



X54x Series

User's Guide

August 2008

www.lexmark.com

Machine type:

7525

Model numbers:

131, 133, 138, 332, 333, 336, 337, 352, 356, 382, 383, 386, 387

Contents

Safety information.....	11
Learning about the printer.....	13
Finding information about the printer.....	13
Selecting a location for the printer.....	14
Printer configurations.....	16
Basic functions of the scanner.....	16
Understanding the ADF and scanner glass.....	17
Understanding the printer control panel.....	17
Additional printer setup.....	23
Installing internal options.....	23
Available options	23
Installing a memory card	23
Installing a flash memory or font card	27
Installing hardware options.....	30
Installing a 650-sheet duo drawer.....	30
Attaching cables.....	32
Verifying printer setup.....	33
Printing menu settings pages	33
Printing a network setup page	33
Setting up the printer software.....	34
Installing printer software	34
Updating available options in the printer driver.....	34
Loading paper and specialty media.....	36
Linking and unlinking trays.....	36
Linking trays.....	36
Unlinking trays.....	36
Assigning a Custom Type <x> name.....	36
Setting the Paper Size and Paper Type.....	37
Configuring Universal paper settings.....	37
Loading the standard 250-sheet tray.....	38
Loading the optional 650-sheet duo drawer.....	40
Using the multipurpose feeder.....	41
Using the manual feeder.....	43

Paper and specialty media guide.....45

Paper guidelines.....45
Paper characteristics..... 45
Unacceptable paper 46
Selecting paper..... 46
Selecting preprinted forms and letterhead..... 46
Storing paper.....47
Supported paper sizes, types, and weights.....47
Paper sizes supported by the printer 47
Paper types supported by the printer 48
Paper types and weights supported by the printer 49
Paper capacities..... 50
Using recycled paper and other office papers 51

Printing.....52

Printing a document.....52
Printing on specialty media.....53
Tips on using letterhead..... 53
Tips on using transparencies 54
Tips on using envelopes..... 54
Tips on using paper labels..... 55
Tips on using card stock..... 56
Printing from a flash drive.....56
Printing photos from a PictBridge-enabled digital camera.....58
Printing information pages.....58
Printing a font sample list..... 58
Printing a directory list..... 59
Printing the print quality test pages 59
Canceling a print job.....59
Canceling a print job from the printer control panel 59
Canceling a print job from the computer 59

Copying.....61

Making copies.....61
Making a quick copy 61
Copying using the ADF..... 61
Copying using the scanner glass 62
Copying photos.....62
Copying on specialty media.....62
Copying to transparencies 62
Copying to letterhead 63

Customizing copy settings.....	63
Copying from one size to another.....	63
Making copies using paper from a selected tray	64
Copying on both sides of the paper (duplexing)	64
Reducing or enlarging copies	65
Making a copy lighter or darker	65
Adjusting copy quality.....	66
Collating copies.....	66
Placing separator sheets between copies	67
Copying multiple pages onto a single sheet.....	67
Canceling a copy job.....	68
Improving copy quality.....	68

E-mailing.....69

Getting ready to e-mail.....	69
Setting up the e-mail function	69
Setting up the address book	70
Creating an e-mail shortcut using the Embedded Web Server.....	70
E-mailing a document.....	70
Sending an e-mail using the keypad	70
Sending an e-mail using a shortcut number	71
Sending an e-mail using the address book.....	72
Canceling an e-mail.....	72

Faxing.....73

Getting the printer ready to fax.....	73
Initial fax setup.....	74
Choosing a fax connection.....	75
Connecting to an analog telephone line	76
Connecting to a DSL service	76
Connecting to a PBX or ISDN system.....	77
Connecting to a Distinctive Ring Service	78
Connecting a telephone or answering machine to the same telephone line.....	79
Connecting to an adapter for your country or region.....	81
Connecting to a computer with a modem.....	85
Setting the outgoing fax name and number.....	87
Setting the date and time.....	87
Turning daylight saving time on or off	88
Sending a fax.....	88
Sending a fax using the printer control panel.....	88
Sending a fax using the computer	89
Creating shortcuts.....	89

Creating a fax destination shortcut using the Embedded Web Server.....	89
Creating a fax destination shortcut using the printer control panel	90
Using shortcuts and the address book.....	91
Using fax destination shortcuts.....	91
Using the address book.....	91
Customizing fax settings.....	91
Changing the fax resolution	91
Making a fax lighter or darker	92
Sending a fax at a scheduled time.....	92
Viewing a fax log.....	92
Canceling an outgoing fax.....	93
Understanding fax options.....	93
Original Size	93
Content.....	93
Sides (Duplex)	93
Resolution.....	94
Darkness.....	94
Improving fax quality.....	94
Holding and forwarding faxes.....	94
Holding faxes.....	94
Forwarding a fax	95
Scanning to a computer or USB flash memory device.....	96
Scanning to a computer.....	96
Scanning to a USB flash memory device.....	97
Understanding scan to computer options.....	98
Sides (Duplex)	98
Darkness.....	98
Improving scan quality.....	98
Using the Scan Center software.....	98
Understanding the Scan Center features.....	98
Using the ScanBack utility.....	99
Using the ScanBack Utility	99
Clearing jams.....	100
Avoiding jams.....	100
Understanding jam numbers and locations.....	101
200 paper jam.....	102
201 paper jam.....	102
202 paper jam.....	103

230 paper jam.....	105
235 paper jam.....	105
242 paper jam.....	105
250 paper jam.....	106
290 paper jam.....	106
Understanding printer menus.....	108
Menus list.....	108
Supplies menu.....	109
Paper menu.....	109
Default Source menu.....	109
Size/Type menu.....	110
Paper Texture menu.....	112
Paper Weight menu.....	114
Paper Loading menu.....	115
Custom Types menu.....	116
Custom Scan Sizes menu.....	117
Universal Setup menu.....	117
Reports menu.....	118
Reports menu.....	118
Network/Ports.....	119
Active NIC menu.....	119
Network menu.....	119
Wireless menu.....	120
USB menu.....	121
Settings menu.....	123
General Settings menu.....	123
Copy Settings menu.....	126
Fax Settings menu.....	128
Flash Drive menu.....	134
Print Settings.....	137
Set Date and Time.....	146
Understanding printer messages.....	148
List of status and error messages.....	148
Maintaining the printer.....	162
Storing supplies.....	162
Checking the status of supplies.....	162
Checking the status of supplies from the printer control panel.....	162
Checking the status of supplies from a network computer.....	162

Conserving supplies.....	162
Ordering supplies.....	163
Ordering toner cartridges.....	163
Ordering imaging kits.....	164
Ordering a waste toner bottle.....	164
Replacing supplies.....	165
Replacing the waste toner bottle.....	165
Replacing a black imaging kit.....	168
Replacing a black and color imaging kit.....	174
Replacing a toner cartridge.....	179
Replacing a developer unit.....	181
Recycling Lexmark products.....	187
Cleaning the exterior of the printer.....	187
Cleaning the scanner glass.....	188
Moving the printer.....	188
Before moving the printer.....	188
Moving the printer to another location.....	189
Shipping the printer.....	189
Administrative support.....	190
Finding advanced networking and administrator information.....	190
Restoring the factory default settings.....	190
Adjusting Power Saver.....	190
Using the Embedded Web Server.....	191
Setting up e-mail alerts.....	191
Viewing reports.....	192
Troubleshooting.....	193
Solving basic printer problems.....	193
Solving printing problems.....	193
Multiple-language PDFs do not print.....	193
Printer control panel display is blank or displays only diamonds.....	193
Error message about reading USB drive appears.....	193
Jobs do not print.....	194
Job takes longer than expected to print.....	194
Job prints from the wrong tray or on the wrong paper.....	195
Incorrect characters print.....	195
Tray linking does not work.....	195
Large jobs do not collate.....	195
Unexpected page breaks occur.....	196
Solving copy problems.....	196

Copier does not respond	196
Scanner unit does not close.....	196
Poor copy quality	197
Partial document or photo copies.....	198
Solving scanner problems.....	198
Checking an unresponsive scanner	198
Scan was not successful	199
Scanning takes too long or freezes the computer.....	199
Poor scanned image quality	199
Partial document or photo scans.....	200
Cannot scan from a computer	200
Solving fax problems.....	200
Caller ID is not shown.....	200
Cannot send or receive a fax.....	201
Can send but not receive faxes.....	202
Can receive but not send faxes.....	203
Received fax has poor print quality.....	203
Blocking junk faxes.....	204
Solving option problems.....	204
Option does not operate correctly or quits after it is installed	204
Drawers.....	205
Multipurpose feeder	205
Memory card	206
Solving paper feed problems.....	206
Paper frequently jams	206
Paper jam message remains after jam is cleared	206
Page that jammed does not reprint after you clear the jam.....	206
Solving print quality problems.....	207
Blank pages.....	207
Characters have jagged or uneven edges	207
Clipped images.....	208
Dark lines	208
Gray background	208
Incorrect margins.....	209
Light colored line, white line, or incorrectly colored line.....	209
Paper curl.....	210
Print irregularities	210
Repeating defects.....	211
Skewed print.....	211
Print is too light	211
Print is too dark.....	213
Solid color pages.....	214
Toner fog or background shading appears on the page	214
Toner rubs off.....	214

Toner specks.....	215
Transparency print quality is poor.....	215
Uneven print density.....	216
Solving color quality problems.....	216
Color misregistration.....	216
FAQ about color printing.....	217
Embedded Web Server does not open.....	220
Check the network connections.....	220
Check the network settings.....	220
Contacting Customer Support.....	220
Notices.....	221
Product information.....	221
Edition notice.....	221
Power consumption.....	231
Index.....	239

Safety information

Connect the power cord to a properly grounded electrical outlet that is near the product and easily accessible.

Do not place or use this product near water or wet locations.

 **CAUTION—POTENTIAL INJURY:** This product uses a laser. Use of controls or adjustments or performance of procedures other than those specified herein may result in hazardous radiation exposure.

This product uses a printing process that heats the print media, and the heat may cause the media to release emissions. You must understand the section in your operating instructions that discusses the guidelines for selecting print media to avoid the possibility of harmful emissions.

 **CAUTION—HOT SURFACE:** The inside of the printer might be hot. To reduce the risk of injury from a hot component, allow the surface to cool before touching.

 **CAUTION—POTENTIAL INJURY:** The printer weight is greater than 18 kg (40 lb) and requires two or more trained personnel to move it safely.

 **CAUTION—POTENTIAL INJURY:** Before moving the printer, follow these guidelines to avoid personal injury or printer damage:

- Turn the printer off using the power switch, and then unplug the power cord from the wall outlet.
- Disconnect all cords and cables from the printer before moving it.
- Lift the printer off of the optional drawer and set it aside instead of trying to lift the drawer and printer at the same time.

Note: Use the handholds located on both sides of the printer to lift it off the optional drawer.

Use only the power cord provided with this product or the manufacturer's authorized replacement.

Use only the telecommunications (RJ-11) cord provided with this product or a 26 AWG or larger replacement when connecting this product to the public switched telephone network.

 **CAUTION—SHOCK HAZARD:** If you are accessing the system board or installing optional hardware or memory devices sometime after setting up the printer, then turn the printer off, and unplug the power cord from the wall outlet before continuing. If you have any other devices attached to the printer, then turn them off as well, and unplug any cables going into the printer.

 **CAUTION—SHOCK HAZARD:** Make sure that all external connections (such as Ethernet and telephone system connections) are properly installed in their marked plug-in ports.

This product contains mercury in the lamp (<5mg Hg). Disposal of mercury may be regulated due to environmental considerations. For disposal or recycling information, contact your local authorities or the Electronic Industries Alliance: www.eiae.org.

This product is designed, tested, and approved to meet strict global safety standards with the use of specific manufacturer's components. The safety features of some parts may not always be obvious. The manufacturer is not responsible for the use of other replacement parts.

 **CAUTION—POTENTIAL INJURY:** Do not twist, bind, crush, or place heavy objects on the power cord. Do not subject the power cord to abrasion or stress. Do not pinch the power cord between objects such as furniture and walls. If the power cord is misused, a risk of fire or electrical shock results. Inspect the power cord regularly for signs of misuse. Remove the power cord from the electrical outlet before inspecting it.

Refer service or repairs, other than those described in the user documentation, to a professional service person.



CAUTION—SHOCK HAZARD: To avoid the risk of electric shock when cleaning the exterior of the printer, unplug the power cord from the wall outlet and disconnect all cables from the printer before proceeding.



CAUTION—SHOCK HAZARD: Do not use the fax feature during a lightning storm. Do not set up this product or make any electrical or cabling connections, such as the fax feature, power cord, or telephone, during a lightning storm.

SAVE THESE INSTRUCTIONS.

Learning about the printer

Finding information about the printer

Setup information

Description	Where to find
The <i>Setup</i> information gives you instructions for setting up the printer. Follow the set of instructions for local, network, or wireless, depending on what you need.	You can find the <i>Setup</i> information in the printer box or on the Lexmark Web site at www.lexmark.com .

Wireless Setup Guide

Description	Where to find
If your printer has built-in wireless functionality, a <i>Wireless Setup Guide</i> gives you instructions for connecting the printer wirelessly.	You can find the <i>Wireless Setup Guide</i> in the printer box or on the Lexmark Web site at www.lexmark.com .

Help

Description	Where to find
The Help gives you instructions for using the software.	While in any Lexmark software program, click Help, Tips → Help , or Help → Help Topics .

Customer support

Description	Where to find (North America)	Where to find (rest of world)
Telephone support	<p>Call us at</p> <ul style="list-style-type: none">• US: 1-800-332-4120 Monday–Friday (8:00 AM–11:00 PM ET) Saturday (Noon–6:00 PM ET)• Canada: 1-800-539-6275 Monday–Friday (8:00 AM–11:00 PM ET) Saturday (Noon–6:00 PM ET)• Mexico: 001-888-377-0063 Monday–Friday (8:00 AM–8:00 PM ET) <p>Note: Telephone numbers and support times may change without notice. For the most recent telephone numbers available, see the printed warranty statement that came with your printer.</p>	<p>Telephone numbers and support hours vary by country or region.</p> <p>Visit our Web site at www.lexmark.com. Select a country or region, and then select the Customer Support link.</p> <p>Note: For additional information about contacting Lexmark, see the printed warranty that came with your printer.</p>

Description	Where to find (North America)	Where to find (rest of world)
E-mail support	For e-mail support, visit our Web site: www.lexmark.com . <ol style="list-style-type: none"> 1 Click SUPPORT. 2 Click Technical Support. 3 Select your printer type. 4 Select your printer model. 5 From the Support Tools section, click e-Mail Support. 6 Complete the form, and then click Submit Request. 	E-mail support varies by country or region, and may not be available in some instances. Visit our Web site at www.lexmark.com . Select a country or region, and then select the Customer Support link. Note: For additional information about contacting Lexmark, see the printed warranty that came with your printer.

Selecting a location for the printer

When selecting a location for the printer, leave enough room to open trays, covers, and doors. If you plan to install any options, leave enough room for them also. It is important to:

- Make sure airflow in the room meets the latest revision of the ASHRAE 62 standard.
- Provide a flat, sturdy, and stable surface.
- Keep the printer:
 - Away from the direct airflow of air conditioners, heaters, or ventilators
 - Free from direct sunlight, humidity extremes, or temperature fluctuations
 - Clean, dry, and free of dust
- Allow the following recommended amount of space around the printer for proper ventilation:

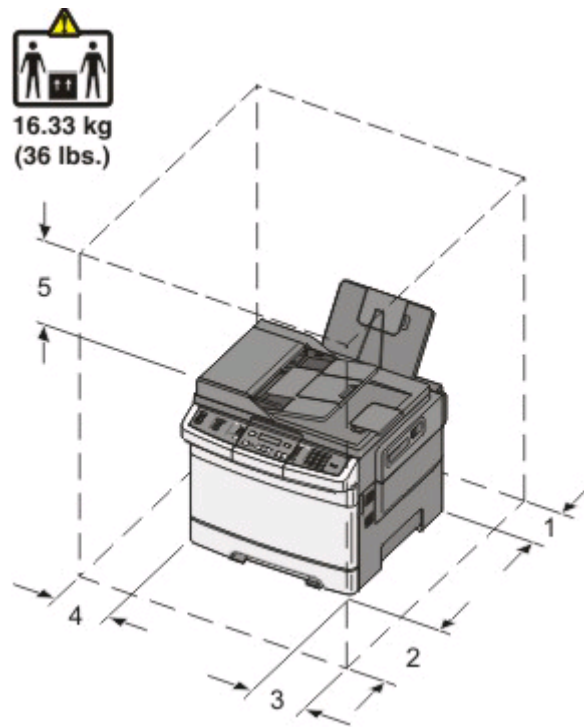

1	100 mm (3.9 in.)
2	482.6 mm (19 in.)
3	100 mm (3.9 in.)
4	100 mm (3.9 in.)
5	360 mm (14 in.)

When the printer is set up, allow clearance around it as shown.

Printer configurations

Basic models

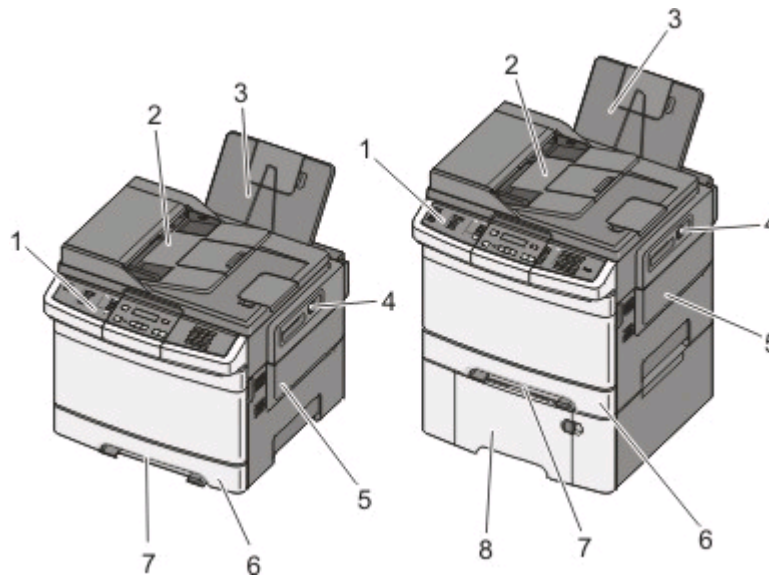

1	Printer control panel
2	Automatic Document Feeder (ADF)
3	Standard exit bin
4	Top door latch
5	Right side cover
6	Standard 250-sheet tray (Tray 1)
7	Manual feeder
8	Optional 650-sheet duo drawer (Tray 2)

Basic functions of the scanner

The scanner provides copy, fax, and scan-to-network capability for workgroups. You can:

- Make quick copies, or change the settings on the printer control panel to perform specific copy jobs.
- Send a fax using the printer control panel.
- Send a fax to multiple fax destinations at the same time.
- Scan documents and send them to your computer, an e-mail address, or a USB flash memory device.

Understanding the ADF and scanner glass

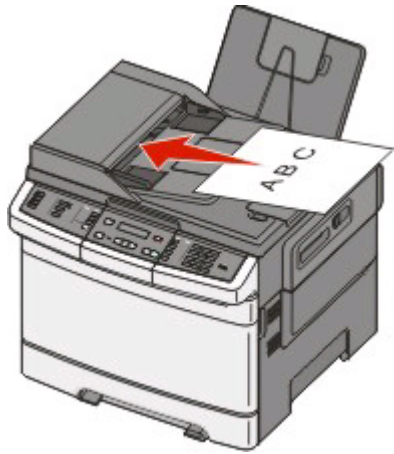
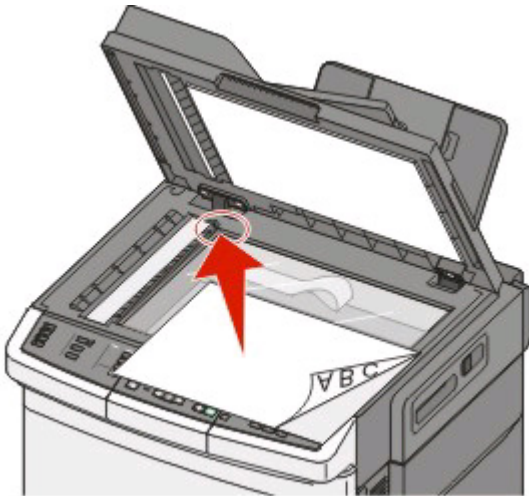
Automatic Document Feeder (ADF)	Scanner glass
 <p data-bbox="149 751 623 781">Use the ADF for multiple-page documents.</p>	 <p data-bbox="643 802 1442 890">Use the scanner glass for single pages, small items (such as postcards or photos), transparencies, photo paper, or thin media (such as magazine clippings).</p>

You can use the ADF or the scanner glass to scan documents.

Using the ADF

The ADF can scan multiple pages including duplex (two-sided) pages. When using the ADF:

Note: Duplex scanning is not available on selected printer models.

- Load the document into the ADF faceup, short edge first.
- Load up to 50 sheets of plain paper into the ADF.
- Scan sizes from 125 x 216 mm (4.9 x 8.5 in.) wide to 127 x 356 mm (5 x 14 in.) long.
- Scan media weights from 52 to 120 g/m² (14 to 32 lb).
- Do not load postcards, photos, small items, transparencies, photo paper, or thin media (such as magazine clippings) into the ADF. Place these items on the scanner glass.

Using the scanner glass

The scanner glass can be used to scan or copy single pages or book pages. When using the scanner glass:

- Place a document facedown on the scanner glass in the corner with the green arrow.
- Scan or copy documents up to 215.9 x 355.6 mm (8.5 x 14 in.).
- Copy books up to 12.7 mm (0.5 in.) thick.



Understanding the printer control panel





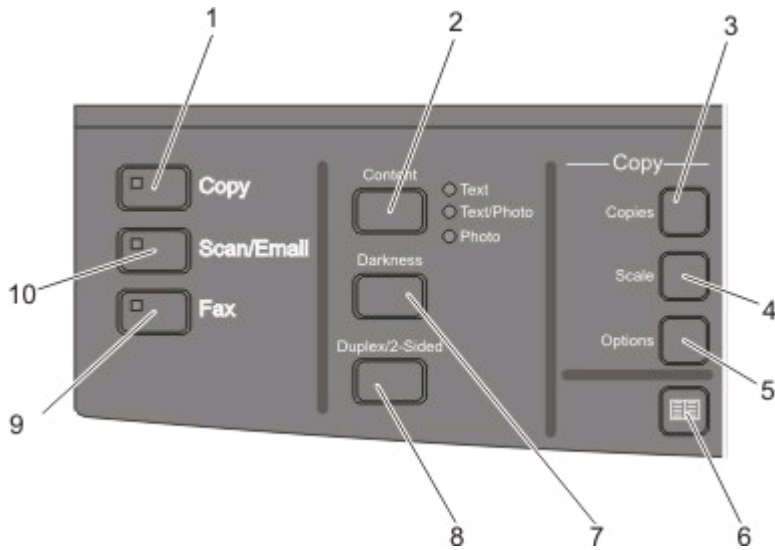



Note: Some features are not available on selected printer models.











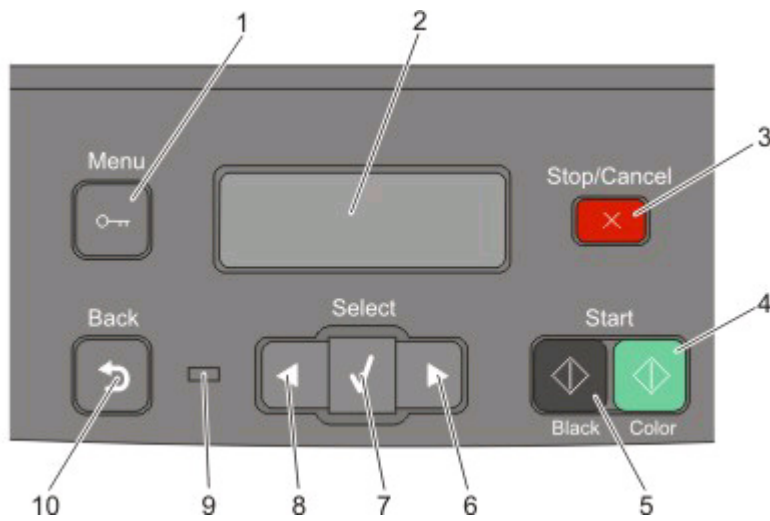



Item	Description	
1	Selections and settings	Select a function such as Copy, Scan, Email, or Fax. Change default copy and scan settings such as the number of copies, duplex printing, copy options, and scaling. Use the address book when scanning to e-mail.
2	Display area	View scanning, copying, faxing, and printing options as well as status and error messages. Access the administration menus, start, stop, or cancel a print job.
3	Keypad area	Enter numbers, letters, or symbols on the display, print using the USB flash memory device, or change the default fax settings.







Item	Description	
1	Copy 	Press the Copy button to enter the copy function.
2	Content 	Press the Content button to enhance copy, scan, e-mail, or fax quality. Choose from Text, Text/Photo, or Photo.
3	Copies 	Press the Copies button to enter the number of copies to print.

Item		Description
4	Scale 	Press the Scale button to change the size of the copied document to fit onto the currently selected paper size.
5	Options 	Press the Options button to change Original Size, Paper Source, Paper Saver, and Collate settings.
6	Address Book 	Press  to enter the address book.
7	Darkness 	Press the Darkness button to adjust the current darkness settings.
8	Duplex 2-Sided 	Press the Duplex 2-Sided button to scan or print on both sides of the paper. Note: The duplex feature is not available on selected printer models.
9	Fax 	Press the Fax button to enter the fax function. Note: Fax mode is not available on selected printer models.
10	Scan/Email 	Press the Scan/Email button to enter the scan or scan to e-mail function.









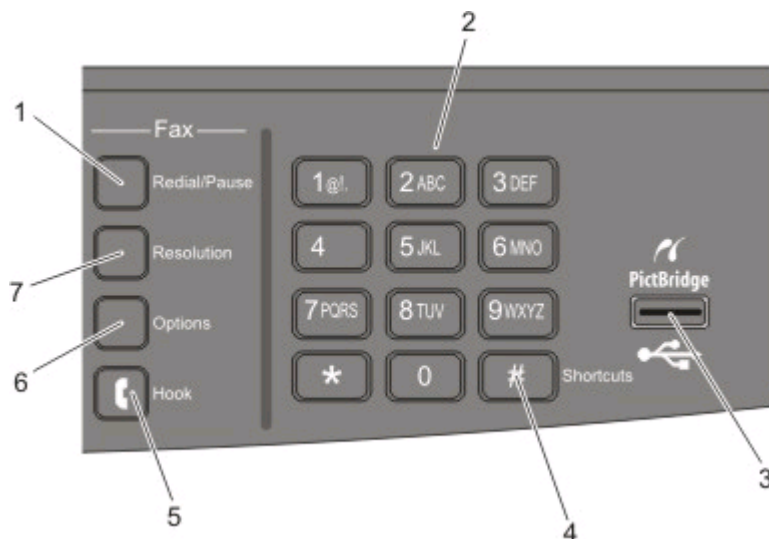





Item	Description
1 Menu 	Press  to enter the administration menus.
2 Display	View scanning, copying, faxing, and printing options as well as status and error messages Note: The fax feature is not available on selected printer models.
3 Stop/Cancel 	Press  to stop all printer activity.
4 Color start 	Press  to copy or scan in color.
5 Black start 	Press  to copy or scan in black and white.
6 Right arrow 	Press  to scroll right.
7 Select 	Press  to accept menu selections and settings.

Item	Description	
8	Left arrow 	Press  to scroll left.
9	Indicator light	Indicates the printer status: <ul style="list-style-type: none"> • Off—The power is off. • Blinking green—The printer is warming up, processing data, or printing. • Solid green—The printer is on, but idle. • Blinking red—Operator intervention is needed.
10	Back 	Press  to return one screen at a time to the Ready screen. Note: An error beep sounds when you press  if a flash drive is connected and the USB menu is displayed.

Note: The fax buttons, keypad, and USB port are not available on selected printer models.



Item	Description	
1	Redial/Pause 	<ul style="list-style-type: none"> • Press the Redial/Pause button to cause a two- or three-second dial pause in a fax number. In the Fax To: field, a Dial Pause is represented by a comma (,). • From the home screen, press the Redial/Pause button to redial a fax number. • The button functions only within the Fax menu or with fax functions. When outside of the Fax menu, fax function, or home screen, pressing the Redial/Pause button causes an error beep.

Item	Description
<p>2 Keypad</p> 	<p>Enter numbers, letters, or symbols on the display.</p>
<p>3 Front USB port</p> 	<p>Lets you scan to a flash drive or print supported file types</p> <p>Note: When a USB flash memory device is inserted into the printer, the printer can only scan to the USB device or print files from the USB device. All other printer functions are unavailable.</p>
<p>4 Shortcuts</p> 	<p>Press  to enter the shortcut screen.</p>
<p>5 Hook</p> 	<p>Press  to take the line off-hook (like picking up a phone receiver). Press  a second time to hang up the line.</p>
<p>6 Options</p> 	<p>Press the Options button to change Original Size, Broadcast, Delayed Send, and Cancel settings.</p>
<p>7 Resolution</p> 	<p>Press the Resolution button to select a dpi value for the scan.</p> <p>Note: Press  or  to scroll through the values, and then press  to enter a value.</p>

Additional printer setup

Installing internal options

 **CAUTION—SHOCK HAZARD:** If you are accessing the system board or installing optional hardware or memory devices sometime after setting up the printer, then turn the printer off, and unplug the power cord from the wall outlet before continuing. If you have any other devices attached to the printer, then turn them off as well, and unplug any cables going into the printer.

You can customize your printer connectivity and memory capacity by adding optional cards. The instructions in this section explain how to install the available cards; you can also use them to locate a card for removal.

Available options

Note: Certain options are not available on selected printer models.

Memory cards

- Printer memory
- Flash memory
- Font cards

Installing a memory card

 **CAUTION—SHOCK HAZARD:** If you are accessing the system board or installing optional hardware or memory devices sometime after setting up the printer, then turn the printer off, and unplug the power cord from the wall outlet before continuing. If you have any other devices attached to the printer, then turn them off as well, and unplug any cables going into the printer.

Note: This task requires a #2 Phillips screwdriver.

- 1** Access the system board on the back of the printer.
 - a** Turn the screws on the cover counterclockwise, and then remove them.
 - b** Gently pull the cover away from the printer, and then remove it.

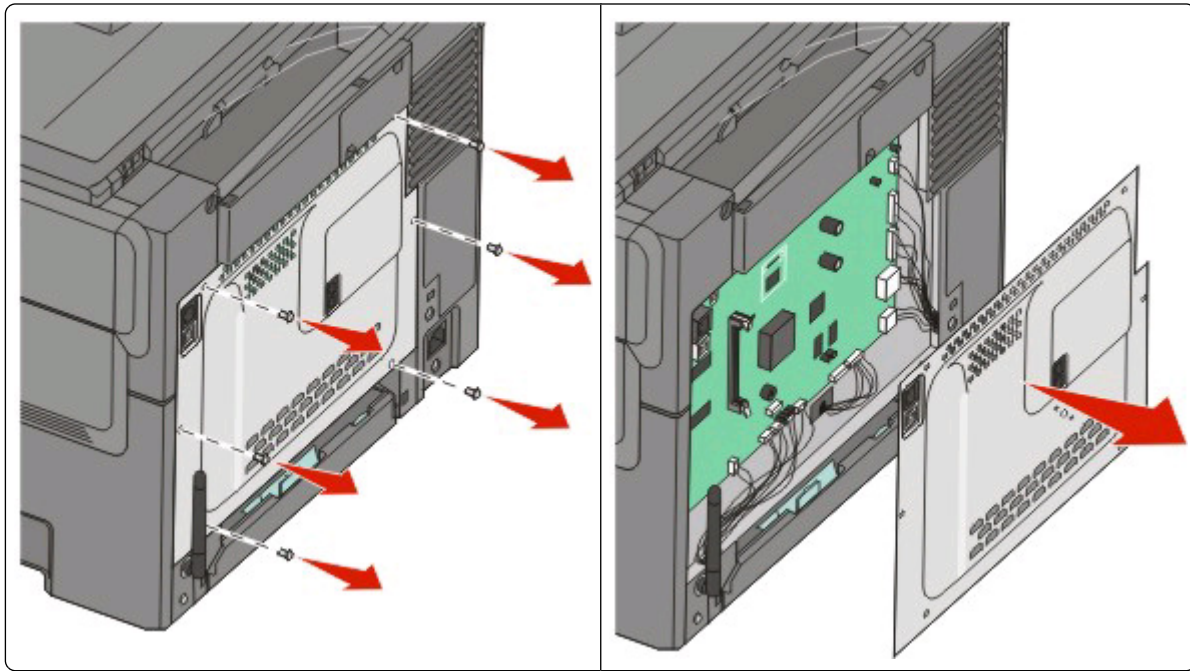

Warning—Potential Damage: System board electronic components are easily damaged by static electricity. Touch something metal on the printer before touching any system board electronic components or connectors.

2 Use the illustration below to locate the connector.

Warning—Potential Damage: System board electronic components are easily damaged by static electricity. Touch something metal on the printer before touching any system board electronic components or connectors.

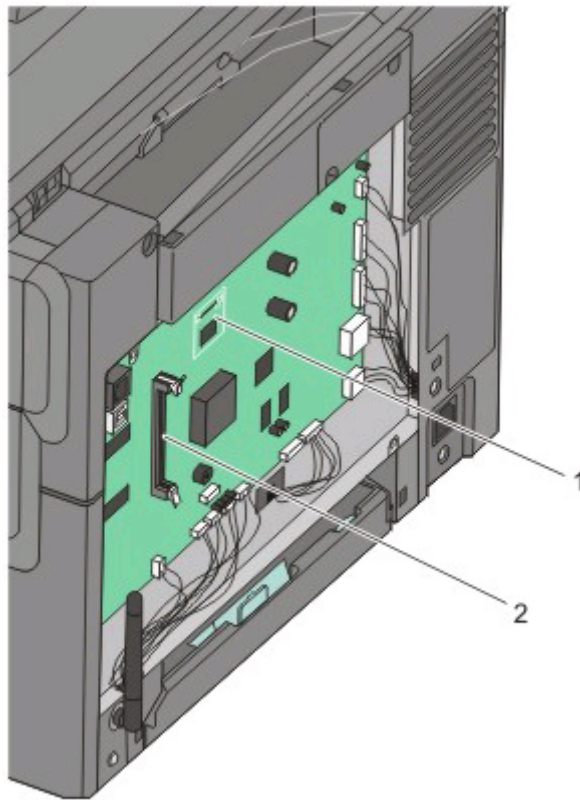

1	Flash memory or font card connector
2	Memory card connector

3 Open the memory card connector latches.

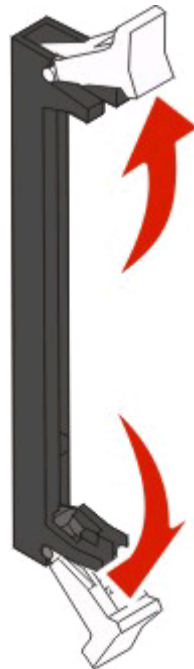

4 Unpack the memory card.

Note: Avoid touching the connection points along the edge of the card.

5 Align the notches on the memory card with the ridges on the connector.

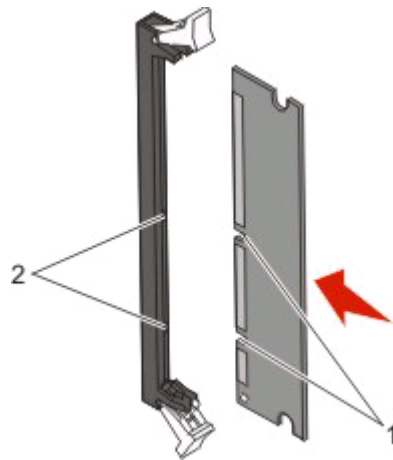

1	Notches
2	Ridges

6 Push the memory card straight into the connector until it *snaps* into place.

7 Reinstall the system board cover.

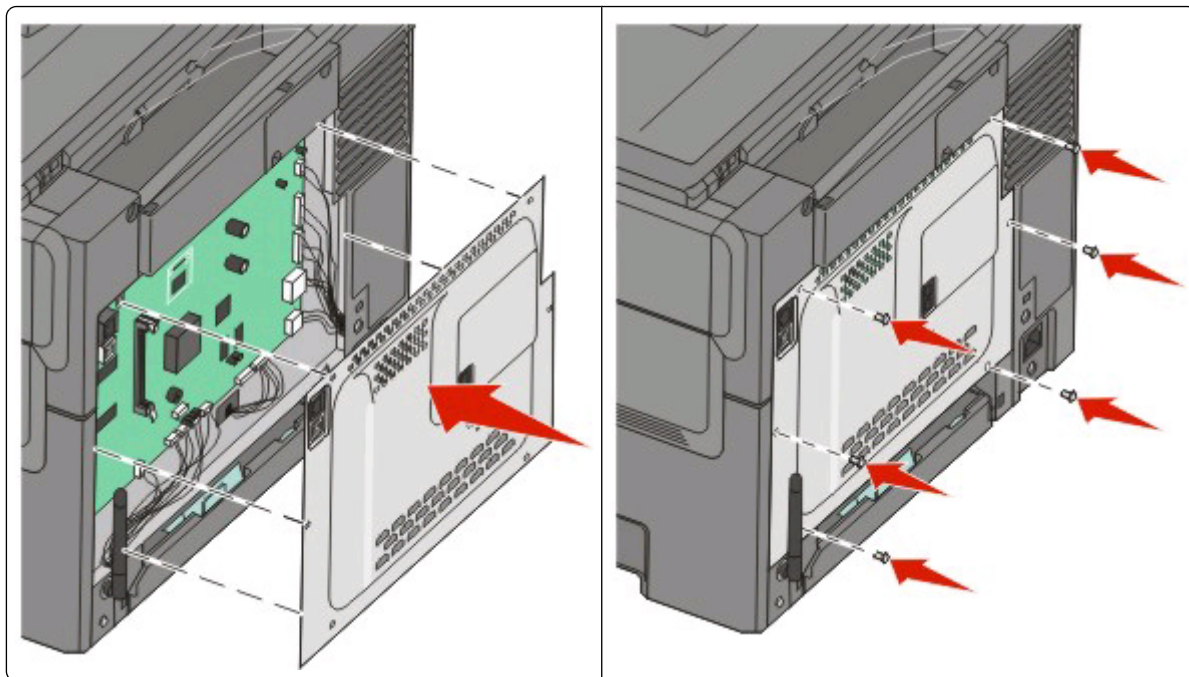

Installing a flash memory or font card

CAUTION—SHOCK HAZARD: If you are accessing the system board or installing optional hardware or memory devices sometime after setting up the printer, then turn the printer off, and unplug the power cord from the wall outlet before continuing. If you have any other devices attached to the printer, then turn them off as well, and unplug any cables going into the printer.

- 1 Access the system board on the back of the printer.
 - a Turn the screws on the cover counterclockwise, and then remove them.
 - b Gently pull the cover away from the printer, and then remove it.

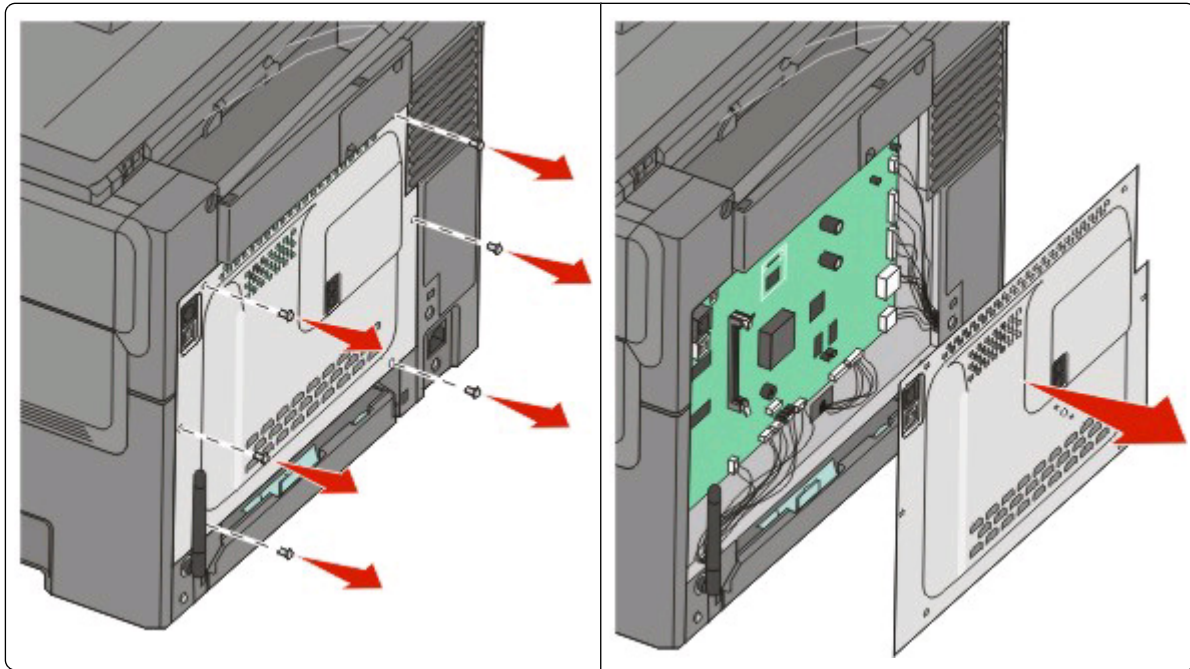

Warning—Potential Damage: System board electronic components are easily damaged by static electricity. Touch something metal on the printer before touching any system board electronic components or connectors.

- 2 Use the illustration below to locate the connector.

Warning—Potential Damage: System board electronic components are easily damaged by static electricity. Touch something metal on the printer before touching any system board electronic components or connectors.

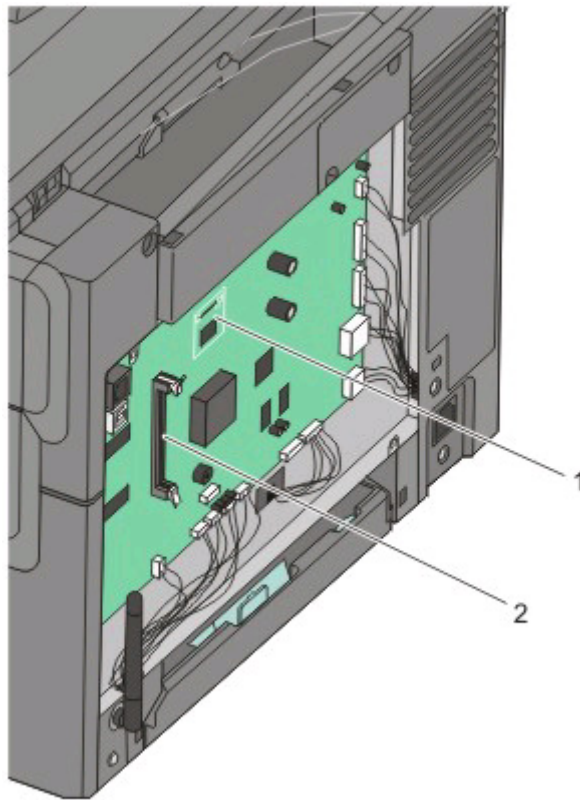

1	Flash memory or font card connector
2	Memory card connector

3 Unpack the flash memory or font card.

Note: Avoid touching the connection points along the edge of the card.

4 Holding the card by its sides, align the plastic pins on the card with the holes on the system board. This ensures the metal pins line up correctly as well.

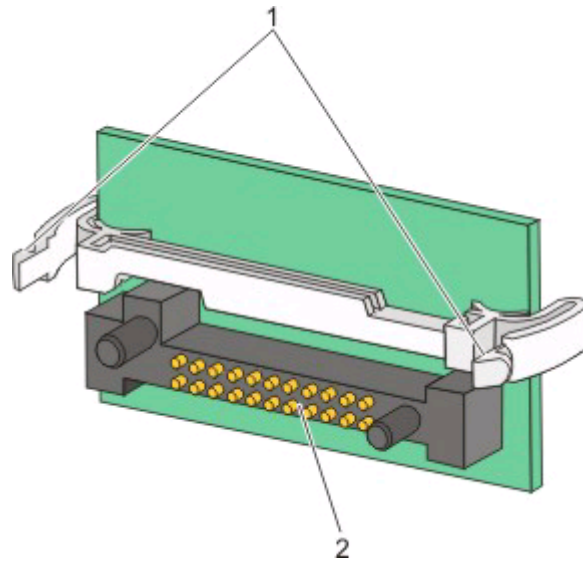

1	Plastic pins
2	Metal pins

5 Push the card firmly into place.

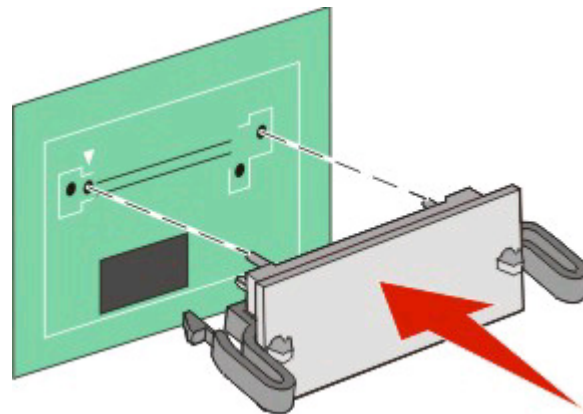

Notes:

- The entire length of the connector on the card must touch and be flush against the system board.
- Be careful not to damage the connectors.

6 Reinstall the system board cover.

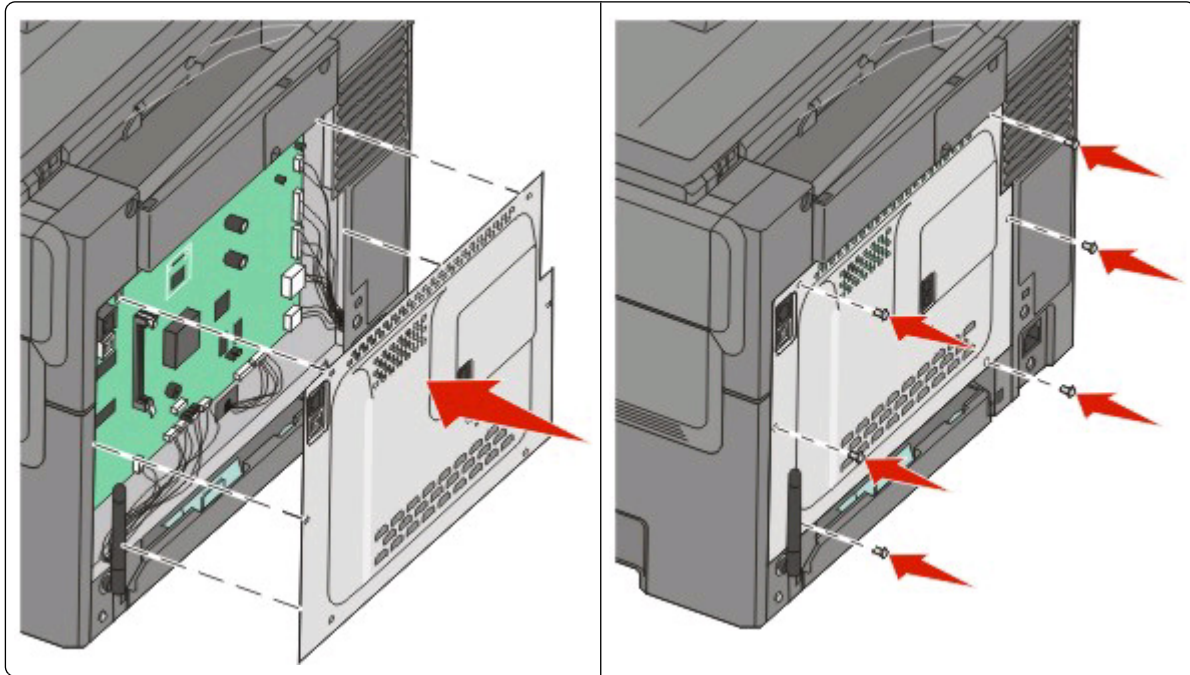

Installing hardware options

Installing a 650-sheet duo drawer

The printer supports one optional drawer, which allows an additional 650 sheets of paper to be loaded. The drawer includes a multipurpose feeder.

⚠ CAUTION—SHOCK HAZARD: If you are accessing the system board or installing optional hardware or memory devices sometime after setting up the printer, then turn the printer off, and unplug the power cord from the wall outlet before continuing. If you have any other devices attached to the printer, then turn them off as well, and unplug any cables going into the printer.

- 1 Unpack the 650-sheet duo drawer, and remove any packing material and the dust cover.
- 2 Place the drawer in the location chosen for the printer.

3 Attach the cover to the rear of the 650-sheet duo drawer.

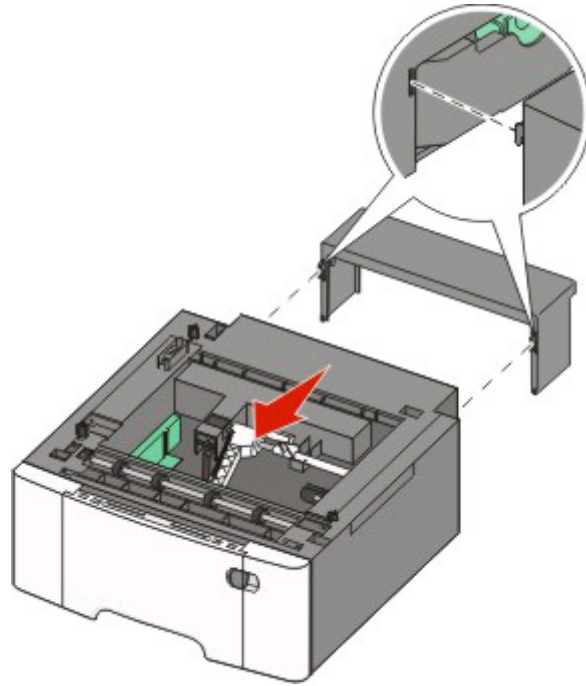

4 Align the printer with the 650-sheet duo drawer, and then lower the printer into place.

⚠ CAUTION—POTENTIAL INJURY: The printer weight is greater than 27.22 kg (60 lb) and requires two or more trained personnel to move it safely.

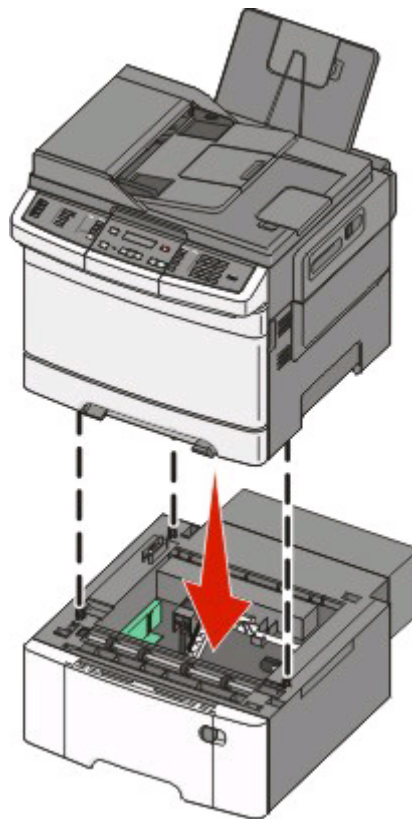

Attaching cables

1 Connect the printer to a computer or a network.

- For a local connection, use a USB cable.
- For a network connection, use an Ethernet cable.

Notes:

- For fax connections, see “Initial fax setup” on page 74.
- Make sure the software is installed before turning the printer on. For more information, see the *Setup Guide*.

2 Connect the power cord to the printer first and then to a wall outlet.

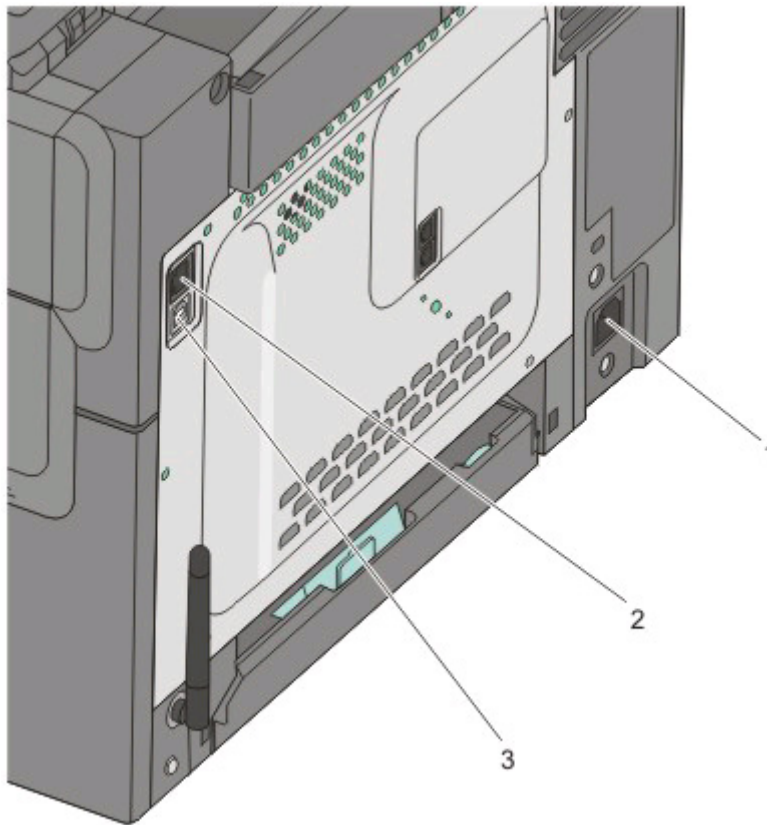

1	Power cord socket
2	Ethernet port Note: The Ethernet port is a feature on network models only.
3	USB port

Verifying printer setup



Once all hardware and software options are installed and the printer is turned on, verify that the printer is set up correctly by printing the following:

- **Menu settings page**—Use this page to verify that all printer options are installed correctly. A list of installed options appears toward the bottom of the page. If an option you installed is not listed, then it is not installed correctly. Remove the option and install it again.
- **Network setup page**—If your printer is a network model and is attached to a network, print a network setup page to verify the network connection. This page also provides important information that aids network printing configuration.

Printing menu settings pages

Print menu settings pages to review the current menu settings and to verify printer options are installed correctly.



Note: If you have not made any menu item settings changes yet, then the menu settings pages list all the factory default settings. Once you select and save other settings from the menus, they replace the factory default settings as *user default settings*. A user default setting remains in effect until you access the menu again, choose another value, and save it. To restore the factory default settings, see “Restoring the factory default settings” on page 190.

- 1 Make sure the printer is on and **Ready** appears.
- 2 From the printer control panel, press .
- 3 Press the arrow buttons until **Reports** appears, and then press .
- 4 Press the arrow buttons until **Menu Settings Page** appears, and then press .

After the menu settings pages print, **Ready** appears.

Printing a network setup page

If the printer is attached to a network, print a network setup page to verify the network connection. This page also provides important information that aids network printing configuration.

- 1 Make sure the printer is on and **Ready** appears.
- 2 From the printer control panel, press .
- 3 Press the arrow buttons until **Reports** appears, and then press .
- 4 Press the arrow buttons until **Network Setup Page** appears, and then press .

After the network setup page prints, **Ready** appears.

- 5 Check the first section on the network setup page, and confirm that Status is “Connected.”

If Status is “Not Connected,” the LAN drop may not be active, or the network cable may be malfunctioning. Consult a system support person for a solution, and then print another network setup page.

Setting up the printer software

Installing printer software

A printer driver is software that lets the computer communicate with the printer. The printer software is typically installed during the initial printer setup. If you need to install the software after setup, follow these instructions:

For Windows users

- 1 Close all open software programs.
- 2 Insert the *Software and Documentation* CD.
- 3 From the main installation dialog, click **Install**.
- 4 Follow the instructions on the screen.

For Macintosh users

- 1 Close all open software applications.
- 2 Insert the *Software and Documentation* CD.
- 3 From the Finder desktop, double-click the printer CD icon that automatically appears.
- 4 Double-click the **Install** icon.
- 5 Follow the instructions on the screen.

Using the World Wide Web

- 1 Go to the Lexmark Web site at **www.lexmark.com**.
- 2 From the Drivers & Downloads menu, click **Driver Finder**.
- 3 Select your printer, and then select your operating system.
- 4 Download the driver and install the printer software.

Updating available options in the printer driver

Once the printer software and any options are installed, it may be necessary to manually add the options in the printer driver to make them available for print jobs.

For Windows users

- 1 Do one of the following:

In Windows Vista

- a Click .
- b Click **Control Panel**.
- c Click **Hardware and Sound**.
- d Click **Printers**.

In Windows XP

- a Click **Start**.
- b Click **Printers and Faxes**.

In Windows 2000

- a Click **Start**.
- b Click **Settings → Printers**.

- 2 Select the printer.
- 3 Right-click the printer, and then select **Properties**.
- 4 Click the Install Options tab.
- 5 Under Available Options, add any installed hardware options.
- 6 Click **Apply**.

For Macintosh users

In Mac OS X version 10.5

- 1 From the Apple menu, choose **System Preferences**.
- 2 Click **Print & Fax**.
- 3 Select the printer, and then click **Options & Supplies**.
- 4 Click **Driver**, and then add any installed hardware options.
- 5 Click **OK**.

In Mac OS X version 10.4 and earlier

- 1 From the Go menu, choose **Applications**.
- 2 Double-click **Utilities**, and then double-click **Print Center** or **Printer Setup Utility**.
- 3 Select the printer, and then from the Printers menu, choose **Show Info**.
- 4 From the pop-up menu, choose **Installable Options**.
- 5 Add any installed hardware options, and then click **Apply Changes**.

Loading paper and specialty media

This section explains how to load the 250- and 550-sheet trays, the multipurpose feeder, and the manual slot. It also includes information about paper orientation, setting the Paper Size and Paper Type, and linking and unlinking trays.

Linking and unlinking trays

Linking trays

Tray linking is useful for large print jobs or multiple copies. When one linked tray is empty, paper feeds from the next linked tray. When the Paper Size and Paper Type settings are the same for any trays, the trays are automatically linked. The Paper Size setting for all trays must be set manually from the Paper Size menu. The Paper Type setting must be set for all trays from the Paper Type menu. The Paper Type menu and the Paper Size menu are both available from the Paper Size/Type menu.

Unlinking trays

Unlinked trays have settings that are *not* the same as the settings of any other tray.





To unlink a tray, change the following tray settings so that they do not match the settings of any other tray:



- Paper Type (for example: Plain Paper, Letterhead, Custom Type <x>)
Paper Type names describe the paper characteristics. If the name that best describes your paper is used by linked trays, assign a different Paper Type name to the tray, such as Custom Type <x>, or define your own custom name.
- Paper Size (for example: letter, A4, statement)
Load a different paper size to change the Paper Size setting for a tray. Paper Size settings are not automatic; they must be set manually from the Paper Size menu.

Warning—Potential Damage: Do not assign a Paper Type name that does not accurately describe the type of paper loaded in the tray. The temperature of the fuser varies according to the specified Paper Type. Paper may not be properly processed if an inaccurate Paper Type is selected.

Assigning a Custom Type <x> name

Assign a Custom Type <x> name to a tray to link or unlink it. Associate the same Custom Type <x> name to each tray that you want to link. Only trays with the same custom names assigned will link.











- 1 Make sure the printer is on and **Ready** appears.
- 2 From the printer control panel, press .
- 3 Press the arrow buttons until **Paper Menu** appears, and then press .
- 4 Press the arrow buttons until **Size/Type** appears, and then press .
- 5 Press the arrow buttons, and then press  to select the tray.
The Paper Size menu appears.
- 6 Press the arrow buttons until the Paper Type menu appears.
- 7 Press .

- 8 Press the arrow buttons until **Custom Type <x>** or another custom name appears, and then press . **Submitting changes** appears, followed by **Paper Menu**.
- 9 Press , and then press  to return to the **Ready** state.

Setting the Paper Size and Paper Type

Note: Trays with matching Paper Size and Paper Type settings are automatically linked by the printer. When a linked tray runs out of paper, the printer draws from another tray.

To change the Paper Size and Paper Type settings:

- 1 Make sure the printer is on and **Ready** appears.
- 2 From the printer control panel, press .
- 3 Press the arrow buttons until **Paper Menu** appears, and then press .
- 4 Press the arrow buttons until **Size/Type** appears, and then press .
- 5 Press the arrow buttons until the correct tray appears, and then press .
- 6 Press  when **Size** appears.
- 7 Press the arrow buttons until the correct size appears, and then press . **Submitting changes** appears, followed by **Size**.
- 8 Press the arrow buttons until **Type** appears, and then press .
- 9 Press the arrow buttons until the correct type appears, and then press . **Submitting changes** appears, followed by **Type**.
- 10 Press , and then press  to return to the **Ready** state.



Configuring Universal paper settings

The Universal Paper Size is a user-defined setting that lets you print on paper sizes that are not preset in the printer menus. Set the Paper Size for the specified tray to Universal when the size you want is not available from the Paper Size menu. Then, specify all of the following Universal size settings for your paper:

- Units of measure (inches or millimeters)
- Portrait Height and Portrait Width
- Feed Direction

Note: The smallest supported Universal size is 76.2 x 127 mm (3 x 5 in.); the largest is 215.9 x 355.6 mm (8.5 x 14 in.).

Specify a unit of measurement

- 1 Make sure the printer is on and **Ready** appears.
- 2 From the printer control panel, press .
- 3 Press the arrow buttons until **Paper Menu** appears, and then press .
- 4 Press the arrow buttons until **Universal Setup** appears, and then press .

- 5 Press the arrow buttons until **Units of Measure** appears, and then press .
 - 6 Press the arrow buttons until the correct unit of measure appears, and then press .
- Submitting changes** appears, followed by the **Universal Setup** menu.

Specify the paper height and width

Defining a specific height and width measurement for the Universal paper size (in the portrait orientation) allows the printer to support the size, including support for standard features such as duplex printing and printing multiple pages on one sheet.

- 1 From the Universal Setup menu, press the arrow buttons until **Portrait Width** or **Portrait Height** appears, and then press .

Note: Select **Portrait Height** to adjust the paper height setting or **Paper Width** to adjust the paper width setting.

- 2 Press the arrow buttons to decrease or to increase the setting, and then press .
- Submitting changes** appears, followed by the **Universal Setup** menu.

Loading the standard 250-sheet tray

The printer has one standard 250-sheet tray (Tray 1) and may have an optional 650-sheet duo drawer. The 250-sheet tray and 650-sheet duo drawer support the same paper sizes and types.

- 1 Pull the tray out.

Note: Do not remove trays while a job prints or while **Busy** appears on the display. Doing so may cause a jam.

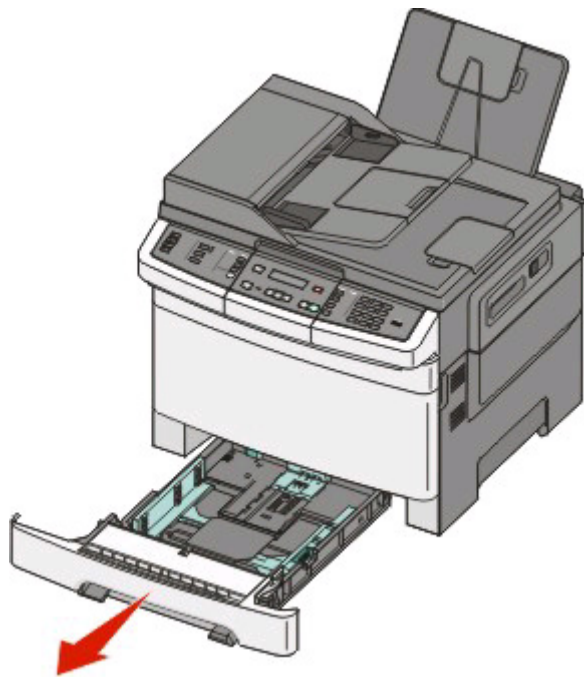

- 2 Squeeze the length guide tab inward as shown, and slide the guide to the correct position for the paper size being loaded.

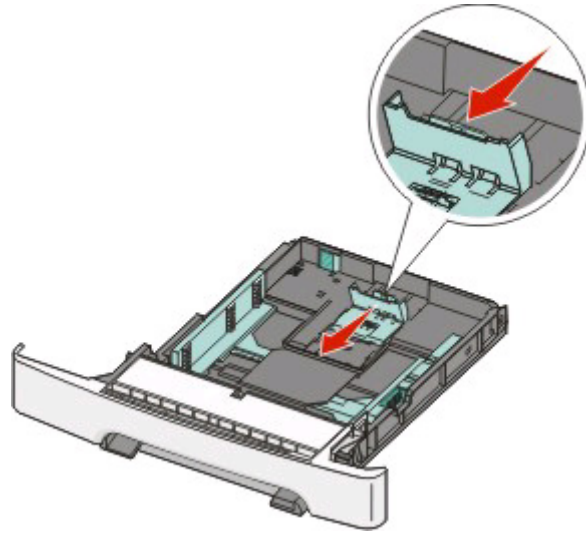

Note: Use the size indicators on the bottom of the tray to help position the guide.

- 3 If the paper is longer than letter-size paper, push the green tab at the back of the tray to elongate it.

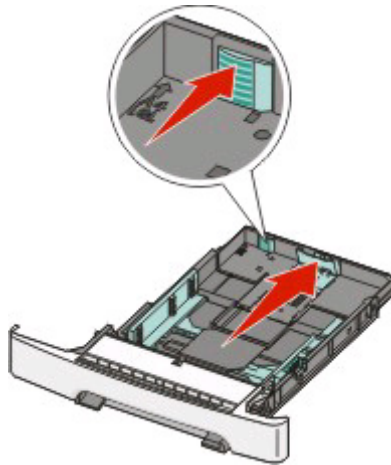

- 4 Flex the sheets back and forth to loosen them, and then fan them. Do not fold or crease the paper. Straighten the edges on a level surface.



- 5 Load the paper stack with the recommended print side faceup.

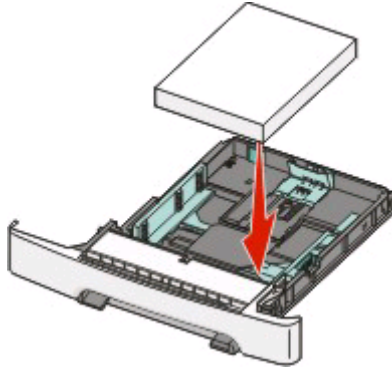

- 6 Make sure the paper guides are secure against the edges of the paper.

Note: Make sure that side guides are placed tightly against the edges of the paper so that the image is registered properly on the page.

- 7 Insert the tray.

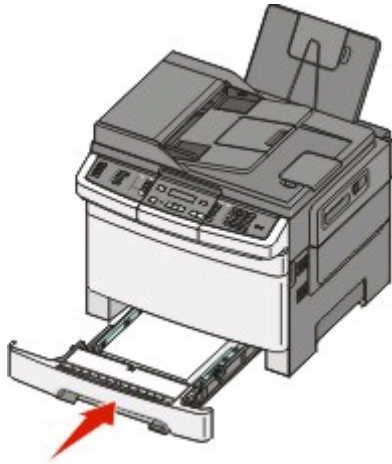

- 8 If a different type or size of paper was loaded than the type or size previously loaded in the tray, change the Paper Type or Paper Size setting for the tray from the printer control panel.

Note: Mixing paper sizes or types in a paper tray may lead to jams.

Loading the optional 650-sheet duo drawer

The 650-sheet duo drawer consists of a 550-sheet tray and a 100-sheet multipurpose feeder. This drawer is loaded in the same way that the standard tray is loaded. The only differences are the look of the guide tabs and the location of the paper size indicators, as shown in the following illustration:

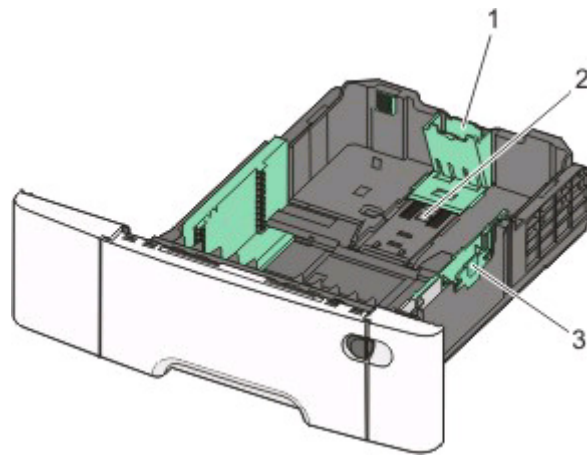

1	Length guide tabs
2	Size indicators
3	Width guide tabs

Using the multipurpose feeder

1 Push the multipurpose feeder latch to the left.

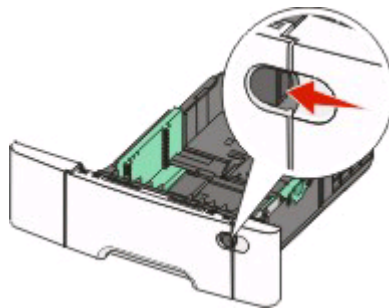

2 Open the multipurpose feeder.

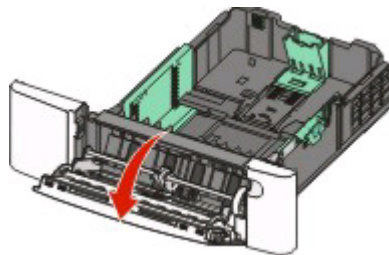

3 Grasp the extension, and pull it straight out until it is fully extended.

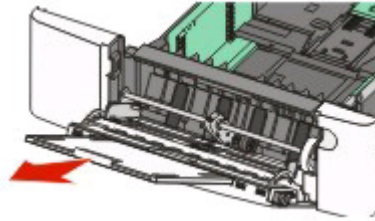

4 Prepare the paper for loading.

- Flex sheets of paper back and forth to loosen them, and then fan them. Do not fold or crease the paper. Straighten the edges on a level surface.



- Hold transparencies by the edges and fan them. Straighten the edges on a level surface.

Note: Avoid touching the print side of transparencies. Be careful not to scratch them.



- Flex a stack of envelopes back and forth to loosen them, and then fan them. Straighten the edges on a level surface.

5 Locate the stack height limiter and tab.

Note: Do not exceed the maximum stack height by forcing paper under the stack height limiter.

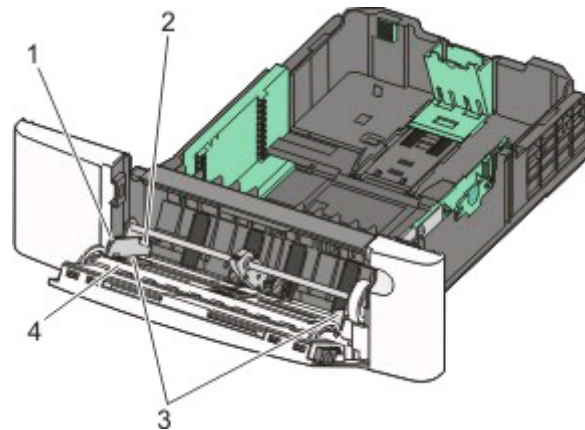

1	Tab
2	Stack height limiter

3	Width guide
4	Size indicators

- 6** Load the paper, and then adjust the width guide to lightly touch the edge of the paper stack.
- Load paper, card stock, and transparencies with the recommended print side facedown and the top edge entering first.

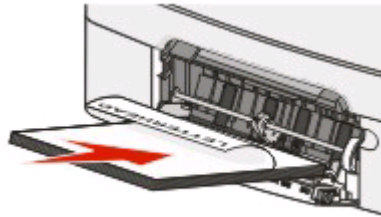

- Load envelopes with the flap side up.

Warning—Potential Damage: Never use envelopes with stamps, clasps, snaps, windows, coated linings, or self-stick adhesives. These envelopes may severely damage the printer..

Notes:

- Do not load or close the multipurpose feeder while a job is printing.
- Load only one size and type of paper at a time.

- 7** Make sure the paper is as far into the multipurpose feeder as it will go with very gentle pushing. Paper should lie flat in the multipurpose feeder. Make sure the paper fits loosely in the multipurpose feeder and is not bent or wrinkled.
- 8** From the printer control panel, set the Paper Size and Paper Type.

Using the manual feeder

- 1** Send a manual print job:

For Windows users:

- With a document open, click **File → Print**.
- Click **Properties, Preferences, Options, or Setup**.
- Select **Manual Paper**.
- Click **OK**.
- Click **OK** or **Print**.

For Macintosh users:

- With a document open, click **File > Print**.
- From the Copies & Pages or General pop-up menu, choose **Manual Paper**.
- Click **OK** or **Print**.

- 2** When **Load Manual** <type> <size> appears, load the paper facedown into the manual feeder. Load envelopes with the flap side up.

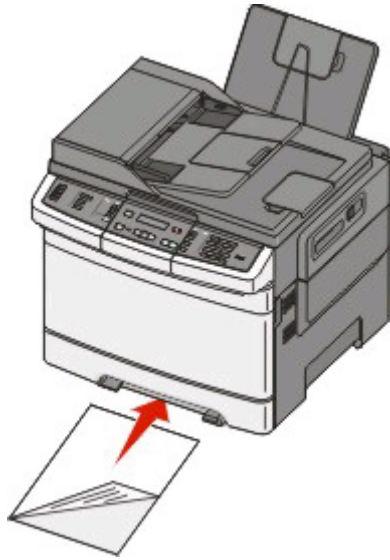

Notes:

- Align the long edge of the paper so that it is flush with the right side of the manual feeder.
- To achieve the best possible print quality, use only high-quality paper designed for laser printers.

- 3** Move the width guide until it lightly touches the sheet. Do not force the width guide against the paper, or it could be damaged.

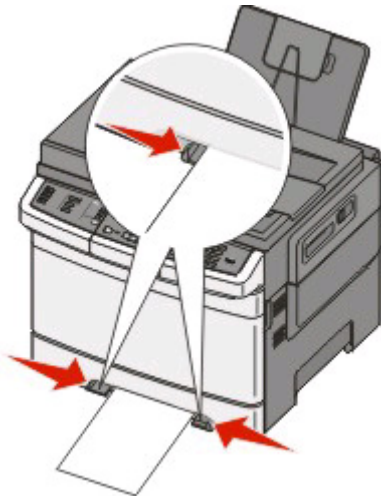

- 4** Push the paper in until it stops. The printer pulls it in farther.
- 5** From the printer control panel, set the Paper Size and Paper Type.

Paper and specialty media guide

Additional information for printing on speciality medias may be found in the *Cardstock and Label Guide* available on Lexmark.com/publications.

Paper guidelines

Paper characteristics

The following paper characteristics affect print quality and reliability. Consider these characteristics when evaluating new paper stock.

Weight

The printer can automatically feed paper weights from 60 to 176 g/m² (16 to 47 lb bond) grain long. Paper lighter than 75 g/m² (20 lb) might not be stiff enough to feed properly, causing jams. For best performance, use 80 g/m² (21 lb bond) grain long paper. For paper smaller than 182 x 257 mm (7.2 x 10.1 in.), we recommend 90 g/m² or heavier paper.

Curl

Curl is the tendency for paper to curl at its edges. Excessive curl can cause paper feeding problems. Curl can occur after the paper passes through the printer, where it is exposed to high temperatures. Storing paper unwrapped in hot, humid, cold, or dry conditions, even in the trays, can contribute to paper curling prior to printing and can cause feeding problems.

Smoothness

Paper smoothness directly affects print quality. If paper is too rough, toner cannot fuse to it properly. If paper is too smooth, it can cause paper feeding or print quality issues. Always use paper between 100 and 300 Sheffield points; however, smoothness between 150 and 200 Sheffield points produces the best print quality.

Moisture content

The amount of moisture in paper affects both print quality and the ability of the printer to feed the paper correctly. Leave paper in its original wrapper until it is time to use it. This limits the exposure of paper to moisture changes that can degrade its performance.

Condition paper before printing by storing it in its original wrapper in the same environment as the printer for 24 to 48 hours before printing. Extend the time several days if the storage or transportation environment is very different from the printer environment. Thick paper may also require a longer conditioning period.

Grain direction

Grain refers to the alignment of the paper fibers in a sheet of paper. Grain is either *grain long*, running the length of the paper, or *grain short*, running the width of the paper.

For 60 to 176 g/m² (16 to 47 lb bond) paper, use grain long fibers.

Fiber content

Most high-quality xerographic paper is made from 100% chemically treated pulped wood. This content provides the paper with a high degree of stability resulting in fewer paper feeding problems and better print quality. Paper containing fibers such as cotton possesses characteristics that can negatively affect paper handling.

Unacceptable paper

The following paper types are not recommended for use with the printer:

- Chemically treated papers used to make copies without carbon paper, also known as carbonless papers, carbonless copy paper (CCP), or no carbon required (NCR) paper
- Preprinted papers with chemicals that may contaminate the printer
- Preprinted papers that can be affected by the temperature in the printer fuser
- Preprinted papers that require a registration (the precise print location on the page) greater than ± 2.3 mm (± 0.9 in.), such as optical character recognition (OCR) forms

In some cases, registration can be adjusted with a software application to successfully print on these forms.

- Coated papers (erasable bond), synthetic papers, thermal papers
- Rough-edged, rough or heavily textured surface papers, or curled papers
- Recycled papers that fail EN12281:2002 (European)
- Paper weighing less than 60 g/m^2 (16 lb)
- Multiple-part forms or documents

Selecting paper

Using appropriate paper prevents jams and helps ensure trouble-free printing.

To help avoid jams and poor print quality:

- *Always* use new, undamaged paper.
- Before loading paper, know the recommended print side of the paper. This information is usually indicated on the paper package.
- *Do not* use paper that has been cut or trimmed by hand.
- *Do not* mix paper sizes, types, or weights in the same source; mixing results in jams.
- *Do not* use coated papers unless they are specifically designed for electrophotographic printing.

Selecting preprinted forms and letterhead

Use these guidelines when selecting preprinted forms and letterhead:

- Use grain long for 60 to 176 g/m^2 weight paper.
- Use only forms and letterhead printed using an offset lithographic or engraved printing process.
- Avoid papers with rough or heavily textured surfaces.

Use papers printed with heat-resistant inks designed for use in xerographic copiers. The ink must be able to withstand temperatures up to 200°C (392°F) without melting or releasing hazardous emissions. Use inks that are not affected by the resin in toner. Inks that are oxidation-set or oil-based generally meet these requirements; latex inks might not. When in doubt, contact the paper supplier.

Preprinted papers such as letterhead must be able to withstand temperatures up to 200°C (392°F) without melting or releasing hazardous emissions.

Storing paper

Use these paper storage guidelines to help avoid jams and uneven print quality:

- For best results, store paper where the temperature is 21°C (70°F) and the relative humidity is 40%. Most label manufacturers recommend printing in a temperature range of 18 to 24°C (65 to 75°F) with relative humidity between 40 and 60%.
- Store paper in cartons when possible, on a pallet or shelf, rather than on the floor.
- Store individual packages on a flat surface.
- Do not store anything on top of individual paper packages.

Supported paper sizes, types, and weights

The following tables provide information on standard and optional paper sources and the types of paper they support.

Note: For an unlisted paper size, select the closest *larger* listed size.

Paper sizes supported by the printer

Paper size	Dimensions	250-sheet tray (standard)	550-sheet tray (optional)	Optional multipurpose feeder	Manual feeder	Duplex	Standard exit tray
A4	210 x 297 mm (8.3 x 11.7 in.)	✓	✓	✓	✓	✓	✓
A5	148 x 210 mm (5.83 x 8.3 in.)	✓	✓	✓	✓	X	✓
JIS B5	182 x 257 mm (7.2 x 10.1 in.)	✓	✓	✓	✓	X	✓
A6	105 x 148 mm (4.1 x 5.8 in.)	X	X	✓	✓	X	✓
Statement	140 x 216 mm (5.5 x 8.5 in.)	X	X	✓	✓	X	✓
Letter	216 x 279 mm (8.5 x 11 in.)	✓	✓	✓	✓	✓	✓
Folio	216 x 330 mm (8.5 x 13 in.)	✓	✓	✓	✓	✓	✓
Oficio (Mexico)	216 x 340 mm (8.5 x 13 in.)	✓	✓	✓	✓	✓	✓
Legal	216 x 356 mm (8.5 x 14 in.)	✓	✓	✓	✓	✓	✓
Executive	184 x 267 mm (7.3 x 10.5 in.)	✓	✓	✓	✓	X	✓

* When Universal is selected, the page is formatted for 216 x 356 mm (8.5 x 14 in.) unless the size is specified by the software program.

Paper size	Dimensions	250-sheet tray (standard)	550-sheet tray (optional)	Optional multipurpose feeder	Manual feeder	Duplex	Standard exit tray
Universal*	148 x 210 mm (5.8x8.3 in.) up to 216 x 356 mm (8.5 x 14 in.)	✓	✓	✓	✓	X	✓
	76 x 127 mm (3 x 5 in.) up to 216 x 356 mm (8.5 x 14 in.)	X	X	✓	✓	X	✓
	210 x 279 mm (8.3 x 11 in.) up to 216 x 356 mm (8.5 x 14 in.)	✓	✓	✓	✓	✓	✓
7 3/4 Envelope (Monarch)	98 x 191 mm (3.9 x 7.5 in.)	X	X	✓	✓	X	✓
9 Envelope	98 x 225 mm (3.9 x 8.9 in.)	X	X	✓	✓	X	✓
10 Envelope	105 x 241 mm (4.1 x 9.5 in.)	X	X	✓	✓	X	✓
DL Envelope	110 x 220 mm (4.3 x 8.7 in.)	X	X	✓	✓	X	✓
B5 Envelope	176 x 250 mm (6.9 x 9.8 in.)	X	X	✓	✓	X	✓
C5 Envelope	162 x 229 mm (6.4 x 9 in.)	X	X	✓	✓	X	✓
Monarch	105 x 241 mm (4.1 x 9.5 in.)	X	X	✓	✓	X	✓
Other Envelope	98 x 162 mm (3.9x6.3 in.) up to 176 x 250 mm (6.9 x 9.8 in.)	X	X	✓	✓	X	✓

* When Universal is selected, the page is formatted for 216 x 356 mm (8.5 x 14 in.) unless the size is specified by the software program.

Paper types supported by the printer

Paper type	Standard 250-sheet tray (Tray 1)	Optional 550-sheet tray (Tray 2)	Optional multipurpose feeder	Manual feeder	Duplex	Standard exit bin
Paper	✓	✓	✓	✓	✓	✓
Card stock	✓	✓	✓	✓	X	✓

* Lexmark transparency part numbers 12A8240 and 12A8241 are supported from the standard tray, manual feeder, and the optional multipurpose feeder.

Paper type	Standard 250-sheet tray (Tray 1)	Optional 550-sheet tray (Tray 2)	Optional multipurpose feeder	Manual feeder	Duplex	Standard exit bin
Transparencies*	✓	X	✓	✓	X	✓
Envelopes	X	X	✓	✓	X	✓
Paper labels	✓	✓	✓	✓	X	✓

* Lexmark transparency part numbers 12A8240 and 12A8241 are supported from the standard tray, manual feeder, and the optional multipurpose feeder.

Paper types and weights supported by the printer

Paper type	Standard 250-sheet tray (Tray 1)	Optional 550-sheet tray (Tray 2)	Optional multipurpose feeder	Manual feeder
Light ^{1,2}	60 to 74.9 g/m ² grain long (16 to 19.9 lb bond)	60 to 74.9 g/m ² grain long (16 to 19.9 lb bond)	60 to 74.9 g/m ² grain long (16 to 19.9 lb bond)	60 to 74.9 g/m ² grain long (16 to 19.9 lb bond)
Plain ^{1,2}	75 to 89.9 g/m ² grain long (20 to 23.8 lb bond)	75 to 89.9 g/m ² grain long (20 to 23.8 lb bond)	75 to 89.9 g/m ² grain long (20 to 23.8 lb bond)	75 to 89.9 g/m ² grain long (20 to 23.8 lb bond)
Heavy ^{1,2}	90 to 104.9 g/m ² grain long (23.9 to 27.8 lb bond)	90 to 104.9 g/m ² grain long (23.9 to 27.8 lb bond)	90 to 104.9 g/m ² grain long (23.9 to 27.8 lb bond)	90 to 104.9 g/m ² grain long (23.9 to 27.8 lb bond)
Cardstock ^{1,2}	105 to 176 g/m ² grain long (27.8 to 47 lb bond)	105 to 176 g/m ² grain long (27.8 to 47 lb bond)	105 to 176 g/m ² grain long (27.8 to 47 lb bond)	105 to 176 g/m ² grain long (27.8 to 47 lb bond)
Glossy papers	Book —88 to 176 g/m ² grain long (60 to 120 lb book) Cover —162 to 176 g/m ² grain long (60 to 65 lb cover)	Book —88 to 176 g/m ² grain long (60 to 120 lb book) Cover —162 to 176 g/m ² grain long (60 to 65 lb cover)	Book —88 to 176 g/m ² grain long (60 to 120 lb book) Cover —162 to 176 g/m ² grain long (60 to 65 lb cover)	Book —88 to 176 g/m ² grain long (60 to 120 lb book) Cover —162 to 176 g/m ² grain long (60 to 65 lb cover)

¹ Paper types must be set to match the supporting paper weights.

² The duplex supports paper weights between 60–105 g/m² (16–28 lb) grain long bond. The duplex does not support card stock, transparencies, envelopes, and labels.

³ For 60 to 176 g/m² (16 to 47 lb bond) paper, we recommend grain long fibers.

⁴ Lexmark transparency part numbers 12A8240 and 12A8241 are supported from the standard tray, manual feeder, and the optional multipurpose feeder.

⁵ The pressure sensitive area must enter the printer first.

⁶ 100 percent cotton content maximum weight is 90 g/m² (24 lb) bond.

⁷ 105 g/m² (28 lb) bond envelopes are limited to 25 percent cotton content.

Paper type	Standard 250-sheet tray (Tray 1)	Optional 550-sheet tray (Tray 2)	Optional multipurpose feeder	Manual feeder
Card stock—maximum (grain long) ³	Index Bristol —120 g/m ² (67 lb) Tag —120 g/m ² (74 lb) Cover —135 g/m ² (50 lb)	Index Bristol —120 g/m ² (67 lb) Tag —120 g/m ² (74 lb) Cover —135 g/m ² (50 lb)	Index Bristol —120 g/m ² (67 lb) Tag —120 g/m ² (74 lb) Cover —135 g/m ² (50 lb)	Index Bristol —120 g/m ² (67 lb) Tag —120 g/m ² (74 lb) Cover —135 g/m ² (50 lb)
Card stock—maximum (grain short) ¹	Index Bristol —163 g/m ² (90 lb) Tag —163 g/m ² (100 lb) Cover —176 g/m ² (65 lb)	Index Bristol —163 g/m ² (90 lb) Tag —163 g/m ² (100 lb) Cover —176 g/m ² (65 lb)	Index Bristol —163 g/m ² (90 lb) Tag —163 g/m ² (100 lb) Cover —176 g/m ² (65 lb)	Index Bristol —163 g/m ² (90 lb) Tag —163 g/m ² (100 lb) Cover —176 g/m ² (65 lb)
Transparencies ⁴	170–180 g/m ² (45 to 48 lb)	N/A	170–180 g/m ² (45 to 48 lb)	170–180 g/m ² (45 to 48 lb)
Labels—maximum ⁵	Paper —131 g/m ² (35 lb bond)	Paper —131 g/m ² (35 lb bond)	Paper —131 g/m ² (35 lb bond)	Paper —131 g/m ² (35 lb bond)
Envelopes ^{6,7}	X	X	60 to 105 g/m ² (16 to 28 lb bond)	60 to 105 g/m ² (16 to 28 lb bond)

¹ Paper types must be set to match the supporting paper weights.

² The duplex supports paper weights between 60–105 g/m² (16–28 lb) grain long bond. The duplex does not support card stock, transparencies, envelopes, and labels.

³ For 60 to 176 g/m² (16 to 47 lb bond) paper, we recommend grain long fibers.

⁴ Lexmark transparency part numbers 12A8240 and 12A8241 are supported from the standard tray, manual feeder, and the optional multipurpose feeder.

⁵ The pressure sensitive area must enter the printer first.

⁶ 100 percent cotton content maximum weight is 90 g/m² (24 lb) bond.

⁷ 105 g/m² (28 lb) bond envelopes are limited to 25 percent cotton content.

Paper capacities

Input capacities

Paper type	Standard 250-sheet tray (Tray 1)	Optional 550-sheet tray (Tray 2)	Optional multipurpose tray
Paper	250 sheets ¹	550 sheets ¹	100 sheets ¹
Labels	100 ²	200 ²	50 ²
Transparencies	50	X	50
Envelopes	X	X	10
Other	X	X	Various quantities ³

¹ Based on 75 g/m² (20 lb) paper

²Capacity varies depending on label material and construction.

³Capacity varies depending on the weight and type of media.

Output capacity

Paper type	Standard 150-sheet output bin ²
Paper	150 sheets ¹
¹ Based on 75 g/m ² (20 lb) paper	
² Capacity may vary depending on media specifications and the printer operating environment.	

Using recycled paper and other office papers

As an environmentally conscious company, Lexmark supports the use of recycled office paper produced specifically for use in laser (electrophotographic) printers. In 1998, Lexmark presented to the US government a study demonstrating that recycled paper produced by major mills in the US fed as well as non-recycled paper. However, no blanket statement can be made that *all* recycled paper will feed well.

Lexmark consistently tests its printers with recycled paper (20–100% post-consumer waste) and a variety of test paper from around the world, using chamber tests for different temperature and humidity conditions. Lexmark has found no reason to discourage the use of today's recycled office papers, but generally the following property guidelines apply to recycled paper.

- Low moisture content (4–5%)
- Suitable smoothness (100–200 Sheffield units, or 140–350 Bendtsen units, European)

Note: Some much smoother papers (such as premium 24 lb laser papers, 50–90 Sheffield units) and much rougher papers (such as premium cotton papers, 200–300 Sheffield units) have been engineered to work very well in laser printers, despite surface texture. Before using these types of paper, consult your paper supplier.

- Suitable sheet-to-sheet coefficient of friction (0.4–0.6)
- Sufficient bending resistance in the direction of feed

Recycled paper, paper of lower weight (<60 g/m² [16 lb bond]) and/or lower caliper (<3.8 mils [0.1 mm]), and paper that is cut grain-short for portrait (or short-edge) fed printers may have lower bending resistance than is required for reliable paper feeding. Before using these types of paper for laser (electrophotographic) printing, consult your paper supplier. Remember that these are general guidelines only and that paper meeting these guidelines may still cause paper feeding problems in any laser printer (for example, if the paper curls excessively under normal printing conditions).

Printing

This chapter covers printing, printer reports, and job cancellation. Selection and handling of paper and specialty media can affect how reliably documents print. For more information, see "Avoiding jams" and "Storing print media."

Printing a document

- 1 Load paper into a tray or feeder.
- 2 From the printer control panel Paper menu, set the Paper Type and Paper Size to match the loaded paper.
- 3 Do one of the following:

For Windows users

- a With a document open, click **File** → **Print**.
- b Click **Properties**, **Preferences**, **Options**, or **Setup**, and then adjust the settings as needed.
Note: To print on a specific size or type of paper, adjust the paper size or type settings to match the loaded paper, or select the appropriate tray or feeder.
- c Click **OK**, and then click **Print**.

For Macintosh users

- a Customize the settings as needed in the Page Setup dialog:
 - 1 With a document open, choose **File** > **Page Setup**.
 - 2 Choose a paper size or create a custom size to match the loaded paper.
 - 3 Click **OK**.
- b Customize the settings as needed in the Print dialog:
 - 1 With a document open, choose **File** > **Print**.
If necessary, click the disclosure triangle to see more options.
 - 2 From the Print dialog and pop-up menus, adjust the settings as needed.
Note: To print on a specific paper type, adjust the paper type setting to match the loaded paper, or select the appropriate tray or feeder.
 - 3 Click **Print**.

Warning—Potential Damage: While printing, do not touch the metal shaft in the area where the printer ejects paper into the standard exit bin.

Printing on specialty media

Tips on using letterhead

Page orientation is important when printing on letterhead. Use the following table to determine which direction to load the letterhead:

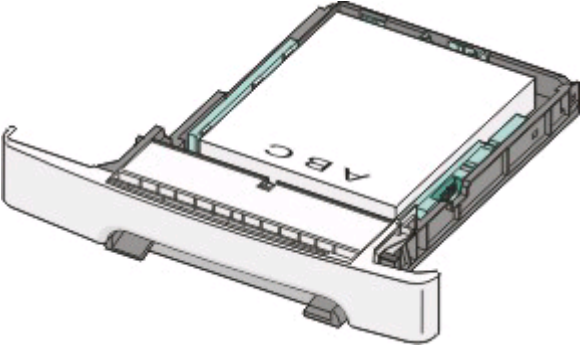
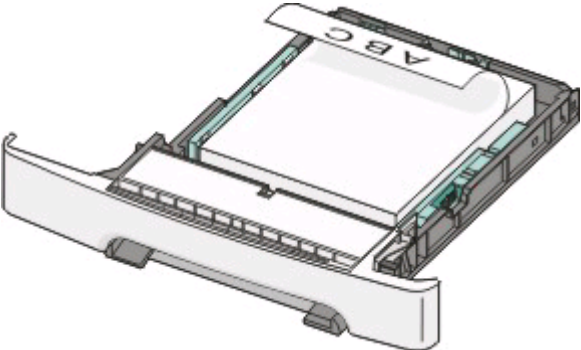
Source or process	Print side and paper orientation
<ul style="list-style-type: none">• Standard 250-sheet tray• Optional 550-sheet tray• Simplex (one-sided) printing from trays	<p>Printed letterhead design is placed faceup. The top edge of the sheet with the logo is placed at the front of the tray.</p> 
Duplex (two-sided) printing from trays	<p>Printed letterhead design is placed facedown. The top edge of the sheet with the logo is placed at the back of the tray.</p> 
<p>Note: Check with the manufacturer or vendor to determine whether the chosen preprinted letterhead is acceptable for laser printers.</p>	

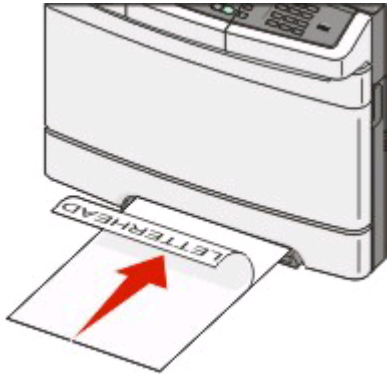
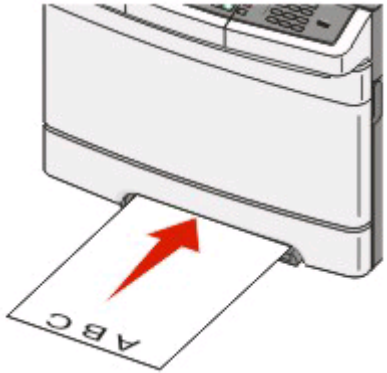
Source or process	Print side and paper orientation
Manual feeder (simplex printing) Multipurpose feeder	Preprinted letterhead design is placed facedown. The top edge of the sheet with the logo should enter the manual feeder first. 
Manual feeder (duplex printing) Multipurpose feeder	Preprinted letterhead design is placed faceup. The top edge of the sheet with the logo should enter the manual feeder last. 
Note: Check with the manufacturer or vendor to determine whether the chosen preprinted letterhead is acceptable for laser printers.	

Tips on using transparencies

Print samples on the transparencies being considered for use before buying large quantities.

When printing on transparencies:

- Feed transparencies from the 250-sheet tray, manual feeder, or optional multipurpose feeder.
- Use transparencies designed specifically for laser printers. Check with the manufacturer or vendor to ensure transparencies are able to withstand temperatures up to 200°C (392°F) without melting, discoloring, offsetting, or releasing hazardous emissions.
- To prevent print quality problems, avoid getting fingerprints on the transparencies.
- Before loading transparencies, fan the stack to prevent sheets from sticking together.
- We recommend Lexmark part number 12A8240 for letter-size transparencies and Lexmark part number 12A8241 for A4-size transparencies.

Tips on using envelopes

Print samples on the envelopes being considered for use before buying large quantities.

When printing on envelopes:

- Feed envelopes from the manual feeder or optional multipurpose feeder.
- Set the Paper Type to Envelope, and select the envelope size.
- Use envelopes designed specifically for laser printers. Check with the manufacturer or vendor to ensure the envelopes can withstand temperatures up to 200°C (392°F) without sealing, wrinkling, curling excessively, or releasing hazardous emissions.
- For the best performance, use envelopes made from 60 g/m² (16 lb bond) paper. Use up to 105 g/m² (28 lb bond) weight for envelopes as long as the cotton content is 25% or less. All-cotton envelopes must not exceed 90 g/m² (24 lb bond) weight.
- Use only new envelopes.
- To optimize performance and minimize jams, do not use envelopes that:
 - Have excessive curl or twist
 - Are stuck together or damaged in any way
 - Have windows, holes, perforations, cutouts, or embossing
 - Have metal clasps, string ties, or folding bars
 - Have an interlocking design
 - Have postage stamps attached
 - Have any exposed adhesive when the flap is in the sealed or closed position
 - Have bent corners
 - Have rough, cockle, or laid finishes
- Adjust the width guides to fit the width of the envelopes.

Note: A combination of high humidity (over 60%) and the high printing temperature may wrinkle or seal envelopes.

Tips on using paper labels

Print samples on the labels being considered for use before buying large quantities.

Note: Use only paper label sheets.

When printing on labels:

- From MarkVision Professional, the printer software, or the printer control panel, set the Paper Type to Labels.
- Use only letter-, A4-, or legal-size label sheets.
- Use labels designed specifically for laser printers. Check with the manufacturer or vendor to verify that:
 - The labels can withstand temperatures up to 200°C (392°F) without sealing, excessive curling, wrinkling, or releasing hazardous emissions.
 - Label adhesives, face sheet (printable stock), and topcoats can withstand up to 25 psi (172 kPa) pressure without delaminating, oozing around the edges, or releasing hazardous fumes.
- Do not use labels with slick backing material.
- Use full label sheets. Partial sheets may cause labels to peel off during printing, resulting in a jam. Partial sheets also contaminate the printer and the cartridge with adhesive, and could void the printer and cartridge warranties.
- Do not use labels with exposed adhesive.
- Do not print within 1 mm (0.04 in.) of the edge of the label, of the perforations, or between die-cuts of the label.
- Be sure adhesive backing does not reach to the sheet edge. Zone coating of the adhesive at least 1 mm (0.04 in.) away from edges is recommended. Adhesive material contaminates the printer and could void the warranty.

- If zone coating of the adhesive is not possible, remove a 1.6 mm (0.06 in.) strip on the leading and driver edge, and use a non-oozing adhesive.
- Portrait orientation works best, especially when printing bar codes.

Tips on using card stock

Card stock is heavy, single-ply specialty media. Many of its variable characteristics, such as moisture content, thickness, and texture, can significantly impact print quality. Print samples on the card stock being considered for use before buying large quantities.

When printing on card stock:

- From MarkVision Professional, the printer software, or the printer control panel:
 - 1 Set the Paper Type to Card Stock.
 - 2 Set the Paper Weight to Card Stock Weight.
 - 3 Set the Card Stock Weight to Normal or Heavy.
- Be aware that preprinting, perforation, and creasing may significantly affect the print quality and cause jams or other paper handling problems.
- Check with the manufacturer or vendor to ensure the card stock can withstand temperatures up to 200°C (392°F) without releasing hazardous emissions.
- Do not use preprinted card stock manufactured with chemicals that may contaminate the printer. Preprinting introduces semi-liquid and volatile components into the printer.
- Use grain short card stock when possible.

Printing from a flash drive

A USB port is located on the printer control panel. Insert a flash drive to print supported file types. Supported file types include: .pdf, .gif, .jpeg, .jpg, .bmp, .png, .tiff, .tif, .pcx, and .dcx.

The following flash drives are tested and approved for use with the printer.

- Lexar JumpDrive 2.0
- Pro (256 MB, 512 MB, or 1G sizes) or
- SanDisk Cruzer Mini (256 MB, 512 MB, or 1G sizes);

Notes:

- When a USB flash memory device is inserted into the printer, the printer can only scan to the USB device or print files from the USB device. All other printer functions are unavailable.
- Hi-Speed USB devices must support the Full-speed standard. Devices only supporting USB Low-speed capabilities are not supported.
- USB devices must support the FAT (*File Allocation Tables*) system. Devices formatted with NTFS (*New Technology File System*) or any other file system are not supported.
- Before printing an encrypted .pdf file, enter the file password from the printer control panel.
- You cannot print files for which you do not have printing permissions.

To print from a flash drive:

- 1 Make sure the printer is on and **Ready** or **Busy** appears.
- 2 Insert a flash drive into the USB port.

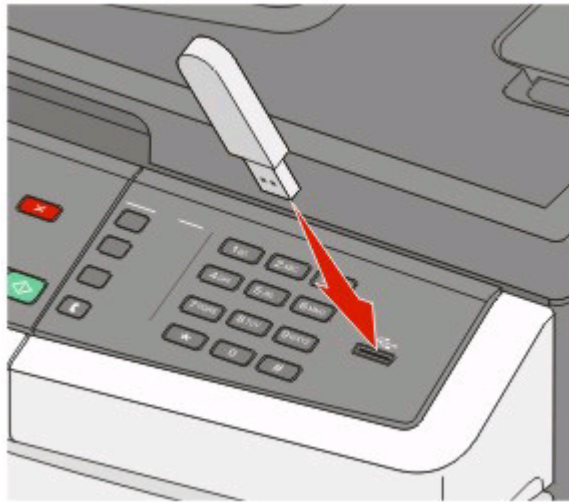

Notes:

- If you insert the flash drive when the printer requires attention, such as when a jam has occurred, the printer ignores the flash drive.
- If you insert the flash drive while the printer is printing other jobs, **Busy** appears. After the other jobs are processed, you may need to view the held jobs list to print documents from the flash drive.

- 3 Press the arrow button until the document you want to print appears, and then press .

Note: Folders found on the flash drive appear with a + in front of the folder (for example, + documents). File names are appended by the extension type (for example, .jpg).

- 4 Press to print one copy, or enter the number of copies using the keypad, and then press to initiate the print job.

Note: Do not remove the flash drive from the USB port until the document has finished printing.

Printing photos from a PictBridge-enabled digital camera

You can connect a PictBridge-enabled digital camera to the printer, and use the buttons on the camera to select and print photos.

- 1 Insert one end of the USB cable into the camera.

Note: Use only the USB cable that came with your camera.

- 2 Insert the other end of the USB cable into the USB port on the front of the printer.

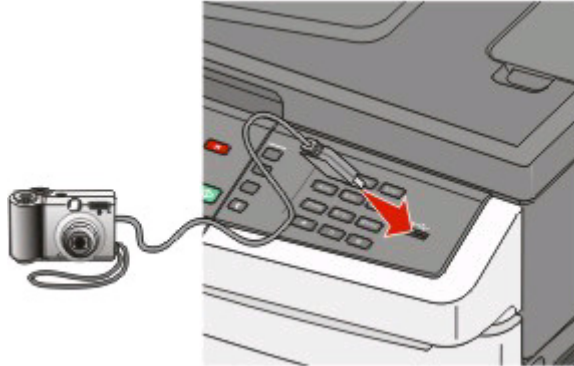

Notes:

- Make sure the PictBridge-enabled digital camera is set to the correct USB mode. See the camera documentation for more information.
- If the PictBridge connection is successful, then a confirmation message appears on the printer display.

- 3 Follow the instructions on the camera to select and print photos.



Note: If the printer is turned off while the camera is connected, then you must disconnect and then reconnect the camera.



Printing information pages

See “Printing menu settings pages” on page 33 and “Printing a network setup page” on page 33 for more information on printing these pages.

Printing a font sample list



To print samples of the fonts currently available for your printer:

- 1 Make sure the printer is on and **Ready** appears.
- 2 From the printer control panel, press .
- 3 Press the arrow buttons until **Reports** appears, and then press .

- 4 Press the arrow buttons until **Print Fonts** appears, and then press .
 - 5 Press the arrow buttons until **PCL Fonts, PostScript Fonts, or PPDS Fonts** appears, and then press .
- After the font sample list prints, **Ready** appears.



Printing a directory list

A directory list shows the resources stored in flash memory or on the hard disk.

- 1 Make sure the printer is on and **Ready** appears.
 - 2 From the printer control panel, press .
 - 3 Press the arrow buttons until **Reports** appears, and then press .
- After the directory list prints, **Ready** appears.



Printing the print quality test pages

Print the print quality test pages to isolate print quality problems.

- 1 Turn the printer off.
 - 2 Hold down  and the right arrow button while turning the printer on.
 - 3 Release the buttons when the dots appear, and wait for **CONFIG MENU** to appear.
 - 4 Press the arrow buttons until **PRINT_QUAL_TXT** appears, and then press .
- The print quality test pages print.
- 5 Press the arrow buttons until **Exit Config Menu** appears, and then press .
- Resetting the Printer** appears briefly, and then **Ready** appears.

Canceling a print job

Canceling a print job from the printer control panel

- 1 Press .
- Stopped** appears.
- 2 Press the arrow buttons until **Cancel a job** appears, and then press .

Canceling a print job from the computer

To cancel a print job, do one of the following:

For Windows users

In Windows Vista:

- 1 Click .
- 2 Click **Control Panel**.

- 3** Click **Hardware and Sound**.
- 4** Click **Printers**.
- 5** Double-click the printer icon.
- 6** Select the job to cancel.
- 7** From the keyboard, press **Delete**.

In Windows XP:

- 1** Click **Start**.
- 2** From **Printers and Faxes**, double-click the printer icon.
- 3** Select the job to cancel.
- 4** From the keyboard, press **Delete**.

From the Windows taskbar:

When you send a job to print, a small printer icon appears in the right corner of the taskbar.

- 1** Double-click the printer icon.
A list of print jobs appears in the printer window.
- 2** Select a job to cancel.
- 3** From the keyboard, press **Delete**.

For Macintosh users

In Mac OS X version 10.5:

- 1** From the Apple menu, choose **System Preferences**.
- 2** Click **Print & Fax**, and then double-click the printer icon.
- 3** From the printer window, select the job to cancel.
- 4** From the icon bar at the top of the window, click the **Delete** icon.

In Mac OS X version 10.4 and earlier:

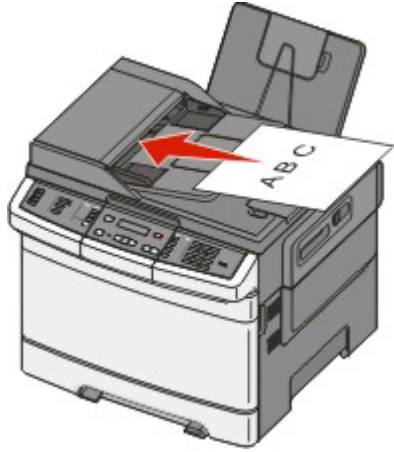
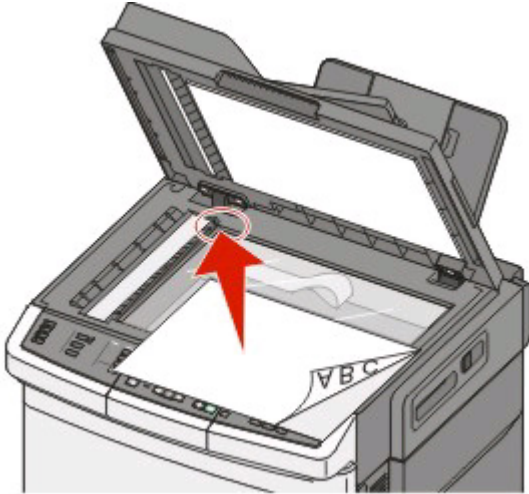

- 1** From the Go menu, choose **Applications**.
- 2** Double-click **Utilities**, and then double-click **Print Center** or **Printer Setup Utility**.
- 3** Double-click the printer icon.
- 4** From the printer window, select the job to cancel.
- 5** From the icon bar at the top of the window, click the **Delete** icon.

Copying

ADF	Scanner glass
 <p data-bbox="151 793 625 821">Use the ADF for multiple-page documents.</p>	 <p data-bbox="641 842 1442 930">Use the scanner glass for single pages, small items (such as postcards or photos), transparencies, photo paper, or thin media (such as magazine clippings).</p>

Making copies

Making a quick copy



- 1 Load an original document faceup, short edge first into the ADF or facedown on the scanner glass.
Note: Do not load postcards, photos, small items, transparencies, photo paper, or thin media (such as magazine clippings) into the ADF. Place these items on the scanner glass.
- 2 If you are loading a document into the ADF, adjust the paper guides.
- 3 From the printer control panel, press  for a black only copy or  for a color copy.
Note: If a Lexmark™ Document Solutions Suite (LDSS) profile has been installed, then you may receive an error when attempting a quick copy. Contact your system support person for access.
- 4 If you placed the document on the scanner glass and have additional pages to copy, then place the next page on the scanner glass, and then press **1** on the numeric keypad. Otherwise, press **2** on the numeric keypad.

Copying using the ADF



- 1 Load an original document faceup, short edge first into the ADF.
Note: Do not load postcards, photos, small items, transparencies, photo paper, or thin media (such as magazine clippings) into the ADF. Place these items on the scanner glass.
- 2 Adjust the paper guides.
- 3 From the printer control panel, press the **Copy** button, or use the keypad to enter the number of copies.

- 4 Change the copy settings as needed.
- 5 From the printer control panel, press  for a black only copy or  for a color copy.

Copying using the scanner glass





- 1 Place an original document facedown on the scanner glass in the upper left corner.
- 2 From the printer control panel, press the **Copy** button, or use the keypad to enter the number of copies.
- 3 Change the copy settings as needed.
- 4 From the printer control panel, press  for a black only copy or  for a color copy.
- 5 Place the next document on the scanner glass, and then press **1** on the numeric keypad. Otherwise, press **2** on the numeric keypad.

Copying photos





- 1 Place a photo facedown on the scanner glass in the upper left corner.
- 2 From the printer control panel, press the **Copy** button.
- 3 Press the **Content** button until the light next to **Photo** comes on.
- 4 Change the copy settings as needed.
- 5 From the printer control panel, press  for a black only copy or  for a color copy.
- 6 Place the next document on the scanner glass, and then press **1** on the numeric keypad. Otherwise, press **2** on the numeric keypad.

Copying on specialty media

Copying to transparencies





- 1 Load an original document faceup, short edge first into the ADF or facedown on the scanner glass.
Note: Do not load postcards, photos, small items, transparencies, photo paper, or thin media (such as magazine clippings) into the ADF. Place these items on the scanner glass.
- 2 If you are loading a document into the ADF, then adjust the paper guides.
- 3 From the printer control panel, press the **Copy** button.
- 4 From the Copy area, press the **Options** button.
- 5 Press the arrow buttons until **Paper Source** appears, and then press .
- 6 Press the arrow buttons until the tray or source containing the transparencies appears, and then press .
- 7 Change the copy settings as needed.
- 8 Press  for a black only copy or  for a color copy.
- 9 If you placed the document on the scanner glass and have additional pages to copy, then place the next page on the scanner glass, and then press **1** on the numeric keypad. Otherwise, press **2** on the numeric keypad.



Copying to letterhead

- 1 Load an original document faceup, short edge first into the ADF or facedown on the scanner glass.
Note: Do not load postcards, photos, small items, transparencies, photo paper, or thin media (such as magazine clippings) into the ADF. Place these items on the scanner glass.
- 2 If you are loading a document into the ADF, then adjust the paper guides.
- 3 From the printer control panel, press the **Copy** button.
- 4 From the Copy area, press the **Options** button.
- 5 Press the arrow buttons until **Paper Source** appears, and then press .
- 6 Press the arrow buttons until the tray or source containing the letterhead appears, and then press .
- 7 Change the copy settings as needed.
- 8 Press  for a black only copy or  for a color copy.
- 9 If you placed the document on the scanner glass and have additional pages to copy, then place the next page on the scanner glass, and then press **1** on the numeric keypad. Otherwise, press **2** on the numeric keypad.

Customizing copy settings

Copying from one size to another





- 1 Load an original document faceup, short edge first into the ADF or facedown on the scanner glass.
Note: Do not load postcards, photos, small items, transparencies, photo paper, or thin media (such as magazine clippings) into the ADF. Place these items on the scanner glass.
- 2 If you are loading a document into the ADF, then adjust the paper guides.
- 3 From the printer control panel, press the **Copy** button.
- 4 From the Copy area, press the **Options** button.
Original Size appears.
- 5 Press .
- 6 Press the arrow buttons until the size of the original document appears, and then press .
- 7 Press the arrow buttons until **Paper Source** appears, and then press .
- 8 Press the arrow buttons until the tray or source containing the size you want the copy to be appears, and then press .

- Note:** If you select a paper size that is different from the original size, then the printer will scale the size automatically.
- 9 Change the copy settings as needed.
- 10 Press  for a black only copy or  for a color copy.

- 11 If you placed the document on the scanner glass and have additional pages to copy, then place the next page on the scanner glass, and then press **1** on the numeric keypad. Otherwise, press **2** on the numeric keypad.
- 12 Press  to return to the **Ready** state.



Making copies using paper from a selected tray

During the copy process, you can select the tray that contains the paper type of choice. For example, if specialty media is loaded in the multipurpose feeder, and you want to make copies on that media:

- 1 Load an original document faceup, short edge first into the ADF or facedown on the scanner glass.
Note: Do not load postcards, photos, small items, transparencies, photo paper, or thin media (such as magazine clippings) into the ADF. Place these items on the scanner glass.
- 2 If you are loading a document into the ADF, then adjust the paper guides.
- 3 From the printer control panel, press the **Copy** button.
- 4 From the Copy area, press the **Options** button.
- 5 Press the arrow buttons until **Paper Source** appears, and then press .
- 6 Press the arrow buttons until the tray or source containing the media you want the copy to be on appears, and then press .
- 7 Change the copy settings as needed.
- 8 Press  for a black only copy or  for a color copy.
- 9 If you placed the document on the scanner glass and have additional pages to copy, then place the next page on the scanner glass, and then press **1** on the numeric keypad. Otherwise, press **2** on the numeric keypad.
- 10 Press  to return to the **Ready** state.

Copying on both sides of the paper (duplexing)





Note: The duplex feature is not available on selected printer models.

- 1 Load an original document faceup, short edge first into the ADF or facedown on the scanner glass.
Note: Do not load postcards, photos, small items, transparencies, photo paper, or thin media (such as magazine clippings) into the ADF. Place these items on the scanner glass.
- 2 If you are loading a document into the ADF, then adjust the paper guides.
- 3 From the printer control panel, press the **Copy** button.
- 4 Press the **Duplex/2-Sided** button.
- 5 Press the arrow buttons until **1 To 2 Sided** appears, and then press .
The first number represents sides of the original documents; the second number represents sides of the copy. For example, select 1-sided to 2-sided if you have 1-sided original documents and you want 2-sided copies.
- 6 Press  for a black only copy or  for a color copy.
- 7 If you placed the document on the scanner glass and have additional pages to copy, then place the next page on the scanner glass, and then press **1** on the numeric keypad. Otherwise, press **2** on the numeric keypad.



Reducing or enlarging copies

Copies can be reduced to 25% of the original document size or enlarged to 400% of the original document size. The factory default setting for Scale is Auto. If you leave Scale set to Auto, then the content of your original document will be scaled to fit the size of the paper onto which you are copying.



To reduce or enlarge a copy:

- 1 Load an original document faceup, short edge first into the ADF or facedown on the scanner glass.
Note: Do not load postcards, photos, small items, transparencies, photo paper, or thin media (such as magazine clippings) into the ADF. Place these items on the scanner glass.
- 2 If you are loading a document into the ADF, then adjust the paper guides.
- 3 From the printer control panel, press the **Copy** button.
- 4 Press the **Scale** button.
- 5 Press the arrow buttons until the scale option you want appears, and then press .
If you selected Custom then do the following:
 - a Press the arrow buttons to decrease or increase the size, or enter a number between 25 and 400 on the numeric keypad.
 - b Press .
- 6 Press  for a black only copy or  for a color copy.
- 7 If you placed the document on the scanner glass and have additional pages to copy, then place the next page on the scanner glass, and then press **1** on the numeric keypad. Otherwise, press **2** on the numeric keypad.

Making a copy lighter or darker

- 1 Load an original document faceup, short edge first into the ADF or facedown on the scanner glass.
Note: Do not load postcards, photos, small items, transparencies, photo paper, or thin media (such as magazine clippings) into the ADF. Place these items on the scanner glass.
- 2 If you are loading a document into the ADF, then adjust the paper guides.
- 3 From the printer control panel, press the **Copy** button.
- 4 Press the **Darkness** button.
- 5 Press the arrow buttons to make the copy lighter or darker.
- 6 Press .
- 7 Press  for a black only copy or  for a color copy.
- 8 If you placed the document on the scanner glass and have additional pages to copy, then place the next page on the scanner glass, and then press **1** on the numeric keypad. Otherwise, press **2** on the numeric keypad.

Adjusting copy quality

- 1 Load an original document faceup, short edge first into the ADF or facedown on the scanner glass.
Note: Do not load postcards, photos, small items, transparencies, photo paper, or thin media (such as magazine clippings) into the ADF. Place these items on the scanner glass.
- 2 If you are loading a document into the ADF, then adjust the paper guides.
- 3 From the printer control panel, press the **Copy** button.
- 4 Press the **Content** button until the light comes on next to the setting that best represents what you are copying:
 - **Text**—Used for original documents that are mostly text or line art
 - **Text/Photo**—Used when the original documents are a mixture of text and graphics or pictures
 - **Photo**—Used when the original document is a high-quality photograph or inkjet print
- 5 Press  for a black only copy or  for a color copy.
- 6 If you placed the document on the scanner glass and have additional pages to copy, then place the next page on the scanner glass, and then press **1** on the numeric keypad. Otherwise, press **2** on the numeric keypad.
- 7 Press  to return to the **Ready** state.

Collating copies

If you print multiple copies of a document, then you can choose to print each copy as a set (collated) or to print the copies as groups of pages (not collated).

Collated







Not collated



By default, Collate is set to On. If you do not want to collate your copies, then change the setting to Off.

To turn collation off:

- 1 Load an original document faceup, short edge first into the ADF or facedown on the scanner glass.
Note: Do not load postcards, photos, small items, transparencies, photo paper, or thin media (such as magazine clippings) into the ADF. Place these items on the scanner glass.
- 2 If you are loading a document into the ADF, then adjust the paper guides.
- 3 From the printer control panel, press the **Copy** button.
- 4 From the Copy area, press the **Options** button.
- 5 Press the arrow buttons until **Collate** appears, and then press .
- 6 Press the arrow buttons until **Off** [1, 1, 1, 2, 2, 2] appears, and then press .
- 7 Press  for a black only copy or  for a color copy.
- 8 If you placed the document on the scanner glass and have additional pages to copy, then place the next page on the scanner glass, and then press **1** on the numeric keypad. Otherwise, press **2** on the numeric keypad.

Placing separator sheets between copies

1 Type the printer IP address into the address field of your Web browser.

Note: If you do not know the IP address of the printer, then print a network setup page and locate the address in the TCP/IP section.

2 Click **Settings**.

3 Click **Copy Settings**.

4 Click **Separator Sheets**.

Note: Collation must be On for the separator sheets to be placed between copies. If Collation is Off, then the separator sheets are added to the end of the print job.

5 Select one of the following:

- Between pages
- Between copies
- Between jobs

6 Click **Submit**.

Copying multiple pages onto a single sheet

In order to save paper, you can copy either two or four consecutive pages of a multiple-page document onto a single sheet of paper.

Notes:

- The Paper Size must be set to Letter, Legal, A4, or B5 JIS.
- The Copy Size must be set to 100%.

1 Load an original document faceup, short edge first into the ADF or facedown on the scanner glass.

Note: Do not load postcards, photos, small items, transparencies, photo paper, or thin media (such as magazine clippings) into the ADF. Place these items on the scanner glass.

2 If you are loading a document into the ADF, then adjust the paper guides.



3 From the printer control panel, press the **Copy** button.

4 From the Copy area, press the **Options** button.

5 Press the arrow buttons until **Paper Saver** appears, and then press .

6 Select the output you want.

For example, if you have four portrait-oriented original documents that you want copied to the same side of one sheet, stop at **4 on 1 Portrait**, and then press .

7 Press  for a black only copy or  for a color copy.

8 If you placed the document on the scanner glass and have additional pages to copy, then place the next page on the scanner glass, and then press **1** on the numeric keypad. Otherwise, press **2** on the numeric keypad.

Canceling a copy job

A copy job can be canceled when the document is in the ADF, on the scanner glass, or while the document is printing. To cancel a copy job:

1 From the printer control, panel press .
Stopping appears, followed by **Cancel Job**.

2 Press  to cancel the job.

Note: If you want to continue to process the job, then press  to continue copying.

Canceling appears.

The printer clears all pages in the ADF or printer and then cancels the job. Once the job is canceled, the copy screen appears.

Improving copy quality

Question	Tip
When should I use Text mode?	<ul style="list-style-type: none">• Use text mode when text preservation is the main goal of the copy, and preserving images copied from the original document is not a concern.• Text mode is recommended for receipts, carbon copy forms, and documents that contain only text or fine line art.
When should I use Text/Photo mode?	<ul style="list-style-type: none">• Use Text/Photo mode when copying an original document that contains a mixture of text and graphics.• Text/Photo mode is recommended for magazine articles, business graphics, and brochures.
When should I use Photograph mode?	Use Photograph mode when the original document is a high-quality photograph or inkjet print.

E-mailing

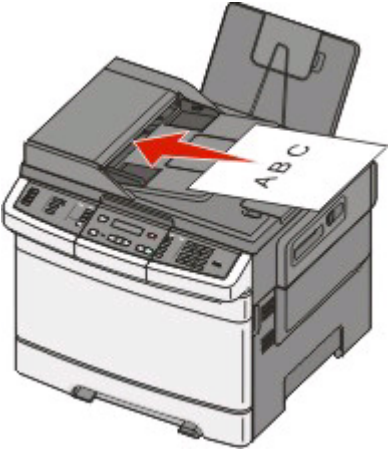
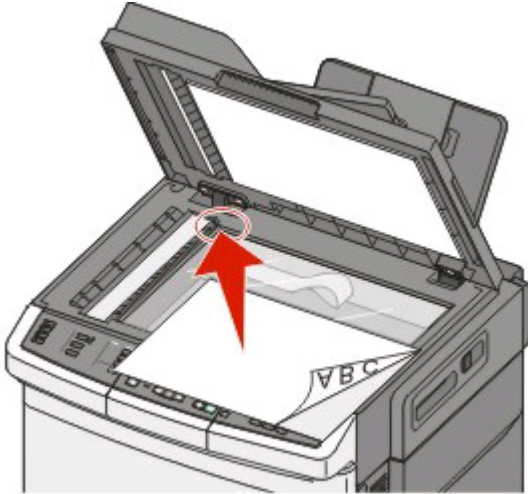
ADF	Scanner glass
 <p data-bbox="151 793 621 821">Use the ADF for multiple-page documents.</p>	 <p data-bbox="643 842 1438 930">Use the scanner glass for single pages, small items (such as postcards or photos), transparencies, photo paper, or thin media (such as magazine clippings).</p>

You can use the printer to e-mail scanned documents to one or more recipients. There are three ways to send and e-mail from the printer. You can type the e-mail address, use a shortcut number, or use the address book.

Getting ready to e-mail

Setting up the e-mail function

For e-mail to operate, it must be turned on in the printer settings and have a valid IP address or gateway address. To set up the e-mail function:

- 1 Type the printer IP address into the address field of your Web browser.
Note: If you do not know the IP address of the printer, then print a network setup page and locate the address in the TCP/IP section.
- 2 Click **Settings**.
- 3 Click **E-mail Settings**.
- 4 Click **E-mail Server Setup**.
- 5 Change the e-mail settings as needed.
- 6 Click **Submit**.

Setting up the address book

- 1 Type the printer IP address into the address field of your Web browser.

Note: If you do not know the IP address of the printer, then print a network setup page and locate the address in the TCP/IP section.

- 2 Click **Settings**.
- 3 Click **E-mail Settings**.
- 4 Click **Manage E-mail Shortcuts**.
- 5 Change the e-mail settings as needed.
- 6 Click **Submit**.

Creating an e-mail shortcut using the Embedded Web Server

- 1 Type the printer IP address into the address field of your Web browser.

Note: If you do not know the IP address of the printer, then print a network setup page and locate the address in the TCP/IP section.

- 2 Click **Settings**.
- 3 Click **Manage Destinations**.

Note: You may be asked to enter a password. If you do not have an ID and password, get one from your system support person.

- 4 Click **E-mail Destination Setup**.
- 5 Type a unique name for the recipient, and then enter the e-mail address.

Note: If you are entering multiple addresses, separate each address with a comma (,).

- 6 Select the scan settings (Format, Content, Color, and Resolution).
- 7 Enter a shortcut number, and then click **Add**.

If you enter a number that is already in use, you are prompted to select another number.

E-mailing a document

Sending an e-mail using the keypad

- 1 Load an original document faceup, short edge first into the ADF or facedown on the scanner glass.

Note: Do not load postcards, photos, small items, transparencies, photo paper, or thin media (such as magazine clippings) into the ADF. Place these items on the scanner glass.

- 2 If you are loading a document into the ADF, then adjust the paper guides.



- 3 From the printer control panel, press the **Scan/Email** button.

Scan to E-mail appears.



- 4 Press .

Search or **Manual Entry** appears.

Note: If there are no entries in the address book, then **Manual Entry** appears.



- 5 Press  to search the address book or press the arrow buttons until **Manual** appears, and then press  to select or enter an e-mail address.

Using the address book

- a After selecting **Search** on the printer control panel, press the arrow buttons until the address you want appears, and then press .
- b Press **1** to search for another address or press **2** to end the search.
After you press **2**, **Press Start To Begin** appears.
- c Press  to send a black only copy or  to send a color copy.

Manually entering an e-mail address

After selecting **Manual** on the printer control panel, **Entry Name** appears on the first line and a blank line with a blinking cursor appears on the second line.

- a Press the button on the numeric keypad that corresponds with the number or letter you want. The first time you press the button, the number for that button appears. When you press the button again, one of the letters assigned to that button appears.
- b Press the right arrow button to move to the next space, or wait a few seconds and the cursor will move to the next space.
- c Once the e-mail address is entered, press .
- Another E-mail? 1=Yes 2=NO** appears.
- d Press **1** to enter another address, or press **2** to end the address entry.
After you press **2**, **Press Start To Begin** appears.
- e Press  to send a black only copy or  to send a color copy.

Sending an e-mail using a shortcut number

- 1 Load an original document faceup, short edge first into the ADF or facedown on the scanner glass.

Note: Do not load postcards, photos, small items, transparencies, photo paper, or thin media (such as magazine clippings) into the ADF. Place these items on the scanner glass.

- 2 If you are loading a document into the ADF, then adjust the paper guides.



- 3 From the printer control panel, press the **Scan/Email** button.

Scan to E-mail appears.





- 4 Press .

Search appears.

Note: If there are no entries in the address book, **Manual Entry** appears.



- 5 Press , and then enter the recipient's shortcut number.
- 6 Press **1** to enter another shortcut or press **2** to end the shortcut entry.
After you press **2**, **Press Start To Begin** appears.
- 7 Press  to send a black only e-mail or  to send a color e-mail.

Sending an e-mail using the address book

- 1 Load an original document faceup, short edge first into the ADF or facedown on the scanner glass.
Note: Do not load postcards, photos, small items, transparencies, photo paper, or thin media (such as magazine clippings) into the ADF. Place these items on the scanner glass.
- 2 If you are loading a document into the ADF, then adjust the paper guides.
- 3 From the printer control panel, press the **Scan/Email** button.
Scan to E-mail appears.
- 4 Press .
Search appears.
Note: If there are no entries in the address book, **Manual Entry** appears.
- 5 Press  to search the address book.
- 6 Press the arrow buttons until the address you want appears, and then press .
- 7 Press **1** to search for another address or press **2** to end the search.
After you press **2**, **Press Start To Begin** appears.
- 8 Press  to send a black only copy or  to send a color copy.

Canceling an e-mail

An e-mail can be canceled when the document is in the ADF or on the scanner glass. To cancel an e-mail:

- 1 From the printer control panel, press .
Stopping appears, and then **Cancel Job** appears.
- 2 Press  to cancel the job.
Note: If you want to continue to process the job, press  to continue scanning the e-mail.
Canceling appears.

The printer clears all pages in the ADF and then cancels the job. Once the job is canceled, the copy screen appears.

Faxing

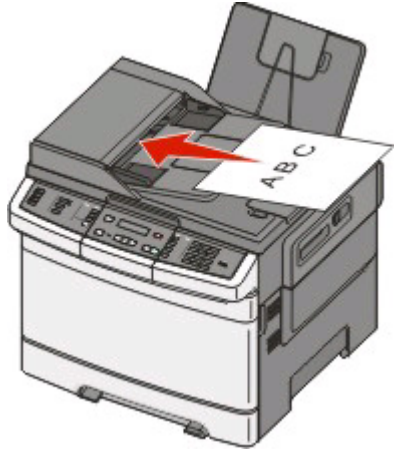
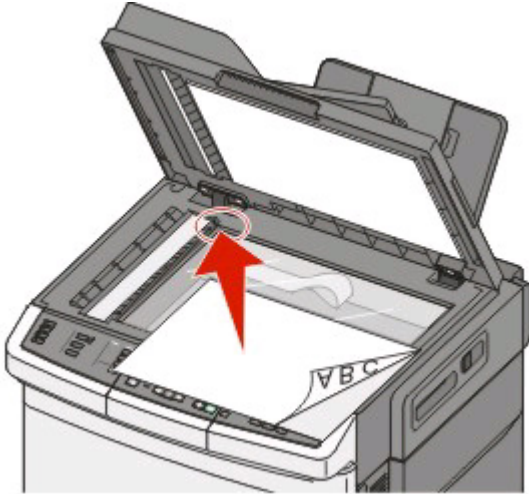
ADF	Scanner glass
 <p data-bbox="151 793 621 821">Use the ADF for multiple-page documents.</p>	 <p data-bbox="641 842 1438 932">Use the scanner glass for single pages, small items (such as postcards or photos), transparencies, photo paper, or thin media (such as magazine clippings).</p>

Getting the printer ready to fax

The following connection methods may not be applicable in all countries or regions.

 **CAUTION—SHOCK HAZARD:** Do not use the fax feature during a lightning storm. Do not set up this product or make any electrical or cabling connections, such as the fax feature, power cord, or telephone, during a lightning storm.

Warning—Potential Damage: Do not touch cables or the printer in the area shown while actively sending or receiving a fax.

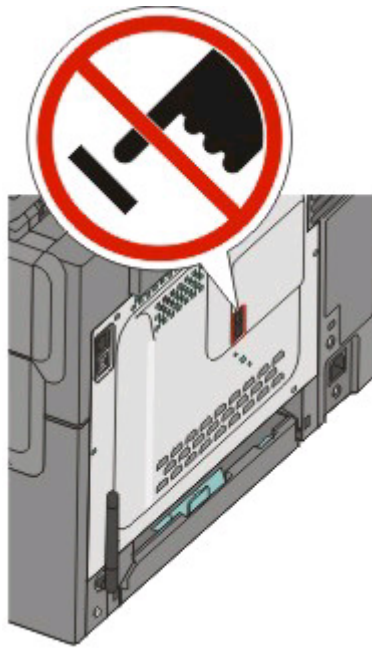

Initial fax setup

Many countries and regions require outgoing faxes to contain the following information in a margin at the top or bottom of each transmitted page, or on the first page of the transmission: station name (identification of the business, other entity, or individual sending the message) and station number (telephone number of the sending fax machine, business, other entity, or individual).

To enter your fax setup information, use the printer control panel, or use your browser to access the Embedded Web Server and then enter the Settings menu.

Note: If you do not have a TCP/IP environment, then you must use the printer control panel to enter your fax setup information.

Using the printer control panel for fax setup

When the printer is turned on for the first time or if the printer has been off for an extended time, a series of start-up screens appear. If the printer has fax capabilities, then the following screens appear:

Station Name
Station Number

- 1** When **Station Name** appears, enter the name to be printed on all outgoing faxes.
 - a** Press the button on the numeric keypad that corresponds with the number or letter you want. The first time you press the button, the number for that button appears. When you press the button again, one of the letters assigned to that button appears.
 - b** Press the right arrow button to move to the next space, or wait a few seconds and the cursor will move to the next space.
- 2** After entering the Station Name, press .
The display changes to Station Number.

- 3 When **Station Number** appears, enter the printer fax number.
 - a Press the button on the numeric keypad that corresponds with the number you want.
 - b Press the right arrow button to move to the next space, or wait a few seconds and the cursor will move to the next space.
- 4 After entering the Station Number, press .

Using the Embedded Web Server for fax setup

- 1 Type the printer IP address into the address field of your Web browser.

Note: If you do not know the IP address of the printer, then print a network setup page and locate the address in the TCP/IP section.
- 2 Click **Settings**.
- 3 Click **Fax Settings**.
- 4 Click **Analog Fax Setup**.
- 5 Click inside the Station Name box, and then enter the name to be printed on all outgoing faxes.
- 6 Click inside the Station Number box, and then enter the printer fax number.
- 7 Click **Submit**.

Choosing a fax connection

You can connect the printer with equipment such as a telephone, an answering machine, or a computer modem. To determine the best way to set up the printer, see the following table.

Notes:

- The printer is an analog device that works best when directly connected to the wall outlet. Other devices (such as a telephone or answering machine) can be successfully attached to pass through the printer, as described in the setup steps.
- If you want a digital connection such as ISDN, DSL, or ADSL, a third-party device (such as a DSL filter) is required. Contact your DSL provider for a DSL filter. The DSL filter removes the digital signal on the telephone line that can interfere with the ability of the printer to fax properly.
- You *do not* need to attach the printer to a computer, but you *do* need to connect it to an analog telephone line to send and receive faxes.

Equipment and service options	Fax connection setup
Connect directly to the telephone line	See "Connecting to an analog telephone line" on page 76
Connect to a Digital Subscriber Line (DSL or ADSL) service	See "Connecting to a DSL service" on page 76.
Connect to a Private Branch eXchange (PBX) or Integrated Services Digital Network (ISDN) system	See "Connecting to a PBX or ISDN system" on page 77.
Use a Distinctive Ring service	See "Connecting to a Distinctive Ring Service" on page 78.
Connect to a telephone line, telephone, and answering machine	See "Connecting a telephone or answering machine to the same telephone line" on page 79

Equipment and service options	Fax connection setup
Connect through an adapter used in your area	See “Connecting to an adapter for your country or region” on page 81.
Connect to a computer with a modem	See “Connecting to a computer with a modem” on page 85.

Connecting to an analog telephone line

There is a plug installed in the EXT port  of the printer. This plug is necessary for the proper functioning of the printer.

Note: Do not remove the plug. If you remove it, then other telecommunications devices in your home (such as telephones or answering machines) may not work.

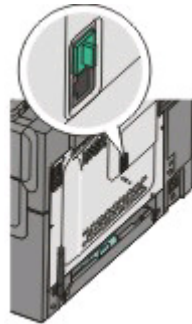

If your telecommunications equipment uses a US-style (RJ11) telephone line, then follow these steps to connect the equipment:

- 1 Connect one end of the telephone cable that came with the printer to the bottom LINE port  on the back of the printer.
- 2 Connect the other end of the telephone cable to an active analog telephone wall jack.

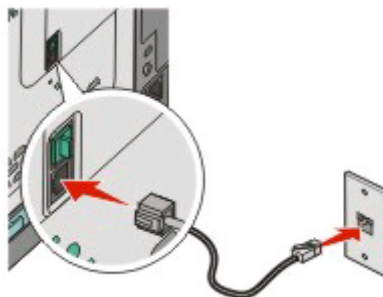

Connecting to a DSL service

There is a plug installed in the EXT port  of the printer. This plug is necessary for the proper functioning of the printer.

Note: Do not remove the plug. If you remove it, then other telecommunications devices in your home (such as telephones or answering machines) may not work.

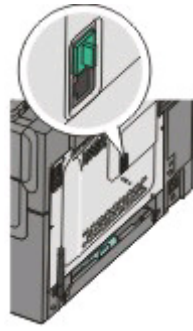

If you subscribe to a DSL service, then contact the DSL provider to obtain a DSL filter and telephone cord, and then follow these steps to connect the equipment:

- 1 Connect one end of the telephone cable that came with the printer to the LINE port  on the back of the printer.
- 2 Connect the other end of the telephone cable to the DSL filter.
Note: Your DSL filter may look different than the one in the illustration.
- 3 Connect the DSL filter cable to an active telephone wall jack.

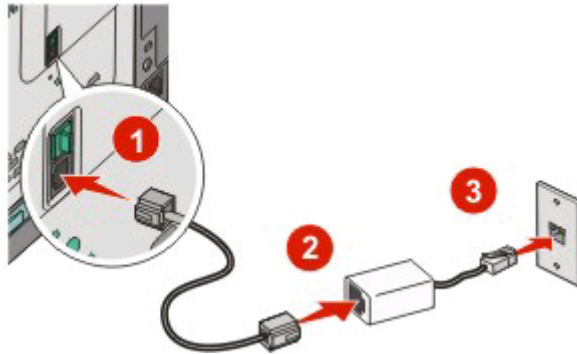

Connecting to a PBX or ISDN system

There is a plug installed in the EXT port  of the printer. This plug is necessary for the proper functioning of the printer.

Note: Do not remove the plug. If you remove it, then other telecommunications devices in your home (such as telephones or answering machines) may not work.

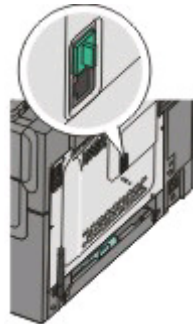

If you use a PBX or ISDN converter or terminal adapter, then follow these steps to connect the equipment:

- 1 Connect one end of the telephone cable that came with the printer to the LINE port  on the back of the printer.
- 2 Connect the other end of the telephone cable to the port designated for fax and telephone use.

Notes:

- Make sure the terminal adapter is set to the correct switch type for your region.
- Depending on the ISDN port assignment, you may have to connect to a specific port.
- When using a PBX, make sure the call waiting tone is off.
- When using a PBX system, dial the outside line prefix before dialing the fax number.
- For more information on using the fax with a PBX system, see the documentation that came with your PBX system.

Connecting to a Distinctive Ring Service

There is a plug installed in the EXT port  of the printer. This plug is necessary for the proper functioning of the printer.



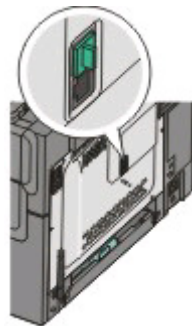

Note: Do not remove the plug. If you remove it, other telecommunications devices in your home (such as telephones or answering machines) may not work.

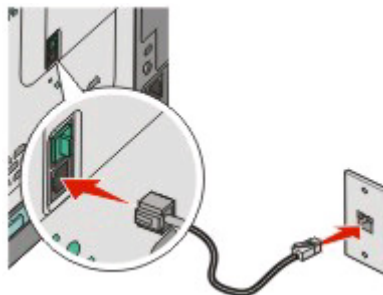

A distinctive ring service may be available from your telephone service provider. This service allows you to have multiple phone numbers on one telephone line with each phone number having a different ring pattern. This may be useful for distinguishing between fax and voice calls. If you subscribe to a distinctive ring service, follow these steps to connect the equipment:

- 1 Connect one end of the telephone cable that came with the printer to bottom LINE  jack on the back of the printer.
- 2 Connect the other end of the telephone cable to an active analog telephone wall jack.



- 3 Change the distinctive ring setting to match the setting you want the printer to answer.
 - a From the printer control panel, press .
 - b Press the arrow buttons until **Settings** appears, and then press .
 - c Press the arrow buttons until **Fax Settings** appears, and then press .
 - d Press the arrow buttons until **Distinctive Rings** appears, and then press .
 - e Press the arrow buttons until the desired ring tone appears, and then press .

Connecting a telephone or answering machine to the same telephone line

- 1 Remove the plug from the EXT port  on the back of the printer.

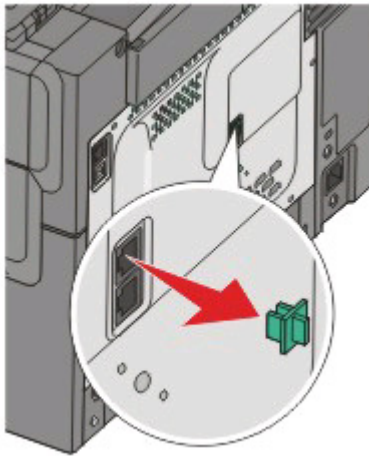

Note: Once this plug is removed, any country- or region-specific equipment you connect to the printer by way of the adapter, as shown, will not function properly.



- 2 Connect your telecommunications equipment directly to the EXT port  on the back of the printer.

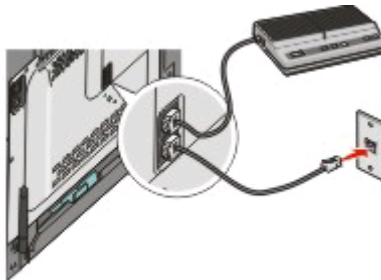

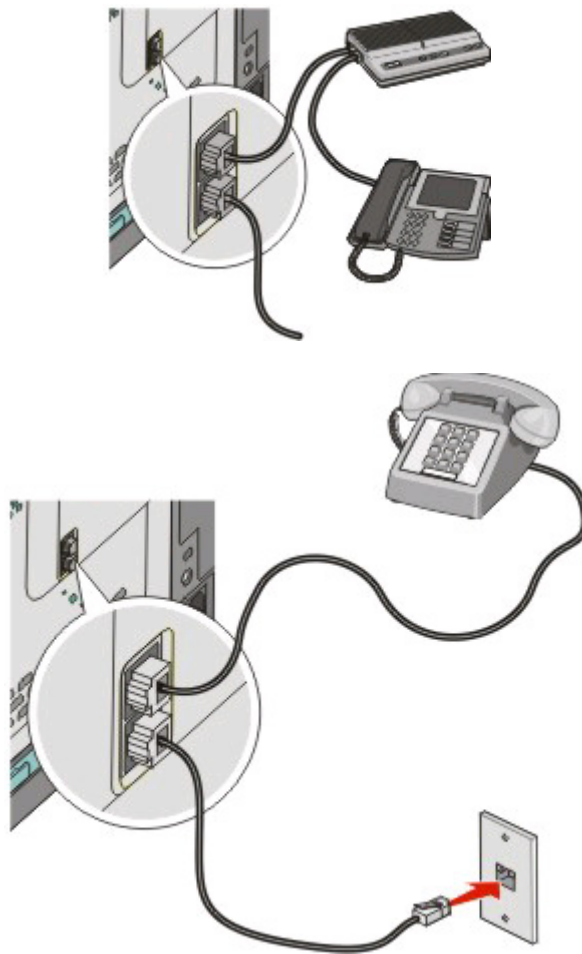

Warning—Potential Damage: Do not touch cables or the printer in the area shown while actively sending or receiving a fax.

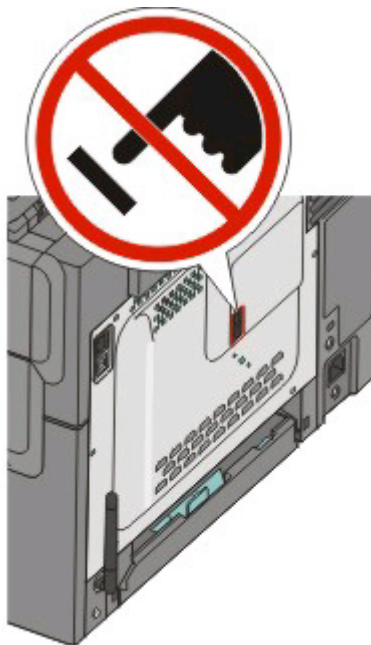

Connecting to an adapter for your country or region

The following countries or regions may require a special adapter to connect the telephone cable to the wall outlet.

Country/region

- Austria
- Cyprus
- Denmark
- Finland
- France
- Germany
- Ireland
- Italy
- New Zealand
- Netherlands
- Norway
- Portugal
- Sweden
- Switzerland
- United Kingdom

Countries or regions except Austria, Germany, and Switzerland

For some countries or regions, a telephone line adapter is included in the box. Use this adapter to connect an answering machine, telephone, or other telecommunications equipment to the printer.

There is a plug installed in the EXT port  of the printer. This plug is necessary for the proper functioning of the printer.

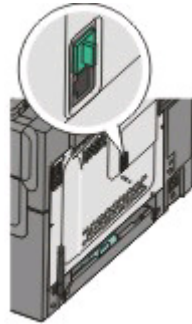

Note: Do not remove the plug. If you remove it, then other telecommunications devices in your home (such as telephones or answering machines) may not work.

- 1 Connect one end of the telephone cable that came with the printer to bottom LINE port  on the back of the printer.
- 2 Connect the other end of the telephone cable to the adapter, and then connect the adapter to the wall jack.

Note: Your telephone adapter may look different than the one shown. It will fit the telephone jack used in your location.

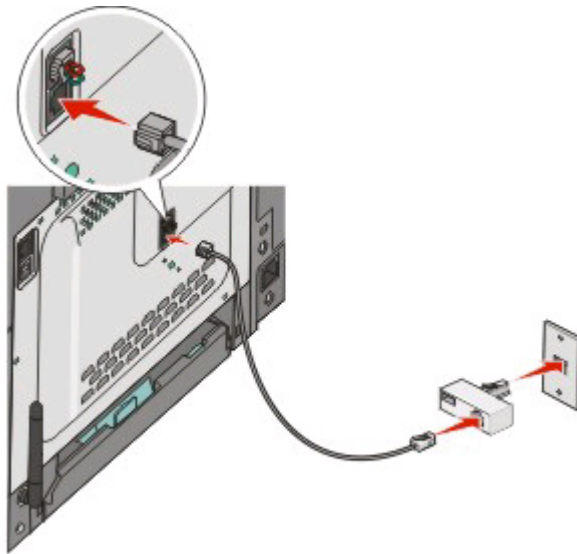

3 Connect the answering machine or telephone to the adapter

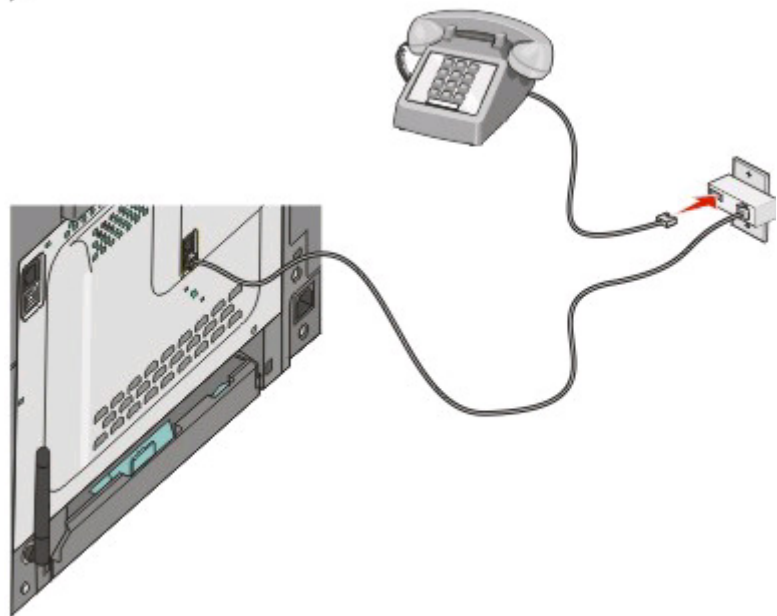
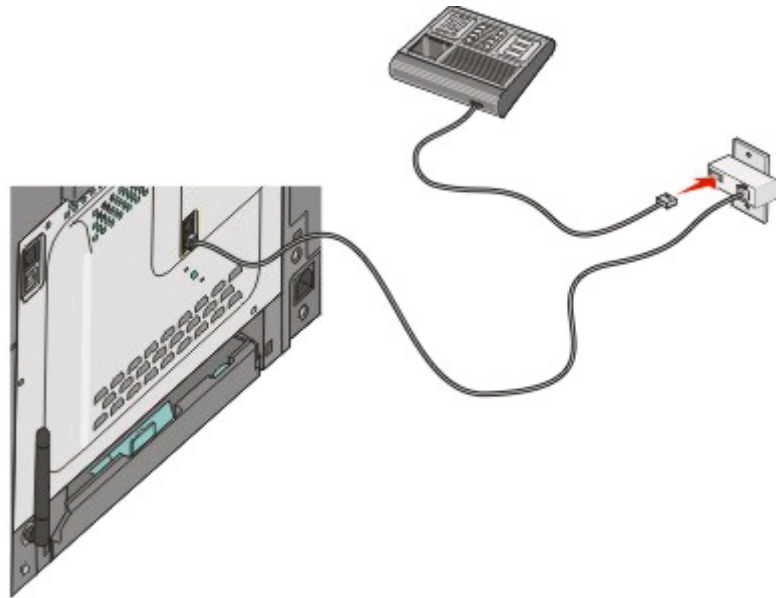

Austria, Germany, and Switzerland

There is a plug installed in the EXT port  of the printer. This plug is necessary for the proper functioning of the printer.

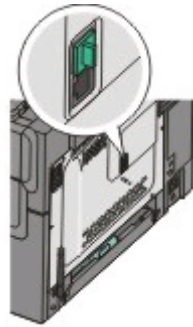

Note: Do not remove the plug. If you remove it, then other telecommunications devices in your home (such as telephones or answering machines) may not work.

- 1 Connect one end of the telephone cable that came with the printer to the LINE port  on the back of the printer.
- 2 Connect the other end of the telephone cable to the adapter, and then connect the adapter to the N slot of an active analog telephone wall jack.

Note: Your telephone adapter may look different than the one shown. It will fit the telephone jack used in your location.

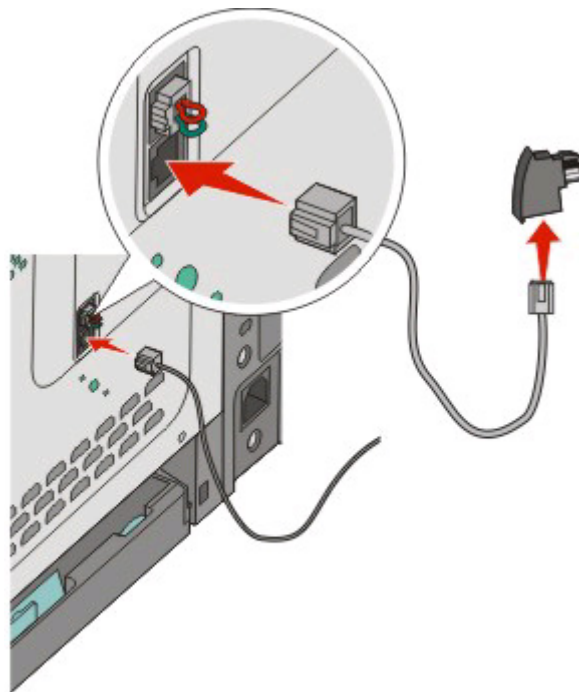

- 3** If you would like to use the same line for both fax and telephone communication, then connect a second telephone line (not provided) between the telephone and the F slot of an active analog telephone wall jack.

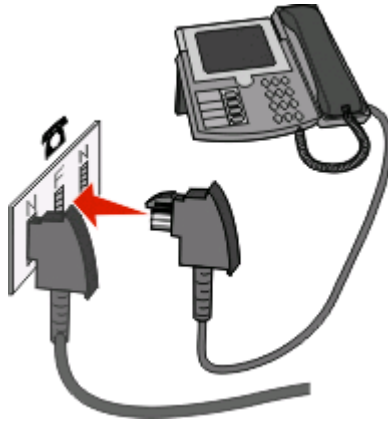

- 4** If you would like to use the same line for recording messages on your answering machine, then connect a second telephone line (not provided) between the answering machine and the other N slot of the active analog telephone wall jack.

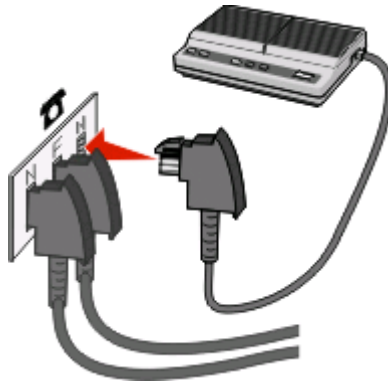

Connecting to a computer with a modem

Connect the printer to a computer with a modem to send faxes from the software program.

Note: Setup steps may vary depending on your country or region.

- 1** Make sure you have the following:
- A telephone
 - A computer with a modem
 - Three telephone cords
 - A telephone wall jack

2 Connect a telephone cord into the LINE  port of the printer, and then plug it into an active telephone wall jack.

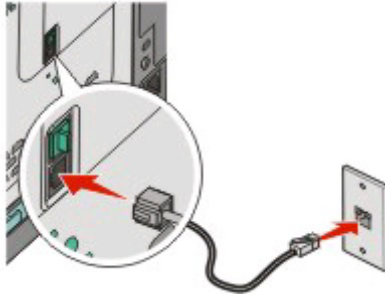

3 Remove the protective plug from the EXT port  of the printer.

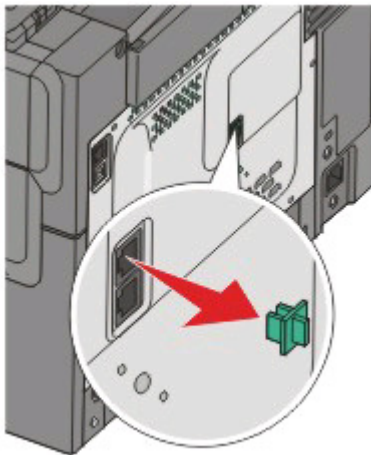

4 Connect a second telephone cord from the telephone to the computer modem.



- 5 Connect a third telephone cord from the computer modem to the EXT port  of the printer.

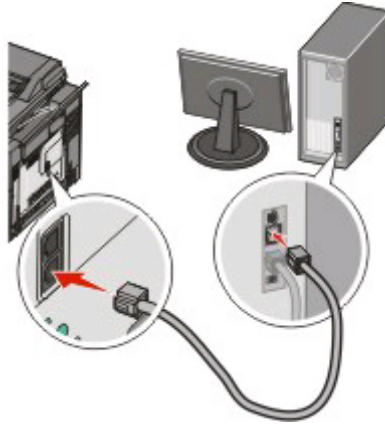

Setting the outgoing fax name and number

To have the designated fax name and fax number printed on outgoing faxes:

- 1 Type the printer IP address into the address field of your Web browser.
Note: If you do not know the IP address of the printer, then print a network setup page and locate the address in the TCP/IP section.
- 2 Click **Settings**.
- 3 Click **Fax Settings**.
- 4 Click **Analog Fax Setup**.
- 5 Click inside the Station Name box, and then enter the name to be printed on all outgoing faxes.
- 6 Click inside the Station Number box, and then enter the printer fax number.
- 7 Click **Submit**.

Setting the date and time

You can set the date and time so that they are printed on every fax you send. If there is a power failure, you may have to reset the date and time. To set the date and time:

- 1 Type the printer IP address into the address field of your Web browser.
Note: If you do not know the IP address of the printer, then print a network setup page and locate the address in the TCP/IP section.
- 2 Click **Settings**.
- 3 Click **Set Date and Time**.
- 4 Click inside the Set Date & Time box, and then enter the current date and time.
- 5 Click **Submit**.







Turning daylight saving time on or off

The printer can be set to automatically adjust for daylight saving time:

- 1 Type the printer IP address into the address field of your Web browser.
Note: If you do not know the IP address of the printer, then print a network setup page and locate the address in the TCP/IP section.
- 2 Click **Settings**.
- 3 Click **Set Date and Time**.
- 4 In the Daylight Savings box, click on one of the following:
Yes turns daylight saving on.
No turns daylight saving off.
- 5 Click **Submit**.

Sending a fax

Sending a fax using the printer control panel

- 1 Load an original document faceup, short edge first into the ADF or facedown on the scanner glass.
Note: Do not load postcards, photos, small items, transparencies, photo paper, or thin media (such as magazine clippings) into the ADF. Place these items on the scanner glass.
- 2 If you are loading a document into the ADF, then adjust the paper guides.
- 3 From the printer control panel, press the **Fax** button.
To: appears on the first line, and the time and date appear on the second line.
- 4 Enter the fax number, and then press .
- Notes:**
 - To place a dial pause within a fax number, press the **Redial/Pause** button. The dial pause appears as a comma on the Fax to: line. Use this feature if you need to dial an outside line first.
 - Press  to move the cursor to the left and delete a number.
 - To use a fax shortcut, press , and then press the arrow buttons until the fax shortcut you want appears. Then, press .
- 5 Press **1** to enter another fax number, or press **2** to end fax number entry.
- 6 Press  to send a black only fax or  to send a color fax.

Sending a fax using the computer

Faxing from a computer lets you send electronic documents without leaving your desk. This gives you the flexibility of faxing documents directly from software programs.

For Windows users

- 1 From your software program, click **File → Print**.
- 2 From the Print window, select your printer, and then click **Properties**.
Note: In order to perform this function from your computer, you must use the PostScript printer driver for your printer.
- 3 Click the **Other Options** tab, and then click **Fax**.
- 4 Click **OK**, and then click **OK** again.
- 5 On the Fax screen, type the name and number of the fax recipient.
- 6 Click **Send**.

For Mac OS X version 10.5 users

The steps for sending a fax from the computer vary depending on your operating system. For specific instructions using other Macintosh OS versions, see your Mac OS Help.

- 1 With a document open, choose **File > Print**.
- 2 From the Printer pop-up menu, choose your printer.
Note: In order to see the fax options on the Print dialog, you must use the fax driver for your printer. To install the fax driver, choose **Add a printer**, and then install the printer again with a different name, choosing the fax version of the driver.
- 3 Enter the fax information (for example, the name and number of the fax recipient).
- 4 Click **Fax**.

Creating shortcuts

Creating a fax destination shortcut using the Embedded Web Server

Instead of entering the entire phone number of a fax recipient on the printer control panel each time you want to send a fax, you can create a permanent fax destination and assign a shortcut number. You can create a shortcut to a single fax number or a group of fax numbers.

- 1 Type the printer IP address into the address field of your Web browser.
Note: If you do not know the IP address of the printer, then print a network setup page and locate the address in the TCP/IP section.
- 2 Click **Settings**.

3 Click **Manage Destinations**.

Note: A password may be required. If you do not have an ID and password, get one from your system support person.

4 Click **Fax Shortcut Setup**.

5 Type a unique name for the shortcut, and then enter the fax number.

To create a multiple-number shortcut, enter the fax numbers for the group.

Note: Separate each fax number in the group with a semicolon (;).

6 Assign a shortcut number.

If you enter a number that is already in use, you are prompted to select another number.

7 Click **Add**.

Creating a fax destination shortcut using the printer control panel

1 Load an original document faceup, short edge first into the ADF or facedown on the scanner glass.

Note: Do not load postcards, photos, small items, transparencies, photo paper, or thin media (such as magazine clippings) into the ADF. Place these items on the scanner glass.

2 If you are loading a document into the ADF, then adjust the paper guides.

3 From the printer control panel, press the **Fax** button.

To: appears on the first line, and the time and date appear on the second line.

4 Press .

Address Book Search appears.

5 Press the arrow buttons until **Add** appears, and then press .

6 Press the arrow buttons until **Enter Fax Number** appears, and then press .

7 Enter the fax number, and then press .

8 Press **1** to enter another fax number, or press **2** to end fax number entry.

9 After selecting **2=NO**, **Enter Name** appears.

a Press the button on the keypad that corresponds with the letter you want. The first time you press the button, the number for that button appears. When you press the button again, one of the letters assigned to that button appears.

b Press the right arrow button to move to the next space, or wait a few seconds and the cursor will move to the next space.

c Once the fax name is entered, press .

Save as Shortcut appears.

d Enter the shortcut number, and then press .

Using shortcuts and the address book

Using fax destination shortcuts

Fax destination shortcuts are just like the speed dial numbers on a telephone or fax machine. You can assign shortcut numbers when creating permanent fax destinations. Permanent fax destinations or speed dial numbers are created in the Manage Destinations link located under the Configuration tab on the Embedded Web Server. A shortcut number (1–99999) can contain a single recipient or multiple recipients. By creating a group fax destination with a shortcut number, you can quickly and easily fax broadcast information to an entire group.

- 1 Load an original document faceup, short edge first into the ADF or facedown on the scanner glass.

Note: Do not place postcards, photos, small items, transparencies, photo paper, or thin media (such as magazine clippings) into the ADF. Place these items on the scanner glass.

- 2 If you are loading a document into the ADF, then adjust the paper guides.

- 3 Press .

Enter Shortcut: appears.

- 4 Enter the shortcut number.

- 5 Press  to send a black only fax or  to send a color fax.

Using the address book

Note: If the address book feature is not enabled, contact your system support person.



- 1 Load an original document faceup, short edge first into the ADF or facedown on the scanner glass.

Note: Do not load postcards, photos, small items, transparencies, photo paper, or thin media (such as magazine clippings) into the ADF. Place these items on the scanner glass.

- 2 If you are loading a document into the ADF, then adjust the paper guides.

- 3 From the printer control panel, press the **Fax** button.

To: appears on the first line, and the time and date appear on the second line.

- 4 Press , and then press the arrow buttons until the fax number you want appears. Then, press .

Customizing fax settings

Changing the fax resolution



Adjusting the resolution setting changes the quality of the fax. Settings range from Standard (fastest speed) to Ultra Fine (slowest speed, best quality).

- 1 Load an original document faceup, short edge first into the ADF or facedown on the scanner glass.



Note: Do not load postcards, photos, small items, transparencies, photo paper, or thin media (such as magazine clippings) into the ADF. Place these items on the scanner glass.

- 2 If you are loading a document into the ADF, then adjust the paper guides.







- 3 From the Fax area of the printer control panel, press the **Resolution** area.

- 4 Press the arrow buttons until the resolution value you want appears, and then press .
- 5 Press  to send a black only copy or  to send a color copy.

Making a fax lighter or darker

- 1 Load an original document faceup, short edge first into the ADF or facedown on the scanner glass.
Note: Do not load postcards, photos, small items, transparencies, photo paper, or thin media (such as magazine clippings) into the ADF. Place these items on the scanner glass.
- 2 If you are loading a document into the ADF, then adjust the paper guides.
- 3 From the printer control panel, press the **Darkness** button.
- 4 Press the arrow buttons to make the fax lighter or darker.
- 5 Press .
- 6 Press  to send a black only fax or  to send a color fax.

Sending a fax at a scheduled time

- 1 Load an original document faceup, short edge first into the ADF or facedown on the scanner glass.
Note: Do not load postcards, photos, small items, transparencies, photo paper, or thin media (such as magazine clippings) into the ADF. Place these items on the scanner glass.
- 2 If you are loading a document into the ADF, then adjust the paper guides.
- 3 From the printer control panel, press the **Fax** button.
To: appears on the first line, and the time and date appear on the second line.
- 4 Enter the fax number, and then press .
- 5 From the Fax area, press the **Options** button.
- 6 Press the arrow buttons until **Delayed Send** appears, and then press .
- Set Send Time** appears on the first line, and **HH:MM** with a blinking cursor appears on the second line.
- 7 Using the numeric keypad, enter the time you want to send the fax. After you enter the time, the cursor moves to the AM or PM field if the printer clock is set to **12 Hour** format. Press the arrow buttons to change from AM to PM or PM to AM.
- 8 Press .
- Set Send Date** appears on the first line, and **MM-DD-YYYY** with a blinking cursor appears on the second line.
- 9 Using the numeric keypad, enter the date you want to send the fax.
- 10 Press .
- 11 Press  to send a black only fax or  to send a color fax.



Viewing a fax log

- 1 Open a Web browser.
- 2 In the address bar, type the IP address of the printer, and then press **Enter**.

- 3 Click **Reports**.
- 4 Click **Fax Settings**.
- 5 Click **Fax Job Log** or **Fax Call Log**.

Canceling an outgoing fax

A fax can be canceled when the document is in the ADF or on the scanner glass. To cancel a fax:



- 1 From the printer control panel, press .
Stopping appears, and then **Cancel Job** appears.
- 2 Press  to cancel the job.
Note: If you want to continue to process the job, press  to resume scanning the fax.
Canceling appears.

The printer clears all pages in the ADF and then cancels the job.

Understanding fax options

Original Size

This option lets you choose the size of the documents you are going to fax.

- 1 From the Fax area of the printer control panel, press the **Options** button.
Original Size appears.
- 2 Press .
- 3 Press the arrow buttons until the size of the original document appears, and then press .

Content

This option tells the printer the original document type. Choose from Text, Text/Photo, or Photo. Content affects the quality and size of your scan.

- **Text**—Emphasizes sharp, black, high-resolution text against a clean, white background
- **Text/Photo**—Used when the original documents are a mixture of text and graphics or pictures
- **Photograph**—Tells the scanner to pay extra attention to graphics and pictures. This setting increases the time it takes to scan, but emphasizes a reproduction of the full dynamic range of tones in the original document. This increases the amount of information saved.

Sides (Duplex)

This option informs the printer if the original document is simplex (printed on one side) or duplex (printed on both sides). This lets the scanner know what needs to be scanned for inclusion in the fax.

Note: Duplex scanning is not available on selected printer models.

Resolution

This option increases how closely the scanner examines the document you want to fax. If you are faxing a photo, a drawing with fine lines, or a document with very small text, increase the Resolution setting. This will increase the amount of time required for the scan and will increase the quality of the fax output.

- **Standard**—Suitable for most documents
- **Fine**—Recommended for documents with small print
- **Super fine**—Recommended for original documents with fine detail
- **Ultra fine**—Recommended for documents with pictures or photos

Darkness

This option adjusts how light or dark your faxes will turn out in relation to the original document.

Improving fax quality

Question	Tip
When should I use Text mode?	<ul style="list-style-type: none">• Use Text mode when text preservation is the main goal of the fax, and preserving images copied from the original document is not a concern.• Text mode is recommended for faxing receipts, carbon copy forms, and documents that contain only text or fine line art.
When should I use Text/Photo mode?	<ul style="list-style-type: none">• Use Text/Photo mode when faxing an original document that contains a mixture of text and graphics.• Text/Photo mode is recommended for magazine articles, business graphics, and brochures.
When should I use Photo mode?	Use Photo mode when faxing photos printed on a laser printer or taken from a magazine or newspaper.

Holding and forwarding faxes

Holding faxes

This option lets you hold received faxes from printing until they are released. Held faxes can be released manually or at a scheduled day or time.

- 1 Type the printer IP address into the address field of your Web browser.

Note: If you do not know the IP address of the printer, then print a network setup page and locate the address in the TCP/IP section.

- 2 Click **Settings**.

- 3 Click **Fax Settings**.

- 4 Click **Analog Fax Setup**.

- 5 Click **Holding Faxes**.

- 6 Enter a password in the Print Faxes Password box.

- 7 In the Held Fax Mode box, click one of the following:
 - Off
 - Always On
 - Manual
 - Scheduled
- 8 If you selected Scheduled, continue with the following steps. Otherwise, go to step 9.
 - a Click **Fax Holding Schedule**.
 - b In the action box, click **Hold faxes**.
 - c In the time box, click the time you want the held faxes released.
 - d In the Day(s) box, click the day you want the held faxes released.
- 9 Click **Add**.

Forwarding a fax

This option lets you print and forward received faxes to a fax number.

- 1 Type the printer IP address into the address field of your Web browser.

Note: If you do not know the IP address of the printer, then print a network setup page and locate the address in the TCP/IP section.
- 2 Click **Settings**.
- 3 Click **Fax Settings**.
- 4 Click **Analog Fax Setup**.
- 5 Click inside the **Fax Forwarding** box, and then select one of the following:
 - Print
 - Print and Forward
 - Forward
- 6 From the **Forward to** list, select **Fax**.
- 7 Click inside the **Forward to Shortcut** box, and then enter the shortcut number where you want the fax forwarded.

Note: The shortcut number must be a valid shortcut number for the setting that was selected in the "Forward to" box.
- 8 Click **Submit**.

Scanning to a computer or USB flash memory device

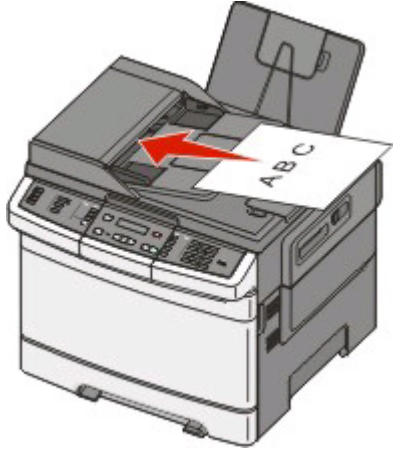
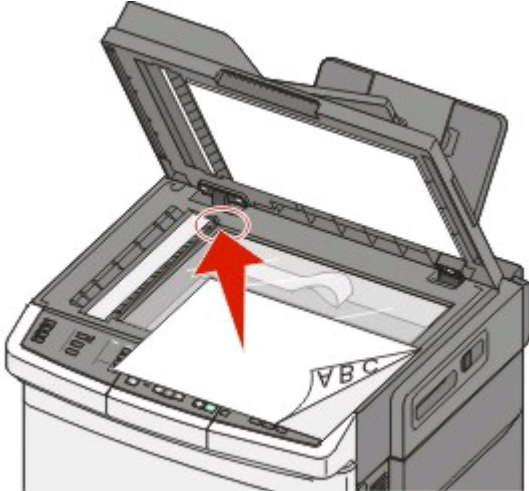
ADF	Scanner glass
 <p data-bbox="149 865 623 894">Use the ADF for multiple-page documents.</p>	 <p data-bbox="641 915 1440 1005">Use the scanner glass for single pages, small items (such as postcards or photos), transparencies, photo paper, or thin media (such as magazine clippings).</p>

The scanner lets you scan documents directly to a computer or a USB flash memory device. The computer does not have to be directly connected to the printer for you to receive Scan to PC images. You can scan the document back to the computer over the network by creating a scan profile on the computer and then downloading the profile to the printer.

Note: Scanning to a computer or USB device is not available on selected printer models.

Scanning to a computer

1 Type the printer IP address into the address field of your Web browser.

Note: If you do not know the IP address of the printer, then print a network setup page and locate the address in the TCP/IP section.

2 Click **Scan Profile**.

3 Click **Create Scan Profile**.

4 Select your scan settings, and then click **Next**.

5 Select a location on your computer where you want to save the scanned output file.

6 Enter a profile name.

The profile name is also the user name, it is the name that appears in the Scan Profile list on the display.

7 Click **Submit**.

8 Scan your document.

A shortcut number was automatically assigned when you clicked Submit. Remember this shortcut number and use it when you are ready to scan your documents.

a Load an original document faceup, short edge first into the ADF or facedown on the scanner glass.

Note: Do not load postcards, photos, small items, transparencies, photo paper, or thin media (such as magazine clippings) into the ADF. Place these items on the scanner glass.

b If you are loading a document into the ADF, then adjust the paper guides.



c Press the **Scan/Email** button.

d Press the arrow buttons until **Profiles** appears, and then press .

e Press .

Enter Shortcut: appears.

f Enter the shortcut number.

g Press  or  to send the scanned image.

Note: The scan settings determine if the image is sent in black or color. Pressing the black or color button does not change these settings.

9 Return to the computer to view the file.

The output file is saved in the location you specified or launched in the program you specified.

Scanning to a USB flash memory device

Note: The USB port is not available on selected printer models.

1 Insert a USB flash memory device into the front USB port.

Access USB appears.

Note: When a USB flash memory device is inserted into the printer, the printer can only scan to the USB device or print files from the USB device. All other printer functions are unavailable.

2 Press **1** on the keypad.

3 Press the arrow buttons until **Scan to USB** appears, and then press .

Press Start To Begin appears.

4 Load an original document faceup, short edge first into the ADF or facedown on the scanner glass.

Note: Do not load postcards, photos, small items, transparencies, photo paper, or thin media (such as magazine clippings) into the ADF. Place these items on the scanner glass.

5 If you are loading a document into the ADF, then adjust the paper guides.

6 Press  or  to send the scanned image.

Note: The scan settings determine if the image is sent in black or color. Pressing the black or color button does not change these settings.

Understanding scan to computer options

Sides (Duplex)

This option informs the printer if your original document is simplex (printed on one side) or duplex (printed on both sides). This lets the scanner know what needs to be scanned for inclusion in the document.

Note: Duplex scanning is not available on selected printer models.

Darkness

This option adjusts how light or dark your scanned documents will turn out in relation to the original document.

Improving scan quality

Question	Tip
When should I use Text mode?	<ul style="list-style-type: none">• Use Text mode when text preservation is the main goal of the scan, and preserving images copied from the original document is not a concern.• Text mode is recommended for receipts, carbon copy forms, and documents that only contain text or fine line art.
When should I use Text/Photo mode?	<ul style="list-style-type: none">• Use Text/Photo mode when scanning an original document that contains a mixture of text and graphics.• Text/Photo mode is recommended for magazine articles, business graphics, and brochures.
When should I use Photo mode?	Use Photo mode when scanning photos printed on a laser printer or taken from a magazine or newspaper.

Using the Scan Center software

Understanding the Scan Center features

The Scan Center software lets you modify scan settings and select where to send the scanned output. Scan settings modified with the Scan Center software can be saved and used for other scan jobs.

The following features are available:

- Scan and send images to your computer
- Convert scanned images to text
- Preview the scanned image and adjust the brightness and contrast
- Make larger scans without losing detail
- Scan two-sided documents





Using the ScanBack utility

Using the ScanBack Utility

You can use the Lexmark ScanBack™ Utility instead of the Embedded Web Server to create Scan to PC profiles. The ScanBack Utility is on the *Software and Documentation CD*.

- 1** Set up your Scan to PC profile.
 - a** Launch the ScanBack Utility.
 - b** Select the printer you want to use.

If no printers are listed, then see your system support person to obtain a list, or click the Setup button to manually search for an IP address or hostname.
 - c** Follow the instructions on the screens to define the type of document being scanned and what kind of output you want to create.
 - d** Make sure to select:
 - **Show MFP Instructions**—if you want to view or print the final directions
 - **Create Shortcut**—if you want to save this group of settings to use again
 - e** Click **Finish**.

A dialog box appears with your scan profile information and the status of the received images.
- 2** Scan your original documents.
 - a** Locate the printer you specified in the scan profile.
 - b** Load all pages in the ADF or on the scanner glass.
 - c** From the printer control panel, press **Scan/Email**.
 - d** Press the arrow buttons until **Profiles** appears, and then press .
 - e** Press the arrow buttons until your scan profile name appears, and then press .
 - f** Press  or  to send the scanned image.

Note: The scan settings determine if the image is sent in black or color. Pressing the black or color button does not change these settings.
 - g** Return to your computer.

Your output file is saved in a directory or launched in the application you specified.

Clearing jams

Avoiding jams

The following hints can help you avoid jams.

Paper tray recommendations

- Make sure the paper lies flat in the tray.
- Do not remove trays while the printer is printing.
- Do not load trays, the multipurpose feeder, or the envelope feeder while the printer is printing. Load them prior to printing, or wait for a prompt to load them.
- Do not load too much paper. Make sure the stack height does not exceed the indicated maximum height.
- Make sure the guides in the paper trays, multipurpose feeder, or envelope feeder are properly positioned and are not pressing too tightly against the paper or envelopes.
- Push all trays in firmly after loading paper.

Paper recommendations

- Use only recommended paper or specialty media. For more information, see “Paper types and weights supported by the printer” on page 49.
- Do not load wrinkled, creased, damp, bent, or curled paper.
- Flex, fan, and straighten paper before loading it.
- Do not use paper that has been cut or trimmed by hand.
- Do not mix paper sizes, weights, or types in the same stack.
- Make sure all sizes and types are set correctly in the printer control panel menus.
- Store paper per the manufacturer's recommendations.

Envelope recommendations

- To reduce wrinkling, use the Envelope Enhance menu in the Paper menu.
- Do not feed envelopes that:
 - Have excessive curl or twist
 - Have windows, holes, perforations, cutouts, or embossing
 - Have metal clasps, string ties, or folding bars
 - Have an interlocking design
 - Have postage stamps attached
 - Have any exposed adhesive when the flap is in the sealed or closed position
 - Have bent corners
 - Have rough, cockle, or laid finishes
 - Are stuck together or damaged in any way

Understanding jam numbers and locations

When a jam occurs, a message indicating the jam location appears. The following illustration and table list the paper jams that can occur and the location of each jam. Open doors and covers, and remove trays to access jam locations.

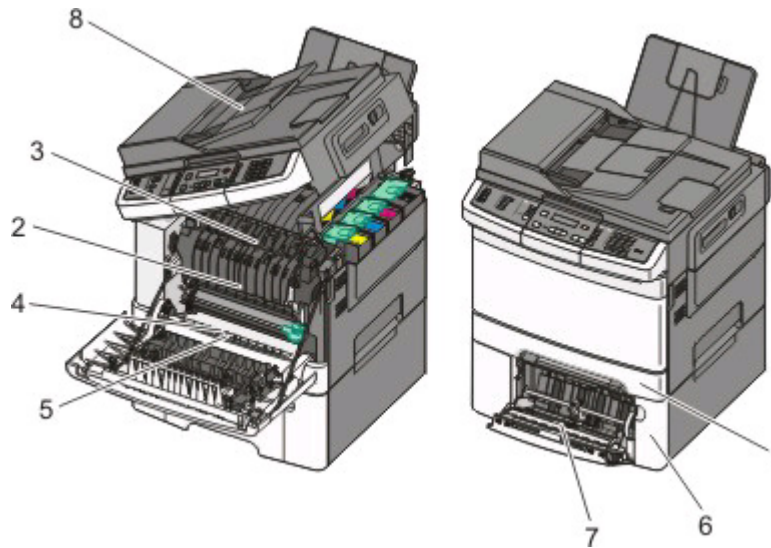

	Jam number	Jam location	Instructions
1	200	Standard 250-sheet tray and manual feeder (Tray 1)	1 Open the front door. Inspect the area behind the front door, and then remove any jams.
2	201	Under the fuser	2 Open the fuser cover. Inspect the area under the cover, and then remove any jams.
3	202	In the fuser	3 Close the front door.
4	230	In the duplex	4 Pull Tray 1 out. Inspect the tray area, and then remove any jams.
5	235	In the duplex Note: This jam number indicates that the paper being used for a duplex print job is not supported.	5 Verify that the paper is loaded correctly. 6 Reinsert Tray 1.
6	242	550-sheet tray (Tray 2)	Pull Tray 1 out. Inspect the tray area, and then remove any jams.
7	250	In the multipurpose feeder	1 Inspect the multipurpose feeder, and then remove any jams 2 Reinsert Tray 1.
8	290	ADF	Open the ADF cover, and then remove the jam.

200 paper jam

- 1 Grasp the handle, and pull the standard 250-sheet tray (Tray 1) and manual feeder out.

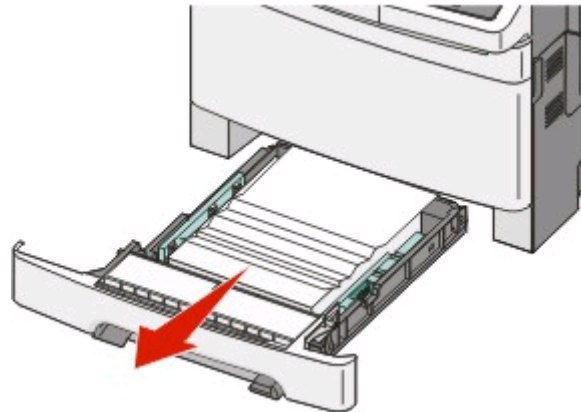

- 2 Remove the jam.

Note: Make sure all paper fragments are removed.

- 3 Insert the tray.

- 4 Press .

201 paper jam

- 1 Grasp the front door at the side handholds, and then pull it toward you to open it.

 **CAUTION—HOT SURFACE:** The inside of the printer might be hot. To reduce the risk of injury from a hot component, allow the surface to cool before touching.

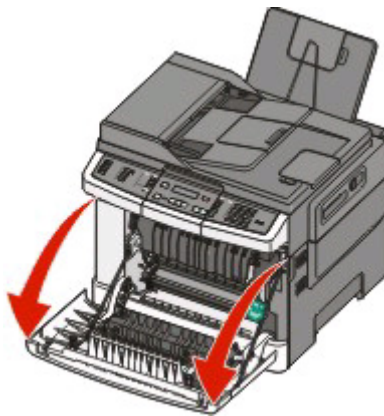

2 Remove the jammed paper.

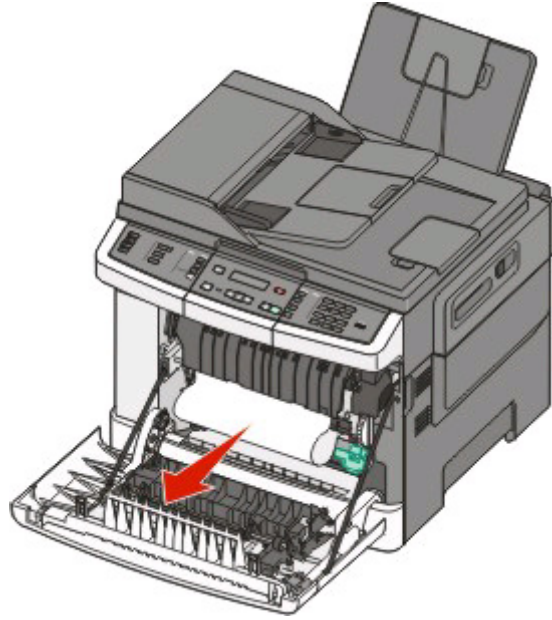

Notes:

- Make sure all paper fragments are removed.
- There may be a second sheet jammed if 200.xx Paper Jam and 202.xx Paper Jam appear.

3 Close the front door.

4 Press .

202 paper jam

1 Grasp the front door at the side handholds, and then pull it toward you to open it.

 **CAUTION—HOT SURFACE:** The inside of the printer might be hot. To reduce the risk of injury from a hot component, allow the surface to cool before touching.

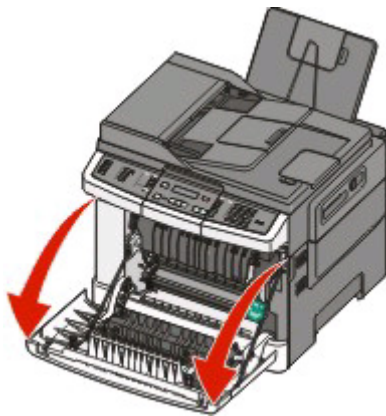

2 Grasp the green lever, and then pull the fuser cover toward you.

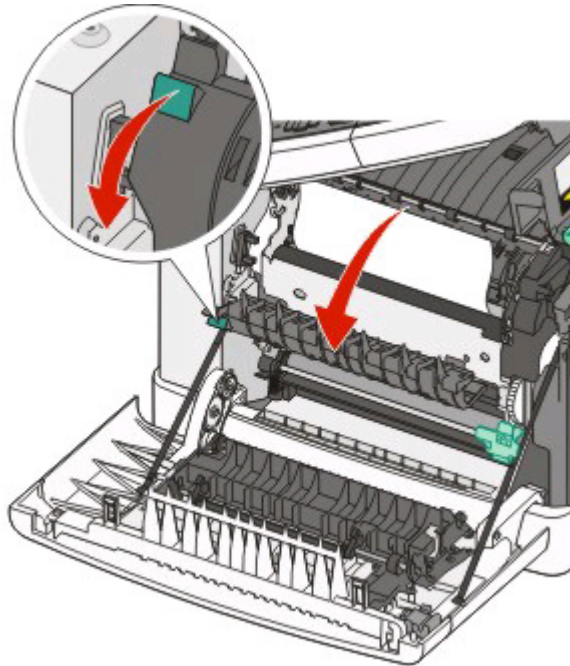

3 Hold the fuser cover down, and then remove the jammed paper.
The fuser cover closes when released.

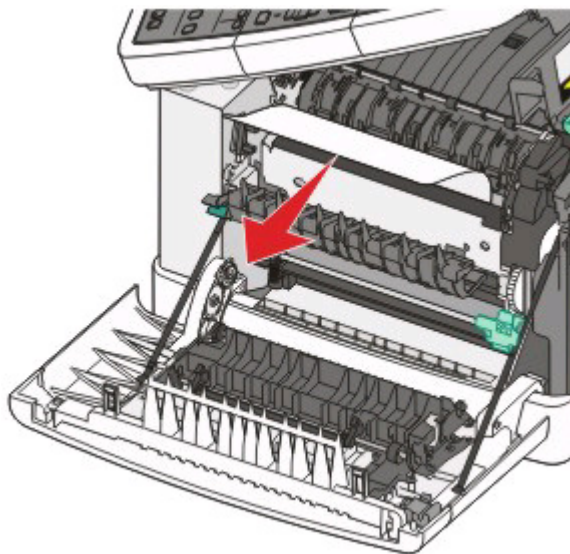

Note: Make sure all paper fragments are removed.

4 Close the front door.

5 Press .

230 paper jam

- 1 Grasp the front door at the side handholds, and then pull it toward you to open it.
- 2 Remove the jam.
- 3 Press .

235 paper jam

This jam occurs when the paper is too short for the duplex unit.

- 1 Grasp the front door at the side handholds, and then pull it toward you to open it.
- 2 Remove the jam.
- 3 Load the tray with the correct paper size (A4, letter, legal, folio).
- 4 Insert the tray.
- 5 Close the front door.
- 6 Press .

242 paper jam

- 1 Grasp the handle, and pull the optional 650-sheet duo drawer out.

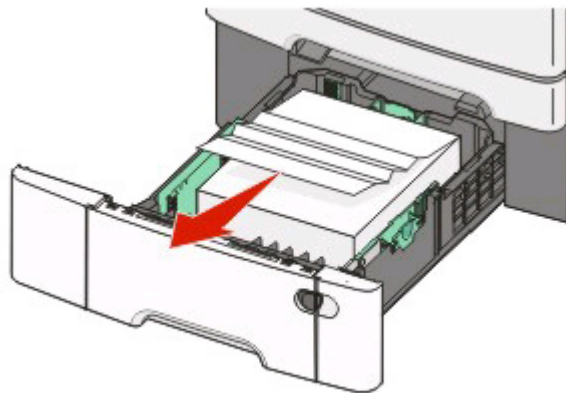

- 2 If a paper jam is in the multipurpose feeder, push the lever.
- 3 Remove the jam.
Note: Make sure all paper fragments are removed.
- 4 Insert the tray.
- 5 Press .

250 paper jam

- 1 Push the lever in the multipurpose feeder to access the paper jammed.

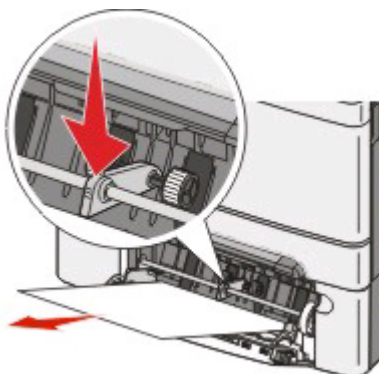

- 2 Remove the jam.

Note: Make sure all paper fragments are removed.

- 3 Insert the tray.

- 4 Press .

290 paper jam

- 1 Remove all original documents from the ADF.
- 2 Open the ADF cover, and then remove any jammed paper.

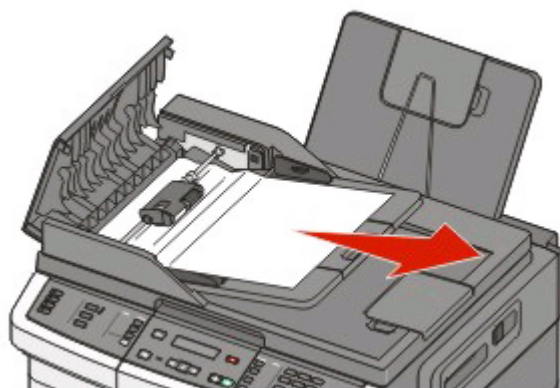

- 3 Close the ADF cover.

4 Open the scanner cover, and then remove any jammed pages.

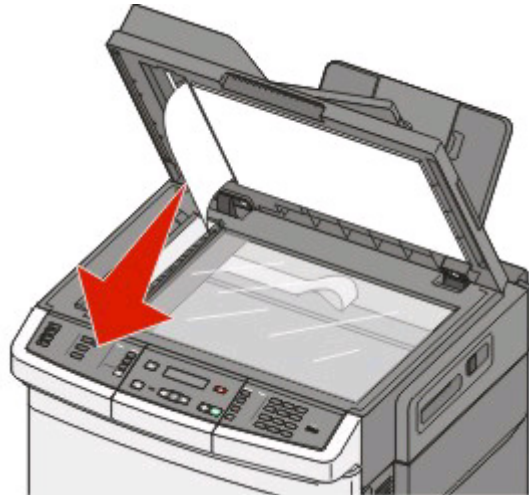

5 Close the scanner cover.

6 Press .

Understanding printer menus

Menus list

A number of menus are available to make it easy for you to change printer settings: These menus can be accessed from the printer control panel, Embedded Web Server, or the software application driver.

Notes:

- Certain menus are not available on selected printer models.
- A setting with an * indicates it is the current default setting.

Note:

Supplies Menu	Paper Menu	Reports	Network/Ports
Cyan Cartridge	Default Source	Menu Settings Page	Active NIC
Magenta Cartridge	Size/Type	Device Statistics	Network Menu
Yellow Cartridge	Paper Texture	Network Setup Page	Wireless Menu
Black Cartridge	Paper Weight	Wireless Setup Page	USB Menu
Imaging Kit	Paper Loading	Shortcut List	
Waste Toner Bottle	Custom Type	Fax Job Log	
	Custom Scan Sizes	Fax Call Log	
	Universal Setup	Copy Shortcuts	
		E-mail Shortcuts	
		Fax Shortcuts	
		Profiles List	
		Print Fonts	
		Print Directory	
		Print Defects	
		Print Demo	
		Asset Report	

Settings

General Settings
Copy Settings
Fax Settings
Flash Drive Menu
Print Settings
Set Date/Time

Supplies menu

Menu item	Description
Cyan, Magenta, Yellow, or Black Toner Cartridges Early Warning Low Invalid Replace Missing or Defective OK Unsupported	Shows the status of the toner cartridges Note: 88 Replace <color> Cartridge indicates the cartridge is nearly empty, and print quality problems may result.
Imaging Kit OK Replace Black Imaging Kit Replace Black and Color Imaging Kit	Shows the status of the imaging kit
Waste Toner Box Near Full Replace Missing OK	Shows the status of the waste toner bottle

Paper menu

Default Source menu

Menu item	Description
Default Source Tray <x> MP Feeder Manual Paper Manual Env	Sets a default paper source for all print jobs Notes: <ul style="list-style-type: none"> • The 650-sheet-duo drawer must be installed in order for MP Feeder or Tray 2 to appear as a menu setting in the Paper Menu. • Tray 1 (standard tray) is the factory default setting. • Only an installed paper source will appear as a menu setting. • A paper source selected by a print job will override the Default Source setting for the duration of the print job. • If the same size and type of paper are in two trays and the Paper Size and Paper Type settings match, the trays are automatically linked. When one tray is empty, the job prints using the linked tray.

Size/Type menu

Menu item	Description
Tray <x> Size Letter Legal Executive Oficio (Mexico) Folio Universal A4 A5 JIS B5	Specifies the paper size loaded in each tray Notes: <ul style="list-style-type: none"> • Letter is the US factory default setting. A4 is the international factory default setting. • If the same size and type of paper are in two trays and the Paper Size and Paper Type settings match, the trays are automatically linked. When one tray is empty, the job prints using paper from the linked tray.
Tray <x> Type Plain Paper Card Stock Transparency Recycled Glossy Labels Bond Letterhead Preprinted Colored Paper Light Paper Heavy Paper Rough/Cotton Custom Type <x>	Specifies the type of paper loaded in each tray Notes: <ul style="list-style-type: none"> • Plain Paper is the factory default setting for Tray 1. Custom Type <x> is the factory default setting for all other trays. • If available, a user-defined name will appear instead of Custom Type <x>. • Use this menu item to configure automatic tray linking.
Manual Paper Size Letter Legal Executive Oficio (Mexico) Folio Statement Universal A4 A5 A5 JIS B5	Specifies the size of the paper being manually loaded Note: Letter is the US factory default setting. A4 is the international factory default setting.
Note: Only installed trays and feeders are listed in this menu.	

Menu item	Description
<p>Manual Paper Type</p> <ul style="list-style-type: none"> Plain Paper Card Stock Transparency Recycled Glossy Labels Bond Letterhead Preprinted Colored Paper Light Paper Heavy Paper Rough/Cotton Custom Type <x> 	<p>Specifies the type of paper being manually loaded</p> <p>Note: Plain Paper is the factory default setting.</p>
<p>MP Feeder Size</p> <ul style="list-style-type: none"> Letter Legal Executive Oficio (Mexico) Folio Statement Universal A4 A5 A5 JIS B5 	<p>Specifies the paper size loaded in the multipurpose feeder</p> <p>Notes:</p> <ul style="list-style-type: none"> • From the Paper menu, Configure MP must be set to Cassette in order for MP Feeder to appear as a menu setting. • Letter is the U.S. factory default setting. A4 is the international factory default setting. • The multipurpose feeder does not automatically sense paper size. The paper size value must be set.
<p>MP Feeder Type</p> <ul style="list-style-type: none"> Plain Paper Card Stock Transparency Recycled Glossy Labels Bond Letterhead Preprinted Colored Paper Light Paper Heavy Paper Rough/Cotton Custom Type <x> 	<p>Specifies the type of paper loaded in the multipurpose feeder.</p> <p>Notes:</p> <ul style="list-style-type: none"> • From the Paper menu, Configure MP must be set to Cassette in order for MP Feeder to appear as a menu setting. • Letter is the U.S. factory default setting. A4 is the international factory default setting.
<p>Note: Only installed trays and feeders are listed in this menu.</p>	

Menu item	Description
Manual Envelope Size 10 Envelope DL Envelope C5 Envelope B5 Envelope Other Envelope 7 3/4 Envelope 9 Envelope	Specifies the size of the envelope being manually loaded Note: 10 Envelope is the US factory default setting. DL Envelope is the international factory default setting.
Manual Envelope Type Envelope Custom Type <x>	Specifies the type of envelope being manually loaded Note: Envelope is the factory default setting.
Note: Only installed trays and feeders are listed in this menu.	

Paper Texture menu

Menu item	Description
Plain Texture Smooth Normal Rough	Specifies the relative texture of the paper loaded in a specific tray Note: Normal is the factory default setting.
Card Stock Texture Smooth Normal Rough	Specifies the relative texture of the card stock loaded in a specific tray Notes: <ul style="list-style-type: none"> • Normal is the factory default setting. • Settings appear only if card stock is supported.
Transparency Texture Smooth Normal Rough	Specifies the relative texture of the transparencies loaded in a specific tray Note: Normal is the factory default setting.
Recycled Texture Smooth Normal Rough	Specifies the relative texture of the recycled paper loaded in a specific tray Note: Normal is the factory default setting.
Glossy Texture Smooth Normal Rough	Specifies the relative texture of the Glossy paper loaded in a specific tray Note: Normal is the factory default setting.
Labels Texture Smooth Normal Rough	Specifies the relative texture of the labels loaded in a specific tray Note: Normal is the factory default setting.

Menu item	Description
Bond Texture Smooth Normal Rough	Specifies the relative texture of the paper loaded in a specific tray Note: Rough is the factory default setting.
Envelope Texture Smooth Normal Rough	Specifies the relative texture of the envelopes loaded in a specific tray Note: Normal is the factory default setting.
Letterhead Texture Smooth Normal Rough	Specifies the relative texture of the paper loaded in a specific tray Note: Normal is the factory default setting.
Preprinted Texture Smooth Normal Rough	Specifies the relative texture of the paper loaded in a specific tray Note: Normal is the factory default setting.
Colored Texture Smooth Normal Rough	Specifies the relative texture of the colored paper loaded in a specific tray Note: Normal is the factory default setting.
Light Paper Smooth Normal Rough	Specifies the relative texture of the light paper loaded in a specific tray Notes: <ul style="list-style-type: none"> • Normal is the factory default setting. • Settings appear only if the custom type is supported.
Heavy Paper Smooth Normal Rough	Specifies the relative texture of the heavy paper loaded in a specific tray Notes: <ul style="list-style-type: none"> • Normal is the factory default setting. • Settings appear only if the custom type is supported.
Rough/Cotton Paper Rough	Specifies the relative texture of the rough/cotton paper loaded in a specific tray Notes: <ul style="list-style-type: none"> • Rough is the factory default setting. • Settings appear only if the custom type is supported.
Custom <x> Paper Smooth Normal Rough	Specifies the relative texture of the custom paper loaded in a specific tray Notes: <ul style="list-style-type: none"> • Normal is the factory default setting. • Settings appear only if the custom type is supported.

Paper Weight menu

Menu items	Definition
Plain Weight, Glossy Weight, Bond Weight, Letterhead Weight, Preprinted Weight, or Colored Weight Light Normal Heavy	Identifies the relative weight of the paper loaded in a specific tray Note: Normal is the factory default setting.
Transparency Weight Light Normal Heavy	Identifies the relative weight of the transparencies loaded in a specific tray Note: Normal is the factory default setting.
Recycled Weight Light Normal Heavy	Identifies the relative weight of the recycled paper loaded in a specific tray Note: Normal is the factory default setting.
Labels Weight Light Normal Heavy	Identifies the relative weight of the labels loaded in a specific tray Note: Normal is the factory default setting.
Envelope Weight Light Normal Heavy	Identifies the relative weight of the envelopes loaded in a specific tray or feeder Note: Normal is the factory default setting.
Card Stock Weight Light Normal Heavy	Identifies the relative weight of the card stock loaded in a specific tray Notes: <ul style="list-style-type: none"> • Normal is the factory default setting. • Settings appear only if card stock is supported.
Light Paper Weight Light	Identifies the relative weight of the light paper loaded in a specific tray Notes: <ul style="list-style-type: none"> • Light is the factory default setting. • Settings appear only if light paper is supported.
Heavy Paper Weight Heavy	Identifies the relative weight of the heavy paper loaded in a specific tray Notes: <ul style="list-style-type: none"> • Heavy is the factory default setting. • Settings appear only if heavy paper is supported.

Menu items	Definition
Rough/Cotton Paper Weight Normal	Identifies the relative weight of the rough/cotton paper loaded in a specific tray Notes: <ul style="list-style-type: none"> • Normal is the factory default setting. • Settings appear only if rough/cotton paper is supported.
Custom <x> Light Normal Heavy	Identifies the relative weight of the custom paper type loaded in a specific tray Notes: <ul style="list-style-type: none"> • Normal is the factory default setting. • Settings appear only if custom paper is supported.

Paper Loading menu

Note: Certain options are not available on selected printer models.

Menu item	Description
Recycled Loading Duplex Off	Determines whether 2-sided printing occurs for all jobs that specify Recycled as the paper type Note: Off is the factory default setting.
Glossy Loading Duplex Off	Determines whether 2-sided printing occurs for all jobs that specify Glossy as the paper type Note: Off is the factory default setting.
Bond Loading Duplex Off	Determines whether 2-sided printing occurs for all jobs that specify Bond as the paper type Note: Off is the factory default setting.
Letterhead Loading Duplex Off	Determines whether 2-sided printing occurs for all jobs that specify Letterhead as the paper type Note: Off is the factory default setting.
Preprinted Loading Duplex Off	Determines whether 2-sided printing occurs for all jobs that specify Preprinted as the paper type Note: Off is the factory default setting.
Colored Loading Duplex Off	Determines whether 2-sided printing occurs for all jobs that specify Colored as the paper type Note: Off is the factory default setting.
Light Paper Loading Duplex Off	Determines whether 2-sided printing occurs for all jobs that specify Light Paper as the paper type Note: Off is the factory default setting.
Note: Duplex sets the printer default to 2-sided printing for every print job unless 1-sided printing is selected from Print Properties (in Windows) or the Print dialog (in Macintosh).	

Menu item	Description
Heavy Paper Loading Duplex Off	Determines whether 2-sided printing occurs for all jobs that specify Heavy Paper as the paper type Note: Off is the factory default setting.
Rough/Cotton Loading Duplex Off	Determines whether 2-sided printing occurs for all jobs that specify Rough/Cotton as the paper type Note: Off is the factory default setting.
Custom <x> Loading Duplex Off	Determines whether 2-sided printing occurs for all jobs that specify Custom <x> as the paper type Notes: <ul style="list-style-type: none"> • Off is the factory default setting. • Custom <x> Loading is available only if the custom type is supported.
Note: Duplex sets the printer default to 2-sided printing for every print job unless 1-sided printing is selected from Print Properties (in Windows) or the Print dialog (in Macintosh).	

Custom Types menu

Menu item	Description
Custom Type <x> Paper Card Stock Transparency Glossy Labels Envelope Rough/Cotton	Associates a paper or specialty media type with a factory default Custom Type <x> name or a user-defined Custom Name created from the Embedded Web Server or MarkVision™ Professional. This user-defined name displays instead of Custom Type <x> . Notes: <ul style="list-style-type: none"> • Paper is the factory default setting. • The custom media type must be supported by the selected tray or feeder in order for you to print from that source.
Recycled Paper Card Stock Transparency Glossy Labels Envelope Cotton	Specifies a paper type when the Recycled setting is selected in other menus Notes: <ul style="list-style-type: none"> • Paper is the factory default setting. • The Recycled type must be supported by the selected tray or feeder in order for you to print from that source.

Custom Scan Sizes menu

Menu item	Description
ID Card Width 1–14 inches (25–355.6 mm) Height 1–14 inches (25–355.6 mm) Orientation Landscape Portrait 2 scans per side Off On	Specifies a non-standard scan size. Notes: <ul style="list-style-type: none"> • 4.83 inches is the US factory default setting for Width. 123 millimeters is the international factory default setting for Width. • 6.32 inches is the US factory default setting for Height. 161 millimeters is the international factory default setting for Height. • Landscape is the factory default setting for Orientation. • On is the factory default setting for 2 scans per side.
Custom Scan Size <x> Scan Size Name Width 1–14 inches (25–355.6 mm) Height 1–14 inches (25–355.6 mm) Orientation Landscape Portrait 2 scans per side Off On	Specifies a custom scan size name and options. This name replaces a Custom Scan Size <x> name in the printer menus. Notes: <ul style="list-style-type: none"> • 8.5 inches is the US factory default setting for Width. 216 millimeters is the international factory default setting for Width. • 14 inches is the US factory default setting for Height. 356 millimeters is the international factory default setting for Height. • Landscape is the factory default setting for Orientation. • Off is the factory default setting for 2 scans per side.

Universal Setup menu

These menu items are used to specify the height and width of the Universal Paper Size. The Universal Paper Size is a user-defined paper size setting. It is listed with the other paper size settings and includes similar options, such as support for duplex printing and printing multiple pages on one sheet.

Menu item	Description
Units of Measure Inches Millimeters	Identifies the units of measure Notes: <ul style="list-style-type: none"> • Inches is the US factory default setting. • Millimeters is the international factory default setting.

Menu item	Description
Portrait Width 3–14.7 inches 76–360 mm	Sets the portrait width Notes: <ul style="list-style-type: none"> • If the width exceeds the maximum, the printer uses the maximum width allowed. • 8.5 inches is the US factory default setting. Inches can be increased in 0.01-inch increments. • 216 mm is the international factory default setting. Millimeters can be increased in 1-mm increments.
Portrait Height 3–14.7 inches 76–360 mm	Sets the portrait height Notes: <ul style="list-style-type: none"> • If the height exceeds the maximum, the printer uses the maximum height allowed. • 14 inches is the US factory default setting. Inches can be increased in 0.01-inch increments. • 356 mm is the international factory default setting. Millimeters can be increased in 1-mm increments.

Reports menu

Reports menu

Note: When you select a menu item from the Reports menu, the indicated report prints.

Menu item	Description
Menu Settings Page	Prints a report containing information about paper loaded into trays, installed memory, the total page count, alarms, timeouts, the printer control panel language, the TCP/IP address, the status of supplies, the status of the network connection, and other information
Device Statistics	Prints a report containing printer statistics such as supply information and details about printed pages
Network Setup Page	Prints a report containing information about the network printer settings, such as the TCP/IP address information Note: This menu item appears only for network printers or printers connected to print servers.
Shortcut List	Prints a report containing information about configured shortcuts
Fax Job Log	Prints a report containing information about the last 200 completed faxes
Fax Call Log	Prints a report containing information about the last 100 attempted, received, and blocked calls
Copy Shortcuts	Prints a report containing information about copy shortcuts
E-mail Shortcuts	Prints a report containing information about e-mail shortcuts
Fax Shortcuts	Prints a report containing information about fax shortcuts

Menu item	Description
Profiles List	Prints a list of profiles stored in the printer
Print Fonts	Prints a report of all the fonts available for the printer language currently set in the printer
Print Defects	Prints a repeating defects page used as a diagnostic tool for identifying print problems Note: Should be printed on letter- or A4-size paper. If printed on smaller paper, the content will be clipped.
Print Demo	Prints a resident demonstration page
Asset Report	Prints a report containing asset information including the printer serial number and model name. The report contains text and UPC barcodes that can be scanned into an asset database.

Network/Ports

Active NIC menu

Menu item	Description
Active NIC Auto List of networks	Shows the print server Note: This menu is available only for network models or printers attached to print servers.

Network menu

Menu item	Description
PCL SmartSwitch On Off	Sets the printer to automatically switch to PCL emulation when a print job requires it, regardless of the default printer language Notes: <ul style="list-style-type: none"> • On is the factory default setting. • When the Off setting is used, the printer does not examine incoming data. • When the Off setting is used, the printer uses PostScript emulation if PS SmartSwitch is set to On. It uses the default printer language specified in the Setup menu if PS SmartSwitch is set to Off.
PS SmartSwitch On Off	Sets the printer to automatically switch to PS emulation when a print job requires it, regardless of the default printer language Notes: <ul style="list-style-type: none"> • On is the factory default setting. • When the Off setting is used, the printer does not examine incoming data. • When the Off setting is used, the printer uses PCL emulation if PCL SmartSwitch is set to On. It uses the default printer language specified in the Setup menu if PCL SmartSwitch is set to Off.

Menu item	Description
NPA Mode Off Auto	Sets the printer to perform the special processing required for bidirectional communication following the conventions defined by the NPA protocol Notes: <ul style="list-style-type: none"> • Auto is the factory default setting • Changing this setting from the printer control panel and then exiting the menus causes the printer to restart. The menu selection is updated.
Network Buffer Disabled Auto	Sets the size of the network input buffer Notes: <ul style="list-style-type: none"> • Auto is the factory default setting. • The value can be changed in 1-K increments. • The maximum size allowed depends on the amount of memory in the printer, the size of the other link buffers, and whether Resource Save is set to On or Off. • To increase the maximum size range for the Network Buffer, disable or reduce the size of the USB buffer. • Changing this setting from the printer control panel and then exiting the menus causes the printer to restart. The menu selection is updated.
Mac Binary PS On Off Auto	Sets the printer to process Macintosh binary PostScript print jobs Notes: <ul style="list-style-type: none"> • Auto is the factory default setting. • The Off setting filters print jobs using the standard protocol. • The On setting processes raw binary PostScript print jobs.
Network Setup Reports Menu Network Card menu TCIP Menu IPv6 Menu Wireless menu AppleTalk menu	Lists all the network setup menus, regardless of the active network of the printer Note: Certain options are not available on selected printer models.

Wireless menu

Use the following menu items to view or configure the wireless internal print server settings.

Note: This menu is available only for network models or printers attached to print servers when an optional wireless internal print server is installed in the printer.

Menu item	Description
Mode Infrastructure Ad hoc	Lets you select a mode Notes: <ul style="list-style-type: none"> Infrastructure mode makes the printer wireless network accessible through an access point. Ad hoc mode configures the printer for peer-to-peer wireless networking.
Compatibility 802.11n 802.11b/g 802.11b/g/n	Lets you select a setting that is compatible with your equipment
Choose Network <list of available network names>	Lets you select an available network for the printer to use
View Signal Quality	Lets you view the strength of the wireless connection
View Security Mode	Lets you view the security of the wireless connection

USB menu

Menu item	Description
PCL SmartSwitch On Off	Sets the printer to automatically switch to PCL emulation when a print job requires it, regardless of the default printer language Notes: <ul style="list-style-type: none"> On is the factory default setting. When the Off setting is used, the printer does not examine incoming data. When the Off setting is used, the printer uses PostScript emulation if PS SmartSwitch is set to On. It uses the default printer language specified in the Setup menu if PS SmartSwitch is set to Off.
PS SmartSwitch On Off	Sets the printer to automatically switch to PS emulation when a print job requires it, regardless of the default printer language Notes: <ul style="list-style-type: none"> On is the factory default setting. When the Off setting is used, the printer does not examine incoming data. When the Off setting is used, the printer uses PCL emulation if PCL SmartSwitch is set to On. It uses the default printer language specified in the Setup menu if PCL SmartSwitch is set to Off.
NPA Mode Off Auto	Sets the printer to perform the special processing required for bidirectional communication following the conventions defined by the NPA protocol Notes: <ul style="list-style-type: none"> Auto is the factory default setting. Changing this setting from the printer control panel and then exiting the menus causes the printer to restart. The menu selection is updated.

Menu item	Description
USB Buffer Disabled Auto	Sets the size of the USB input buffer Notes: <ul style="list-style-type: none"> • Auto is the factory default setting. • Changing this setting from the printer control panel and then exiting the menus causes the printer to restart. The menu selection is updated.
Mac Binary PS On Off Auto	Sets the printer to process Macintosh binary PostScript print jobs Notes: <ul style="list-style-type: none"> • Auto is the factory default setting. • The Off setting filters print jobs using the standard protocol. • The On setting processes raw binary PostScript print jobs.
ENA Address	Sets the network address information for an external print server that is attached to the printer using a USB cable Note: This menu item is available only if the printer is attached to an external printer server through the USB port.
ENA Netmask	Sets the netmask information for an external print server that is attached to the printer using a USB cable Note: This menu item is available only if the printer is attached to an external print server through the USB port.
ENA Gateway	Sets the gateway information for an external print server that is attached to the printer using a USB cable Note: This menu item is available only if the printer is attached to an external print server through the USB port.

Settings menu

General Settings menu

Menu item	Description
Display Language English Francais Deutsch Italiano Espanol Dansk Norsk Nederlands Svenska Portuguese Suomi Russian Polski Magyar Turkce Cesky Simplified Chinese Traditional Chinese Korean Japanese	Sets the language of the text appearing on the display Note: All languages may not be available for all printers.
Eco-Mode Off Energy Energy/Paper Paper	Minimizes the use of energy, paper, or specialty media Notes: <ul style="list-style-type: none">• Off is the factory default setting. Off resets the printer to its factory default settings.• The Energy setting minimizes the power used by the printer. Performance may be affected but quality is not.• Paper minimizes the amount of paper and specialty media needed for a print job. Performance may be affected but quality is not.• Energy/Paper minimizes the use of power and of paper and specialty media.
Quiet Mode Off On	Reduces the amount of noise produced by the printer Notes: <ul style="list-style-type: none">• Off is the factory default setting.• On configures the printer to produce as little noise as possible.

Menu item	Description
Run Initial setup Yes No	Instructs the printer to run the setup wizard Notes: <ul style="list-style-type: none"> • Yes is the factory default setting. • After completing the setup wizard by selecting Done at the Country select screen, the default setting becomes No.
Paper Sizes U.S. Metric	Specifies the printer factory default measurements. The default setting is determined by the country selection in the initial setup wizard.
Scan to PC Port Range <port range>	Specifies a valid port range for printers behind a port blocking firewall. The valid ports are specified by two sets of numbers separated by a semicolon. Note: 9751:12000 is the factory default setting.
Default Mode Copy Fax	Sets the function the printer enters when Go, Content, Darkness, or any number is pressed on the printer control panel Note: Copy is the factory default setting
Date Format MM-DD-YYYY DD-MM-YYYY YYYY-MM-DD	Formats the printer date Note: MM-DD-YYYY is the US factory default setting and DD-MM-YYYY is the international factory default setting.
Time Format 12 hour A.M./P.M. 24 hour clock	Formats the printer time Note: The factory default setting is 12 hour A.M./P.M.
Alarms Alarm Control Cartridge Alarm	Sets an alarm to sound when the printer requires operator intervention. Available selections for each alarm type are: Off Single Continuous Notes: <ul style="list-style-type: none"> • Single is the factory default setting for Alarm Control. Single sounds three quick beeps. • Off means no alarm will sound. • Continuous repeats three beeps every 10 seconds.
Timeouts Power Saver Disabled 1–240	Specifies the number of minutes of inactivity before some systems begin entering a minimum power state. Note: 30 minutes is the factory default setting.
Timeouts Screen Timeout 15–300	Sets the amount of time in seconds the printer waits before returning the printer display to a Ready state Note: 30 seconds is the factory default setting.

Menu item	Description
Timeouts Print Timeout Disabled 1–255	Sets the amount of time in seconds the printer waits to receive an end-of-job message before canceling the remainder of the print job Notes: <ul style="list-style-type: none"> • 90 seconds is the factory default setting. • When the timer expires, any partially printed page still in the printer is printed, and then the printer checks to see if any new print jobs are waiting. • Print Timeout is available only when using PCL or PPDS emulation. This setting has no effect on PostScript emulation print jobs.
Timeouts Wait Timeout Disabled 15–65535	Sets the amount of time in seconds the printer waits for additional data before canceling a print job Notes: <ul style="list-style-type: none"> • 40 seconds is the factory default setting. • Wait Timeout is available only when the printer is using PostScript emulation. This setting has no effect on PCL or PPDS emulation print jobs.
Print Recovery Auto Continue Disabled 5–255	Lets the printer automatically continue printing from certain offline situations when not resolved within the specified time period Notes: <ul style="list-style-type: none"> • Disabled is the factory default setting. • 5–255 is a range of time in seconds.
Print Recovery Jam Recovery On Off Auto	Specifies whether the printer reprints jammed pages Notes: <ul style="list-style-type: none"> • Auto is the factory default setting. The printer reprints jammed pages unless the memory required to hold the pages is needed for other printer tasks. • On sets the printer to always reprint jammed pages. • Off sets the printer to never reprint jammed pages.
Print Recovery Page Protect On Off	Lets the printer successfully print a page that may not have printed otherwise Notes: <ul style="list-style-type: none"> • Off is the factory default setting. Off prints a partial page when there is not enough memory to print the whole page. • On sets the printer to process the whole page so that the entire page prints.

Menu item	Description
Factory Defaults Do Not Restore Restore Now	Returns the printer settings to the factory default settings Notes: <ul style="list-style-type: none"> • Do Not Restore is the factory default setting. Do Not Restore keeps the user-defined settings. • Restore returns all printer settings to the factory default settings except Network/Ports menu settings. All downloads stored in RAM are deleted.

Copy Settings menu

Menu item	Description
Content Text Text/Photo Photograph	Specifies the type of content contained in the copy job Notes: <ul style="list-style-type: none"> • Text emphasizes sharp, black, high-resolution text against a clean, white background. • Text/Photo is the factory default setting. Text/Photo is used when the original documents are a mixture of text and graphics or pictures. • Photograph tells the scanner to pay extra attention to graphics and pictures. This setting increases the time it takes to scan, but emphasizes a reproduction of the full dynamic range of tones in the original document. This increases the amount of information saved.
Sides (Duplex) 1 sided to 1 sided 1 sided to 2 sided 2 sided to 1 sided 2 sided to 2 sided	Specifies whether an original document is duplex (two-sided) or simplex (one-sided), and then specifies whether the copy should be duplex or simplex Notes: <ul style="list-style-type: none"> • Duplex is not available on selected models. • 1 sided to 1 sided—The original page has printing on one side. The copied page will have printing on one side. • 1 sided to 2 sided—The original page has printing on one side. The copied page will have printing on both sides. For example, if the original is six sheets, the copy is three sheets with printing on both sides. • 2 sided to 1 sided—The original page has printing on both sides. The copied page will have printing on only one side. For example, if the original draft is three sheets of paper with an image on each side of each sheet, then the copy is six sheets with only one image on one side of each sheet. • 2 sided to 2 sided—The original page has printing on both sides. The copy mimics the original exactly.
Paper Saver Off 2 on 1 Portrait 2 on 1 Landscape 4 on 1 Portrait 4 on 1 Landscape	Sets two or four sheets of an original document together on the same page Note: Off is the factory default setting.

Menu item	Description
Print Page Borders On Off	Specifies whether a border is printed around the edge of the page at the margins Note: Off is the factory default setting.
Collate On Off	Keeps the pages of a print job stacked in sequence when making multiple copies of the job Note: On is the factory default setting.
Original Size Letter Legal Executive Folio Statement Universal ID Card 4 x 6 in. 3 x 5 in. Business Card Custom Scan Size <x> A4 A5 Oficio (Mexico) A6 JIS B5	Specifies the paper size of the original document Notes: <ul style="list-style-type: none"> • Letter is the US factory default setting. A4 is the international factory default setting. • A setting with an * indicates it is the current default setting.
Paper Source Tray <x> Single Sheet Feeder Multi Sheet Feeder	Specifies the paper source for copy jobs Note: Tray 1 is the factory default setting.
Transparency Separators On Off	Places a sheet of paper between transparencies Note: On is the factory default setting.
Separator Sheets None Between Copies Between Jobs Between Pages	Places a sheet of paper between pages, copies, or jobs based on the value selected Note: None is the factory default setting.
Separator Source Tray <x> Manual Feeder	Specifies a paper source Note: Tray 1 is the factory default setting.
Darkness -4 to +4	Specifies the level of darkness for the copy job Note: The factory default setting is 0.
Number of Copies 1–999	Specifies the number of copies for the copy job Note: The factory default setting is 1.

Menu item	Description
Overlay Off Confidential Copy Draft Urgent Custom	Specifies overlay text that is printed on each page of the copy job Note: Off is the factory default setting.
Allow priority copies On Off	Allows interruption of a print job to copy a page or document Note: On is the factory default setting.
Background Removal -4 to +4	Adjusts the amount of background visible on a copy Note: The factory default setting is 0.
Color Balance Cyan-Red Magenta-Green Yellow-Blue	Specifies the amount of color from -4 to +4. Note: The factory default setting is 0.
Contrast 0-5 Best for content	Specifies the contrast used for the copy job Note: "Best for content" is the factory default setting.
Shadow Detail -4 to +4	Adjusts the amount of shadow detail visible on a copy Note: 0 is the factory default setting.
Scan edge to edge On Off	Specifies if the original document is scanned edge-to-edge prior to copying Note: Off is the factory default setting.
Sharpness 1-5	Adjusts the amount of sharpness on a copy Note: 3 is the factory default setting.

Fax Settings menu

General Fax Settings

Menu item	Description
Station Name	Specifies the name of the fax within the printer
Station Number	Specifies a number associated with the fax
Station ID Station Name Station Number	Specifies how the fax is identified

Menu item	Description
Enable Manual Fax On Off	Sets the printer to fax manually only, which requires a line splitter and a telephone hand set Notes: <ul style="list-style-type: none"> • Off is the factory default setting. • Use a regular telephone to answer an incoming fax job and to dial a fax number. • Touch # 0 on the numeric keypad to go directly to the Manual Fax function.
Memory Use All receive Mostly receive Equal Mostly sent All send	Defines the amount of non-volatile memory used to fax a job Notes: <ul style="list-style-type: none"> • “All receive” specifies that all the memory is set to receive fax jobs. • “Mostly receive” specifies that most of the memory is set to receive fax jobs. • Equal is the factory default setting. Equal splits the memory for sending and receiving fax jobs into equal amounts. • “Mostly sent” specifies that most of the memory is set to send fax jobs. • “All send” specifies that all the memory is set to send fax jobs.
Cancel Faxes Allow Don't Allow	Specifies whether the printer may cancel fax jobs Note: If Cancel Faxes is not enabled, it will not appear as an option.
Caller ID FSK DTMF	Specifies the type of caller ID being used Note: FSK is the factory default setting.

Fax Send Settings

Menu item	Description
Resolution Standard Fine Super Fine Ultra Fine	Specifies quality in dots per inch (dpi). A higher resolution gives greater print quality, but it increases the fax transmission time for outgoing faxes. Note: Standard is the factory default setting.

Menu item	Description
Original Size Letter Legal Executive Mixed Letter/Legal Folio Statement A4 A5 A6 Oficio (Mexico) JIS B5 4 x 6 3 x 5 ID Card Universal Custom Scan Size Business Card	Specifies the paper size of the document that is being scanned Note: Letter is the US factory default setting. A4 is the international factory default setting.
Duplex Off Long edge Short edge	Specifies how the text and graphics are oriented on the page Notes: <ul style="list-style-type: none"> • Off is the factory default setting. • Long edge assumes binding along the long edge of the page (left edge for portrait orientation and top edge for landscape orientation). • Short edge assumes binding along the short edge of the page (top edge for portrait orientation and left edge for landscape orientation).
Content Text Text/Photo Photograph	Specifies the type of content that will be scanned to fax Notes: <ul style="list-style-type: none"> • Text is used when the document is mostly text. • Text/Photo is the factory default setting. Text/Photo is used when the documents are mostly text or line art. • Photograph is used when the document is a high-quality photograph or inkjet print.
Darkness -4 to +4	Lightens or darkens the output Note: 0 is the factory default setting.
Dial Prefix <none>	A numeric entry field is provided to enter numbers
Automatic Redial 0-9	Specifies the number of times the printer tries to send the fax to a specified number Note: 5 is the factory default setting.
Redial Frequency 1-200	Specifies the number of minutes between redials Note: 3 minutes is the factory default setting.

Menu item	Description
Behind a PABX Yes No	Enables switchboard blind dialing without a dial tone Note: No is the factory default setting.
Enable ECM Yes No	Enables Error Correction Mode for fax jobs Note: Yes is the factory default setting.
Enable Fax Scans On Off	Lets you send faxes by scanning at the printer Note: On is the factory default setting.
Driver to fax Yes No	Allows driver to fax jobs to be sent by the printer Note: Yes is the factory default setting.
Dial Mode Tone Pulse	Specifies the dialing sound, either as a tone or a pulse Note: Tone is the factory default setting.
Max Speed 2400 4800 9600 14400 33600	Specifies the maximum speed in baud at which faxes are sent Note: 33600 baud is the factory default setting.
Background Removal -4 to +4	Adjusts the amount of background visible on a copy Note: 0 is the factory default setting.
Contrast Best for content 0-5	Specifies the contrast of the output Note: "Best for content" is the factory default setting.
Shadow Detail -4 to +4	Adjusts the amount of shadow detail visible on a copy Note: 0 is the factory default setting.
Scan edge to edge On Off	Specifies if the original document is scanned edge-to-edge Note: Off is the factory default setting.
Sharpness 1-5	Adjusts the amount of sharpness on a fax Note: 3 is the factory default setting.
Enable Color Fax Scans On Off	Enables color faxing Note: On is the factory default setting.
Auto Convert Color Faxes to Mono Faxes On Off	Converts all outgoing faxes to black and white Note: On is the factory default setting.

Fax Receive Settings

Menu item	Description
Enable Fax Receive On Off	Allows fax jobs to be received by the printer Note: On is the factory default setting.
Rings to Answer 1–25	Specifies the number of rings before answering an incoming fax job Note: 3 is the factory default setting.
Auto Answer Yes No	Allows the printer to answer an incoming fax job Note: Yes is the factory default setting.
Manual Answer Code 1–9	Lets you enter a code on the telephone number pad to begin receiving a fax Notes: <ul style="list-style-type: none"> • This menu item is used when the printer shares a line with a telephone • 9 is the factory default setting
Auto Reduction On Off	Scales an incoming fax job so it fits the size of the paper loaded in the designated fax source Note: On is the factory default setting.
Paper Source Auto Size Match Tray <x> Single Sheet Feeder Multi-Page Feeder	Specifies the paper source selected to supply paper for the printer to print an incoming fax Note: Tray 1 is the factory default setting.
Sides On Off	Enables duplex (two-sided) printing for incoming fax jobs Note: Off is the factory default setting.
Fax Footer On Off	Prints the transmission information at the bottom of each page from a received fax Note: Off is the factory default setting.
Max Speed 2400 4800 9600 14400 33600	Specifies the maximum speed in baud at which faxes are received Note: 33600 (baud) is the factory default setting.
Block No Name Fax On Off	Enables blocking of incoming faxes sent from devices with no station ID specified Note: Off is the factory default setting.

Fax Log Settings

Menu item	Description
Transmission Log Print log Do not print log Print only for error	Enables printing of a transmission log after each fax job Note: Print log is the factory default setting.
Receive Error Log Print Never Print on Error	Enables printing of a receive error log following a receive error Note: Print Never is the factory default setting.
Auto Print Logs On Off	Enables automatic printing of fax logs Note: On is the factory default setting.
Log Paper Source Tray <x>	Selects the source of the paper used for printing logs Note: Tray 1 is the factory default setting.
Logs Display Remote Station Name Dialed Number	Specifies whether printed logs display the dialed number or the station name Note: "Remote Station Name" is the factory default setting.
Enable Job Log On Off	Enables access to the Fax Job log Note: On is the factory default setting.
Enable Call Log On Off	Enables access to the Fax Call log Note: On is the factory default setting.

Speaker Settings

Menu item	Description
Speaker Mode Always Off On until Connected Always On	Notes: <ul style="list-style-type: none"> • Always Off turns the speaker off. • "On until Connected" is the factory default setting. The speaker is on and issues a noise until the fax connection is made. • Always On turns the speaker on.
Speaker Volume High Medium Low	Controls the volume setting Note: High is the factory default setting.
Ringer Volume On Off	Controls the ringer volume for the fax speaker Note: On is the factory default setting.

Distinctive Rings

Menu item	Description
Single Ring On Off	Answers calls with a one-ring pattern Note: On is the factory default setting.
Double Ring On Off	Answers calls with a double-ring pattern Note: On is the factory default setting.
Triple Ring On Off	Triple Ring answers calls with a triple-ring pattern Note: On is the factory default setting.

Flash Drive menu

Flash Drive menu

Menu item	Description
Enable Drive Enable Disable	Enables or disables the USB port on the front of the printer Notes: <ul style="list-style-type: none"> • Certain options are not available on selected printer models. • Enable is the factory default setting
Update Code Enable Disable	Enables or disables the ability of the printer to update its firmware code from a USB device Note: Enable is the factory default setting

Scan Settings

Menu item	Description
Format PDF (.pdf) TIFF (.tif) JPEG (.jpg)	Specifies the format of the file Note: PDF is the factory default setting.
PDF Version 1.2–1.6	Sets the version of the PDF file that will be scanned to USB Note: 1.5 is the factory default setting.
Content Text Text/Photo Photograph	Specifies the type of content that will be scanned to USB Notes: <ul style="list-style-type: none"> • Text is used when the document is mostly text. • Text/Photo is the factory default setting. Text/Photo is used when the documents are mostly text or line art. • Photograph is used when the document is a high-quality photograph or inkjet print.

Menu item	Description
Color Gray Color	Specifies whether a job prints in grayscale or color Note: Gray is the factory default setting.
Resolution 75 150 200 300 400 600	Specifies how many dots per inch are scanned Note: 150 dpi is the factory default setting.
Darkness -4 to +4	Lightens or darkens the output Note: 0 is the factory default setting.
Orientation Portrait Landscape	Specifies the orientation of the scanned image Note: Portrait is the factory default setting.
Original Size Letter Legal Executive Folio Statement Universal 4 x 6 in. 3 x 5 in. Business Card Custom Scan Size <x> A4 A5 Oficio (Mexico) A6 JIS B5	Specifies the paper size of the document that is being scanned Note: Letter is the US factory default setting. A4 is the international factory default setting.
Sides (Duplex) Off Long edge Short edge	Specifies how the text and graphics are oriented on the page Notes: <ul style="list-style-type: none"> • Off is the factory default setting. • Long edge assumes binding along the long edge of the page (left edge for portrait orientation and top edge for landscape orientation). • Short edge assumes binding along the short edge of the page (top edge for portrait orientation and left edge for landscape orientation).

Menu item	Description
JPEG Quality Text or Text/Photo 5–90	Sets the quality of a JPEG text or text/photo image in relation to file size and the quality of the image. Notes: <ul style="list-style-type: none"> • 75 is the factory default setting. • 5 reduces the file size, but the quality of the image is lessened. • 90 provides the best image quality, but the file size is very large.
Photo JPEG Quality 5–90	Sets the quality of a JPEG photo image in relation to file size and the quality of the image Notes: <ul style="list-style-type: none"> • 50 is the factory default setting. • 5 reduces the file size, but the quality of the image is lessened. • 90 provides the best image quality, but the file size is very large.
Use Multi-Page TIFF On Off	Provides a choice between single-page TIFF files and multiple-page TIFF files. For a multiple-page scan to USB job, either one TIFF file is created containing all the pages, or multiple TIFF files are created with one file for each page of the job. Notes: <ul style="list-style-type: none"> • On is the factory default setting. • This menu item applies to all scan functions.
Scan bit Depth 8 bit 1 bit	Enables the Text/Photo mode to have smaller file sizes by using 1-bit images when Color is set to Off Note: 8 bit is the factory default setting.
Background Removal -4 to +4	Adjusts the amount of background visible on a copy Note: 0 is the factory default setting.
Contrast 0–5 Best for content	Specifies the contrast of the output Note: “Best for content” is the factory default setting.
Shadow Detail -4 to +4	Adjusts the amount of shadow detail visible on a scanned image Note: 0 is the factory default setting.
Scan edge to edge On Off	Specifies if the original document is scanned edge-to-edge Note: Off is the factory default setting.
Sharpness 1–5	Adjusts the sharpness of a scanned image Note: 3 is the factory default setting.

Print Settings

Menu item	Description
Copies	Specifies the number of copies to print Note: 1 is the factory default setting.

Menu item	Description
Sides (Duplex) 2 sided 1 sided	Enables duplex (two-sided) printing Note: 1 sided is the factory default setting.

Print Settings

Setup menu

Menu item	Description
Printer Language PS Emulation PCL Emulation PPDS Emulation	Determines which printer language the print server uses to send data to the printer Note: PS is the factory default setting.
Print Area Normal Fit to Page Whole Page	Determines the print area on paper Note: Normal is the factory default setting.
Download Target RAM Flash	Collects permanent resources that have been downloaded on the printer and automatically writes them to the flash drive Note: RAM is the factory default setting.
Resource Save On Off	Saves the permanently downloaded resources Note: Off is the factory default setting.

Finishing menu

Note: Certain options are not available on selected printer models.

Menu item	Description
Sides 2 Sided 1 Sided	Specifies whether duplex (2-sided) printing is set as the default for all print jobs Note: 1 Sided is the factory default setting.
Duplex Binding Long Edge Short Edge	Defines the way duplexed pages are bound and how the printing on the back of the page is oriented in relation to the printing on the front of the page Notes: <ul style="list-style-type: none"> • Long Edge is the factory default setting. • Long Edge specifies that binding be placed on the left edge of portrait pages and the top edge of landscape pages. • Short Edge specifies that binding be placed on the top edge of portrait pages and the left edge of landscape pages.
Copies 1–999	Specifies a default number of copies for each print job Note: 1 is the factory default setting.

Menu item	Description
Blank Pages Do Not Print Print	Specifies whether blank pages are inserted in a print job Note: "Do Not Print" is the factory default setting.
Collate On Off	Stacks the pages of a print job in sequence when printing multiple copies Notes: <ul style="list-style-type: none"> • Off is the factory default setting. No pages will be collated. • The On setting stacks the print job sequentially. • Both settings print the entire job the number of times specified by the Copy menu setting.
Separator Sheets None Between Copies Between Jobs Between Pages	Specifies whether blank separator sheets are inserted Notes: <ul style="list-style-type: none"> • None is the factory default setting. • Between Copies inserts a blank sheet between each copy of a print job if Collation is set to On. If Collation is set to Off, a blank page is inserted between each set of printed pages, such as after all page 1's, all page 2's, and so on. • Between Jobs inserts a blank sheet between print jobs. • Between Pages inserts a blank sheet between each page of the print job. This setting is useful when printing transparencies or inserting blank pages in a document for notes.
Separator Source Tray <x> Multi-Page Feeder	Specifies the paper source for separator sheets Note: Tray 1 (standard tray) is the factory default setting.
N-Up Off 2 Up 4 Up 6 Up 9 Up 16 Up	Specifies that multiple-page images are printed on one side of a sheet of paper Notes: <ul style="list-style-type: none"> • The number selected is the number of page images that will print per side • Off is the factory default setting.
N-Up Ordering Horizontal Reverse Horizontal Reverse Vertical Vertical	Specifies how the page images appear on the physical page Note: Horizontal is the factory default setting.
Orientation Auto Landscape Portrait	Specifies the orientation of a multiple-page sheet Notes: <ul style="list-style-type: none"> • Auto is the factory default setting. The printer chooses between portrait and landscape. • Long Edge uses landscape. • Short Edge uses portrait.

Menu item	Description
N-Up Border None Solid	Prints a border around each page image Note: None is the factory default setting.

Quality menu

Menu item	Description
Color Correction Auto Off Manual	Adjusts the color output on the printed page Notes: <ul style="list-style-type: none"> • Auto is the factory default setting. Auto applies different color conversion tables to each object on the printed page. • Off turns off color correction. • Manual allows customization of the color tables using the settings available from the Manual Color menu. • Due to the differences in additive and subtractive colors, certain colors that appear on computer monitors are impossible to duplicate on the printed page.
Print Resolution 4800 CQ 1200 dpi	Specifies the printed output resolution Note: 4800 CQ is the factory default setting.
Toner Darkness 1–5	Lightens or darkens the printed output Notes: <ul style="list-style-type: none"> • 4 is the factory default setting. • Selecting a smaller number can help conserve toner.
Enhance Fine Lines On Off	Creates smoother lines with sharper edges Notes: <ul style="list-style-type: none"> • Off is the factory default setting. • This feature improves the printed output of CAD-type drawings (e.g. circuit diagrams, architectural prints, etc.).
Color Saver On Off	Reduces the amount of toner used for graphics and images. The amount of toner used for text is not reduced. Notes: <ul style="list-style-type: none"> • Off is the factory default setting. • On overrides Toner Darkness settings.
RGB Brightness -6 to +6	Adjusts brightness in color outputs Notes: <ul style="list-style-type: none"> • 0 is the factory default setting. • This menu item does not affect files that use CMYK color specifications.

Menu item	Description
RGB Contrast 0–5	Adjusts contrast in color outputs Notes: <ul style="list-style-type: none"> • 0 is the factory default setting. • This menu item does not affect files that use CMYK color specifications.
RGB Saturation 0–5	Adjusts saturation in color outputs Notes: <ul style="list-style-type: none"> • 0 is the factory default setting. • This menu item does not affect files that use CMYK color specifications.
Color Balance Cyan Magenta Yellow Black Reset Defaults	Lets you make subtle color adjustments to the printer output by individually altering the amount of toner being used for each color plane. Specifies the amount of color from -5 to +5. Note: 0 is the factory default setting.
Color Samples sRGB Display sRGB Vivid Display—True Black Vivid Off—RGB US CMYK Euro CMYK Vivid CMYK Off—CMYK	Prints sample pages for each of the RGB and CMYK color conversion tables used in the printer Notes: <ul style="list-style-type: none"> • Selecting any setting prints the sample. • Color samples consist of a series of colored boxes along with the RGB or CMYK combination that creates the color observed. These pages can be used to help decide which combinations to use to get the desired printed output. • From a browser window, type the IP address of the printer to access a complete list of color sample pages from the Embedded Web Server.
Manual Color (RGB) RGB Image RGB Text RGB Graphics	Customizes the RGB color conversions. The values for each setting are: Vivid sRGB Display Display—True Black sRGB Vivid Off Notes: <ul style="list-style-type: none"> • Vivid applies a color conversion table that produces brighter, more saturated colors. • sRGB Display is the factory default setting for RGB Image. This applies a color conversion table to an output that matches the colors displayed on a computer monitor. • Display—True Black applies a color conversion table that uses only black toner for neutral gray colors. • sRGB Vivid is the factory default setting for RGB Text and RGB Graphics. sRGB Vivid applies a color table that increases saturation. This is preferred for business graphics and text. • Off turns off color conversion.

Menu item	Description
Manual Color (CMYK) CMYK Image CMYK Text CMYK Graphics	Customizes the CMYK color conversions. The values for each setting are: USCMYK EuroCMYK Vivid CMYK Off Notes: <ul style="list-style-type: none"> • USCMYK is the US factory default setting • EuroCMYK is the International factory default setting • Vivid CMYK applies a color conversion table that produces brighter, more saturated colors. • Off turns off color conversion.
Color Adjust	Initiates an automatic color adjust calibration.

Utilities menu

Menu item	Description
Hex Trace Activate	Assists in isolating the source of a print job problem Notes: <ul style="list-style-type: none"> • When Hex Trace is activated, all data sent to the printer is printed in hexadecimal and character representation, and control codes are not executed. • To exit Hex Trace, turn the printer off.
Coverage Estimator Off On	Provides an estimate of the percentage coverage of cyan, magenta, yellow, and black on a page. The estimate is printed on a separator page. Notes: <ul style="list-style-type: none"> • Off is the factory default setting. • This menu item is not available on selected printer models.

PDF menu

Menu item	Description
Scale to Fit No Yes	Scales page content to fit the selected page size Note: No is the factory default setting.
Annotations Do Not Print Print	Specifies whether to print annotations in the PDF Note: Do Not Print is the factory default setting.

PostScript menu

Menu item	Description
Print PS Error On Off	Prints a page containing the PostScript error Note: Off is the factory default setting.
Image Smoothing On Off	Enhances the contrast and sharpness of low-resolution images and smooths their color transitions Notes: <ul style="list-style-type: none"> • Off is the factory default setting. • Image Smoothing has no effect on images that are 300 dpi or higher in resolution.

PCL Emul menu

Menu item	Description
Font Source Resident Download All	Specifies the set of fonts used by the Font Name menu item Notes: <ul style="list-style-type: none"> • Resident is the factory default setting. It shows the factory default set of fonts downloaded into RAM. • Download shows all the fonts downloaded into RAM. • All shows all fonts available to any option.
Font Name RO Courier	Identifies a specific font and the option where it is stored Notes: <ul style="list-style-type: none"> • RO Courier is the factory default setting. • RO Courier shows the font name, font ID, and storage location in the printer. The font source abbreviation is R for Resident, F for Flash, and D for Download.
Symbol Set 10U PC-8 12U PC-850	Specifies the symbol set for each font name Notes: <ul style="list-style-type: none"> • 10U PC-8 is the US factory default setting. • 12U PC-850 is the international factory default setting. • A symbol set is a set of alphabetic and numeric characters, punctuation, and special symbols. Symbol sets support the different languages or specific programs such as math symbols for scientific text. Only the supported symbol sets are shown.
PCL Emulation Settings Point Size 1.00–1008.00	Changes the point size for scalable typographic fonts Notes: <ul style="list-style-type: none"> • 12 is the factory default setting. • Point Size refers to the height of the characters in the font. One point equals approximately 1/72 of an inch. • Point sizes can be increased or decreased in 0.25-point increments.

Menu item	Description
PCL Emulation Settings Pitch 0.08–100	Specifies the font pitch for scalable monospaced fonts Notes: <ul style="list-style-type: none"> • 10 is the factory default setting. • Pitch refers to the number of fixed-space characters per inch (cpi). • Pitch can be increased or decreased in 0.01-cpi increments. • For nonscalable monospaced fonts, the pitch appears on the display but cannot be changed.
PCL Emulation Settings Orientation Portrait Landscape	Specifies the orientation of text and graphics on the page Notes: <ul style="list-style-type: none"> • Portrait is the factory default setting. • Portrait prints text and graphics parallel to the short edge of the page. • Landscape prints text and graphics parallel to the long edge of the page.
PCL Emulation Settings Lines per Page 1–255 60 64	Specifies the number of lines that print on each page Notes: <ul style="list-style-type: none"> • 60 is the US factory default setting. 64 is the international factory default setting. • The printer sets the amount of space between each line based on the Lines per Page, Paper Size, and Orientation settings. Select the desired Paper Size and Orientation before setting Lines per Page.
PCL Emulation Settings A4 Width 198 mm 203 mm	Sets the printer to print on A4-size paper Notes: <ul style="list-style-type: none"> • 198 mm is the factory default setting. • The 203-mm setting sets the width of the page to allow the printing of eighty 10-pitch characters.
PCL Emulation Settings Auto CR after LF On Off	Specifies whether the printer automatically performs a carriage return (CR) after a line feed (LF) control command Notes: <ul style="list-style-type: none"> • Off is the factory default setting. • Setting alterations are duplicated in the PPDS menu.
PCL Emulation Settings Auto LF after CR On Off	Specifies whether the printer automatically performs a line feed (LF) after a carriage return (CR) control command Notes: <ul style="list-style-type: none"> • Off is the factory default setting. • Setting alterations are duplicated in the PPDS menu.

Menu item	Description
Tray Renumber Assign MP Feeder Off None 0–199 Assign Tray <x> Off None 0–199 Assign Manual Paper Off None 0–199 Assign Man Env Off None 0–199	Configures the printer to work with printer software or programs that use different source assignments for trays, drawers, and feeders Notes: <ul style="list-style-type: none"> • Off is the factory default setting. • None is not an available selection. It is displayed only when it is selected by the PCL 5 interpreter. • None ignores the Select Paper Feed command. • 0–199 allows a custom setting to be assigned.
Tray Renumber View Factory Def None	Displays the factory default setting assigned to each tray, drawer, or feeder
Tray Renumber Restore Defaults Yes No	Returns all tray, drawer, and feeder assignments to the factory default settings

Image menu

Menu item	Description
Auto Fit On Off	Selects the optimal paper size, scaling, and orientation Notes: <ul style="list-style-type: none"> • On is the factory default setting. • The On setting overrides scaling and orientation settings for some images.
Invert On Off	Inverts bi-tonal monochrome images Notes: <ul style="list-style-type: none"> • Off is the factory default setting. • The font size can be increased in 1-point increments. • This setting does not apply to GIF or JPEG images.

Menu item	Description
Scaling Anchor Top Left Best Fit Anchor Center Fit Height/Width Fit Height Fit Width	Scales the image to fit the selected paper size Note: Best Fit is the factory default setting.
Orientation Portrait Landscape Rev Portrait Rev Landscape	Sets the image orientation Note: Portrait is the factory default setting.

PictBridge menu

Menu item	Description
Photo Size Auto L 2L Hagaki Postcard Card Size 100 x 150 mm 4 x 6 in 8 x 10 in Letter A4 A5 JIS B5	Controls the printed size of each photo printed from a PictBridge-enabled device Notes: <ul style="list-style-type: none"> • Auto is the factory default setting. • If both the printer and the PictBridge-enabled camera have a value for this setting, the value in the camera supersedes the value in the printer.
Layout Auto Off 2 Up 3 Up 4 Up 6 Up 9 Up 12 Up 16 Up Index Print	Determines the maximum number of images that can print on one side of paper Notes: <ul style="list-style-type: none"> • Auto is the factory default setting. • If both the printer and the PictBridge-enabled camera have a value for this setting, the value in the camera supersedes the value in the printer.

Menu item	Description
Quality Normal Draft Fine	Determines which resolution, toner darkness, and color saver values the device uses when printing photos sent from a PictBridge-enabled device Notes: <ul style="list-style-type: none"> • Normal is the factory default setting. • If both the printer and the PictBridge-enabled camera have a value for this setting, the value in the camera supersedes the value in the printer.
Paper Source MP Feeder Tray <x> Manual Paper	Identifies the printer default input source when printing photos from a PictBridge-enabled device Notes: <ul style="list-style-type: none"> • MP Feeder is the factory default setting. • A photo size larger than the size of the media installed in the printer input source cannot be selected.

Set Date and Time

Menu item	Description
View Date/Time	Displays the time in YYYY-MM-DD HH:MM format Note: This is a view only screen.
Set Date/Time Yes No	Instructs the printer to run the setup wizard Notes: <ul style="list-style-type: none"> • Yes is the factory default setting. • After completing the setup wizard by selecting Done at the Country select screen, the default becomes No.
Time Zone (North, Central, and South America) Hawaii * Alaska Tijuana (PST) USA/Canada PST USA/Canada MST USA/Canada CST USA/Canada EST Canada AST Caracas (VET) Newfoundland (NST) Brasilia (BRT)	Specifies the time zone for the fax Note: * indicates that this value <i>does not</i> have pre-programmed Daylight Savings Time Start and End times.

Menu item	Description
Time Zone (Europe and Africa) Azores (AZOT) Praia (CVT) * GMT (*) Dublin, Ireland London (BST) Western Europe Central Europe Eastern Europe Cairo (EET) Pretoria (SAST) * Moscow (MSK)	Specifies the time zone for the fax Note: * indicates that this value <i>does not</i> have pre-programmed Daylight Savings Time Start and End times.
Time Zone (Asia) Jerusalem (IST) Abu Dhabi GIST)* Kabul (AFT) * Islamabad (PKT) * New Delhi (IST) * Kathmandu (NPT) * Astana (ALMT) * Yangon (MMT) * Bangkok (ICT) * Beijing (CST) * Seoul (KST) * Tokyo (JST) *	Specifies the time zone for the fax Note: * indicates that this value <i>does not</i> have pre-programmed Daylight Savings Time Start and End times.
Time Zone (Australia and the Pacific region) Australia WST Australia CST Darwin (CST) * Australia EST Queensland (EST) * Tasmania (EST) Wellington (NZST) Not Listed	Specifies the time zone for the fax Note: * indicates that this value <i>does not</i> have pre-programmed Daylight Savings Time Start and End times.
Observe DST On Off	Accommodates Daylight Savings Time changes Note: On is the factory default setting.
Enable NTP On Off	Lets the printer clock synchronize with the Network Time Protocol (NTP) server Note: On is the factory default setting.

Understanding printer messages

List of status and error messages

Access USB after scan

A USB drive was inserted into the printer while the printer was scanning. From the keypad, press **1** to open the drive after scanning, or press **2** to ignore the USB drive.

Access USB now

A USB drive was inserted into the printer while the printer was setting up a job (copy, fax, e-mail) or while in the menus. From the keypad, press **1** to release job resources and access the USB drive directly, or press **2** to ignore the USB drive and return to the job being set up.

Busy

Wait for the message to clear.

Calibrating

Wait for the message to clear.

Call complete

A fax call is completed. Wait for the message to clear.

Cancel not available

Wait for the message to clear.

Canceling

Wait for the message to clear.

Check Config ID

The printer configuration ID is invalid. Contact Customer Support.

Clock battery

The real-time clock in the printer has a malfunctioning battery. This message appears until the real-time clock battery is replaced.

Close door

Close the upper and lower doors.

<color> Low

Replace the toner cartridge, and then wait for the message to clear.

Dialing

A fax number is dialed. If the number is too long to fit on the screen, only the word **Dialing** appears. Wait for the message to clear.

DO NOT TOUCH

The printer is receiving a code to update a file. Wait for the message to clear.

Warning—Potential Damage: Do not turn off or touch the printer while this message appears on the display.

Fax complete

A fax that was sent or received is complete. Wait for the message to clear.

Fax failed

The fax failed to be sent. Wait for the message to clear.

Flushing buffer

Wait for the message to clear.

File corrupt

A file with a valid extension is detected, but the actual file type does not match the extension, or the file is corrupt.

Hex Trace

The printer is in Hex Trace mode.

With Hex Trace selected, all data sent to the printer is printed in hexadecimal and character representation. This is used to help isolate the source of a print job problem.

Note: Control codes are not executed.

To exit Hex Trace, turn the printer off, wait about 10 seconds, and then turn the printer on.

Imaging Kit

Replace the imaging kit, and then press  to clear the message and continue printing.

Incoming call

This message appears when using manual fax mode. Press  to print a black only fax or  to print a color fax.

Insert Tray <x>

Insert the specified tray into the printer.

Invalid Engine Code

The engine code is invalid. Contact Customer Support.

Invalid Network Code

The network code is invalid. Contact Customer Support.

LADP connection error

The LADP server information is present but the printer is unable to communicate with the server, or the communication ended before the return of the search results.



- Wait for the message to clear and try searching for the address again.
- Contact your system support person.

Line busy

A fax number is dialed, but the fax line is busy. Wait for the message to clear.





Load <src> with <x>

Try one or more of the following:

- Load the paper tray or other source with the correct paper type and size.
- Press , and then press  to cancel printing.

Load single sheet feeder with <x>

Try one or more of the following:

- Load the manual feeder with the correct paper type and size.
If no paper is in the manual feeder, load a sheet, and then press  to clear the message and continue printing.
- Press  to clear the message and continue printing.
The printer manually overrides the manual request, and then the job prints from an automatic source.
- Press , and then press  to cancel printing.
- Define a name for each custom type (Custom 1–6) using the MarkVision utility. When the printer is prompting for one of the custom types, which has been named, then only the custom name is displayed.

Maintenance

The printer needs maintenance. Call for service.

Memory full, cannot send faxes

The printer fax memory is full. Press  to clear the message and cancel the fax.

- Reduce the fax resolution and try to send the fax again.
- Reduce the number of pages in the fax and try to send the fax again.

Menus disabled

The printer menus are disabled. The printer settings cannot be changed from the printer control panel. Contact your system support person for help.

Note: When menus are disabled, it is still possible to cancel a print job.

No analog phone line

The analog phone line was not detected; the fax is disabled. Connect the printer to an analog phone line.

No answer

A fax number is dialed, but no connection is made. Wait for the message to clear.

No dial tone

The printer does not have a dial tone. Wait for the message to clear.

No recognized file types

Either there are no files saved on the USB drive, or the files saved are not supported. Convert files to any of the following supported file types: .pdf, .gif, .jpeg, .jpg, .bmp, .png, .tiff, .tif, .pcx, or .dcm.



PC Kit Life Warning

This is the final warning message for the photoconductor kit. The photoconductor kit is near exhaustion. The printer continues printing unless the value for the Cartridge Alarm is changed from the printer control panel or set to On from the Supply Notifications Web page (located on the Embedded Web Server).

If the setting is On, then the printer stops printing. Press  to select **Continue**. The printer continues to print until the photoconductor kit is completely exhausted. When the photoconductor kit is exhausted, replace it.

Phone in Use

The telephone attached to the printer is in use, or its handset is off the cradle.

- 1 Place the handset on the telephone cradle.
- 2 Press  to send a black only fax or  to send a color fax.
- 3 Enter the fax number.

Picture too large

The photo sent to the printer is larger than the current paper size. Press the arrow buttons until **Closest photo size** or **Fit to page** appears, and then press .

Power Saver

The printer is saving power while it waits for the next print job.

- Send a job to print.
- Touch  to warm the printer to normal operating temperature. Afterwards, **Ready** appears.

Printing error

A job sent from a USB drive was not successfully received. Wait for the message to clear and then try sending the job again.

Programming Code

The printer is receiving a file that is a code update. Wait for the message to clear.

Warning—Potential Damage: Do not turn the printer off while this message appears on the display.

Reading data

A PictBridge enabled device is connected, and the printer is reading data from the device. Wait for the message to clear.

Warning—Potential Damage: Do not remove the device or turn the printer power off while **Reading data** appears on the display.

Reading error (Remove drive)

The printer was reading information from a USB drive and encountered an error. The USB drive must be removed from the printer to clear the message.



Ready

The printer is ready to receive print jobs.

Receiving pXX

The printer is receiving a fax. **pXX** represents the number of pages received. Wait for the message to clear.

Reload printed pages in Tray <x>

- Press  to clear the message and continue processing the second side of the sheet.
- Press , and then press  to cancel printing.

Remote Management Active

The printer is offline while it configures settings. Wait for the message to clear.

Remove originals from the scanner ADF

Remove the paper from the ADF to clear the message and continue printing.

Remove packaging material

Check for and remove any packaging materials from the toner cartridges.

Remove paper from standard output bin

Remove the stack of paper from the standard exit bin.

Replace <color> cartridge

Replace the toner cartridge, and then press  to clear the message and continue printing.

Replace PC Kit

This is the early warning message for the photoconductor kit. The printer continues printing unless the value for the Cartridge Alarm is changed from the printer control panel or set to On from the Supply Notifications Web page (located on the Embedded Web Server).

If the setting is On, then the printer stops printing. Press  to select **Continue** and continue printing.

When the **PC Kit Life Warning** appears, order a new photoconductor kit.

Scan Document Too Long

The scan job exceeds the maximum number of pages. Press , and then press  to cancel printing and clear the message.

Scan to USB failed

An attempt to create a file on the USB drive failed.

Try one or more of the following:

- Re-send the job.
- Reduce the scan resolution, and then try sending the job again.
- Remove the USB drive, reconnect it, and then try sending the job again.

Scanner ADF Cover Open

The ADF cover is open. The message clears when the cover is closed.

Sending pXX



The printer is sending a fax. **pXX** represents the number of pages received. Wait for the message to clear.

Standard Exit Bin Full

Empty the standard exit bin to clear the message and continue printing.

Tray <x> Empty

Try one or more of the following:

- Load the paper tray or other source with the correct paper type and size.
- Press , and then press  to cancel the current job.

Tray <x> Low

Wait until the printer is not printing, and then load the paper tray or other source with the correct paper type and size.

Tray <x> Missing

Insert the specified tray into the printer.

Unsupported USB device, please remove

Remove the unrecognized USB device.

Unsupported USB hub, please remove

Remove the unrecognized USB hub.

Unsupported Mode

Remove the camera, and then change the mode to PictBridge. Reconnect the camera.

USB drive disabled

A USB drive was inserted into the printer, and the port is disabled. Contact your system support person.

Use camera controls to print

A recognized PictBridge-compatible camera is attached to the printer.

Waiting

The printer has received data to print, but is waiting for an End-of-Job command, a Form Feed command, or additional data.

Try one or more of the following:

- Press to print the contents of the buffer.
- Cancel the current print job.

Waiting, too many events

Wait for the message to clear.

Warning—Potential Damage: Do not turn the printer off while this message appears on the display.

30.yy <color> cartridge missing

Insert the missing toner cartridge to clear the message and continue printing.

31.yy Defective <color> Cartridge

Replace the defective toner cartridge with a new one.

31 Defective Imaging Kit

Replace the imaging kit.



32.yy Replace Unsupported <color> Cartridge

Replace the unsupported toner cartridge with a supported one.

34 Short paper

The printer paper size setting did not match the length of the paper that entered the printer.

Try one or more of the following:

- Press  to clear the message and continue printing.
- Press , and then press  to cancel printing.
- Make sure the paper size setting matches the size of the paper in the tray.



35 Insufficient memory to support Resource Save feature

The printer lacks sufficient memory to save settings. Install additional memory, or press  to disable Resource Save and continue printing.

37 Insufficient memory to collate job

The printer prints the pages that were spooled prior to the collation message and collates the remainder of the print job.



Try one or more of the following:

- Press  to clear the message and continue printing.
- Press , and then press  to cancel printing.

38 Memory Full

The printer does not have enough memory available to continue printing. You cannot press  because of this.

Try one or more of the following:

- Press , and then press  to cancel printing.
- Simplify the print job by reducing the amount of text or graphics on a page and deleting unnecessary downloaded fonts or macros.
- Install additional printer memory.

39 Complex page, some data may not have printed

The page is too complex to print. Press , and then press  to cancel printing.



40 <color> Invalid refill, change cartridge

Replace the toner cartridge with a new one.

50 PPDS Font Error

The printer has encountered a font error because a specific font may not be installed.

Try one or more of the following:



- Press  to clear the message and continue printing.
- The printer cannot find the requested font. From the PPDS menu, select **Best Fit**, and then select **On**. The printer will find a similar font and reformat the affected text.
- Press , and then press  to cancel printing.

51 Defective flash detected

Press  to clear the message and continue printing.

52 Not enough free space in flash memory for resources

Try one or more of the following:

- Press  to clear the message and continue printing.
- Delete fonts, macros, and other data stored in flash memory.
- Upgrade to a larger capacity flash memory.
- Press , and then press  to cancel printing.

53 Unformatted flash detected

Try one or more of the following:

- Press  to clear the message and continue printing.
- Format the flash memory. If the message remains, the flash memory may be defective and require replacing.

54 Network <x> Software Error

The printer detects that a network port is installed, but cannot communicate with it. The printer disables all communication to the associated network interface.

Try one or more of the following:

- Press  to clear the message and continue printing.
- Turn the printer off and then back on to reset the printer.
- Upgrade (flash) the network firmware in the printer or print server.

56 Standard USB Port Disabled

Try one or more of the following:

- The printer discards any data received through the USB port. Press  to clear the message and continue printing.
- Make sure the USB Buffer menu item is not set to Disabled.

58 Too many flash options installed

Too many optional flash memory cards or too many optional firmware cards are installed on the printer.

Try one or more of the following:

- Press to clear the message and continue printing.
- Remove extra flash options:
 - 1 Turn the printer off.
 - 2 Unplug the power cord from the wall outlet.
 - 3 Remove extra flash options.
 - 4 Connect the power cord to a properly grounded outlet.
 - 5 Turn the printer back on.

58 Too many trays attached

- 1 Turn the printer off.
- 2 Unplug the power cord from the wall outlet.
- 3 Remove the additional trays.
- 4 Connect the power cord to a properly grounded outlet.
- 5 Turn the printer back on.

59 Incompatible tray <x>

Only options designed specifically for this printer are supported.

Try one or more of the following:

- Remove the specified tray.
- Press to clear the message and continue printing without using the specified tray.

82 Replace waste toner box

Replace the waste toner bottle. For more information, see “Replacing the waste toner bottle” on page 165.

82.yy Waste toner box missing

Replace the waste toner bottle, and then press to clear the message and continue printing.

88.yy <color> Cartridge is low

Press to clear the message and continue printing.

88.yy Replace <color> Cartridge

Replace the toner cartridge.

150 displayed

The USB drive contains more than 150 files; only 150 files will be displayed.

200.yy Paper jam <area name>

- 1 Clear the paper path.
- 2 Press to clear the message and continue printing.

201.yy Paper jam <area name>

- 1 Clear the paper path.
- 2 Remove the jammed paper below the fuser.
- 3 Press to clear the message and continue printing.

202.yy Paper jam <area name>

- 1 Clear the paper path.
- 2 Remove the jammed paper from the fuser.
- 3 Press to clear the message and continue printing.

230.yy Paper jam <area name>

- 1 Clear the paper path.
- 2 Open the front door, and then remove the jammed paper.
- 3 Close the front door.
- 4 Press to clear the message and continue printing.

Note: When there is more than one jam, the message displays the number of pages jammed.

235 Paper Jam Check Duplex

An unsupported paper size is jammed in the duplex unit.

- 1 Open the front door
- 2 Remove the jam.
- 3 Load the tray with the correct paper size.
- 4 Press to continue printing.

24x Paper Jam Check Tray <x>

- 1 Pull the tray out.
- 2 Remove the jammed paper.
- 3 Insert the tray.

If all jams are cleared, the printer resumes printing.



Note: When there is more than one jam, the message indicates the number of pages jammed.

250.yy Paper jam <area name>

- 1 Clear the paper path.
- 2 Open the front door, and then remove the jammed paper.
- 3 Hold the fuser cover down, and then remove the jammed paper from inside the fuser.
- 4 Close the fuser cover, and then close the front door.
- 5 Press  to clear the message and continue printing.

290–292 ADF Scanning Jams



The scanner failed to feed one or more pages through the ADF.

- 1 Remove all pages from the ADF.
Note: The message clears when the pages are removed from the ADF.
- 2 Flex and fan the pages.
- 3 Place the pages in the ADF.
- 4 Adjust the ADF guides.
- 5 From the printer control panel, press  to start a black only job or  to start a color job.

293 Paper Missing

The scanner was instructed to scan using the ADF, but there is no paper in the ADF.

Note: The message clears when the pages are placed in the ADF.

- 1 Flex and fan the pages.
- 2 Place the pages in the ADF.
- 3 Adjust the ADF guides.
- 4 From the printer control panel, press  to start a black only job or  to start a color job.

293.02 Flatbed Cover Open



Close the scanner cover.

294 ADF Jam

This jam location may also be identified as **294.04 Duplex Sensor Off Jam**, **294.05 Scan Sensor Off Jam**, or **294.06 ADF Backfeed Jam**. To clear this jam:

- 1 Remove all pages from the ADF.
Note: The message clears when the pages are removed from the ADF.
- 2 Flex and fan the pages.
- 3 Place the pages in the ADF.

4 Adjust the ADF guides.

5 From the printer control panel, press  to start a black only job or  to start a color job.

840.01 Scanner Disabled

This message indicates that the scanner has been disabled by the system support person.

840.02 Scanner Auto Disabled



This message indicates the printer identified a problem with the scanner and automatically disabled it.

1 Remove all pages from the ADF.

2 Turn the printer off.

3 Wait 15 seconds and then turn the printer on.

4 Place the document in the ADF.

5 Press  to start a black only job or  to start a color job.

Note: If turning the printer off and then on again does not clear the message, contact your system support person.

940.01

Press down on the cyan toner cartridge to make sure it is installed properly. Turn the printer off, wait about 10 seconds, and then turn the printer back on

941.01

Press down on the magenta toner cartridge to make sure it is installed properly. Turn the printer off, wait about 10 seconds, and then turn the printer back on.

942.01

Press down on the yellow toner cartridge to make sure it is installed properly. Turn the printer off, wait about 10 seconds, and then turn the printer back on

943.01

Press down on the black toner cartridge to make sure it is installed properly. Turn the printer off, wait about 10 seconds, and then turn the printer back on

940.02

The cyan toner cartridge needs maintenance. Call for service.

941.02

The magenta toner cartridge needs maintenance. Call for service.

942.02

The yellow toner cartridge needs maintenance. Call for service.

943.02

The black toner cartridge needs maintenance. Call for service.

900–999 Service <message>

- 1** Turn the printer off.
- 2** Unplug the power cord from the wall outlet.
- 3** Check all cable connections.
- 4** Connect the power cord to a properly grounded outlet.
- 5** Turn the printer back on.

If the service message appears again, contact Customer Support, and report the message.

Maintaining the printer

Periodically, certain tasks are required to maintain optimum print quality.

Storing supplies

Choose a cool, clean storage area for the printer supplies. Store supplies right side up in their original packing until you are ready to use them.

Do not expose supplies to:



- Direct sunlight
- Temperatures above 35°C (95°F)
- High humidity above 80%
- Salty air
- Corrosive gases
- Heavy dust

Checking the status of supplies

A message appears on the display when a replacement supply item is needed or when maintenance is required.

Checking the status of supplies from the printer control panel

You can check the status of printer supplies by printing a menu settings page:

- 1 Make sure the printer is on and **Ready** appears.
- 2 From the printer control panel, press .
- 3 Press the arrow buttons until **Reports** appears, and then press .
- 4 Press the arrow buttons until **Menu Settings Page** appears, and then press .

Checking the status of supplies from a network computer

Note: The computer must be connected to the same network as the printer.

- 1 Type the printer IP address into the address field of your Web browser.
Note: If you do not know the IP address of the printer, print a network setup page and locate the IP address in the TCP/IP section.
- 2 Click **Device Status**. The Device Status page appears, displaying a summary of supply levels.

Conserving supplies

There are some settings you can change from the printer control panel that will help you conserve toner and paper. For more information, see "Supplies menu," "Quality menu," and "Finishing menu."

If you need to print several copies, you can conserve supplies by printing the first copy and checking it for accuracy before printing the remaining copies.

Ordering supplies

To order supplies in the U.S., contact Lexmark at 1-800-539-6275 for information about Lexmark authorized supplies dealers in your area. In other countries or regions, visit the Lexmark Web Site at www.lexmark.com or contact the place where you purchased the printer.

Note: All life estimates for printer supplies assume printing on letter- or A4-size plain paper.

Ordering toner cartridges

When **88 Cyan Cartridge Low**, **88 Magenta Cartridge Low**, **88 Yellow Cartridge Low**, or **88 Black Cartridge low** appears, order a new cartridge.

When **88 Replace Cyan Cartridge**, **88 Replace Magenta Cartridge**, **88 Replace Yellow Cartridge**, or **88 Replace Black Cartridge** appears, you *must* replace the specified toner cartridge.

Part name	Part number	C540, C543, and X543 series	C544 and X544 series
Black Return Program Toner Cartridge	C540A1KG	✓	✓
Cyan Return Program Toner Cartridge	C540A1CG	✓	✓
Magenta Return Program Toner Cartridge	C540A1MG	✓	✓
Yellow Return Program Toner Cartridge	C540A1YG	✓	✓
Black High Yield Return Program Toner Cartridge	C540H1KG	✓	✓
Cyan High Yield Return Program Toner Cartridge	C540H1CG	✓	✓
Magenta High Yield Return Program Toner Cartridge	C540H1MG	✓	✓
Yellow High Yield Return Program Toner Cartridge	C540H1YG	✓	✓
Black High Yield Toner Cartridge	C540H2KG	✓	✓
Cyan High Yield Toner Cartridge	C540H2CG	✓	✓
Magenta High Yield Toner Cartridge	C540H2MG	✓	✓
Yellow High Yield Toner Cartridge	C540H2YG	✓	✓

Part name	Part number	C540, C543, and X543 series	C544 and X544 series
Black Extra High Yield Return Program Toner Cartridge	C544X1KG	Not supported	✓
Cyan Extra High Yield Return Program Toner Cartridge	C544X1CG	Not supported	✓
Magenta Extra High Yield Return Program Toner Cartridge	C544X1MG	Not supported	✓
Yellow Extra High Yield Return Program Toner Cartridge	C544X1YG	Not supported	✓
Black Extra High Yield Toner Cartridge	C544X2KG	Not supported	✓
Cyan Extra High Yield Toner Cartridge	C544X2CG	Not supported	✓
Magenta Extra High Yield Toner Cartridge	C544X2MG	Not supported	✓
Yellow Extra High Yield Toner Cartridge	C544X2YG	Not supported	✓

Ordering imaging kits

When **Replace black and color imaging kit** or **Replace black imaging kit** appears, order a replacement imaging kit.

Part name	Part number
Black and Color Imaging Kit	C540X71G
Black Imaging Kit	C540X74G

Ordering a waste toner bottle

When **82 Replace Waste Toner** appears, order a replacement waste toner bottle. The waste toner bottle *must* be replaced when **82 Replace Waste Toner** appears.

Part name	Part number
Waste toner bottle	C540X75G

Replacing supplies

Replacing the waste toner bottle

Replace the waste toner bottle when 82 **Replace waste toner** appears. The printer will not continue printing until the waste toner bottle is replaced.

- 1 Unpack the replacement waste toner bottle.
- 2 Grasp the front door at the side handholds, and then pull it toward you.

 **CAUTION—HOT SURFACE:** The inside of the printer might be hot. To reduce the risk of injury from a hot component, allow the surface to cool before touching.

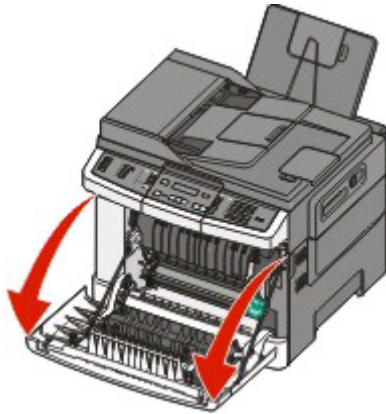

- 3 Open the top door.

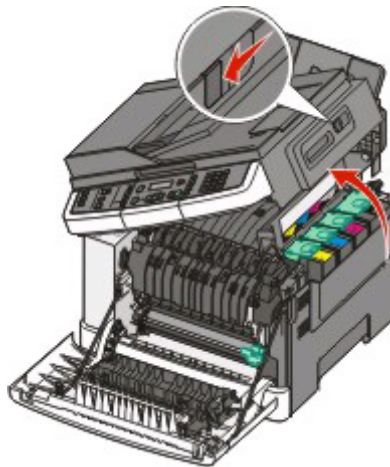

4 Remove the right side cover.

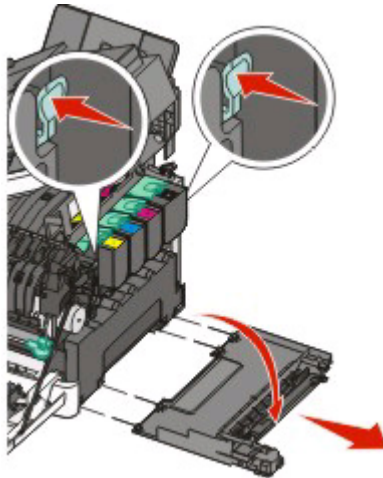

5 Press the green levers on each side of the waste toner bottle, and then remove it.

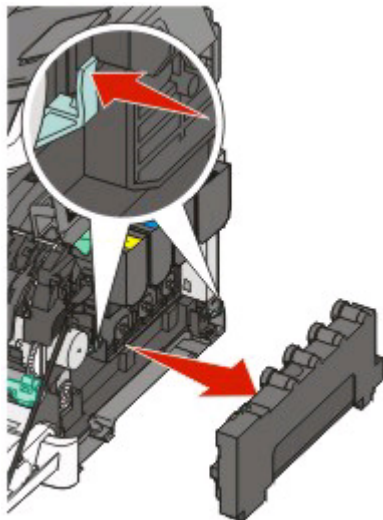

6 Place the waste toner bottle in the enclosed packaging.

7 Insert the new waste toner bottle.

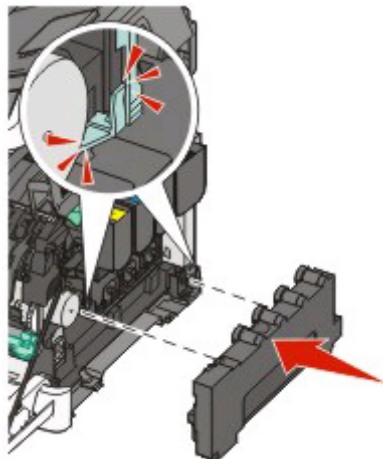

8 Replace the right side cover.

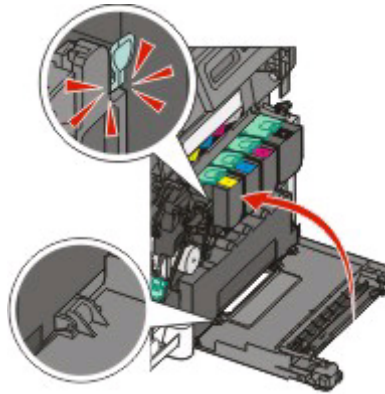

9 Close the top door.

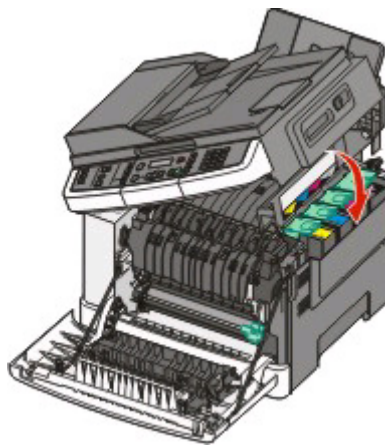

10 Close the front door.

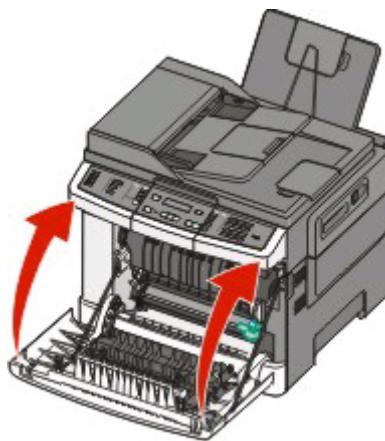

Replacing a black imaging kit

Replace the black imaging kit when **Imaging Kit** appears.

- 1 Grasp the front door at the side handholds, and then pull it toward you.

 **CAUTION—HOT SURFACE:** The inside of the printer might be hot. To reduce the risk of injury from a hot component, allow the surface to cool before touching.

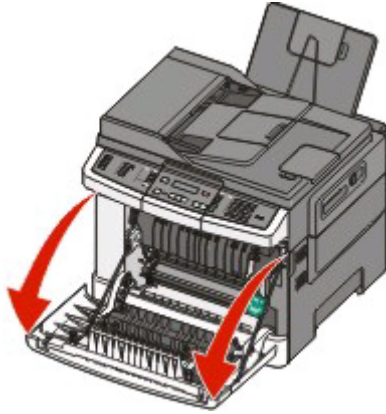

- 2 Open the top door.

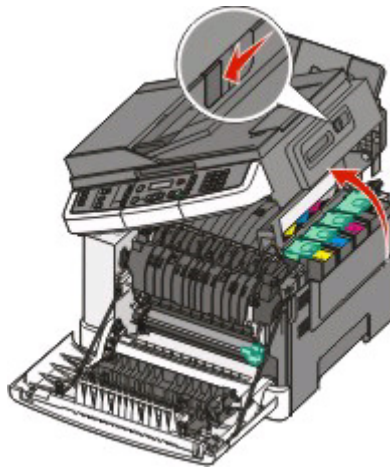

3 Remove the toner cartridges by lifting the handles, and then gently pulling away from the imaging kit.

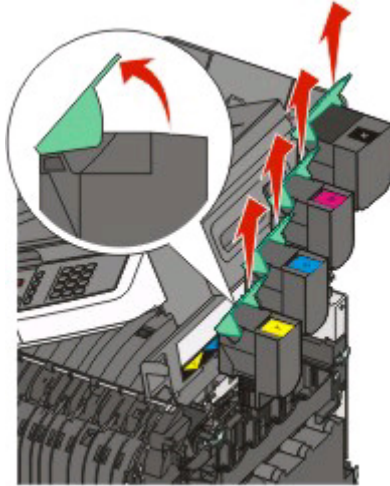

4 Remove the right side cover.

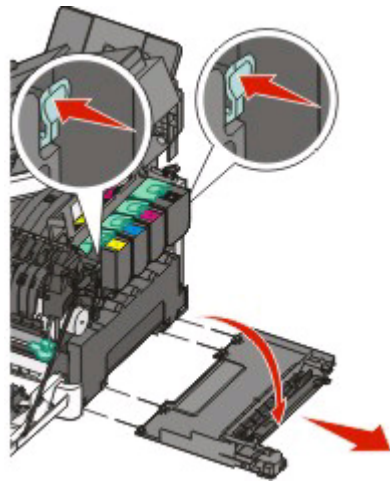

5 Press the green levers on each side of the waste toner bottle, and then remove it.

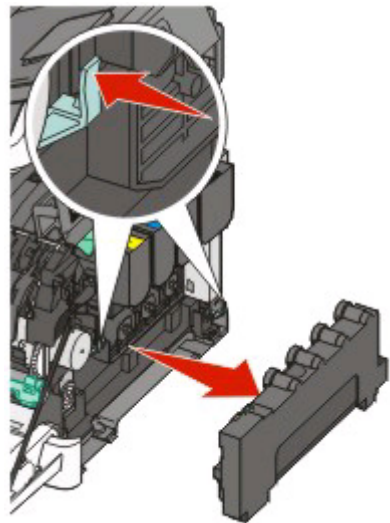

6 Lift the blue levers on the imaging kit, and then pull it toward you.

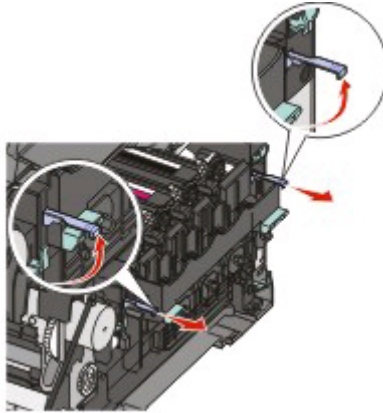

7 Press down on the blue levers, grasp the green handles on the sides, and then pull the imaging kit out.

Warning—Potential Damage: Do not touch the underside of the imaging kit. This could damage the imaging kit.

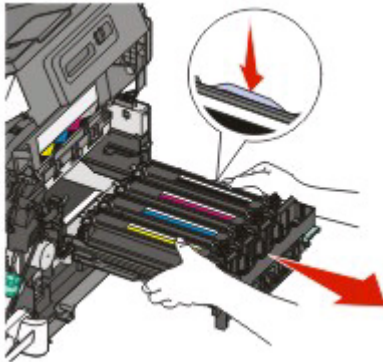

8 Remove the yellow, cyan, and magenta developer units.

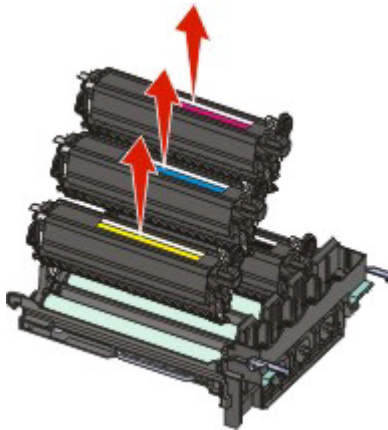

9 Unpack the replacement black imaging kit.

Leave the packaging on the black developer unit.

10 Gently shake the black developer unit side to side.

11 Remove the packaging from the black developer unit.

12 Insert the black developer unit.



13 Replace the yellow, cyan, and magenta developer units.

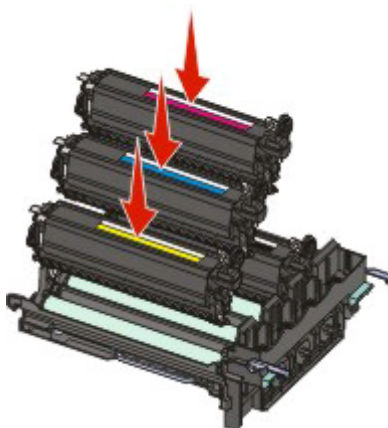

Note: Make sure each developer unit is inserted into a matching color slot.

14 Place the used black imaging kit in the enclosed package.

15 Align and insert the imaging kit.

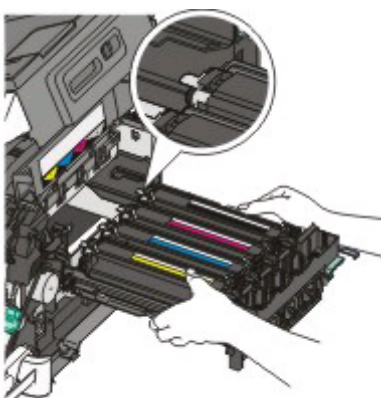

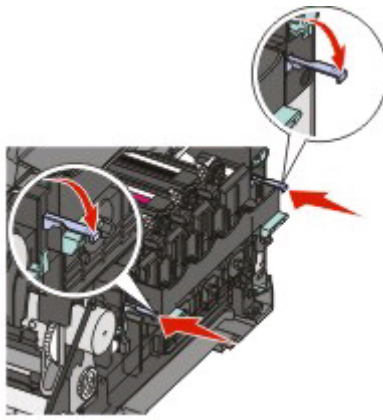

16 Rotate the blue levers down until the imaging kit drops into place.

17 Replace the waste toner bottle.

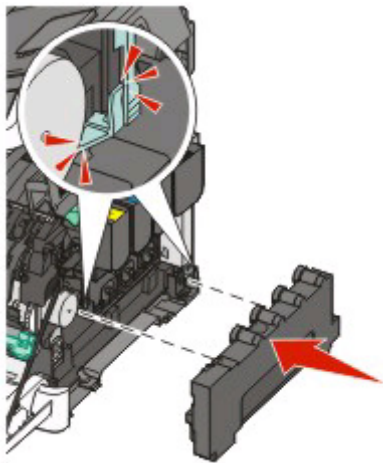

18 Replace the right side cover.

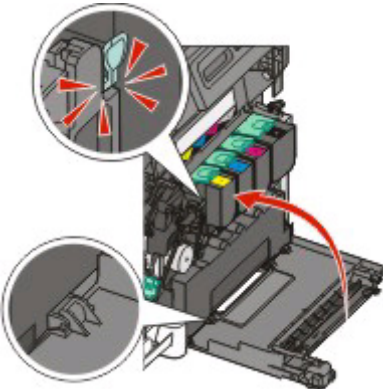

19 Replace the toner cartridges.

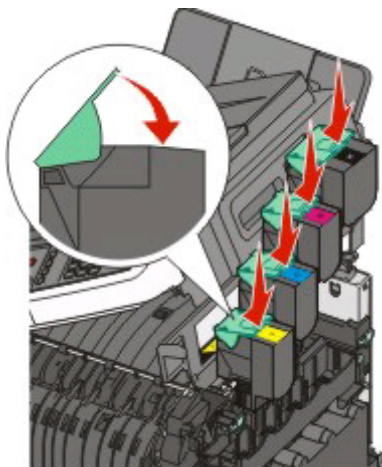

20 Close the top door.

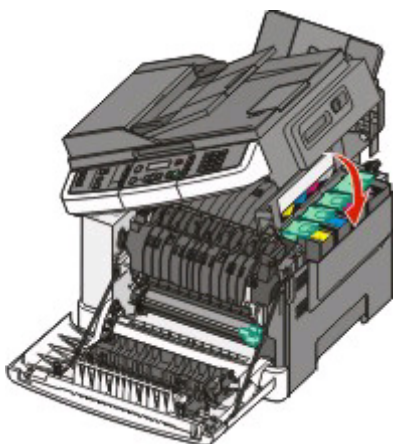

21 Close the front door.

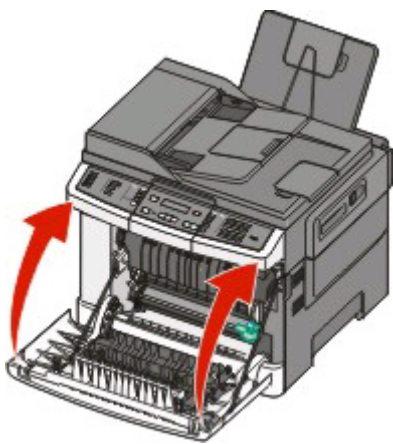

Replacing a black and color imaging kit

Replace the black and color imaging kit when **Imaging Kit** appears.

- 1 Grasp the front door at the side handholds, and then pull it toward you to open it.

 **CAUTION—HOT SURFACE:** The inside of the printer might be hot. To reduce the risk of injury from a hot component, allow the surface to cool before touching.

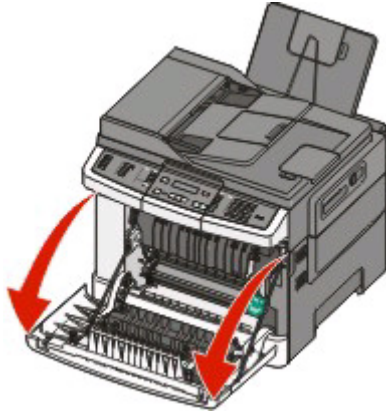

- 2 Open the top door.

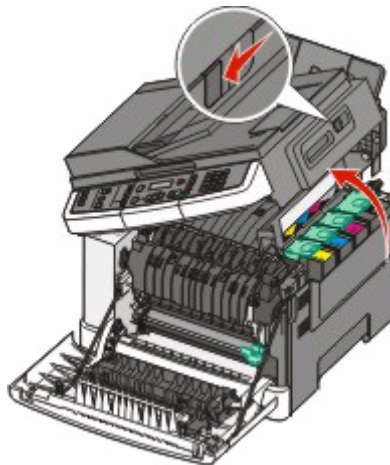

3 Remove the toner cartridges by lifting the handles, and then gently pulling away from the imaging kit.

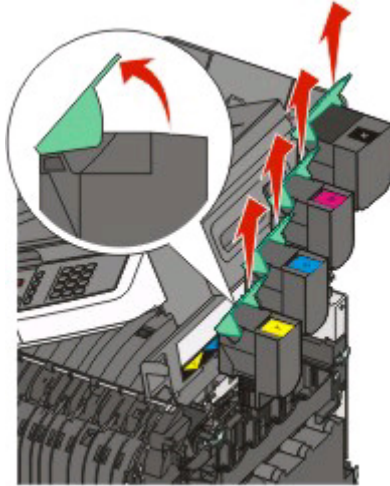

4 Remove the right side cover.

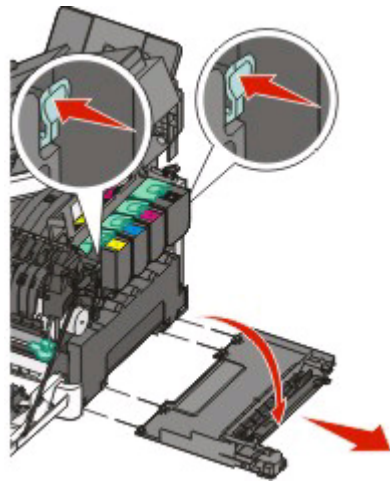

5 Press the green levers on each side of the waste toner bottle, and remove it.

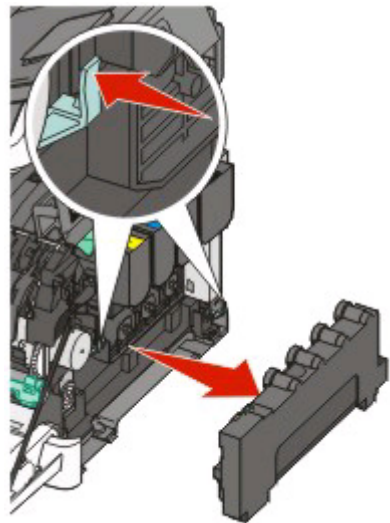

6 Lift the blue levers on the imaging kit, and then pull it toward you.

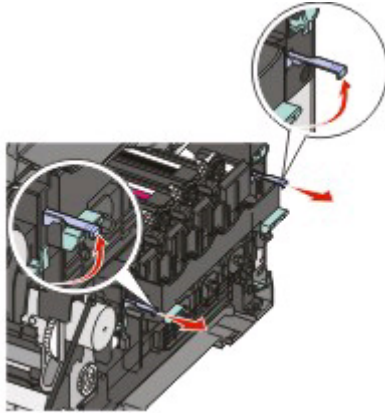

7 Press down on the blue levers, grasp the green handles on the sides, and then pull the imaging kit out.

Warning—Potential Damage: Do not touch the underside of the imaging kit. This could damage the imaging kit.

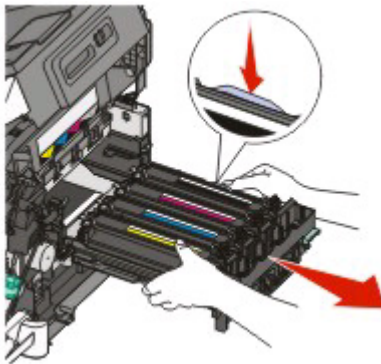

8 Unpack the replacement black and color imaging kit.

Leave the packaging on the developer units.

9 Gently shake the yellow, cyan, magenta, and black developer units side to side.

10 Remove the packaging from the yellow, cyan, magenta, and black developer units.

11 Insert the yellow, cyan, magenta, and black developer units.

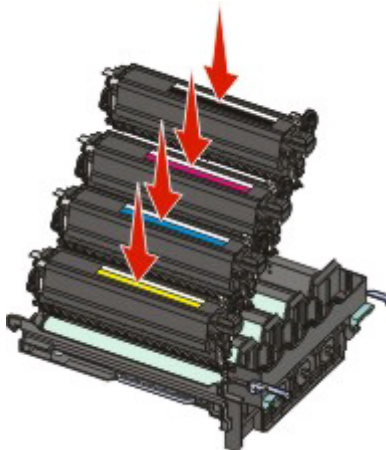

12 Place the used black and color imaging kit in the enclosed package.

13 Align and insert the imaging kit.

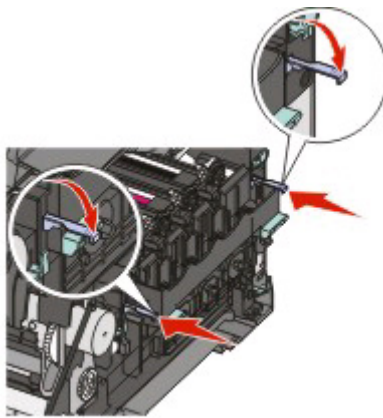
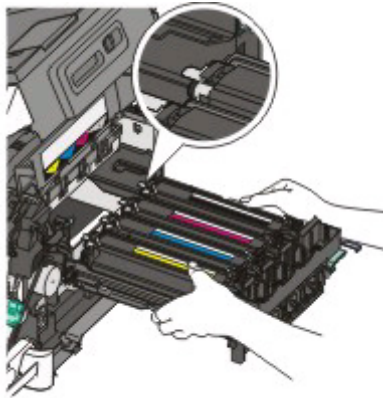

14 Replace the waste toner bottle.

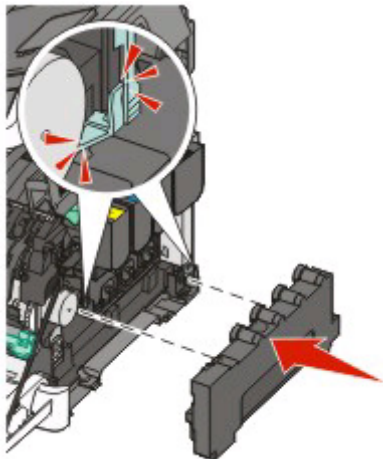

15 Replace the right side cover.

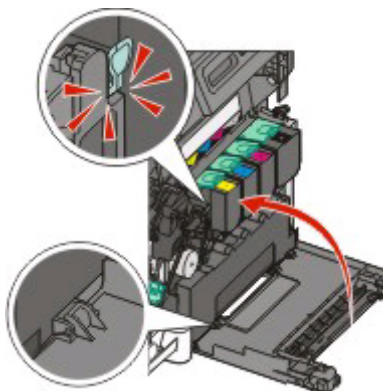

16 Replace the toner cartridges.

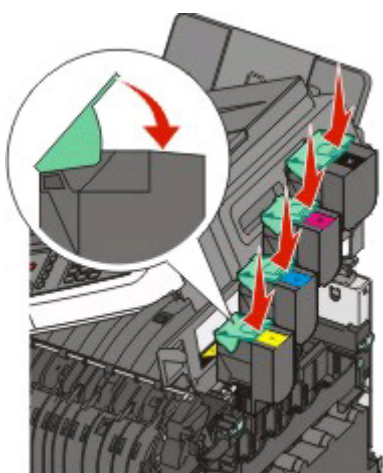

17 Close the top door.

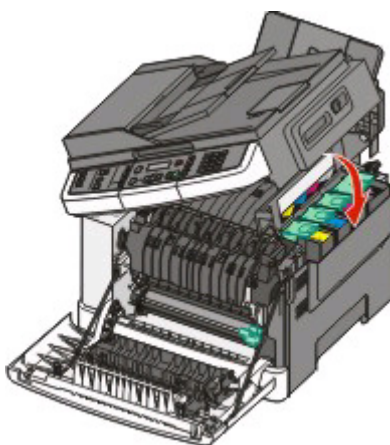

18 Close the front door.

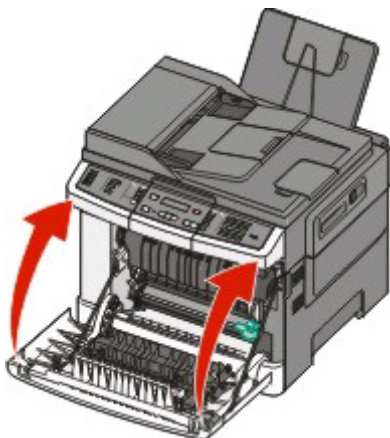

Replacing a toner cartridge

Replace the specified toner cartridge (yellow, cyan, magenta, or black) when **88 Replace <color> Cartridge** appears. The printer will not continue printing until the specified cartridge is replaced.

Warning—Potential Damage: Damage caused by use of a non-Lexmark toner cartridge is not covered under warranty.

Note: Degraded print quality may result from using non-Lexmark toner cartridges.

- 1** Make sure the printer is on and **Ready** or **88 Replace <color> Cartridge** appears.
- 2** Unpack the new cartridge, and set it near the printer.
- 3** Open the top door.

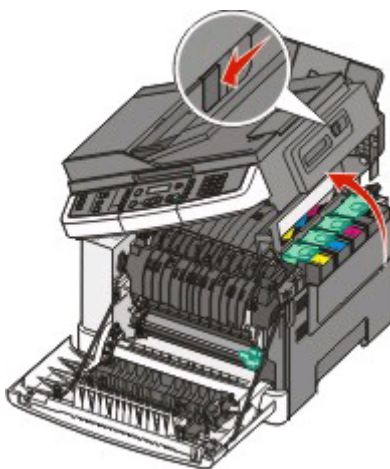

4 Remove the toner cartridge by lifting the handle, and then gently pulling away from the imaging kit.

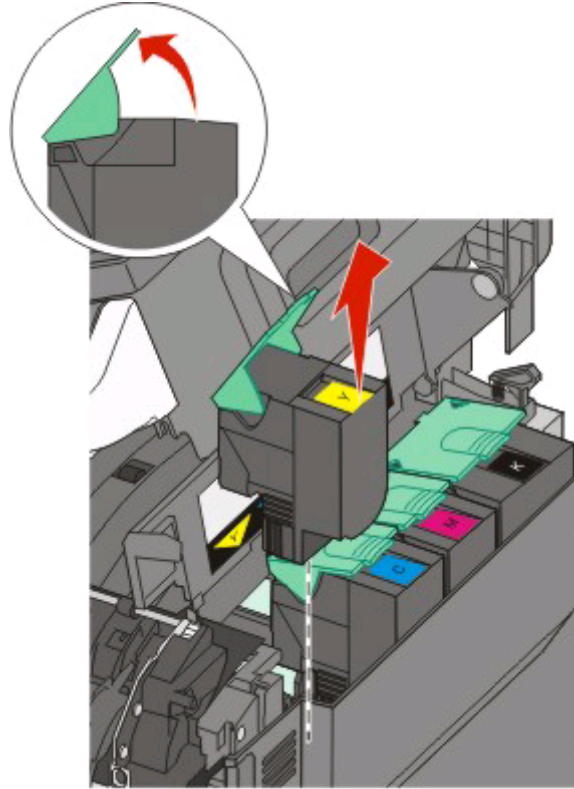

5 Align the new toner cartridge, and then press down until it is all the way into the slot.

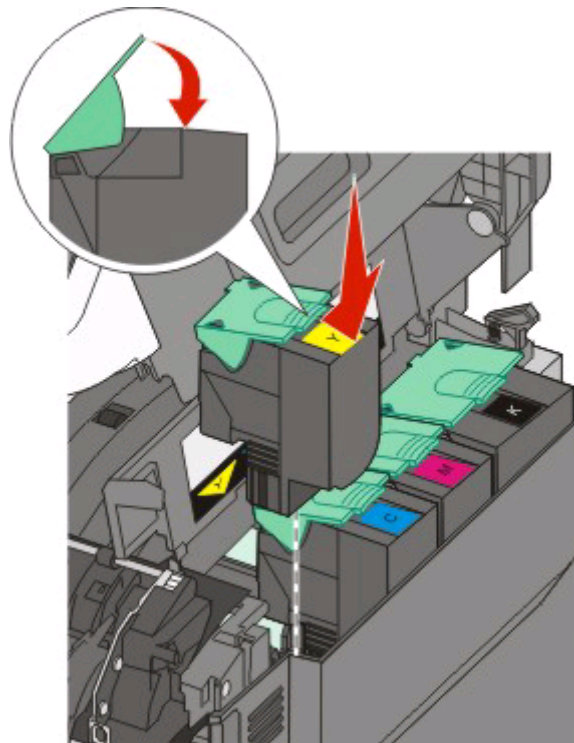

6 Close the top door.

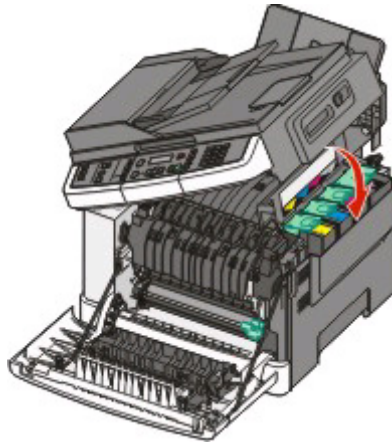

Replacing a developer unit

Replace a developer unit when a print quality defect occurs or when damage occurs to the printer.

1 Grasp the front door at the side handholds, and then pull it toward you to open it.

 **CAUTION—HOT SURFACE:** The inside of the printer might be hot. To reduce the risk of injury from a hot component, allow the surface to cool before touching.

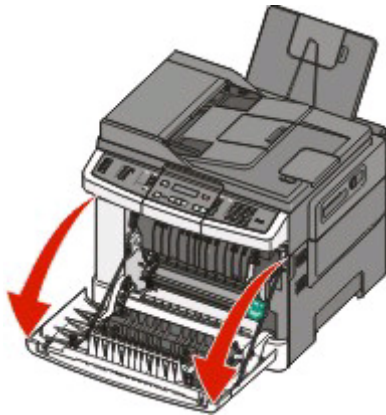

2 Open the top door.

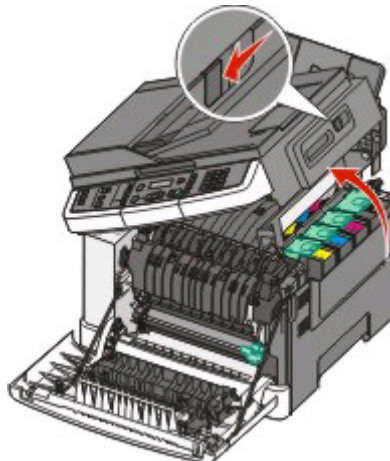

3 Remove the toner cartridges by lifting the handles and then gently pulling away from the imaging kit.

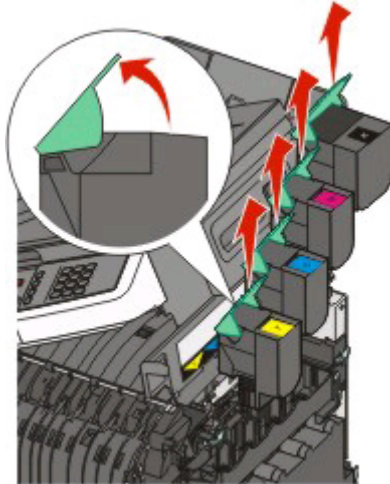

4 Remove the right side cover.

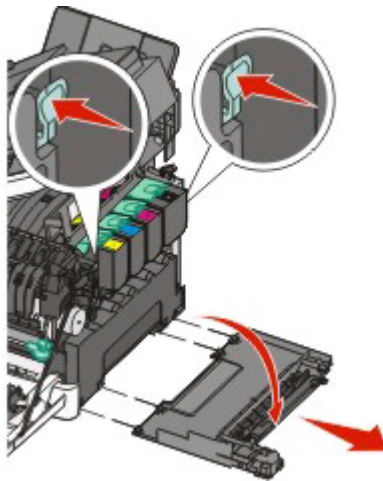

5 Press the green levers on each side of the waste toner bottle, and then remove it.

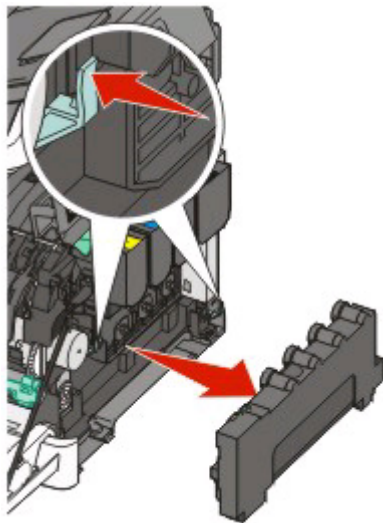

6 Lift the blue levers on the imaging kit, and then pull it toward you.

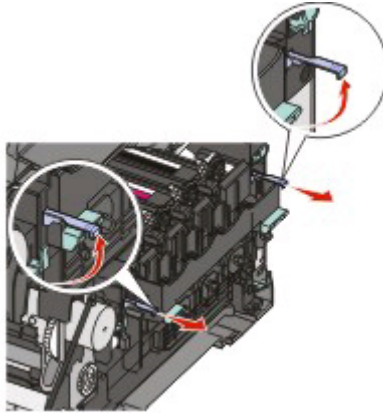

7 Press down on the blue levers, grasp the handles on the sides, and then pull the imaging kit out.

Warning—Potential Damage: Do not touch the underside of the imaging kit. This could damage the imaging kit.

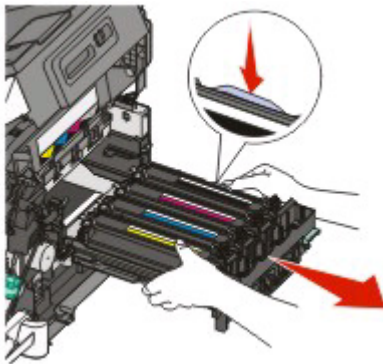

8 Remove the used developer unit.



9 Place the used developer in the enclosed package.

10 Unpack the replacement developer unit.

Leave the packaging on the developer unit.

11 Gently shake the developer unit side to side.

12 Remove the red shipping cover from the developer unit.

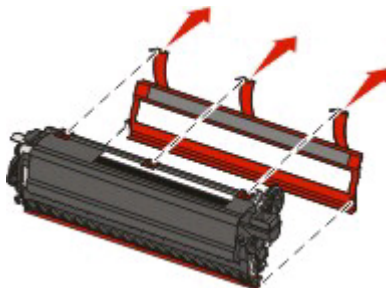

13 Insert the developer unit.



14 Align and insert the imaging kit.

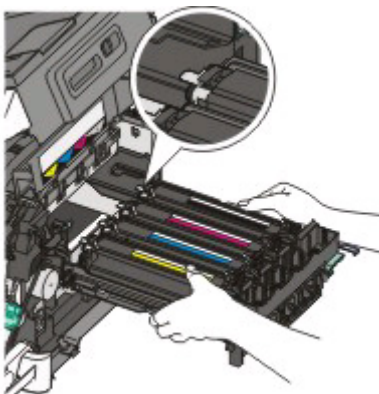

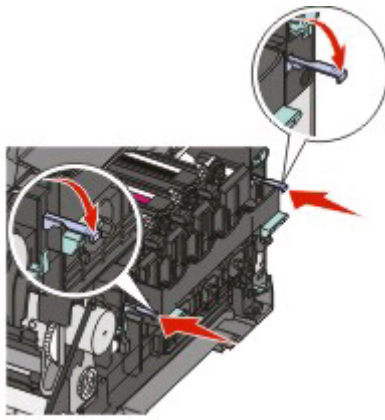

15 Replace the waste toner bottle.

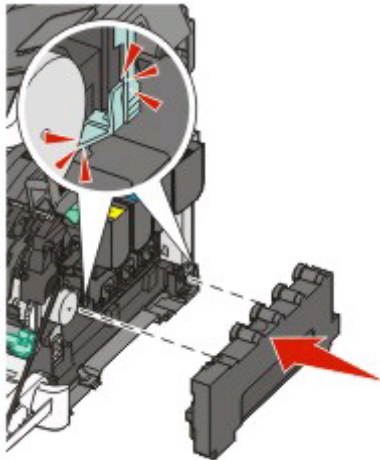

16 Replace the right side cover.

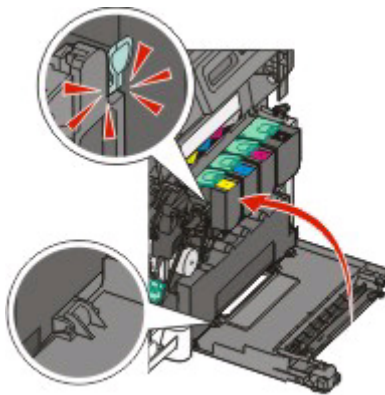

17 Replace the toner cartridges.

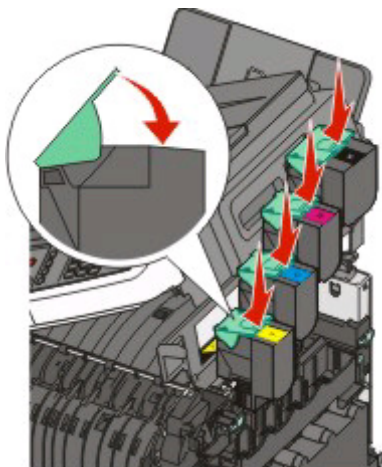

18 Close the top door.

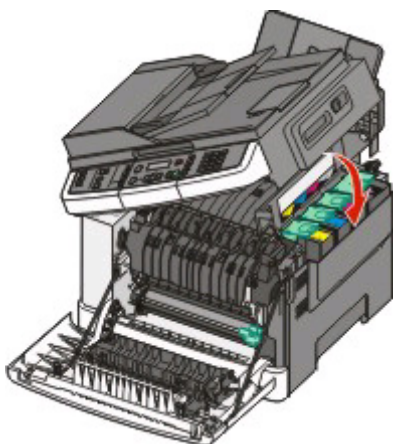

19 Close the front door.

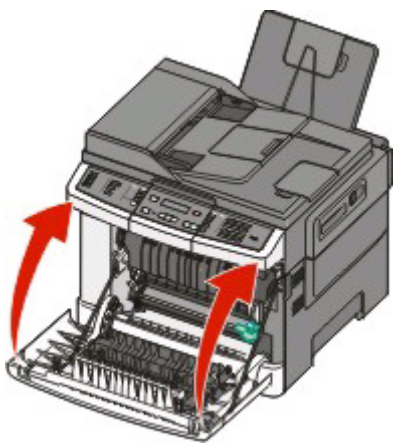

Recycling Lexmark products

To return Lexmark products to Lexmark for recycling:

- 1 If you are returning a print cartridge, place it in the return bag that came with your product.
Note: The return bag is not available in all countries and regions.
- 2 Visit our Web site at www.lexmark.com/recycle.
- 3 Follow the instructions on the computer screen.

Cleaning the exterior of the printer

- 1 Make sure that the printer is turned off and unplugged from the wall outlet.



CAUTION—SHOCK HAZARD: To avoid the risk of electric shock when cleaning the exterior of the printer, unplug the power cord from the wall outlet and disconnect all cables from the printer before proceeding.

- 2 Remove paper from the standard exit tray.
- 3 Dampen a clean, lint-free cloth with water.

Warning—Potential Damage: Do not use household cleaners or detergents, as they may damage the finish of the printer.

- 4 Wipe only the outside of the printer, making sure to include the standard exit tray.

Warning—Potential Damage: Using a damp cloth to clean the interior may cause damage to your printer.

- 5 Make sure the standard exit tray is dry before beginning a new print job.

Cleaning the scanner glass

Clean the scanner glass if you encounter print quality problems, such as streaks on copied or scanned images.

Note: Clean both areas of the scanner glass and both white underside areas.

- 1 Slightly dampen a soft, lint-free cloth or paper towel with water.
- 2 Open the scanner cover.

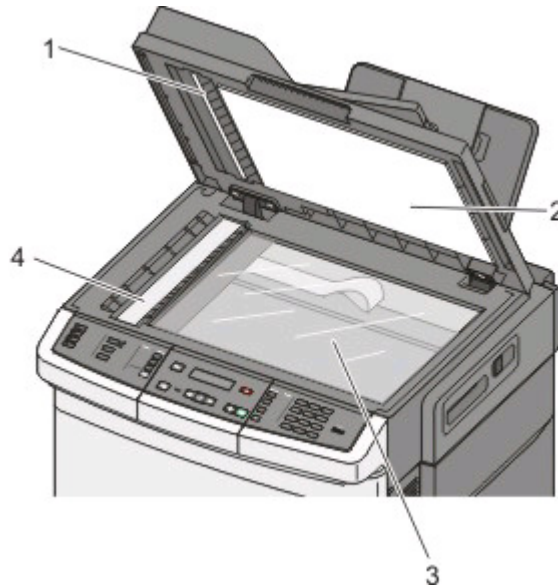

1	White underside ADF cover.
2	White underside scanner glass cover
3	Scanner glass
4	ADF glass

- 3 Wipe the scanner glass until it is clean and dry.
- 4 Wipe the white underside of the scanner cover until it is clean and dry.
- 5 Close the scanner cover.

Moving the printer

Before moving the printer

- CAUTION—POTENTIAL INJURY:** The printer weight is greater than 18 kg (40 lb) and requires two or more trained personnel to move it safely.
- CAUTION—POTENTIAL INJURY:** Before moving the printer, follow these guidelines to avoid personal injury or printer damage:
 - Turn the printer off using the power switch, and then unplug the power cord from the wall outlet.
 - Disconnect all cords and cables from the printer before moving it.

- Lift the printer off of the optional drawer and set it aside instead of trying to lift the drawer and printer at the same time.

Note: Use the handholds located on both sides of the printer to lift it off the optional drawer.

Warning—Potential Damage: Damage to the printer caused by improper moving is not covered by the printer warranty.

Moving the printer to another location

The printer and options can be safely moved to another location by following these precautions:

- Any cart used to move the printer must have a surface able to support the full footprint of the printer. Any cart used to move the options must have a surface able to support the dimensions of the options.
- Keep the printer in an upright position.
- Avoid severe jarring movements.

Shipping the printer

When shipping the printer, use the original packaging or call the place of purchase for a relocation kit.







Administrative support

Finding advanced networking and administrator information

This chapter covers basic administrative support tasks. For more advanced system support tasks, see the *Networking Guide* on the *Software and Documentation* CD and the *Embedded Web Server Administrator's Guide* on the Lexmark Web site at www.lexmark.com.

Restoring the factory default settings





Menu settings marked with an asterisk (*) indicate the active settings. You can restore the original printer settings, often referred to as the *factory default settings*.

- 1 Make sure the printer is on and **Ready** appears.
- 2 From the printer control panel, press .
- 3 Press the arrow buttons until **Settings** appears, and then press .
- 4 Press the arrow buttons until **General Settings** appears, and then press .
- 5 Press the arrow buttons until **Factory Defaults** appears, and then press .
- 6 Press the arrow buttons until **Restore Now** appears, and then press .
Submitting changes appears briefly.
- 7 Press , and then press  until **Ready** appears.

The following factory default settings are restored:



- All downloaded resources in the printer memory are deleted. This includes fonts, macros, and symbol sets.
- All settings return to the factory default settings except **Printer Language** in the Setup menu and custom settings in the Network and USB menus.

Adjusting Power Saver

- 1 Make sure the printer is on and **Ready** appears.
- 2 From the printer control panel, press .
- 3 Press the arrow buttons until **Settings** appears, and then press .
- 4 Press the arrow buttons until **General Settings** appears, and then press .
- 5 Press the arrow buttons until **Timeout** appears, and then press .
- 6 Press the arrow buttons until **Power Saver** appears, and then press .
- 7 Press the arrow buttons to enter the number of minutes for the printer to wait before entering the Power Saver mode. Available settings range from 1–240 minutes.

8 Press .

Submitting changes appears.

9 Press , and then press  until **Ready** appears.

Note: Power Saver settings can also be adjusted by typing the printer IP address into the address field of your Web browser.

Using the Embedded Web Server

If the printer is installed on a network, the Embedded Web Server is available for a range of functions:

- Configuring printer settings
- Checking the status of the printer supplies
- Configuring network settings
- Viewing reports
- Restoring the factory default settings
- Viewing the virtual display
- Setting Web page password protect
- Setting Panel PIN protect
- Setting the date and time

To access the Embedded Web Server:

1 Type the printer IP address into the address field of your Web browser.

Note: If you do not know the IP address of the printer, then print a network setup page and locate the IP address in the TCP/IP section.

2 Click one of the tabs to access information about the printer, change settings, or view a report.

Note: If the printer is connected to a computer by a USB or parallel cable, then open the Local Printer Settings Utility for Windows or Printer Settings for Macintosh to access printer menus.

Setting up e-mail alerts

You can have the printer send you an e-mail when the supplies are getting low or when the paper needs to be changed, added, or unjammed.

To set up e-mail alerts:

1 Type the printer IP address into the address field of your Web browser.

Note: If you do not know the IP address of the printer, then print a network setup page and locate the IP address in the TCP/IP section.

2 Click **Settings**.

3 Under Other Settings, click **E-mail Alert Setup**.

4 Select the items for notification and type in the e-mail addresses that you want to receive e-mail alerts.

5 Click **Submit**.

Note: See your system support person to set up the e-mail server.

Viewing reports

You can view some reports from the Embedded Web Server. These reports are useful for assessing the status of the printer, the network, and supplies.

To view reports from a network printer:

1 Type the printer IP address into the address field of your Web browser.

Note: If you do not know the IP address of the printer, then print a network setup page and locate the IP address in the TCP/IP section.

2 Click **Reports**, and then click the type of report you want to view.

Troubleshooting

Solving basic printer problems

If there are basic printer problems, or the printer is unresponsive, make sure:

- The power cord is plugged into the printer and a properly grounded electrical outlet.
- The electrical outlet is not turned off by any switch or breaker.
- The printer is not plugged into any surge protectors, uninterrupted power supplies, or extension cords.
- Other electronic equipment plugged into the outlet is working.
- The printer is turned on. Check the printer power switch.
- The printer cable is securely attached to the printer and the host computer, print server, option, or other network device.
- All options are properly installed.
- The printer driver settings are correct.

Once you have checked each of these possibilities, turn the printer off, wait for about 10 seconds, and then turn the printer back on. This often fixes the problem.

Solving printing problems

Multiple-language PDFs do not print

The documents contain unavailable fonts.

- 1 Open the document you want to print in Adobe Acrobat.
- 2 Click the printer icon.
The Print dialog appears.
- 3 Select **Print as image**.
- 4 Click **OK**.

Printer control panel display is blank or displays only diamonds

The printer self test failed. Turn the printer off, wait about 10 seconds, and then turn the printer back on.

If **Performing Self Test** and **Ready** do not appear, turn the printer off and contact Customer Support.

Error message about reading USB drive appears

Make sure the USB drive is supported. For information regarding tested and approved USB flash memory devices, visit the Lexmark Web site at www.lexmark.com.

Jobs do not print

These are possible solutions. Try one or more of the following:

MAKE SURE THE PRINTER IS READY TO PRINT

Make sure **Ready** or **Power Saver** appears on the display before sending a job to print. Press  to return the printer to the **Ready** state.

CHECK TO SEE IF THE STANDARD EXIT BIN IS FULL

Remove the stack of paper from the standard exit bin, and then press .

CHECK TO SEE IF THE PAPER TRAY IS EMPTY

Load paper in the tray.

MAKE SURE THE PRINTER IS CONNECTED TO THE NETWORK

Print a network setup page and check that the status shows **Connected**. If the status is **Not Connected**, check the network cables, and then try printing the network setup page again. Contact your system support person to make sure the network is functioning correctly.

Copies of the printer software are also available on the Lexmark Web site at www.lexmark.com.

MAKE SURE YOU ARE USING A RECOMMENDED USB OR ETHERNET CABLE

For more information, visit the Lexmark Web site at www.lexmark.com.

MAKE SURE PRINTER CABLES ARE SECURELY CONNECTED

Check the cable connections to the printer and print server to make sure they are secure.

For more information, see the setup documentation that came with the printer.





Job takes longer than expected to print

These are possible solutions. Try one or more of the following:

REDUCE THE COMPLEXITY OF THE PRINT JOB

Eliminate the number and size of fonts, the number and complexity of images, and the number of pages in the job.

CHANGE THE PAGE PROTECT SETTING TO OFF

- 1 From the printer control panel, press .
- 2 Press the arrow buttons until **Settings** appears, and then press .
- 3 Press the arrow buttons until **Setup Menu** appears, and then press .
- 4 Press the arrow buttons until **Print Recovery** appears, and then press .

5 Press the arrow buttons until **Page Protect** appears, and then press .

6 Press the arrow buttons until **Off** appears, and then press .

Job prints from the wrong tray or on the wrong paper

CHECK THE PAPER TYPE SETTING

Make sure the Paper Type setting matches the paper loaded in the tray.

Incorrect characters print

Make sure the printer is not in Hex Trace mode. If **Ready Hex** appears on the display, you must exit Hex Trace mode before you can print your job. Turn the printer off and back on to exit Hex Trace mode.

Tray linking does not work

These are possible solutions. Try one or more of the following:

Note: The paper trays, manual feeder, and multipurpose feeder do not automatically sense the paper size. You must set the size from the Paper Size/Type menu.

LOAD THE SAME SIZE AND TYPE OF PAPER

- Load the same size and type of paper in each tray to be linked.
- Move the paper guides to the correct positions for the paper size loaded in each tray.

USE THE SAME PAPER SIZE AND PAPER TYPE SETTINGS

- Print a menu settings page and compare the settings for each tray.
- If necessary, adjust the settings from the Paper Size/Type menu.

Large jobs do not collate

These are possible solutions. Try one or more of the following:

MAKE SURE COLLATE IS SET TO ON

From the printer control panel Finishing menu, Print Properties, or the Print dialog, set Collate to On.

Note: Setting Collate to Off in the software overrides the setting in the Finishing menu.

REDUCE THE COMPLEXITY OF THE PRINT JOB







Reduce the complexity of the print job by eliminating the number and size of fonts, the number and complexity of images, and the number of pages in the job.

MAKE SURE THE PRINTER HAS ENOUGH MEMORY

Add printer memory.

Unexpected page breaks occur

Increase the Print Timeout value:

- 1 From the printer control panel, press .
- 2 Press the arrow buttons until **Settings** appears, and then press .
- 3 Press the arrow buttons until **General Settings** appears, and then press .
- 4 Press the arrow buttons until **Timeouts** appears, and then press .
- 5 Press the arrow buttons until **Print Timeout** appears, and then press .
- 6 Press the arrow buttons until the desired value appears, and then press .

Solving copy problems

Copier does not respond

These are possible solutions. Try one or more of the following:

CHECK THE DISPLAY FOR ERROR MESSAGES

Clear any error messages.

CHECK THE POWER

Make sure the printer is plugged in, the power is on, and **Ready** appears.

Scanner unit does not close

Make sure there are no obstructions:

- 1 Open the scanner cover.
- 2 Remove any obstruction keeping the scanner unit open.
- 3 Close the scanner cover.

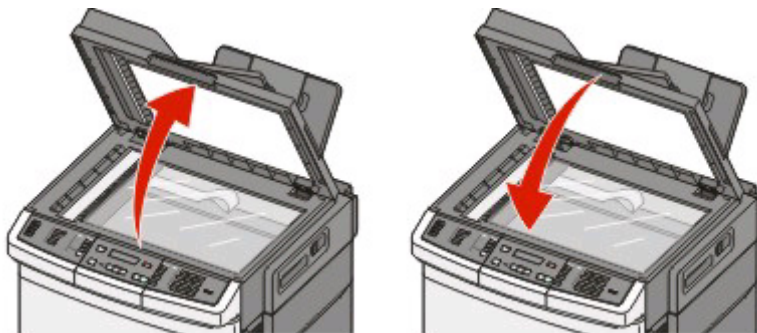

Poor copy quality

These are some examples of poor copy quality:

- Blank pages
- Checkerboard pattern
- Distorted graphics or pictures
- Missing characters
- Faded print
- Dark print
- Skewed lines
- Smudges
- Streaks
- Unexpected characters
- White lines in print

These are possible solutions. Try one or more of the following:

CHECK THE DISPLAY FOR ERROR MESSAGES

Clear any error messages.

THE TONER MAY BE LOW

When **88 Cartridge low** appears or when the print becomes faded, replace the toner cartridge.

THE SCANNER GLASS MAY BE DIRTY

Clean the scanner glass with a clean, lint-free cloth dampened with water.

THE COPY IS TOO LIGHT OR TOO DARK

Adjust the copy darkness setting.

CHECK THE QUALITY OF THE ORIGINAL DOCUMENT

Make sure the quality of the original document is satisfactory.

CHECK THE DOCUMENT PLACEMENT

Make sure the document or photo is loaded facedown on the scanner glass in the upper left corner.

UNWANTED TONER IS IN THE BACKGROUND

- Adjust the darkness to a lighter setting.
- Change the **Background Removal** setting in the **Copy Settings** menu.

PATTERNS (MOIRÉ) APPEAR IN THE OUTPUT

- From the printer control panel, press the **Content** button until the light comes on next to Text/Photo or Photo.
- Rotate the original document on the scanner glass.
- From the printer control panel, press the **Scale** button and adjust the setting.

TEXT IS LIGHT OR DISAPPEARING

From the printer control panel, press the **Content** button until the light comes on next to Text or Text/Photo.

THE OUTPUT APPEARS WASHED OUT OR OVEREXPOSED

- From the printer control panel, press the **Content** button until the light comes on next to Text/Photo or Photo.
- From the printer control panel, press the **Darkness** button and change to a darker setting.

Partial document or photo copies

These are possible solutions. Try one or more of the following:

CHECK THE DOCUMENT PLACEMENT

Make sure the document or photo is loaded facedown on the scanner glass in the upper left corner.

CHECK THE PAPER SIZE SETTING

Make sure the Paper Size setting matches the paper loaded in the tray.

Solving scanner problems

Checking an unresponsive scanner

If your scanner is not responding, then make sure:

- The printer is turned on.
- The printer cable is securely attached to the printer and the host computer, print server, option, or other network device.
- The power cord is plugged into the printer and a properly grounded electrical outlet.
- The electrical outlet is not turned off by any switch or breaker.
- The printer is not plugged into any surge protectors, uninterrupted power supplies, or extension cords.
- Other electrical equipment plugged into the outlet is working.

Once you have checked each of these possibilities, turn the printer off and then back on. This often fixes the problem with the scanner.

Scan was not successful

These are possible solutions. Try one or more of the following:

CHECK THE CABLE CONNECTIONS

Make sure the network or USB cable is securely connected to the computer and the printer.

AN ERROR MAY HAVE OCCURRED IN THE PROGRAM

Turn off and then restart the computer.

Scanning takes too long or freezes the computer

These are possible solutions. Try one or more of the following:

OTHER SOFTWARE PROGRAMS MAY BE INTERFERING WITH SCANNING

Close all programs not being used.

THE SCAN RESOLUTION MAY BE SET TOO HIGH

Select a lower scan resolution.

Poor scanned image quality

These are possible solutions. Try one or more of the following:

CHECK THE DISPLAY FOR ERROR MESSAGES

Clear any error messages.

THE SCANNER GLASS MAY BE DIRTY

Clean the scanner glass with a clean, lint-free cloth dampened with water. For more information, see "Cleaning the scanner glass" on page 188.

ADJUST THE SCAN RESOLUTION

Increase the resolution of the scan for a higher quality output.

CHECK THE QUALITY OF THE ORIGINAL DOCUMENT

Make sure the quality of the original document is satisfactory.

CHECK THE DOCUMENT PLACEMENT

Make sure the document or photo is loaded facedown on the scanner glass in the upper left corner.

Partial document or photo scans

These are possible solutions. Try one or more of the following:

CHECK THE DOCUMENT PLACEMENT

Make sure the document or photo is loaded facedown on the scanner glass in the upper left corner.

CHECK THE PAPER SIZE SETTING

Make sure the paper size setting matches the paper loaded in the tray:

- 1 From the printer control panel, check the Paper Size setting from the Paper menu.
- 2 Before sending the job to print, specify the correct size setting:
 - For Windows users, specify the size from Print Properties.
 - For Macintosh users, specify the size from the Page Setup dialog.

Cannot scan from a computer

These are possible solutions. Try one or more of the following:

CHECK THE DISPLAY FOR ERROR MESSAGES

Clear any error messages.

CHECK THE POWER

Make sure the printer is plugged in, the power is on, and **Ready** appears.

CHECK THE CABLE CONNECTIONS

Make sure the network or USB cable is securely connected to the computer and the printer.

Solving fax problems

Caller ID is not shown

Contact your telecommunications company to verify that your telephone line is subscribed to the caller ID service.

If your region supports multiple caller ID patterns, you may have to change the default setting. There are two settings available: FSK (pattern 1) and DTMF (pattern 2). The availability of these settings by way of the Fax menu depends on whether your country or region supports multiple caller ID patterns. Contact your telecommunications company to determine which pattern or switch setting to use.

Cannot send or receive a fax

These are possible solutions. Try one or more of the following:

CHECK THE DISPLAY FOR ERROR MESSAGES

Clear any error messages.

CHECK THE POWER

Make sure the printer is plugged in, the power is on, and **Ready** appears.

CHECK THE PRINTER CONNECTIONS

Make sure the cable connections for the following hardware are secure, if applicable:

- Telephone
- Handset
- Answering machine

CHECK THE TELEPHONE WALL JACK

- 1 Plug a telephone into the wall jack.
- 2 Listen for a dial tone.
- 3 If you do not hear a dial tone, then plug a different telephone into the wall jack.
- 4 If you still do not hear a dial tone, then plug a telephone into a different wall jack.
- 5 If you hear a dial tone, then connect the printer to that wall jack.

REVIEW THIS DIGITAL PHONE SERVICE CHECKLIST

The fax modem is an analog device. Certain devices can be connected to the printer so that digital telephone services can be used.

- If you are using an ISDN telephone service, then connect the printer to an analog telephone port (an R-interface port) on an ISDN terminal adapter. For more information and to request an R-interface port, contact your ISDN provider.
- If you are using DSL, then connect to a DSL filter or router that will support analog use. For more information, contact your DSL provider.
- If you are using a PBX telephone service, then make sure you are connecting to an analog connection on the PBX. If none exists, consider installing an analog telephone line for the fax machine.

CHECK FOR A DIAL TONE

- Place a test call to the telephone number to which you want to send a fax to make sure that it is working correctly.
- If the telephone line is being used by another device, then wait until the other device is finished before sending a fax.
- If you are using the On Hook Dial feature, then turn up the volume to verify a dial tone.

TEMPORARILY DISCONNECT OTHER EQUIPMENT

To ensure the printer is working correctly, connect it directly to the telephone line. Disconnect any answering machines, computers with modems, or telephone line splitters.

CHECK FOR JAMS

Clear any jams, and then make sure that **Ready** appears.

TEMPORARILY DISABLE CALL WAITING

Call Waiting can disrupt fax transmissions. Disable this feature before sending or receiving a fax. Call your telephone company to obtain the keypad sequence for temporarily disabling Call Waiting.

VOICE MAIL SERVICE MAY BE INTERFERING WITH THE FAX TRANSMISSION

Voice Mail offered through your local telephone company may disrupt fax transmissions. To enable both Voice Mail and the printer to answer calls, you may want to consider adding a second telephone line for the printer.

THE PRINTER MEMORY MAY BE FULL

- 1 Dial the fax number.
- 2 Scan the original document one page at a time.

Can send but not receive faxes

These are possible solutions. Try one or more of the following:

CHECK TO SEE IF THE PAPER TRAY IS EMPTY

Load paper in the tray.

CHECK THE RING COUNT DELAY SETTINGS

The ring count delay sets the number of times the phone line rings before the printer answers. If you have extension phones on the same line as the printer, or subscribe to the telephone company's Distinctive Ring service, then keep the Ring Delay setting at 4.

- 1 Type the printer IP address into the address field of your Web browser.
Note: If you do not know the IP address of the printer, then print a network setup page and locate the IP address in the TCP/IP section.
- 2 Click **Settings**.
- 3 Click **Fax Settings**.
- 4 Click **Analog Fax Setup**.
- 5 In the Rings to Answer box, enter the number of times you want the phone to ring before answering.
- 6 Click **Submit**.

THE TONER MAY BE LOW

88 <color> toner low appears when the toner is low.

Can receive but not send faxes

These are possible solutions. Try one or more of the following:

MAKE SURE THE PRINTER IS IN FAX MODE

From the printer control panel, press the **Fax** button to put the printer in Fax mode.

MAKE SURE THE DOCUMENT IS LOADED PROPERLY

Load the original document faceup, short edge first into the ADF or facedown on the scanner glass in the upper left corner.

Note: Do not load postcards, photos, small items, transparencies, photo paper, or thin media (such as magazine clippings) into the ADF. Place these items on the scanner glass.

MAKE SURE THE SHORTCUT NUMBER IS SET UP PROPERLY

- Check to make sure the shortcut number has been programmed for the number that you want to dial.
- As an alternative, dial the telephone number manually.

Received fax has poor print quality

These are possible solutions. Try one or more of the following:

RE-SEND THE DOCUMENT

Ask the person who sent you the fax to:

- Check that the quality of the original document is satisfactory.
- Resend the fax. There may have been a problem with the quality of the telephone line connection.
- Increase the fax scan resolution, if possible.

THE TONER MAY BE LOW

When 88 <color> toner low appears or when you experience faded print, replace the cartridge(s).

MAKE SURE THE FAX TRANSMISSION SPEED IS NOT SET TOO HIGH

Decrease the incoming fax transmission speed:

- 1 Type the printer IP address into the address field of your Web browser.

Note: If you do not know the IP address of the printer, then print a network setup page and locate the IP address in the TCP/IP section.

- 2 Click **Configuration**.

- 3 Click **Fax Settings**.

- 4 Click **Analog Fax Setup**.
- 5 In the Max Speed box, click on one of the following:
 - 2400
 - 4800
 - 9600
 - 14400
 - 33600
- 6 Click **Submit**.

Blocking junk faxes

- 1 Type the printer IP address into the address field of your Web browser.

Note: If you do not know the IP address of the printer, then print a network setup page and locate the IP address in the TCP/IP section.
- 2 Click **Configuration**.
- 3 Click **Fax Settings**.
- 4 Click **Analog Fax Setup**.
- 5 Click the **No Name Fax** option.

This option blocks all incoming faxes that have a private caller ID or no fax station name.
- 6 In the Banned Fax List field, enter the phone numbers or fax station names of specific fax callers you want to block.

Solving option problems

Option does not operate correctly or quits after it is installed

These are possible solutions. Try one or more of the following:

RESET THE PRINTER

Turn the printer off, wait about 10 seconds, and then turn the printer on.

CHECK TO SEE IF THE OPTION IS CONNECTED TO THE PRINTER

- 1 Turn the printer off.
- 2 Unplug the printer.
- 3 Check the connection between the option and the printer.

MAKE SURE THE OPTION IS INSTALLED CORRECTLY

Print a menu settings page and check to see if the option is listed in the Installed Options list. If the option is not listed, then reinstall it. For more information, see the hardware setup documentation that came with the option, or go to www.lexmark.com/publications to view the option instruction sheet.

MAKE SURE THE OPTION IS SELECTED

From the computer you are printing from, select the option. For more information, see “Updating available options in the printer driver” on page 34.

Drawers

MAKE SURE THE PAPER IS LOADED CORRECTLY

- 1 Open the paper tray.
- 2 Check for paper jams or misfeeds.
- 3 Make sure paper guides are aligned against the edges of the paper.
- 4 Make sure the paper tray closes properly.
- 5 Close the door.

RESET THE PRINTER

Turn the printer off. Wait 10 seconds. Turn the printer back on.

Multipurpose feeder

CHECK THE MULTIPURPOSE FEEDER

Make sure the 650-sheet duo drawer (multipurpose feeder) is installed properly.

CLEAR ANY JAMS

Clear any jams in the multipurpose feeder.

CHECK THE POWER CORD CONNECTION

Make sure:

- The power cord is plugged into the printer and a properly grounded electrical outlet.
- The outlet has power.

CHECK THE PAPER

Use recommended paper and specialty media. For more information, see the chapter about paper and specialty media guidelines.

CHECK THE PAPER GUIDES

Move the guides in the tray to the correct position for the size loaded.

CHECK FOR SERVICE MESSAGES

If a service message appears, turn the printer off, wait about 10 seconds, and then turn the printer back on. If the error recurs, call for service.

Memory card

Make sure the memory card is securely connected to the printer system board.

Solving paper feed problems

Paper frequently jams

These are possible solutions. Try one or more of the following:

CHECK THE PAPER

Use recommended paper and specialty media. For more information, see the chapter about paper and specialty media guidelines.

MAKE SURE THERE IS NOT TOO MUCH PAPER IN THE PAPER TRAY

Make sure the stack of paper you load does not exceed the maximum stack height indicated in the tray or on the multipurpose feeder.

CHECK THE PAPER GUIDES

Move the guides in the tray to the correct positions for the paper size loaded.

THE PAPER MAY HAVE ABSORBED MOISTURE DUE TO HIGH HUMIDITY





- Load paper from a fresh package.
- Store paper in its original wrapper until you use it.

Paper jam message remains after jam is cleared

The paper path is not clear. Clear jammed paper from the entire paper path, and then press .

Page that jammed does not reprint after you clear the jam

In the Setup menu, Jam Recovery is set to Off. Set Jam Recovery to Auto or On:

- 1 Press .
- 2 Press the arrow buttons until **Settings** appears, and then press .
- 3 Press the arrow buttons until **General settings** appears, and then press .
- 4 Press the arrow buttons until **Print Recovery** appears, and then press .

5 Press the arrow buttons until **Jam Recovery** appears, and then press .

6 Press the arrow buttons until **On** or **Auto** appears, and then press .

Solving print quality problems

The information in the following topics may help you solve print quality problems. If these suggestions still do not correct the problem, contact Customer Support. You may have a printer part that requires adjustment or replacement.

Blank pages

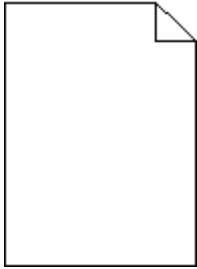

These are possible solutions. Try one or more of the following:

PACKING MATERIAL MAY BE ON THE PRINT CARTRIDGE

Remove the print cartridge and make sure the packing material is properly removed. Reinstall the print cartridge.

THE TONER MAY BE LOW

When **88 Cartridge low** appears, order a new print cartridge.

If the problem continues, the printer may need to be serviced. For more information, contact Customer Support.

Characters have jagged or uneven edges



If you are using downloaded fonts, verify that the fonts are supported by the printer, the host computer, and the software program.

Clipped images

These are possible solutions. Try one or more of the following:

CHECK THE GUIDES

Move the width and length guides in the tray to the correct positions for the paper size loaded.

CHECK THE PAPER SIZE SETTING

Make sure the paper size setting matches the paper loaded in the tray:

- 1 From the printer control panel, check the Paper Size setting from the Paper menu.
- 2 Before sending the job to print, specify the correct size setting:
 - For Windows users, specify the size from Print Properties.
 - For Macintosh users, specify the size from the Page Setup dialog.

Dark lines



The imaging kit may be defective.

If **Black and color imaging kit life warning** or **Black imaging kit life warning** appears, replace the imaging kit.

Gray background

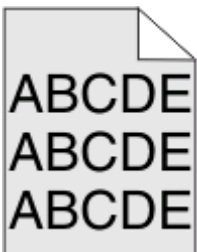

CHECK THE TONER DARKNESS SETTING

Select a lighter Toner Darkness setting:

- From the printer control panel, change the setting from the Quality menu.
- For Windows users, change the setting from Print Properties.
- For Macintosh users, change the setting from the Print dialog.

Incorrect margins

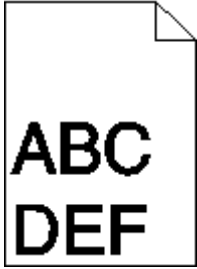

These are possible solutions. Try one or more of the following:

CHECK THE PAPER GUIDES

Move the guides in the tray to the correct positions for the paper size loaded.

CHECK THE PAPER SIZE SETTING

Make sure the paper size setting matches the paper loaded in the tray:

- 1 From the printer control panel, check the Paper Size setting from the Paper menu.
- 2 Before sending the job to print, specify the correct size setting:
 - For Windows users, specify the size from Print Properties.
 - For Macintosh users, specify the size from the Page Setup dialog.

Light colored line, white line, or incorrectly colored line



These are possible solutions. Try one or more of the following:

A TONER CARTRIDGE MAY BE DEFECTIVE

Replace the defective toner cartridge.

THE IMAGING KIT MAY BE DEFECTIVE

Replace the imaging kit.

Note: The printer has two types of imaging kits: a black and color imaging kit, and a black imaging kit. The black and color imaging kit contains cyan, magenta, yellow, and black. The black imaging kit contains black only.

Paper curl

These are possible solutions. Try one or more of the following:

CHECK THE PAPER TYPE SETTING

Make sure the Paper Type setting matches the paper loaded in the tray.

HAS THE PAPER ABSORBED MOISTURE DUE TO HIGH HUMIDITY?

- Load paper from a fresh package.
- Store paper in its original wrapper until you use it.

Print irregularities

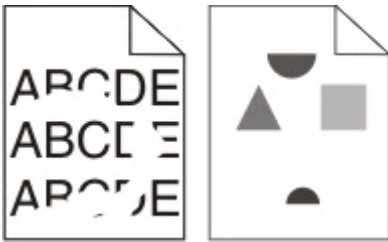

These are possible solutions. Try one or more of the following:

THE PAPER MAY HAVE ABSORBED MOISTURE DUE TO HIGH HUMIDITY

- Load paper from a fresh package.
- Store paper in its original wrapper until you use it.

CHECK THE PAPER TYPE SETTING

Make sure the paper type setting matches the paper loaded in the tray:

- 1 From the printer control panel, check the Paper Type setting from the Paper menu.
- 2 Before sending the job to print, specify the correct type setting:
 - For Windows users, specify the type from Print Properties.
 - For Macintosh users, specify the type from the Print dialog.

CHECK THE PAPER

Avoid textured paper with rough finishes.

THE TONER MAY BE LOW

When **88 Cartridge low** appears or when the print becomes faded, replace the print cartridge.

THE FUSER MAY BE WORN OR DEFECTIVE

Replace the fuser.

Repeating defects

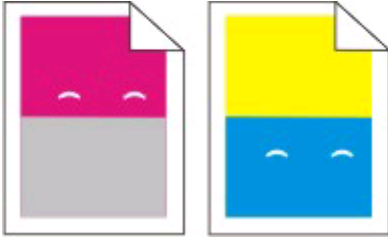

REPEATING MARKS OCCUR MULTIPLE TIMES ON A PAGE

Print the Print defects guide and match the defects to the marks on one of the vertical lines. Follow the instructions on the Print defects guide to determine the cause of the repeating defects.

Skewed print

CHECK THE PAPER GUIDES

Move the guides in the tray to the correct positions for the paper size loaded.

CHECK THE PAPER

Make sure you are using paper that meets the printer specifications.





Print is too light



These are possible solutions. Try one or more of the following:







CALIBRATE THE COLOR

The printer automatically calibrates the colors whenever a new imaging kit is detected. If a cartridge is replaced, then you can calibrate the colors manually:

- 1 From the printer control panel, press .
 - 2 From the **Admin** menu, press the arrow buttons until **Settings** appears, and then press .
 - 3 Press the arrow buttons until **Print** menu appears, and then press .
 - 4 Press the arrow buttons until **Quality** menu appears, and then press .
 - 5 Press the arrow buttons until **Color Adjust** appears, and then press .
- Calibrating appears.

CHECK THE DARKNESS, BRIGHTNESS, AND CONTRAST SETTINGS

The Toner Darkness setting is too light, the RGB Brightness setting is too light, or the RGB Contrast setting is too low.

- 1 From the printer control panel, press .
- 2 From the **Admin menu**, press the arrow buttons until **Settings** appears, and then press .
- 3 Press the arrow buttons until **Print menu** appears, and then press .
- 4 Press the arrow buttons until **Quality menu** appears, and then press .
- 5 Press the arrow buttons until **Toner Darkness**, **RGB Brightness**, or **RGB Contrast** appears, and then press .
- 6 Change the selected setting to a lower value, and then press .

THE PAPER MAY HAVE ABSORBED MOISTURE DUE TO HIGH HUMIDITY

- Load paper from a fresh package.
- Store paper in its original wrapper until you use it.

CHECK THE PAPER

Avoid textured paper with rough finishes.

CHECK THE PAPER TYPE SETTING

Make sure the Paper Type setting matches the paper loaded in the tray.

MAKE SURE COLOR SAVER IS SET TO OFF

Color Saver may be set to On.

A TONER CARTRIDGE MAY BE LOW

When 88 **<color> Cartridge Low** appears, order a new cartridge.

A TONER CARTRIDGE MAY BE DEFECTIVE

Replace the toner cartridge.

THE IMAGING KIT MAY BE WORN OR DEFECTIVE

Replace the imaging kit.

Note: The printer has two types of imaging kits: a black and color imaging kit, and a black imaging kit. The black and color imaging kit contains cyan, magenta, yellow, and black. The black imaging kit contains black only.





Print is too dark



These are possible solutions. Try one or more of the following:







CALIBRATE THE COLOR

The printer automatically calibrates the colors whenever a new imaging kit is detected. If a cartridge is replaced, then you can calibrate the colors manually:

- 1 From the printer control panel, press .
 - 2 From the **Admin** menu, press the arrow buttons until **Settings** appears, and then press .
 - 3 Press the arrow buttons until **Print** menu appears, and then press .
 - 4 Press the arrow buttons until **Quality** menu appears, and then press .
 - 5 Press the arrow buttons until **Color Adjust** appears, and then press .
- Calibrating appears.

CHECK THE DARKNESS, BRIGHTNESS, AND CONTRAST SETTINGS

The Toner Darkness setting is too dark, the RGB Brightness setting is too dark, or the RGB Contrast setting is too high.

- 1 From the printer control panel, press .
- 2 From the **Admin** menu, press the arrow buttons until **Settings** appears, and then press .
- 3 Press the arrow buttons until **Print** menu appears, and then press .
- 4 Press the arrow buttons until **Quality** menu appears, and then press .
- 5 Press the arrow buttons until **Toner Darkness**, **RGB Brightness**, or **RGB Contrast** appears, and then press .
- 6 Change the selected setting to a lower value, and then press .

A TONER CARTRIDGE MAY BE DEFECTIVE

Replace the toner cartridge.

Solid color pages

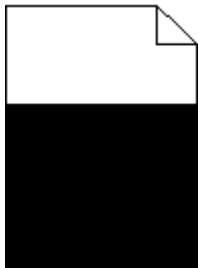

These are possible solutions. Try one or more of the following:

MAKE SURE THE PRINT CARTRIDGE IS PROPERLY INSTALLED

Remove the print cartridge and shake it from side to side to redistribute the toner, and then reinstall it.

THE PRINT CARTRIDGE MAY BE DEFECTIVE OR LOW ON TONER

Replace the used print cartridge with a new one. If the problem continues, the printer may need to be serviced. For more information, contact Customer Support.

Toner fog or background shading appears on the page

These are possible solutions. Try one or more of the following:

THE IMAGING KIT MAY BE WORN OR DEFECTIVE

Replace the imaging kit.

Note: The printer has two types of imaging kits: a black and color imaging kit, and a black imaging kit. The black and color imaging kit contains cyan, magenta, yellow, and black. The black imaging kit contains black only.

IS THERE TONER IN THE PAPER PATH?

Contact Customer Support.

Toner rubs off

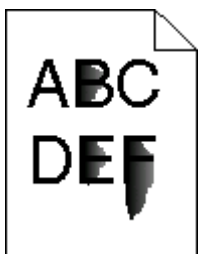

These are possible solutions. Try one or more of the following:

CHECK THE PAPER TYPE SETTING

Make sure the paper type setting matches the paper loaded in the tray:

- 1 From the printer control panel, check the Paper Type setting from the Paper menu.
- 2 Before sending the job to print, specify the correct type setting:
 - For Windows users, specify the type from Print Properties.
 - For Macintosh users, specify the type from the Print dialog.

CHECK THE PAPER TEXTURE SETTING

From the printer control panel Paper menu, make sure the Paper Texture setting matches the paper loaded in the tray.

Toner specks

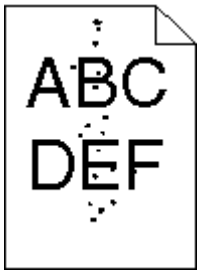

These are possible solutions. Try one or more of the following:

THE PRINT CARTRIDGE MAY BE DEFECTIVE

Replace the print cartridge.

THERE IS TONER IN THE PAPER PATH

Contact Customer Support.

Transparency print quality is poor

Try one or more of the following:

CHECK THE TRANSPARENCIES

Use only transparencies recommended by the printer manufacturer.

CHECK THE PAPER TYPE SETTING

Make sure the paper type setting matches the paper loaded in the tray:

- 1 From the printer control panel, check the Paper Type setting from the Paper menu.
- 2 Before sending the job to print, specify the correct type setting:
 - For Windows users, specify the type from Print Properties.
 - For Macintosh users, specify the type from the Print dialog.

Uneven print density



Replace the black and color imaging kit.

Solving color quality problems

This section helps answer some basic color-related questions and describes how some of the features provided in the Quality menu can be used to solve typical color problems.

Color misregistration







Color has shifted outside of the appropriate area or has been superimposed over another color area. These are possible solutions. Try one or more of the following:

A TONER CARTRIDGE MAY BE DEFECTIVE

Remove and reinstall the toner cartridges.

CALIBRATE THE COLOR

The printer will automatically calibrate the colors whenever a new imaging kit is detected. If a toner cartridge is replaced, a manual alignment will need to be performed.

- 1 From the printer control panel, press .
- 2 From the **Admin** menu, press the arrow buttons until **Settings** appears, and then press .
- 3 Press the arrow buttons until **Print** menu appears, and then press .
- 4 Press the arrow buttons until **Quality** menu appears, and then press .
- 5 Press the arrow buttons until **Color Adjust** appears, and then press .

Calibrating appears.

FAQ about color printing

What is RGB color?

Red, green, and blue light can be added together in various amounts to produce a large range of colors observed in nature. For example, red and green can be combined to create yellow. Televisions and computer monitors create colors in this manner. RGB color is a method of describing colors by indicating the amount of red, green, or blue needed to produce a certain color.

What is CMYK color?

Cyan, magenta, yellow, and black inks or toners can be printed in various amounts to produce a large range of colors observed in nature. For example, cyan and yellow can be combined to create green. Printing presses, inkjet printers, and color laser printers create colors in this manner. CMYK color is a method of describing colors by indicating the amount of cyan, magenta, yellow, and black needed to reproduce a particular color.

How is color specified in a document to be printed?

Software programs typically specify document color using RGB or CMYK color combinations. Additionally, they allow users to modify the color of each object in a document. For more information, see the software program Help topics.

How does the printer know what color to print?

When a user prints a document, information describing the type and color of each object is sent to the printer. The color information is passed through color conversion tables that translate the color into the appropriate amounts of cyan, magenta, yellow, and black toner needed to produce the desired color. The object information determines the application of color conversion tables. For example, it is possible to apply one type of color conversion table to text while applying a different color conversion table to photographic images.

Should I use PostScript or PCL emulation printer software? What settings should I use for the best color?

The PostScript driver is strongly recommended for best color quality. The default settings in the PostScript driver provide the preferred color quality for the majority of printouts.

Why doesn't the printed color match the color I see on the computer screen?

The color conversion tables used in Auto Color Correction mode generally approximate the colors of a standard computer monitor. However, because of technology differences that exist between printers and monitors, there are many colors that can also be affected by monitor variations and lighting conditions. For recommendations on how the printer color sample pages may be useful in solving certain color-matching problems, see the question, "How can I match a particular color (such as a corporate logo)?"

The printed page appears tinted. Can I adjust the color?

Sometimes a printed page may appear tinted (for example, everything printed seems to be too red). This can be caused by environmental conditions, paper type, lighting conditions, or user preference. In these instances, adjust the Color Balance setting to create a more preferable color. Color Balance provides the user with the ability to make subtle adjustments to the amount of toner being used in each color plane. Selecting positive or negative values for cyan, magenta, yellow, and black (from the Color Balance menu) will slightly increase or decrease the amount of toner used for the chosen color. For example, if a printed page has a red tint, then decreasing both magenta and yellow could potentially improve the color balance.

My color transparencies seem dark when they are projected. Is there anything I can do to improve the color?

This problem most commonly occurs when projecting transparencies with reflective overhead projectors. To obtain the highest projected color quality, transmissive overhead projectors are recommended. If a reflective projector must be used, then adjusting the Toner Darkness setting to 1, 2, or 3 will lighten the transparency. Make sure to print on the recommended type of color transparencies.

What is manual color correction?

When manual color correction is enabled, the printer employs user-selected color conversion tables to process objects. However, Color Correction must be set to Manual, or no user-defined color conversion will be implemented. Manual color correction settings are specific to the type of object being printed (text, graphics, or images), and how the color of the object is specified in the software program (RGB or CMYK combinations).

Notes:

- Manual color correction is not useful if the software program does not specify colors with RGB or CMYK combinations. It is also not effective in situations in which the software program or the computer operating system controls the adjustment of colors.
- The color conversion tables—applied to each object when Color Correction is set to Auto—generate preferred colors for the majority of documents.

To manually apply a different color conversion table:

- 1 From the Quality menu, select **Color Correction**, and then select **Manual**.
- 2 From the Quality menu, select **Manual Color**, and then select the appropriate color conversion table for the affected object type.

Manual Color menu

Object type	Color conversion tables
RGB Image RGB Text RGB Graphics	<ul style="list-style-type: none">• Vivid—Produces brighter, more saturated colors and may be applied to all incoming color formats.• sRGB Display—Produces an output that approximates the colors displayed on a computer monitor. Black toner usage is optimized for printing photographs.• Display—True Black—Produces an output that approximates the colors displayed on a computer monitor. Uses only black toner to create all levels of neutral gray.• sRGB Vivid—Provides an increased color saturation for the sRGB Display color correction. Black usage is optimized for printing business graphics.• Off—No color correction is implemented.

Object type	Color conversion tables
CMYK Image CMYK Text CMYK Graphics	<ul style="list-style-type: none"> • US CMYK—Applies color correction to approximate the SWOP (Specifications for Web Offset Publishing) color output. • Euro CMYK—Applies color correction to approximated EuroScale color output. • Vivid CMYK—Increases the color saturation of the US CMYK color correction setting. • Off—No color correction is implemented.

How can I match a particular color (such as a corporate logo)?

From the printer Quality menu, nine types of Color Samples sets are available. These are also available from the Color Samples page of the Embedded Web Server. Selecting any sample set generates a multiple-page printout consisting of hundreds of colored boxes. Either a CMYK or RGB combination is located on each box, depending on the table selected. The observed color of each box is obtained by passing the CMYK or RGB combination labeled on the box through the selected color conversion table.

By examining Color Samples sets, a user can identify the box whose color is the closest to the desired color. The color combination labeled on the box can then be used for modifying the color of the object in a software program. For more information, see the software program Help topics. Manual color correction may be necessary to utilize the selected color conversion table for the particular object.

Selecting which Color Samples set to use for a particular color-matching problem depends on the Color Correction setting being used (Auto, Off, or Manual), the type of object being printed (text, graphics, or images), and how the color of the object is specified in the software program (RGB or CMYK combinations). When the printer Color Correction setting is set to Off, the color is based on the print job information; and no color conversion is implemented.

Note: The Color Samples pages are not useful if the software program does not specify colors with RGB or CMYK combinations. Additionally, certain situations exist in which the software program or the computer operating system adjusts the RGB or CMYK combinations specified in the program through color management. The resulting printed color may not be an exact match of the Color Samples pages.

What are detailed Color Samples and how do I access them?

Detailed Color Samples sets are available only through the Embedded Web Server of a network printer. A detailed Color Samples set contains a range of shades (displayed as colored boxes) that are similar to a user-defined RGB or CMYK value. The likeness of the colors in the set are dependent on the value entered in the RGB or CMYK Increment box.

To access a detailed Color Samples set from the Embedded Web Server:

- 1 Type the printer IP address into the address field of your Web browser.

Note: If you do not know the IP address of the printer, then print a network setup page and locate the IP address in the TCP/IP section.

- 2 Click **Configuration**.
- 3 Click **Color Samples**.
- 4 Click **Detailed Options** to narrow the set to one color range.
- 5 When the Detailed Options page appears, select a color conversion table.
- 6 Enter the RGB or CMYK color number.

7 Enter an Increment value from 1–255.

Note: The closer the value is to 1, the narrower the color sample range will appear.

8 Click **Print** to print the detailed Color Samples set.

Embedded Web Server does not open

These are possible solutions. Try one or more of the following:

CHECK THE NETWORK CONNECTIONS

Make sure the printer and computer are turned on and connected to the same network.

CHECK THE NETWORK SETTINGS

Depending on the network settings, you may need to type `https://` instead of `http://` before the printer IP address to access the Embedded Web Server. For more information, see your system administrator.

Contacting Customer Support

When you call Customer Support, describe the problem you are experiencing, the message on the display, and the troubleshooting steps you have already taken to find a solution.

You need to know your printer model type and serial number. For more information, see the label on the inside top front cover of the printer. The serial number is also listed on the menu settings page.

In the U.S. or Canada, call (1-800-539-6275). For other countries/regions, visit the Lexmark Web site at www.lexmark.com.

Notices

Product information

Product name:

Lexmark X543, X544, X544t, X544w

Machine type:

7525

Model(s):

131, 133, 138, 332, 333, 336, 337, 352, 356, 382, 383, 386, 387

Edition notice

August 2008

The following paragraph does not apply to any country where such provisions are inconsistent with local law: LEXMARK INTERNATIONAL, INC., PROVIDES THIS PUBLICATION "AS IS" WITHOUT WARRANTY OF ANY KIND, EITHER EXPRESS OR IMPLIED, INCLUDING, BUT NOT LIMITED TO, THE IMPLIED WARRANTIES OF MERCHANTABILITY OR FITNESS FOR A PARTICULAR PURPOSE. Some states do not allow disclaimer of express or implied warranties in certain transactions; therefore, this statement may not apply to you.

This publication could include technical inaccuracies or typographical errors. Changes are periodically made to the information herein; these changes will be incorporated in later editions. Improvements or changes in the products or the programs described may be made at any time.

References in this publication to products, programs, or services do not imply that the manufacturer intends to make these available in all countries in which it operates. Any reference to a product, program, or service is not intended to state or imply that only that product, program, or service may be used. Any functionally equivalent product, program, or service that does not infringe any existing intellectual property right may be used instead. Evaluation and verification of operation in conjunction with other products, programs, or services, except those expressly designated by the manufacturer, are the user's responsibility.

For Lexmark technical support, visit support.lexmark.com.

For information on supplies and downloads, visit www.lexmark.com.

If you don't have access to the Internet, you can contact Lexmark by mail:

Lexmark International, Inc.
Bldg 004-2/CSC
740 New Circle Road NW
Lexington, KY 40550
USA

© 2008 Lexmark International, Inc.

All rights reserved.

UNITED STATES GOVERNMENT RIGHTS

This software and any accompanying documentation provided under this agreement are commercial computer software and documentation developed exclusively at private expense.

Trademarks

Lexmark, Lexmark with diamond design, and MarkVision are trademarks of Lexmark International, Inc., registered in the United States and/or other countries.

ScanBack is a trademark of Lexmark International, Inc.

PCL® is a registered trademark of the Hewlett-Packard Company. PCL is Hewlett-Packard Company's designation of a set of printer commands (language) and functions included in its printer products. This printer is intended to be compatible with the PCL language. This means the printer recognizes PCL commands used in various application programs, and that the printer emulates the functions corresponding to the commands.

All other trademarks are the property of their respective owners.

Federal Communications Commission (FCC) compliance information statement

This product has been tested and found to comply with the limits for a Class B digital device, pursuant to Part 15 of the FCC Rules. Operation is subject to the following two conditions: (1) this device may not cause harmful interference, and (2) this device must accept any interference received, including interference that may cause undesired operation

The FCC Class B limits are designed to provide reasonable protection against harmful interference when the equipment is operated in a residential installation. This equipment generates, uses, and can radiate radio frequency energy and, if not installed and used in accordance with the instructions, may cause harmful interference to radio communications. However, there is no guarantee that interference will not occur in a particular installation. If this equipment does cause harmful interference to radio or television reception, which can be determined by turning the equipment off and on, the user is encouraged to try to correct the interference by one or more of the following measures:

- Reorient or relocate the receiving antenna.
- Increase the separation between the equipment and receiver.
- Connect the equipment into an outlet on a circuit different from that to which the receiver is connected.
- Consult your point of purchase or service representative for additional suggestions.

The manufacturer is not responsible for radio or television interference caused by using other than recommended cables or by unauthorized changes or modifications to this equipment. Unauthorized changes or modifications could void the user's authority to operate this equipment.

Note: To assure compliance with FCC regulations on electromagnetic interference for a Class B computing device, use a properly shielded and grounded cable such as Lexmark part number 1021231 for parallel attach or 1021294 for USB attach. Use of a substitute cable not properly shielded and grounded may result in a violation of FCC regulations.

Any questions regarding this compliance information statement should be directed to:

Director of Lexmark Technology & Services
Lexmark International, Inc.
740 West New Circle Road
Lexington, KY 40550
(859) 232-3000

Industry Canada compliance statement

This Class B digital apparatus meets all requirements of the Canadian Interference-Causing Equipment Standard ICES-003.

Avis de conformité aux normes de l'industrie du Canada

Cet appareil numérique de classe B est conforme aux exigences de la norme canadienne relative aux équipements pouvant causer des interférences NMB-003.

European Community (EC) directives conformity

This product is in conformity with the protection requirements of EC Council directives 2004/108/EC and 2006/95/EC on the approximation and harmonization of the laws of the Member States relating to electromagnetic compatibility and safety of electrical equipment designed for use within certain voltage limits.

A declaration of conformity with the requirements of the directives has been signed by the Director of Manufacturing and Technical Support, Lexmark International, Inc., S.A., Boigny, France.

This product satisfies the Class B limits of EN 55022 and safety requirements of EN 60950.

The following notices are applicable if your printer has a wireless network card installed

Exposure to radio frequency radiation

The radiated output power of this device is far below the radio frequency exposure limits of the FCC and other regulatory agencies. A minimum separation of 20 cm (8 inches) must be maintained between the antenna and any persons for this device to satisfy the RF exposure requirements of the FCC and other regulatory agencies.

Industry Canada notice

The following notices are applicable if your printer has a wireless network card installed.

Industry Canada (Canada)

This device complies with Industry Canada specification RSS-210. Operation is subject to the following two conditions: (1) this device may not cause interference, and (2) this device must accept any interference, including interference that may cause undesired operation of the device.

This device has been designed to operate only with the antenna provided. Use of any other antenna is strictly prohibited per regulations of Industry Canada.

To prevent radio interference to the licensed service, this device is intended to be operated indoors and away from windows to provide maximum shielding. Equipment (or its transmit antenna) that is installed outdoors is subject to licensing.

The installer of this radio equipment must ensure that the antenna is located or pointed such that it does not emit RF fields in excess of Health Canada limits for the general population; consult Safety Code 6, obtainable from Health Canada's Web site www.hc-sc.gc.ca/rpb.

The term "IC:" before the certification/registration number only signifies that the Industry Canada technical specifications were met.

Industry Canada (Canada)

Cet appareil est conforme à la norme RSS-210 d'Industry Canada. Son fonctionnement est soumis aux deux conditions suivantes :

(1) cet appareil ne doit pas provoquer d'interférences et (2) il doit accepter toute interférence reçue, y compris celles risquant d'altérer son fonctionnement.

Cet appareil a été conçu pour fonctionner uniquement avec l'antenne fournie. L'utilisation de toute autre antenne est strictement interdite par la réglementation d'Industry Canada.

En application des réglementations d'Industry Canada, l'utilisation d'une antenne de gain supérieur est strictement interdite.

Pour empêcher toute interférence radio au service faisant l'objet d'une licence, cet appareil doit être utilisé à l'intérieur et loin des fenêtres afin de garantir une protection optimale.

Si le matériel (ou son antenne d'émission) est installé à l'extérieur, il doit faire l'objet d'une licence.

L'installateur de cet équipement radio doit veiller à ce que l'antenne soit implantée et dirigée de manière à n'émettre aucun champ HF dépassant les limites fixées pour l'ensemble de la population par Santé Canada. Reportez-vous au Code de sécurité 6 que vous pouvez consulter sur le site Web de Santé Canada www.hc-sc.gc.ca/rpb.

Le terme « IC » précédant le numéro de d'accréditation/inscription signifie simplement que le produit est conforme aux spécifications techniques d'Industry Canada.

European Community (EC) directives conformity statement for radio products

This product is in conformity with the protection requirements of EC Council directives 2004/108/EC, 2006/95/EC, and 1999/5/EC on the approximation and harmonization of the laws of the Member States relating to electromagnetic compatibility, safety of electrical equipment designed for use within certain voltage limits and on radio equipment and telecommunications terminal equipment.

Compliance is indicated by the CE marking.



Operation is allowed in all EU and EFTA countries, but is restricted to indoor use only.

A declaration of conformity with the requirements of the directives is available from the Director of Manufacturing and Technical Support, Lexmark International, S. A., Boigny, France.

This product satisfies the limits of EN 55022; safety requirements of EN 60950; radio spectrum requirements of ETSI EN 300 328; and the EMC requirements of EN 55024, ETSI EN 301 489-1 and ETSI EN 301 489-17.

Česky	Společnost Lexmark International, Inc. tímto prohlašuje, že výrobek tento výrobek je ve shodě se základními požadavky a dalšími příslušnými ustanoveními směrnice 1999/5/ES.
Dansk	Lexmark International, Inc. erklærer herved, at dette produkt overholder de væsentlige krav og øvrige relevante krav i direktiv 1999/5/EF.
Deutsch	Hiermit erklärt Lexmark International, Inc., dass sich das Gerät dieses Gerät in Übereinstimmung mit den grundlegenden Anforderungen und den übrigen einschlägigen Bestimmungen der Richtlinie 1999/5/EG befindet.
Ελληνική	ΜΕ ΤΗΝ ΠΑΡΟΥΣΑ Η LEXMARK INTERNATIONAL, INC. ΔΗΛΩΝΕΙ ΟΤΙ ΑΥΤΟ ΤΟ ΠΡΟΪΟΝ ΣΥΜΜΟΡΦΩΝΕΤΑΙ ΠΡΟΣ ΤΙΣ ΟΥΣΙΩΔΕΙΣ ΑΠΑΙΤΗΣΕΙΣ ΚΑΙ ΤΙΣ ΛΟΙΠΕΣ ΣΧΕΤΙΚΕΣ ΔΙΑΤΑΞΕΙΣ ΤΗΣ ΟΔΗΓΙΑΣ 1999/5/ΕΚ.
English	Hereby, Lexmark International, Inc., declares that this type of equipment is in compliance with the essential requirements and other relevant provisions of Directive 1999/5/EC.
Español	Por medio de la presente, Lexmark International, Inc. declara que este producto cumple con los requisitos esenciales y cualesquiera otras disposiciones aplicables o exigibles de la Directiva 1999/5/CE.
Eesti	Käesolevaga kinnitab Lexmark International, Inc., et seade see toode vastab direktiivi 1999/5/EÜ põhinõuetele ja nimetatud direktiivist tulenevatele muudele asjakohastele sätetele.
Suomi	Lexmark International, Inc. vakuuttaa täten, että tämä tuote on direktiivin 1999/5/EY oleellisten vaatimusten ja muiden sitä koskevien direktiivin ehtojen mukainen.
Français	Par la présente, Lexmark International, Inc. déclare que l'appareil ce produit est conforme aux exigences fondamentales et autres dispositions pertinentes de la directive 1999/5/CE.
Magyar	Alulírott, Lexmark International, Inc. nyilatkozom, hogy a termék megfelel a vonatkozó alapvető követelményeknek és az 1999/5/EC irányelv egyéb előírásainak.
Íslenska	Hér með lýsir Lexmark International, Inc. yfir því að þessi vara er í samræmi við grunnkröfur og aðrar kröfur, sem gerðar eru í tilskipun 1999/5/EC.
Italiano	Con la presente Lexmark International, Inc. dichiara che questo questo prodotto è conforme ai requisiti essenziali ed alle altre disposizioni pertinenti stabilite dalla direttiva 1999/5/CE.
Latviski	Ar šo Lexmark International, Inc. deklarē, ka šis izstrādājums atbilst Direktīvas 1999/5/EK būtiskajām prasībām un citiem ar to saistītajiem noteikumiem.
Lietuvių	Šiuo Lexmark International, Inc. deklaruoja, kad šis produktas atitinka esminius reikalavimus ir kitas 1999/5/EB direktyvos nuostatas.
Malti	Bil-preżenti, Lexmark International, Inc., jiddikjara li dan il-prodott huwa konformi mal-ħtiġijiet essenzjali u ma dispożizzjonijiet oħrajn relevanti li jinsabu fid-Direttiva 1999/5/KE.
Nederlands	Hierbij verklaart Lexmark International, Inc. dat het toestel dit product in overeenstemming is met de essentiële eisen en de andere relevante bepalingen van richtlijn 1999/5/EG.
Norsk	Lexmark International, Inc. erklærer herved at dette produktet er i samsvar med de grunnleggende krav og øvrige relevante krav i direktiv 1999/5/EF.
Polski	Niniejszym Lexmark International, Inc. oświadcza, że niniejszy produkt jest zgodny z zasadniczymi wymogami oraz pozostałymi stosownymi postanowieniami Dyrektywy 1999/5/EC.
Português	A Lexmark International Inc. declara que este este produto está conforme com os requisitos essenciais e outras disposições da Diretiva 1999/5/CE.

Slovensky	Lexmark International, Inc. týmto vyhlasuje, že tento produkt spĺňa základné požiadavky a všetky príslušné ustanovenia smernice 1999/5/ES.
Slovensko	Lexmark International, Inc. izjavlja, da je ta izdelek v skladu z bistvenimi zahtevami in ostalimi relevantnimi določili direktive 1999/5/ES.
Svenska	Härmed intygar Lexmark International, Inc. att denna produkt står i överensstämmelse med de väsentliga egenskapskrav och övriga relevanta bestämmelser som framgår av direktiv 1999/5/EG.

Noise emission levels

The following measurements were made in accordance with ISO 7779 and reported in conformance with ISO 9296.

Note: Some modes may not apply to your product.

1-meter average sound pressure, dBA	
Printing	52 dBA
Ready	32 dBA

Values are subject to change. See www.lexmark.com for current values.

Temperature information

Ambient temperature	15.6°C – 32.2°C
Shipping and storage temperature	-40.0°C – 60.0°C

Federal Communications Commission (FCC) compliance information statement

This equipment complies with Part 68 of the FCC rules and the requirements adopted by the Administrative Council for Terminal Attachments (ACTA). On the back of this equipment is a label that contains, among other information, a product identifier in the format US:AAAEQ##TXXXX. If requested, this number must be provided to your telephone company.

This equipment uses the RJ-11C Universal Service Order Code (USOC) jack.

A plug and jack used to connect this equipment to the premises' wiring and telephone network must comply with the applicable FCC Part 68 rules and requirements adopted by the ACTA. A compliant telephone cord and modular plug is provided with this product. It is designed to be connected to a compatible modular jack that is also compliant. See your setup documentation for more information.

The Ringer Equivalence Number (REN) is used to determine the number of devices that may be connected to a telephone line. Excessive RENs on a telephone line may result in the devices not ringing in response to an incoming call. In most but not all areas, the sum of RENs should not exceed five (5.0). To be certain of the number of devices that may be connected to a line, as determined by the total RENs, contact your local telephone company. For products approved after July 23, 2001, the REN for this product is part of the product identifier that has the format US:AAAEQ##TXXXX. The digits represented by ## are the REN without a decimal point (for example, 03 is a REN of 0.3). For earlier products, the REN is shown separately on the label.

If this equipment causes harm to the telephone network, the telephone company will notify you in advance that temporary discontinuance of service may be required. If advance notice is not practical, the telephone company will notify the customer as soon as possible. You will also be advised of your right to file a complaint with the FCC.

The telephone company may make changes in its facilities, equipment, operations or procedures that could affect the operation of this equipment. If this happens, the telephone company will provide advance notice in order for you to make necessary modifications to maintain uninterrupted service.

If you experience trouble with this equipment, for repair or warranty information, contact Lexmark International, Inc. at **www.lexmark.com** or your Lexmark representative. If the equipment is causing harm to the telephone network, the telephone company may request that you disconnect the equipment until the problem is resolved.

This equipment contains no user serviceable parts. For repair and warranty information, contact Lexmark International, Inc. See the previous paragraph for contact information.

Connection to party line service is subject to state tariffs. Contact the state public utility commission, public service commission, or corporation commission for information.

If your home has specially wired alarm equipment connected to the telephone line, ensure the installation of this equipment does not disable your alarm equipment. If you have questions about what will disable alarm equipment, consult your telephone company or a qualified installer.

Telephone companies report that electrical surges, typically lightning transients, are very destructive to customer terminal equipment connected to AC power sources. This has been identified as a major nationwide problem. It is recommended that the customer install an appropriate AC surge arrester in the AC outlet to which this device is connected. An appropriate AC surge arrester is defined as one that is suitably rated, and certified by UL (Underwriter's Laboratories), another NRTL (Nationally Recognized Testing Laboratory), or a recognized safety certification body in the country/region of use. This is to avoid damage to the equipment caused by local lightning strikes and other electrical surges.

The Telephone Consumer Protection Act of 1991 makes it unlawful for any person to use a computer or other electronic device, including fax machines, to send any message unless said message clearly contains in a margin at the top or bottom of each transmitted page or on the first page of the transmission, the date and time it is sent and an identification of the business or other entity, or other individual sending the message, and the telephone number of the sending machine or such business, other entity, or individual. (The telephone number provided may not be a 900 number or any other number for which charges exceed local or long-distance transmission charges.)

See your user documentation in order to program this information into your fax machine.

Notice to users of the Canadian telephone network

This product meets the applicable Industry Canada technical specifications. The Ringer Equivalence Number (REN) is an indication of the maximum number of terminals allowed to be connected to a telephone interface. The terminus of an interface may consist of any combination of devices, subject only to the requirement that the sum of the RENs of all the devices does not exceed five. The modem REN is located on the rear of the equipment on the product labeling.

Telephone companies report that electrical surges, typically lightning transients, are very destructive to customer terminal equipment connected to AC power sources. This has been identified as a major nationwide problem. It is recommended that the customer install an appropriate AC surge arrester in the AC outlet to which this device is connected. An appropriate AC surge arrester is defined as one that is suitably rated, and certified by UL (Underwriter's Laboratories), another NRTL (Nationally Recognized Testing Laboratory), or a recognized safety certification body in the country/region of use. This is to avoid damage to the equipment caused by local lightning strikes and other electrical surges.

This equipment uses CA11A telephone jacks.

Avis réservé aux utilisateurs du réseau téléphonique du Canada

Ce produit est conforme aux spécifications techniques d'Industrie Canada. Le numéro REN (ringer equivalence number : numéro d'équivalence de sonnerie) fournit une indication du nombre maximum de terminaux pouvant être connectés à l'interface téléphonique. En bout de ligne, le nombre d'appareils qui peuvent être connectés n'est pas directement limité, mais la somme des REN de ces appareils ne doit pas dépasser cinq. Le numéro REN du modem est indiqué sur l'étiquette produit située à l'arrière de l'équipement.

Les compagnies de téléphone constatent que les surtensions électriques, en particulier celles dues à la foudre, entraînent d'importants dégâts sur les terminaux privés connectés à des sources d'alimentation CA. Il s'agit-là d'un problème majeur d'échelle nationale. En conséquence, il vous est recommandé de brancher un parasurtenseur dans la prise de courant à laquelle l'équipement est connecté. Utilisez un parasurtenseur répondant à des caractéristiques nominales satisfaisantes et certifié par le laboratoire d'assureurs UL (Underwriter's Laboratories), un autre laboratoire agréé de type NRTL (Nationally Recognized Testing Laboratory) ou un organisme de certification agréé dans votre région ou pays. Ceci prévient tout endommagement de l'équipement causé par les orages et autres surtensions électriques.

Cet équipement utilise des prises de téléphone CA11A.

Notice to users of the New Zealand telephone network

The following are special conditions for the Facsimile User Instructions. The grant of a telepermit for any item of terminal equipment indicates only that Telecom has accepted that the item complies with minimum conditions for connection to its network. It indicates no endorsement of the product by Telecom, nor does it provide any sort of warranty. Above all, it provides no assurance that any item will work correctly in all respects with another item of telepermitted equipment of a different make or model, nor does it imply that any product is compatible with all of Telecom's network services.

This equipment shall not be set up to make automatic calls to the Telecom's 111 Emergency Service.

This equipment may not provide for the effective hand-over of a call to another device connected to the same line.

This equipment should not be used under any circumstances that may constitute a nuisance to other Telecom customers.

Some parameters required for compliance with Telecom's telepermit requirements are dependent on the equipment associated with this device. The associated equipment shall be set to operate within the following limits for compliance to Telecom's specifications:

- There shall be no more than 10 call attempts to the same number within any 30 minute period for any single manual call initiation, and
- The equipment shall go on-hook for a period of not less than 30 seconds between the end of one attempt and the beginning of the next call attempt.
- The equipment shall be set to ensure that automatic calls to different numbers are spaced such that there is not less than 5 seconds between the end of one call attempt and the beginning of another.

South Africa telecommunications notice

This modem must be used in conjunction with an approved surge protection device when connected to the PSTN.

Using this product in Switzerland

This product requires a Swiss billing tone filter (Lexmark part number 14B5109 or 80D1877) to be installed on any line which receives metering pulses in Switzerland. The Lexmark filter must be used, as metering pulses are present on all analog telephone lines in Switzerland.

Utilisation de ce produit en Suisse

Cet appareil nécessite l'utilisation d'un filtre de tonalité de facturation suisse (n° de référence Lexmark : 14B5109 ou 80D1877) devant être installé sur toute ligne recevant des impulsions de comptage en Suisse. Ce filtre doit être utilisé pour toute installation car ces impulsions existent sur toutes les lignes téléphoniques suisses.

Verwendung dieses Produkts in der Schweiz

Für dieses Produkt muss ein schweizerischer Billing Tone Filter zur Zählzeichenübertragung (Lexmark Teilenummer 14B5109 oder 80D1877) für jede Leitung installiert werden, über die in der Schweiz Zeitsteuertakte übertragen werden. Die Verwendung des Lexmark Filters ist obligatorisch, da in allen analogen Telefonleitungen in der Schweiz Zeitsteuertakte vorhanden sind.

Uso del prodotto in Svizzera

Questo prodotto richiede un filtro toni Billing svizzero, (codice Lexmark 14B5109 o 80D1877) da installare su tutte le linee che ricevono impulsi remoti in Svizzera. È necessario utilizzare il filtro Lexmark poiché gli impulsi remoti sono presenti su tutte le linee analogiche in Svizzera.

Waste from Electrical and Electronic Equipment (WEEE) directive



The WEEE logo signifies specific recycling programs and procedures for electronic products in countries of the European Union. We encourage the recycling of our products. If you have further questions about recycling options, visit the Lexmark Web site at www.lexmark.com for your local sales office phone number.

Mercury statement

This product contains mercury in the lamp (<5mg Hg). Disposal of mercury may be regulated due to environmental considerations. For disposal or recycling information, contact your local authorities or the Electronic Industries Alliance: www.eiae.org.

Product disposal

Do not dispose of the printer or supplies in the same manner as normal household waste. Consult your local authorities for disposal and recycling options.

Static sensitivity notice



This symbol identifies static-sensitive parts. Do not touch in the areas near these symbols without first touching the metal frame of the printer.

ENERGY STAR

Applicable only to models with duplexing enabled.



Use care when you replace a lithium battery.

⚠ CAUTION—POTENTIAL INJURY: There is a danger of explosion if a lithium battery is incorrectly replaced. Replace it only with the same or an equivalent type of lithium battery. Do not recharge, disassemble, or incinerate a lithium battery. Discard used batteries according to the manufacturer's instructions and local regulations.

Laser notice

The printer is certified in the U.S. to conform to the requirements of DHHS 21 CFR Subchapter J for Class I (1) laser products, and elsewhere is certified as a Class I laser product conforming to the requirements of IEC 60825-1.

Class I laser products are not considered to be hazardous. The printer contains internally a Class IIIb (3b) laser that is nominally a 7 milliwatt gallium arsenide laser operating in the wavelength of 655-675 nanometers. The laser system and printer are designed so there is never any human access to laser radiation above a Class I level during normal operation, user maintenance, or prescribed service condition.

Laser advisory label

A laser notice label may be affixed to this printer as shown:

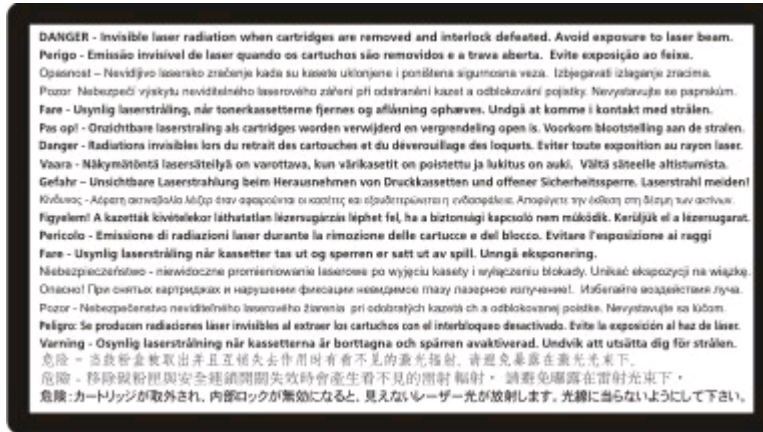

Power consumption

Product power consumption

The following table documents the power consumption characteristics of the product.

Note: Some modes may not apply to your product.

Mode	Description	Power consumption (Watts)
Printing	The product is generating hard-copy output from electronic inputs.	850 W
Copying	The product is generating hard-copy output from hard-copy original documents.	850 W
Scanning	The product is scanning hard-copy documents.	240 W
Ready	The product is waiting for a print job.	220 W
Power Saver	The product is in energy-saving mode.	45 W
Off	The product is plugged into a wall outlet, but the power switch is turned off.	110V = 0.15W, 220V = 1.25W

The power consumption levels listed in the previous table represent time-averaged measurements. Instantaneous power draws may be substantially higher than the average.

Values are subject to change. See www.lexmark.com for current values.

Power Saver

This product is designed with an energy-saving mode called Power Saver. The Power Saver Mode is equivalent to the EPA Sleep Mode. The Power Saver Mode saves energy by lowering power consumption during extended periods of inactivity. The Power Saver Mode is automatically engaged after this product is not used for a specified period of time, called the Power Saver Timeout.

Factory default Power Saver Timeout for this product (in minutes):	110V = 45 minutes, 220V = 60 minutes
--	--------------------------------------

By using the configuration menus, the Power Saver Timeout can be modified between 1 minute and 240 minutes. Setting the Power Saver Timeout to a low value reduces energy consumption, but may increase the response time of the product. Setting the Power Saver Timeout to a high value maintains a fast response, but uses more energy.

Off mode

If this product has an off mode which still consumes a small amount of power, then to completely stop product power consumption, disconnect the power supply cord from the wall outlet.

Total energy usage

It is sometimes helpful to calculate the total product energy usage. Since power consumption claims are provided in power units of Watts, the power consumption should be multiplied by the time the product spends in each mode in order to calculate energy usage. The total product energy usage is the sum of each mode's energy usage.

Statement of Limited Warranty

Lexmark X543, X544, X544t, X544w

Lexmark International, Inc., Lexington, KY

This limited warranty applies to the United States and Canada. For customers outside the U.S., refer to the country-specific warranty information that came with your product.

This limited warranty applies to this product only if it was originally purchased for your use, and not for resale, from Lexmark or a Lexmark Remarketer, referred to in this statement as "Remarketer."

Limited warranty

Lexmark warrants that this product:

- Is manufactured from new parts, or new and serviceable used parts, which perform like new parts
- Is, during normal use, free from defects in material and workmanship

If this product does not function as warranted during the warranty period, contact a Remarketer or Lexmark for repair or replacement (at Lexmark's option).

If this product is a feature or option, this statement applies only when that feature or option is used with the product for which it was intended. To obtain warranty service, you may be required to present the feature or option with the product.

If you transfer this product to another user, warranty service under the terms of this statement is available to that user for the remainder of the warranty period. You should transfer proof of original purchase and this statement to that user.

Limited warranty service

The warranty period starts on the date of original purchase as shown on the purchase receipt and ends 12 months later provided that the warranty period for any supplies and for any maintenance items included with the printer shall end earlier if it, or its original contents, are substantially used up, depleted, or consumed.

To obtain warranty service you may be required to present proof of original purchase. You may be required to deliver your product to the Remarketer or Lexmark, or ship it prepaid and suitably packaged to a Lexmark designated location. You are responsible for loss of, or damage to, a product in transit to the Remarketer or the Lexmark designated location.

When warranty service involves the exchange of a product or part, the item replaced becomes the property of the Remarketer or Lexmark. The replacement may be a new or repaired item.

The replacement item assumes the remaining warranty period of the original product.

Replacement is not available to you if the product you present for exchange is defaced, altered, in need of a repair not included in warranty service, damaged beyond repair, or if the product is not free of all legal obligations, restrictions, liens, and encumbrances.

Before you present this product for warranty service, remove all print cartridges, programs, data, and removable storage media (unless directed otherwise by Lexmark).

For further explanation of your warranty alternatives and the nearest Lexmark authorized servicer in your area contact Lexmark on the World Wide Web at <http://support.lexmark.com>.

Remote technical support is provided for this product throughout its warranty period. For products no longer covered by a Lexmark warranty, technical support may not be available or only be available for a fee.

Extent of limited warranty

Lexmark does not warrant uninterrupted or error-free operation of any product or the durability or longevity of prints produced by any product.

Warranty service does not include repair of failures caused by:

- Modification or unauthorized attachments
- Accidents, misuse, abuse or use inconsistent with Lexmark user's guides, manuals, instructions or guidance
- Unsuitable physical or operating environment
- Maintenance by anyone other than Lexmark or a Lexmark authorized servicer
- Operation of a product beyond the limit of its duty cycle
- Use of printing media outside of Lexmark specifications
- Refurbishment, repair, refilling or remanufacture by a third party of products, supplies or parts
- Products, supplies, parts, materials (such as toners and inks), software, or interfaces not furnished by Lexmark

TO THE EXTENT PERMITTED BY APPLICABLE LAW, NEITHER LEXMARK NOR ITS THIRD PARTY SUPPLIERS OR REMARKETERS MAKE ANY OTHER WARRANTY OR CONDITION OF ANY KIND, WHETHER EXPRESS OR IMPLIED, WITH RESPECT TO THIS PRODUCT, AND SPECIFICALLY DISCLAIM THE IMPLIED WARRANTIES OR CONDITIONS OF MERCHANTABILITY, FITNESS FOR A PARTICULAR PURPOSE, AND SATISFACTORY QUALITY. ANY WARRANTIES THAT MAY NOT BE DISCLAIMED UNDER APPLICABLE LAW ARE LIMITED IN DURATION TO THE WARRANTY PERIOD. NO WARRANTIES, EXPRESS OR IMPLIED, WILL APPLY AFTER THIS PERIOD. ALL INFORMATION, SPECIFICATIONS, PRICES, AND SERVICES ARE SUBJECT TO CHANGE AT ANY TIME WITHOUT NOTICE.

Limitation of liability

Your sole remedy under this limited warranty is set forth in this document. For any claim concerning performance or nonperformance of Lexmark or a Remarketer for this product under this limited warranty, you may recover actual damages up to the limit set forth in the following paragraph.

Lexmark's liability for actual damages from any cause whatsoever will be limited to the amount you paid for the product that caused the damages. This limitation of liability will not apply to claims by you for bodily injury or damage to real property or tangible personal property for which Lexmark is legally liable. **IN NO EVENT WILL LEXMARK BE LIABLE FOR ANY LOST PROFITS, LOST SAVINGS, INCIDENTAL DAMAGE, OR OTHER ECONOMIC OR CONSEQUENTIAL DAMAGES.** This is true even if you advise Lexmark or a Remarketer of the possibility of such damages. Lexmark is not liable for any claim by you based on a third party claim.

This limitation of remedies also applies to claims against any Suppliers and Remarketers of Lexmark. Lexmark's and its Suppliers' and Remarketers' limitations of remedies are not cumulative. Such Suppliers and Remarketers are intended beneficiaries of this limitation.

Additional rights

Some states do not allow limitations on how long an implied warranty lasts, or do not allow the exclusion or limitation of incidental or consequential damages, so the limitations or exclusions contained above may not apply to you.

This limited warranty gives you specific legal rights. You may also have other rights that vary from state to state.

DEVICE PATENT LICENSE

Lexmark reserves the right to discontinue selling these toner cartridges any time after it discontinues service support for this printer.

IMPORTANT: PLEASE READ BEFORE OPENING: Opening this package, installing the printing device software, or using the products inside confirms your acceptance of the following licenses/agreements:

License: The patented printer inside is licensed for, and designed to work with only genuine Lexmark toner cartridges and developer components for the life of the patented printer. You agree to: (1) use only genuine Lexmark toner cartridges and developer components with this printer except as otherwise provided below, and (2) pass this license/agreement to any subsequent user of this printer. The patented Lexmark toner cartridges and developer components inside are licensed subject to a restriction that they may be used only once. Following their initial use, you agree to return them only to Lexmark for recycling. Lexmark toner cartridges are designed to stop working after delivering a fixed amount of toner. A variable amount of toner may remain in them when replacement is required.

If you do not accept these terms, return the unopened package to your point of purchase. Replacement toner cartridge(s) sold without these terms are available through www.lexmark.com, may be refilled by you, or a third party, as the only cartridge alternative to be used with the licensed printer.

LEXMARK SOFTWARE LIMITED WARRANTY AND LICENSE AGREEMENTS

PLEASE READ CAREFULLY BEFORE USING THIS PRODUCT: BY USING THIS PRODUCT, YOU AGREE TO BE BOUND BY ALL THE TERMS AND CONDITIONS OF THIS SOFTWARE LIMITED WARRANTY AND LICENSE AGREEMENTS. IF YOU DO NOT AGREE WITH THE TERMS OF THIS SOFTWARE LIMITED WARRANTY AND LICENSE AGREEMENTS, PROMPTLY RETURN THE PRODUCT UNUSED AND REQUEST A REFUND OF THE AMOUNT YOU PAID. IF YOU ARE INSTALLING THIS PRODUCT FOR USE BY OTHER PARTIES, YOU AGREE TO INFORM THE USERS THAT USE OF THE PRODUCT INDICATES ACCEPTANCE OF THESE TERMS.

DEVICE LICENSE AGREEMENT

The patented printer is licensed for, and designed to work with only genuine Lexmark toner cartridges and developer components for the life of the patented printer. Under this patent license, you agree to: (1) use only genuine Lexmark toner cartridges and developer components with this printer except as otherwise provided below, and (2) pass this license/agreement to any subsequent user of this printer. The patented Lexmark toner cartridges and developer components inside are licensed subject to a restriction that they may be used only once. Following their initial use, you agree to return them only to Lexmark for recycling. Lexmark toner cartridges are designed to stop working after a delivering a fixed amount of toner. A variable amount of toner may remain in them when replacement is required. Replacement toner cartridge(s) sold without these terms are available through www.lexmark.com, may be refilled by you, or a third party, as the only cartridge alternative to be used with the licensed printer.

LEXMARK SOFTWARE LICENSE AGREEMENT

This Software License Agreement ("Software License Agreement") is a legal agreement between you (either an individual or a single entity) and Lexmark International, Inc. ("Lexmark") that, to the extent your Lexmark product or Software Program is not otherwise subject to a written software license agreement between you and Lexmark or its suppliers, governs your use of any Software Program installed on or provided by Lexmark for use in connection with your Lexmark product. The term "Software Program" includes machine-readable instructions, audio/visual content (such as images and recordings), and associated media, printed materials and electronic documentation, whether incorporated into, distributed with or for use with your Lexmark product.

- 1 STATEMENT OF SOFTWARE LIMITED WARRANTY.** Lexmark warrants that the media (e.g., diskette or compact disk) on which the Software Program (if any) is furnished is free from defects in materials and workmanship under normal use during the warranty period. The warranty period is ninety (90) days and commences on the date the Software Program is delivered to the original end-user. This limited warranty applies only to Software Program media purchased new from Lexmark or an Authorized Lexmark Reseller or Distributor. Lexmark will replace the Software Program should it be determined that the media does not conform to this limited warranty.
- 2 DISCLAIMER AND LIMITATION OF WARRANTIES.** EXCEPT AS PROVIDED IN THIS SOFTWARE LICENSE AGREEMENT AND TO THE MAXIMUM EXTENT PERMITTED BY APPLICABLE LAW, LEXMARK AND ITS SUPPLIERS PROVIDE THE SOFTWARE PROGRAM "AS IS" AND HEREBY DISCLAIM ALL OTHER WARRANTIES AND CONDITIONS, EITHER EXPRESS OR IMPLIED, INCLUDING, BUT NOT LIMITED TO, TITLE, NON-INFRINGEMENT, MERCHANTABILITY AND FITNESS FOR A PARTICULAR PURPOSE, AND ABSENCE OF VIRUSES, ALL WITH REGARD TO THE SOFTWARE PROGRAM. TO THE EXTENT LEXMARK CANNOT BY LAW DISCLAIM ANY COMPONENT OF THE IMPLIED WARRANTIES OF MERCHANTABILITY OR FITNESS FOR A PARTICULAR PURPOSE, LEXMARK LIMITS THE DURATION OF SUCH WARRANTIES TO THE 90-DAY TERM OF THE EXPRESS SOFTWARE LIMITED WARRANTY.

This Agreement is to be read in conjunction with certain statutory provisions, as that may be in force from time to time, that imply warranties or conditions or impose obligations on Lexmark that cannot be excluded or modified. If any such provisions apply, then to the extent Lexmark is able, Lexmark hereby limits its liability for breach of those provisions to one of the following: providing you a replacement copy of the Software Program or reimbursement of the price paid for the Software Program.

The Software Program may include internet links to other software applications and/or internet web pages hosted and operated by third parties unaffiliated with Lexmark. You acknowledge and agree that Lexmark is not responsible in any way for the hosting, performance, operation, maintenance, or content of, such software applications and/or internet web pages.

3 LIMITATION OF REMEDY. TO THE MAXIMUM EXTENT PERMITTED BY APPLICABLE LAW, ANY AND ALL LIABILITY OF LEXMARK UNDER THIS SOFTWARE LICENSE AGREEMENT IS EXPRESSLY LIMITED TO THE GREATER OF THE PRICE PAID FOR THE SOFTWARE PROGRAM AND FIVE U.S. DOLLARS (OR THE EQUIVALENT IN LOCAL CURRENCY). YOUR SOLE REMEDY AGAINST LEXMARK IN ANY DISPUTE UNDER THIS SOFTWARE LICENSE AGREEMENT SHALL BE TO SEEK TO RECOVER ONE OF THESE AMOUNTS, UPON PAYMENT OF WHICH LEXMARK SHALL BE RELEASED AND DISCHARGED OF ALL FURTHER OBLIGATIONS AND LIABILITY TO YOU.

IN NO EVENT WILL LEXMARK, ITS SUPPLIERS, SUBSIDIARIES, OR RESELLERS BE LIABLE FOR ANY SPECIAL, INCIDENTAL, INDIRECT, EXEMPLARY, PUNITIVE, OR CONSEQUENTIAL DAMAGES (INCLUDING BUT NOT LIMITED TO LOST PROFITS OR REVENUES, LOST SAVINGS, INTERRUPTION OF USE OR ANY LOSS OF, INACCURACY IN, OR DAMAGE TO, DATA OR RECORDS, FOR CLAIMS OF THIRD PARTIES, OR DAMAGE TO REAL OR TANGIBLE PROPERTY, FOR LOSS OF PRIVACY ARISING OUT OR IN ANY WAY RELATED TO THE USE OF OR INABILITY TO USE THE SOFTWARE PROGRAM, OR OTHERWISE IN CONNECTION WITH ANY PROVISION OF THIS SOFTWARE LICENCE AGREEMENT), REGARDLESS OF THE NATURE OF THE CLAIM, INCLUDING BUT NOT LIMITED TO BREACH OF WARRANTY OR CONTRACT, TORT (INCLUDING NEGLIGENCE OR STRICT LIABILITY), AND EVEN IF LEXMARK, OR ITS SUPPLIERS, AFFILIATES, OR REMARKETERS HAVE BEEN ADVISED OF THE POSSIBILITY OF SUCH DAMAGES, OR FOR ANY CLAIM BY YOU BASED ON A THIRD-PARTY CLAIM, EXCEPT TO THE EXTENT THIS EXCLUSION OF DAMAGES IS DETERMINED LEGALLY INVALID. THE FOREGOING LIMITATIONS APPLY EVEN IF THE ABOVE-STATED REMEDIES FAIL OF THEIR ESSENTIAL PURPOSE.

4 U.S.A. STATE LAWS. This Software Limited Warranty gives you specific legal rights. You may also have other rights that vary from state to state. Some states do not allow limitations on how long an implied warranty lasts or the exclusion of limitation of incidental or consequential damages, so the above limitations may not apply to you.

5 LICENSE GRANT. Lexmark grants you the following rights provided you comply with all terms and conditions of this Software License Agreement:

- a Use.** You may Use one (1) copy of the Software Program. The term "Use" means storing, loading, installing, executing, or displaying the Software Program. If Lexmark has licensed the Software Program to you for concurrent use, you must limit the number of authorized users to the number specified in your agreement with Lexmark. You may not separate the components of the Software Program for use on more than one computer. You agree that you will not Use the Software Program, in whole or in part, in any manner that has the effect of overriding, modifying, eliminating, obscuring, altering or de-emphasizing the visual appearance of any trademark, trade name, trade dress or intellectual property notice that appears on any computer display screens normally generated by, or as a result of, the Software Program.
- b Copying.** You may make one (1) copy of the Software Program solely for purposes of backup, archiving, or installation, provided the copy contains all of the original Software Program's proprietary notices. You may not copy the Software Program to any public or distributed network.
- c Reservation of Rights.** The Software Program, including all fonts, is copyrighted and owned by Lexmark International, Inc. and/or its suppliers. Lexmark reserves all rights not expressly granted to you in this Software License Agreement.
- d Freeware.** Notwithstanding the terms and conditions of this Software License Agreement, all or any portion of the Software Program that constitutes software provided under public license by third parties ("Freeware") is licensed to you subject to the terms and conditions of the software license agreement accompanying such Freeware, whether in the form of a discrete agreement, shrink-wrap license, or electronic license terms at the time of download or installation. Use of the Freeware by you shall be governed entirely by the terms and conditions of such license.

- 6 TRANSFER.** You may transfer the Software Program to another end-user. Any transfer must include all software components, media, printed materials, and this Software License Agreement and you may not retain copies of the Software Program or components thereof. The transfer may not be an indirect transfer, such as a consignment. Prior to the transfer, the end-user receiving the transferred Software Program must agree to all these Software License Agreement terms. Upon transfer of the Software Program, your license is automatically terminated. You may not rent, sublicense, or assign the Software Program except to the extent provided in this Software License Agreement.
- 7 UPGRADES.** To Use a Software Program identified as an upgrade, you must first be licensed to the original Software Program identified by Lexmark as eligible for the upgrade. After upgrading, you may no longer use the original Software Program that formed the basis for your upgrade eligibility.
- 8 LIMITATION ON REVERSE ENGINEERING.** You may not alter, decrypt, reverse engineer, reverse assemble, reverse compile or otherwise translate the Software Program or assist or otherwise facilitate others to do so, except as and to the extent expressly permitted to do so by applicable law for the purposes of inter-operability, error correction, and security testing. If you have such statutory rights, you will notify Lexmark in writing of any intended reverse engineering, reverse assembly, or reverse compilation. You may not decrypt the Software Program unless necessary for the legitimate Use of the Software Program.
- 9 ADDITIONAL SOFTWARE.** This Software License Agreement applies to updates or supplements to the original Software Program provided by Lexmark unless Lexmark provides other terms along with the update or supplement.
- 10 TERM.** This Software License Agreement is effective unless terminated or rejected. You may reject or terminate this license at any time by destroying all copies of the Software Program, together with all modifications, documentation, and merged portions in any form, or as otherwise described herein. Lexmark may terminate your license upon notice if you fail to comply with any of the terms of this Software License Agreement. Upon such termination, you agree to destroy all copies of the Software Program together with all modifications, documentation, and merged portions in any form.
- 11 TAXES.** You agree that you are responsible for payment of any taxes including, without limitation, any goods and services and personal property taxes, resulting from this Software License Agreement or your Use of the Software Program.
- 12 LIMITATION ON ACTIONS.** No action, regardless of form, arising out of this Software License Agreement may be brought by either party more than two years after the cause of action has arisen, except as provided under applicable law.
- 13 APPLICABLE LAW.** This Software License Agreement is governed by the laws of the Commonwealth of Kentucky, United States of America. No choice of law rules in any jurisdiction shall apply. The UN Convention on Contracts for the International Sale of Goods shall not apply.
- 14 UNITED STATES GOVERNMENT RESTRICTED RIGHTS.** The Software Program has been developed entirely at private expense. Rights of the United States Government to use the Software Program are as set forth in this Software License Agreement and as restricted in DFARS 252.227-7014 and in similar FAR provisions (or any equivalent agency regulation or contract clause).
- 15 CONSENT TO USE OF DATA.** You agree that Lexmark, its affiliates, and agents may collect and use information you provide in relation to support services performed with respect to the Software Program and requested by you. Lexmark agrees not to use this information in a form that personally identifies you except to the extent necessary to provide such services.
- 16 EXPORT RESTRICTIONS.** You may not (a) acquire, ship, transfer, or reexport, directly or indirectly, the Software Program or any direct product therefrom, in violation of any applicable export laws or (b) permit the Software Program to be used for any purpose prohibited by such export laws, including, without limitation, nuclear, chemical, or biological weapons proliferation.

- 17 AGREEMENT TO CONTRACT ELECTRONICALLY.** You and Lexmark agree to form this Software License Agreement electronically. This means that when you click the “Agree” or “I accept” button on this page or use this product, you acknowledge your agreement to these Software License Agreement terms and conditions and that you are doing so with the intent to “sign” a contract with Lexmark.
- 18 CAPACITY AND AUTHORITY TO CONTRACT.** You represent that you are of the legal age of majority in the place you sign this Software License Agreement and, if applicable, you are duly authorized by your employer or principal to enter into this contract.
- 19 ENTIRE AGREEMENT.** This Software License Agreement (including any addendum or amendment to this Software License Agreement that is included with the Software Program) is the entire agreement between you and Lexmark relating to the Software Program. Except as otherwise provided for herein, these terms and conditions supersede all prior or contemporaneous oral or written communications, proposals, and representations with respect to the Software Program or any other subject matter covered by this Software License Agreement (except to the extent such extraneous terms do not conflict with the terms of this Software License Agreement, any other written agreement signed by you and Lexmark relating to your Use of the Software Program). To the extent any Lexmark policies or programs for support services conflict with the terms of this Software License Agreement, the terms of this Software License Agreement shall control.

MICROSOFT CORPORATION NOTICES

- 1** This product may incorporate intellectual property owned by Microsoft Corporation. The terms and conditions upon which Microsoft is licensing such intellectual property may be found at <http://go.microsoft.com/fwlink/?LinkId=52369>.
- 2** This product is based on Microsoft Print Schema technology. You may find the terms and conditions upon which Microsoft is licensing such intellectual property at <http://go.microsoft.com/fwlink/?LinkId=83288>.

Index

Numerics

150 displayed 157
200 Paper jam <area name> 158
201.yy Paper jam <area name> 158
202.yy Paper jam <area name> 158
230.yy Paper jam <area name> 158
235 Paper Jam Check Duplex 158
24x Paper Jam Check Tray <x> 158
250.yy Paper jam <area name> 159
250-sheet tray (standard)
 loading 38
290–292 ADF Scanning Jams 159
293 Paper Missing 159
293.02 Flatbed Cover Open 159
294 ADF Jam 159
30.yy <color> cartridge missing 154
31 Defective Imaging Kit 154
34 Short paper 155
35 Insufficient memory to support Resource Save feature 155
37 Insufficient memory to collate job 155
38 Memory Full 155
39 Complex page, some data may not have printed 155
40 <color> Invalid refill, change cartridge 155
50 PPDS Font Error 155
51 Defective flash detected 156
52 Not enough free space in flash memory for resources 156
53 Unformatted flash detected 156
54 Network <x> Software Error 156
56 Standard USB Port Disabled 156
58 Too many flash options installed 156
58 Too many trays attached 157
59 Incompatible tray <x> 157
650-sheet duo drawer
 installing 30

650-sheet duo drawer (optional)
 loading 40
82 Replace waste toner box 157
82.yy Waste toner box missing 157
840.01 Scanner Disabled 160
840.02 Scanner Auto Disabled 160
88.yy <color> Cartridge is low 157
88.yy Replace <color>
 Cartridge 157
900–999 Service <message> 161
940.01 160
940.02 160
941.01 160
941.02 160
942.01 160
942.02 161
943.01 160
943.02 161

A

Access USB after scan 148
Access USB now 148
Active NIC menu 119
address book, e-mail
 setting up 70
address book, fax
 using 91
ADF
 copying using 61
attaching cables 32

B

battery, clock 148
Black Low 149
Busy 148
buttons, printer control panel 17

C

cables
 Ethernet 32
 USB 32
Calibrating 148
Call complete 148
calling Customer Support 220
Cancel not available 148
Canceling 148

canceling a job
 from Macintosh 59
 from the printer control panel 59
 from Windows 59
card stock
 loading 41
 tips on using 56
Check Config ID 148
checking an unresponsive printer 193
checking an unresponsive scanner 198
cleaning
 exterior of the printer 187
 scanner glass 188
clock battery 148
Close door 148
collating copies 66
configurations
 printer 16
connecting the printer to
 computer modem 85
conserving supplies 162
contacting Customer Support 220
control panel, printer 17
copy quality
 adjusting 66
 improving 68
Copy Settings menu 126
copy troubleshooting
 copier does not respond 196
 partial document or photo
 copies 198
 poor copy quality 197
 poor scanned image quality 199
 scanner unit does not close 196
copying
 adjusting quality 66
 canceling a copy job 68
 collating copies 66
 enlarging 65
 from one size to another 63
 improving copy quality 68
 making a copy lighter or
 darker 65
 multiple pages on one sheet 67
 on both sides of the paper
 (duplexing) 64

- photos 62
- placing separator sheets between copies 67
- quick copy 61
- reducing 65
- selecting a tray 64
- to letterhead 63
- to transparencies 62
- using the ADF 61
- using the scanner glass 62

Custom Scan Sizes menu 117

Custom Types menu 116

Cyan Low 149

D

- date and time
 - setting 87
- Default Source menu 109
- Defective <color> Cartridge 154
- Dialing 149
- directory list, printing 59
- display troubleshooting
 - display is blank 193
 - display shows only diamonds 193
- display, printer control panel 17
- distinctive ring service
 - connecting to 78
- DO NOT TOUCH 149
- documents, printing
 - from Macintosh computer 52
 - from Windows 52
- duplexing 64

E

- Embedded Web Server 191
 - administrator settings 190
 - does not open 220
 - networking settings 190
 - setting up e-mail alerts 191
- Embedded Web Server Administrator's Guide 190
- emission
 - notices 222, 223, 224, 225, 226
- enlarging a copy 65
- envelopes
 - loading 41, 43
 - tips 54
- Ethernet port 32
- exterior of the printer
 - cleaning 187

- e-mail
 - canceling 72
 - notice of low supply level 191
 - notice of paper jam 191
 - notice of paper needed 191
 - notice that different paper is needed 191
- e-mail function
 - setting up 69
- e-mailing
 - creating shortcuts using the Embedded Web Server 70
 - setting up address book 70
 - setting up e-mail function 69
 - using shortcut numbers 71
 - using the address book 72
 - using the keypad 70

F

- FAQ about color printing 217
- fax
 - canceling 93
 - options 93, 94
- Fax complete 149
- fax connection
 - connecting the printer to the wall jack 76
 - connecting to a distinctive ring service 78
 - connecting to a DSL line 76
 - connecting to a PBX or ISDN 77
- Fax failed 149
- fax quality, improving 94
- Fax Settings menu 128
- fax troubleshooting
 - blocking junk faxes 204
 - caller ID is not shown 200
 - can receive but not send faxes 203
 - can send but not receive faxes 202
 - cannot send or receive a fax 201
 - received fax has poor print quality 203
- faxing
 - changing resolution 91
 - choosing a fax connection 75
 - connecting to a telephone 79
 - connecting to an answering machine 79
 - connecting to regional adapters 81

- creating shortcuts using the Embedded Web Server 89
- creating shortcuts using the printer control panel 90
- fax setup 74
- forwarding faxes 95
- holding faxes 94
- improving fax quality 94
- making a fax lighter or darker 92
- sending a fax at a scheduled time 92
- sending using the computer 89
- sending using the printer control panel 88
- setting the date and time 87
- setting the outgoing fax name and number 87
- turning daylight saving time on or off 88
- using shortcuts 91
- using the address book 91
- viewing a fax log 92
- FCC notices 222, 223, 226
- features
 - Scan Center 98
- File corrupt 149
- finding information
 - customer support 13
 - publications 13
- Finishing menu 137
- flash drive 56
- Flash Drive menu 134
- flash memory card
 - installing 27
- Flushing buffer 149
- font sample list
 - printing 58
- forwarding faxes 95

G

- guidelines
 - card stock 56
 - envelopes 54
 - labels, paper 55
 - letterhead 53
 - transparencies 54

H

- Hex Trace 149
- holding faxes 94

I

Image menu 144
Imaging Kit 149
imaging kits
 ordering 164
 replacing 168, 174
Incoming call 149
Insert Tray <x> 149
installing
 options in driver 34
 printer software 34
installing printer software
 adding options 34
Invalid Engine Code 150
Invalid Network Code 150

J

jams
 avoiding 100
 locating doors and trays 101
 locations 101
 numbers 101
jams, clearing
 200 102
 201 102
 202 103
 230 105
 235 105
 242 105
 250 106
 290 106

L

labels, paper
 tips on using 55
LADP connection error 150
letterhead
 copying to 63
 loading, manual feeder 53
 loading, trays 53
 tips on using 53
light, indicator 17
Line busy 150
linking trays 36
Load <src> with <x> 150
Load single sheet feeder with
<x> 150
loading
 250-sheet tray (standard) 38
 650-sheet duo drawer
 (optional) 40

card stock 41
envelopes 41, 43
letterhead in manual feeder 53
letterhead in trays 53
manual feeder 43
multipurpose feeder 41
transparencies 41

M

Magenta Low 149
Maintenance 150
manual feeder
 loading 43
memory card
 installing 23
 troubleshooting 206
Memory full, cannot send
faxes 150
menu settings pages, printing 33
menus
 Active NIC 119
 Copy Settings 126
 Custom Scan Sizes 117
 Custom Types 116
 Default Source 109
 diagram of 108
 Fax Settings 128
 Finishing 137
 Flash Drive 134
 Image 144
 Network 119
 Paper Loading 115
 Paper Size/Type 110
 Paper Texture 112
 PCL Emul 142
 PDF 141
 PictBridge 145
 PostScript 142
 Quality 139
 Reports 118
 Set Date and Time 146
 Settings 123
 Setup 137
 Supplies 109
 USB 121
 Utilities 141
 Wireless 120
Menus disabled 151
moving the printer 188, 189
multiple pages on one sheet 67
multipurpose feeder
 loading 41

N

Network menu 119
network setup page 33
Networking Guide 190
No analog phone line 151
No answer 151
No dial tone 151
No recognized file types 151
noise emission levels 226
notices 222, 223, 224, 225, 226,
227, 228, 229, 230, 231, 232

O

options
 650-sheet duo drawer 30
 fax 93, 94
 flash memory card 27
 internal 23
 memory card 23
 memory cards 23
 scan to computer 98
ordering
 imaging kits 164
 toner cartridges 163
 waste toner bottle 164

P

paper
 capacities 50
 characteristics 45
 letterhead 46
 preprinted forms 46
 recycled 51
 selecting 46
 selecting weight 114
 setting size 37
 setting type 37
 storing 47
 unacceptable 46
 Universal Paper Size 117
 Universal size setting 37
paper feed troubleshooting
 message remains after jam is
 cleared 206
paper jams
 avoiding 100
Paper Loading menu 115
Paper Size/Type menu 110
paper sizes
 supported by the printer 47
Paper Texture menu 112

- paper types
 - duplex support 48
 - supported by printer 48
 - where to load 48
- paper types and weights
 - supported by the printer 49
- PC Kit Life Warning 151
- PCL Emul menu 142
- PDF menu 141
- Phone in Use 151
- photos
 - copying 62
- PictBridge menu 145
- PictBridge-enabled printing
 - photos 58
- Picture too large 151
- PostScript menu 142
- Power Saver 151
 - adjusting 190
- print job
 - canceling from Macintosh 59
 - canceling from the printer control panel 59
 - canceling from Windows 59
- print quality
 - cleaning the scanner glass 188
 - replacing developer unit 181
 - replacing imaging kits 168, 174
 - replacing the waste toner bottle 165
- print quality test pages, printing 59
- print quality troubleshooting
 - blank pages 207
 - characters have jagged edges 207
 - clipped images 208
 - color misregistration 216
 - dark lines 208
 - gray background 208
 - light colored line, white line, or incorrectly colored line 209
 - poor transparency quality 215
 - print irregularities 210
 - print is too dark 213
 - print is too light 211
 - repeating defects 211
 - skewed print 211
 - solid color pages 214
 - toner fog or background shading 214
 - toner rubs off 214
 - toner specks 215
 - uneven print density 216
- print troubleshooting
 - error reading USB drive 193
 - incorrect characters print 195
 - incorrect margins 209
 - jammed page does not reprint 206
 - job prints from wrong tray 195
 - job prints on wrong paper 195
 - job takes longer than expected 194
 - jobs do not print 194
 - Large jobs do not collate 195
 - multiple-language PDFs do not print 193
 - paper curl 210
 - paper frequently jams 206
 - tray linking does not work 195
 - unexpected page breaks occur 196
- printer
 - configurations 16
 - minimum clearances 14
 - models 16
 - moving 188, 189
 - selecting a location 14
 - shipping 189
- printer messages
 - 150 displayed 157
 - 200 Paper jam <area name> 158
 - 201.yy Paper jam <area name> 158
 - 202.yy Paper jam <area name> 158
 - 230.yy Paper jam <area name> 158
 - 235 Paper Jam Check Duplex 158
 - 24x Paper Jam Check Tray <x> 158
 - 250.yy Paper jam <area name> 159
 - 290–292 ADF Scanning Jams 159
 - 293 Paper Missing 159
 - 293.02 Flatbed Cover Open 159
 - 294 ADF Jam 159
 - 30.yy <color> cartridge missing 154
 - 31 Defective Imaging Kit 154
 - 34 Short paper 155
 - 35 Insufficient memory to support Resource Save feature 155
- 37 Insufficient memory to collate job 155
- 38 Memory Full 155
- 39 Complex page, some data may not have printed 155
- 40 <color> Invalid refill, change cartridge 155
- 50 PPDS Font Error 155
- 51 Defective flash detected 156
- 52 Not enough free space in flash memory for resources 156
- 53 Unformatted flash detected 156
- 54 Network <x> Software Error 156
- 56 Standard USB Port Disabled 156
- 58 Too many flash options installed 156
- 58 Too many trays attached 157
- 59 Incompatible tray <x> 157
- 82 Replace waste toner bottle 165
- 82 Replace waste toner box 157
- 82.yy Waste toner box missing 157
- 840.01 Scanner Disabled 160
- 840.02 Scanner Auto Disabled 160
- 88 Replace <color> Cartridge 179
- 88.yy <color> Cartridge is low 157
- 88.yy Replace <color> Cartridge 157
- 900–999 Service <message> 161
- 940.01 160
- 940.02 160
- 941.01 160
- 941.02 160
- 942.01 160
- 942.02 161
- 943.01 160
- 943.02 161
- Access USB after scan 148
- Access USB now 148
- Black Low 149
- Busy 148
- Calibrating 148
- Call complete 148
- Cancel not available 148
- Canceling 148
- Check Config ID 148

- clock battery 148
 - Close door 148
 - Cyan Low 149
 - Defective <color> Cartridge 154
 - Dialing 149
 - DO NOT TOUCH 149
 - Fax complete 149
 - Fax failed 149
 - File corrupt 149
 - Flushing buffer 149
 - Hex Trace 149
 - Imaging Kit 149, 168, 174
 - Incoming call 149
 - Insert Tray <x> 149
 - Invalid Engine Code 150
 - Invalid Network Code 150
 - LADP connection error 150
 - Line busy 150
 - Load <src> with <x> 150
 - Load single sheet feeder with <x> 150
 - Magenta Low 149
 - Maintenance 150
 - Memory full, cannot send faxes 150
 - Menus disabled 151
 - No analog phone line 151
 - No answer 151
 - No dial tone 151
 - No recognized file types 151
 - PC Kit Life Warning 151
 - Phone in Use 151
 - Picture too large 151
 - Power Saver 151
 - Printing error 152
 - Programming Code 152
 - Reading data 152
 - Reading error 152
 - Ready 152
 - Receiving pXX 152
 - Reload printed pages in Tray <x> 152
 - Remote Management Active 152
 - Remove originals from the scanner ADF 152
 - Remove packaging material 152
 - Remove paper from standard output bin 152
 - Replace <color> cartridge 153
 - Replace PC Kit 153
 - Replace Unsupported <color> Cartridge 155
 - Scan Document Too Long 153
 - Scan to USB failed 153
 - Scanner ADF Cover Open 153
 - Sending pXX 153
 - Standard Exit Bin Full 153
 - Tray <x> Empty 153
 - Tray <x> Low 153
 - Tray <x> Missing 154
 - Unsupported Mode 154
 - Unsupported USB device, please remove 154
 - Unsupported USB hub, please remove 154
 - USB drive disabled 154
 - Use camera controls to print 154
 - Waiting 154
 - Waiting, too many events 154
 - Yellow Low 149
 - printer options troubleshooting
 - drawers 205
 - memory card 206
 - multipurpose feeder 205
 - option not working 204
 - printer problems, solving basic 193
 - printing
 - directory list 59
 - font sample list 58
 - from flash drive 56
 - from Macintosh computer 52
 - from Windows 52
 - installing printer software 34
 - menu settings pages 33
 - network setup page 33
 - photos 58
 - print quality test pages 59
 - Printing error 152
 - Programming Code 152
- Q**
- Quality menu 139
- R**
- Reading data 152
 - Reading error 152
 - Ready 152
 - Receiving pXX 152
 - recycled paper using 51
 - recycling
 - Lexmark products 187
 - WEEE statement 229
 - reducing a copy 65
 - Reload printed pages in Tray <x> 152
 - Remote Management Active 152
 - Remove originals from the scanner ADF 152
 - Remove packaging material 152
 - Remove paper from standard output bin 152
 - Replace <color> cartridge 153
 - Replace PC Kit 153
 - Replace Unsupported <color> Cartridge 155
 - reports
 - viewing 192
 - Reports menu 118
 - resolution, fax
 - changing 91
 - restoring factory default settings 190
- S**
- safety information 11, 12
 - Scan Center features 98
 - Scan Document Too Long 153
 - scan quality, improving 98
 - scan to computer
 - options 98
 - Scan to USB failed 153
 - scan troubleshooting
 - cannot scan from a computer 200
 - partial document or photo scans 200
 - scan was not successful 199
 - scanner unit does not close 196
 - scanning takes too long or freezes the computer 199
 - ScanBack Utility
 - using the ScanBack Utility 99
 - scanner
 - Automatic Document Feeder (ADF) 17
 - functions 16
 - scanner glass 17
 - Scanner ADF Cover Open 153
 - scanner glass
 - cleaning 188
 - copying using 62
 - scanning to a computer 96
 - improving scan quality 98

- scanning to a USB flash memory device 97
- Sending pXX 153
- Set Date and Time menu 146
- setting
 - Active NIC 119
 - paper size 37
 - paper type 37
 - Universal Paper Size 37
- Settings menu 123
- Setup menu 137
- shipping the printer 189
- shortcuts, creating
 - e-mail 70
 - fax destination 89, 90
- Standard Exit Bin Full 153
- standard tray
 - loading 38
- status of supplies, checking 162
- storing
 - paper 47
 - supplies 162
- supplies
 - conserving 162
 - status of 162
 - storing 162
- Supplies menu 109
- supplies, ordering
 - imaging kits 164
 - toner cartridges 163
 - waste toner bottle 164

T

- telecommunication
 - notices 226, 227, 228, 229
- toner cartridges
 - ordering 163
 - replacing 179
- transparencies
 - copying to 62
 - loading 41
 - tips on using 54
- Tray <x> Empty 153
- Tray <x> Low 153
- Tray <x> Missing 154
- tray linking 36
- tray unlinking 36
- trays
 - linking 36
 - unlinking 36

- troubleshooting
 - checking an unresponsive printer 193
 - checking an unresponsive scanner 198
 - contacting Customer Support 220
 - FAQ about color printing 217
 - solving basic printer problems 193
- troubleshooting, copy
 - copier does not respond 196
 - partial document or photo copies 198
 - poor copy quality 197
 - poor scanned image quality 199
 - scanner unit does not close 196
- troubleshooting, display
 - display is blank 193
 - display shows only diamonds 193
- troubleshooting, fax
 - blocking junk faxes 204
 - caller ID is not shown 200
 - can receive but not send faxes 203
 - can send but not receive faxes 202
 - cannot send or receive a fax 201
 - received fax has poor print quality 203
- troubleshooting, paper feed
 - message remains after jam is cleared 206
- troubleshooting, print
 - error reading USB drive 193
 - incorrect characters print 195
 - incorrect margins 209
 - jammed page does not reprint 206
 - job prints from wrong tray 195
 - job prints on wrong paper 195
 - job takes longer than expected 194
 - jobs do not print 194
 - Large jobs do not collate 195
 - multiple-language PDFs do not print 193
 - paper curl 210
 - paper frequently jams 206
 - tray linking does not work 195

- unexpected page breaks
 - occur 196
- troubleshooting, print quality
 - blank pages 207
 - characters have jagged edges 207
 - clipped images 208
 - color misregistration 216
 - dark lines 208
 - gray background 208
 - light colored line, white line, or incorrectly colored line 209
 - poor transparency quality 215
 - print irregularities 210
 - print is too dark 213
 - print is too light 211
 - repeating defects 211
 - skewed print 211
 - solid color pages 214
 - toner fog or background shading 214
 - toner rubs off 214
 - toner specks 215
 - uneven print density 216
- troubleshooting, printer options
 - drawers 205
 - memory card 206
 - multipurpose feeder 205
 - option not working 204
- troubleshooting, scan
 - cannot scan from a computer 200
 - partial document or photo scans 200
 - scan was not successful 199
 - scanner unit does not close 196
 - scanning takes too long or freezes the computer 199

U

- Universal Paper Size 117
 - setting 37
- Universal Setup menu 117
- unlinking trays 36
- Unsupported Mode 154
- Unsupported USB device, please remove 154
- Unsupported USB hub, please remove 154
- USB drive disabled 154
- USB menu 121
- USB port 32

Use camera controls to print 154

Utilities menu 141

V

viewing

reports 192

W

Waiting 154

Waiting, too many events 154

waste toner bottle

ordering 164

replacing 165

Wireless menu 120

Y

Yellow Low 149