

GB

English

GB

SUTCD 97B

First time you turn on your dryer you must select your preferred language see page 8

TUMBLE DRYER



This symbol reminds you to read this booklet.

! Keep this instruction booklet on hand in order to refer to it when necessary. Take it with you when you move, and should you sell this appliance or pass it on to another party, make sure that this booklet is supplied along with the dryer so that the new owner may be informed about warnings and suggestions on how the appliance works.

! Read these instructions carefully; the following pages contain important information on installation and suggestions on how the appliance works.

Contents

Installation, 2

Where to put your dryer
Ventilation
Water drain
Electrical connection
Before you start using your dryer

Warnings, 3-4

General safety
To minimise the risk of fire

Maintenance and Care, 5-6

Switching off the electricity
Cleaning the filter after each cycle
Cleaning the condenser unit
Empty the water container after each cycle
Check the drum after each cycle
Cleaning the dryer

Dryer description, 7

The features
Control panel

The Display, 8-10

Start and programmes, 10-14

Choosing a programme
Programmes Table
The Controls

Laundry, 15

Sorting your laundry
Wash care labels
Drying times

Troubleshooting, 16

Service, 17

Spare Parts
Recycling and Disposal

Product data, 18

**To activate your free* 5 Year Parts Guarantee
Call free on 0800 519 2102**

*Labour charges not included. Terms and conditions apply. Lines open 364 days a year. Calls are free from a BT landline. Charges from other providers and mobiles may apply.

Installation

GB

Where to put your dryer

- Place your dryer at a distance from gas ranges, stoves, heaters, or cook tops because flames can damage the appliance.

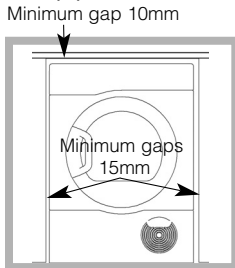

- If you are going to install the appliance under a work counter, be sure to leave a 10mm space between the top and any other objects on or above the machine and a 15mm space between

the sides and lateral furnishings or walls. This is to ensure proper air circulation.

The appliance must be installed with the rear surface placed against a wall.

Ventilation

When the dryer is in use, there has to be adequate ventilation. Make sure you put your dryer in an environment that is not damp and has proper air circulation throughout. Airflow around the dryer is essential to condense the water produced during the washing, the dryer will not operate efficiently in an enclosed space or cupboard.

! If using the dryer in a small or cold room some condensation could be experienced.

! We do not recommend that the dryer is installed in a cupboard but the dryer must never be installed behind a lockable door, a sliding door or a door with a hinge on the opposite side to that of the dryer door.

Water drain

If your dryer is installed next to a drain the water can be plumbed into this drain. This does away with the need to empty the water container. If the dryer is stacked onto or installed next to a washing machine it can share the same drain.

The height of the drain must be less than 3' (1m) from the bottom of the dryer.

Note: If you are using a washing machine with a spin speed below 1100 rpm and drying loads of 8 kg or more (also for energy label tests to EU Regulation 392) you have to plumb the dryer into a drain, or the container may fill before the clothes are dry. follow the instructions below:

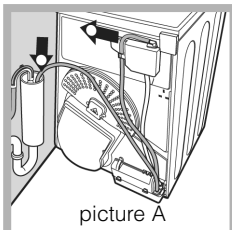

Remove the existing hose from position shown in picture A.

Then fit a suitable length of hose to position shown in picture B.

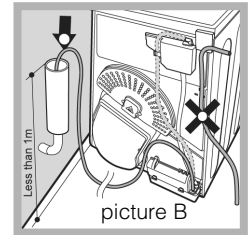

! Make sure that the hose is not squashed or kinked when the dryer is in its final location.

Electrical connections

Make sure of the following before you insert the plug into the the electrical socket:

- Make sure your hands are dry.
- The socket must have an earth connection.
- The socket must be able to sustain the machines maximum power, which is indicated on the rating label (*see Dryer Description*).
- Power voltage must be within the values indicated on the rating label (*see Dryer Description*).
- The socket must be compatible with the dryers plug. Should this not be the case, replace the plug or the socket.

! The dryer must not be installed outdoors, even if the space is sheltered. It can be very dangerous if it is exposed to rain or storms.

! Once installed, the dryers electrical wire and plug must be within easy reach.

! Do not use extension cords.

! The power cord must not be bent or squashed.

! The power cord should be regularly checked. If the supply cord is damaged, it must be replaced by the manufacturer, its service agent or similarly qualified persons in order to avoid a hazard. New or longer power cords are supplied at an extra charge by authorised dealers.

! The manufacturer denies any responsibility should any of these rules not be followed.

! If in doubt about any of the above consult a qualified electrician.

Before you start using your dryer

Once you have installed your dryer and before you use it, clean the inside of the drum to remove any dust that could have accumulated during transport.

Maximum load

Natural fibres : 9 kg

! The appliance has been designed and built according to international safety standards.

These warnings are given for safety reasons and must be followed carefully.

General safety

- This appliance can be used by children aged from 8 years and above and persons with reduced physical, sensory or mental capabilities, or lack of knowledge if they are given supervision or instruction concerning use of the appliance in a safe way and understand the hazards involved.
- This tumble dryer has been designed for home, and not professional use.
- Do not touch the appliance while bare foot or with wet hands or feet.
- Unplug the machine by pulling on the plug, not the cord.
- After using the dryer, turn it off and unplug it. Keep the door closed to make sure that children do not use it as a toy.
- Children should be supervised to ensure that they do not play with the dryer.
- Cleaning and user maintenance should not be made by children without supervision.
- Children of less than 3 years should be kept away from the appliance unless continuously supervised.
- The appliance must be installed correctly and have proper ventilation. The air intake at the front of the dryer should never be obstructed (*see Installation*).
- Never use the dryer on carpeting where the pile height would prevent air from entering the dryer from the base.
- Check to see if the dryer is empty before loading it.
-  The back of the dryer could become very hot. Never touch it while in use.
- Do not use the dryer unless the filter, water container and condenser are securely in place (*see Maintenance*).
- Do not overload the dryer (*see Laundry* for maximum loads).
- Do not load items that are dripping wet.
- Carefully check all instructions on clothing labels (*see Laundry*).
- Do not tumble dry large, very bulky items.
- Do not tumble dry acrylic fibres at high temperatures.
- Do not turn off the dryer when there are still warm items inside.
- Clean the filter after each use (*see Maintenance*).
- Empty the water container after each use (*see Maintenance*).
- Clean the condenser unit at regular intervals (*see Maintenance*).
- Do not allow lint to collect around the dryer.
- Never climb on top of the dryer. It could result in damage.
- Always follow electrical standards and requirements (*see Installation*).
- Always buy original spare parts and accessories (*see Service*).

Warnings

GB

To minimise the risk of fire in your tumble dryer, the following should be observed:

- Tumble dry items only if they have been washed with detergent and water, rinsed and been through the spin cycle. It is a fire hazard to dry items that HAVE NOT been washed with water.
- Do not dry garments that have been treated with chemical products.
- Do not tumble dry items that have been spotted or soaked with vegetable or cooking oils, this constitutes a fire hazard. Oil-affected items can ignite spontaneously, especially when exposed to heat sources such as a tumble dryer. The items become warm, causing an oxidation reaction with the oil, Oxidation creates heat. If the heat cannot escape, items can become hot enough to catch fire. Piling, stacking or storing oil-affected items can prevent heat from escaping and so create a fire hazard. If it is unavoidable that fabrics containing vegetable or cooking oil or those that have been contaminated with hair care products be placed in a tumble dryer they should first be washed with extra detergent - this will reduce, but not eliminate the hazard. They should not be removed from the dryer and piled or stacked while hot.
- Do not tumble dry items that have previously been cleaned in or washed in, soaked in or soiled with petrol/gasoline, dry cleaning solvents or other flammable or explosive substances. Highly flammable substances commonly used in domestic environments including cooking oil, acetone, denatured alcohol, kerosene, spot removers, turpentine, waxes and wax removers. Ensure these items have been washed in hot water with an extra amount of detergent before being dried in the tumble dryer.
- Do not tumble dry items containing foam rubber (also known as latex foam), or similarly textured rubber like materials. Foam rubber materials can, when heated, produce fire by spontaneous combustion.
- Fabric softener or similar products should not be used in a tumble dryer to eliminate the effects of static electricity unless the practice is specifically recommended by the manufacturer of the fabric softener product.
- Do not tumble dry undergarments that contain metal reinforcements eg. bras with metal reinforcing wires. Damage to the tumble dryer can result if the metal reinforcements come loose during drying.
- Do not tumble dry rubber, plastic articles such as shower caps or babies water proof covers, polythene or paper.
- Do not tumble dry rubber backed articles, clothes fitted with foam rubber pads, pillows, galoshes and rubber coated tennis shoes.
- Remove all objects from pockets, such as lighters and matches.

! WARNING: Never stop the dryer before the end of the drying cycle unless all items are quickly removed and spread out so that the heat is dissipated.

Switching off the electricity

! Unplug your dryer when not using it, when cleaning it and during all maintenance operations.

Clean the filter after each cycle

The filter is an important part of your dryer: it accumulates lint and fluff that is formed while drying.

When finished drying, clean the filter by rinsing it under running water or with your vacuum cleaner.

Should the filter become clogged up, the airflow inside the dryer will be seriously compromised: drying times lengthen and you will consume more energy. It may also damage your dryer.

The filter is found in front of the dryer trim (see diagram on next page).

Removing the filter:

1. Pull the plastic grip of the filter upwards.
2. Open the filter and clean the lint from the inside.
3. Replace it correctly. Ensure the filter is fully located flush into the tumble dryer trim.

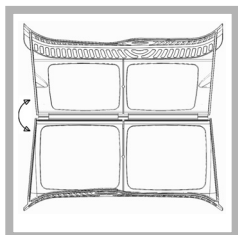

4. Remove any lint that has built up on the inside of the door and around the door seal.

! Do not use the dryer without replacing the filter.

Empty the water container after each cycle

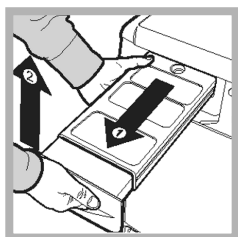

Pull the container out of the dryer and remove either the small or large cap and empty it into a sink or other suitable drain. Refit the cap and replace the container securely.

! Always check and empty the container before you start a new drying programme.

! Failure to empty the water container may cause the following:

- The dryer will stop heating (so the load may still be damp at the end of the drying cycle) (see *The Controls*).

• Priming the water collection system

When your dryer is new, the water container will not collect water until the system is primed.

This will take 1 or 2 drying cycles. Once primed it will collect water during every drying cycle.

Cleaning the condenser unit

Periodically (every month) remove the condenser unit and clean any build up of fluff from between the plates by rinsing it under the tap with cold water.

This should be done with cold water from the rear of the condenser.

Removing the condenser:

1. Unplug the dryer and open the door.
2. Pull open the condenser cover (see diagram).

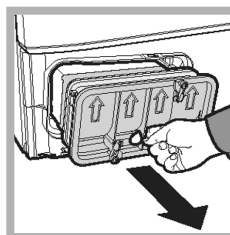

Release the three catches by turning 90° counter-clockwise then pull on the grip and remove from the dryer.

Clean the surface of the seals and replace, with the arrows pointing upwards making sure that the catches have been secured.

Maintenance and Care

GB

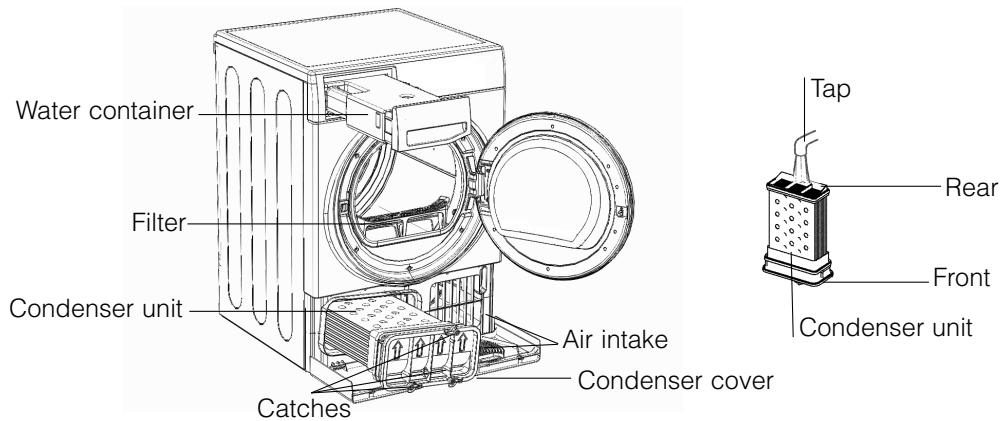

Check the drum after each cycle

Turn the drum manually in order to remove small items (handkerchiefs) that could have been left behind.

Cleaning the drum

! Do not use abrasives, steel wool or stainless steel cleaning agents to clean the drum.

A coloured film may start to appear on the stainless steel drum, this may be caused by a combination of water and, or cleaning agents such as fabric conditioner from the wash. This coloured film will not affect the dryer performance.

Cleaning the dryer

- External parts in metal or plastic and rubber parts can be cleaned with a damp cloth.
- Periodically (every 6 months) vacuum the front air intake grille, to remove any build up of fluff, lint or dust. Also to remove accumulation of fluff from the front of the condenser and filter areas, clean occasionally with a vacuum cleaner.

! Do not use solvents or abrasives.

! Have your dryer checked regularly by authorised technicians to ensure electrical and mechanical safety (*see Service*).

Quick Tips

- Remember to clean the door filter and the condenser filter after each load.
- Remember to empty the water container after each load.

! Doing BOTH the above will keep your appliance working at its BEST.

Dryer Description

The features

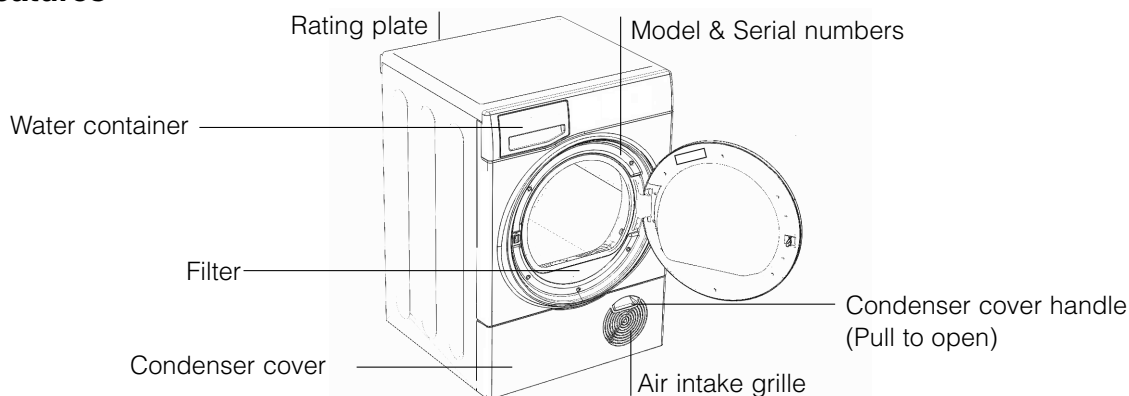

Control panel

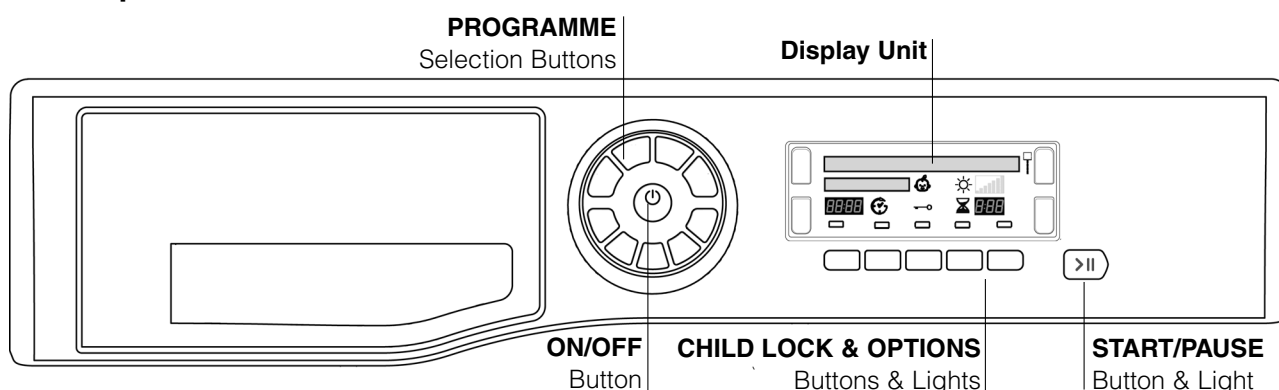

The **ON/OFF** button - if pressed when the dryer is running: If the display shows **TURNING OFF** the dryer stops. If the display shows **PRESS AND HOLD** hold the button and the display counts down 3, 2, 1 and then stops.

Press and hold again for more than 3 seconds, the display briefly shows **POWER ON**.

The **PROGRAMME** selection buttons set the programme: press the button corresponding to the programme you want to select (see *Start and Programmes*).

The **OPTION** buttons/indicators: these buttons select available options for your selected programme (see *The Controls*). The indicators on the display unit next to the bottom buttons light to show that the option has been selected.

The **START/PAUSE** button/light starts a selected programme. When a programme is running, pressing this button in pauses the programme, there will be one beep, the display will show **PAUSE** and the dryer stops. The light is green when the programme is running, flashing amber if the programme has been paused or flashing green if on standby waiting to start a programme (see *Start and Programmes*).

Note: This light also flashes amber during the Post Care phase of a programme.

The **Display Unit** gives warnings and information about the programme selected and its progress (see *next page*).

The **CHILD LOCK** button/icon : Press and hold this button after selecting your programme and any options, this prevents the programme settings from being changed, the display will briefly show **LOCKED**. When the icon is lit, the other buttons are disabled. Hold the button to cancel and the icon will go out, the display will briefly show **UNLOCKED**.

Note: This tumble dryer, in compliance with new energy saving regulations, is fitted with an automatic standby system which is enabled after about 30 minutes if no activity is detected. Press and hold the **ON-OFF** button until the display briefly shows **POWER ON** and the dryer then reactivates.

The Wool drying cycle of this tumble dryer has been tested and approved by The Woolmark Company. The cycle is suitable to dry wool garments which are labelled 'hand wash' provided the garments are washed in a Woolmark endorsed hand washing cycle and tumble dried according to the instructions issued by the manufacturer.



M1219 in UK, Eire, Hong Kong and India. The Woolmark symbol is a certification trademark ©The Woolmark Company Pty Ltd

The Display

GB

Selecting your language

The first time you turn on your dryer you should select your preferred language from the available list.

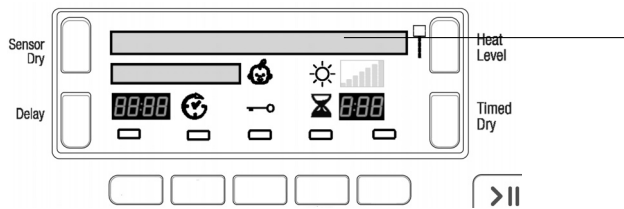

To change: the language current selection must flash, on the first line of the display.

- Press the On/Off button to turn off the display then press and hold all 3 buttons: **Heat Level**, **Timed Dry** and **Sensor Dry** for 5 seconds.
- Press the Heat Level or the Timed Dry button to scroll up or down through the list.
- When your required language is flashing on the top line of the display, pressing the Sensor Dry button will select your choice.

Understanding the display

Programme selection and display

The selected programme is shown on the first line of the display, this message is shown while the programme is running. Eight of the buttons have two selections, press the button once for the first choice and press again for the second choice, your selected programme is displayed. The final button selects My Cycle.

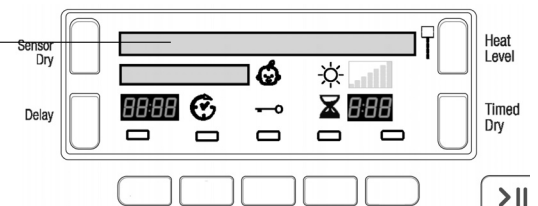

	First Press	Second Press
1	STANDARD COTTON	SHIRTS
2	BED & BATH	ANTI ALLERGY
3	SYNTHETICS	TURBO DRY
4	JEANS	DUVET
5	WOOL	SILK
6	BABY DELICATES	DARK
7	CUDDLY TOYS	HEAT & ENJOY
8	EASY IRON	REFRESH
M	MY CYCLE (<i>see below</i>)	

My Cycle When you select the My Cycle button the Display will show your selected programme with 'M' before its name. ie. **M COTTONS** (*see Start and Programmes*).

Dryness levels

During programme selection for an automatic programme that has different dryness levels available (*see Programmes Table*).

The second line of the display shows the dryness level you require, for each press of the ☀️ Dryness Level button the next option from the list below is selected and displayed. The display also shows 1 to 7 bars depending on your selection and these are displayed during the programmes progress.

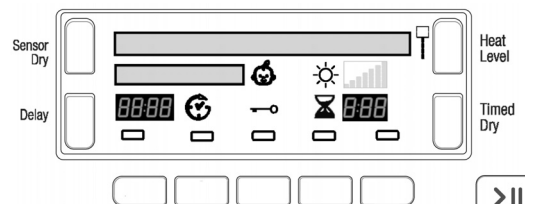

! Some automatic programmes do not allow the dryness level to be changed or do not have all the dryness level options.

DAMP	☀️	☐	Dries your items ready to be ironed using a machine or rotary ironer.
IRON DRY	☀️	☐	Dries your items ready to be ironed with a hand iron.
HANGER PLUS	☀️	▒	Dries your delicate items ready to be hanged for final drying.
HANGER DRY	☀️	▒	Dries your items ready to be hanged for final drying.
LIGHT DRY	☀️	▒	Dries your delicate items ready to be put away.
CUPBOARD DRY	☀️	▒	Dries your items ready to be put away.
EXTRA DRY	☀️	▒	Dries your clothes ready to be worn.

Programme progress

The second line of the display shows the status of the programme as it progresses:
(long messages scroll across the line)

- DRY
- COOL TUMBLE
- HEATING Heat & Enjoy programme
- READY
- END OF CYCLE, CREASE CARE (if option *Crease Care* selected).
- END OF CYCLE, CLEAN FILTER AND EMPTY WATER BOTTLE

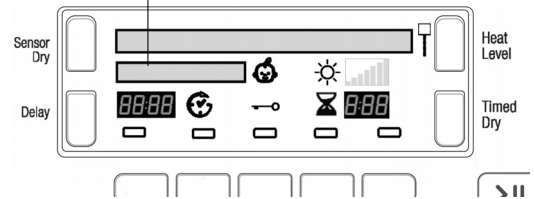

Timed Dry

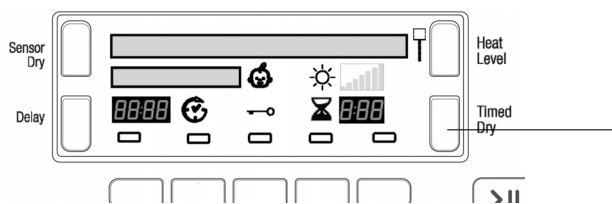

After selecting a programme that has a Timed Dry option, press the Timed Dry button and the display will increment the selected time, each time you press and release the button (*see Start and Programmes*).

Each press reduces the time duration and number of available time options depending on the programme/material selected.

The Timed Dry icon is displayed next to the time.

The selected time remains displayed after the programme starts, but can be changed anytime you wish.

Delay and Time to End

Some programmes can have a delayed start (*see Start and Programmes*). Press the Delay button and the icon flashes.

Each press of the Delay button advances the delay setting in 1 hour increments, from: **1h** to **24h**, then **OFF** and then after a couple of seconds cancels the delay.

The delay time is shown on the display next to the Delay button.

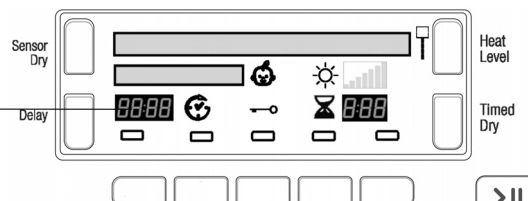

The display counts down the minutes of the delay period after the Start/Pause button is pressed.

The second line of the display shows **STARTS IN**

You can change or cancel the delay time selected anytime if you wish.

After the Start/Pause button is pressed the Delay or Time to End is displayed in hours and minutes and counts down each minute.

Time to End

After the delay period finishes, or for all the programme if delay not selected, this part of the display will show:

- the estimated time to the end of the programme, for automatic programmes
- the actual time remaining during a timed programme

When timed programmes are selected the time displayed throughout the cycle is the actual time remaining.

When Automatic programmes are selected the time displayed is an estimate of the time remaining. When the programme is selected the display shows the time required to dry a full load. The time remaining is constantly monitored during the drying cycle and is updated to show the best forecast.

The colons between the hours and minutes in the display flash to show the time is counting down.

The Display

GB

Warnings

The second line of the display also gives warnings and reminders: (reminders occur at the end of the programme)

END OF CYCLE, CLEAN FILTER AND EMPTY WATER BOTTLE

- Reminder that the water container should be emptied and the filter cleaned every time you use the dryer (*see Maintenance*).

EMPTY WATER BOTTLE

- Indicates that the water container is full. The message will take a few seconds to go out after replacing the empty water container; the dryer must be running for this to happen (*see The Controls*).

Note: If the water container fills and this message is displayed, the heat is turned off and your clothes will not dry.

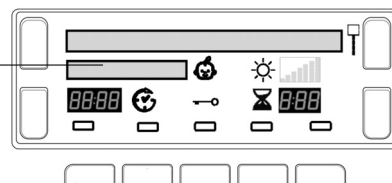

CLEAN CONDENSER, FILTER AND EMPTY WATER BOTTLE



- This message indicates that you must clean the Condenser unit (*see Maintenance*) and will occur at intervals depending how much you have used the dryer. When you finish the next programme the message is cancelled. You must also clean the filter.

CLEAN FILTER TO ENSURE ANTI ALLERGY ACTION

- Shown during the Anti-Allergy programme and indicates that the filter needs cleaning to complete the full anti-allergy cycle (*see Maintenance*).

Start and Programmes

Choosing a programme

- Plug the dryer into the electrical socket.
- Sort your laundry according to fabric type (*see Laundry*).
- Open the door and make sure the filter is clean and in place and the water container is empty and in place (*see Maintenance*).
- Load the machine and make sure items are not in the way of the door seal. Close the door.
- If the Display is not lit: Press the ON/OFF button .
- Press the Programmes Selection button that corresponds with the type of fabric being dried by checking the Programmes Table (*see Programmes*) as well as the indications for each type of fabric (*see Laundry*).
 - If the **M** button is selected; steps 7 and 8 are not required (*see below*).
- Choose Timed Drying or Dryness Levels option:
 - If Timed Drying press and release the Timed button until the required time is displayed.
 - or - To change from default dryness setting, press and release the Dryness Levels button until required level is indicated.
- !** See Programmes Table, for more details: availability of Dryness Levels, Timed Dry and Options.
- Set a delay time and other options if necessary (*see The Display*).
- Press the Start/Pause button  to begin. The display will show the estimated time to end. During the drying programme, you can check on your laundry and take out items that are dry while others continue drying. When you close the door again, press the Start/Pause button  in order to resume drying.
- During the last few minutes of Drying Programmes, before the programme is completed, the final COOL TUMBLE phase is entered (fabrics are cooled), this phase should always be allowed to complete.
- At the end of the drying cycle a message is displayed:
 - If **END OF CYCLE, CLEAN FILTER AND EMPTY WATER BOTTLE** is shown, the buzzer will beep 3 times (**Note:** If the SOUND option was selected the buzzer beeps 3 times every 30 seconds for 5 minutes).
 - If **END OF CYCLE, CREASE CARE** is shown, Crease Care option has been selected and if you do not remove the laundry immediately, the dryer will tumble occasionally for 10 hours or until you open the door, the buzzer will beep 3 times to confirm the programme is completed.
- Open the door, take the laundry out, clean the filter and replace it. Empty the Water Container and replace it (*see Maintenance*).
- Unplug the dryer.

My Cycle button:

First time you press this button the display will show **PRESS AND HOLD TO STORE**

After selecting your favorite programme and options you can save these settings by pressing and holding in the My Cycle button for at least 5 seconds, the top line will show a flashing **M** followed by the selected programme. The buzzer will then beep and the second line of the display shows **MEMORY**

The next time you need this programme press the **M** button, then the Start/Pause button  and this programme will run. If you wish, you can change your stored favorite, by selecting a new programme and/or options and press and hold in the **M** button (*as above*).

Start and Programmes

ESSENTIALS Programmes Table

! If the Display is not lit; Press the ON/OFF button and then select programme.

Programme		Options available							Dryness Levels available (default highlighted <input checked="" type="checkbox"/>)						
		Delay Timer	Pre Care	Sound or *Post Care	Less Fluff	Heat Level	Timed Dry	Sensor Dry	Damp Dry	Iron Dry	Hanger Dry Plus	Hanger Dry	Light Dry	Cupboard Dry	Extra Dry
1	Standard Cotton	<input checked="" type="checkbox"/>	<input checked="" type="checkbox"/>	<input checked="" type="checkbox"/>	<input checked="" type="checkbox"/>	- High - Medium - Low	<input checked="" type="checkbox"/>	<input checked="" type="checkbox"/>	<input checked="" type="checkbox"/>	<input checked="" type="checkbox"/>	<input checked="" type="checkbox"/>	<input checked="" type="checkbox"/>	<input checked="" type="checkbox"/>	<input checked="" type="checkbox"/>	<input checked="" type="checkbox"/>
	Shirts	<input checked="" type="checkbox"/>	<input checked="" type="checkbox"/>	<input checked="" type="checkbox"/>	<input checked="" type="checkbox"/>	- High - Medium	<input checked="" type="checkbox"/>	<input checked="" type="checkbox"/>	<input checked="" type="checkbox"/>	<input checked="" type="checkbox"/>	<input checked="" type="checkbox"/>	<input checked="" type="checkbox"/>	<input checked="" type="checkbox"/>	<input checked="" type="checkbox"/>	<input checked="" type="checkbox"/>
	Bed & Bath	<input checked="" type="checkbox"/>	<input checked="" type="checkbox"/>	<input checked="" type="checkbox"/>	<input checked="" type="checkbox"/>	- High - Medium	<input checked="" type="checkbox"/>	<input checked="" type="checkbox"/>	<input checked="" type="checkbox"/>	<input checked="" type="checkbox"/>	<input checked="" type="checkbox"/>	<input checked="" type="checkbox"/>	<input checked="" type="checkbox"/>	<input checked="" type="checkbox"/>	<input checked="" type="checkbox"/>
2	Anti Allergy	<input checked="" type="checkbox"/>	<input checked="" type="checkbox"/>	<input checked="" type="checkbox"/>	<input checked="" type="checkbox"/>	X	• An Automatic programme								
3	Synthetics	<input checked="" type="checkbox"/>	<input checked="" type="checkbox"/>	<input checked="" type="checkbox"/>	<input checked="" type="checkbox"/>	- Medium - Low	<input checked="" type="checkbox"/>	<input checked="" type="checkbox"/>	<input checked="" type="checkbox"/>	<input checked="" type="checkbox"/>	<input checked="" type="checkbox"/>	<input checked="" type="checkbox"/>	<input checked="" type="checkbox"/>	<input checked="" type="checkbox"/>	<input checked="" type="checkbox"/>
	Turbo Dry	<input checked="" type="checkbox"/>	<input checked="" type="checkbox"/>	<input checked="" type="checkbox"/>	<input checked="" type="checkbox"/>	X	• An Automatic programme								

*YOU CANNOT SELECT BOTH POST CARE AND SOUND OPTIONS

Standard Cotton

- This is a programme for cotton items.
- The duration of this programme will depend on the size of the load, the dryness setting selected and the spin speed used in your washer (*see Laundry*).
- The Standard Cotton programme to EU Regulation 392/2012 is Programme 1 selection with High Heat and Dryness Level Cupboard Dry.

Shirts

High heat option

- This is a programme for shirts made from cotton.
- It can be used for load sizes up to 3kg (approximately 10 shirts).

Medium heat option

- This is a programme for shirts made from synthetic materials or a mixture of natural and synthetic materials, such as polyester and cotton.
- It can be used for load sizes up to 3kg (approximately 14 shirts).
- **Note:** The Less Fluff option is NOT available when Shirts - Medium Heat is selected.

The duration of this programme will depend on the size of the load, the dryness setting selected and the spin speed used in your washer.

Loads dried using the Cupboard Dry setting are usually ready to wear, the edges or seams may be slightly damp. If this is the case, try turning the shirts inside out and running the programme again for a short period.

Bed & Bath

- This is a programme for cotton towels and sheets.
- The duration of this programme will depend on the size of the load, the dryness setting selected and the spin speed used in your washer (*see Laundry*).
- Loads dried using the Extra Dry setting are usually ready to use, the edges or seams may be slightly damp especially on large items. If this is the case, try opening them out and running the programme again for a short period.

Anti Allergy Programme

This programme has the 'Seal of Approval' endorsement from Allergy UK, which reflects the effective reduction and elimination of allergens from the clothes with the special Anti Allergy cycle. With this programme, thanks to the achievement of constant temperature for an extended period of time, the effects of the most common allergens (including House Mites and Pollen) are neutralised.

Can be used on a full size wet load to dry and treat, or on a 4kg dry load just to treat your laundry.

If the display shows CLEAN FILTER TO ENSURE ANTI ALLERGY ACTION : Clean the filter and re-start the programme.

Synthetics

- This is a programme for items of Synthetic with low heat setting or Synthetic/Cotton mixtures with medium heat setting.
- The duration of this programme will depend on the size of the load, the dryness setting selected and the spin speed used in your washer (*see Laundry*).

Turbo Dry

This programme has an extra fast cycle to dry cottons (ie. Cottons and Bed & Bath) by using a combination of temperature control and a special motor speed profile that takes advantage of our new **Soft Motion** motor system.

- It has been optimised for a 7kg load, other load sizes will not benefit from the optimised drying speeds and therefore may not give an improvement in drying time.
- The load must have been spun in the washing machine with a spin speed between 1200 - 1400 rpm.
- It dries to Hanger Dry level leaving your clothes ready to be hanged for final drying.
- The duration of this programme will depend on the size of the load and the spin speed used in your washer.

Start and Programmes

GB

EXCLUSIVES Programmes Table

! If the Display is not lit; Press the ON/OFF button  and then select programme.

Programme		Options available								Dryness Levels available (default highlighted <input checked="" type="checkbox"/>)						
		Delay Timer	Pre Care	Sound or *Post Care	Sound	Less Fluff	Heat Level	Timed Dry	Sensor Dry	Damp Dry	Iron Dry	Hanger Dry Plus	Hanger Dry	Light Dry	Cupboard Dry	Extra Dry
4	Jeans	<input checked="" type="checkbox"/>	<input checked="" type="checkbox"/>	<input checked="" type="checkbox"/>	*	<input checked="" type="checkbox"/>	<input checked="" type="checkbox"/>	<input checked="" type="checkbox"/>	<input checked="" type="checkbox"/>	<input checked="" type="checkbox"/>	<input checked="" type="checkbox"/>	<input checked="" type="checkbox"/>	<input checked="" type="checkbox"/>	<input checked="" type="checkbox"/>	<input checked="" type="checkbox"/>	<input checked="" type="checkbox"/>
	Duvet	<input checked="" type="checkbox"/>	<input checked="" type="checkbox"/>	<input checked="" type="checkbox"/>	*	<input checked="" type="checkbox"/>	- High - Medium	<input checked="" type="checkbox"/>	• An Automatic programme							
5	Wool 	<input checked="" type="checkbox"/>	<input checked="" type="checkbox"/>	<input checked="" type="checkbox"/>	<input checked="" type="checkbox"/>	<input checked="" type="checkbox"/>	<input checked="" type="checkbox"/>	<input checked="" type="checkbox"/>	• An Automatic programme							
	Silk	<input checked="" type="checkbox"/>	<input checked="" type="checkbox"/>	<input checked="" type="checkbox"/>	<input checked="" type="checkbox"/>	<input checked="" type="checkbox"/>	<input checked="" type="checkbox"/>	<input checked="" type="checkbox"/>	<input checked="" type="checkbox"/>	<input checked="" type="checkbox"/>	<input checked="" type="checkbox"/>	<input checked="" type="checkbox"/>	<input checked="" type="checkbox"/>	<input checked="" type="checkbox"/>	<input checked="" type="checkbox"/>	<input checked="" type="checkbox"/>
6	Baby Delicate	<input checked="" type="checkbox"/>	<input checked="" type="checkbox"/>	<input checked="" type="checkbox"/>	*	<input checked="" type="checkbox"/>	<input checked="" type="checkbox"/>	<input checked="" type="checkbox"/>	<input checked="" type="checkbox"/>	<input checked="" type="checkbox"/>	<input checked="" type="checkbox"/>	<input checked="" type="checkbox"/>	<input checked="" type="checkbox"/>	<input checked="" type="checkbox"/>	<input checked="" type="checkbox"/>	<input checked="" type="checkbox"/>
	Dark Cycle	<input checked="" type="checkbox"/>	<input checked="" type="checkbox"/>	<input checked="" type="checkbox"/>	<input checked="" type="checkbox"/>	<input checked="" type="checkbox"/>	<input checked="" type="checkbox"/>	<input checked="" type="checkbox"/>	• An Automatic programme							

*YOU CANNOT SELECT BOTH POST CARE AND SOUND OPTIONS

Jeans

- This is a programme for jeans made from denim cotton. Before drying your jeans turn the front pockets inside out.
- It can be used for load sizes up to 3kg (approximately 4 pairs).
- Do not mix dark and light coloured items.
- It can also be used on other garments made from the same material, such as jackets.
- The duration of this programme will depend on the size of the load, the dryness setting selected and the spin speed used in your washer.
- Loads dried using the Extra Dry setting are usually ready to wear, the edges or seams may be slightly damp. If this is the case, try turning the jeans inside out and running the programme again for a short period.

! We do not recommend that you use this programme if your jeans have elastic waist bands, studs or embroidery.

Duvet

! Take care with this programme DO NOT dry any items that are damaged which could result in the filling blocking the filter and air vent resulting in a fire hazard.

- Must only be used on single size duvets: NOT suitable for double or king size items.
- Loads dried using this programme are usually ready to use, but may be slightly damp in places. If this is the case, try opening them out and shaking them and running the programme again for a short period.
- Also suitable for down filled jackets.
- Select high heat for Cotton Duvets and medium heat for Synthetic duvets
- The duration of this programme will depend on the size and density of the load and the spin speed used in your washer.



Wool Programme

- This is a programme for tumble dryer safe garments marked with the symbol .
- It can be used for load sizes up to 1kg (approximately 3 sweaters).
- We recommend that garments are turned inside out before drying.
- The duration of this programme will depend on the size of the load, the dryness setting selected and the spin speed used in your washer.
- Loads dried using this programme are usually ready to wear, but on some heavier garments the edges may be slightly damp. Allow these to dry naturally as over-drying could damage garments.

! Unlike other materials, the mechanism of wool shrinkage is irreversible; i.e. it will not stretch back to original size and shape.

! This programme is not suitable for Acrylic garments.

Silk

- This is a programme for drying your delicate silk.
- It can be used for load sizes up to 0.5kg.
- The duration of this programme will depend on the size of the load, the dryness setting selected and the spin speed used in your washer.
- Loads dried using the Cupboard Dry setting are usually ready to use, but on some garments the edges may be slightly damp. If this is the case, try opening them out or turn items inside out and running the programme again for a short period.

Start and Programmes

Baby Delicates Programme

- This is a programme for drying your baby's small delicate items of clothing and bedding (Cotton and Chenille) and for drying your delicate clothes.
- DO NOT dry items such as bibs and nappy pants with plastic coverings.
- It can be used for load sizes up to 2kg.
- The duration of this programme will depend on the size of the load, the dryness setting selected and the spin speed used in your washer.
- Loads dried using this programme are usually ready to wear, but on some heavier garments the edges may be slightly damp. If this is the case, try turning items inside out and running the programme again for a short period.

Dark cycle

This programme helps to maintain your dark coloured Cotton clothes, by controlling the motor speed and drum rotation, together with control of the lower drying temperature.

- It can be used for cottons loads and jeans loads, up to a maximum of 3kg.
- The load must have been spun in the washing machine with a spin speed between 1200 - 1400 rpm.
- The duration of this programme will depend on the size of the load and the spin speed used in your washer.
- As this is a treatment programme aimed to protect your dark coloured clothes, the programme duration could be more than 4 hours.
- It dries to Cupboard Dry level.

EXTRA Programmes Table

! If the Display is not lit; Press the ON/OFF button and then select programme.

Programme		Options available							Dryness Levels available (default highlighted <input checked="" type="checkbox"/>)							
		Delay Timer	Pre Care	Post Care	Less Fluff	Sound	Heat Level	Timed Dry	Sensor Dry	Damp Dry	Iron Dry	Hanger Dry Plus	Hanger Dry	Light Dry	Cupboard Dry	Extra Dry
7	Cuddly Toys	<input checked="" type="checkbox"/>	<input type="checkbox"/>	<input type="checkbox"/>	<input type="checkbox"/>	<input checked="" type="checkbox"/>	<input type="checkbox"/>	<input type="checkbox"/>	<input type="checkbox"/>	• An Automatic programme						
	Heat & Enjoy	<input type="checkbox"/>	<input type="checkbox"/>	<input type="checkbox"/>	<input type="checkbox"/>	<input type="checkbox"/>	<input type="checkbox"/>	<input type="checkbox"/>	<input type="checkbox"/>	• An Automatic programme						
8	Easy Iron	<input type="checkbox"/>	<input type="checkbox"/>	<input type="checkbox"/>	<input type="checkbox"/>	<input checked="" type="checkbox"/>	<input type="checkbox"/>	<input type="checkbox"/>	<input type="checkbox"/>	• An Automatic programme						
	Refresh	<input type="checkbox"/>	<input type="checkbox"/>	<input type="checkbox"/>	<input type="checkbox"/>	<input checked="" type="checkbox"/>	<input type="checkbox"/>	<input type="checkbox"/>	<input type="checkbox"/>	• An Automatic programme						
M	My Cycle	Depends on your chosen programme. <i>See previous details.</i>														

Cuddly Toy Programme

With this programme you can remove dust easier and wash the cuddly toys more often because the drying time is very much reduced compared to drying in the open air. It is a delicate drying cycle that dries at low temperature and with soft mechanical action to maintain at best the original look and shine of the fur.

Note: For allergy protection, just freeze cuddly toys for 24 hours then wash and dry them. Repeat every 6 weeks. Before drying remove accessories such as clothes, collars or sound boxes and protect plastic eyes with masking tape after drying them with a cloth.

The programme time will vary dependant on the exact make up of the load. The maximum load should not exceed 2.5kg and no individual item should be greater than 600g.

Heat & Enjoy

This programme helps to heat towels & bathrobes for a warm sensation after a bath or shower. It is also useful for warming clothes before dressing during winter. The cycle heats clothes to 37°C (Body Temperature), the display shows **HEATING** and runs at this temperature for a maximum of 4 hours or until you stop the cycle by opening the door when the display shows **READY**. Maximum load 3kg.

Note: The Start/Pause button is disabled during this programme.

Refresh

! 'Refresh' is **not a drying programme** and should not be used for wet articles of clothing.

- It can be used on any load size, but is more effective on smaller loads.
- Do not overload your dryer (*see Laundry*).
- This is a 20 minute programme that airs your clothes with cool air. Also use to cool warm clothes.

Start and Programmes

GB

Easy Iron Programme

'Easy Iron' is a short 10 minute programme (8 minutes of heat followed by a 2 minute cool tumble period) which fluffs the fibres of clothing that have been left in the same position/location for an extended period of time. The cycle relaxes the fibres and makes them easier to iron and fold.

! 'Easy Iron' is **not a drying programme** and should not be used for wet articles of clothing.

For best results:

1. Do not load more than the maximum capacity. These numbers refer to the dry weight:

Fabric	Maximum load
Cotton and Cotton mixtures	2.5kg
Synthetics	2kg
Denim	2kg

2. Unload the dryer immediately after the end of the programme, hang, fold or iron the articles and put them away in the closet. Should this not be possible repeat the programme.

The 'Easy Iron' effect varies from one fabric to the next. It works well on traditional fabrics like Cotton or Cotton mix, and less well on acrylic fibres and on materials such as Tencel®.

The Controls

! Warning, after pressing the Start/Pause button >||, the programme cannot be changed.

To change a selected programme, press the Start/Pause button >||, the light flashes Amber to indicate the programme is paused. Select the new programme and any options required, the light will then flash green. Press the Start/Pause button >|| again and the new programme will start.

• Option buttons

These buttons are used to customise the selected programme to your requirements. A programme must have been selected, by pressing a programme selection button, before an option can be selected. Not all options are available for all programmes (*see Programmes Table*). If an option is not available and you press the button, the buzzer will beep 3 times. If the option is available the indicator, on the display unit next to the bottom buttons, lights to show that the option has been selected.

Delay Timer (Time Delay)

The start of some programmes (*see The Display and Programmes tables*) can be delayed for up to 24 hours. Ensure the water container is emptied before setting a delayed start.

Pre Care

This option is only available if a delayed start has been selected. It tumbles the clothes occasionally during the delayed period to help prevent creases developing.

Post Care

When available and selected, the clothes are occasionally tumbled after the end of the drying and cool tumble cycles, to help prevent creases developing should you not be available to remove the load immediately the programme is complete.

Note: The Start/Pause light flashes Amber during this phase.

Note: If you have selected the Sound option this option is not available.

Heat Level button, Display and Icons

Not all programmes allow you to change the heat level and some programmes allow all three heat level options: Low, Medium and High.

When the heat level options are available pressing this button changes the heat level and the display briefly shows the selected heat level, along with a display of the selected level icon:

HIGH HEAT ↑ MEDIUM HEAT ⇄ LOW HEAT ↓

Sound

When available and selected, a buzzer gives a signal at the end of the drying cycle, to remind you that the clothes are ready to be removed.

Note: If you have selected the Post Care option this option is not available.

Less Fluff

By reducing the mechanical action during the final drying stage the amount of lint and fluff produced is substantially reduced, protecting the fibres of your garments.

• TIME DISPLAY 88:88

The display shows either the amount of time delay remaining or an indication of the amount of time left for a drying programme (*see The Display*).

The display also shows if there is a problem with your dryer, if this occurs the display will show F followed by a fault code number (*see Troubleshooting*).

• Empty Water Container

(Messages about emptying can be ignored if you have plumbed your dryer into a drain as there is no need to empty the water container).

Messages are displayed to remind you to empty the water container (*see The Display*).

If the water container fills during a programme, the heater turns off and the dryer does a period of Cool Tumble.

After this it stops and a message tells you to

EMPTY THE WATER CONTAINER.

You must empty the water container and restart the dryer or the clothes will not dry. After re-starting the dryer the message will take a few seconds to go out.

To avoid this always empty the water container each time you use the dryer (*see Maintenance*).

• Door Opening

Opening the door during a programme will stop the dryer and have the following effects:

Note: The Start/Pause light flashes Amber during the Post Care phase of a programme.

- The display shows [PAUSE].
- During a delay phase the delay will continue to count down. The Start/Pause button **must** be pressed to resume the delay programme. The display will change to show current status.
- The Start/Pause button **must** be pressed to resume the programme. The display will change to show the current status, the Start/Pause light will stop flashing and turn green.
- During the Post Care phase, the programme ends. Pressing the Start/Pause button will restart a new programme from the beginning.

• Note

If you have a power cut, switch off the power or remove the plug. When power is restored, press and hold the On/Off button until the display briefly shows [POWER ON] and the dryer reactivates. Then press the Start/Pause button and the programme will resume.

Sorting your laundry

- Check symbols on clothing labels to make sure that the articles can be tumble dried.
- Sort laundry by fabric type.
- Empty pockets and check buttons.
- Close zippers and hooks and tie loose belts and strings.
- Wring out each item in order to eliminate as much excess water as possible.

! Do not load dripping wet clothes into the dryer.

Maximum load size

Do not load more than maximum capacity.

These numbers refer to dry weight:





Natural fibres: 9kg max (20lb)

Synthetic fibres: 3kg max (6.6lb)

! DO NOT overload the dryer as this could result in reduced drying performance.

Wash Care Labels

Look at the labels on your garments, especially when tumble drying for the first time. The following symbols are the most common:

-  May be tumble dried
-  Do **not** tumble dry
-  Tumble dry at high heat setting
-  Tumble dry at low heat setting

Drying times

The table (*see below*) presents APPROXIMATE drying times in Minutes. Weights refer to dry garments.

Times are approximate and can vary depending upon:

- Amount of water retained in clothes after spin cycle: towels and delicates retain a lot of water.
- Fabrics: items that are the same type of fabric but different textures and thicknesses may not have the same drying time.
- Quantity of laundry: single items or small loads may take longer to dry.
- Dryness: If you are going to iron some of your clothes, they can be taken out while still a bit damp. Others can be left longer if you need them to be completely dry.
- Heat setting.
- Room temperature: if the room where the dryer is located is cold, it will take longer for the dryer to dry your clothes.
- Bulk: some bulky items can be tumble dried with care. We suggest that you remove these items several times, shake them out, and return them to the dryer until finished.

! Do not over-dry your clothes.

All fabrics contain a little natural moisture, which keeps them soft and fluffy.

Cottons		1 kg	2 kg	3 kg	4 kg	5 kg	6 kg	7 kg	8 kg	9 kg
High Heat	Automatic duration	0:30 - 0:40	0:40 - 0:55	0:55 - 1:10	1:10 - 1:20	1:20 - 1:30	1:35 - 2:00	2:00 - 2:20	2:00 - 2:40	2:30 - 2:50
	Automatic minutes	30 - 40	40 - 55	55 - 70	70 - 80	80 - 90	95 - 120	120 - 140	130 - 160	140 - 170
	Timed Dry setting	0:30	1:00	1:00 or 1:30	1:30	1:30	1:30 or 2:00	2:00 or 2:40	2:00 or 2:40	2:40 or 3:00
	Drying times 800 -1000 rpm in washing machine.									
Synthetics		1 kg			2 kg			3 kg		
Medium Heat	Automatic duration	0:40 - 0:50			0:50 - 1:10			1:10 - 1:30		
	Automatic minutes	40 - 50			50 - 70			70 - 90		
	Timed Dry setting	1:00			1:00			1:00 or 1:30		
	Drying times on reduced spin in washing machine.									
Delicates		1 kg				2 kg				
Low Heat	Automatic duration	Synthetics, Timed Dry only								
	Timed Dry setting	0:30				1:00				
	Drying times on reduced spin in washing machine.									

- **Note:** At the end of a drying cycle, cottons could still be damp if you grouped cottons and synthetics together. If this is the case, simply give the damp cotton items an additional short period of drying.

Troubleshooting

GB

One day your dryer seems not to be working. Before you call your Service Centre (*see Service*), go through the following troubleshooting suggestions:

Problem:

Possible causes / Solution:

The tumble dryer won't start.

- The plug is not plugged into the socket, or not making contact.
- There has been a power failure.
- The fuse has blown. Try to plug another appliance into the socket.
- You are using an extension cord? Try to plug the dryer's power cord directly into the socket.
- The door is not closed securely?
- The programme has not been set properly (*see Start and Programmes*).
- The Start/Pause button has not been pressed (*see Start and Programmes*).

Drying cycle will not begin.

- You have set a delayed time (*see Start and Programmes*).

Its taking a long time to dry.

- The filter has not been cleaned (*see Maintenance*).
- The water container needs emptying? The empty water message is displayed? (*see Maintenance*).
- The condenser needs cleaning? (*see Maintenance*).
- The temperature setting is not ideal for the type of fabric you are drying (*see Start and Programmes, and see Laundry*).
- The correct drying time has not been selected for the load (*see Laundry*).
- The air intake grille is obstructed (*see Installation, and see Maintenance*).
- The items were too wet (*see Laundry*).
- The dryer was overloaded (*see Laundry*).

Empty water message is displayed but the dryer has only been running for a short period.

- The water container was probably not emptied at the start of the programme. Do not wait for the empty water signal, always check and empty the container before starting a new drying programme (*see Maintenance*).

Empty water message is displayed and the water container is not full.

- This is normal, the: END OF CYCLE, CLEAN FILTER AND EMPTY WATER BOTTLE message is shown as a reminder to empty the container (*see The Display and Start and Programmes*).

Programme finishes and clothes are damper than expected.

- ! For safety the dryer has a maximum programme time of 5 hours. If an automatic programme has not sensed the required final moisture in this time the dryer will complete the programme and stop. Check the above points and run the programme again, if the results are still damp, contact the Service Centre (*see Service*).

The display shows a fault code F followed by one or two numbers.

- If the display shows a fault:
 - Turn off and remove the plug. Clean the filter and the condenser (*see Maintenance*). Then replace the plug, turn on and start another programme. If a fault is then displayed note down the code and contact the Service Centre (*see Service*).

The display briefly shows DEMO ON every 6 seconds.

- The dryer is in 'Demo' mode. Press and hold both the On/Off and Start/Pause buttons for 3 seconds. The display will show DEMO OFF for 3 seconds and then the dryer will resume normal operation.

The lights on the dryer control panel are off although the dryer is switched on.

- The dryer has gone into standby mode to save power. This occurs if you have had a power cut or leave your dryer either without starting a programme or after your drying programme has finished.
 - Press and hold the On/Off button and the lights will come on.

Before calling the Service Centre:

- Use the troubleshooting guide to see if you can solve the problem yourself (*see Troubleshooting*).
- If not, turn off the dryer and call the Service Centre closest to you.

Spare Parts

This dryer is a complex machine. Repairing it yourself or having a non-authorized person try to repair it could cause harm to one or more persons, could damage the machine and could invalidate the spare parts warranty.

Call an authorised technician if you experience problems while using the machine.

Essential Contact Information

Hotpoint Service - Service You Can Rely On

At Hotpoint we pride ourselves on offering our customers the best service we possibly can, wherever you are in the UK and Ireland.

Rest assured though, no one knows a Hotpoint appliance better than we do and our service is second to none...

Wherever you are we can be there - we have over 1,000 highly skilled Hotpoint engineers covering the whole of the UK and Ireland ensuring fast, reliable, local service.

'Right first time' - our engineers have the latest tools to help get your Hotpoint appliance back up and running the first time we visit.

Experts in our field - all of our engineers are trained to the highest standard at our Hotpoint Training Centre of Excellence with unrivalled expertise and product knowledge.

Skilled staff - we have over 400 skilled UK based call centre staff, dedicated to offering you excellent service 364 days a year.

Telephone in the United Kingdom: 08448 224 224

Telephone in the Republic of Ireland: 0818 313 413

www.hotpointservice.co.uk

Our advisors will require the following information:

- name, address and post code.
- telephone number.
- the type of problem.
- the date of purchase.

- the appliance model (Mod.).
- the serial number (S/N).

This information can be found on the data label inside the door of the machine.

Save energy and respect the environment

- Wring out items to eliminate excess water before tumble drying (if you use a washing machine first, select a high spin cycle). Doing this will save time and energy during drying.
- Always dry full loads - you save energy: single items or small loads take longer to dry.
- Clean the filter after each use to contain energy consumption costs (*see Maintenance*).

Recycling and Disposal Information



As part of our continued commitment to helping the environment, we reserve the right to use quality recycled components to keep down customer costs and minimise material wastage.

- Disposing of the packaging material: follow local regulations, so the packaging can be recycled.
- To minimise risk of injury to children, remove the door and plug - then cut off mains cable, flush with the appliance. Dispose of these parts separately to ensure that the appliance can no longer be plugged into a mains socket.

Disposal of old electrical appliances

The European Directive 2012/19/EC on Waste Electrical and Electronic Equipment (WEEE), requires that old household electrical appliances must not be disposed of in the normal unsorted municipal waste stream. Old appliances must be collected separately in order to optimise the recovery and recycling of the materials they contain and reduce the impact on human health and the environment.



The crossed out "wheeled bin" symbol on the product reminds you of your obligation, that when you dispose of the appliance it must be separately collected.

Consumers should contact their local authority or retailer for information concerning the correct disposal of their old appliance.

Product Data... (EU Regulation 392/2012)

GB

Brand Hotpoint	Models SUTCD 97B
Rated capacity of Cotton laundry for the standard programme at full load 9 kg	Energy efficiency class B
The weighted Annual Energy Consumption (AE_c) 616.1 kWh Consumption per year, based on 160 drying cycles of the standard cotton programme at full and partial load, and the consumption of the low-power modes. Actual energy consumption per cycle will depend on how the appliance is used.	
This household tumble dryer is an Automatic Condenser Dryer	
Energy consumption : full load E_{dry} 5.22 kWh , partial load $E_{dry1/2}$ 2.81 kWh	
Power consumption : off-mode (P_o) 0.17 W , left-on mode (P_l) 3.17 W	
Duration of the 'left-on mode' for power management systems 30 minutes	
The 'standard cotton programme' suitable for drying normal wet cotton laundry that is the most efficient programme in terms of energy consumption for cotton used at full and partial load is Standard Cotton, High Heat, Cupboard Dry (with the dryer plumbed into a drain)	
Programme time (minutes) : weighted (T_i) full & partial load 114 , full load (T_{dry}) 153 , partial load ($T_{dry1/2}$) 85	
Condensation efficiency class B	
Average condensation efficiency (%) : full load (C_{dry}) 84 , partial load ($C_{dry1/2}$) 85 , weighted (C_i) full & partial load 85	
Airborne acoustical noise emissions 69 dB(A) re 1 pW	

* "consumer information in compliance with EU Regulation 932/2012".

Typical energy used	- Synthetics	full load 1.35 kWh ,	partial load not applicable
Typical drying time	- Synthetics	full load 50 minutes,	partial load not applicable



This appliance conforms to the following EC Directives:
 - 2006/95/EC (Low Voltage Equipment)
 - 2004/108/EC (Electromagnetic Compatibility)

Indesit Company, Viale Aristide Merloni 47, 60044 Fabriano (AN), Italy



195125820.00 N

06/2014 - LION fpg - Four Ashes, Wolverhampton

GB