



GENERATION FUTURE

EN



Thank-you for choosing a **Hoover** washing machine. We are proud to always offer new, innovative and technologically advanced products, with a complete range of home appliances to ensure true assistance in your daily routine.

We suggest you register your product at **www.registerhoover.com** to gain faster access to supplementary services solely reserved to our most loyal customers.

Carefully read this manual for correct and safe appliance use and for helpful tips on efficient maintenance.



Only use the washing machine after carefully reading these instructions. We recommend you always keep this manual on hand and in good conditions for any future owners.

Please check that the appliance is delivered with this instruction manual, warranty certificate, service centre address and energy efficiency label. Also check that plugs, curve for drain hose and liquid detergent or bleach tray (only on some models) are included. We recommend you keep all these components.

Each product is identified by a unique 16-character code, also called the “serial number”, printed on the sticker affixed to the appliance (porthole area) or in the document envelope found inside the product. This code is a sort of specific product ID card that you will need to register it and should you need to contact the **Hoover** Customer Service Centre.

Environmental conditions



This appliance is marked according to the European directive 2012/19/EU on Waste Electrical and Electronic Equipment (WEEE).

WEEE contains both polluting substances (which can cause negative consequences for the environment) and basic components (which can be re-used). It is important to have WEEE subjected to specific treatments, in order to remove and dispose properly all pollutants, and recover and recycle all materials. Individuals can play an important role in ensuring that WEEE does not become an environmental issue; it is essential to follow some basic rules:

- WEEE should not be treated as household waste;
- WEEE should be handed over to the relevant collection points managed by the municipality or by registered companies. In many countries, for large WEEE, home collection could be present.

In many countries, when you buy a new appliance, the old one may be returned to the retailer who has to collect it free of charge on a one-to-one basis, as long as the equipment is of equivalent type and has the same functions as the supplied equipment.

Contents

- 1. GENERAL SAFETY RULES**
- 2. INSTALLATION**
- 3. PRACTICAL TIPS**
- 4. MAINTENANCE AND CLEANING**
- 5. QUICK USER GUIDE**
- 6. CONTROLS AND PROGRAMS**
- 7. CUSTOMER SERVICE CENTRE AND WARRANTY**

1. GENERAL SAFETY RULES

● This appliances is intended to be used in household and similar applications such as:

- Staff kitchen areas in shops, offices and other working environments;
- Farm houses;
- By clients in hotels, motels and other residential type environments;
- Bed and breakfast type environments.

A different use of this appliance from household environment or from typical housekeeping functions, as commercial use by expert or trained users, is excluded even in the above applications. If the appliance is used in a manner inconsistent with this it may reduce the life of the appliance and may void the manufacturer's warranty. Any damage to the appliance or other damage or loss arising through use that is not consistent with domestic or household use (even if located in a domestic or household environment) shall not be accepted by the manufacturer to the fullest extent permitted by law.

● This appliance can be used by children aged from 8 years and above and persons with reduced physical, sensory or mental capabilities or lack of experience and knowledge if they have been given supervision or instruction concerning use of the appliance in a safe way and understand the hazards involved.

Children shall not play with the appliance. Cleaning and user maintenance shall not be made by children without supervision.

- Children should be supervised to ensure that they do not play with the appliance.
- Children of less than 3 years should be kept away unless continuously supervised.
- If the supply cord is damaged, it must be replaced by the manufacturer, its service agent or similarly qualified persons in order to avoid a hazard.
- Only use the hose-sets supplied with the appliance for the water supply connection (do not reuse old hose-sets).
- Water pressure must be between 0,05 MPa and 0,8 MPa.
- Make sure that a carpet do not obstruct the base of the machine and ventilation openings.
- The OFF condition is reached by placing the reference mark on the programmes control/knob in the vertical position. Any other different position of such control sets the machine in ON condition (only for models with programmes knob).
- After installation, the appliance must be positioned so that the plug is accessible.
- The maximum load capacity of dry clothes depends on the model used (see control panel).

- To consult the product fiche please refer to the manufacturer website.
- In the event of fault and/or malfunction, turn off the washing machine, close the water faucet and do not tamper with the appliance.

Safety instructions

- Before cleaning or maintaining the washing machine, unplug the appliance and turn off the water faucet.
- Make sure the electrical system is grounded. Otherwise, seek qualified professional assistance.
- Please do not use converters, multiple sockets or extension cords.



WARNING:
water may reach very high temperatures during the wash cycle.

- Make sure there is no water in the drum before opening the porthole.
- Do not pull on the power cord or appliance to unplug the machine.
- Do not expose the washing machine to rain, direct sunlight or other weather elements.
- When moving, do not lift the washing machine by the knobs or detergent drawer; during transport, never rest the porthole on the trolley. We recommend two people lift the washing machine.

Immediately contact the Customer Service Centre and only use original spare parts. Failure to observe these instruction may jeopardise appliance safety.

CE Appliance complies with European Directives:

- 2006/95/EC (LVD);
- 2004/108/EC (EMC);
- 2009/125/EC (ErP);
- 2011/65/EU (RoHS)

and subsequent amendments.

2. INSTALLATION

- Cut the tube straps, being careful not to damage the tube and power cord.
- Unscrew the **2** or **4** screws (**A**) on the back and remove the **2** or **4** shims (**B**) as illustrated in **figure 1**.
- Close the **2** or **4** holes using the plugs included in the instruction envelope.
- If the washing machine is **built-in**, after cutting the hose straps, unscrew the **3** or **4** screws (**A**) and remove the **3** or **4** shims (**B**).
- In some models, **1** or **more** shims will fall inside the machine: tilt the washing machine forward to remove them. Close the holes using the plugs found in the envelope.



WARNING:
keep packaging materials away from children.

- Place the polionda sheet on the bottom as shown in **figure 2** (according to the model, consider version **A**, **B** or **C**).

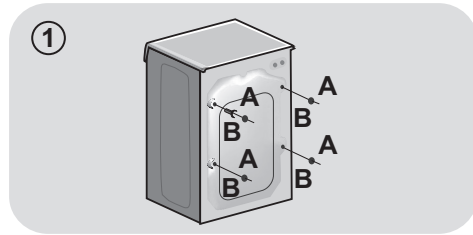

NE

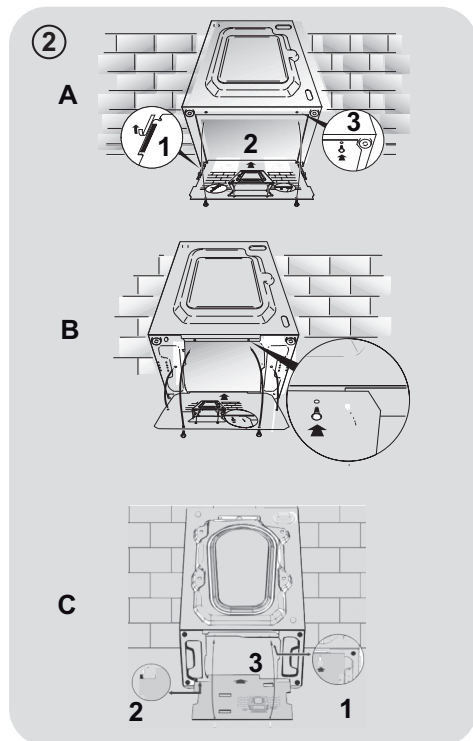

Hydraulic connections

- Connect the water tube to the faucet, only using the drain tube supplied with the washing machine (fig. 3).

DO NOT OPEN THE FAUCET.

- Some models may include one or more of the following features:

- **HOT&COLD (fig. 4):**

water mains connection settings with hot and cold water for higher energy savings. Connect the grey tube to the cold water faucet  and the red one to the hot water faucet. The machine can be connected to the cold water faucet only: in this case, some programs may start a few minutes later.

- **AQUASTOP (fig. 5):**

a device located on the supply tube that stops water flow if the tube deteriorates; in this case, a red mark will appear in the window "A" and the tube must be replaced. To unscrew the nut, press the one-way lock device "B".

- **AQUAPROTECT – SUPPLY TUBE WITH GUARD (fig. 6):**

Should water leak from the primary internal tube "A", the transparent containment sheath "B" will contain water to permit the washing cycle to complete. At the end of the cycle, contact the Customer Service Centre to replace the supply tube.

Setting

- Near the washing machine to the wall, being careful that the tube is not bent or crushed, and place the drain tube in the tub or, preferably, connect it to a wall drain at least 50 cm high with diameter greater than the washing machine tube (fig. 7).

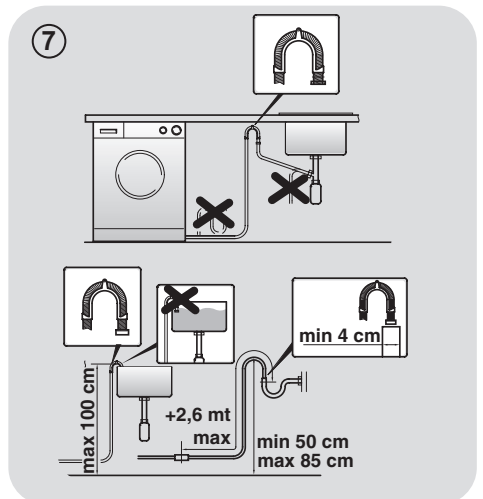
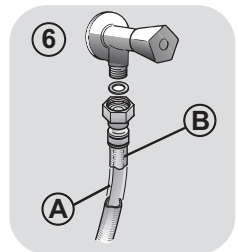
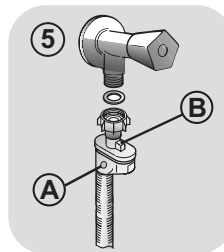
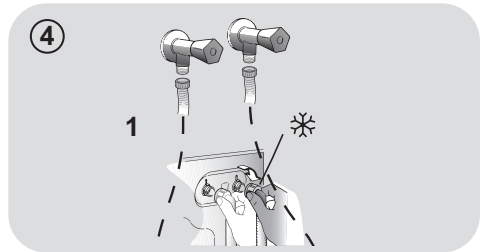
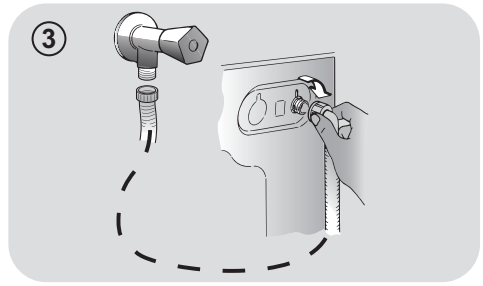

- Level the appliance using the feet as illustrated in **figure 8**:
 - a. turn the nut clockwise to release the screw;
 - b. rotate the foot to raise or lower it until it adheres to the floor;
 - c. lock the foot, screwing in the nut, until it adheres to the bottom of the washing machine.
- Plug in the appliance.



WARNING:
contact the Customer Service Centre should the power cord need replacement.

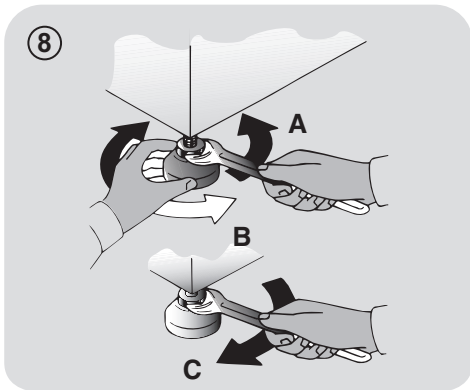

Detergent drawer

The detergent draw is split into 3 compartments as illustrated in **figure 9**:

- **compartment "1"**: for prewash detergent;
- **compartment "☼"**: for special additives, softeners, starch fragrances, etc.;

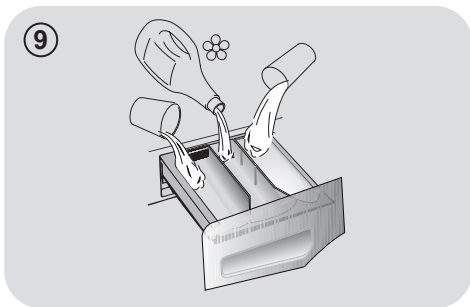

WARNING:
only use liquid products; the washing machine is set to automatically dose additives at each cycle during the last rinse.

- **compartment "2"**: for washing detergent.

A **liquid detergent cup** is also included in some models (**fig. 10**). To use it, place it in **compartment "2"**. This way, liquid detergent will only enter the drum at the right time. The cup can also be used for bleach when the "Rinse" program is selected.

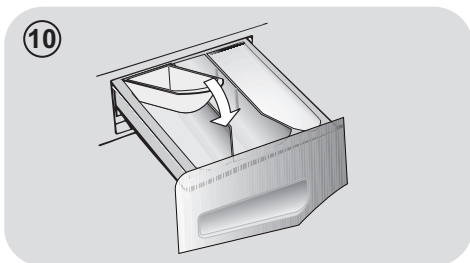

WARNING:
some detergents are hard to remove. In this case we recommend using the specific container to be placed in the drum (example in figure 11).

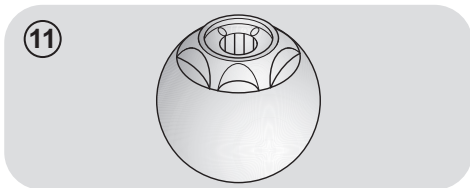

3. PRACTICAL TIPS

Load tips

WARNING: when sorting laundry, make sure:

- have eliminated metallic objects such as barrettes, pins, coins, from laundry;
 - to have buttoned pillow cases, closed zips, tied loose belts and long robe ribbons;
 - to have removed rollers from curtains;
 - to have carefully read clothing washing labels;
 - to have removed any persistent stains using specific detergents.
- When washing rugs, bedcovers or other heavy clothing, we recommend you avoid centrifuging.
 - To wash wool, make sure the item can be machine washed and marked by the "Pure virgin wool" symbol with the "Does not mat" or "Machine washable" label.

Helpful suggestions for the user

A guide environmentally friendly and economic use of your appliance.

Maximise The Load Size

- Achieve the best use of energy, water, detergent and time by using the recommended maximum load size. Save up to 50% energy by washing a full load instead of 2 half loads.

Do you need to pre-wash?

- For heavily soiled laundry only! SAVE detergent, time, water and between 5 to 15% energy consumption by NOT selecting Prewash for slight to normally soiled laundry.

Is a hot wash required?

- Pretreat stains with stain remover or soak dried in stains in water before washing to reduce the necessity of a hot wash programme. Save up to 50% energy by using a 60°C wash programme.

Following is a **quick guide** with tips and recommendations on **detergent use at the various temperatures**. In any case, always read the instructions on the detergent for correct use and doses.

When washing heavily soiled whites, we recommend using cotton programs of 60°C or above and a normal washing powder (heavy duty) that contains bleaching agents that at medium/high temperatures provide excellent results.

For washes between 40°C and 60°C the type of detergent used needs to be appropriate for the type of fabric and level of soiling.

Normal powders are suitable for "white" or colour fast fabrics with high soiling, while liquid detergents or "colour protecting" powders are suitable for coloured fabrics with light levels of soiling.

For washing at temperatures below 40°C we recommend the use of liquid detergents or detergents specifically labeled as suitable for low temperature washing.

For washing **wool** or **silk**, only use detergents specifically formulated for these fabrics.

4. MAINTENANCE AND CLEANING

To clean the washing machine exterior, use a damp cloth, avoiding abrasives, alcohol and/or solvents. The washing machine does not require any special care for ordinary cleaning: clean drawer compartments and the filter; some tips on how to move the machine or on long periods of disuse are provided below.

Drawer cleaning

- We recommend you clean the drawer to avoid accumulating detergent and additive residue.
- To do this, extract the drawer using slight force, clean it with running water and reinsert it in its housing.

Filter cleaning

- The washing machine comes with a special filter able to trap large residue, such as buttons or coins, which could clog the drain.
- Only available on certain models: pull out the corrugated hose, remove the stopper and drain the water into a container.
- Before unscrewing the filter, we recommend you place an absorbent cloth under it to keep the floor dry.
- Turn the filter counter-clockwise to the limit stop in the vertical position.
- Remove and clean the filter; when finished, replace it turning it clockwise.
- Repeat the previous steps in reverse order to reassemble all parts.

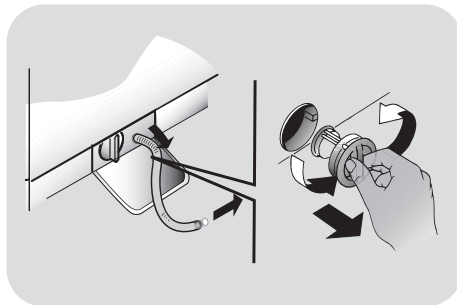

EN

Suggestions for moves or prolonged disuse

- Should the washing machine be stored in an unheated room for a long period of time, drain all water from tubes.
- Unplug the washing machine.
- Detach the tube from the strap and lower it, fully draining water into a bowl.
- Secure the drain tube with the strap when finished.

5. QUICK USER GUIDE

This washing machine automatically adapts the level of the water to the type and quantity of washing. This system gives a decrease in energy consumption and a sensible reduction in washing times.

Program selection

- Turn on the washing machine and select the required program.
- Adjust the washing temperature if necessary and press the required "option" buttons.
- Press the **START/PAUSE** button to start washing.

Should power go out when the washing machine is running, a special memory saves the settings and, when power returns, the machine resumes the cycle from where it left off.

- The message "end" will appear on the display or the corresponding led will turn on at the end of the program.

Wait until the porthole locked light turns off: about 2 minutes after the program ends.

- Turn off the washing machine.

For any type of wash, see the program table and follow the operating sequence as indicated.

Technical data

Water pressure:

min 0,05 Mpa
max 0,8 Mpa

Spin r.p.m.:

See rating plate.

Power input / Power current fuse amp /

Supply voltage:

See rating plate.

6. CONTROLS AND PROGRAMS

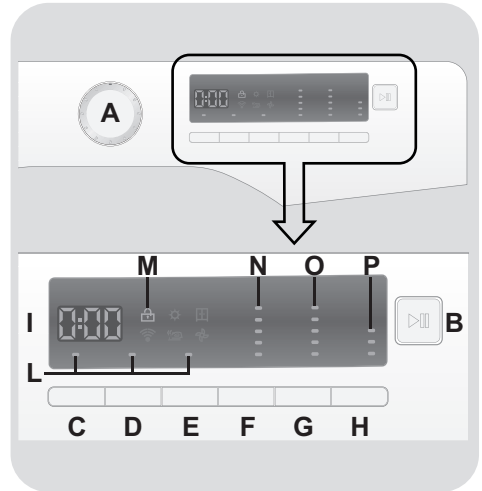

A Programme selector with OFF position

B START/PAUSE button

C DELAY START button

D PREWASH button

E EASY IRON button

F SPIN SPEED button

G TEMPERATURE SELECTION button

H RAPID LENGTH button

I Digital display

L BUTTONS indicator lights

M DOOR LOCKED indicator light

N SPIN SPEED indicator lights

O TEMPERATURE SELECTION indicator lights

P RAPID LENGTH indicator lights

Opening the door

A special safety device prevents the door from being opened immediately after the end of the cycle.

Wait for **2 minutes** after the wash cycle has finished and the "Door Security" light has gone out before opening the door.

PROGRAMME selector with OFF position

When the programme selector is turned the display lights up to show the settings for the programme selected.

For energy saving, at the end of the cycle or with an inactivity period, the display level contrast will decrease.

N.B.: To switch the machine off, turn the programme selector to the **OFF** position.

- Press the **START/PAUSE** button to start the selected cycle.
- Once a programme is selected the programme selector remains stationary on the selected programme till cycle ends.
- Switch off the washing machine by turning the selector to **OFF**.

The programme selector must be returned to the **OFF** position at the end of each cycle or when starting a subsequent wash cycle prior to the next programme being selected and started.

START/PAUSE button

Close the door **BEFORE** selecting the button **START/PAUSE**.

- Press to start the selected cycle.

When the **START/PAUSE** button has been pressed, the appliance can take few seconds before it starts working.

ADD OR REMOVE ITEMS AFTER THE PROGRAMMES HAS STARTED (PAUSE)

- Press and hold the **START/PAUSE** button for about **2 seconds** (some indicator light and the time remaining indicator will flash, showing that the machine has been paused).

- Wait **2 minutes** until the safety device unlocks the door.
- After you have added or removed items, close the door and press the **START/PAUSE** button (the programme will start from where it left off).

CANCELLING THE PROGRAMME

- To cancel the programme, set the selector to the **OFF** position.

DELAY START button

- This button allows you to pre-programme the wash cycle to delay the start of the cycle for up to **24 hours**.
- To delay the start use the following procedure:

- Set the required programme.
- Press the button once to activate it (**h00** appears on the display) and then press it again to set a **1 hour** delay (**h01** appears on the display). The pre-set delay increases by **1 hour** each time the

button is pressed, until **h24** appears on the display, at which point pressing the button again will reset the delay start to zero.

- Confirm by pressing the **START/PAUSE** button (the light on the display starts to flash). The countdown will begin and when it has finished the programme will start automatically.

- It is possible to cancel the delay start by turning the programme selector to **OFF**.

If there is any break in the power supply while the machine is operating, a special memory stores the selected programme and, when the power is restored, it continues where it left OFF.

The option buttons should be selected before pressing the **START/PAUSE** button.

If an option is selected that is not compatible with the selected programme then the option indicator first flashes and then goes off.

PREWASH button

It allows you to do a preliminary wash at the beginning of the cycle. The temperature does not exceed 40°C and in any case it does not exceed the maximum temperatures of the selected washing program (ex. the temperature of HAND program will be 30°C).

EASY IRON button

This function allows you to minimize creases as much as possible, eliminating the intermediate spins or reducing the intensity of the last one.

SPIN SPEED button

- By pressing this button, it is possible to reduce the maximum speed, and if you wish, the spin cycle can be cancelled.
- To reactivate the spin cycle press the button until you reach the spin speed you would like to set.

To prevent damage to the fabrics, it is not possible to increase the speed over that which is automatically suitable during the selection of the program.

- It is possible to modify the spin speed without pausing the machine.

The machine is fitted with a special electronic device, which prevents the spin cycle should the load be unbalanced.

This reduces the noise and vibration in the machine and so prolongs the life of your machine.

TEMPERATURE SELECTION button

When you select a program, the light illuminates the recommended temperature. It is also possible to change the temperature but not over the maximum in order to save the fabrics.

RAPID LENGTH button

The button becomes active when you select the **RAPID** program on the knob; it allows you to select one of three durations indicated.

Digital Display

The display's indicator system allows you to be constantly informed about the status of the machine.

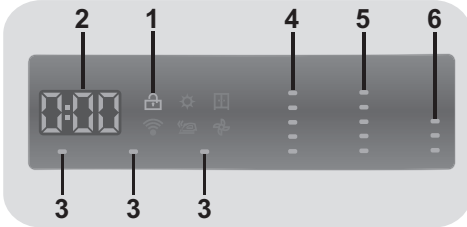

1) DOOR LOCKED INDICATOR LIGHT

- The indicator light is illuminated when the door is fully closed.

Close the door BEFORE selecting the START/PAUSE button.

- When **START/PAUSE** is pressed on the machine with the door closed, the indicator will flash momentarily and then illuminate.

If the door is not properly closed, the light will continue to flash for about 7 seconds, after which the start command will be automatically delete. In this case, close the door in the proper way and press the START/PAUSE button.

- A special safety device prevents the door from being opened immediately after the end of the cycle. Wait for **2 minutes** after the wash cycle has finished and the **DOOR LOCKED** light has gone out before opening the door. At the end of the cycle turn the programme selector to **OFF**.

2) CYCLE DURATION

- When a programme is selected the display automatically shows the cycle duration, which can vary, depending on the options selected.

- Once the programme has started you will be kept informed constantly of the time remaining to the end of the wash.

- The appliance calculates the time to the end of the selected programme based upon a standard loading, during the cycle, the appliance corrects the time to that applicable to the size and composition of the load.

3) BUTTONS INDICATOR LIGHTS

- These light up when the relevant buttons are pressed.
- If an option is selected that is not compatible with the selected programme then the light on the button first flashes and then goes off.

4) SPIN SPEED indicator lights

The indicator lights show the spin speed of the selected programme that can be changed or omitted by the relevant button.

5) TEMPERATURE SELECTION indicator lights

The indicator lights show the washing temperature of the selected programme that can be changed (where allowed) by the relevant button.

6) RAPID LENGTH indicator lights

The indicator lights show the rapid programmes that can be selected by the relevant button.

Table of programmes

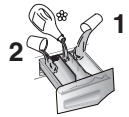

PROGRAM	kg* (MAX.)				TEMP.°C		DETERGENT			
					Recommended	Max.	2		1	
ActivEco 20°C	5	6	7	8	20°	20°	●	●		
Baby 60°C	3,5	4	4,5	5,5	60°	60°	●	●		
Daily 59 Min.	1,5	2	2,5	3	40°	40°	●	●		
Rapid (14/30/44 Min.)	1)	1	1	1	1,5	30°	30°	●	●	
		1,5	2	2,5	2,5	30°	30°	●	●	
		3	3	3,5	3,5	30°	40°	●	●	
Shirts		2,5	3	3,5	4	30°	30°	●	●	(●)
Dark Colours		2,5	3	3,5	4	40°	40°	●	●	(●)
Auto Clean								●		
Rinse		-	-	-	-	-	-	△	●	
Drain & Spin		-	-	-	-	-	-			
Lingerie		1,5	2	2	2,5	40°	60°	●	●	
Hand & Silk		1	1	1	2	30°	30°	●	●	
Wool		1	1	1	2	40°	40°	●	●	
Delicates		2	2	2,5	2,5	40°	40°	●	●	
Mixed		2,5	3	3,5	4	40°	60°	●	●	(●)
Cottons	**	5	6	7	8	40°	90°	●	●	(●)

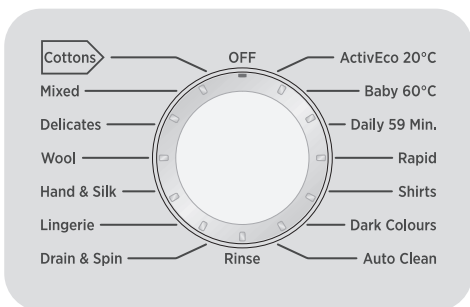

An over dosing of detergent can cause excessive foaming. If the appliance detects the presence of excessive foam, it may exclude the spinning phase or extend the duration of the program and increase water consumption.



Please read these notes:

* Maximum load capacity of dry clothes, according to the model used (see control panel).

- Only with PREWASH option selected (programmes with PREWASH option available).

△ (Only for models with liquid detergent compartment)

When only a limited number of articles have stains which require treatment with liquid bleaching agents, preliminary removal of stain can be carried out in the washing machine.

Pour the bleach into the liquid bleach container, inserted into the compartment marked "2" in the detergent drawer, and set the special programme RINSE.

When this phase has terminated, turn the programme selector on the OFF position, add the rest of the fabrics and proceed with a normal wash on the most suitable programme.

- 1) Selecting the RAPID program on the knob, it will be possible to select with the RAPID LENGTH button, one of the three rapid programs available among 14 Min., 30 Min. and 44 Min..

**** STANDARD COTTON PROGRAMMES ACCORDING TO (EU) No 1015/2010 and No 1061/2010.**

COTTON PROGRAMME WITH A TEMPERATURE OF 60°C.

COTTON PROGRAMME WITH A TEMPERATURE OF 40°C.

These programmes are suitable to clean normally soiled cotton laundry and they are the most efficient programmes in terms of combined energy and water consumptions for washing cotton laundry.

These programmes have been developed to be compliant with the temperature on the wash label on the garments and the actual water temperature may slightly differ from the declared temperature of the cycle.

The spin speed may also be reduced, to match any guidelines suggested on the fabric label, or for very delicate fabrics cancel the spin completely this option is available with a spin speed button. This function can be activated with the button SPIN SPEED.

If the label does not indicate specific information, it is possible to use the maximum spin expected in the program.

Programmes selection

To clean different types of fabrics and various levels of dirt, the washing machine has specific programs to meet every need of washing (see table of programmes).

ActivEco 20°C

This innovative programme, allows you to wash different fabrics and colours together, such as cottons, synthetics and mixed fabrics at only 20°C and provides an excellent cleaning performance. Consumption on this program is about 40% of a conventional 40°C. cottons wash.

Baby 60°C

This program allows you to wash all baby clothes getting a perfect clean and sanitizing effect, setting the temperature at 60°C minimum. To optimize the result of the sanitizing effect we recommend the use of powder detergent.

Daily 59 Min.

This specially designed programme maintains the high quality wash performance whilst greatly reducing the wash time. The programme is designed for a reduced load (see table of programmes).

Rapid (14/30/44 Min.)

Washing cycle suggested for low loads and slightly dirty. With this program it is recommended to reduce the quantity of detergent normally used, in order to avoid unnecessary waste. Selecting the RAPID program and acting on the button you can choose one of three programs available.

Shirts

The washing cycle is optimized to reduce the creation of creases, keeping an excellent washing performance. It is also possible to further reduce the spin speed, to ensure an easier ironing.

Dark Colours

Program designed to mix all dark garments and to avoid the loss of colour and the formation of creases. We recommend the use of liquid detergent.

Auto Clean

This program is suited to clean the drum of your appliance. It is recommended to use this program every 50 washing cycles, to ensure a long service life and avoid bad odors. Make sure

to start the program exclusively without laundry in the machine, using only powder detergent for washing machine. When the washing cycle finishes, open the door of the washing machine to dry the drum.

Rinse

This program performs 3 rinses with an intermediate spin (which can be reduced or excluded by using the appropriate button). It is used for rinsing any type of fabric, for example after a wash carried out by hand.

Drain & Spin

The program completes the drain and a maximum spin. It is possible to delete or reduce the spin with the SPIN SPEED button.

Lingerie

This program has been designed to perfectly clean the everyday underwear: it is particularly indicated for cottons and resistant synthetics, with also the possibility to mix colours (colourfast clothes only).

Hand & Silk

This programme allows a delicate washing cycle for garments specified as "Hand Wash only" and laundry items made from Silk or specified as "Wash as Silk" on the fabric label.

Wool

This program performs a wash cycle dedicated to the wool fabrics that can be washed in a washing machine, or the articles to be washed by hand.

Delicates

This program alternates among moments of work during breaks and is particularly suitable for washing delicate fabrics. The wash cycle and rinses are carried out with a high level of water to ensure the best performance.

Mixed

The washing and rinsing are optimized in the rhythms of rotation of the drum and to the water levels. The gentle spin, ensures a reduced formation of creases in the fabric.



This program is suitable to clean normally soiled cotton laundry and it is the most efficient program in terms of combined energy and water consumptions for washing cotton laundry.

7. CUSTOMER SERVICE CENTRE AND WARRANTY

If you believe the washing machine is not working correctly, consult the quick guide provided below with some practical tips on how to fix the most common problems.

Problem	Possible causes and practical solutions
<i>The washing machine does not work/start</i>	<p>Make sure it is correctly plugged in.</p> <p>Make sure power is on.</p> <p>Check whether the required program was correctly selected and to have correctly started the machine.</p> <p>Make sure the fuse has not blown and that the wall socket is working, testing it with another appliance such as a lamp.</p> <p>The porthole may not be correctly closed: open and close it again.</p>
<i>The washing machine does not fill with water</i>	<p>Make sure the water faucet is open.</p> <p>Make sure the timer is correct set.</p>
<i>The washing machine does not drain water</i>	<p>Make sure the filter is not clogged.</p> <p>Make sure the drain hose is not bent.</p> <p>Make sure there are no foreign objects in the filter.</p>
<i>Water leaked on the floor near the washing machine</i>	<p>This may be due to a leak in the gasket between the faucet and supply tube; in this case, replace it and tighten the tube and faucet.</p>
<i>The washing machine does not centrifuge</i>	<p>This could be due to the fact that water has not been completely drained: wait a few minutes.</p> <p>Some models include a "no centrifuge" function: make sure it is not on.</p> <p>An excessive amount of detergent could prevent centrifuge: reduce the amount at the next wash.</p>
<i>Strong vibrations are heard during centrifuge</i>	<p>The washing machine may not be fully levelled: if necessary, adjust the feet as indicated in the specific section.</p> <p>Make sure transport brackets were removed.</p> <p>Make sure the load is evenly distributed.</p>
<i>If a specific ERROR appears of blinks</i>	<p>If error no. 0, 1, 5, 7 or 8 appears or blinks, contact the Customer Service Centre directly.</p> <p>If error no. 2 appears or blinks, the machine does not load water. Make sure the water faucet is open.</p> <p>If error no. 3 appears or blinks, the machine does not correctly drain. Make sure the drain is free and that the drain hose is not bent.</p> <p>If error no. 4 appears or blinks, the machine is too full. Close the water faucet and contact the Customer Service Centre.</p> <p>If error no. 9 appears or blinks, turn off the washing machine, wait 10 – 15 seconds and restart the program.</p>

The use of ecological detergents without phosphates may cause the following effects:

- **cloudier rinse drain water:** This effect is tied to the suspended zeolites which do not have negative effects on rinse efficiency.

- **white powder (zeolites) on laundry at the end of the wash:** this is normal, the powder is not absorbed by fabric and does not change its colour.

- **foam in the water at last rinse:** this does not necessary indicate poor rinsing.

- **abundant foam:** This is often due to the anionic surfactants found in the detergents which are hard to eliminate from laundry.

In this case, do not re-rinse to eliminate these effects: it will not help at all.

If the problem persists or if you suspect a malfunction, immediately contact the **Hoover** Customer Service Centre.

You can also register for the **Hoover** service plan to receive free home service after the warranty expires.

Attention: the call is not toll-free. The cost will be communicated in a voice message by your telephone operator's customer service.

Hoover recommends you always use original spare parts available at our Customer Service Centre.

Warranty

The product is guaranteed under the terms and conditions stated on the certificate included with the product. The warranty certificate must be duly filled in and stored, so as to be shown to the Authorised **Hoover** Service Centre in case of need.

Register your product!

Don't waste time. Register your washing machine at once, and discover the benefits to which you are entitled. Discover how at www.registerhoover.com or by calling the number stated on the related material.

The manufacturer declines all responsibility for any printing errors in the booklet included with this product. Moreover, it also reserves the right to make any changes deemed useful to its products without changing their essential characteristics.

