

Honeywell

Dolphin™ 6110 Mobile Computer

with Windows® Embedded Handheld 6.5

User's Guide

Disclaimer

Honeywell International Inc. (“HII”) reserves the right to make changes in specifications and other information contained in this document without prior notice, and the reader should in all cases consult HII to determine whether any such changes have been made. The information in this publication does not represent a commitment on the part of HII.

HII shall not be liable for technical or editorial errors or omissions contained herein; nor for incidental or consequential damages resulting from the furnishing, performance, or use of this material.

This document contains proprietary information that is protected by copyright. All rights are reserved. No part of this document may be photocopied, reproduced, or translated into another language without the prior written consent of HII.

Web Address: www.honeywellaidc.com

Trademarks

Dolphin is a trademark or registered trademarks of Hand Held Products, Inc. or Honeywell International Inc.

Microsoft, Windows, Windows Mobile, Windows Embedded Handheld, Windows CE, Windows NT, Windows 2000, Windows ME, Windows XP, ActiveSync, Outlook, and the Windows logo are trademarks or registered trademarks of Microsoft Corporation.

Other product names mentioned in this manual may be trademarks or registered trademarks of their respective companies and are the property of their respective owners.

Other Trademarks

The Bluetooth trademarks are owned by Bluetooth SIG, Inc., U.S.A. and licensed to Honeywell International Inc.

Patents

For patent information, please refer to www.honeywellaidc.com/patents.

©2013-2014 Honeywell International Inc. All rights reserved.



Table of Contents

Chapter 1 - Agency Approvals

Chapter 2 - Getting Started

Out of the Box	2-1
Initial Setup for Dolphin 6110 Terminals	2-1
LED Indicators.....	2-2
Home Screen	2-4
Title Bar.....	2-4
Horizontal Scroll.....	2-5
Horizontal Scroll.....	2-6
Tile Bar.....	2-6
Pop-Up Menus	2-6
Selecting Programs.....	2-6
File Explorer.....	2-7
File Provisioning on the Dolphin 6110.....	2-8
Search.....	2-8
Turning Power On/Off	2-9
Suspend Mode	2-9
Resetting the Terminal.....	2-9

Chapter 3 - Hardware Overview

Standard Terminal Configurations	3-1
Dolphin Peripherals/Accessories for the Dolphin 6110.....	3-1
USB Communication Cable for the Dolphin 6110.....	3-2
Front Panel Features	3-2
Using the Touch Panel.....	3-3
Installing a Screen Protector	3-4
Back Panel Features.....	3-4
Left Side Panel Features.....	3-5
Right Side Panel Features	3-6
Top Panel Features.....	3-6
Bottom Panel Features	3-7
Battery Power.....	3-7
Battery Pack.....	3-8
Managing Battery Power.....	3-9
Storage Guidelines.....	3-9
Hardware Maintenance	3-10
Installing Memory Cards	3-10
Dolphin 6110 Technical Specifications	3-12

Chapter 4 - Using the Keypad

Overview	4-1
Navigation Keys	4-1
Basic Keys	4-1

Alpha/Numeric Modes	4-2
Alpha Indicators on the Number Keys	4-2
Function Key Combinations.....	4-2
CTRL Key Combinations	4-3
Program Buttons.....	4-3

Chapter 5 - Using the Image Engine

Overview.....	5-1
Available Image Engines	5-1
Depth of Field	5-1
Supported Bar Code Symbologies	5-2
Activating the Engine.....	5-3
Capturing Images (56XX Engine only)	5-3

Chapter 6 - Using the Laser Engine

Overview.....	6-1
Available Laser Engines	6-1
Depth of Field - N4313-TTL	6-1
Supported Bar Code Symbologies	6-1
Activating the Engine.....	6-2
Decoding a Bar Code	6-2

Chapter 7 - System Settings

Overview.....	7-1
Clock & Alarms	7-2
Personal Menu	7-3
Buttons.....	7-3
Program Buttons.....	7-5
System Menu.....	7-8
About	7-9
Backlight	7-9
Certificates.....	7-10
Encryption.....	7-11
HSM SystemInfo.....	7-11
Error Reporting.....	7-12
Managed Programs	7-12
Memory.....	7-12
Power.....	7-14
Regional Settings.....	7-16
Remove Programs.....	7-16
Screen	7-18
SIP Configuration	7-19
Task Manager.....	7-20

Chapter 8 - Communication

Connecting the Dolphin 6110-USB Communication Cable	8-1
Charging Terminal with USB Cable.....	8-1

Connections Menu.....	8-3
Receiving Data	8-3
Connections Manager	8-4
To Access the Connections Manager.....	8-4
Tasks	8-5
Advanced.....	8-6
Dolphin Wireless Manager	8-7
Dolphin Wireless Manager Window.....	8-7
Enabling the Radios.....	8-8
Accessing Radio Configuration Utilities	8-8
Network Cards.....	8-9
Connecting and Synchronizing the Terminal and Workstation.....	8-9
Installing Additional Software	8-12
Adding Programs Using ActiveSync or Windows Mobile Device Center.....	8-12
Connecting the Terminal to a Wireless Network.....	8-13
Adding Programs Using the Internet.....	8-13
Software Upgrades.....	8-14

Chapter 9 - Working with the Bluetooth Radio

Enabling the Bluetooth Radio	9-1
Pairing and Trusted Devices	9-2
Connecting to Other Bluetooth Devices	9-2
Transferring Files.....	9-4
Making the Terminal Discoverable	9-6

Chapter 10 - Dolphin HomeBase (Model 6100-HB)/eBase (Model 6100-EHB) Device

Overview.....	10-1
Front Panel	10-2
Back Panel	10-3
Powering the Dolphin HomeBase Device.....	10-4
eBase Clamp-on Ferrite Core Installation	10-4
Charging the Battery.....	10-5
Charging a Spare Battery	10-6
Checking Battery Power	10-6
Technical Specifications	10-7

Chapter 11 - Dolphin 6110 ChargeBase Device (Model 6100-CB-1)

Overview.....	11-1
Parts and Functions.....	11-2
Front Panel	11-2
Back Panel	11-2
Power	11-2
Connecting Power to the ChargeBase	11-3
Charging the Battery.....	11-3
To Power a Terminal and Charge its Battery.....	11-3
Mounting the ChargeBase.....	11-4

Chapter 12 - Dolphin 6110 Net Base Device (Model 6100-NB)

Overview.....	12-1
Parts and Functions.....	12-2
Front Panel	12-2
Back Panel	12-3
Bottom Panel	12-4
Power	12-4
Connecting Power to the Net Base.....	12-4
Charging the Battery.....	12-5
To Power a Terminal and Charge its Battery.....	12-5
Communication.....	12-5
Software Requirements	12-5
Connecting the Dolphin Terminal to the Net Base	12-5
Mounting the Net Base	12-6

Chapter 13 - Dolphin QuadCharger Device

Overview.....	13-1
QuadCharger Device	13-1
Battery Charging.....	13-2
Recommendations for Storing Batteries	13-3
Troubleshooting.....	13-3
Technical Specifications	13-4

Chapter 14 - Customer Support

Technical Assistance.....	14-1
Product Service and Repair.....	14-1
Limited Warranty	14-1
Limited Warranty Duration.....	14-2
How to Extend Your Warranty	14-2

Agency Approvals

Label Locations

Dolphin 6110 mobile computers meet or exceed the requirements of all applicable standards organizations for safe operation. However, as with any electrical equipment, the best way to ensure safe operation is to operate them according to the agency guidelines that follow. Read these guidelines carefully before using your mobile computer.

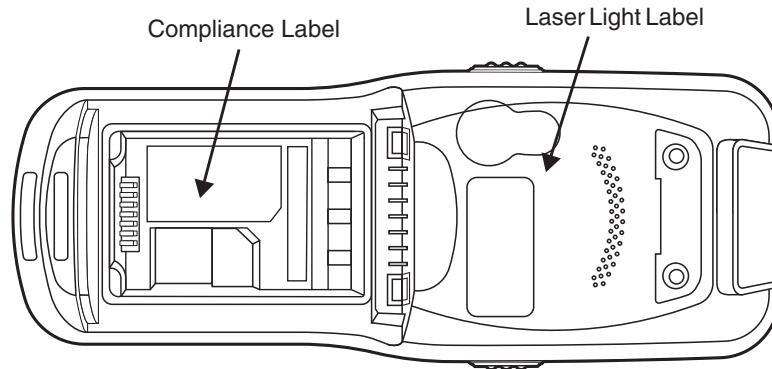

Laser Safety Label

If the following label is attached to your product, it indicates that the product contains an engine with a laser aimer:

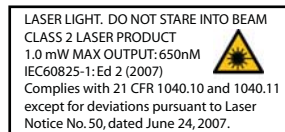

N4313-TTL Safety & RF Approvals by Country:

Country	Safety	RF (Radio)
U.S.A.	UL60950-1	FCC Part 15, Sub part B, Sub part C, Sub part E
Canada*	C-UL CSA C22.2 No. 60950-1-07	ICES-003, RSS 210
European Community	IEC 60825-1:2007 IEC62471:2008 EN60950-1:2006+A11:2009+A1:2010+A12:2011	EN55022 (CISPR 22) Class B EN55024:2010 EN300 328 EN300 440-2 EN301 489-1 EN301 489-17 EN301 893 EN62311 EN62209-2
China	CCC	SRRC
Mexico	NOM-019	NOM-121

* Does not apply to N4313-TTL laser engine.

R&TTE Compliance Statement—802.11a/b/g/n and/or Bluetooth

Dolphin RF terminals are in conformity with all essential requirements of the R&TTE Directive (1999/5/EC).

This product is marked with **CE** 0984  in accordance with the Class II product requirements specified in the R&TTE Directive, 1999/5/EC. The equipment is intended for use throughout the European Community; PAN European Frequency Range: 2.402–2.480 GHz.

Restrictions for use in France are as follows:

- Indoor use: Maximum power (EIRP*) of 100 mW for the entire 2.400–2.4835 GHz
- Outdoor use: Maximum power (EIRP*) of 100 mW for the 2.400–2.454 GHz band & maximum power (EIRP*) of 10 mW for the 2.454–2.483 GHz band.

Frequency band 5180-5320 MHz is restricted to indoor use only.

CE The CE Mark on the product indicates that the system has been tested to and conforms with the provisions noted within the 2004/108/EC Electromagnetic Compatibility Directive and the 2006/95/EC Low Voltage Directive. Honeywell shall not be liable for use of our product with equipment (i.e., power supplies, personal computers, etc.) that is not CE marked and does not comply with the Low Voltage Directive.

For further information, contact:

Hand Held Products Europe B.V.
Nijverheidsweg 9-13
5627 BT Eindhoven
The Netherlands

 **Warning!** To prevent possible hearing damage, do not listen at high volume levels for long periods.

CB Scheme

Certified to CB Scheme IEC 60950-1.

FCC RF Radiation Exposure Statement

This equipment complies with FCC RF radiation exposure limits set forth for an uncontrolled environment. NII frequency band 5150-5250 MHz is restricted to indoor use only.

Dolphin RF Terminal—802.11a/b/g/n and/or Bluetooth

This device complies with Part 15 of the FCC Rules. Operation is subject to the following two conditions: (1) this device may not cause harmful interference, and (2) this device must accept any interference received, including interference that may cause undesired operation.

This equipment has been tested and found to comply with the limits for a Class B digital device pursuant to Part 15 of the FCC Rules. These limits are designed to provide reasonable protection against harmful interference in a residential installation. This equipment generates, uses, and can radiate radio frequency energy and, if not installed and used in accordance with the instructions, may cause harmful interference to radio communications. However, there is no guarantee that interference will not occur in a particular installation. If this equipment does cause harmful interference to radio or television reception, which can be determined by turning the equipment off and on, the user is encouraged to try to correct the interference by one or more of the following measures:

- Reorient or relocate the receiving antenna.
- Increase the separation between the equipment and receiver.
- Connect the equipment into an outlet on a circuit different from that to which the receiver is connected.
- Consult the dealer or an experienced radio/TV technician for help.

If necessary, the user should consult the dealer or an experienced radio/television technician for additional suggestions. The user may find the following booklet helpful: "Something About Interference." This is available at FCC local regional offices. Our company is not responsible for any radio or television interference caused by unauthorized modifications of this equipment or the substitution or attachment of connecting cables and equipment other than those specified by our company. The correction is the responsibility of the user. Use only shielded data cables with this system.

In accordance with FCC 15.21, changes or modifications not expressly approved by the party responsible for compliance could void the user's authority to operate the equipment.



This device and its antenna must not be co-located or operating in conjunction with any other antenna or transmitter. To maintain compliance with FCC RF exposure guidelines for body-worn operation, do not use accessories that contain metallic components.

CAUTION! Any changes or modifications not expressly approved by the grantee of this device could void the user's authority to operate the equipment.

Canadian Compliance

This radio transmitter has been approved by Industry Canada to operate with the antenna types listed below with the maximum permissible gain and required antenna impedance for each antenna type indicated. Antenna types not included in this list, having a gain greater than the maximum gain indicated for that type, are strictly prohibited for use with this device.

Under Industry Canada regulations, this radio transmitter may only operate using an antenna of a type and maximum (or lesser) gain approved for the transmitter by Industry Canada. To reduce potential radio interference to other users, the antenna type and its gain should be so chosen that the equivalent isotropically radiated power (e.i.r.p.) is not more than that necessary for successful communication.

This Class B digital apparatus complies with Canadian IECES-003.

This device complies with Industry Canada license-exempt RSS standard(s). Operation is subject to the following two conditions: (1) this device may not cause interference, and (2) this device must accept any interference, including interference that may cause undesired operation of the device.

Cet appareil numérique de la Classe B est conforme à la norme NMB-003 du Canada.

Le présent appareil est conforme aux CNR d'Industrie Canada applicables aux appareils radio exempts de licence. L'exploitation est autorisée aux deux conditions suivantes : (1) l'appareil ne doit pas produire de brouillage, et (2) l'utilisateur de l'appareil doit accepter tout brouillage radioélectrique subi, même si le brouillage est susceptible d'en compromettre le fonctionnement.

For European Community Users

Honeywell Scanning & Mobility Product Environmental Information

Refer to www.honeywellaidc.com/environmental for the RoHS / REACH / WEEE information.

Singapore

Complies with
IDA Standards
DA104404

 有毒有害物质名称及含量的标识格式 (Names and Content of Hazardous Substances or Elements)						
部件名称 (Parts Name)	有毒有害物质或元素 (Toxic and Hazardous Substances or Elements)					
	铅 (Pb)	汞 (Hg)	镉 (Cd)	六价铬 (Cr6+)	多溴联苯 (PBB)	多溴二苯醚 (PBDE)
扫描模块 (Scanner Module)	x	o	o	o	o	o
印刷电路部件 (PCA)	x	o	o	o	o	o
外壳 (Housing)	x	o	o	o	o	o
连接线 (Cable)	x	o	o	o	o	o

o: 表示该有毒有害物质在该部件所有均质材料中的含量均在 SJ/T11363-2006 标准规定的限量要求以下 (Indicates that this toxic or hazardous substance contained in all of the homogeneous materials for this part is below the limit requirement in China's SJ/T11363-2006.)
 x: 表示该有毒有害物质至少在该部件的某一均质材料中的含量超出 SJ/T11363-2006 标准规定的限量要求 (Indicates that this toxic or hazardous substance contained in at least one of the homogeneous materials for this part is above the limit requirement in China's SJ/T11363-2006.)

Getting Started

Out of the Box

Verify that your carton contains the following items:

- Dolphin 6110 mobile computer (the terminal)
- Battery pack (3.7v, Li-Ion)
- AC power supply (KSAS0100500200D5; Input: 100-240V AC, 50/60Hz 0.4 Amps; Output: 5 Volts DC, 2.0 A)
- Localized plug adapters

Note: Be sure to keep the original packaging in case you need to return the Dolphin terminal for service; see [Customer Support](#) on page 14-1.

Initial Setup for Dolphin 6110 Terminals

Step 1. Install the Battery

The Dolphin 6110 is shipped with the battery packaged separate from the unit. Follow the steps below to install the battery.

1. Release the strap making it convenient to reach the cover.
2. Remove the battery compartment cover by turning the cover locks upward and removing the cover.
3. Insert the battery into the battery well with the labels facing upward.

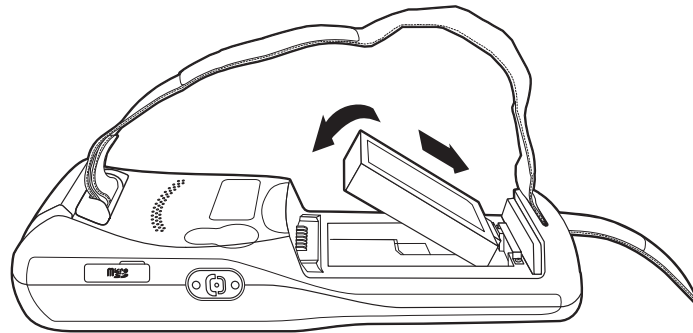

4. Replace the cover with a hinging motion and turn the locks downwards.

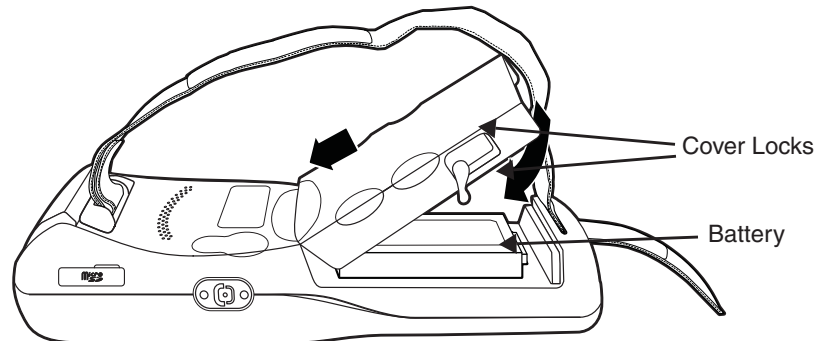

Note: The battery door must be installed prior to booting the unit.

5. Replace the hand strap.

 We recommend use of Honeywell Li-Ion battery packs. Use of any non-Honeywell battery may result in damage not covered by the warranty.

Step 2. Charge the Batteries

Dolphin 6110s ship with the battery pack significantly discharged of power. Charge the battery pack with the Dolphin charging cable until the LED turns green (red while charging). The average charge time for a fully depleted battery is 7 1/2 hours. It takes less time if the battery has some charge.

1. Attach the appropriate plug adapter to the plug of the power cable.*
2. Insert the plug into the appropriate power source.
3. Plug the Dolphin power cable into the **DC Power Jack** (see page 3-7) on the bottom end of the unit.

Important: Removing the battery from the terminal erases all non-persistent memory.

LED Indicators

Red LED On	Charging
Green LED On	Battery is fully charged

*This power cable can also be used to power the Dolphin 6110 while in the [Dolphin HomeBase \(Model 6100-HB\)](#)/[eBase \(Model 6100-EHB\) Device](#) (see page 10-1).

 We recommend use of Honeywell peripherals, power cables, and power adapters that comply with L.P.S. Use of any non-Honeywell peripherals, cables, or power adapters may cause damage not covered by the warranty.

 Ensure all components are dry prior to mating terminals/batteries with peripheral devices. Mating wet components may cause damage not covered by the warranty.

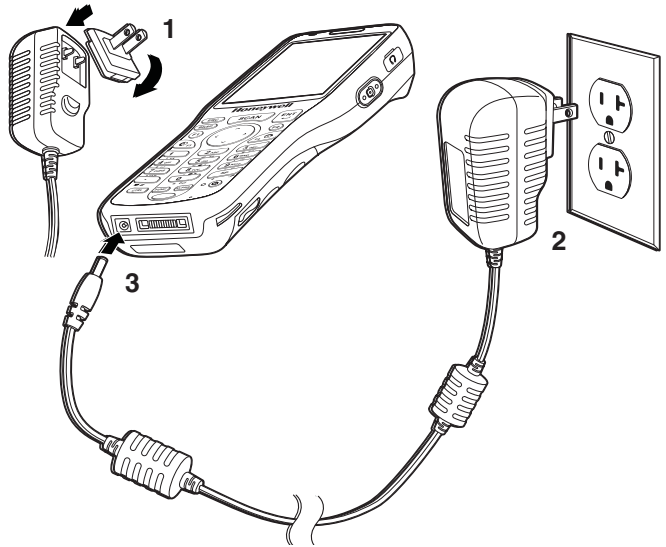

The power adapter on the power cable converts the voltage from the power source to 5 volts DC. Only power adapter cables from Honeywell convert the voltage appropriately. The power cable contains a plug adapter for each geography (US, UK, EU, etc.).

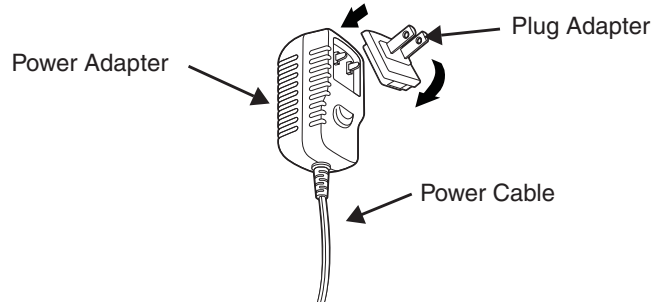

Step 3. Boot the Terminal

The terminal is not connected to an external power source, it begins booting once you push the **Power** button. If the terminal is connected to an external power source (e.g., power cable, HomeBase), it will automatically reboot. Do NOT press any keys or interrupt the boot process.

When the boot process is complete, the Desktop appears, and the terminal is ready for use.

Step 4. Set the Time Zone, Time, and Date

On the Home screen, tap the line that displays the time and date.





When the Clock & Alarms screen appears, tap the arrow to the right of the time zone to open the drop down menu. Select the appropriate time zone from the menu. Set the correct time and date in the remaining fields and tap **OK** to save.

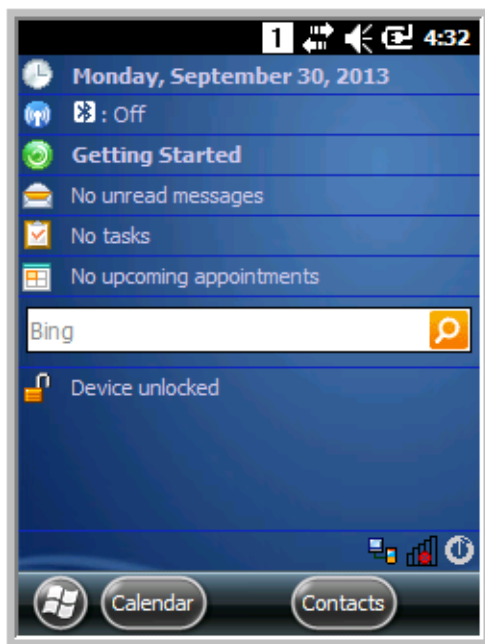

Home Screen

After the Dolphin terminal initializes the first time, you see the Home screen.



Tap  to reach the Start screen from the home screen.







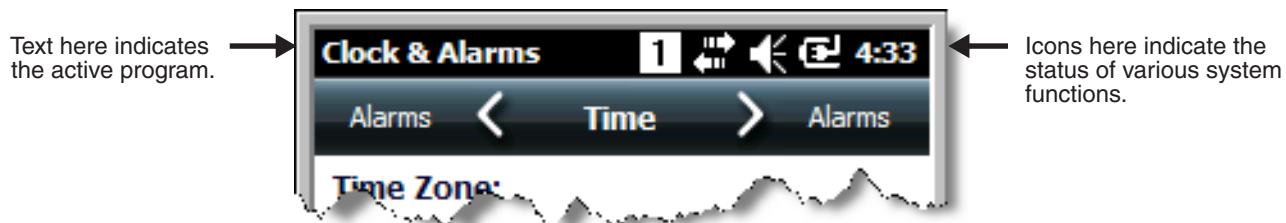













Tap  to access the [Dolphin Wireless Manager Window](#) (see page 8-7) from the home screen.

Title Bar

The Title bar, located at the top of the screen, displays the active program, the status of various system functions, and the current time. Tapping on the title bar provides access to the Horizontal Scroll. The scroll provides access to additional programs and application screens. For additional information, see [Horizontal Scroll](#) on page 2-5.



Horizontal Scroll

Indicator	Meaning
	Synchronizing data
	The terminal could not synchronize data with the workstation via ActiveSync.
	New e-mail
	New text message
	New voicemail
	New instant message
	Ringer off
	A battery error has occurred. Replace the battery pack with a Honeywell Li-poly or Li-ion battery pack.
	Battery is has a full charge
	Battery has a high charge
	Battery has a medium charge
	Battery has a low charge
	Battery has a very low charge and requires charging
	Terminal is running on external power. If a battery pack is installed, the battery is charging in the background.
	The terminal is not connected to external power. A battery is installed, but is defective; specifically, its charge level cannot be measured.
	Active network connection
	No active network connection
	Wi-Fi is on, but device is not connected
	Wi-Fi data call
	Pending alarm
	Bluetooth

Horizontal Scroll

The Horizontal Scroll, located at the top of most application windows, provides access to additional application screens. You can flick left or right on the scroll or tap each label on the scroll, until you get to the desired screen. Tapping a label to the left or right of the center item brings new labels into view.

Note: Tap the Title bar to access the horizontal scroll if it is not visible on the screen.

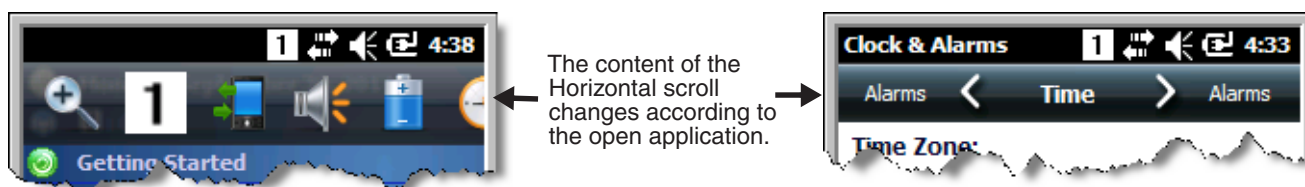

Tile Bar

The Tile bar is located at the bottom of application windows.

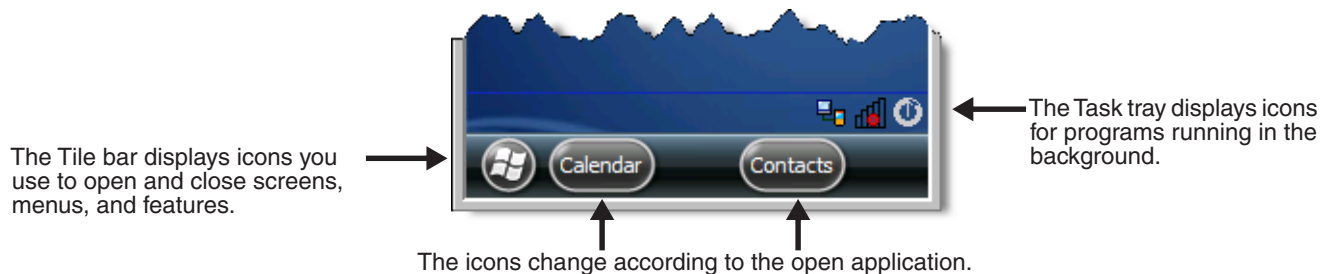

Pop-Up Menus

With pop-up menus, you can quickly choose an action for a selected item. To access a pop-up menu, tap and hold the stylus on the item name of the action you want to perform. When the menu appears, lift the stylus, and tap the action you want to perform.

Tap **OK** to close the menu without performing an action.

Selecting Programs

To see the programs loaded on your terminal, tap  to access the Start Menu. To open a program, tap once on the program icon. To reposition an icon on the Start Menu, tap and hold the stylus on the icon, then drag the icon to the desired position.

File Explorer

You can also use the File Explorer to find files and organize these files into folders.

1. Tap  > **File Explorer** .

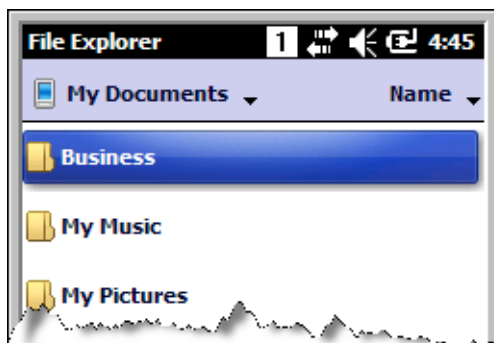

2. Tap the **Up** button at the bottom of the screen to move up one level in the directory.



3. You can move files in File Explorer by tapping and holding on the item you want to move, then tapping **Cut** or **Copy** on popup menu.
4. Navigate to the folder you want to move the file to, then tap and hold a blank area of the window.
5. Tap **Paste** on the pop-up menu.

*Note: If there is no blank space available in the window, tap **Menu** on the command bar, navigate to the end of the menu using the down arrow, then tap **Edit** > **Paste**.*

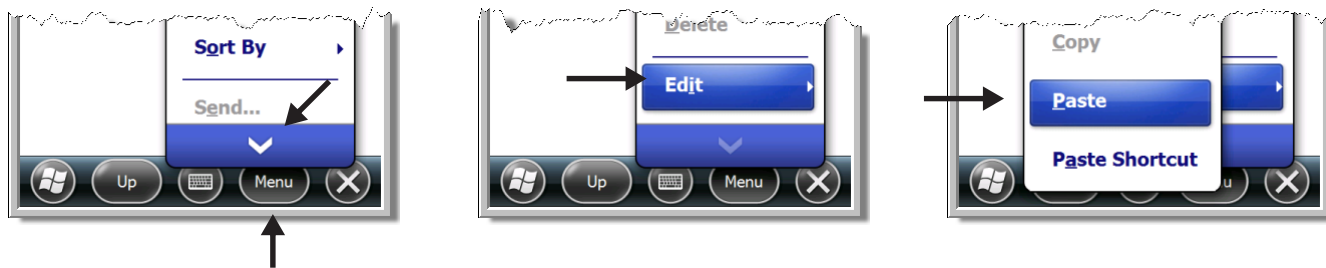

File Provisioning on the Dolphin 6110

\IPSM\Honeywell

The IPSM folder is the only partition on the terminal that persists across a kernel upgrade (*.UPG file extension). During a kernel upgrade, files are automatically copied from the \IPSM\Honeywell folder and then installed in the \Honeywell (root file system) folder as part of the upgrade process.

\IPSM\Honeywell\AutoInstall

The files in the IPSM\Honeywell\AutoInstall folder are only installed when a factory reset or kernel upgrade occurs. Once the files are installed, they persist through hard and soft resets. If a file is added to the folder and a hard or soft reset is performed, it will have no effect. If a program is manually removed using the Remove Programs application (see page 7-16), then the program is not automatically re-installed on a hard or soft reset.

\Honeywell

The Honeywell partition or root file system partition is persistent over a hard reset, soft reset, and the removal of the battery pack or the removal of AC power. However, during a kernel upgrade or factory reset, the root file system is reformatted so all data in the folder is deleted and replaced by any files in the \IPSM\Honeywell folder as part of the upgrade process.

 *To prevent data loss, back up all user data to an SD card or external memory device before performing an upgrade or factory reset.*

\Honeywell\AutoInstall

If you run a CAB file from within the \Honeywell\AutoInstall folder, after the program has been installed, the CAB file will be deleted. However, the program remains installed through all successive hard and soft resets.

If you want the program to be part of the Autoinstall that occurs after a factory reset or software upgrade, paste the program file(s) into the \IPSM\Honeywell\Autoinstall folder.

Contact a Honeywell technical support representative for information on how to perform a factory reset or for information on available software upgrades for your Dolphin terminal. For contact information, see [Product Service and Repair](#) on page 14-1.

 *Note: To prevent data loss, back up all user data to an SD card or external memory device before performing an upgrade.*

Search

The Search feature helps you quickly locate information. Tap  > **Search Phone** .

Enter the text you want to find, select a data type, and then tap **Search**. Select **Larger than 64 KB** in the **Type** drop-down field to quickly find information that is taking up storage space.

Turning Power On/Off

To turn the terminal **On**, press the **Power** button .

To turn the terminal **Off**:

1. Press and hold the **Power** button  for approximately 4 seconds until the options menu displays.
2. Tap **Power off**.

Suspend Mode

Suspend mode differs from **Power off** mode. **Power off** mode is the equivalent to having no battery or external power source connected to the device. In **Suspend** mode, the device enters a low power state to conserve battery power.

Suspend mode automatically turns the system off, which includes turning the screen off to save battery power when the terminal is inactive for a programmed period of time. The automatic timeout limits are adjustable from the **Advance** tab located under **Settings > System > Power** (see page 7-14). In addition, **Suspend** mode also automatically turns off the radio and drivers. The PMIC and main processor wakeup mode clock remain on allowing the system to detect a wakeup interrupt and to resume working.

Press and release the **Power** button  to toggle the terminal in or out of **Suspend** mode.

*Note: You should always place the terminal in **Suspend** mode before removing the battery.*

Resetting the Terminal

There are three types of system resets: a **Soft Reset**, a **Hard Reset**, or a **Factory Reset**. The soft and hard resets preserve all data stored in the file system. Contact a Honeywell technical support representative for more information on how to perform a **Factory Reset**. For contact information, see [Technical Assistance](#) on page 14-1.

A **Soft Reset** (Warm Boot) re-boots the device and preserves any objects created in RAM. You would perform a soft reset when: the terminal fails to respond, after installing some software applications, or after making changes to certain system settings, such as network cards.

A **Hard Reset** (Cold Boot) re-boots the terminal and closes any open applications running in RAM at the time of the reset.

To perform a **Soft Reset** or **Hard Reset**:

1. Press and hold the **Power** button  until the options menu appears.
2. Tap **Soft Reset** or **Hard Reset** on the menu.
3. When the reset is complete, the **Home** screen displays.

*Note: To perform a **Hard Reset** if the screen has stopped responding, press and hold the **Power** button  for approximately 8 seconds until the terminal starts to re-boot. When the reset is complete, the **Home** screen displays.*



Standard Terminal Configurations

Dolphin 6110 WPAN/WLAN
<ul style="list-style-type: none"> • Microsoft Windows Embedded Handheld 6.5 Classic • TI OMAP37xx 800MHz • 512 MB RAM X 512 MB Flash Memory • 28-key shifted alpha numeric keypad • 240x320. 262.144 Color Transmissive TFT Display • Standard Capacity: Li-ion battery: 3.7V / 2200mAh / 8.1 Wh or Extended Capacity: Li-ion battery: 3.7V / 3300mAh / 12.2 Wh • 56XX image engine with laser aiming or N4313-TTL laser engine • (WPAN/WLAN) - Bluetooth and 802.11a/b/g/n radio • Dolphin power cable (included with each Dolphin 6110)

Dolphin Peripherals/Accessories for the Dolphin 6110

The following items are sold separately and enhance your Dolphin 6110's capabilities.

Dolphin HomeBase™ Device

This charging and communication cradle supports USB and RS-232 communication, enabling your terminal to interface with the majority of enterprise systems. When a terminal is seated in a powered base, its battery pack charges in an average of 7 1/2 hours for a fully depleted battery. It takes less time if the battery has some charge.

This device also contains an auxiliary battery well that charges a spare battery.

For more information, see [Dolphin HomeBase \(Model 6100-HB\)/eBase \(Model 6100-EHB\) Device](#) on page 10-1.

Dolphin eBase™ Device

The Dolphin eBase is used to charge the battery and can be used to communicate data from the terminal to a PC/laptop via the Ethernet port.

This device also contains an auxiliary battery well that charges a spare battery.

For more information, see [Dolphin HomeBase \(Model 6100-HB\)/eBase \(Model 6100-EHB\) Device](#) on page 10-1.

Dolphin QuadCharger™ Device

The Dolphin QuadCharger device, a four-slot charging station for Dolphin Li-Ion battery packs, can charge each battery in an average of 7 1/2 hours for a fully depleted battery. It takes less time if the battery has some charge.

For more information, see [Dolphin QuadCharger Device](#) on page 13-1.

Dolphin NetBase Device

The Dolphin NetBase device, enables up to four Dolphin 6110 mobile computers to communicate with a host device over an Ethernet network.

For more information, see [Dolphin 6110 Net Base Device \(Model 6100-NB\)](#) on page 12-1.

USB Communication Cable for the Dolphin 6110

The USB Communication Cable for the 6110 is used when communicating between the terminal and a PC/laptop via the USB port. The cup-style 6110-USB cable slides onto the bottom of the device lining up with the connector. The cable unit includes an opening for the power cable. See [Connecting the Dolphin 6110-USB Communication Cable](#) (page 8-1).

Li-Ion Battery Packs

The Li-Ion battery pack provides the main power supply for the terminal. For more information, see [Battery Power](#) on page 3-7.

For information on how to purchase these items, contact a Honeywell sales representative.

Front Panel Features

Note: Your Dolphin model may differ from the model illustrated; however, the features noted are standard for all Dolphin 6110 models unless otherwise indicated.

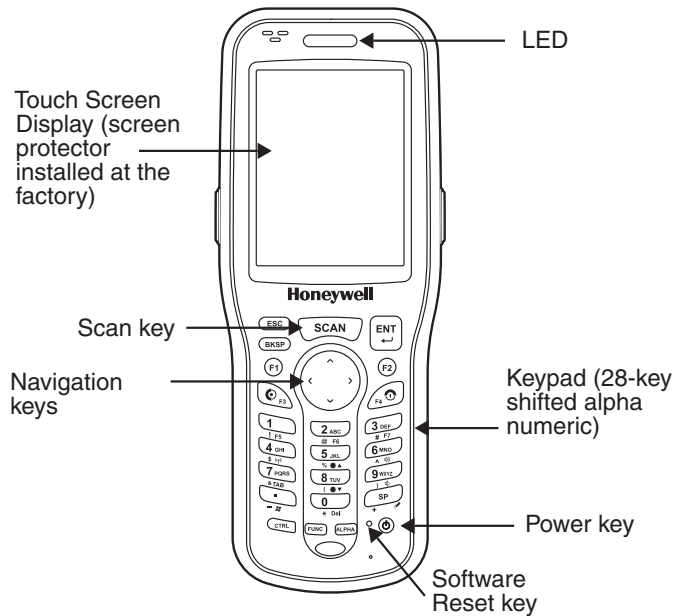

Scan/Decode LED

Note: The LED is user-programmable.

LED color	Description
Red	While battery is charging. Once Scan button pressed in scanning applications.
Green	When battery charging is complete. Scanned bar code is successfully decoded.
Blue or Red	Soft or hard resets.

Scan Key

The SCAN key is centrally located for easy access with the right or left hand. When pressed, the SCAN key activates the scanner/imager. The SCAN key also functions as a system wakeup control for the terminal.

Keypad

A 28-key shifted alpha numeric keypad is included on the unit.

Microphone

The integrated microphone can be used for audio recording.

Touch Screen Display

The display is a LCD (Liquid Crystal Display) with a 4-wire analog resistive touch screen. The 2.8" (1/4) VGA (Video Graphic Array) is transmissive active matrix color, backlit, and the resolution is 240 x 320; see [Backlight](#) on page 7-9. The touch panel is a 4-wire analog resistive touch.



Dolphin 6110s ship with a screen protector already installed over the touch screen lens to help prevent damage to the touch screen. Do NOT remove this screen protector before initial use. Honeywell recommends using screen protectors, especially for applications that require high volume interfacing with the touch screen. You can purchase additional screen protectors by contacting your Honeywell sales representative.

For touch screen input, use the stylus included with the terminal or your finger. The method you choose depends on which one is most appropriate for your application. While there is a great deal of variation in different applications, you generally achieve greater accuracy with the stylus for buttons or icons that are close together.



Use of objects, such as paper clips, pencils, or ink pens on the touch screen can damage the input panel and may cause damage not covered by the warranty.

Using the Touch Panel

Honeywell defines proper use of the terminal touch panel as using a screen protector and proper stylus. Screen protectors maintain the ongoing integrity (i.e., prevent scratching) of the touch panel, which is why their use is recommended for applications that require a high-to-medium level of interface with the touch panel, such as signature capture for proof of delivery.

Honeywell advocates the use of screen protectors on all Dolphin devices. We recommend implementing

a screen protector replacement program to ensure that screen protectors are replaced periodically when signs of damage/wear are noticeable. Replacement screen protectors can be purchased directly from Honeywell. Please contact a Honeywell sales associate for details.

Honeywell also mandates use of a proper stylus, which is one that has a stylus tip radius of no less than 0.8 mm. Use of the Honeywell stylus included with the terminal is recommended at all times. Honeywell warranty policy covers wear on the touch panel for the first twelve (12) months if a screen protector is applied and an approved stylus is used for the 12 month duration covered by the warranty.

Installing a Screen Protector

Dolphin terminals ship with a screen protector already installed. You will need to replace the screen protector at regular intervals.

1. After the current screen protector has been removed from the touch panel, clean the touch panel thoroughly with a clean, non-abrasive, lint-free cloth. Make sure there is no debris on the touch panel.
2. Align the exposed section of the protector with the left edge of the touch panel. Make sure that the screen protector is flush with each side of the touch panel. To reposition, lift up gently and reapply.
3. Press the screen protector firmly and carefully across the surface of the touch panel as you peel away the backing.
4. If necessary, smooth out any air pockets or bumps.

Back Panel Features

Note: Your Dolphin model may differ from the model illustrated; however, the features noted are standard for all Dolphin 6110 models unless otherwise indicated.

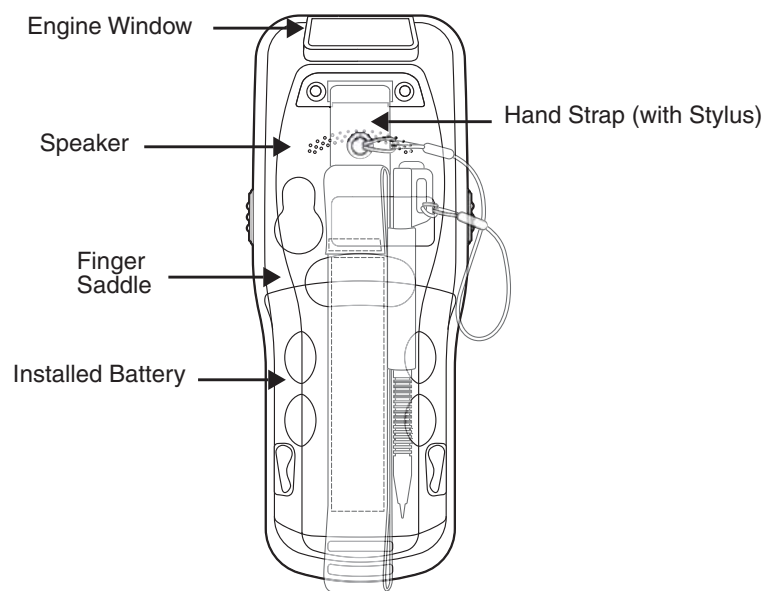

Hand Strap

The Dolphin 6110 comes with an adjustable, elastic hand strap. The strap is attached to the device with the two small screws. It is threaded through the slot on the bottom of the back of the unit.

Keep in mind that the hand strap covers the battery. When you want to replace the battery, you will need to adjust the hand strap accordingly.

Finger Saddle

This is a slightly depressed and angled area of the back housing that is designed to cradle or “saddle” your finger while holding the terminal. This unique ergonomic design makes the terminal comfortable to hold and helps prevent you from accidentally dropping the terminal.

Installed Battery

For information about installing the battery, see [Changing the Battery Pack](#) on page 3-8
For information about battery power, see [Battery Power](#) on page 3-7.

Speaker

The integrated speaker sounds audio signals as you scan bar code labels and enter data, but emits no ambient noise on system activity (i.e., processor, memory access, radio traffic, etc.). The speaker can also be used for playing sounds (e.g., WAV or MP3 files).

The speaker meets the following SPL levels at 40cm:

- 500Hz–67db
- 1KHz–72db
- 4KHz–72db

Stylus

Dolphin 6110 terminals ship with a stylus inserted in a loop on the hand strap. The stylus is used to operate the touch panel. The stylus features a special tip for added accuracy and ease of use. Store the stylus in the hand strap when you’re not using it.

Left Side Panel Features

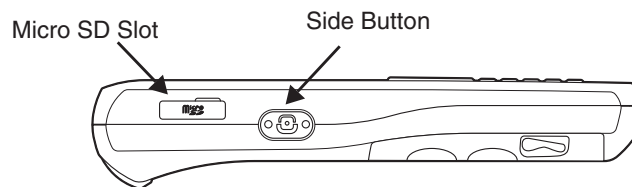

Side Button

There is a side button on both side panels. You can use the Program Buttons option to change the functionality of the side buttons. Tap  > **System** > **Settings** > **Program Buttons**.

Side Door

The rubber door on the left side panel provides access to the Micro SD slot.

When closed, the side door seals the terminal from moisture and particle intrusion thus preserving the terminal’s environmental rating.

Right Side Panel Features

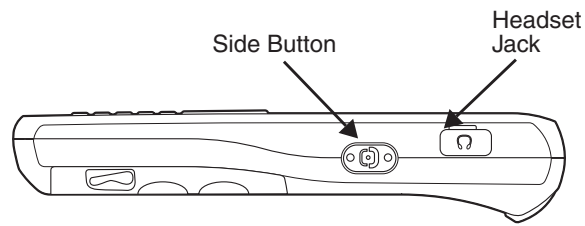

Headset Jack

The rubber door on the right side panel provides access to the headset jack. This is a 3.5mm audio jack that supports a headset with a mono speaker and microphone.

When closed, the side door seals the terminal from moisture and particle intrusion thus preserving the terminal's environmental rating.

Side Button

There is a side button on both side panels. You can use the Program Buttons option to change the functionality of the side buttons. Tap  > **System** > **Settings** > **Program Buttons**.

Top Panel Features

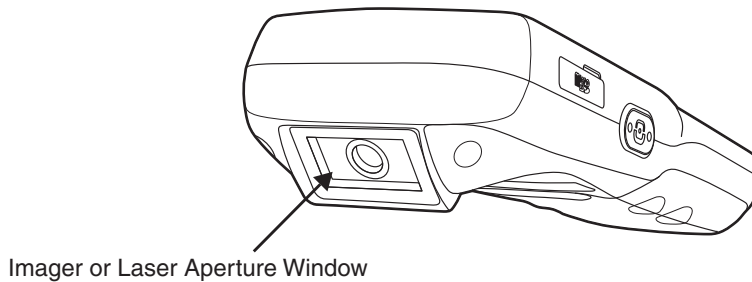

Imager or Laser Aperture Window

The angled image engine or laser engine reads and decodes most popular bar code symbologies and takes images like a digital camera (image engine only). For more information, see [Using the Image Engine](#) on page 5-1 or see [Using the Laser Engine](#) on page 6-1.

Bottom Panel Features

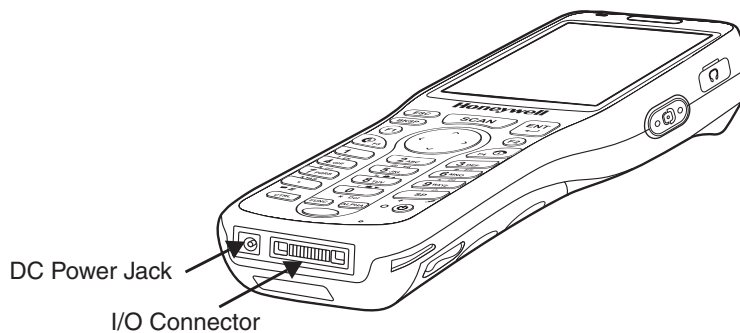

DC Power Jack

The DC power jack receives external power from the Dolphin power cable that is included in the box with the terminal. When connected to the Dolphin power cable, the terminal is powered and the battery pack is charging.

I/O Connector

The I/O mechanical connector is designed to work exclusively with Dolphin 6110 peripherals and cables. This connector powers the terminal, charges the battery, and facilitates communication. The I/O connector supports High-speed USB 2.0 communication (up to 480 Mbps) and RS-232 communications with a maximum speed of 115Kbps and seven baud rate settings.

Through this connector, you can communicate with a host workstation via Microsoft ActiveSync; see [Connecting and Synchronizing the Terminal and Workstation](#) on page 8-9.

The I/O connector supports the following signals:

- DC IN
- Transmitted Data
- Request To Send
- USB Host +5V
- USB Host D+
- USB Host D-
- USB Host Detect
- Clear To Send
- Received Data
- GND
- RS-232 Shutdown
- USB Client D+
- USB Client D-
- USB Client +5V

Note: Signals referenced are for a DTE device.

Battery Power

The battery pack is located on the back panel (see [Battery Pack](#) on page 3-8)

The battery must be charged to full capacity before using the Dolphin 6110 for the first time!

Charge the battery pack with the Dolphin USB Charging/Communication cable until the LED turns green (red while charging). The average charge time for a fully depleted battery is 7 1/2 hours. It takes less time if the battery has some charge.

Battery Pack

 **Caution:** We recommend use of Honeywell Li-Ion battery packs. Use of any non-Honeywell battery may result in damage not covered by the warranty.

There are two Li-ion battery packs available for the 6110:

Standard Capacity: Li-ion 3.7V/2200mAh/8.1Wh

Extended Capacity: Li-ion 3.7V/3300mAh/12.2Wh

Changing the Battery Pack

Before installing a battery pack, press the **Power** button to put the terminal into [Suspend Mode](#) (see page 2-9) so that operations are suspended before removing the power source. The Dolphin 6110 is shipped with the battery separate from the unit. You will need to loosen the hand strap, remove the battery door, insert the battery, and replace the battery door. Refer to the instructions included in "[Install the Battery](#)" on [page 2-1](#) section.

Note: The battery door must be installed prior to booting the unit.

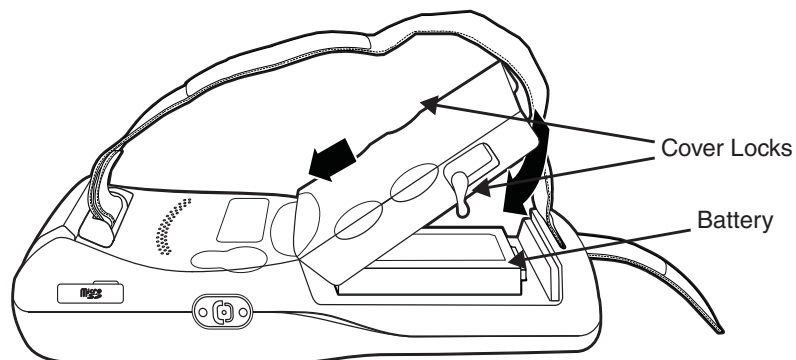

Charging Options

Dolphin terminals ship with the battery significantly discharged of power. Before using a Dolphin terminal for the first time, charge the battery with a Dolphin charging device for a minimum of 6 hours for the standard battery and 9 hours for the extended battery. When the battery is installed in the terminal, you can use any of the peripherals listed below to charge the battery.

- [Dolphin HomeBase \(Model 6100-HB\)/eBase \(Model 6100-EHB\) Device](#) (see page 10-1)
- [Dolphin Comm/Charge Cable; Managing Battery Power](#) (see page 3-9). You may charge the device using the USB connection if you do not have a wall adapter. Access the option by selecting  > **Settings** > **System** > **Power** > **USB Charging** (see [Charging Terminal with USB Cable](#) on page 8-1).

To fully charge the Li-Ion battery before installing it in the terminal, use the

- [QuadCharger Device](#) (see page 13-1) or insert the battery in the spare battery charging well in the back of either the Dolphin HomeBase or Dolphin eBase.

Charging Time

The standard capacity 2200mAh Li-ion battery pack requires 6 hours to charge to full capacity, while the extended capacity 3300mAh pack requires 9 hours. It takes less time if the battery has some charge.

Managing Battery Power

Data and files saved on the Dolphin terminal may be stored in RAM memory; therefore, maintain a continuous power supply to the terminal to help prevent data loss. When you remove a battery pack, insert another charged battery pack in the Dolphin. If the battery pack is low, insert the terminal into a charging peripheral to power the terminal and begin recharging the battery.

Note: If you remove the battery pack or it completely discharges, all data in RAM is cleared. Always place the terminal in Suspend mode before removing the battery to ensure that any changes made are saved to the flash memory.

*Note: If the battery is low and the terminal is in Suspend Mode, pressing the **Power** button does **not** wake the Dolphin 6110 terminal; you must first replace the discharged battery with a fully charged battery or apply A/C power to the terminal.*

Checking Battery Power

Power icons appear in the title bar at the top of the window. Tap on the battery icon to open the Power Properties or select  > **Settings** > **System** > **Power**. The Battery screen opens displaying the charge status of the battery.

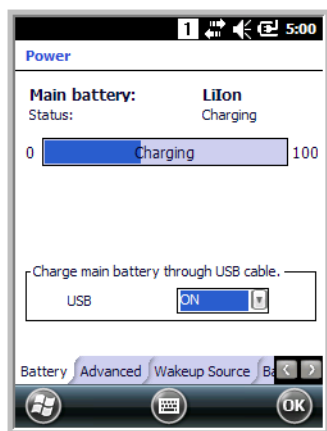

Storage Guidelines

To maintain optimal battery performance, follow these storage guidelines:

- Avoid storing batteries outside the specified range of -4 to 140° F (-20 to 40°C) or in extremely high humidity.
- For prolonged storage, it is recommended that the battery be at a 40% - 50% charge level, be removed from the device, and stored in a controlled temperature environment. Following these recommendations will maximize battery life.

Guidelines for Battery Pack Use and Disposal

The following are general guidelines for the safe use and disposal of batteries:

- Do not disassemble or open, crush, bend or deform, puncture or shred.
- Do not modify or remanufacture, attempt to insert foreign objects into the battery, immerse or expose to water or other liquids, expose to fire, explosion or other hazard.

-
- Improper battery use may result in a fire, explosion or other hazard.
 - We recommend use of Honeywell Li-Ion battery packs. Use of any non-Honeywell battery may pose a personal hazard to the user.
 - Only use the battery for the system for which it is specified. Do not use a battery in any other manner outside its intended use in Dolphin terminals and peripherals.
 - Ensure all components are dry prior to mating batteries with peripheral devices. Mating wet components may cause damage not covered by the warranty.
 - Replace defective batteries immediately; using a defective battery could damage the Dolphin terminal.
 - Never throw a used battery in the trash. Promptly dispose of used batteries in accordance with local regulations.
 - Do not short-circuit a battery or throw it into a fire; it can explode and cause severe personal injury. Do not allow metallic conductive objects to contact battery terminals.
 - Don't use a battery in any other manner outside its intended use in Dolphin terminals and peripherals.
 - Excessive discharge damages a battery. Recharge the battery when your terminal indicates low battery power.
 - If you observe that the Honeywell battery supplied is physically damaged in some way, send it to Honeywell International Inc. or an authorized service center for inspection, [see Technical Assistance](#) on page 14-1
 - Avoid dropping the terminal or battery. If the terminal or battery is dropped, especially on a hard surface, and the user suspects damage, send it to a Honeywell International Inc. or an authorized service center for inspection, [see Technical Assistance](#) on page 14-1.
 - Although your battery can be recharged many times, it will eventually be depleted. Replace it after the battery is unable to hold an adequate charge.
 - If you are not sure the battery or charger is working properly, send it to Honeywell International or an authorized service center for inspection.

Charging

You can begin using the Dolphin terminal after charging the battery for an average of 7 1/2 hours for a fully depleted battery. It takes less time to charge the battery if the battery has some charge.

Hardware Maintenance

When needed, clean the image/laser aperture window and the LCD display with a clean, non-abrasive, lint-free cloth. The terminal can be cleaned with a damp cloth.

Installing Memory Cards

Note: Honeywell recommends the use of Single Level Cell (SLC) industrial grade microSD or microSDHC memory cards with Dolphin terminals for maximum performance and durability. Only memory cards purchased directly from Honeywell are supported. Contact a Honeywell sales representative for additional information on qualified memory card options.

To install an SD card:

1. Open the access door on the left side.
2. Insert the SD card with the label facing upward.

Note: To remove an installed SD card while the access door is open, tap on the edge lightly to unlock the card; the card pops out just enough for you to grab its edge and to pull it out.

3. Replace the access door.

The rubber door is required for 1) proper functioning of the SD card and 2) preserving the environmental rating for water sealing. Do not remove the rubber door.

Note: Do not use the terminal when the access door is open. When this door is fastened securely and properly, the memory interface is sealed against moisture and particle intrusion, read/write data is stored securely, and the terminal's environmental rating is preserved.

4. Tap the **Power** key to resume operation.
5. To verify that the operating system recognizes the new memory card, open Windows Explorer and navigate to My Device\Storage Card.

Dolphin 6110 Technical Specifications

Operating System	Microsoft Windows Embedded Handheld 6.5
Development Environment	Honeywell SDK for Windows Embedded Handheld 6.5
Application Software	Honeywell Power Tools and Demos
Processor	TI OMAP3715 800MHz
Memory	512 MB RAM X 512 MB Flash
Expansion Memory	User accessible Micro SD memory card slot with SDIO support. Please check current price guide for available qualified card options.
Display	240x320. 262.144 Color Transmissive TFT
Backlight	LED
Engine	56XX 2D imager engine with laser aimer or N4313-TTL 1D laser engine
Keypad	28-key shifted alpha numeric with backlit keys
Voice communication	Voice-over-IP and Push-to-Talk ready
Audio	Built-in microphone and speaker, stereo headset jack
Communication Interface	High-speed USB 2.0 (480 Mbps) from cradle (or I/O cable); RS232 (115 Kbps) from cradle.
Battery	2200mAh - Li-ion battery 3.7V 3300mAh - Li-Ion battery 3.7V (includes extended battery door)
Expected Hours of Operation	2200mAh battery pack: 10 hours (with scan every 2 seconds) Battery life varies with application and use case.
Charging	5V/2A input through bottom access or USB/Serial connector
Expected Charge Time	2200mAh / 8.1Wh - 6 hours for a fully depleted battery 3300mAh / 12.2Wh - 9 hours for a fully depleted battery
Charging Peripherals	AC wall adapter and Charger (KSAS0100500200D5)/Communication Cable HomeBase—single-bay terminal charge/communicate eBase—single-bay terminal charge/communicate (via Ethernet connection) Quad Charger—four-slot battery pack charger (DSA-0421S-03 1)
WPAN	Bluetooth Class II (10 m) v2.1 Enhanced Data Rate (EDR) with on-board antenna. BQB certified
WLAN	Dual Mode 802.11a/b/g/n (11 Mbps/54 Mbps) with internal antenna

WLAN Security	OPEN, WEP, 802.1x, WPA-PSK/EAP, WPA2-PSK/EAP, EAP-LEAP, EAP-TLS, EAP-TTLS, EAP-PEAP, EAP-FAST, CCKM
Operating Temperature	14° to 122°F (-10° to 50°C)
Charging Temperature	32° to 113°F (0° to 45°C)
Storage Temperature	-4° to 158°F (-20° to 70°C)
Humidity	95% humidity, non-condensing
Construction	High impact resistant PC/ABS housings Magnesium alloy internal chassis with component shock mounts
Drop	4 ft. (1.2m) multiple drops to concrete, all axis, across operating temperature range
Tumble	500 3.3 ft (1.0m) tumbles (1000 drops)
ESD	Air: ± 15k Vdc Direct: ± 8k Vdc
Environmental Sealing	IP54 rating
Dimensions	175 mm long x 66 mm wide x 26.8 mm deep (6.8" x 2.60" x 1.06")
Weight	250 g (8.8 oz) including standard battery pack
Scanner / Decode Capabilities	56XX 2D Imager with Adaptus Technology and Laser Aimer. Decodes all standard 1D, 2D, Postal, and OCR codes. N4313-TTL 1D laser scanner. Decodes all standard 1D codes.
Regulatory and Compliance	Safety: UL60950-1, C-UL 60950, IEC 60825-1:2007, NOM-019, EN60950, CCC EMC: FCC Part 15, Sub Part B, Sub Part C, Sub Part E, ICES-003, RSS 210, EN 55022 (CISPR 22) Class B, EN55024:2010, EN300 328, EN300 440-2, EN301 489-1, EN301 489-17, EN301 893, EN62209-1, EN62209-2, EN62311, SRRRC, AIRB, ANATEL, AS/NZS4268, COFETEL



Using the Keypad

Overview

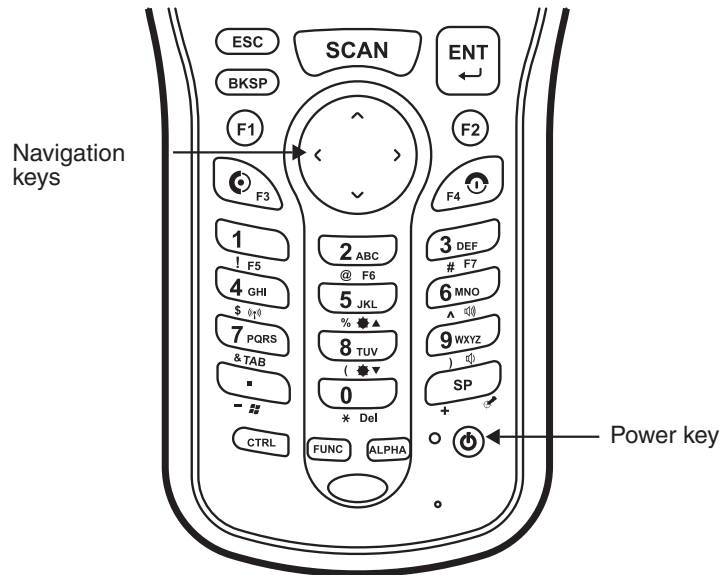

Navigation Keys

Located in the center of the keypad for easy access with either hand, the navigation keys enable you to move the cursor up and down lines and from character to character.

Basic Keys

Name	Function
ALPHA	Toggles the keypad between alpha (upper and lowercase) and numeric modes. The 'A/a/1' indicator on the Title Bar changes accordingly.
Backspace (BKSP)	Backspace moves the cursor back one space each time the key is pressed. If you are typing text, BKSP deletes the previous character each time it is pressed.
Control (CTRL)	Modifies the next key pressed to type specific characters (e.g., pressing CTRL and a "2", types an "@" sign).
Escape (ESC)	Cancels an action.
Enter (ENT)	Confirms data entry.
Power	Suspends/resumes the terminal and performs a soft and hard reset, as well as powering on/off the terminal.

Name	Function
Scan	Activates the scan and “wakes” the terminal from Sleep Mode. Its position allows convenient one-handed image-taking and/or bar code decoding.
Space (SP)	Moves the cursor one space.

Alpha/Numeric Modes

The keypad defaults to numeric mode. Use the **ALPHA** key to toggle between numeric and alpha modes. Pressing the **ALPHA** key locks the keypad in numeric mode, alpha mode (lowercase), or alpha mode (uppercase).

The Title Bar on the screen displays an icon indicating the alpha/numeric status of the keypad.



Alpha Indicators on the Number Keys

Each number key displays the characters typed when you press that key in alpha mode.

Note that when typing in alpha mode on the Dolphin 6110, you must use the same multi-press method you would use when typing letters on some phone keypads. Each key press types the next letter in the sequence as displayed by the alpha indicator.

Function Key Combinations

The Function key (FUNC) modifies the next key pressed to perform specific functions. The keypad is color-coded in blue to indicate these key combinations.

*Note: The color-coded indicators are located **below** each key.*

Key Combination	Function
FUNC + 1	F5
FUNC + 2	F6
FUNC + 3	F7
FUNC + 4	Toggle the wireless radio on and off
FUNC + 5	Increase screen brightness
FUNC + 6	Increase volume
FUNC + 7	Tab

Key Combination	Function
FUNC + 8	Decrease screen brightness
FUNC + 9	Decrease volume
FUNC + .	Start menu
FUNC + 0	Delete
FUNC + SP	Align the screen (Press ESC to exit)

CTRL Key Combinations

The Control key (CTRL) modifies the next key pressed to type specific characters. The keypad is color-coded in yellow to indicate these key combinations.

*Note: The color-coded indicators are located **below** each key.*

Key Combination	Function
CTRL + 1	!
CTRL + 2	@
CTRL + 3	#
CTRL + 4	\$
CTRL + 5	%
CTRL + 6	^
CTRL + 7	&
CTRL + 8	(
CTRL + 9)
CTRL + .	- (minus)
CTRL + 0	*
CTRL + SP	+ (plus)

Program Buttons

Buttons can be programmed to execute different functions using the Program Button program in the Control Panel. The following buttons are programmed for the listed function.

Key Combination	Function
F1	Calendar
F2	Contacts

Key Combination	Function
F3	User programmable
F4	User programmable

Using the Image Engine

Overview

The Dolphin 6110 houses a compact image engine using Adaptus™ Imaging Technology that instantly reads popular 1D and 2D bar codes and supports omni-directional aiming and decoding for greater flexibility in real-world settings. The image engine can also capture digital images, such as signatures and pictures of damaged inventory.

Available Image Engines

The Dolphin 6110 can be equipped with a 56XX image engine (depending on the configuration purchased).

Depth of Field

56XX Image Engine

	8.3 mil Linear	10 mil PDF417	13 mil UPC	15 mil Data Matrix	15 mil QR	35 mil MaxiCode
Working Range*:	(.020cm)	(.025cm)	(.033cm)	(.038cm)	(.038cm)	(.089cm)
Near	3.5 in. (8.9cm)	3.1 in. (7.9cm)	2.1 in. (5.3cm)	2.3 in. (5.8cm)	3.1 in. (7.9cm)	2.0 in. (5.1cm)
Far	7.6 in. (19.3cm)	9 in. (22.9cm)	13.2 in. (33.5cm)	10.2 in. (25.9cm)	8.8 in. (22.4cm)	13.0 in. (33cm)

*Data characterized at 23°C (73°F) and 0 lux ambient light.

Supported Bar Code Symbologies

Symbology Type	Symbology Name
1D Symbologies	Codabar Code 3 of 9 Code 11 Code 32 Pharmaceutical (PARAF) Code 93 Code 128 EAN with Add-On EAN with Extended Coupon Code EAN-13 GS1 Databar Interleaved 2 of 5 Matrix 2 of 5 Plessey PosiCode Straight 2 of 5 IATA Straight 2 of 5 Industrial Telepen Trioptic Code GS1-128 UPC and UPC-A
2D Symbologies	Aztec Code 16K Composite Data Matrix Grid Matrix GS1 Databar Han Xin MaxiCode OCR PDF417 QR Code
Composite Codes	Aztec Mesa Codablock F EAN-UCC GS1 Databar-14
OCR	OCR-A OCR-B OCR-US Money Font
Postal Codes	Postnet and most international 4 state codes Australian Post British Post Canadian Post China Post Japanese Post KIX (Netherlands) Post Korea Post Planet Code

Activating the Engine

When a scanning application is open, press the **Scan** key to activate the image engine.

Using Demos

Dolphin Demos are software utilities loaded on Dolphin terminals that demonstrate the advanced features of the terminal. There are two Demos that feature the image engine: Image Demo and Scan Demo.

To access these demos, tap  > **Demos**.

- Select **Scan Demo** to verify decoding, or
- Select **Image Demo** to verify imaging (not available on device using the N4313-TTL laser engine).

Capturing Images (56XX Engine only)

The image-capture process is an intuitive, split-second operation for experienced users. By following basic guidelines, new users can easily develop their own technique and, with practice, quickly learn to adapt to different application environments.

Image Preview

When the imaging process is initiated, the touch screen displays a preview of the object. This is a live video image of what the imager is currently viewing. The live video image has a slightly degraded appearance compared to the captured image. This is normal.

File Formats



File formats supported for image storage include Bitmap (BMP), JPEG (JPG) and Portable Network Graphics (PNG). The default file format for images is a grayscale BMP.

Compression

Digital images have a maximum image size of 640 x 480 pixels and may have up to a 256 grayscale image definition. The image quality and related file size are determined by the data compression method used by the software application used to take images. The average size of the image file is approximately 4-8K. However, the size of the image depends on the content of the image - the more complex the content, the larger the file size.

Taking an Image

The following steps are basic guidelines for taking images:

1. Tap  > **Demos**  > **Imaging Demo** .
2. Point the Dolphin terminal at the object.
3. Press the **Scan** key to activate the engine. The touch screen displays a preview of the object.
4. Adjust the terminal's position until the preview on the screen is as you want it to appear in the image.
5. Hold the terminal still and release the Scan key.
The touch screen flashes, and the captured image appears on the screen.
6. To save the image, select **File > Save**. By default, the image is saved to the My Documents folder in My Device. To save the image to another location, tap **File > Save As**.

Uploading Images

Image files can be uploaded to a host workstation via Microsoft ActiveSync and a Dolphin communication peripheral or your wireless radio connection. Refer to the [Communication](#) or [Working with the Bluetooth Radio](#) chapters.

Note: You can download the most current version of ActiveSync from www.microsoft.com.

Using the Laser Engine

Overview

The Dolphin 6110 (N4313-TTL laser version) contains a laser diode that emits a beam toward an oscillating mirror that scans through the code and the reflected light is bounced off of two mirrors back to the collector. The 6110 Laser reads all popular 1D bar codes.

Available Laser Engines

The Dolphin 6110 can be equipped with an N4313-TTL laser engine (depending on the configuration purchased).

Depth of Field - N4313-TTL

	5.2 mil	7.5 mil	10.4 mil	13.0 mil	19.5 mil
Working Range*:	(25mm)	(114mm)	(160mm)	(204mm)	(225mm)
Near	2.75 in. (70mm)	2.25 in. (57mm)	2.00 in. (50mm)	2.00in. (50mm)	2.95 in. (75mm)
Far	3.75 in. (95mm)	6.75 in. (171mm)	8.25 in. (210mm)	10.00 in. (254mm)	11.81 in. (300mm)

*Data characterized at 25°C (77°F) under typical indoor lighting.

Supported Bar Code Symbologies

Symbology Type	Symbology Name
1D Symbologies	China Post Codabar Code 11 Code 32 Pharmaceutical (PARAF) Code 39 Code 93/93i EAN-8 EAN-13 GS1-128 GS1 Databar Interleaved 2 of 5 ISBT 128 Korea Post Matrix 2 of 5 MSI PosiCode Straight 2 of 5 IATA Straight 2 of 5 Industrial Telepen Trioptic Code UPC-A, UPC-E0, UPC-E1

Activating the Engine

When a scanning application is open, press the **Scan** key to activate the laser engine.

Using Demos

Dolphin Demos are software utilities loaded on Dolphin terminals that demonstrate the advanced features of the terminal.

Decoding a Bar Code

1. Tap  > **Demos** > **Scan Demo**.
2. Position the Dolphin terminal over one of the sample bar code below.
A range of 4-10 inches (10-25 cm) from the bar code is recommended.
3. Project the aiming beam by pressing and holding the **Scan** key. The Scan LED lights red.
4. Center the aimer beam horizontally over the bar code and highlight all of the vertical bars of the bar code. The aiming pattern is smaller when the terminal is held closer to the code and larger when the terminal is held farther from the code. Symbologies with smaller bars or elements (mil size) should be read closer to the unit whereas larger bars or elements (mil size) should be read farther from the unit.
5. When the bar code is successfully decoded, the decode LED lights green and the terminal beeps.

Sample Bar Code

You can use the following bar code to verify decoding:

Sample 128



Scanning Positions

The aiming beam must be aimed across the entire bar code to provide the best scanning performance.









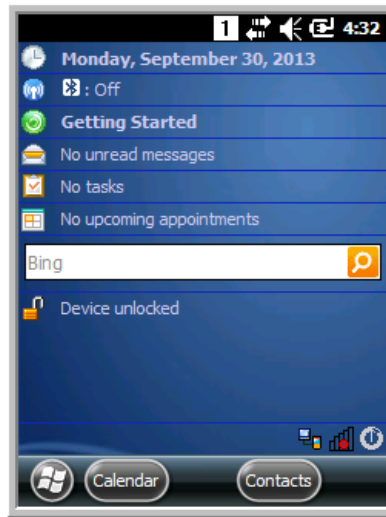

System Settings

Overview

Customized settings are available on the System Settings menu. Tap  > **Settings** and the settings screen opens.



Icon		Description
Bluetooth		Configure the Bluetooth radio. See Enabling the Bluetooth Radio on page 9-1.
Clock & Alarms		Set the system clock, date, time and schedule alarms. See Clock & Alarms on page 7-2.
Lock		Password protect the terminal to limit access to the terminal.
Sounds & Notifications		Set the sound volume, enable or disable sounds for specific actions, set sound parameters for system notifications.
Home		Customize the look and the information displayed on the Home screen.
Connections		Establish network connections settings. See Connecting the Dolphin 6110-USB Communication Cable on page 8-1.
Personal		Customize buttons, and set SIP options. See Personal Menu on page 7-3.

Icon		Description
System		Adjust system settings. See System Menu on page 7-8.

Clock & Alarms

The Clock & Alarms settings can be accessed from the Home screen or the Settings Menu.

1. On the Home screen, tap the line that displays the time and date

OR

Tap  > **Settings** > **Clock & Alarms**,

The Clock Settings screen appears. This setting sets the system clock. All scheduled items run according to this setting.

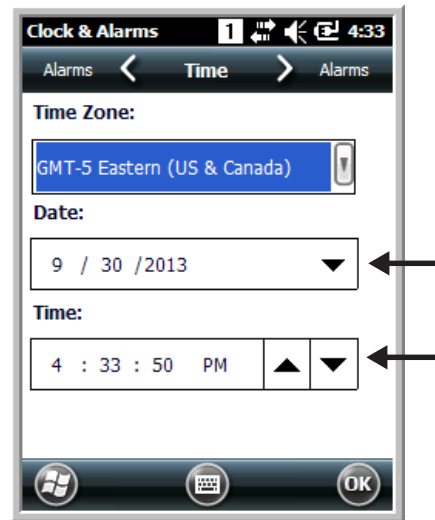

2. Tap the arrow to the right of the time zone to open the drop down menu. Select the appropriate time zone from the menu. Set the correct time and date in the remaining fields and tap **OK** to save.



Personal Menu

To access the Personal Menu, tap  > **Settings** > **Personal**. The screen opens displaying the Personal Menu.



Icon		Description
Buttons		Program Function keys 1-4 to perform specific tasks. See Buttons on page 7-3.
Owner Information		Enter your contact information (e.g., name, company, address, telephone number and E-mail address).
Program Buttons		Program various keypad keys and Function keys 5 through 11 to launch applications or execute commands. See Program Buttons on page 7-5.

Buttons

The Buttons setting programs certain Function buttons to launch applications or execute commands.

Changing Button Assignments

1. Tap  > **Settings** > **Personal**  > **Buttons** .

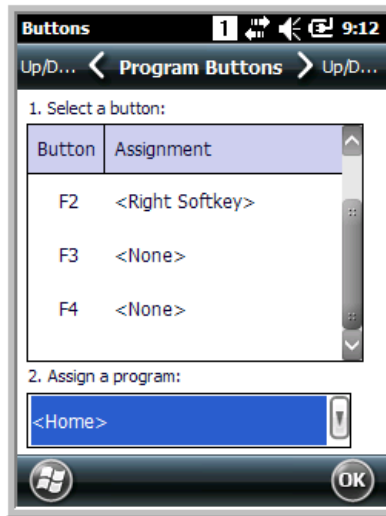

Note: The buttons that appear on this window are the only buttons that can be programmed via the Buttons setting. You cannot add buttons to this window.

2. To change Function key assignment, tap on the name of the button in the **Button** column, and then select a program or command in the **Assign a program** drop down list.
3. Tap **OK** to save.
4. Press the button to verify that the program is launched or action performed.

Available Applications

The **Assign a program** list contains the applications installed on the terminal. If there is a program installed that you would like to see in this list, paste a Shortcut to the program in the `\\Windows\Start Menu\Programs` folder. For instructions about creating shortcuts, see [Using File Explorer](#) on page 7-6.

Additional Functions

The **Assign a program** list also contains the following commands and Microsoft programs:

Command	Description
<Context Menu>	Performs the same function as tap-and-hold to open the context menu for the control.
<Home>	Opens the Home screen.
<Input Panel>	Opens the soft input panel.
<Left Softkey>	Opens the menu or performs the action displayed on the left side of the Command bar.
<None>	Nothing happens when the button is pressed.
<OK/Close>	Performs the same function as tapping OK on the screen.

Command	Description
<Right Softkey>	Opens the menu or performs the action displayed on the right side of the Command bar.
<Rotate Screen>	Changes the screen orientation from portrait to landscape.
<Scroll Down>	Scrolls down in the open application.
<Scroll Left>	Scrolls left in the open application.
<Scroll Right>	Scrolls right in the open application.
<Scroll Up>	Scrolls up in the open application.
<Start Menu>	Opens the Start menu.

Program Buttons

The **Program Buttons** setting programs various keypad keys and Functions keys 5 through 11 to launch applications or execute commands.

Programming Buttons

1. Tap  > **Settings** > **Personal**  > **Program Buttons** .

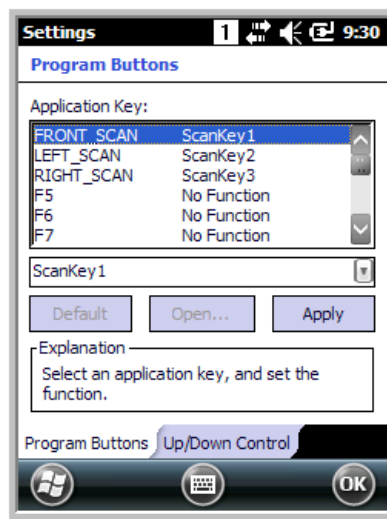

Note: The buttons that appear on this window are the only buttons that can be programmed via the Buttons setting. You cannot add buttons to this window.

To change a key assignment, tap on the name of the application key, and then select the function. If you select the Application option, select **Open** to select the application (e.g., ActiveSync) to assign to the key.

Using File Explorer

If you do not see the program listed, you can either use File Explorer to move the program or ActiveSync on the workstation to create a shortcut to the program and place the shortcut in the Start Menu folder.

Note: We recommend that you Copy and Paste Shortcut so that you do not alter your program configurations by accident. Using Copy and Paste Shortcut (as opposed to Cut and Paste) ensures that the program files remain where they need to be for the system to find them to perform system functions.

1. Tap  > **File Explorer** , and navigate to the program (**My Device > Program Files**).

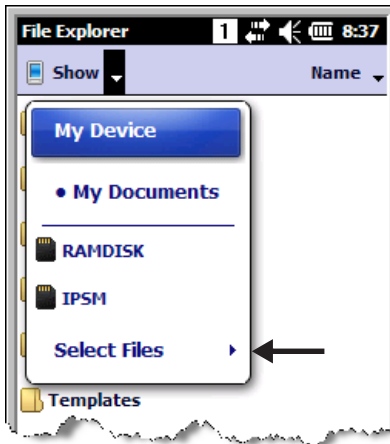

2. Tap and hold on the program, then tap **Copy** on the pop-up menu.
3. Navigate to the Windows folder and open the Start Menu (**My Device > Windows > Start Menu > Programs**), tap and hold a blank area of the window, and tap **Paste Shortcut** on the pop-up menu.

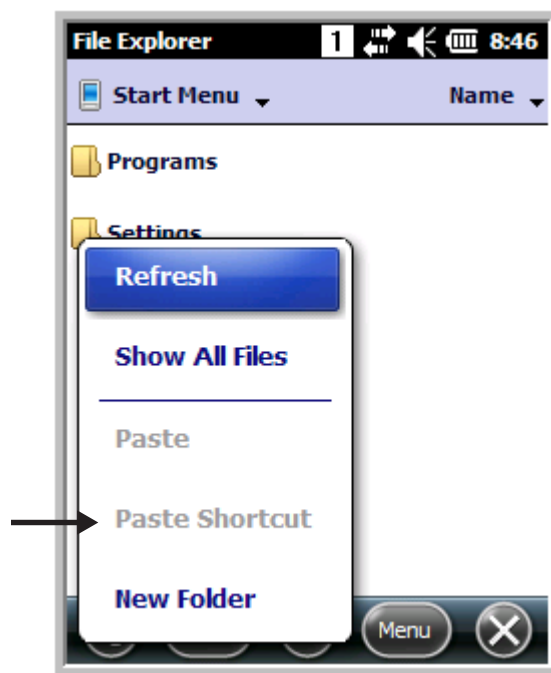

Note: If there is no blank space available in the window, tap on **Menu > Edit > Paste Shortcut**.

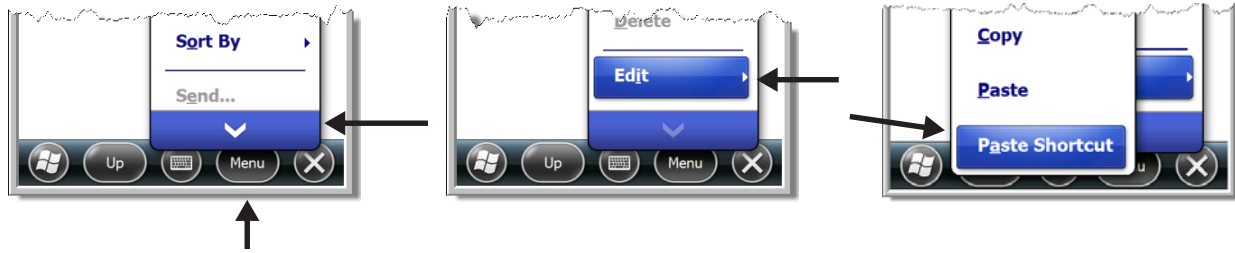

4. Tap  to verify that the program now appears on the Start menu.

Using ActiveSync on the Workstation







Here, you are performing the same basic process as on the terminal, except that you are using the Explore utility (Windows Explorer) to copy and paste the shortcut.







1. Open **ActiveSync > Explore** and navigate to the program.
2. Right-click on the program and select **Create Shortcut**.
3. Select the shortcut, right-click, and select **Cut**.
4. Navigate to the **Start Menu** folder (**Windows > Start Menu > Programs**).
5. Right-click on an empty area and select **Paste Shortcut**.
6. On the terminal, tap the **Start** menu.
7. Verify that program appears.

System Menu

The System menu enables you to verify and sometimes alter system parameters. To access the System menu, go to  > **Settings** > **System**. Tap the appropriate icon to open that system setting.



Icon		See Page
About		See About on page 7-9.
Backlight		See Backlight on page 7-9.
Power		See Power on page 7-14.
Certificates		See Certificates on page 7-10.
Encryption		See Encryption on page 7-11.
HSM SystemInfo		See HSM SystemInfo on page 7-11.
Error Reporting		See Error Reporting on page 7-12.

Icon		See Page
Managed Programs		See Managed Programs on page 7-12.
Memory		See Memory on page 7-12.
Regional Settings		See Regional Settings on page 7-16.
Remove Programs		See Remove Programs on page 7-16.
Screen		See Screen on page 7-18.
SIP Config		See SIP Configuration on page 7-19.
Task Manager		See Task Manager on page 7-20.

About

The **About** system setting displays specific information about the terminal. It contains three screens:

Version Screen Displays the information about the operating system, memory, and processor.

Device ID Screen Displays the information the terminal uses to identify itself to other devices. It can be important to know this information if the Dolphin terminal is going to be part of a networked system of devices.

Device name: Displays the system's default name. (This is the name used by ActiveSync.)

Description: Displays the description of the device ID.

Copyrights Screen Displays important copyright information.

Backlight

The Backlight system setting enables you to customize backlight functionality for the display. The backlight for the color display is user-defined. The Backlight system setting screen contains three tabs: Dim Backlight, Brightness, Keypad Backlight.

Tap  > **Settings** > **System** > **Backlight**.



The **Dim Backlight** tab determines the backlight timeout when the terminal is running on battery/external/USB power.

The **Brightness** tab determines the backlight brightness. The default is 5.

The **Keypad Backlight** tab determines the if the backlight is on with the display or off.

Certificates

Certificates shows you the certificates that are recognized by the operating system. It contains three screens.

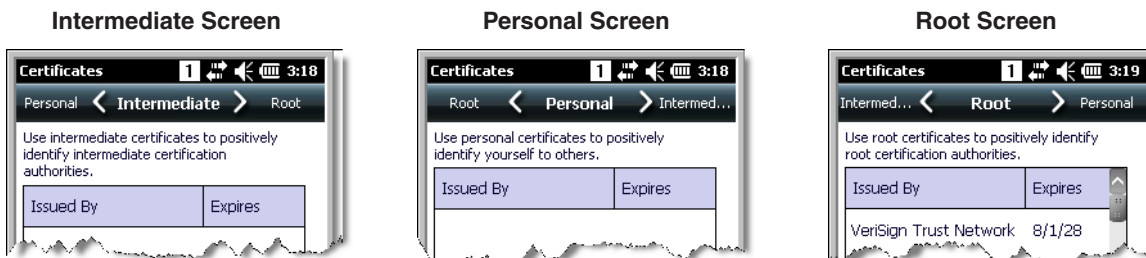

Encryption





Encryption gives you the option of encrypting files placed on storage cards so that those files cannot be read by any other device.



HSM SystemInfo

The HSM SysInfo screen provides important system information including firmware versions, DLL versions, system parameters, as well as network and radio information. HSM SysInfo screen contains six tabs: **System**, **HW**, **SW**, **Radio**, **EXE** and **DLL**.

To output the system information to a text file:

1. Tap  > **Settings**  > **System**  > **HSM SystemInfo** .
2. Tap **Save** on the tile bar.
3. A text file containing the collected system information is created and saved to **IPSM/SysInfo.txt**.

To upload SysInfo.txt file to a Workstation via ActiveSync:

1. Connect the Dolphin terminal to the workstation using a Dolphin communication peripheral.
2. Open Windows Explorer on the workstation.
3. Navigate to the **Mobile Device** folder.
4. Double click **My Windows Mobile-Based Device** and navigate to the **IPSM** folder.
5. Copy the **SysInfo.txt** file to your workstation.

Error Reporting

Error Reporting gives you the option of enabling or disabling the error reporting function of Windows Embedded Handheld 6.5.

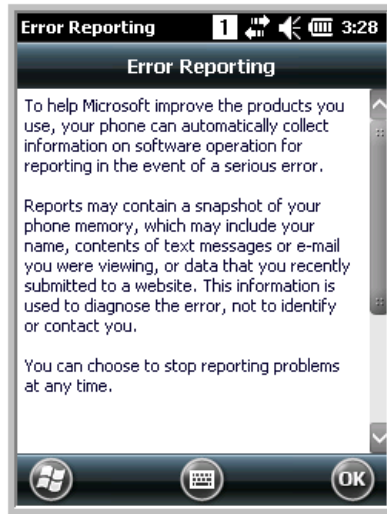

Managed Programs

Managed Programs are a list of programs that are managed if enrolled to enterprise domain. Managed Programs is the client-side that works with the server product System Center Mobile Device Manager (MDM). MDM consists of MDM Gateway Server and one or more computers that run MDM Device Management Server; MDM Enrollment Server; and Microsoft SQL Server® 2005 databases.

It lets system administrators:

- provide an authenticated connection to LOB applications, managed Group Policy, and application packages.
- use Group Policy and software packages to manage the enrolled Windows phones (enforce policy, wipe devices, etc.).
- manage the requests for and retrieving of certificates for devices and for creating the Active Directory® Domain Service objects that represent these devices. By using these objects, you can manage the devices as if they were members of a domain.

Memory

The Memory applet shows the capacity and usage of the Storage and Program portions of the Flash file system. The Storage portion includes the IPSM folder, which can be detailed under the Storage Card tab. When the Program portion becomes too full, you can use the Task Manager to remove any unnecessary tasks.

Main Screen

The Main screen displays the usage statistics of the flash memory.

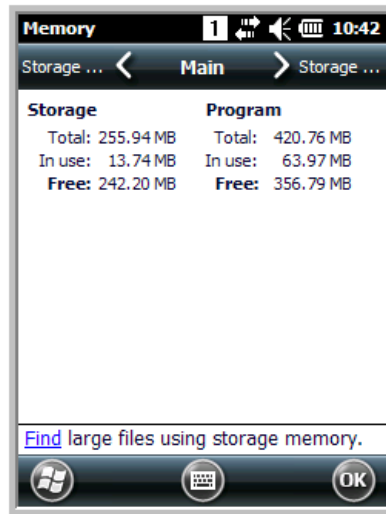

Storage Card Screen

The **Storage Card** screen displays the current capacity and usage statistics of the selected memory type: RAMDISK, IPSM, or Storage Card. Select the memory type from the drop-down list. RAMDISK is selected by default.

- **IPSM** (Internal Persistent Storage Manager)
Data or programs stored in the IPSM are not affected when the operating system is upgraded. Autoinstall programs, for example, are stored in \\IPSM\Honeywell\Autoinstall so that they are always installed after an operating system upgrade or factory reset. Contact a Honeywell technical support representative for more information on how to perform a factory reset. For contact information, see [Technical Assistance](#) on page 14-1.
- **RAMDISK**, is a virtual disk that resides in RAM, volatile memory. The virtual disk provides faster access speed than the ISPM or other system folders. RAMDISK is volatile and is cleared when a reset (i.e., soft, hard or factory) is performed or power is lost.

- **Storage Card**

You can install one memory card in Dolphin terminals (see [Right Side Panel Features](#) on page 3-6). If a storage card is installed in the terminal, you can select it in the drop-down list and see capacity and usage statistics for the card.

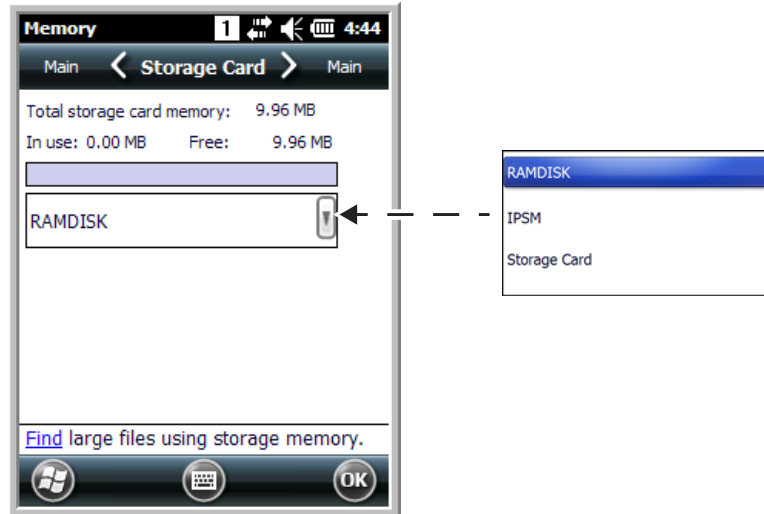

Power

Power system settings contains four tabs: Battery, Advanced, Wakeup Source, and BatteryLog Source.

Tap > **Settings** > **System** > **Power**.

Battery Tab

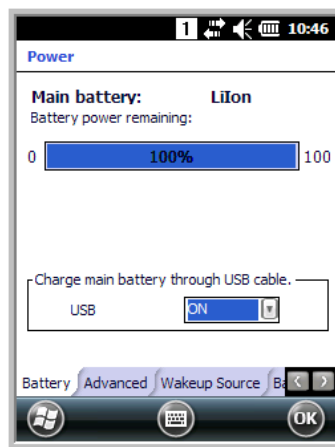

The battery tab displays the power level status of the battery. You may also turn on/off the capability to charge the battery using the USB cable.

Advanced Tab

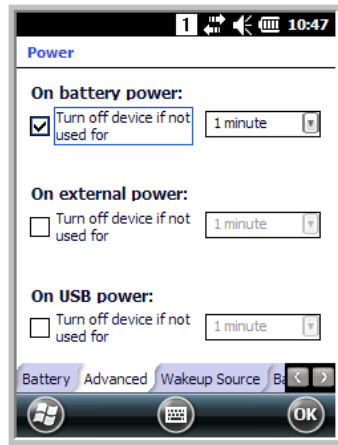

Determines power time-outs.

For **On battery power**, select from the drop-down list, the number of minutes of inactivity you want to pass before the terminal powers off when running on battery power.

For **On external power**, select from the drop-down list, the number of minutes of inactivity you want to pass before the terminal powers off when running on external power.

For **On USB power**, select from the drop-down list, the number of minutes of inactivity you want to pass before the terminal powers off when running on USB power.

Wakeup Source Tab

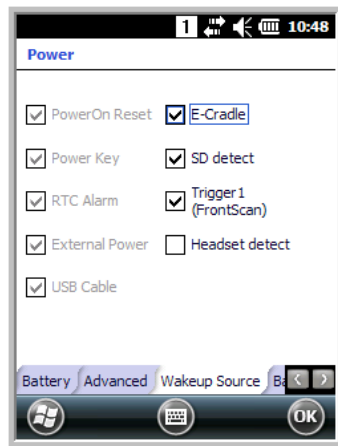

Determines when the terminal wakes up. You may select the incidences when the terminal wakes by checking the appropriate box.

Battery Log Source Tab

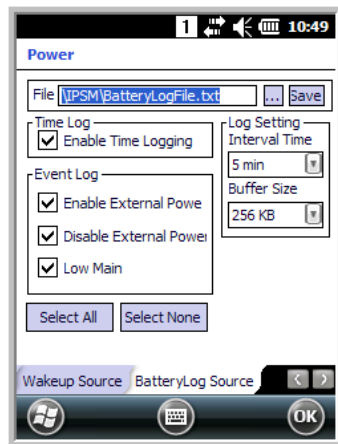

Allows you to configure the BatteryLogFile.

Note: When the terminal "powers off", it enters *Suspend Mode* (see page 2-9).

Regional Settings

Regional Settings enables you to customize the appearance and formatting to your geographic region. Specifically, you can customize numbers (i.e., number of decimal places allowed), currency (i.e., using the \$ or € symbol), time, and date. These specifications apply to all screens, including the Home screen. The Region tab displays an overview of the region selected in the drop-down list at the top.

The terminal is loaded with a number of pre-programmed regional settings. Select one from the list and the results appear on the screen. To see specific settings or to change a specific setting, tap on one of the tabs, make the change, and tap **OK** to save it.

Remove Programs

Remove Programs enables you to remove programs installed on the terminal. If a program is manually removed using the **Remove Programs** application, the program does not re-install on a hard or soft reset.

Note: A program (file) does not automatically install if it is added to the \\Honeywell\\Autoinstall folder on the storage card and a hard or soft reset is performed. Any program stored in the \\IPSM\\Honeywell\\Autoinstall folder on the storage card re-installs after a software upgrade or a factory reset. For information on program installation, see [Installing Additional Software](#) on page 8-12.

For information about the system resets, see [Hardware Maintenance](#) on page 3-10. See Honeywell support for more information on how to perform a factory reset.

1. Tap **Remove Programs**. In the list, select the program you want to remove.

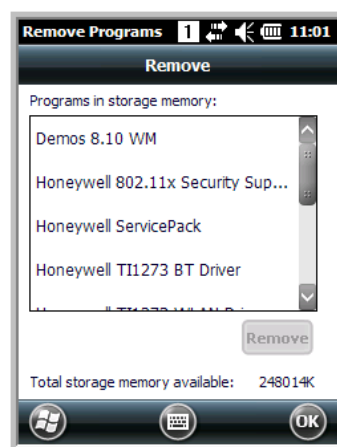

-
2. Tap **Remove**. The following message appears:

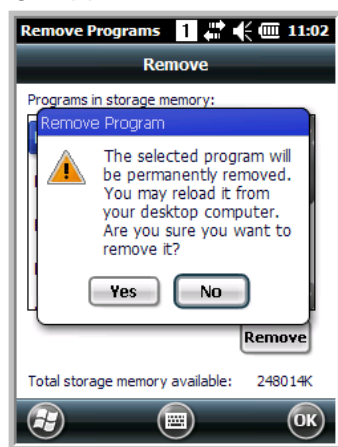

3. Tap **Yes**. Wait while the program is removed.
4. Verify that the program no longer appears in the list.

Screen

The Screen system setting contains three screens: General, Clear Type, and Text Size.

General Screen

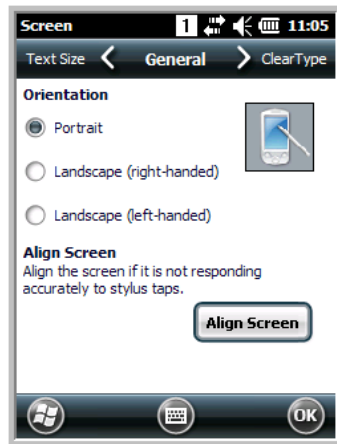

Orientation

The General screen enables you to set the dynamic screen rotation. Three choices of screen orientation are supported: Portrait, Landscape (right-handed), and Landscape (left-handed).

Align Screen

The General Tab also allows you to re-align the screen. You need to re-align the screen if tapping buttons or icons with the stylus no longer seems to work appropriately.

Tapping **Align Screen** brings up the align screen window where you are guided to tap a target several times. This recalibrates how the touch screen receives input.

- Alignment should always be performed with a stylus designed for touch panel applications. The small point is required for accurate calibration.
- Press the stylus firmly into the center of the cross-hair target once and release. Do not “double-tap” the target.

ClearType Screen

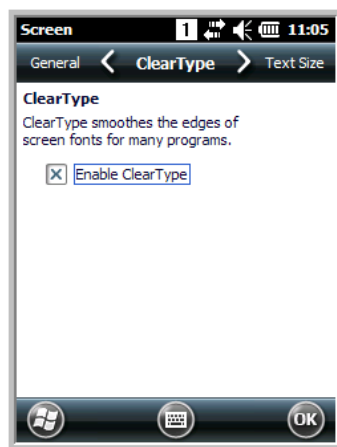

The display supports ClearType font rendering, which is a Microsoft technology that dramatically increases the readability of text on LCD displays.

ClearType font is enabled by default.

For more information about ClearType font rendering, visit: www.microsoft.com/typography/WhatIsClearType.mspx.

Text Size Screen

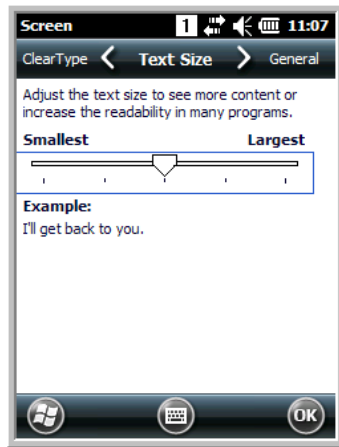

The Text Size screen enables you to perform font scaling within certain views of the:





- Home screen,
- Contacts,
- Calendar,
- Messaging, and
- Tasks.

Font scaling means that you can increase or decrease the point size of the font on application windows.

To change the font size, move the slider toward **Smallest** or **Largest**. The Example text changes to reflect the font change. Tap **OK** to save the new font size setting.

SIP Configuration

The SIP Config settings screen enables you to configure Session Initiation Protocol (SIP) for Voice Over IP (VOIP) and Telephony communication.

To access the SIP Config screens, tap Tap  > **Settings**  > **System**  > **SIP Config** .

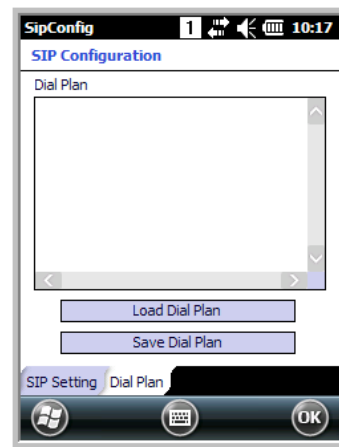
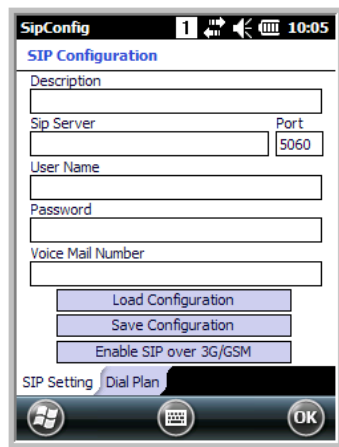

Task Manager

The Task Manager provides information about applications and processes running on your mobile computer. You can use the Task Manager to monitor the memory and CPU usage of specific applications and processes. Check the Task Manager when you are receiving out of memory errors or when the mobile computer is running slowly.

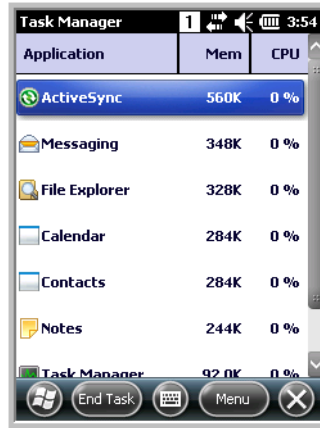

Using the Task Manager

Applications

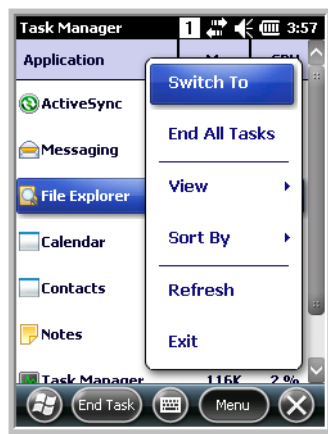

To view the status of the programs running on your mobile computer, tap the **Menu** button at the bottom of the screen, then tap **View > Applications**.

From the application list, you can:

- Tap and hold on an application, then tap **Switch To** on the pop-up menu.
- Tap and hold on an application, then tap **End Task** or **End All Tasks** on the pop-up menu.

Note: Anytime you stop a running program, it frees up memory. To free up memory, return to the running program, save your data, and close the application.

Processes

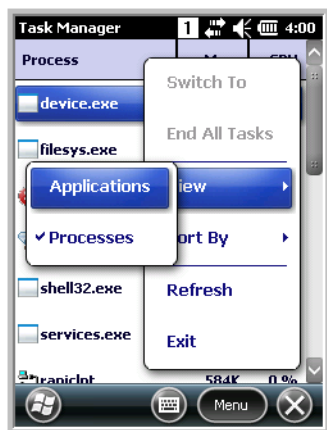

To view information about the processes running on the mobile computer, tap the **Menu** button at the bottom of the screen, then tap **View > Processes**.



Communication

Connecting the Dolphin 6110-USB Communication Cable

To facilitate USB communication between the Dolphin terminal and the host workstation, you may connect your unit to a host by using either the optional Dolphin 6110-USB Communication Cable or HomeBase. If you use the Communication Cable, slide the cable unit onto the bottom of the terminal lining up the terminal's I/O connector with the cable unit's connector.

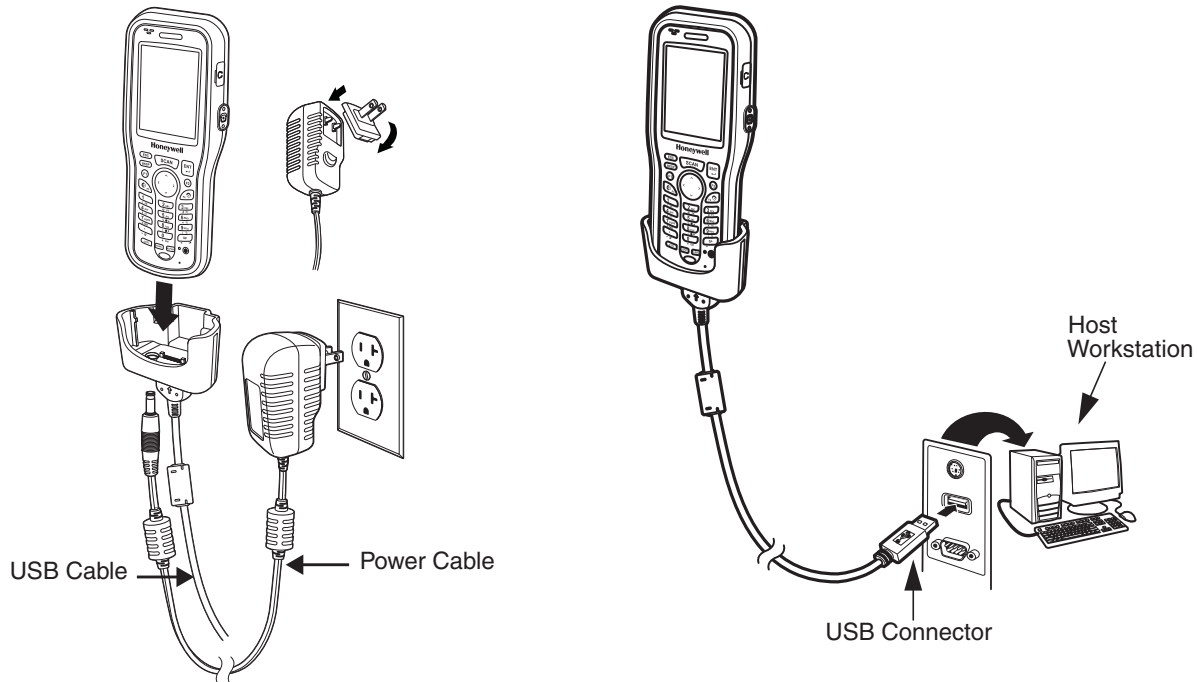

Charging Terminal with USB Cable

Not only can you communicate between the terminal and the host using the Dolphin Charging/Communication cable, but you can also trickle charge the terminal. The preferred charging method, however, is using the supplied power cord and plugging the unit into the wall. To charge the battery using the USB cable:

1. Disconnect the cable and select  > **Settings** > **System** > **Power**. The default setting is On.

-
2. If you do not disconnect the cable, the option will be grayed out.

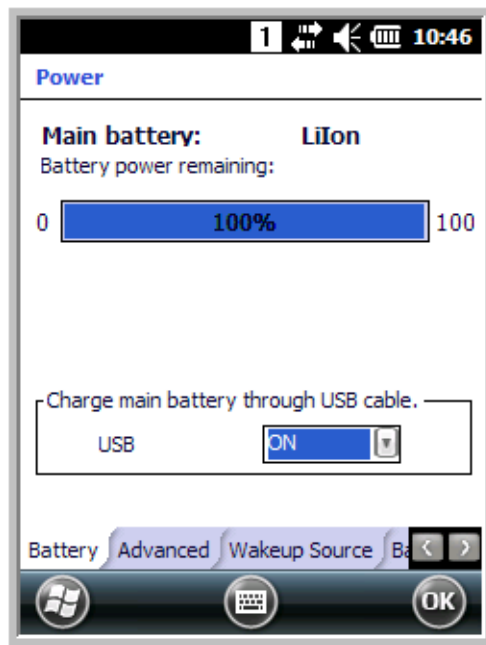

3. Re-connect the cable.

Connections Menu

The Connections system setting provides access to the terminal's various wireless communication options.

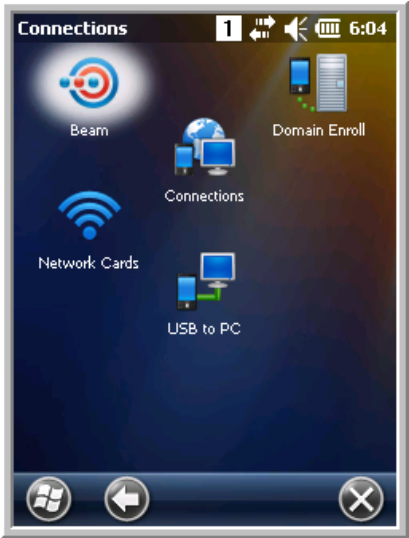

Icon		Tapping this icon...
Beam		Enables infrared communications. See Receiving Data on page 8-3.
Connections		Opens Microsoft's connections manager. See Receiving Data on page 8-3.
Domain Enroll		Opens the Enrollment screen for connecting your phone with company resources. <i>Note: System administrator password is required for domain enrollment.</i>
USB to PC		Enables advanced wired USB to PC communication via sync software. See Connecting and Synchronizing the Terminal and Workstation on page 8-9.
Network Cards		Manage Network card settings.

Note: All server-assigned IP addresses use Dynamic Host Configuration Protocol (DHCP).

Receiving Data

The Beam Setting must be set to receive all incoming beams from other infrared devices.

-
1. Verify that beam settings are set to receive. Tap  > **Settings** > **Connections** > **Beam** and check the box.

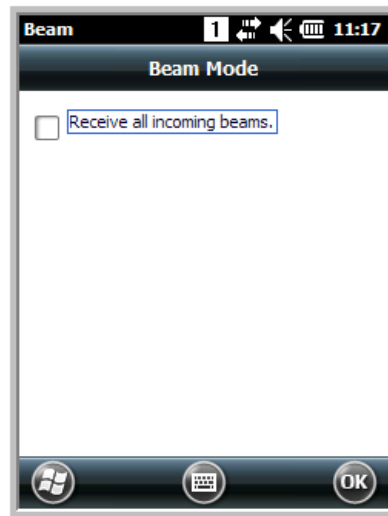

Connections Manager

Microsoft's Connections Manager sets up multiple network connections to Internet Service Providers (ISPs) via external modem.

Do NOT enter connection parameters in the Connections Manager if:

- you are using one of the on-board wireless radios to connect to a network. The Dolphin terminal uses the settings from each radio's configuration utility to connect. The connections manager is used primarily to setup WAN modem dial up connections.
- you are using Wireless Zero Config. By default, WZC is disabled on Dolphin terminals.

To Access the Connections Manager

Tap  > **Settings** > **Connections**  > **Connections** .

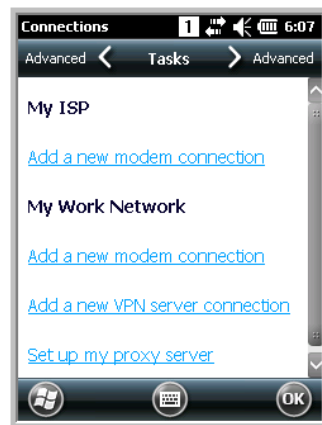

Tasks

The Tasks screen enables you to initially configure, and then manage network settings when using a modem. Select an item in this list and then complete the setup screens that follow with the appropriate information for your network.

My ISP

The links under this heading enables you to add and manage modem connections to an ISP. To complete the setup screens, obtain the following information from your ISP:

- ISP dial-up access telephone number
- Username
- Password
- TCP/IP settings

My Work Network

These links enable you to establish the following connections types:

- Modem
- Virtual Private Network (VPN)
- Proxy server connection

Note: If you are connected to your ISP or private network during synchronization, the terminal should download the proper proxy settings during synchronization with the workstation. If these settings are not on your workstation or need to be changed, ask your ISP or network administrator for the proxy sever name, server type, port, type of Socks protocol used, and your user name and password.

To complete the setup screens, obtain the network parameters from your system administrator.

Modify an Existing Connection

Manage Existing Connections appears on the Connections tab after at least one network connection has been established.

Tap **Manage Existing Connections** on the Horizontal scroll and follow the setup screens.



Advanced

The Advanced screen enables you to select the default network, dialing rules, and IP address exceptions for modem connections.

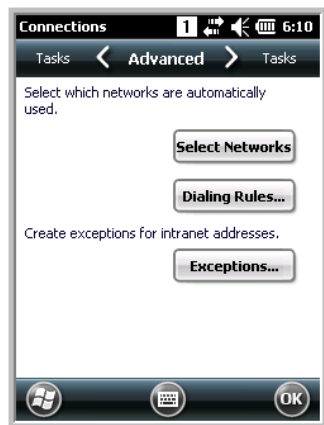

Note: You should not need to change Advanced settings because most ISPs now use DHCP addresses.

Dolphin Wireless Manager

The Dolphin Wireless Manager provides a centralized interface that enables and disables all the on-board radios. Each radio has its own configuration program. The Dolphin Wireless Manager also provides shortcuts to the configuration utilities for each radio.

Tap  on the Home screen to access the **Dolphin Wireless Manager**.

OR

1. Tap once on the Title bar to access the Horizontal Scroll bar.

2. Tap  .

3. Select “Dolphin Wireless Manager.”

Dolphin Wireless Manager Window

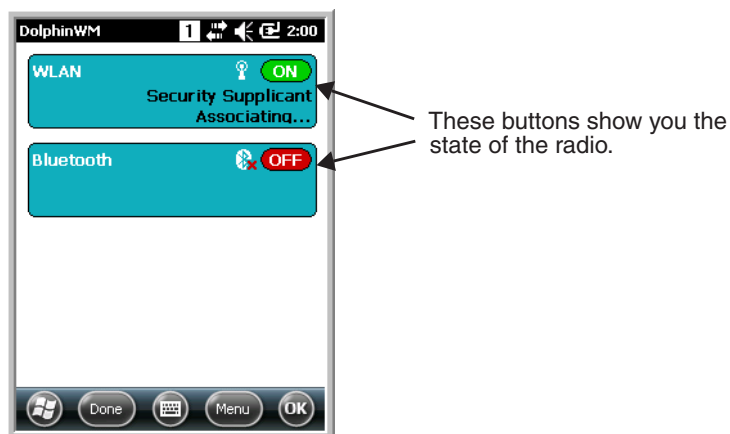

Note: Not all Dolphin models are equipped with the same radio types. Your Dolphin Wireless Manager Window may differ slightly from what is illustrated depending on your Dolphin model.

Enabling the Radios

1. Tap  on the Home screen to access the **Dolphin Wireless Manager**.



2. Tap anywhere inside the rectangle of the radio you want to enable.
3. The radio begins activating.
4. When the radio is activated (i.e., transmitting a signal), the **OFF** button changes to **ON**.

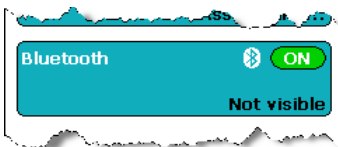

Note: If applicable, information about the radio appears in the rectangle.

Accessing Radio Configuration Utilities

Each radio has its own configuration utility that you can access by tapping **Menu** on the tile bar.



Radio Type	Menu Option
802.11a/b/g/n	Tap WLAN Settings and the Honeywell WLAN Security Supplicant opens. The <i>Honeywell WLAN Security Supplicant User's Guide</i> is available for download from the Dolphin 6110 product page at www.honeywellaidc.com .
Bluetooth	Tap Bluetooth Settings and the Bluetooth Settings open. For details, see Working with the Bluetooth Radio on page 9-1.

Network Cards

The Network Cards screen allows you to set and configure the type of Network Adapter the Network card in the terminal uses. To access this option, Tap  > **Settings** > **Connections** > **Network Cards**. You can modify the adapter settings (e.g., Name Servers or IP address) by tapping on the adapter type or highlighting the adapter and tapping **Edit** at the bottom of the screen.

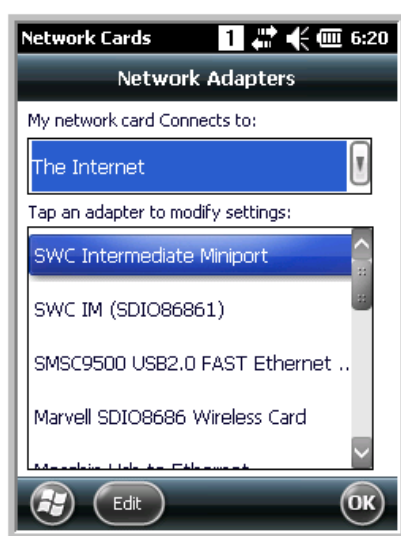

Connecting and Synchronizing the Terminal and Workstation

To synchronize data between the terminal and the workstation, ActiveSync (version 4.5 or higher) or Windows Mobile Device Center must be installed and configured for the appropriate communication type on the host workstation (Windows-based PC) and the Dolphin terminal. Dolphin terminals ship with ActiveSync already installed. Therefore, if ActiveSync is already installed on the host workstation, you just need to connect the Dolphin terminal to the host workstation (via Dolphin peripheral) to initiate communication.

If ActiveSync (4.5 or higher) or Windows Mobile Device Center is not installed on the host workstation, you can download and install the most current version of the software from the [Microsoft Web site](http://go.microsoft.com/fwlink/?LinkId=147001) (<http://go.microsoft.com/fwlink/?LinkId=147001>).

Note: ActiveSync on your Dolphin terminal works with Windows Mobile Device Center on host workstations running Windows Vista or Windows 7 and with ActiveSync on host workstations running Windows XP. For detailed information on ActiveSync and WMDC visit the [Microsoft Windows Phone Web site](#).



When communicating via ActiveSync or Windows Mobile Device Center, your terminal is designed to be connected to the host workstation with a communication peripheral sold/manufactured by Honeywell, such as the charge/communication cable. Use of any peripheral not sold/manufactured by Honeywell may cause damage not covered by the warranty.

Capabilities

- Back up and restore your device data.
- Copy (rather than synchronize) files between your device and workstation.
- Control when synchronization occurs by selecting a synchronization mode. For example, you can synchronize continually while connected to your workstation or only when you choose the synchronize command.
- Select which information types are synchronized, controlling how much data is synchronized. For example, you can choose how many weeks of past appointments you want synchronized.

Communication Type

The Dolphin 6110 supports the following type of communication via ActiveSync through its [DC Power Jack](#) (see page 3-7) on the bottom panel:

USB The USB Communication/Charge cable and hardware peripherals allow the Dolphin terminal to communicate with a workstation through a USB port or to a network through a USB hub. The Dolphin terminal supports High-speed USB communication (USB 2.0). The Dolphin terminal defaults to USB communication out of the box.

Hardware Requirements for Setup

- Dolphin communication peripheral (e.g., HomeBase, eBase, USB Communication/Charge Cable) and power supply.

Software Requirements for Communication

- ActiveSync (v4.5 or higher) or Windows Mobile Device Center installed and configured on the host workstation (PC), see [Setting Up the Host Workstation](#) on page 8-11.

Note: ActiveSync or Windows Mobile Device Center must be setup on your workstation before you initiate synchronization from the terminal for the first time.

- Windows 98 Second Edition, Windows Me, Windows 2000, Windows NT (4.0 SP6 or higher), Windows XP, Windows Vista, and Windows 7 operating systems.

Setting Up the Host Workstation

To synchronize data between the terminal and the workstation, ActiveSync (v4.5 or higher) or Windows Mobile Device Center must be configured for same communication type on both the host workstation and the Dolphin terminal.

ActiveSync

Verify that ActiveSync is configured to use the appropriate communication type.

1. In the ActiveSync window on your workstation, select **File > Connection Settings**.
2. Check the box next to “Allow USB connections”.
3. Select **COM1** from the drop down menu.

Connecting the Dolphin Terminal to the Host Workstation

After setting up both the workstation and the terminal:

1. Connect the Dolphin terminal to the workstation using a Dolphin communication peripheral.
2. ActiveSync or Windows Mobile Device Center should open and connect automatically to the Dolphin terminal.

Synchronizing with the Host Workstation

After setup, synchronization begins automatically whenever the terminal’s mechanical connector connects to a Dolphin peripheral that is connected to a host workstation with ActiveSync or Windows Mobile Device Center installed. For additional information visit the [Microsoft Phone Web site](http://go.microsoft.com/fwlink/?LinkId=147001) (<http://go.microsoft.com/fwlink/?LinkId=147001>).

Exploring the Terminal from the Workstation

ActiveSync

1. Open the main ActiveSync window (on the desktop).
2. Click **Explore**. This opens the Mobile Device folder for the terminal in Windows Explorer.
3. The Dolphin terminal is now treated as a mass storage device, and transferring files is as simple as dragging and dropping or copying and pasting.

Windows Mobile Device Center

1. Open Windows Mobile Device Center (on the desktop).
2. Click **File Management**. This opens the Mobile Device folder for the terminal.
3. The Dolphin terminal is now treated as a mass storage device, and transferring files is as simple as dragging and dropping or copying and pasting.

Installing Additional Software

Dolphin terminals ship with the operating system, radio drivers, and custom Honeywell software already installed. These are the default programs that install when your terminal first boots up. You can install additional software programs to the terminal provided that the following parameters are met:

- The software program was created for a Windows Embedded Handheld 6.5 device.
- The terminal has enough memory to store and run the program.
- The program has an EXE, CAB, or DLL extension.

When selecting programs, verify that the program and version of the program are designed for the Windows Embedded Handheld 6.5 and the terminal's processor. You can verify your processor by tapping

 > **Settings** > **System** > **About** > **Version**. Make a note of the information in the **Processor** field.

To install additional software, you can use the communication options described in this chapter.

- [Adding Programs Using ActiveSync or Windows Mobile Device Center](#) on page 8-12.
- [Adding Programs Using the Internet](#) on page 8-13.

Adding Programs Using ActiveSync or Windows Mobile Device Center

Generally, software for Windows Embedded Handheld devices must be installed to the host workstation first, then transferred to the Dolphin terminal.

Note: An active Microsoft ActiveSync or Windows Mobile Device Center connection between a host workstation and the Dolphin terminal is required to add programs. For additional information, see [Connecting and Synchronizing the Terminal and Workstation](#) on page 8-9.

1. Download the program to the workstation from either the Internet or the install CD. You may see a single *.exe or setup.exe file, a *.cab file, or a *.dll file.

Note: There may be several versions of files for different device types and processors. Select the file that matches the terminal's processor.

2. Read any installation instructions, Read Me files, or documentation that comes with the program. Many programs provide special installation instructions.
3. Connect the terminal to the workstation via a Dolphin communication peripheral.

If the File is an Installer (*.exe or *.setup.exe)

An installer program is one that installs on the workstation and the terminal simultaneously; one process installs to both devices.

1. On the workstation, double-click the *.exe or setup.exe file. The installation wizard begins.
2. Follow the directions on the workstation screen. The installation process includes transferring the software to the Dolphin terminal.

If the File is Not an Installer

Some programs cannot be installed on PCs because they are designed exclusively for Windows Embedded Handheld devices. In these cases, the appropriate files must be stored on the host workstation and transferred to the terminal via ActiveSync Explore or Windows Device Mobile File Management.

Note: You know that the program is not an installer because an error message stating that the program is valid but designed for a different type of computer appears when you try to install the program on the workstation.

1. If you cannot find any installation instructions for the program in the Read Me file or documentation, do one of the following:

-
- a. Open **ActiveSync** and click **Explore**, or
 - b. Open **Windows Mobile Device Center** and click **File Management**
2. On the workstation, navigate to the workstation folder containing the program file(s). Copy and paste the file(s) into the **Program Files** folder on the terminal.
 - If you want the program to be part of the Autoinstall that occurs after a factory reset or software upgrade, paste the program file(s) in both the \\Honeywell\\Autoinstall folder on the storage card and the \\Honeywell\\Autoinstall folder on the device.
Note: Contact a Honeywell technical support representative for information on how to perform a factory reset. See [Technical Assistance](#) on page 13-1. or go to www.honeywellaidc.com.
 3. On the terminal from the  screen, tap **File Explorer**, navigate to the folder where the program is located.
 4. Tap on the program file to start the installation.
 - If you copied the file to the \\Honeywell\\Autoinstall folder, you can perform a Soft Reset (Press the **Reset** button using the stylus) to install the program.

Connecting the Terminal to a Wireless Network

You connect the terminal to a wireless network through the on-board radio (802.11a/b/g/n, Bluetooth). Each radio has its own configuration utility and requires specific information about the wireless network to connect. Successful connection depends on your network infrastructure about which you will need specific information from your network administrator.

WLAN (802.11a/b/g/n)

The Dolphin 6110 has a 2.4 and 5 GHz 802.11a/b/g/n WLAN (Wireless Local Area Network) radio. The radio is interoperable with other 2.4 and 5 GHz 802.11a/b/g/n, Wi-Fi compliant products including access points (APs), workstations via PC card adapters, and other wireless portable devices. By default, the 802.11a/b/g/n radio is disabled after each factory reset. The next step is to configure the connection parameters of the radio to connect to a wireless network.

WLAN Radio

The WLAN radio is configured in the Honeywell WLAN Security Supplicant, which you access by tapping the program icon in the task tray near the bottom of the touch screen. For complete configuration instructions, download the *Honeywell Secure Wireless (SWC) Client User's Guide* from www.honeywellaidc.com. A link to this guide appears on the Dolphin 6110 product page.

Adding Programs Using the Internet

When you have established a network connection, you can access the Internet and download additional software programs.

Note: When selecting programs, verify that the program and version of the program are designed for Windows Embedded Handheld and the terminal's processor. You can verify your processor by tapping

 > **Settings** > **System** > **About** > **Version**. Make a note of the information in the Processor field.

1. Open Internet Explorer and navigate to the program's location. You may see a single *.exe or setup.exe file, or several versions of files for different device types and processors.
2. Select the program version that matches your Dolphin terminal and processor.

-
3. Read any installation instructions, Read Me files, or documentation that comes with the program. Many programs provide special installation instructions.
 4. Download the program to the terminal directly from the Internet. You would normally store the program in the \Program Files folder unless another location is required by the program.
 5. On the terminal, tap the installer file: e.g., *.exe or setup.exe file.
 6. The installation wizard for the program begins.
 7. Follow the directions on the screen to complete the installation.

Software Upgrades

Contact a Honeywell technical support representative for information on available software upgrades for your Dolphin terminal, see [Customer Support](#) on page 14-1. or go to www.honeywellaidc.com.



To prevent data loss, back up all user data to an SD card or external memory device before performing an upgrade.

Note: An active Microsoft ActiveSync or Windows Mobile Device Center connection between a host workstation and the Dolphin terminal may be required for some types of software upgrades. For additional information, see [Connecting and Synchronizing the Terminal and Workstation](#) on page 8-9.

Working with the Bluetooth Radio

Enabling the Bluetooth Radio

You enable the Bluetooth radio in the [Dolphin Wireless Manager](#) (see page 8-7).

1. Tap  on the Home screen to access the **Dolphin Wireless Manager**.

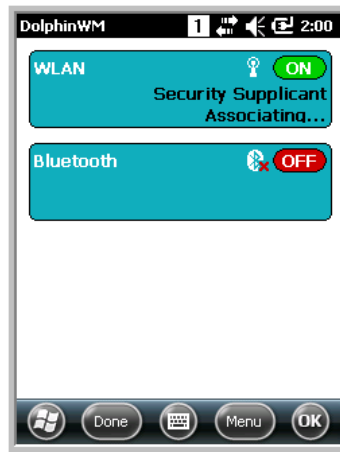

2. Tap anywhere inside the Bluetooth rectangle and Bluetooth begins activating.

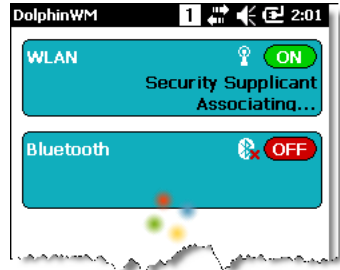

3. When the radio is activated (i.e., transmitting a signal), the **OFF** button changes to **ON**.



Now, the Bluetooth radio is transmitting a signal. Additional text in the Bluetooth section tells information about the Bluetooth radio. “Visible” and “Not visible” indicates whether the Bluetooth radio is discoverable or not discoverable by other Bluetooth devices.

Now, you can connect to other transmitting and discoverable Bluetooth devices (see page 9-2).

To make the terminal discoverable, [see page 9-6](#).

Pairing and Trusted Devices

The terminal does support pairing. Pairing happens during general connection setup. Paired devices are "trusted" devices. This means that there is unrestricted access to all services (including services that require authorization and authentication).

A connection can exclude pairing. A device that is connected to the terminal but not paired with it is considered an untrusted device. Content can still be passed to untrusted devices by requiring authorization with each attempt (for example, with the initialization of a file exchange). The Beam File method of file transfer can be used to pass a file as an untrusted device; see [Transferring Files](#) on page 9-4.

Connecting to Other Bluetooth Devices

To connect to other Bluetooth devices, you need to perform a device discovery, select a discovered device, and then connect to the selected device. Pairing happens as part of the connection process.

1. Make sure the Bluetooth device is in range and set to be discoverable by other Bluetooth devices.
2. In the Dolphin Wireless Manager, tap **Menu > Bluetooth Settings**.

OR

Tap  > **Settings > Bluetooth** .

3. Tap **Add new device**. The terminal begins searching for discoverable Bluetooth devices.

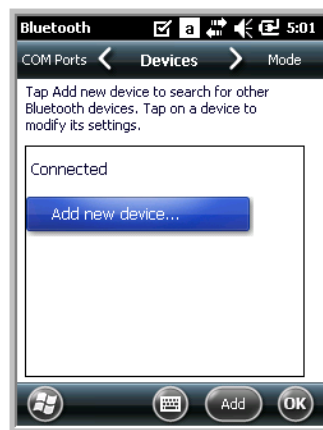

4. Select a device from the list and tap **Next**.

The types of devices in the vicinity of the radio appear in the list of discovered devices.



5. You are prompted to enter a passcode.

- If the device has a specific passcode, enter it in the **Passcode** field and tap **Next**.

When attempting to connect to a printer or headset with Bluetooth capabilities, the passcode may default to either 1111 or 0000. If there is no default, consult the device literature for the number.

- If the device does not have a specific passcode, enter one in the **Passcode** field and tap **Next**.

6. The Bluetooth radio tries to connect with the device.

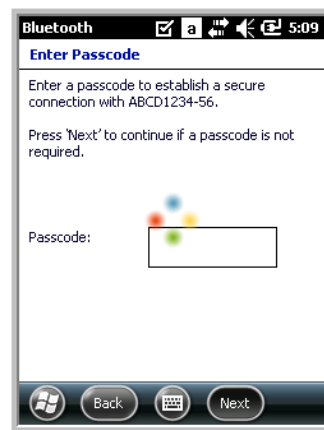

7. If you created a passcode, you will be prompted by the other device to enter the same passcode. Enter the created passcode to establish a paired connection.

If you entered a device specific passcode, you should not have to do anything on the other device.

-
- When the connection is complete, a list of matching and supported services on the device appears. Only the services that are mutually supported on both devices appear in the Partnership Settings window.



- Select the services you want to use and tap **Save**.

The services on the new devices have to be selected or the pairing won't include those services, even though the devices are paired. If services are not selected, you will be continually re-prompted for the passcode from the device.

- The device appears in the list on the main window.

If you are connecting to a printer or headset, complete any additional steps required by the device.

- After the passcodes have been accepted on both sides, you have a trusted (paired) connection.

Transferring Files

- Tap  > **File Explorer**.
- Navigate to the file you want to transfer.
- Tap and hold on the file and select **Beam File** on the popup menu.

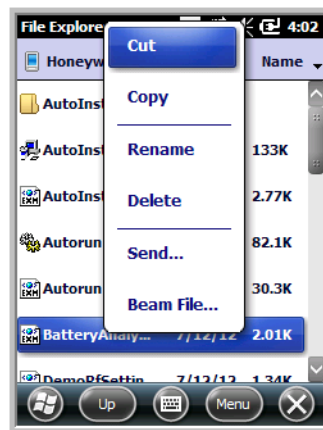

- The Bluetooth radio begins searching for devices.

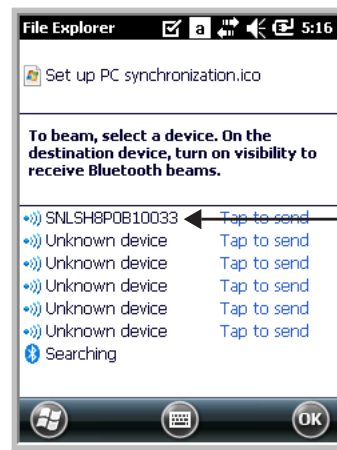

When a Bluetooth device is first found, it appears as an Unknown device; the Bluetooth icon indicates that the device is a Bluetooth device.

As data is retrieved, the device IDs appear in the list.

- Tap the device to begin sending the selected file.
- While trying to connect, the selected device reads "Pending".



- When the file is being transferred, the selected device reads "Sending".



Making the Terminal Discoverable

By default, the Dolphin terminal is not discoverable, which means that the terminal will not be found by other Bluetooth devices.

To make the terminal discoverable, tap **Mode** on the Horizontal scroll. Select **Make this device visible to other devices** and tap **OK**.

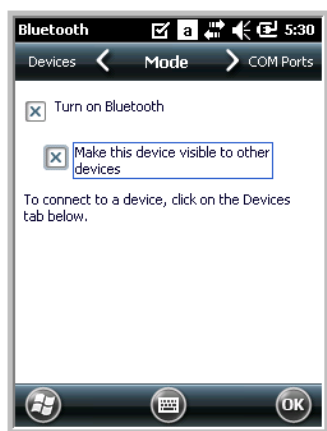

Dolphin HomeBase (Model 6100-HB)/eBase (Model 6100-EHB) Device

Overview

Note: The information in this chapter applies to both the Dolphin HomeBase and Dolphin eBase devices unless otherwise indicated.

As the hub of your Dolphin 6110 system, the Dolphin HomeBase charging and communication cradle supports High-speed USB 2.0 and RS-232 communication with a workstation. The Dolphin eBase is identical to the Dolphin HomeBase except it supports Ethernet communication as well as USB 2.0, and RS-232.

Communication

The base can communicate via USB or serial RS-232 (or Ethernet for the eBase). Data transmission for USB is up to 480 Mbps. Data transmission for serial RS-232 is up to 115 Kbps.

These bases cannot be physically connected to each other—sometimes referred to as “daisy-chaining”—but can be networked together via serial or USB hubs.

Battery Charging

The base completes a full charge of a fully depleted battery pack in an average of 7 1/2 hours. It takes less time if the battery has some charge.

In addition to charging, the base powers the terminal's intelligent battery charging system, which protects the battery from being damaged by overcharging. The terminal senses when a battery pack is fully charged and automatically turns off the charger. If the battery voltage drops below the charge threshold, the charger turns on again to maintain the battery at full capacity. As a result, Dolphin terminals may be stored in the base indefinitely without damage to the terminals, battery packs, or peripherals. For prolonged storage, see [Storage Guidelines](#) on page 3-9. The base can also charge a second battery while the terminal is positioned in the base. See [Charging a Spare Battery](#) on page 10-6.

Power Supply

The power cable that ships with each terminal also powers the base.



We recommend use of Honeywell peripherals, power cables, and power adapters that comply with L.P.S. Use of any non-Honeywell peripherals, cables, or power adapters may cause damage not covered by the warranty.



We recommend use of Honeywell Li-Ion battery packs. Use of any non-Honeywell battery may result in damage not covered by the warranty.



Ensure all components are dry prior to mating terminals/batteries with peripheral devices. Mating wet components may cause damage not covered by the warranty.

Front Panel

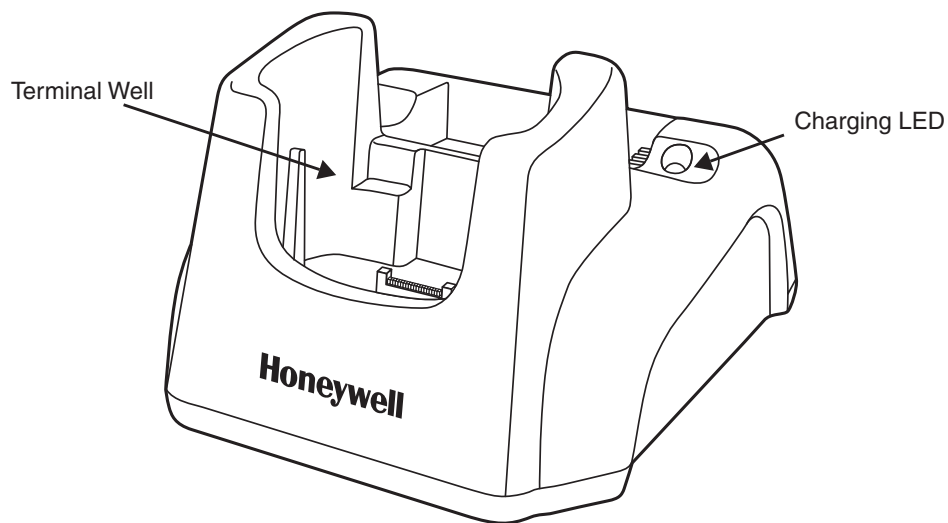

Terminal Well

Place the Dolphin terminal in the terminal well to communicate with a host device, power the terminal, and charge the terminal's battery. Make sure that the device is securely seated.

Rubber Feet

The bottom panel has four rubber feet to stabilize the unit on a flat surface. You can set the base on a dry, stable surface, such as a desktop or workbench near an electrical outlet.

Back Panel

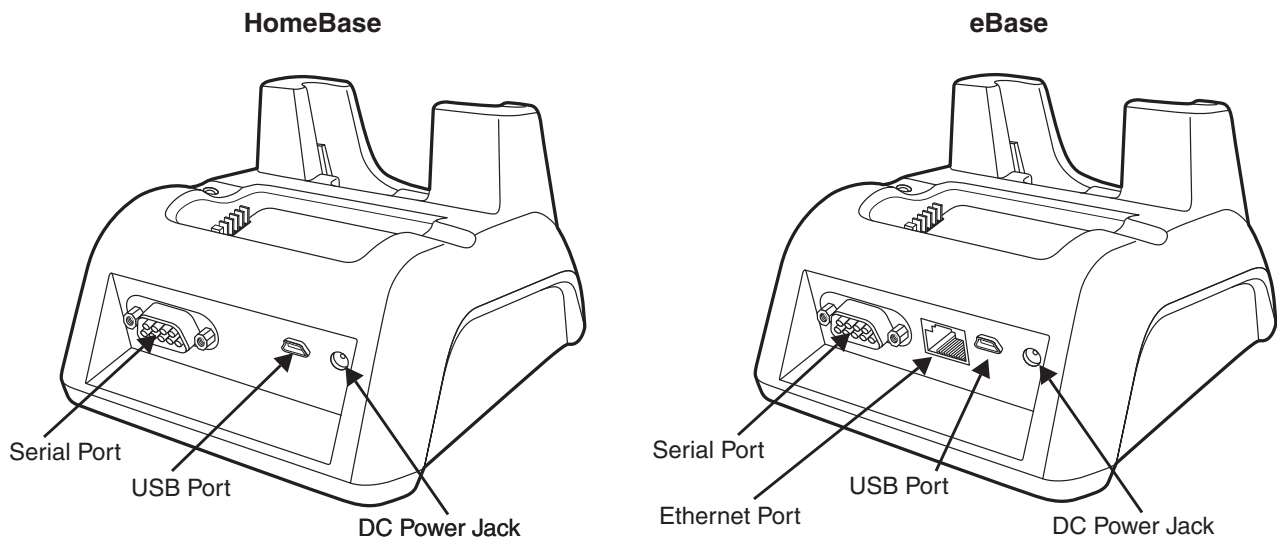

DC Power Jack

Connect the power cable to this power jack; see [Powering the Dolphin HomeBase Device](#) on page 10-4.

USB Port

The USB port is High-speed (v2.0). Using the USB cable, you can connect the base to a USB-compliant device to facilitate USB communication to and from the terminal. USB communication occurs through Microsoft ActiveSync (v.4.1 or higher). For more information about ActiveSync setup, see [Connecting and Synchronizing the Terminal and Workstation](#) on page 8-9.

Serial Port

The serial port supports serial communication between the terminal and another device. Note that the connector is a DB9 Male connector, requiring a female connector on the serial cable. The following four signals are supported:

- Transmitted Data
- Received Data
- Request to Send
- Clear to Send

Note: ActiveSync is not supported over the serial port.

Ethernet Port (eBase only)

Using an Ethernet cable, you can connect the eBase to an Ethernet-compliant device to facilitate Ethernet communication to and from the terminal. This equipment is for indoor use only. The communication wiring is limited to the inside of a building.

Powering the Dolphin HomeBase Device

The terminal requires 5 volts DC input for communication and battery charging; the power adapter on the power cable converts the voltage from the power source to 5 volts DC. Only power adapter cables from Honeywell convert the voltage appropriately.

The same power cable that ships with each terminal can be used to power the base. This cable contains a plug adapter for each geography (US, UK, EU, etc.).

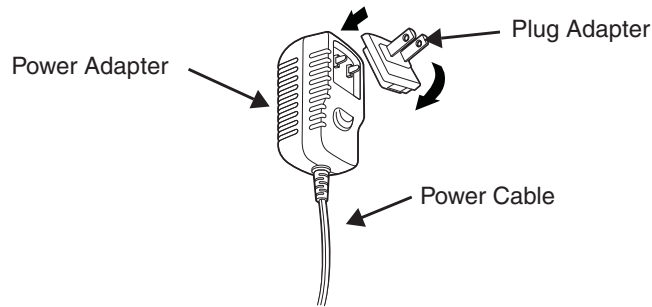

1. Attach the appropriate plug adapter to the power adapter.
2. Plug the power cable into the power source.
3. Plug the connector into the DC power jack on the back panel. The base is now powered.

When a terminal is properly seated, the base powers the terminal, charges the terminal's battery pack, and launches ActiveSync (see [Connecting and Synchronizing the Terminal and Workstation](#) on page 8-9).

Honeywell recommends that you leave the base connected to its power source at all times, so that it is always ready to use.

eBase Clamp-on Ferrite Core Installation

We recommend that you install the clamp-on ferrite core included with your Dolphin® eBase on your Ethernet cable. *Installation of the ferrite is required to meet the declared FCC emission levels.*

The following illustration shows how to install the ferrite on the cable. It should be placed approximately 1.57 inches (40mm) from the RJ45 plug. The cable should be looped around the core, as shown.

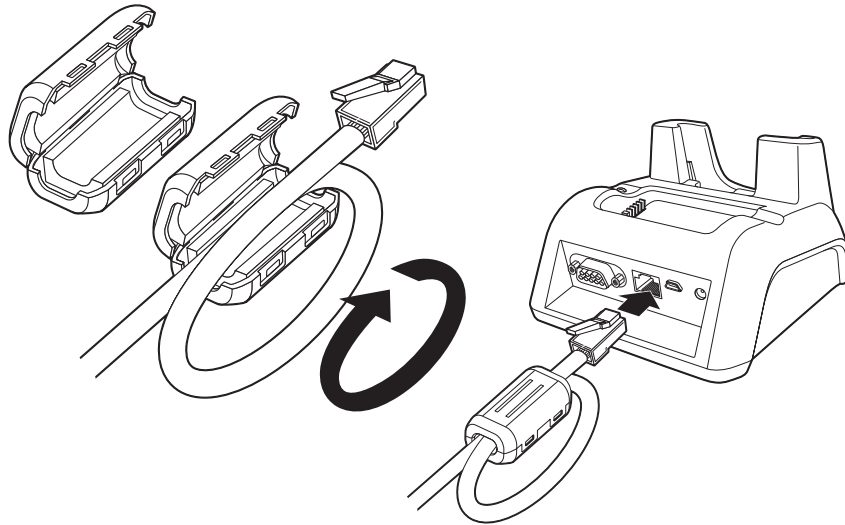

Charging the Battery

The base powers the terminal and fully charges its battery pack in an average of 7 1/2 hours for a fully depleted battery. It takes less time if the battery has some charge.

As battery packs charge, the charging circuitry follows the two-step charging process (CC-CV) that is recommended for Li-Ion batteries. The process monitors changes in temperature, current, and voltage.

Inserting a Terminal

1. Install the battery pack in the terminal; see [Install the Battery](#) on page 2-1.
2. Power the base; see [Powering the Dolphin HomeBase Device](#) on page 10-4.
3. Slide the terminal into the terminal well making certain that the terminal is seated properly.
4. The battery pack begins charging.

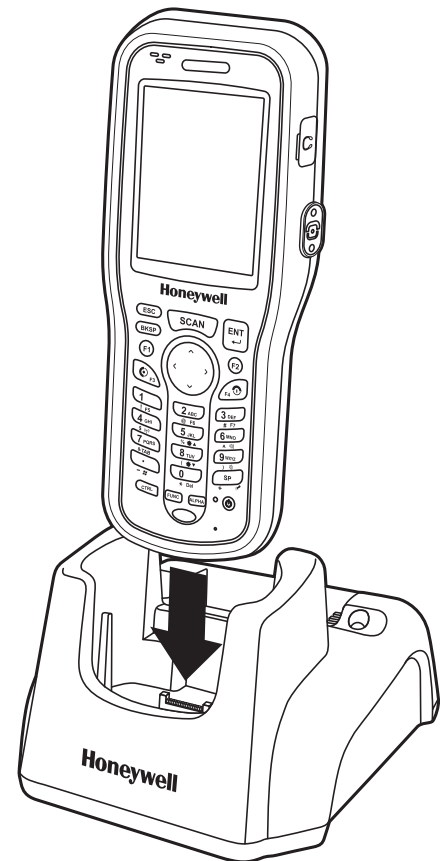

 *Ensure all components are dry prior to mating terminals/ batteries with peripheral devices. Mating wet components may cause damage not covered by the warranty.*

Charging a Spare Battery

The base can also charge a second battery while the terminal is positioned in the base. The second battery can be inserted in the battery charging well in back of the terminal connection. Place the battery in the well with the label facing up and toward the back of the unit. Angle the battery as shown. Once the connectors engage, the LED lights. If the LED is red, the unit is charging; if it is green, the charge is complete.

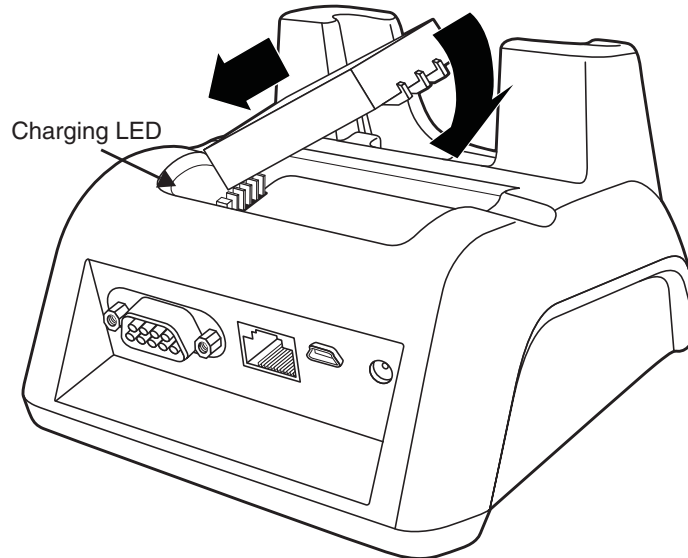

Checking Battery Power

To check battery power while the terminal is operating, tap  > **Settings** > **Power**.

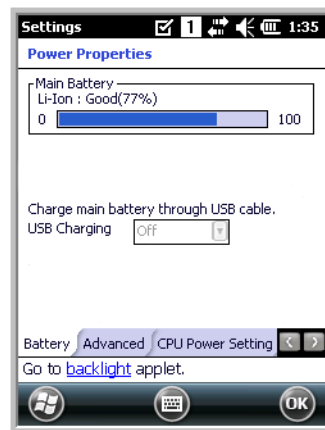

Technical Specifications

Structural	
Dimensions	5.3 in. high X 4.5 in. wide X 3.1 in. deep (13.5 cm. X 11.4 cm. X 7.9 cm.)
Weight	Dolphin HomeBase - 11.0 oz. (313g) Dolphin eBase - 11.3 oz (320g)
Material	Polycarbonate
Color	Black
Environmental	
Operating Temperature	14° to 122°F (-10° to +50°C)
Storage Temperature	-4° to 158°F (-20° to +70°C)
Charging Temperature	32° to 104°F (0° to 40°C)
Electrical Static Discharge	Air: ± 15k Vdc Direct: ± 8k Vdc
Humidity	90% relative humidity (non-condensing)
Power Supply	
Input (Universal) (from the power source)	100–240 Volts, 0.4 A 50–60Hz Included with Dolphin terminal
Output (to the base)	5 Volts DC, 2.0 A
Charging	
Standard Charge	2200mAh / 8.1Wh - 6 hours for a fully depleted battery 3300mAh / 12.2Wh - 9 hours for a fully depleted battery
Max Charging Current	1A Max
Standby Current	<100mA
Status LED	Green: charged Red: charging
Communication	
Interface	USB Mini-B Male connector supports data transmission of up to 480 Mbps OR Standard DB9 serial connector supports data transmission up to 115 Kbps
Agency Approvals	
Power Supply:	UL listed TUV licensed Power Supply compliant to FCC part 15, Class B
Charging:	CE Marking (EMC) CISPR Pub 22
Fire Retardant:	UL 94-V0



Dolphin 6110 ChargeBase Device (Model 6100-CB-1)

Overview

The Dolphin 6110 ChargeBase is a 4-slot charging cradle that can power four Dolphin terminals, and charge their batteries in 6 hours for a standard battery and 9 hours for an extended battery.



We recommend use of Honeywell peripherals, power cables, and power adapters that comply with L.P.S. Use of any non-Honeywell peripherals, cables, or power adapters may cause damage not covered by the warranty.

Unpacking the ChargeBase

Open the shipping box and inspect the package to see that the following standard items are included:

- One Dolphin ChargeBase cradle
- One universal AC/DC power adapter for the Dolphin ChargeBase
- One power cord

These items are needed to set up and operate the ChargeBase. If any items are missing or anything appears to be damaged, contact your Customer Account Representative.

Keep the original packaging in case you need to return the ChargeBase for service or to store the ChargeBase while not in use.

Charge Time

The base supplies power to the intelligent battery charging system in all Dolphin terminals, which senses when a full charge has been achieved and switches to a trickle charge to maintain the full charge.

As battery packs charge, the charging circuitry follows the two-step charging process (CC-CV) that is recommended for Li-ion batteries. The process monitors changes in temperature, current, and voltage. The battery of each terminal charges in 6 hours for the standard 3.7V battery or 9 hours for the extended 3.7V battery.

Convenient Storage

Intelligent battery charging makes this base a safe and convenient storage receptacle for your Dolphin terminal.

Capacity

The base can hold up to 4 Dolphin terminals. Each charging well charges each terminal independently of the other wells.



We recommend use of Honeywell Li-ion battery packs. Use of any non-Honeywell battery may result in damage not covered by the warranty.



We recommend use of Honeywell peripherals, power cables, and power adapters that comply with L.P.S. Use of any non-Honeywell peripherals, cables, or power adapters may cause damage not covered by the warranty.

Parts and Functions

Front Panel

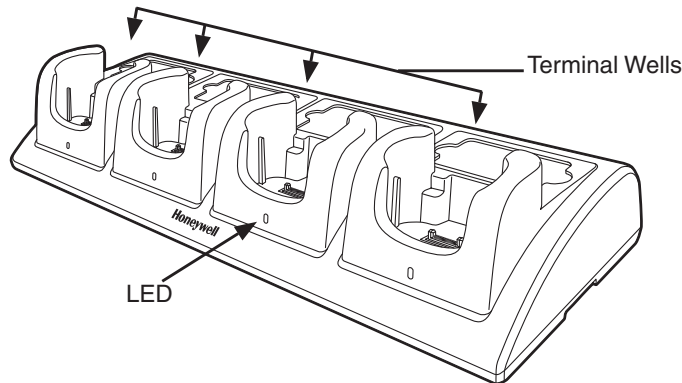

Terminal Wells

The ChargeBase contains four terminal wells. Each well has its own dedicated LED indicator. The ChargeBase completely charges the battery in a Dolphin terminal in 6 hours for the standard 3.7V battery or 9 hours for the extended 3.7 battery.

Back Panel

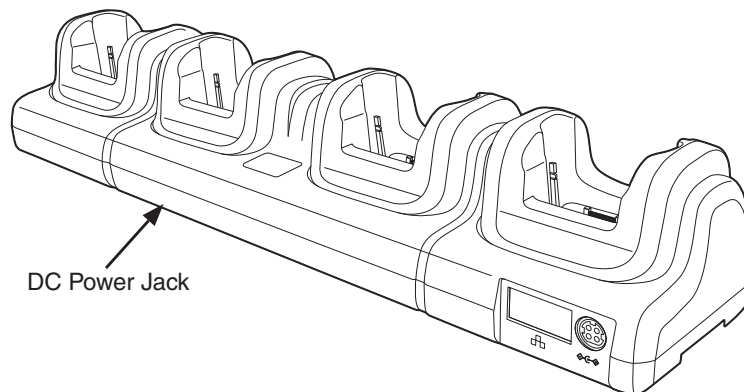

DC Power Jack

Use the power cable from Honeywell that comes with the ChargeBase to supply power to the power jack. For more information, see [Power](#) on page 11-2.

Power

The terminal requires 5 Volts DC input for battery charging; the power adapter on the power cable converts the voltage from the power source to 5 volts DC. **Only** the Honeywell 5V/7A power supply provided with the ChargeBase converts the voltage appropriately. The operating temperature range is -10° to 50°C (14° to 122°F).

Honeywell recommends that you leave the ChargeBase connected to its power source at all times, so that it is always ready to use.

 We recommend use of Honeywell peripherals, power cables, and power adapters that comply with L.P.S. Use of any non-Honeywell peripherals, cables, or power adapters may cause damage not covered by the warranty.

Connecting Power to the ChargeBase

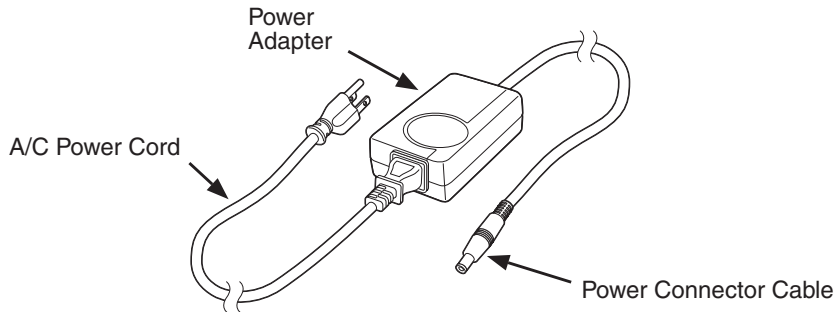

1. Plug the A/C power cord into the power adapter.
2. Plug the power connector cable into the power connector on the back of the ChargeBase.
3. Plug the A/C power cord into a standard wall outlet.
4. The base is ready to begin charging terminals.

Charging the Battery

The base provides power to the Dolphin terminals and allows the charging of the batteries in the terminals. The battery of each terminal charges in 6 hours for the standard 3.7V battery or 9 hours for the extended 3.7V battery. The intelligent battery charging system incorporated into all Dolphin terminals prevents overcharging, which means that Dolphin terminals may be stored in the base indefinitely without damage to the terminals, battery packs, or the base.

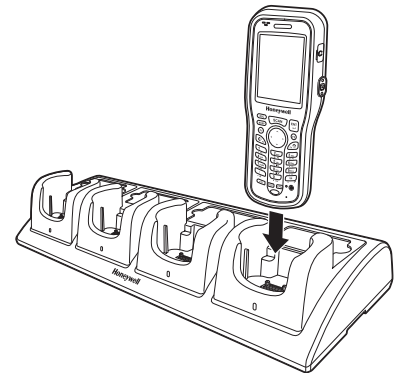

To Power a Terminal and Charge its Battery

1. Install the battery pack in the terminal; see [Install the Battery](#) on page 2-1.
2. Verify the base has power. If the LEDs are not illuminated, see [Connecting Power to the ChargeBase](#) on page 11-3.
3. Slide the Dolphin terminal into one of the four terminal wells. The the Power/Dock LED for the well changes to green. Charging begins immediately if required by the Dolphin terminal.

 Make sure the terminal is dry before placing it in the ChargeBase. Do NOT place a wet terminal in the ChargeBase! Doing so may cause damage not covered by the warranty.

 We recommend use of Honeywell Li-Ion battery packs. Use of any non-Honeywell battery may result in damage not covered by the warranty.

Mounting the ChargeBase

Set the ChargeBase on a dry, stable surface, such as a desktop or workbench near an electrical outlet. Be sure to provide enough workspace with good lighting for the user to view and operate the Dolphin terminal while it is in the ChargeBase. When choosing a location, bear in mind that the mounting location must allow users easy access to the terminal wells and the power jack.

Bottom Panel

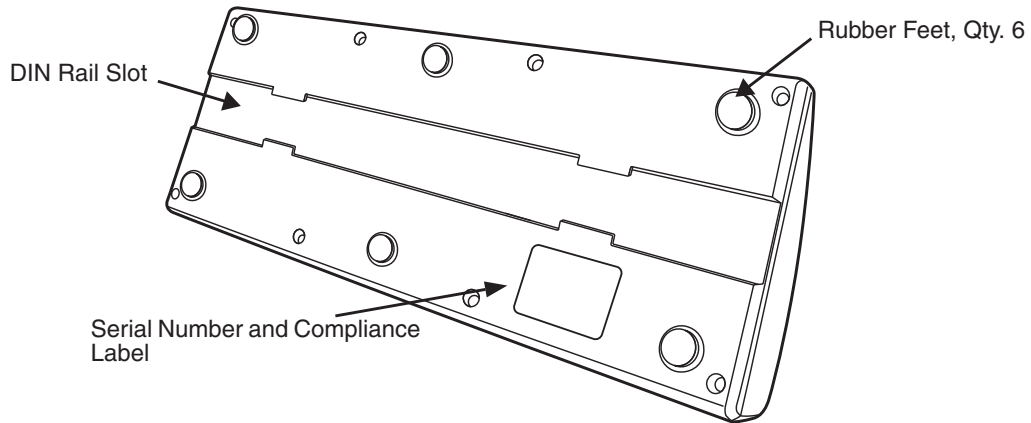

Desk Mounting

The DIN Rail (7.5 X 35 mm) slot on the bottom panel enables secure mounting on a horizontal surface.

Hardware Required

- 3/16 in. dia x 5/8 in. long pan head screw
- 1/2 in. OD x 7/32 in. ID x 3/64 in. thick
- 3/16 in. dia nut

Installing the DIN Rail

1. Slide the DIN Rail into the DIN Rail slot on the bottom panel of the base.

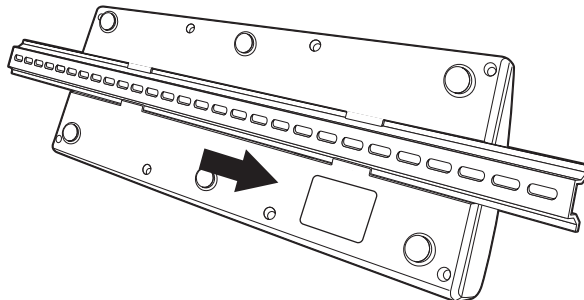

2. Turn the base and DIN Rail right side up.

-
- Then, using the appropriate nuts and bolts, secure the DIN Rail to a stable, flat horizontal surface.

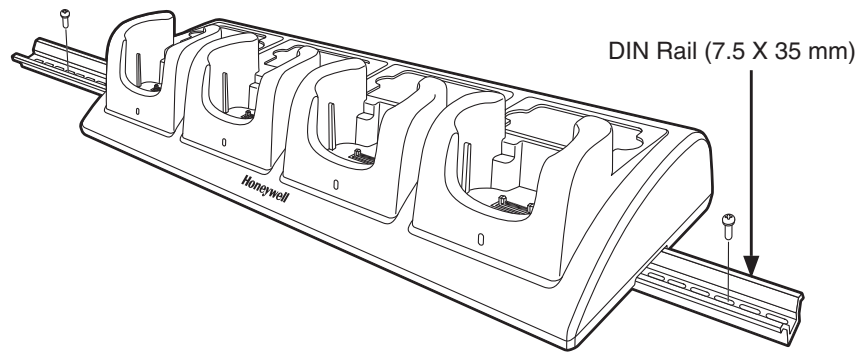

Wall Mounting

The optional wall mount bracket enables secure mounting of the base on a vertical surface. The wall mount bracket can be used in conjunction with the DIN rail but does not require the DIN Rail for use.

Hardware (Provided)

- M3 x 9 mm self-tapping screws, #2 Phillips, Qty. 4
- 3/8 in. x 4 in. round head toggle bolt, 2-5/8 in. usable length, Qty. 4
- 3/8 in. x 2 1/2 in. length Hex Head Lag Screw, Qty. 4

Tools Required

- Drill
- 7/8 in. Drill Bit (for hollow wall installations) or 1/4 in. Drill Bit (for wood stud installation)
- Phillips Screw Driver

Hollow Wall Installation

- Drill four pilot holes in the wall using a 7/8 in. drill bit.

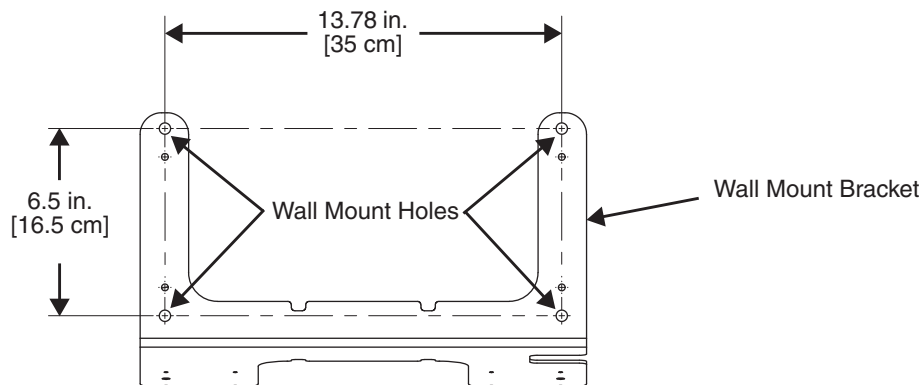

-
- Slide the bolt through the wall bracket, and thread the toggle nut onto the bolt.
 - Press the ends of the toggle nut together, and insert the bolt/nut into the pilot hole until the nut clears inside wall surface. The toggle nut should spring open preventing the screw from being removed.
 - Repeat steps 2 and 3 for each of the remaining mounting holes.
 - Tighten all four bolts to secure the bracket to the wall.
 - Once the bracket is installed, secure the base to the wall bracket, see [Securing the Base to the Wall Bracket](#) for detailed instructions.

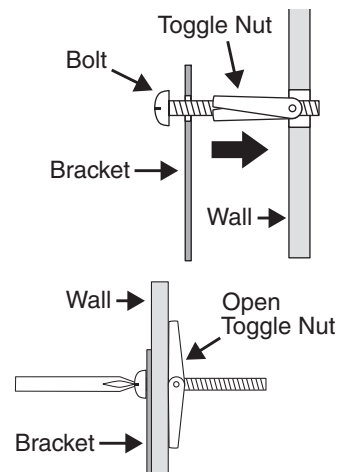

Wood Stud Installation

- Drill four pilot holes in the wall/wood stud using the 1/4 in. drill bit.
- Secure the bracket to the wall using the four Hex Head Lag Screws provided.
- Once the bracket is installed, secure the base to the wall bracket, [Securing the Base to the Wall Bracket](#) for detailed instructions.

Securing the Base to the Wall Bracket

You can secure the base to the wall bracket using the optional DIN rail.

Hardware Required

- DIN Rail, Qty. 1
- 3/16 in. dia x 5/8 in. long pan head screw, Qty. 2
- 1/2 in. OD x 7/32 in. ID x 3/64 in. thick washer, Qty. 2
- 3/16 in. dia nut, Qty. 2

- Position the DIN Rail on the wall bracket, as shown below.
- Slide the screw through the slot on the DIN Rail and the mounting hole in the bracket.

-
3. Slide the washer onto the screw and tighten the nut to secure the assembly.

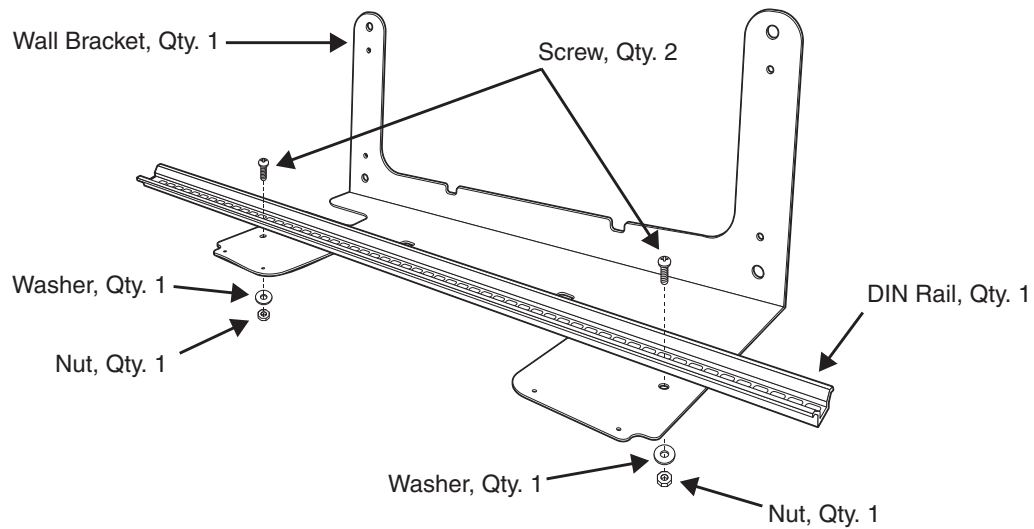

4. Remove the rubber feet on the bottom of the ChargeBase.
5. Slide the base onto the DIN Rail using the slot on the bottom of the base.

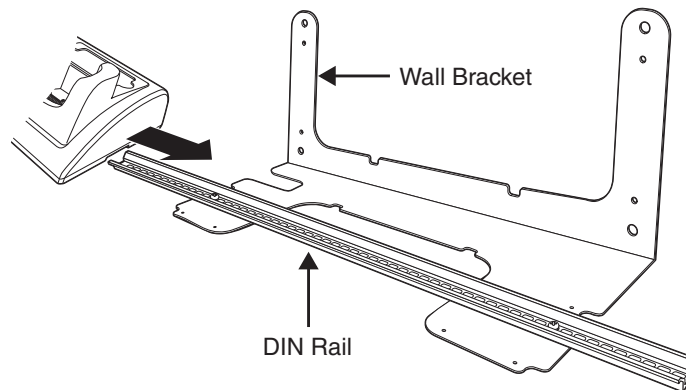

Technical Specifications

Structural	
Dimensions	3.2 in. high X 16.37 in. wide X 6.1 in. deep (8.2 cm. X 41.6 cm. X 15.5 cm.)
Weight	35.27 oz. (1Kg)
Material	Polycarbonate
Color	Black
Environmental	
Operating Temperature	14° to 122°F (-10° to +50°C)
Storage Temperature	-4° to 158°F (-20° to +70°C)
Charging Temperature	32° to 104°F (0° to 40°C)
Electrical Static Discharge	Air: ± 15k Vdc Direct: ± 8k Vdc
Humidity	90% relative humidity (non-condensing)
Power Supply	
Input (Universal) (from the power source)	100–240 Volts, 1.5 A 50–60Hz
Output (to the base)	+5VDC @7A
Charging	
Standard Charge	2200mAh / 8.1Wh - 6 hours for a fully depleted battery 3300mAh / 12.2Wh - 9 hours for a fully depleted battery
Agency Approvals	
ChargeBase Power Supply:	UL listed TUV licensed Power Supply compliant to FCC part 15, Class B CE Marking (EMC) CISPR Pub 22
Fire Retardant:	UL 94-V0

Dolphin 6110 Net Base Device (Model 6100-NB)

Overview

The Net Base enables up to four Dolphin 6110 mobile computers to communicate with a host device over an Ethernet network. In addition, the Net Base provides a second RJ45 Ethernet port for connection to an additional device such as a printer, workstation, eBase, or another Net Base.



We recommend use of Honeywell peripherals, power cables, and power adapters that comply with L.P.S. Use of any non-Honeywell peripherals, cables, or power adapters may cause damage not covered by the warranty.

Unpacking the Net Base

Open the shipping box and inspect the package to see that the following standard items are included:

- One Dolphin Net Base Ethernet cradle
- One universal AC/DC power adapter for the Dolphin Net Base
- One power cord

You will also need to provide a standard CAT-5 Ethernet network cable. These items are needed to set up and operate the Net Base. If any items are missing or anything appears to be damaged, contact your Customer Account Representative.

Keep the original packaging in case you need to return the Net Base for service or to store the Net Base while not in use.

Charge Time

The base supplies power to the intelligent battery charging system in all Dolphin terminals, which senses when a full charge has been achieved and switches to a trickle charge to maintain the full charge.

As battery packs charge, the charging circuitry follows the two-step charging process (CC-CV) that is recommended for Li-ion batteries. The process monitors changes in temperature, current, and voltage. The battery of each terminal charges in 6 hours for the standard 3.7V battery or 9 hours for the extended 3.7V battery.

Convenient Storage

Intelligent battery charging makes this base a safe and convenient storage receptacle for your Dolphin terminal.

Capacity

The base can hold up to 4 Dolphin terminals. Each charging well charges each terminal independently of the other wells.



We recommend use of Honeywell Li-ion battery packs. Use of any non-Honeywell battery may result in damage not covered by the warranty.



We recommend use of Honeywell peripherals, power cables, and power adapters that comply with L.P.S. Use of any non-Honeywell peripherals, cables, or power adapters may cause damage not covered by the warranty.

Parts and Functions

Front Panel

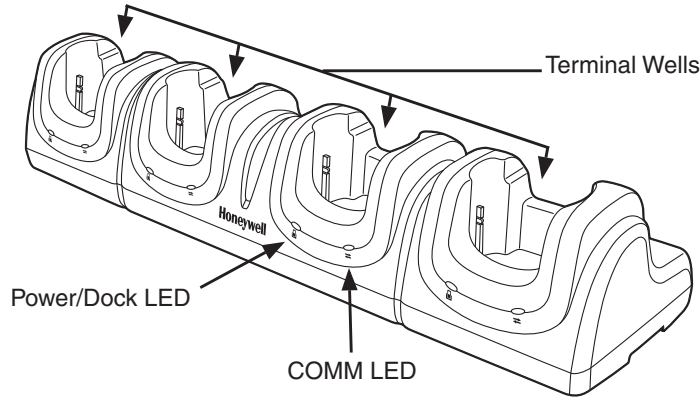

Terminal Wells

The Net Base contains four terminal wells. Each well has its own dedicated Power/Dock LED and COMM LED indicator.

Place the Dolphin terminal in any one of the four wells to communicate with a host device, power the terminal, and charge the installed battery pack. The Net Base completely charges the battery in a Dolphin terminal in 6 hours for the standard 3.7V battery or 9 hours for the extended 3.7 battery.

Power/DOCK LED

Indicates if power is supplied to the Net Base and if a terminal is docked properly in the terminal well. Each terminal well has its own dedicated Dock LED.

This color	means...
-------------------	-----------------

Red	The Net Base has power but no terminal is docked.
-----	---

Green	The Net Base has power and the terminal is properly seated in the base.
-------	---

COMM LED

The COMM LED indicates the status of connection and data transfer between the Dolphin terminal and the Net Base. Each terminal well has its own dedicated COMM LED.

When the Dolphin terminal is docked:

This color	and status	means...
-------------------	-------------------	-----------------

Green	Solid	A connection has been established between the Dolphin terminal and the Net Base.
-------	-------	--

Green	Flashing	Data transfer in progress.
-------	----------	----------------------------

Note: The COMM LED does not necessarily indicate the Net Base and terminal are connected to a valid Ethernet link. For more information, see [RJ45 Ethernet Ports](#) on page 12-3.

Back Panel

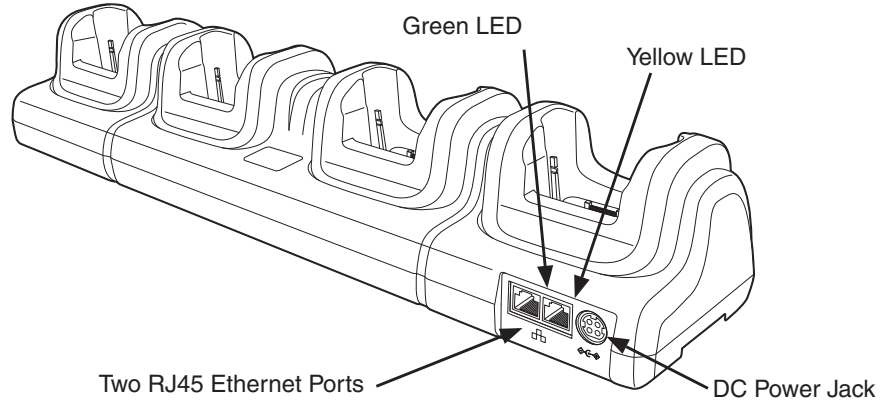

DC Power Jack

Use the power cable from Honeywell that comes with the Net Base to supply power to this power jack. For more information, see [Power](#) on page 12-4.

RJ45 Ethernet Ports

The Net Base contains two RJ45 Ethernet ports. You can connect the Net Base to an Ethernet-compliant device to facilitate Ethernet communication to and from the terminal by plugging a standard CAT-5 Ethernet cable into one of the two Ethernet ports provided. The second RJ45 Ethernet port can be used for connection to an additional device such as a printer, workstation, eBase, or another Net Base.

Note: The Net Base does not use a Spanning Tree Protocol (STP). When both RJ45 Ethernet ports are used, do not connect both Net Base interfaces to the same layer 2 LAN.

Each Ethernet port has a dedicated green and yellow status LED.

This color	and status	means...
Green	Flashing	Data transfer is in progress.
	Solid	A connection has been established between the Net Base and the Ethernet.
Yellow	Solid	Ethernet is connected at 100T.
	Off	Ethernet is connected at 10T.

Note: The terminal and Ethernet link must be set up properly to allow the terminal to communicate to other devices and/or the Internet. For more information, see [Connecting the Dolphin Terminal to the Net Base](#) on page 12-5.

Bottom Panel

For details on how to mount the Net Base, see [Mounting the Net Base](#) on page 12-6.

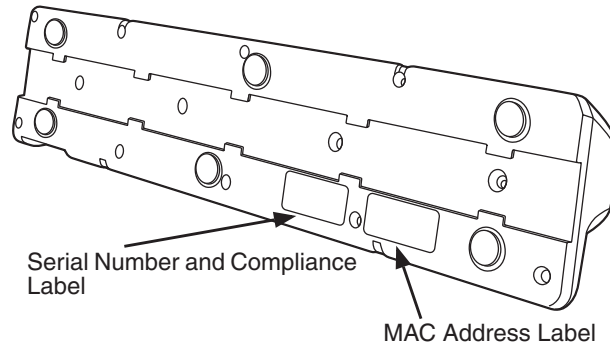

Power

The terminal requires 12 Volts DC input for communications and battery charging; the power adapter on the power cable converts the voltage from the power source to 12 volts DC. **Only** the Honeywell 12V/ 8.5A power supply provided with the Net Base converts the voltage appropriately. The operating temperature range is -10° to 50°C (14° to 122°F).

Honeywell recommends that you leave the Net Base connected to its power source at all times, so that it is always ready to use.



We recommend use of Honeywell peripherals, power cables, and power adapters that comply with L.P.S. Use of any non-Honeywell peripherals, cables, or power adapters may cause damage not covered by the warranty.

Connecting Power to the Net Base

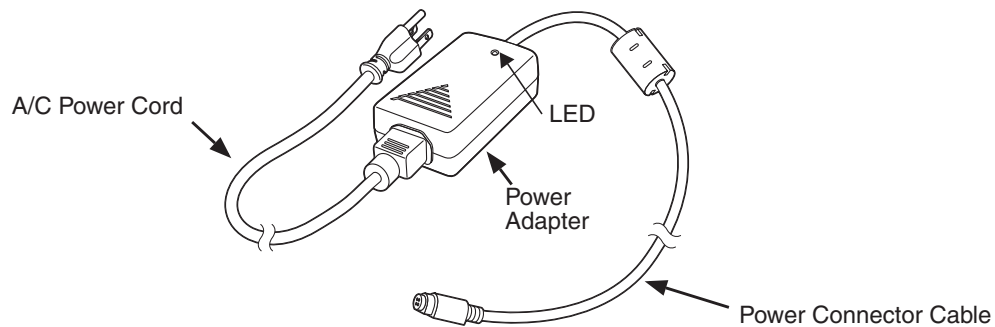

1. Plug the A/C power cord into the power adapter.
2. Plug the power connector cable into the power connector on the back of the Net Base.
3. Plug the A/C power cord into a standard wall outlet. The LED on the Power Adapter illuminates to indicate power.
4. All four Power/Dock LEDs illuminate solid red to indicate the base has power. Terminal wells with properly docked Dolphins indicate power with a green LED.
5. The base is ready to begin charging terminals.

Charging the Battery

The base provides power to the Dolphin terminals and allows the charging of the batteries in the terminals. The battery of each terminal charges in 6 hours for the standard 3.7V battery or 9 hours for the extended 3.7V battery. The intelligent battery charging system incorporated into all Dolphin terminals prevents overcharging, which means that Dolphin terminals may be stored in the base indefinitely without damage to the terminals, battery packs, or the base.

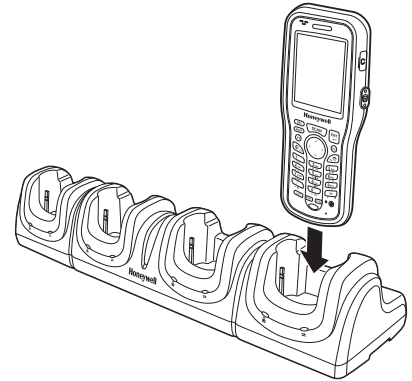

To Power a Terminal and Charge its Battery

1. Install the battery pack in the terminal; see [Install the Battery](#) on page 2-1.
2. Verify the base has power. If the Power/Dock LEDs are not illuminated, see [Connecting Power to the Net Base](#) on page 12-4.
3. Slide the Dolphin terminal into one of the four terminal wells. The the Power/Dock LED for the well changes to green. Charging begins immediately if required by the Dolphin terminal.

 *Make sure the terminal is dry before placing it in the Net Base. Do NOT place a wet terminal in the Net Base! Doing so may cause damage not covered by the warranty.*

 *We recommend use of Honeywell Li-Ion battery packs. Use of any non-Honeywell battery may result in damage not covered by the warranty.*

Communication

Software Requirements

Before you connect the Dolphin terminal to the Net Base, make sure you have the most current software installed. To check the terminal's system information, tap  > **Power Tools** > **SysInfo**.

- The Kernel version must be 28.04 or later in terminals running Windows Embedded Handheld 6.5 Classic.
- In terminals running Windows CE 5.0, the kernel version must be 23.08 Service Pack 8 or later.



Applications on the Dolphin Terminal

Applications running on the Dolphin terminal when it is connected to the Net Base should be designed specifically for a partially connected network. For more details, please refer to the *Best Practices for Partially Connected Networks* document available at www.honeywellaidc.com.

Connecting the Dolphin Terminal to the Net Base

By default, the Dolphin terminal is configured to obtain IP addresses automatically using a DHCP server. This means that in most cases, you would simply plug-and-play the unit.

1. Verify the base has power. If the Power/Dock LEDs are not illuminated, see [Connecting Power to the Net Base](#) on page 12-4.
2. Plug the CAT-5 Ethernet cable into one of the RJ45 connectors on the back of the Net Base.
3. Plug the Ethernet cable into the network.

-
4. Insert the Dolphin into one of the terminal wells. The DOCK LED for the well changes from red to green and the connection icon on the Dolphin's title bar changes from  to .
 5. By default, the DHCP server assigns a unique IP address to each of the Dolphin terminals docked in the Net Base. This IP address can be used by any application on the Dolphin terminal.

Note: Instead of using the default for DHCP assigned IP addresses, the Dolphin terminal can use a statically assigned IP address. See standard Microsoft Windows Mobile documentation for how to assign a static IP address to a network adapter. In this case, set a static IP address for the adapter named "SMC95001 USB2.0 FAST Ethernet Drive".

Displaying the Net Base Terminal Well and Dolphin IP Address

Once the Dolphin terminal establishes communication, it uses the unique IP address assigned to the terminal well it is docked in on the Net Base. If four Dolphin terminals are successfully connected, then four different IP addresses are assigned to the adapter associated with the Dolphin terminal.

1. Tap  > **Power Tools** > **Network Utilities** > **IPConfig**.
2. Change the **Adapter** to SMC95001.
3. On the Input tab, tap the **Display full configuration** button.
4. The Dolphin terminal retrieves and displays the IP configuration for the entire Dolphin terminal and the Net Base terminal well where the Dolphin is docked.
5. Locate the **IpAddress** field in the IP configuration list.

Mounting the Net Base

Set the Net Base on a dry, stable surface, such as a desktop or workbench near an electrical outlet. Be sure to provide enough workspace with good lighting for the user to view and operate the Dolphin terminal while it is in the Net Base. When choosing a location, bear in mind that the mounting location must allow users easy access to the terminal wells, the Ethernet ports, and the power jack.

Bottom Panel

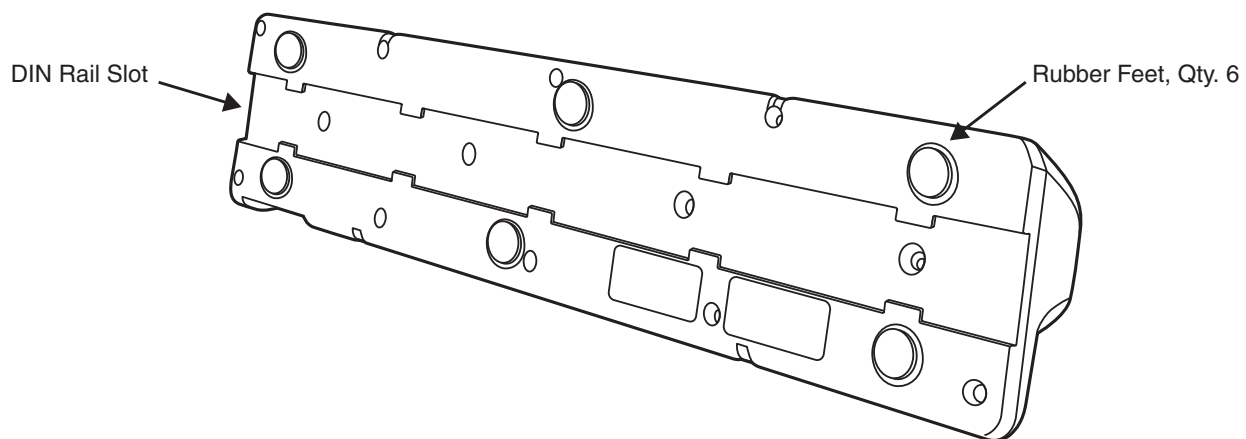

Desk Mounting

The DIN Rail (7.5 X 35 mm) slot on the bottom panel enables secure mounting on a horizontal surface.

Hardware Required

- 3/16 in. dia x 5/8 in. long pan head screw
- 1/2 in. OD x 7/32 in. ID x 3/64 in. thick
- 3/16 in. dia nut

Installing the DIN Rail

1. Slide the DIN Rail into the DIN Rail slot on the bottom panel of the base.

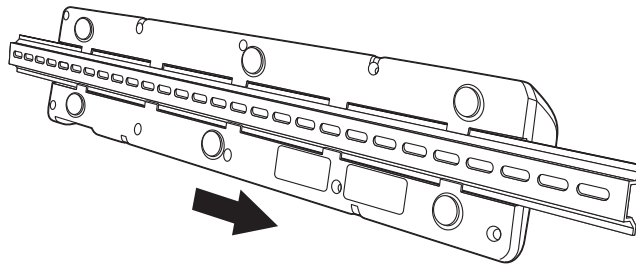

2. Turn the base and DIN Rail right side up.
3. Then, using the appropriate nuts and bolts, secure the DIN Rail to a stable, flat horizontal surface.

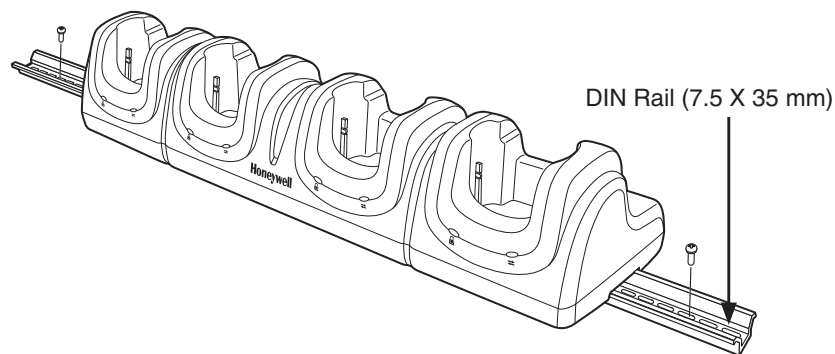

Wall Mounting

The optional wall mount bracket enables secure mounting of the base on a vertical surface. The wall mount bracket can be used in conjunction with the DIN rail but does not require the DIN Rail for use.

Hardware (Provided)

- M3 x 9 mm self-tapping screws, #2 Phillips, Qty. 4
- 3/8 in. x 4 in. round head toggle bolt, 2-5/8 in. usable length, Qty. 4
- 3/8 in. x 2 1/2 in. length Hex Head Lag Screw, Qty. 4

Tools Required

- Drill
- 7/8 in. Drill Bit (for hollow wall installations) or 1/4 in. Drill Bit (for wood stud installation)
- Phillips Screw Driver

Hollow Wall Installation

1. Drill four pilot holes in the wall using a 7/8 in. drill bit.

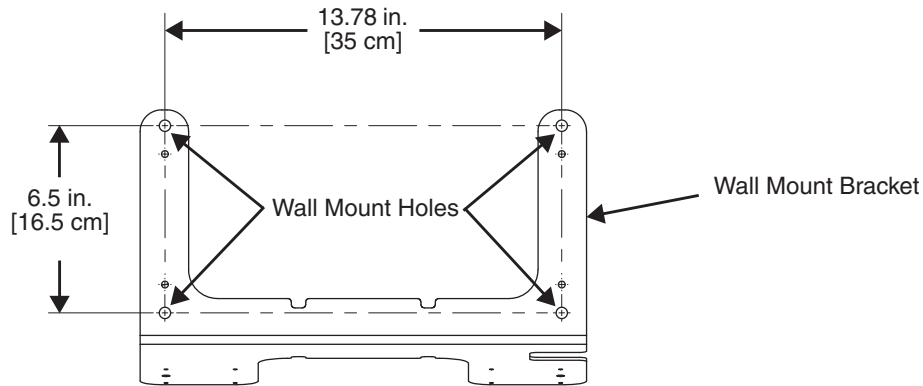

2. Slide the bolt through the wall bracket, and thread the toggle nut onto the bolt.
3. Press the ends of the toggle nut together, and insert the bolt/nut into the pilot hole until the nut clears inside wall surface. The toggle nut should spring open preventing the screw from being removed.
4. Repeat steps 2 and 3 for each of the remaining mounting holes.
5. Tighten all four bolts to secure the bracket to the wall.
6. Once the bracket is installed, secure the base to the wall bracket, see [Securing the Base to the Wall Bracket](#) for detailed instructions.

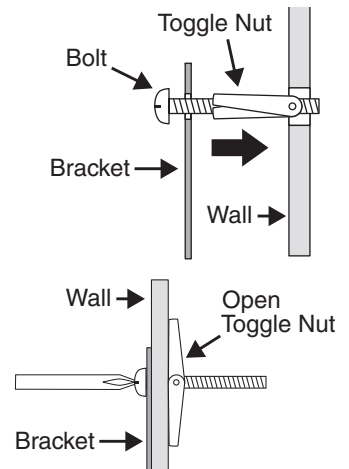

Wood Stud Installation

1. Drill four pilot holes in the wall/wood stud using the 1/4 in. drill bit.
2. Secure the bracket to the wall using the four Hex Head Lag Screws provided.
3. Once the bracket is installed, secure the base to the wall bracket, [Securing the Base to the Wall Bracket](#) for detailed instructions.

Securing the Base to the Wall Bracket

You can secure the base to the wall bracket using the optional DIN rail.

Hardware Required

- DIN Rail, Qty. 1
- 3/16 in. dia x 5/8 in. long pan head screw, Qty. 2
- 1/2 in. OD x 7/32 in. ID x 3/64 in. thick washer, Qty. 2
- 3/16 in. dia nut, Qty. 2

1. Position the DIN Rail on the wall bracket, as shown below.
2. Slide the screw through the slot on the DIN Rail and the mounting hole in the bracket.

-
3. Slide the washer onto the screw and tighten the nut to secure the assembly.

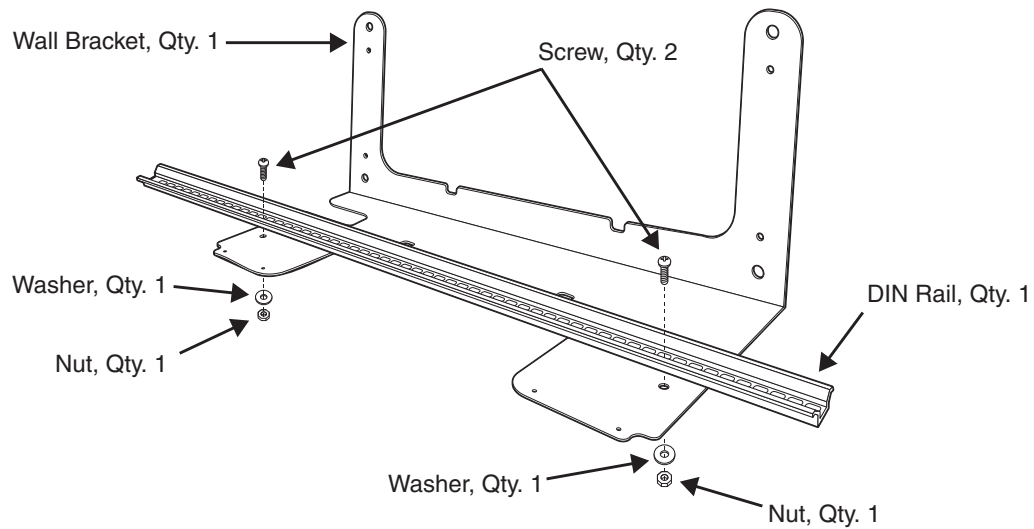

4. Remove the rubber feet on the bottom of the Net Base.
5. Slide the base onto the DIN Rail using the slot on the bottom of the base.

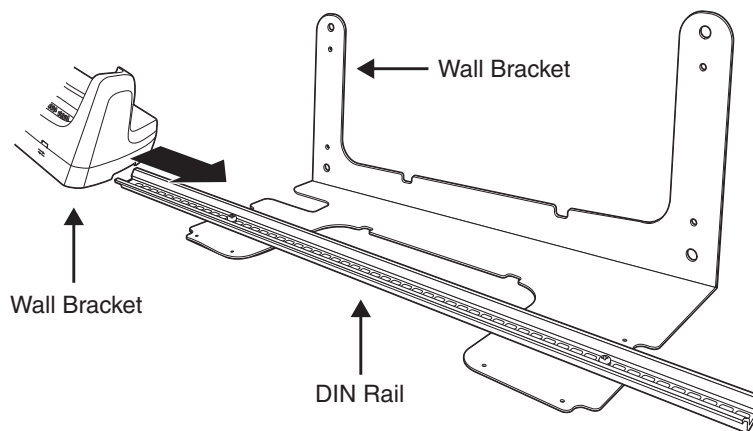

Technical Specifications

Structural	
Dimensions	3.17 in. high X 17.64 in. wide X 3.97 in. deep (8.05 cm. X 44.8 cm. X 10.1 cm.)
Weight	28.4 oz. (805g)
Material	Polycarbonate
Color	Black
Environmental	
Operating Temperature	14° to 122°F (-10° to +50°C)
Storage Temperature	-4° to 158°F (-20° to +70°C)
Charging Temperature	32° to 104°F (0° to 40°C)
Electrical Static Discharge	Air: ± 15k Vdc Direct: ± 8k Vdc
Humidity	90% relative humidity (non-condensing)
Power Supply	
Input (Universal) (from the power source)	90–264 Volts, 0.4 A 50–60Hz
Output (to the base)	+12VDC @8.5A
Charging	
Standard Charge	2200mAh / 8.1Wh - 6 hours for a fully depleted battery 3300mAh / 12.2Wh - 9 hours for a fully depleted battery
Status LEDs	Dock LED (denotes device docking status) Green: Terminal properly seated in NetBase. Communication LED Solid Red: Open connection and ready for data transfer Blinking Green: Active data transfer Continous Quick Blinking Red: No IP address available or detected Slow Blinking Yellow: Acquiring IP address Solid Yellow: Positive IP address and no terminal detected Solid Red: Positive IP address and terminal detected but no connection to terminal
Communication	
Interface	2-RJ45 Ethernet 10/100 ports for Ethernet connectivity; supports daisy chain connection of multiple bases
Agency Approvals	
NetBase Power Supply:	UL listed TUV licensed Power Supply compliant to FCC part 15, Class B CE Marking (EMC) CISPR Pub 22

Technical Specifications

Fire Retardant:	UL 94-V0
------------------------	----------



Dolphin QuadCharger Device

Overview

The Dolphin QuadCharger device is a four-slot charging station that charges up to four Dolphin 6110 Li-Ion battery packs in an average of 7 1/2 hours for a fully depleted battery. It takes less time if the battery has some charge. For more details about charging, see [Battery Charging](#) on page 13-2.

 We recommend use of Honeywell peripherals, power cables, and power adapters that comply with L.P.S. Use of any non-Honeywell peripherals, cables, or power adapters may cause damage not covered by the warranty.

 We recommend use of Honeywell Li-Ion battery packs. Use of any non-Honeywell battery may result in damage not covered by the warranty.

 Ensure all components are dry prior to mating batteries with peripheral devices. Mating wet components may cause damage not covered by the warranty.

QuadCharger Device

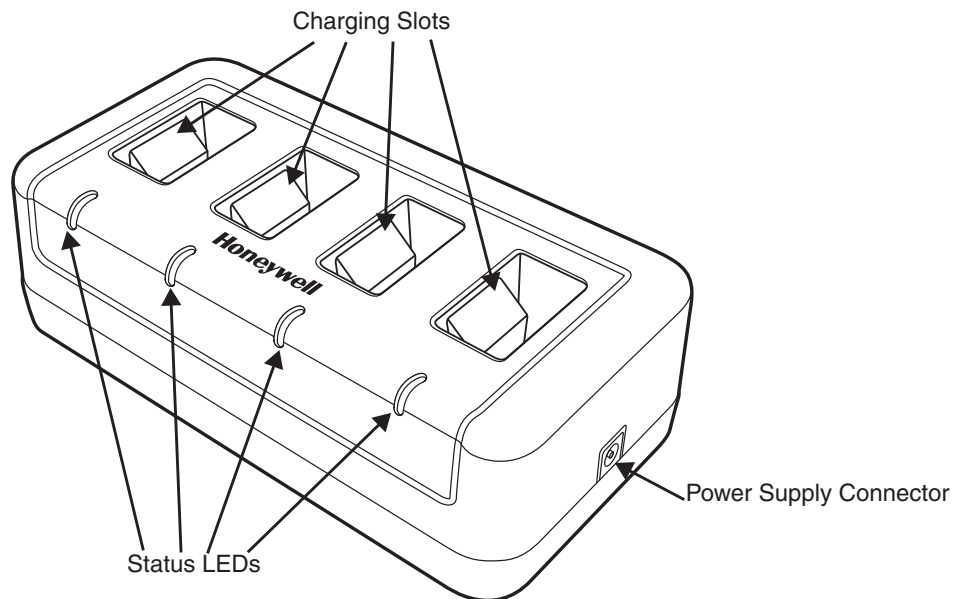

Charging Slots

The charger contains four charging slots. Each slot holds one battery. When a battery is placed in a slot, it immediately begins charging and its Status LED lights.

Status LEDs

A status LED is located at the end of each of the four battery slots. The color of the LED indicates the charge status of the battery in the slot.

Green	The battery has completed its charge cycle and is ready for use.
Red	The battery is charging.

Power Supply Connector

Use this connector to attach the power supply to the charger. The universal power supply accepts input voltages between 90–265 volts.

Battery Charging

Charging Process

This charger charges Dolphin 6110 Li-Ion battery packs in an average of 7 1/2 hours for a fully depleted battery. It takes less time if the battery has some charge. Each charging slot works independently of the other three. As battery packs charge, the charging circuitry follows the two-step charging process (CC-CV) that is recommended for Li-Ion batteries. The process monitors changes in temperature, current, and voltage.

Temperature

The six-hour charge time applies when batteries are charged within the recommended temperature range of 50° to 95° F (10° to 35°C). Temperature has a significant effect on charging. For best results, battery packs should be at room temperature before inserting in the charger.

 When the battery temperature exceeds 40°C, the charger may exceed the stated six-hour charge time. The charger stops charging if the battery temperature is greater than 40°C, but will begin charging again when the battery temperature is less than 40°C.

Charging Batteries

1. Supply the charger with power.
2. Insert batteries into the appropriate slots.
The Status LED for each slot turns red to indicate that the battery is properly seated and has begun a charge cycle.

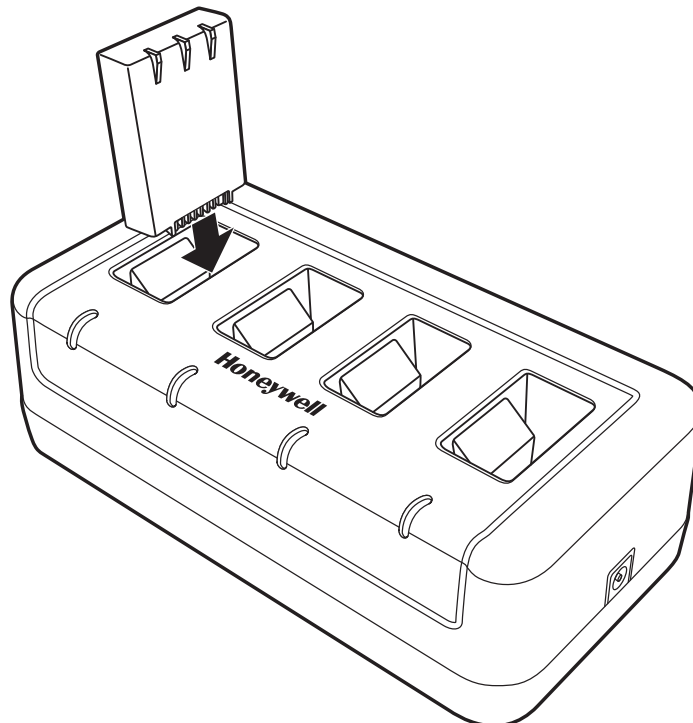

3. When the Status LED turns green, the battery in the slot has completed charging.

Recommendations for Storing Batteries

To maintain top performance from batteries, follow these storage guidelines:

- Avoid storing batteries outside of the specified temperature range of -4 to 104°F (-20 to 40°C) or in extremely high humidity.
- For prolonged storage, it is recommended that the battery be at a 40% - 50% charge level, be removed from the device, and stored in a controlled temperature environment. Following these recommendations will maximize battery life.

Troubleshooting

If you encounter problems with the charger, refer to chart below for possible solutions. If problems persist, contact [Product Service and Repair](#) (see page 14-1).

Problem	Issue
The Status LED does not come on when I insert a battery pack into a slot.	Check the power connections to the device; make sure the battery pack is properly seated.

Technical Specifications

Structural	
Dimensions	7.3 in. long X 3.7 in. wide X 2.4 in. high (18.5 cm. X 9.4 cm. X 6.1 cm.)
Weight	11.5 oz. (325g)
Material	Case: Polycarbonate Color: Black
Capacity	Supports up to four Li-Ion battery packs
Environmental	
Operating Temperature	32° to 104°F (0° to 40°C)
Storage Temperature	-4° to +140°F (-20° to +60°C)
Charging Temperature	32° to 104°F (0° to 40°C)
Electrical Static Discharge	Air: ± 15k Vdc Direct: ± 8k Vdc
Humidity	90% relative humidity (non-condensing)
Power Supply	
Input (Universal)	100V-240V, 1.2 A 50-60Hz Included
Output	5Volts DC, 4.0 A
Charging	
Standard Charge	2200mAh / 8.1Wh - 6 hours for a fully depleted battery 3300mAh / 12.2Wh - 9 hours for a fully depleted battery
Status LEDs	Green: charged Red: charging
Agency Approvals	
Power Supply	UL listed TUV licensed Power Supply compliant to FCC part 15, Class B
Charging	CE Marking CISPR Pub 22
Fire Retardant	UL94 V-0

Customer Support

Technical Assistance

If you need assistance installing or troubleshooting your device, please contact us by using one of the methods below:

Knowledge Base: www.hsmknowledgebase.com

Our Knowledge Base provides thousands of immediate solutions. If the Knowledge Base cannot help, our Technical Support Portal (see below) provides an easy way to report your problem or ask your question.

Technical Support Portal: www.hsmsupportportal.com

The Technical Support Portal not only allows you to report your problem, but it also provides immediate solutions to your technical issues by searching our Knowledge Base. With the Portal, you can submit and track your questions online and send and receive attachments.

Web form: www.hsmcontactsupport.com

You can contact our technical support team directly by filling out our online support form. Enter your contact details and the description of the question/problem.

Telephone: www.honeywellaidc.com/locations

For our latest contact information, please check our website at the link above.

Product Service and Repair

Honeywell International Inc. provides service for all of its products through service centers throughout the world. To obtain warranty or non-warranty service, please visit www.honeywellaidc.com and select **Support > Contact Service and Repair** to see your region's instructions on how to obtain a Return Material Authorization number (RMA #). You should do this prior to returning the product.

For ongoing and future product quality improvement initiatives, the Dolphin 6110 comes equipped with an embedded device lifetime counter function. Honeywell may use lifetime counter data for future statistical reliability analysis as well as ongoing quality, repair and service purposes.

Limited Warranty

Honeywell International Inc. ("HII") warrants its products and optional accessories to be free from defects in materials and workmanship and to conform to HII's published specifications applicable to the products purchased at the time of shipment. This warranty does not cover any HII product which is (i) improperly installed or used; (ii) damaged by accident or negligence, including failure to follow the proper maintenance, service, and cleaning schedule; or (iii) damaged as a result of (A) modification or alteration by the purchaser or other party, (B) excessive voltage or current supplied to or drawn from the interface connections, (C) static electricity or electro-static discharge, (D) operation under conditions beyond the specified operating parameters, or (E) repair or service of the product by anyone other than HII or its authorized representatives.

This warranty shall extend from the time of shipment for the duration published by HII for the product at the time of purchase ("Warranty Period"). Any defective product must be returned (at purchaser's expense) during the Warranty Period to HII factory or authorized service center for inspection. No product will be accepted by HII without a Return Materials Authorization, which may be obtained by contacting HII. In the event that the product is returned to HII or its authorized service center within the Warranty Period and HII determines to its satisfaction that the product is defective due to defects in materials or workmanship, HII, at its sole option, will either repair or replace the product without charge, except for return shipping to HII.

EXCEPT AS MAY BE OTHERWISE PROVIDED BY APPLICABLE LAW, THE FOREGOING WARRANTY IS IN LIEU OF ALL OTHER COVENANTS OR WARRANTIES, EITHER EXPRESSED OR IMPLIED, ORAL OR WRITTEN, INCLUDING, WITHOUT LIMITATION, ANY IMPLIED WARRANTIES OF MERCHANTABILITY OR FITNESS FOR A PARTICULAR PURPOSE, OR NON-INFRINGEMENT.

HII'S RESPONSIBILITY AND PURCHASER'S EXCLUSIVE REMEDY UNDER THIS WARRANTY IS LIMITED TO THE REPAIR OR REPLACEMENT OF THE DEFECTIVE PRODUCT WITH NEW OR REFURBISHED PARTS. IN NO EVENT SHALL HII BE LIABLE FOR INDIRECT, INCIDENTAL, OR CONSEQUENTIAL DAMAGES, AND, IN NO EVENT, SHALL ANY LIABILITY OF HII ARISING IN CONNECTION WITH ANY PRODUCT SOLD HEREUNDER (WHETHER SUCH LIABILITY ARISES FROM A CLAIM BASED ON CONTRACT, WARRANTY, TORT, OR OTHERWISE) EXCEED THE ACTUAL AMOUNT PAID TO HII FOR THE PRODUCT. THESE LIMITATIONS ON LIABILITY SHALL REMAIN IN FULL FORCE AND EFFECT EVEN WHEN HII MAY HAVE BEEN ADVISED OF THE POSSIBILITY OF SUCH INJURIES, LOSSES, OR DAMAGES. SOME STATES, PROVINCES, OR COUNTRIES DO NOT ALLOW THE EXCLUSION OR LIMITATIONS OF INCIDENTAL OR CONSEQUENTIAL DAMAGES, SO THE ABOVE LIMITATION OR EXCLUSION MAY NOT APPLY TO YOU.

All provisions of this Limited Warranty are separate and severable, which means that if any provision is held invalid and unenforceable, such determination shall not affect the validity of enforceability of the other provisions hereof. Use of any peripherals not provided by the manufacturer may result in damage not covered by this warranty. This includes but is not limited to: cables, power supplies, cradles, and docking stations. HII extends these warranties only to the first end-users of the products. These warranties are non-transferable.

Limited Warranty Duration

- The duration of the limited warranty for terminals with an integrated imager is one year.
- The duration of the limited warranty for touch screens is one year.
- The duration of the limited warranty for Dolphin HomeBase, Dolphin Mobile Mount, Dolphin ChargeBase, Dolphin Mobile Charger, and Dolphin QuadCharger is one year.
- The duration of the limited warranty for batteries is one year.
Use of any battery from a source other than Honeywell may result in damage not covered by the warranty. Batteries returned to Honeywell International Inc. in a reduced state may or may not be replaced under this warranty. Battery life will be greatly increased when following the battery instructions in this user's guide.

How to Extend Your Warranty

Honeywell International Inc. offers a variety of service plans on our hardware products. These agreements offer continued coverage for your equipment after the initial warranty expires. For more information, contact your Sales Representative, Customer Account Representative, or Product Service Marketing Manager from Honeywell International Inc., or your Authorized Reseller.



Honeywell Scanning & Mobility
9680 Old Bailes Road
Fort Mill, SC 29707

www.honeywellaidc.com