



User Guide



HP Smart Tank 530 series

HP company notices

THE INFORMATION CONTAINED HEREIN IS SUBJECT TO CHANGE WITHOUT NOTICE.

ALL RIGHTS RESERVED. REPRODUCTION, ADAPTATION, OR TRANSLATION OF THIS MATERIAL IS PROHIBITED WITHOUT PRIOR WRITTEN PERMISSION OF HP, EXCEPT AS ALLOWED UNDER THE COPYRIGHT LAWS. THE ONLY WARRANTIES FOR HP PRODUCTS AND SERVICES ARE SET FORTH IN THE EXPRESS WARRANTY STATEMENTS ACCOMPANYING SUCH PRODUCTS AND SERVICES. NOTHING HEREIN SHOULD BE CONSTRUED AS CONSTITUTING AN ADDITIONAL WARRANTY. HP SHALL NOT BE LIABLE FOR TECHNICAL OR EDITORIAL ERRORS OR OMISSIONS CONTAINED HEREIN.

© Copyright 2019 HP Development Company, L.P.

Microsoft and Windows are either registered trademarks or trademarks of Microsoft Corporation in the United States and/or other countries.

Mac, OS X, macOS, and AirPrint are trademarks of Apple Inc., registered in the U.S. and other countries.

ENERGY STAR and the ENERGY STAR mark are registered trademarks owned by the U.S. Environmental Protection Agency.

Android and Chromebook are trademarks of Google LLC.

Amazon and Kindle are trademarks of Amazon.com, Inc. or its affiliates.

iOS is a trademark or registered trademark of Cisco in the U.S. and other countries and is used under license.

Table of contents

1 Get started	1
Printer parts	2
Get to know the ink tank system	4
Control panel features	5
Change the default paper settings detected by printer	8
Paper basics	9
Open the HP printer software	11
Use the HP Smart app to print, scan, and troubleshoot	12
Sleep mode	13
Quiet Mode	14
Auto-Off	16
Schedule On and Off	17
2 Print	18
Load media	19
Print documents	23
Print photos	24
Print envelopes	25
Print using the HP Smart app	26
Print using the maximum dpi	27
Print using a Mac desktop or laptop	28
Print with mobile devices	29
Tips for print success	30
View print job status and manage print jobs (Windows)	32
Customize your printer (Windows)	33
3 Use Web Services	34
What are Web Services?	35
Set up Web Services	36
Print with HP ePrint	37
Use the HP Connected website	38

Remove Web Services	39
4 Copy and scan	40
Copy documents	41
Load original	42
Scan using the HP Smart app	44
Scan using the HP printer software	47
Scan from the printer control panel	49
Scan using Webscan	50
Tips for successful scanning and copying	51
5 Manage ink and printhead	52
Ink levels	53
Refill ink tanks	54
Order ink supplies	57
Print with black ink only	58
Improve print quality	59
Align printheads	61
Clean printheads	62
Clean printer	63
Tips for working with ink and printhead	64
Move printer	65
6 Connect	66
Before you begin	67
To place the printer in setup mode	68
Connect your printer to a wireless network with a router	69
Connect wirelessly to the printer without a router (Wi-Fi Direct)	70
Connect your printer by using the HP Smart app	73
Change wireless settings	74
Connect your printer to your computer with a USB cable (non-network connection)	75
Change from a USB connection to a wireless network	76
Use advanced printer management tools (for networked printers)	77
Tips for setting up and using a networked printer	79
7 Solve a problem	80
Get help with HP online troubleshooting	81
Get more help	82
Get help from the printer control panel	83
Get help from the HP Smart app	84

Jams and paper-feed issues	85
Printhead (cartridge) problem	94
Printing issues	100
Copy issues	103
Scan issues	104
Network and connection issues	105
Printer hardware issues	107
Solve problems using Web Services	108
Restore original factory defaults and settings	109
Maintain the printer	110
HP support	113
Appendix A Technical information	115
Specifications	116
Regulatory notices	118
Environmental product stewardship program	122
Index	130

1 Get started

- [Printer parts](#)
- [Get to know the ink tank system](#)
- [Control panel features](#)
- [Change the default paper settings detected by printer](#)
- [Paper basics](#)
- [Open the HP printer software](#)
- [Use the HP Smart app to print, scan, and troubleshoot](#)
- [Sleep mode](#)
- [Quiet Mode](#)
- [Auto-Off](#)
- [Schedule On and Off](#)

Printer parts

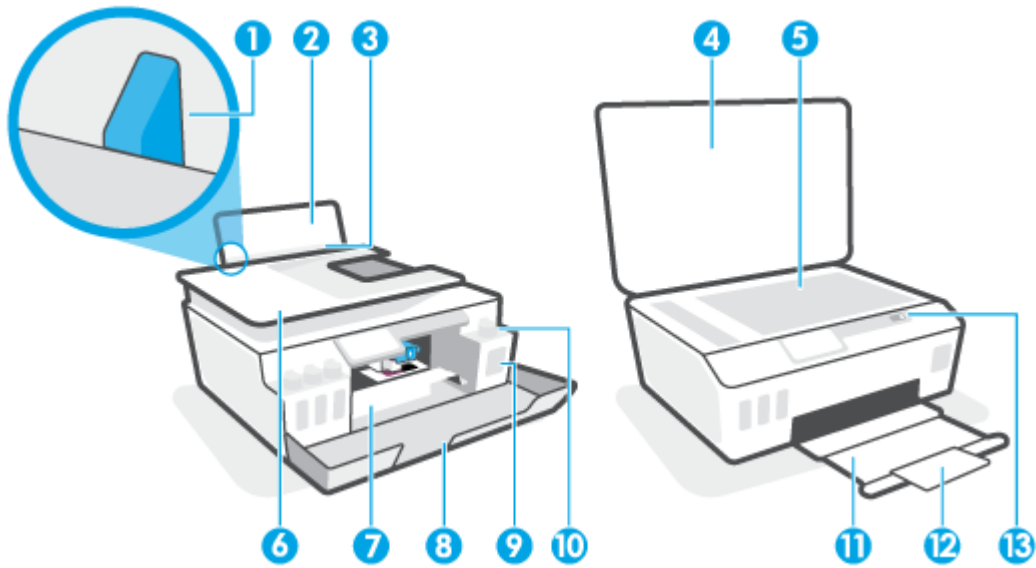

1	Paper-width guide
2	Input tray
3	Input tray shield
4	Scanner lid
5	Scanner glass
6	Document feeder
7	Printhead access door
8	Front door
9	Ink tank
10	Ink tank cap
11	Output tray
12	Output tray extender (also referred to as the tray extender)
13	Control panel

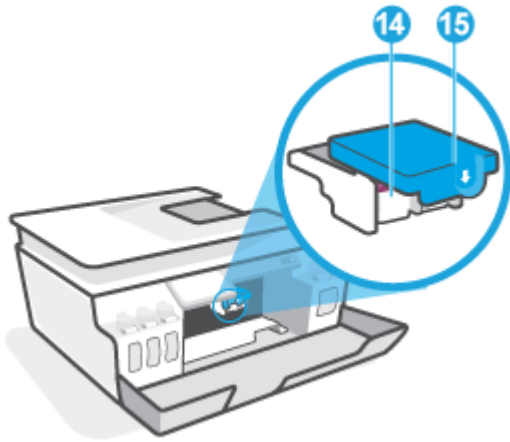

14	Printheads
15	Printhead latch

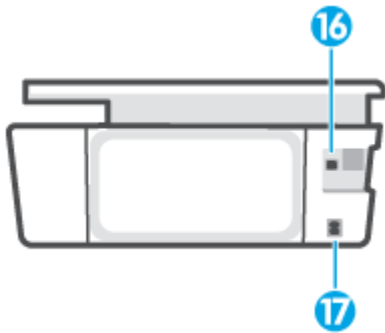

16	USB port
17	Power connection

Get to know the ink tank system

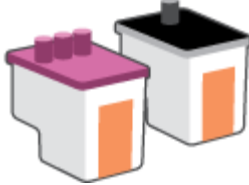
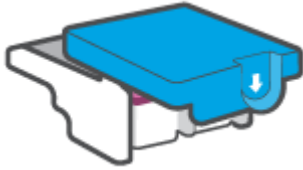
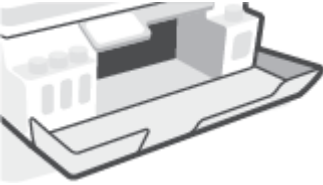
Term	Definition
Printheads	<p>The printheads are the components in the print mechanism that apply ink to the paper. There are two printheads: a black ink printhead and a color ink printhead.</p> <p>CAUTION: After you have set up the printer, do not open the printhead latch unless instructed to do so.</p> 
Printhead latch	<p>The printhead latch on the carriage secures the printheads in the carriage. Make sure the printhead latch is properly closed to avoid problems such as carriage jams.</p> <p>CAUTION: After you have set up the printer, do not open the printhead latch unless instructed to do so.</p> 
Ink tanks	<p>There are four ink tanks. Each ink tank corresponds to an individual color: cyan, magenta, yellow and, black.</p> 
Ink tank caps	<p>Ink tank caps are plugs that seal each ink tank.</p>
Alignment	<p>Alignment is a process of aligning the printheads to improve print quality.</p>

Control panel features





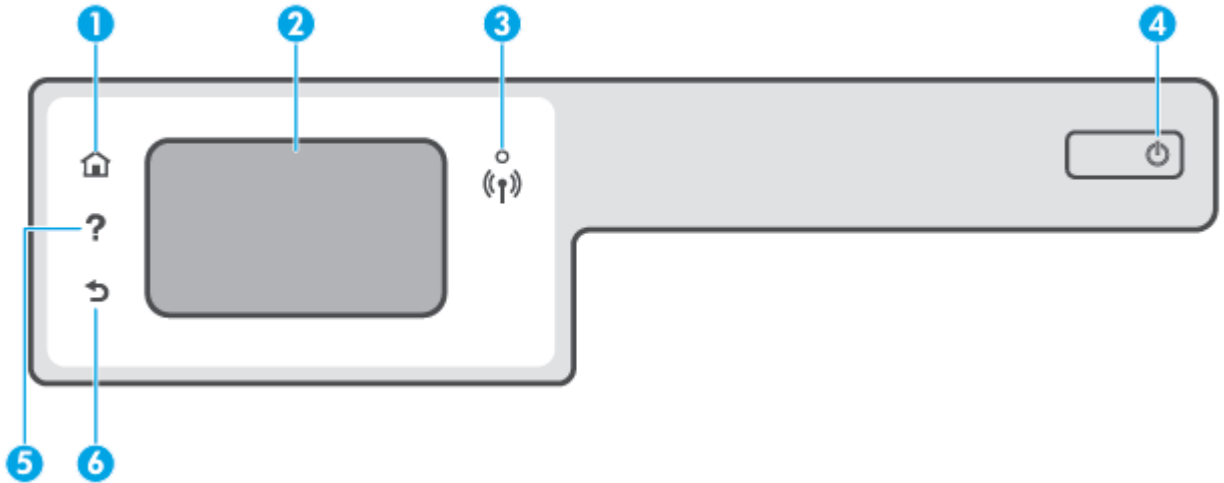

Overview of buttons and lights

The following diagram and related table provides a quick reference to the printer control panel features.



Label	Name and Description
1	Home button: Returns to the Home screen, the screen that is displayed when you first turn on the printer.
2	Control panel display: Touch the screen to select menu options, or scroll through the menu items.
3	Wireless light: Indicates the status of the printer wireless connection. <ul style="list-style-type: none">• Solid blue light indicates that wireless connection has been established and you can print.• Slow blinking light indicates that wireless is on, but the printer is not connected to a network. Make sure your printer is within the range of wireless signal.• Fast blinking light indicates wireless error. Refer to the message on the printer display.• If the wireless light is off, wireless is turned off.
4	Power button: Turns the printer on or off.
5	Help button: Opens the Help menu for the current operation. From the Home screen, opens the Help menu where you can view How To videos, information on printer features, or tips on using printer.
6	Back button: Returns to the previous screen.

Control panel display icons

Icon	Purpose
	Copy : Opens the Copy menu where you can select a copy type or change the copy settings.
	Scan : Opens the Scan menu where you can select a destination for your scan.
	Setup : Opens the Setup menu where you can change preferences and use tools to perform maintenance functions.
	HP ePrint icon: Opens the Web Services Summary menu, where you can check HP ePrint status details, change HP ePrint settings, or print an Info page.
	Wi-Fi Direct icon: Opens the Wi-Fi Direct menu where you can turn on Wi-Fi Direct, turn off Wi-Fi Direct, and display the Wi-Fi Direct name and password.
	Wireless icon: Opens the Wireless Summary menu where you can check wireless status and change wireless settings. You can also print a wireless test report, helping diagnose network connection issues.
	Ink icon: Shows estimated ink levels. Displays a warning symbol if an ink tank is low on ink. NOTE: Ink level alerts and indicators provide estimates for planning purposes only. Refill an ink tank that is low on ink to avoid any printing delay or print quality issue.

Change printer settings

Use the control panel to change the printer function and settings, print reports, or get help for the printer.



 **TIP:** If the printer is connected to a computer, you can also change the printer settings using the printer management tools in computer.

For more information about these tools, see [Use advanced printer management tools \(for networked printers\) on page 77](#).

To change settings for a function

The Home screen of the control panel display shows the available functions for the printer.



1. From the control panel display, on the Home screen, touch the icon of the function that you want to change settings for.
2. After selecting a function, touch  (Settings), scroll through the available settings, and then touch the setting you want to change.
3. Follow the prompts on the control panel display to change the settings.

 **TIP:** Touch  (Home) to return to the Home screen.

To change the printer settings

To change the printer settings or print reports, use the options available on the **Setup** menu.

1. From the Home screen on the printer control panel display, touch  (**Setup**).
2. Swipe up and down the screen to see the available options.
3. Touch the option that you want to change settings for.

 **TIP:** Touch  (Home) to return to the Home screen.

Change the default paper settings detected by printer

The printer can automatically detect whether the input tray is loaded with paper and also detect whether the loaded paper width is large, small, or medium. You can change the default large, medium, or small paper size detected by the printer.



NOTE: When prompted during paper loading, change the paper settings on the printer control panel to match the paper you are using.

To change the default paper settings from the embedded web server

1. Open the embedded web server (EWS). For more information, see [Open the embedded web server on page 77](#).
2. Click the **Settings** tab.
3. From the left menu, click **Preferences**, click **Tray and Paper Management**, and then make the necessary changes.
4. Click **Apply**.

Paper basics

The printer is designed to work well with most types of office paper. It is best to test a variety of print paper types before buying large quantities. Use HP paper for optimum print quality. Visit the HP website at www.hp.com for more information about HP paper.



HP recommends plain papers with the ColorLok logo for printing everyday documents. All papers with the ColorLok logo are independently tested to meet high standards of reliability and print quality, and produce documents with crisp, vivid color, bolder blacks, and that dry faster than ordinary plain papers. Look for papers with the ColorLok logo in a variety of weights and sizes from major paper manufacturers.

This section contains the following topics:

- [Recommended papers for printing](#)
- [Order HP paper supplies](#)

Recommended papers for printing

If you want the best print quality, HP recommends using HP papers that are specifically designed for the type of project you are printing.

Depending on your country/region, some of these papers might not be available.

Photo printing

- **HP Premium Plus Photo Paper**

HP Premium Plus Photo Paper is HP's highest-quality photo paper for your best photos. With HP Premium Plus Photo Paper, you can print beautiful photos that are instant-dry so you can share them right off the printer. It is available in several sizes, including A4, 8.5 x 11 inches, 4 x 6 inches (10 x 15 cm), 5 x 7 inches (13 x 18 cm), and in two finishes - glossy or soft gloss (semi-gloss). Ideal for framing, displaying, or gifting your best photos and special photo projects. HP Premium Plus Photo Paper delivers exceptional results with professional quality and durability.

- **HP Advanced Photo Paper**

This glossy photo paper features an instant-dry finish for easy handling without smudging. It resists water, smears, fingerprints, and humidity. Your prints have a look and feel comparable to a store-processed photo. It is available in several sizes, including A4, 8.5 x 11 inches, 10 x 15 cm (4 x 6 inches), 13 x 18 cm (5 x 7 inches). It is acid-free for longer lasting documents.

- **HP Everyday Photo Paper**

Print colorful, everyday snapshots at a low cost, using paper designed for casual photo printing. This affordable photo paper dries quickly for easy handling. Get sharp, crisp images when you use this paper with any inkjet printer. It is available in glossy finish in several sizes, including A4, 8.5 x 11 inches, 5 x 7 inches, and 4 x 6 inches (10 x 15 cm). It is acid-free for longer lasting documents.

- **HP Photo Value Packs**

HP Photo Value Packs conveniently package original HP ink cartridges and HP Advanced Photo Paper to save you time and take the guesswork out of printing affordable, lab-quality photos with your HP

printer. Original HP inks and HP Advanced Photo Paper have been designed to work together so your photos are long lasting and vivid, print after print. Great for printing out an entire vacation's worth of photos or multiple prints to share.

Business documents

- **HP Premium Presentation Paper 120g Matte or HP Professional Paper 120 Matt**

This paper is a heavy two-sided matte paper perfect for presentation, proposals, reports, and newsletters. It is heavyweight for an impressive look and feel.

- **HP Brochure Paper 180g Glossy or HP Professional Paper 180 Glossy**

These papers are glossy-coated on both sides for two-sided use. They are the perfect choice for near-photographic reproductions and business graphics for report covers, special presentations, brochures, mailers, and calendars.

- **HP Brochure Paper 180g Matte or HP Professional Paper 180 Matte**

These papers are matte-coated on both sides for two-sided use. They are the perfect choice for near-photographic reproductions and business graphics for report covers, special presentations, brochures, mailers, and calendars.

Everyday printing

All the papers listed for everyday printing feature ColorLok Technology for less smearing, bolder blacks, and vivid colors.

- **HP Bright White Inkjet Paper**

HP Bright White Inkjet Paper delivers high-contrast colors and sharp text. It is opaque enough for two-sided color usage with no show-through, which makes it ideal for newsletters, reports, and flyers.

- **HP Printing Paper**

HP Printing Paper is a high-quality multifunction paper. It produces documents that look and feel more substantial than documents printed on standard multipurpose or copy paper. It is acid-free for longer lasting documents.

- **HP Office Paper**

HP Office Paper is a high-quality multifunction paper. It is suitable for copies, drafts, memos, and other everyday documents. It is acid-free for longer lasting documents.

- **HP Office Recycled Paper**

HP Office Recycled Paper is a high-quality multifunction paper made with 30% recycled fiber.

Order HP paper supplies

The printer is designed to work well with most types of office paper. Use HP paper for optimum print quality.

To order HP papers and other supplies, go to www.hp.com. At this time, some portions of the HP website are available in English only.

HP recommends plain papers with the ColorLok logo for printing and copying of everyday documents. All papers with the ColorLok logo are independently tested to meet high standards of reliability and print quality, and produce documents with crisp, vivid color, bolder blacks and shorter dry-time than ordinary plain papers. Look for papers with the ColorLok logo in a variety of weights and sizes from major paper manufacturers.

Open the HP printer software

You can use the HP printer software to configure the printer settings, check estimated ink levels, order printing supplies, maintain the printer, resolve printing issues, and more. More information about the available printer software options is provided throughout this guide.

After completing the hardware setup, visit 123.hp.com on your computer, if you have not installed the HP printer software.



NOTE:

- If you are using the HP Smart app instead of the printer software, see [Use the HP Smart app to print, scan, and troubleshoot on page 12](#).
 - Each device must have the app or software installed in order to print.
-

After installing the HP printer software, do one of the following:

- **Windows 10:** From the computer desktop, click **Start**, select **HP** from the app list, and then select the icon with the printer name.
- **Windows 7:** From the computer desktop, click **Start**, select **All Programs**, click **HP**, click the folder for the printer, and then select the icon with the printer name.

Use the HP Smart app to print, scan, and troubleshoot

HP Smart helps you to set up, scan, print, share, and manage your HP printer. You can share documents and images through email, text messages, and popular cloud and social media services (such as iCloud, Google Drive, Dropbox, and Facebook). You can also set up new HP printers, as well as monitor and order supplies.



NOTE: The HP Smart app is supported on iOS, Android, Windows 10, OS X 10.11, and macOS 10.12 and later devices. The app might not be available in all languages. Some features might not be available with all printer models.

Get more information about the HP Smart app

For basic instructions on how to print, scan, and troubleshoot using HP Smart, see [Print using the HP Smart app on page 26](#), [Scan using the HP Smart app on page 44](#), and [Get help from the HP Smart app on page 84](#). For more information, you can also visit:

- **iOS/Android:** www.hp.com/go/hpsmart-help
- **Windows:** www.hp.com/go/hpsmartwin-help
- **Mac:** www.hp.com/go/hpsmartmac-help

To install the HP Smart app and connect to your printer

1. To get the HP Smart app, visit 123.hp.com to download and install the app.
Users of iOS, Android, and Windows 10 devices can also get the app from the device's app store.
2. After installation, open the app.
 - **iOS/Android:** From the device desktop or app menu, tap HP Smart.
 - **Windows 10:** From the computer desktop, click **Start**, and then select HP Smart from the app list.
 - **Mac:** From the Launchpad, select the HP Smart app.
3. Connect to your printer. For information, see [Connect your printer by using the HP Smart app on page 73](#).

Sleep mode

- Power usage is reduced while in Sleep mode.
- After initial setup of printer, the printer will enter Sleep mode after 5 minutes of inactivity.
- The Power button light is dimmed and the printer control panel display is off in Sleep mode.
- Pressing any button on the control panel, or sending a print or scan job can wake up the printer from sleep mode.

To change the Sleep mode settings from the Embedded Web Server (EWS)

1. Open the embedded web server (EWS). For more information, see [Open the embedded web server on page 77](#).
2. Click the **Settings** tab.
3. In the **Power Management** section, click **Energy Save Mode**, and select the desired option.
4. Click **Apply**.

To change the Sleep mode settings from the printer control panel

1. From the Home screen on the printer control panel display, touch  (**Setup**).



NOTE: If you do not see the Home screen, touch  (Home).

2. Touch **Power Management**, touch **Sleep Mode**, and then touch the desired option.

Quiet Mode

Quiet Mode slows down printing to reduce overall noise without affecting print quality. Quiet Mode only works for printing with **Normal** print quality on plain paper. To reduce printing noise, turn on Quiet Mode. To print at normal speed, turn Quiet Mode off. Quiet Mode is off by default.

 **NOTE:** In Quiet Mode, if you print on plain paper with the **Draft** or **Best** print quality, or if you print photos or envelopes, the printer works in the same way as when Quiet Mode is off.

To turn Quiet Mode on or off from the printer control panel

1. From the Home screen, touch  (**Setup**).
2. Touch **Quiet Mode**.
3. Touch the toggle button to turn it on or off.

To turn Quiet Mode on or off from the printer software (Windows)

1. Open the HP printer software. For more information, see [Open the HP printer software on page 11](#).
2. Click the **Quiet Mode** tab.

 **NOTE:** The Quiet mode tab is available only if the printer is connected from the HP printer software.

3. Click **On** or **Off**.
4. Click **Save Setting**.

To turn on Quiet Mode while the printer is printing

- ▲ On the printer control panel display, from the printing screen, touch  (Quiet Mode) to turn on Quiet Mode.

 **NOTE:** Quiet Mode is turned on only after the current page is printed and is only used for the current print job.

To create a schedule for Quiet Mode from the printer control panel

1. From the Home screen, touch  (**Setup**).
2. Touch **Quiet Mode**.
3. Touch **Off** next to **Quiet Mode** to turn it on, and then touch **OK** to confirm.
4. Touch **Off** next to **Schedule**, and then change start time and end time of the schedule.

To create a schedule for Quiet Mode from the Embedded Web Server (EWS)

1. Open the EWS. For more information, see [Open the embedded web server on page 77](#).
2. Click the **Settings** tab.
3. From the left menu, click **Preferences**, and then click **Quiet Mode**.

4. Under **Schedule Quiet Mode**, specify the time to turn on Quiet Mode.
5. Click **Apply**.

Auto-Off

This feature turns the printer off after 2 hours of inactivity to help reduce energy use. Auto-Off turns the printer off completely, so you must use the Power button to turn the printer back on.

If your printer supports this energy saving feature, Auto-Off is automatically enabled or disabled depending on printer capabilities and connection options. Even when Auto-Off is disabled, the printer enters Sleep mode after 5 minutes of inactivity to help reduce energy use.

- Auto-Off is enabled when the printer is turned on, if the printer does not have network, fax or Wi-Fi Direct capability, or is not using these capabilities.
- Auto-Off is disabled when a printer's wireless or Wi-Fi Direct capability is turned on or when a printer with fax, USB, or Ethernet network capability establishes a fax, USB, or Ethernet network connection.

 **TIP:** To conserve battery power, you can enable Auto-Off, even when the printer is connected or wireless is turned on.

Schedule On and Off

This feature turns the printer off after 2 hours of inactivity to help reduce energy use. Auto-Off turns the printer off completely, so you must use the Power button to turn the printer back on.

Use the following instructions to schedule the day and time for On and Off.

1. From the Home screen of the printer control panel display, touch  (**Setup**).



NOTE: If you do not see the Home screen, touch  (Home).

2. Touch **Power Management**, touch **Schedule Printer On/Off**.
3. Touch **Off** next to **Schedule On** or **Schedule Off** to turn the feature on, and then follow the onscreen instructions to set the day and time to turn on or turn off the printer.



CAUTION: Always turn the printer off properly, using either **Schedule Off** or  (the Power button) located on the printer.

If you improperly turn the printer off, the print carriage might not return to the correct position, causing problems with the printheads and print quality issues.

2 Print

- [Load media](#)
- [Print documents](#)
- [Print photos](#)
- [Print envelopes](#)
- [Print using the HP Smart app](#)
- [Print using the maximum dpi](#)
- [Print using a Mac desktop or laptop](#)
- [Print with mobile devices](#)
- [Tips for print success](#)
- [View print job status and manage print jobs \(Windows\)](#)
- [Customize your printer \(Windows\)](#)

Load media

 **NOTE:** When prompted, change the paper settings on the printer control panel to match the paper you are using.

To load paper

1. Raise the input tray.



2. Slide the paper-width guide to the left.

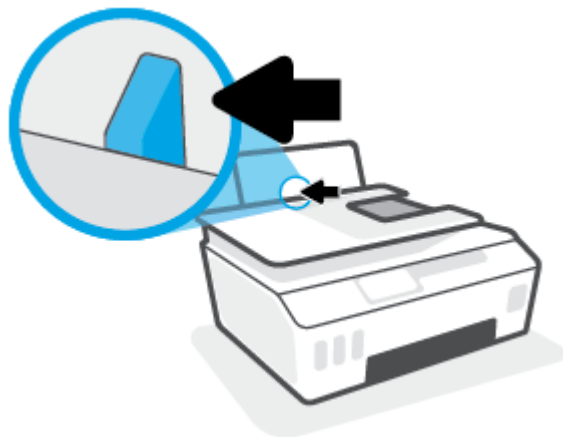

3. Insert a stack of paper into the input tray with the short edge down and the print-side up, and slide the stack of paper down until it stops.

If you are loading small-size paper (like photo paper), make sure the paper stack is aligned with the far-right side of the tray.



4. Slide the paper-width guide to the right until it stops at the edge of the paper.

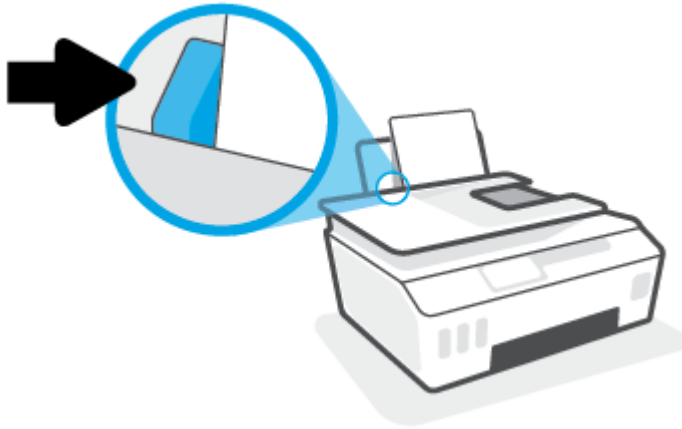

5. Pull out the output tray and the tray extender.



To load envelopes

1. Raise the input tray.



2. Slide the paper-width guide to the left.

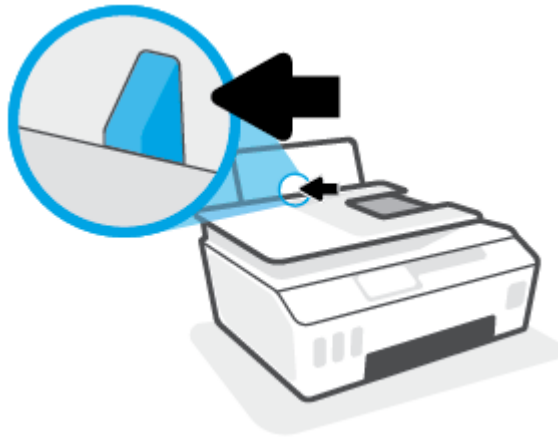

3. Insert one or more envelopes into the far-right side of the input tray and slide the stack of envelopes down until it stops.

The side to be printed on should face up.

- a. For envelope with flap on the long edge, insert the envelope vertically with the flap on the left side and facing down.

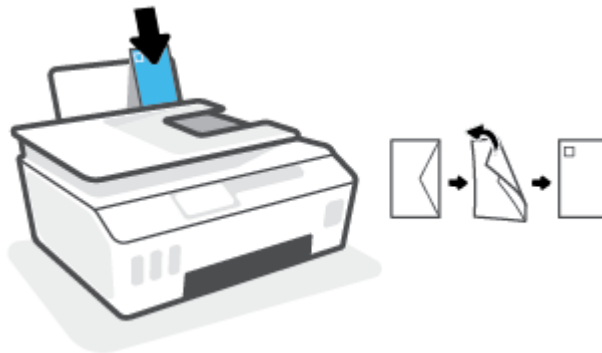

- b. For envelope with the flap on the short edge, insert the envelope vertically with the flap on the top and facing down.

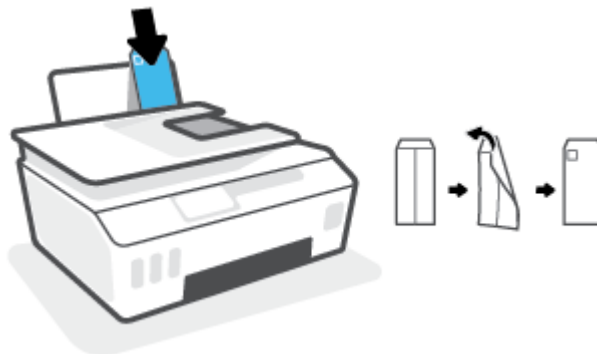

4. Slide the paper-width guide to the right against the stack of envelopes until it stops.

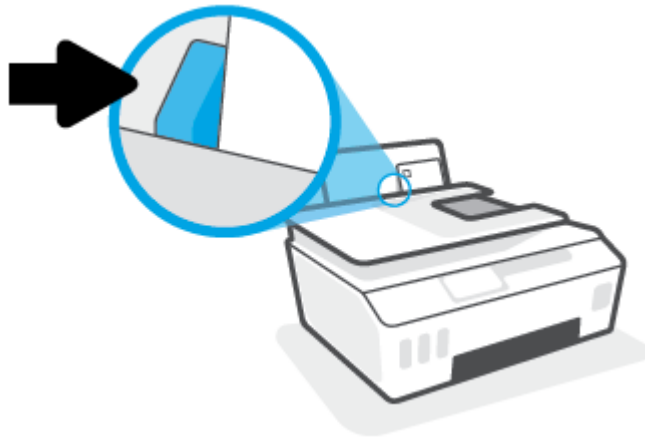

5. Pull out the output tray and the tray extender.



Print documents

Before printing documents, make sure you have paper loaded in the input tray and the output tray is open. For more information about loading paper, see [Load media on page 19](#).

To print a document (Windows)

1. From the **File** menu in your software, select **Print**.
2. Make sure your printer is selected.
3. Click the button that opens the **Properties** dialog box.

Depending on your software application, this button might be called **Properties**, **Options**, **Printer Setup**, **Printer Properties**, **Printer**, or **Preferences**.

4. Select the appropriate options on the **Printing Shortcuts** or **Printing Shortcut** tab.

To change other print settings, click the other tabs.

To learn more about the options in the printer driver, hover your mouse over each option to view the tooltips.



NOTE: If you change the paper size, be sure to load the correct paper in the input tray.

5. Click **OK** to close the **Properties** dialog box.
6. Click **Print** or **OK** to begin printing.

To print on both sides of the page (Windows)

1. From the **File** menu in your software, select **Print**.
2. Make sure your printer is selected.
3. Click the button that opens the **Properties** dialog box.

Depending on your software application, this button might be called **Properties**, **Options**, **Printer Setup**, **Printer Properties**, **Printer**, or **Preferences**.

4. On the **Printing Shortcuts** or **Printing Shortcut** tab, select the **Two-sided (Duplex) Printing** shortcut, and then select an option from the **Print On Both Sides Manually** drop-down list.

To change other print settings, click the other tabs.

To learn more about the options in the printer driver, hover your mouse over each option to view the tooltips.



NOTE: If you change the paper size, be sure to load the correct paper in the input tray.

5. Click **OK** to close the **Properties** dialog box.
6. Click **Print** or **OK** to begin printing.

Print photos

Before printing photos, make sure you have photo paper loaded in the input tray and the output tray is open. For more information about loading paper, see [Load media on page 19](#).

To print a photo on photo paper (Windows)

1. From the **File** menu in your software, select **Print**.
2. Make sure your printer is selected.
3. Click the button that opens the **Properties** dialog box.

Depending on your software application, this button might be called **Properties**, **Options**, **Printer Setup**, **Printer Properties**, **Printer**, or **Preferences**.

4. Select the appropriate options on the **Printing Shortcuts** or **Printing Shortcut** tab.

To change other print settings, click the other tabs.

To learn more about the options in the printer driver, hover your mouse over each option to view the tooltips.



NOTE: If you change the paper size, be sure to load the correct paper in the input tray.

5. Click **OK** to close the **Properties** dialog box.
6. Click **Print** or **OK** to begin printing.



NOTE: After the printing is finished, remove unused photo paper from the input tray. Store the photo paper so it does not start to curl, which could reduce the quality of your printout.

Print envelopes

Before printing envelopes, make sure you have envelopes loaded in the input tray and the output tray is open. You can load one or more envelopes into the input tray. Do not use shiny or embossed envelopes or envelopes that have clasps or windows. For more information about loading envelopes, see [Load media on page 19](#).



NOTE: For details on how to format text for printing on envelopes, refer to the documentation of the application that you are using.

To print an envelope (Windows)

1. From the **File** menu in your software, select **Print**.
2. Make sure your printer is selected.
3. Click the button that opens the **Properties** dialog box.

Depending on your software application, this button might be called **Properties**, **Options**, **Printer Setup**, **Printer Properties**, **Printer**, or **Preferences**.

4. Select the appropriate options on the **Printing Shortcuts** or **Printing Shortcut** tab.

To change other print settings, click the other tabs.

To learn more about the options in the printer driver, hover your mouse over each option to view the tooltips.



NOTE: If you change the paper size, be sure to load the correct paper in the input tray.

5. Click **OK** to close the **Properties** dialog box.
6. Click **Print** or **OK** to begin printing.

Print using the HP Smart app

This section provides basic instructions for using the HP Smart app to print from your iOS, Android, Windows, and Mac devices. For more information about the app, see [Use the HP Smart app to print, scan, and troubleshoot on page 12](#).

To begin using the HP Smart app to print

1. Load paper in the input tray. For more information, see [Load media on page 19](#).
2. Open the HP Smart app on your device.
3. On the Home screen of HP Smart, make sure your printer is selected.

 **TIP:** If a printer is already set up, you can select it from the Home screen of HP Smart by swiping left or right and selecting it.

To use a different printer, click or tap **+** (Plus icon) on the Home screen, and then select a different printer or add a new printer.

To print from Android or iOS device

1. On the Home screen of HP Smart, tap a printing option (for example, **Print Photos** or **Print Facebook Photos**, etc.). You can print photos and documents from your device, cloud storage, or social media sites.
2. Select the photo or document you want to print.
3. Tap **Print**.

To print from a Windows 10 device

1. On the Home screen of HP Smart, do one of the following:
 - Select **Print Photo**, locate a photo you want to print, and then click or tap **Select Photos to Print**.
 - Select **Print Document**, locate a PDF document you want to print, and then click or tap **Print**.
2. Select the appropriate options. To view more settings, click or tap **More settings**.

For more information about printing settings, see [Tips for print success on page 30](#).
3. Click or tap **Print** to begin printing.

To print from a Mac device

1. On the Home screen of HP Smart, click **Print** tile, and then click **Print Document** or **Print Photo**.
2. Locate the document or photo in the Documents folder or Pictures library, or browse to another folder where the file is saved.
3. Select the document or photo you want, and then click **Print**.
4. Select a different printer or make any changes to the print settings, such as paper size or output quality.
5. Click **Print**.

Print using the maximum dpi

Use maximum dots per inch (dpi) to print high-quality, sharp images on photo paper.

Printing in maximum dpi takes longer than printing with other settings and requires a large amount of disk space.

For supported print resolutions, visit the printer support website at www.support.hp.com.

To print in maximum dpi mode (Windows)

1. From your software, select **Print**.
2. Make sure your printer is selected.
3. Click the button that opens the **Properties** dialog box.

Depending on your software application, this button might be called **Properties**, **Options**, **Printer Setup**, **Printer Properties**, **Printer**, or **Preferences**.

4. Select the appropriate options.

Windows 10

- Click the **Paper/Quality** tab. From the **Paper Size** drop-down list, select the appropriate paper size. From the **Paper Type** drop-down list, select the appropriate paper type.
- Click the **Advanced** tab, and then select **Print in Max DPI**.

Windows 7

- Click the **Paper/Quality** tab. From the **Media** drop-down list, select the appropriate paper type.
- Click the **Advanced** button. Select the appropriate paper size from the **Paper Size** drop-down list. In the **Printer Features** area, select **Yes** from the **Print in Max DPI** drop-down list. Then click **OK** to close the **Advanced Options** dialog.

For more printing tips, see [Printer settings tips on page 30](#).

5. Confirm the orientation on the **Layout** tab, and then click **OK** to print.

Print using a Mac desktop or laptop

Instructions for HP AirPrint-compatible printers and Mac computers with OS X 10.11 and macOS 10.12 and later.

Printer connected to network

If your printer is already set up and connected to your wireless network, you can enable printing from a Mac desktop or laptop using the **System Preferences** menu.

1. Open **System Preferences** and select **Printers and Scanners**.
2. Click **Add +** to set up the printer on your Mac. Choose your printer from the displayed list of network printers, then click **Add**. This will install the available print, and scan drivers for your printer.

These instructions let you print from your Mac. Continue to use the HP Smart app to monitor ink levels and printer alerts.

Printer not connected to network

- ▲ If you have not set up or connected your printer to your network, go to 123.hp.com to install the necessary software.

Print with mobile devices

Print from mobile devices

You can print documents and photos directly from your mobile devices, including iOS, Android, Windows Mobile, Chromebook and Amazon Kindle.

 **NOTE:** You can also use the HP Smart app to print from mobile devices. For more information, see [Print using the HP Smart app on page 26](#).

To print from mobile devices

1. Make sure the device you are using to connect the printer is connected to the same network you want to connect the printer to.

 **TIP:** If you want to print without connecting to a router, use Wi-Fi Direct to print from mobile device. For more information, see [Connect wirelessly to the printer without a router \(Wi-Fi Direct\) on page 70](#).

2. Enable printing on your mobile device:

- **iOS:** Use the **Print** option from the **Share** menu.

 **NOTE:** Devices running iOS 4.2 or later have AirPrint® preinstalled.

- **Android:** Download the HP Print Service Plugin (supported by Android 4.4 devices and later) from the Google Play Store and enable it on your device.
- **Windows Mobile:** Tap **Print** from the **Device** menu. No setup is required since the software is preinstalled.

 **NOTE:** If your printer is not listed, you might need to do a one-time setup of the printer using the **Add Printer** wizard.

- **Chromebook:** Download and install the **HP Print for Chrome** app from the Chrome Web Store to enable both Wi-Fi and USB printing.
- **Amazon Kindle Fire HD9 and HDX:** The first time you select **Print** on your device, the HP Print Service Plugin is automatically downloaded to enable mobile printing.

 **NOTE:** For detailed information about enabling printing from your mobile devices, visit the HP Mobile Printing website (www.hp.com/go/mobileprinting). If a local version of this website is not available in your country/region or language, you might be directed to the HP Mobile Printing website in another country/region or language.

3. Make sure the loaded paper matches the paper settings of the printer (see [Load media on page 19](#) for more information).

Accurately setting the paper size for the paper that is loaded enables your mobile device to know what paper size it is printing.

 **NOTE:** To change the default paper settings, see [Change the default paper settings detected by printer on page 8](#).

Tips for print success

- [Paper loading tips](#)
- [Printer settings tips](#)

To print successfully, the HP printheads should be functioning properly, the ink tanks should be filled with sufficient ink, the paper should be loaded correctly, and the printer should have the appropriate settings. For more information, see [Tips for working with ink and printhead on page 64](#).

Print settings do not apply to copying or scanning.

Paper loading tips

- Load a stack of paper (not just one page). All of the paper in the stack should be in the same size and type to avoid a paper jam.
- Load the paper with side to be printed on facing up.
- Ensure that paper loaded in the input tray lays flat, and the edges are not bent or torn.
- Adjust the paper-width guide in the input tray to fit snugly against all paper. Make sure the paper-width guide does not bend the paper in the input tray.

For more information, see [Load media on page 19](#).

Printer settings tips

Printer settings tips (Windows)

- To change default print settings, open the HP printer software, click **Print & Scan**, and then click **Set Preferences**. For information how to open the printer software, see [Open the HP printer software on page 11](#).

 **TIP:** To learn more about the options in the printer driver, hover your mouse over each option to view the tooltips.

- You can use printing shortcuts to save time setting desired printing preferences. A printing shortcut stores the settings that are appropriate for a particular type of job, so that you can set all the options with a single click. To use a shortcut, go to the **Printing Shortcuts** or **Printing Shortcut** tab, select the desired shortcut, and then click **OK**.

To add a new printing shortcut, set the desired printing preferences on the **Paper/Quality**, **Layout**, or **Advanced** tab, select the **Printing Shortcuts** or **Printing Shortcut** tab, click **Save As** and enter a name, and then click **OK**.

To delete a printing shortcut, select it, and then click **Delete**.

 **NOTE:** You cannot delete the default printing shortcuts.

- To understand paper and paper tray settings:
 - **Paper Size:** Select the paper size you loaded in the input tray.
 - **Paper Source:** Select the paper tray you loaded the paper into.
 - **Paper Type or Media:** Select the paper type you are using.

- To understand color or black and white settings:
 - **Color:** Uses black and color ink for full color prints.
 - **Black & White** or **Black Ink Only:** Uses the black ink only for normal or lower quality black and white prints.
 - **High Quality Grayscale:** Uses black and color ink to produce a wider range of black and grey tones for high quality black and white prints.

- To understand print quality settings:

The print quality is measured in print resolution dots per inch (dpi). Higher dpi produces clearer and more detailed prints, but slows print speed and might use more ink.

 - **Draft:** Lowest dpi typically used when ink levels are low or when high quality prints are not needed.
 - **Normal:** Suitable for most print jobs.
 - **Best:** Better dpi than **Normal**.
 - **Print in Max DPI:** Highest dpi setting available for print quality.
 - **HP Real Life Technologies:** This feature smooths and sharpens images and graphics for improved print quality.

- To understand page and layout settings:
 - **Orientation:** Select **Portrait** for vertical prints or **Landscape** for horizontal prints.
 - **Print on Both Sides Manually:** Manually flip the pages after one side of the paper prints out so that you can print on both sides of the paper.
 - **Flip on Long Edge:** Select it if you want to flip pages by the long edge of the paper when printing on both sides of the paper.
 - **Flip on Short Edge:** Select it if you want to flip pages by the short edge of the paper when printing on both sides of the paper.
 - **Booklet Layout** or **Booklet:** Allows you to print a multiple-page document as a booklet. It places two pages on each side of a sheet that can then be folded into a booklet in half size of the paper.
 - **Left binding** or **Booklet-LeftBinding:** The binding side after folded into a booklet appears at the left side. Select this option if your reading habit is from left to right.
 - **Right binding** or **Booklet-RightBinding:** The binding side after folded into a booklet appears at the right side. Select this option if your reading habit is from right to left.
 - **Borderless** or **Page Borders:** Allows you to add or remove borders to the pages if you print the document with two or more pages per sheet.
 - **Pages per Sheet Layout:** Helps you specify the order of the pages if you print the document with more than two pages per sheet.
 - **Pages to Print:** Allows you to print the odd pages only, print the even pages only, or print all pages.
 - **Reverse page order** or **Page Order:** Allows you to print pages from front to back or in reverse order.

View print job status and manage print jobs (Windows)

To view, pause, or cancel your print jobs, open the HP printer software (available from the **Start** menu), click **Print & Scan** , and then click **See What's Printing**.

Customize your printer (Windows)

To change the printer name, security settings, or other properties, open the HP printer software (available from the **Start** menu), click **Print & Scan** , and then click **Customize Your Printer**.

3 Use Web Services

- [What are Web Services?](#)
- [Set up Web Services](#)
- [Print with HP ePrint](#)
- [Use the HP Connected website](#)
- [Remove Web Services](#)

What are Web Services?

HP ePrint

- HP ePrint is a free service from HP that allows you to print to your HP ePrint-enabled printer anytime, from any location. It's as simple as sending an email to the email address assigned to your printer when you enable Web Services on the printer. No special drivers or software are needed. If you can send an email, you can print from anywhere, using HP ePrint.

Once you have signed up for an account on HP Connected (www.hpconnected.com ; might not be available in all countries/regions), you can sign in to customize your printer's HP ePrint email address, control who can use the email address to print, and get help for HP ePrint.

Set up Web Services

Before you set up Web Services, make sure your printer is connected to the Internet using a wireless connection.

To set up Web Services using the printer control panel

1. From the Home screen of the printer control panel display, touch  (**Setup**).
2. Touch **Web Services**.
3. Touch **Yes** to accept the Web Services terms of setup.
4. Touch **OK** when you see Web Services have been set up successfully.

When the printer is connected to the server, the printer prints an information page, and shows Web Services Summary on the screen.

To set up Web Services using the embedded web server

1. Open the embedded web server (EWS). For more information, see [Open the embedded web server on page 77](#).
2. Click the **Web Services** tab.
3. In the **Web Services Settings** section, click **Setup**, click **Continue**, and follow the onscreen instructions to accept the terms of use.

 **NOTE:** If prompted for proxy settings and if your network uses proxy settings, follow the on-screen instructions to set up a proxy server. If you do not have the proxy details, contact your network administrator or the person who set up the network.

4. When the printer is connected to the server, the printer prints an information page. Follow the instructions on the information page to finish the setup.

Print with HP ePrint

HP ePrint allows you to print to your HP ePrint-enabled printer anytime, from any location.

Before you can use HP ePrint, make sure the printer is connected to an active network providing Internet access.

To find the HP ePrint email address

1. From the Home screen of the printer control panel display, touch  (**Setup**).
2. Touch **Web Services**.
3. Touch **Display Email Address**.

 **NOTE:** Touch **Print** to print an information page that contains the printer code and instructions on how to customize the email address.

To print a document using HP ePrint

1. Make sure you have set up Web Services.
For more information, see [Set up Web Services on page 36](#).
2. Email your document to the printer.
 - a. On your computer or mobile device, open your email application.

 **NOTE:** For information about using the email application on your computer or mobile device, see the documentation provided with the application.



- b. Create a new email and attach the document to print.
- c. Send the email to the printer email address.

The printer prints the attached document.

 **NOTE:** The email will be printed once it is received. As with any email, there is no guarantee when or whether it will be received. You can check the print status on HP Connected (www.hpconnected.com). This site might not be available in all countries/regions.

 **NOTE:** Documents printed with HP ePrint may appear different from the original. Style, formatting, and text flow may differ from the original document. For documents that need to be printed with a higher quality (such as legal documents), we recommend that you print from the software application on your computer, where you will have more control over what your printout looks like.

To turn off HP ePrint

1. From the Home screen of the printer control panel display, touch  (HP ePrint), and then touch  (Web Services Settings).
2. Touch the toggle button next to **HP ePrint** to turn it off.

 **NOTE:** To remove all Web Services, see [Remove Web Services on page 39](#).

 [Click here to go online for more information.](#)

Use the HP Connected website



Use HP's free HP Connected website to set up increased security for HP ePrint, and specify the email addresses that are allowed to send email to your printer. You can also get product updates, and other free services.

Go to the HP Connected website (might not be available in all countries/regions) for more information and specific terms and conditions: www.hpconnected.com.

Remove Web Services

Use the following instructions to remove Web Services.

To remove Web Services using the printer control panel

1. From the Home screen of the printer control panel display, touch  (HP ePrint), and then touch  (Web Services Settings).
2. Touch **Remove Web Services**.

To remove Web Services using the embedded web server

1. Open the embedded web server (EWS). For more information, see [Open the embedded web server on page 77](#).
2. Click the **Web Services** tab.
3. From the left menu, click **Web Services Settings**, click **Remove Web Services**, and then follow the on-screen instructions.

4 Copy and scan

- [Copy documents](#)
- [Load original](#)
- [Scan using the HP Smart app](#)
- [Scan using the HP printer software](#)
- [Scan from the printer control panel](#)
- [Scan using Webscan](#)
- [Tips for successful scanning and copying](#)

Copy documents





NOTE: All documents are copied in normal quality print mode. You cannot change the print mode quality when copying.

You can also use the HP Smart app to copy from your mobile device. For information about this app, see [Use the HP Smart app to print, scan, and troubleshoot on page 12](#).

To copy documents

1. Load paper in the input tray.

For information about how to load paper, see [Load media on page 19](#).

2. Load the original print-side up into the document feeder, or load the original print side down near the icon at the corner of the scanner glass.
3. From the Home screen of the printer control panel display, touch **Copy**.
4. Specify the desired number of copies. Do either of the following to specify the number:
 - Select a number in the spinner. You can swipe left or right in the spinner to increase or decrease the number.
 - Touch the keypad button on the right side of the spinner to enter a specific number.
5. Touch  (Settings) to specify paper size, paper type, quality, or other settings.
6. Touch  (Back) to return to the Copy menu.
7. Touch **Start Black** or **Start Color** to start the copy job.

Load original

To load an original on the scanner glass

1. Lift the scanner lid.



2. Load the original print-side down near the icon at the corner of the scanner glass.

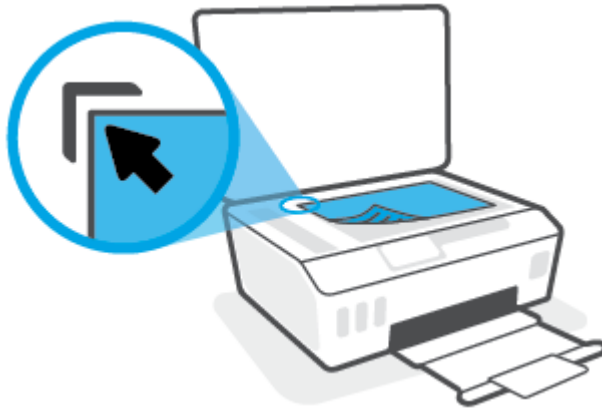

3. Close the scanner lid.

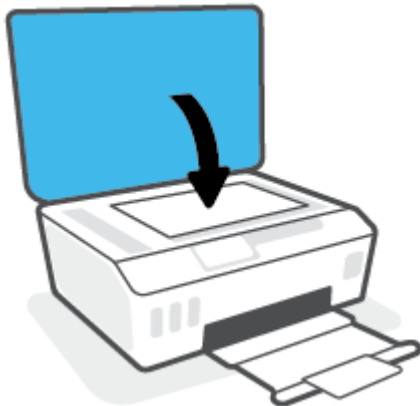

To load an original in the document feeder

1. Slide paper-width guides outwards.



2. Load original print-side up in the document feeder.



3. Slide paper-width guides inward until they stop at the edge of paper.



Scan using the HP Smart app

This section provides basic instructions for using the HP Smart app to scan from your iOS, Android, Windows, and Mac devices. For more information about the app, see [Use the HP Smart app to print, scan, and troubleshoot on page 12](#).

You can use the HP Smart app to scan documents or photos from the printer's scanner, and you can also scan using your device camera. HP Smart includes editing tools that allow you to adjust the scanned image before saving or sharing. You can print, save your scans locally or in cloud storage, and share them via email, SMS, Facebook, Instagram, etc. To scan with HP Smart, follow the instructions provided in the appropriate section below, depending on the type of device you are using.

- [Scan from an iOS or Android device](#)
- [Scan from the printer to your Mac device](#)
- [Scan from a Windows 10 device](#)

Scan from an iOS or Android device

1. Open the HP Smart app on your device.
2. On the Home screen of HP Smart, make sure your printer is selected.

 **TIP:** If a printer is already set up, you can select it from the Home screen of HP Smart by swiping left or right and selecting it.

To use a different printer, click or tap **+** (Plus icon) on the Home screen, and then select a different printer or add a new printer.

3. Tap the scanning option you want to use.
 - If you are using the device camera, make sure you are in a well-lit area, and the photo or document does not blend in with the surface it rests on.
 - If you are using the printer scanner, tap the **Settings** icon to select the input source and change the scan settings, and then tap the **Scan** icon.
 - If you select the option for files and photos, follow onscreen instructions to select the desired file, make the desired changes, and save the changes.
4. When you have finished adjusting the scanned document or photo, save, share, or print it.

Scan from the printer to your Mac device

1. Load the original print-side down near the icon at the corner of the scanner glass on the printer.
2. Open the HP Smart app on your device.
3. On the Home screen of HP Smart app, make sure your printer is selected.
4. Click the **Scan** tile.
5. From the Scan window, make the desired changes, and then click **Scan**.
6. In the scan preview, click **Edit** to make the desired changes, and then apply the changes.
7. Click **Add Pages** to add pages to your scan job, if necessary, and then print, save, or share the scan.

Scan from a Windows 10 device

To scan a document or photo using the printer scanner

1. Load the original print-side down near the icon at the corner of the scanner glass on the printer.
2. Open HP Smart. For more information, see [Use the HP Smart app to print, scan, and troubleshoot on page 12](#).
3. Select **Scan**, and then select **Scanner**.
4. Click or tap the Settings icon to modify the basic settings.
Select Glass from the **Source** drop-down list.
5. Click or tap the Preview icon to preview and adjust the image if necessary.
6. Click or tap the Scan icon.
7. Make other adjustments if necessary:
 - Click or tap **Add Pages** to add more documents or photos.
 - Click or tap **Edit** to rotate or crop the document or image, or adjust its contrast, brightness, saturation, or angle.
8. Select the file type you want, and then click or tap the Save icon to save it or click or tap the Share icon to share it with others.

To scan a document or photo using the device camera

If your device has a camera, you can use the HP Smart app to scan a printed document or photo with the device camera. You can then use HP Smart to edit, save, print or share the image.

1. Open HP Smart. For more information, see [Use the HP Smart app to print, scan, and troubleshoot on page 12](#).
2. Select **Scan**, and then select **Camera**.
3. Put a document or photo in front of the camera, and then click or tap the round button at the bottom of the screen to take an image.
4. Adjust boundaries if needed. Click or tap the Apply icon.
5. Make other adjustments if necessary:
 - Click or tap **Add Pages** to add more documents or photos.
 - Click or tap **Edit** to rotate or crop the document or image, or adjust its contrast, brightness, saturation, or angle.
6. Select the file type you want, and then click or tap the Save icon to save it or click or tap the Share icon to share it with others.

To edit a previously scanned document or photo

HP Smart provides editing tools, such as crop and rotate, which you can use to adjust a previously scanned document or photo on your device.

1. Open HP Smart. For more information, see [Use the HP Smart app to print, scan, and troubleshoot on page 12](#).
2. Select **Scan**, and then select **Import**.
3. Select the document or photo that you want to adjust, and then click or tap **Open**.
4. Adjust boundaries if needed. Click or tap the Apply icon.
5. Make other adjustments if necessary:
 - Click or tap **Add Pages** to add more documents or photos.
 - Click or tap **Edit** to rotate or crop the document or image, or adjust its contrast, brightness, saturation, or angle.
6. Select the file type you want, and then click or tap **Save** or **Share** to save the file or share it with others.

Scan using the HP printer software

- [Scan from a computer](#)
- [Change scan settings \(Windows\)](#)
- [Create a new scan shortcut \(Windows\)](#)

Scan from a computer

Before scanning from a computer, make sure you have already installed the HP recommended printer software. The printer and computer must be connected and turned on.

To scan a document or photo to a file (Windows)

1. Load the original print-side up into the document feeder, or load the original print side down near the icon at the corner of the scanner glass.
2. In the HP printer software (available from the **Start** menu), click **Scan** , and then click **Scan a Document or Photo** .
3. Select the type of scan you want and then click **Scan** .
 - Choose **Save as PDF** to save the document (or photo) as a PDF file.
 - Choose **Save as JPEG** to save the photo (or document) as an image file.



NOTE: Click the **More** link at the top right corner of the Scan dialog to review and modify settings for any scan.

For more information, see [Change scan settings \(Windows\) on page 48](#).

If **Show Viewer After Scan** is selected, you can make adjustments to the scanned image in the preview screen.

To scan a document or photo to email (Windows)

1. Load the original print-side up into the document feeder, or load the original print side down near the icon at the corner of the scanner glass.
2. In the HP printer software, available from the **Start** menu, click **Scan** , and then click **Scan a Document or Photo** .
3. Select the type of scan you want and then click **Scan** .

Choose **Email as PDF** or **Email as JPEG** to open your email software with the scanned file as an attachment.



NOTE: Click the **More** link at the top right corner of the Scan dialog to review and modify settings for any scan.

For more information, see [Change scan settings \(Windows\) on page 48](#).

If **Show Viewer After Scan** is selected, you can make adjustments to the scanned image in the preview screen.

Change scan settings (Windows)

You can modify any of the scan settings either for a singular use or save the changes to use permanently. These settings include options such as page size and orientation, scan resolution, contrast, and the folder location for saved scans.

1. Load the original print-side up into the document feeder, or load the original print side down near the icon at the corner of the scanner glass.
2. In the HP printer software, available from the **Start** menu, click **Scan** , and then click **Scan a Document or Photo** .
3. Click the **More** link in the top right corner of the HP Scan dialog.

The detailed settings pane appears on the right. The left column summarizes the current settings for each section. The right column allows you to change the settings in the highlighted section.

4. Click each section at the left of the detailed settings pane to review the settings in that section.

You can review and change most settings using drop-down menus.

Some settings allow greater flexibility by displaying a new pane. These are indicated by a + (plus sign) at the right of the setting. You must either click **OK** to accept or click **Cancel** to cancel any changes on this pane to return to the detailed settings pane.

5. When you have finished changing settings, do one of the following:
 - Click **Scan** . You are prompted to save or reject the changes to the shortcut after the scan is finished.
 - Click the save icon to the right of the shortcut, and then click **Scan** .

Create a new scan shortcut (Windows)

You can create your own scan shortcut to make scanning easier. For example, you might want to regularly scan and save photos in PNG format, rather than JPEG.

1. Load the original print-side up into the document feeder, or load the original print side down near the icon at the corner of the scanner glass.
2. In the HP printer software, available from the **Start** menu, click **Scan** , and then click **Scan a Document or Photo** .
3. Click **Create New Scan Shortcut** .
4. Enter a descriptive name, choose an existing shortcut on which to base your new shortcut, and then click **Create** .

For example, if you are creating a new shortcut for photos, choose either **Save as JPEG** or **Email as JPEG** . This makes available the options for working with graphics when scanning.

5. Change the settings for your new shortcut to meet your needs, and then click the save icon to the right of the shortcut.



NOTE: Click the **More** link at the top right corner of the Scan dialog to review and modify settings for any scan.

For more information, see [Change scan settings \(Windows\) on page 48](#).

Scan from the printer control panel

To scan an original from the printer control panel

1. Load the original print-side up into the document feeder, or load the original print side down near the icon at the corner of the scanner glass.
2. Touch **Scan** .
3. Touch a computer that you want to scan to.
4. Choose the type of scan you want.
5. Touch **OK**.

Scan using Webscan

Webscan is a feature of the embedded web server that lets you scan photos and documents from your printer to your computer using a web browser.

This feature is available even if you did not install the printer software on your computer.



NOTE: By default, Webscan is off. You can enable this feature from the EWS.

If you are unable to open Webscan in the EWS, your network administrator might have turned it off. For more information, contact your network administrator or the person who set up your network.

To enable Webscan

1. Open the embedded web server. For more information, see [Open the embedded web server on page 77](#).
2. Click the **Settings** tab.
3. In the **Security** section, click **Administrator Settings**.
4. Select **Webscan** to enable Webscan.
5. Click **Apply**.

To scan using Webscan

Scanning using Webscan offers basic scan options. For additional scan options or functionality, scan from the HP printer software.

1. Load the original print-side up into the document feeder, or load the original print side down near the icon at the corner of the scanner glass.

For more information, see [Load original on page 42](#).

2. Open the embedded web server. For more information, see [Open the embedded web server on page 77](#).
3. Click the **Scan** tab.
4. Click **Webscan** in the left pane, change any settings, and then click **Start Scan**.

Tips for successful scanning and copying

Use the following tips to copy and scan successfully:

- Keep the glass and the back of the lid clean. The scanner interprets anything it detects on the glass as part of the image.
- Load the original print-side down near the icon at the corner of the scanner glass.
- To make a large copy of a small original, scan the original into the computer, resize the image in the scanning software, and then print a copy of the enlarged image.
- To avoid incorrect or missing scanned text, make sure the brightness is set appropriately in the software.
- You can also use the HP Smart app to scan from your mobile device. For information about this app, see [Scan using the HP Smart app on page 44](#).
- Make sure to select the correct source (document feeder or scanner glass) for scanning when using HP software.
- When the document feeder is properly loaded with an original, the control panel display will indicate so.

5 Manage ink and printhead

This section contains the following topics:

- [Ink levels](#)
- [Refill ink tanks](#)
- [Order ink supplies](#)
- [Print with black ink only](#)
- [Improve print quality](#)
- [Align printheads](#)
- [Clean printheads](#)
- [Clean printer](#)
- [Tips for working with ink and printhead](#)
- [Move printer](#)

Ink levels

You can check the ink levels from the ink tanks on the printer. You can also check the HP printer software or printer control panel to determine when the tanks need to be refilled.

To check the ink levels from the printer software (Windows)

1. In the HP printer software (available from the **Start** menu), click **Estimated Levels** at the top of the window.
2. In the Toolbox, click the **Estimated Levels** tab.

To check the ink levels from the printer control panel

- From the Home screen, touch  (Ink icon).

Refill ink tanks

 **NOTE:** Product service or repairs required as a result of filling the ink tanks improperly and/or using non-HP ink will not be covered under warranty.

To refill the ink tanks

1. Open the front door.

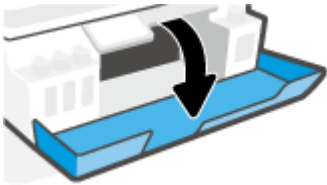

2. Open the cap of the ink tank you plan to refill.

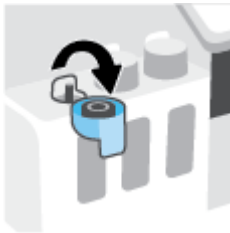

3. Depending on the type of ink bottles you have, do one of following:

- **Screw-cap bottles:** Twist to remove the cap of the ink bottle.



- **Flip-cap bottles:** Twist to remove the cap of the ink bottle, remove the seal from the bottle, install the cap back onto the bottle, and then pull open the top part of the cap.

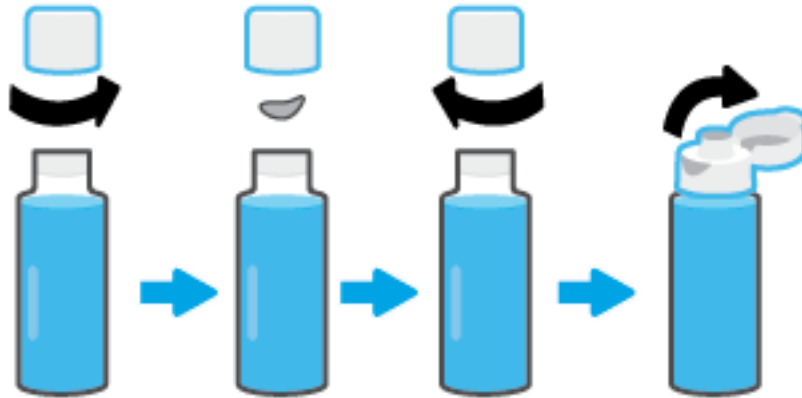

4. Match the color of the ink bottle with the color of the ink tank. Hold the bottle on the tank nozzle, making sure the tip of the bottle fits properly over the nozzle, and let the ink drain into the tank until the tank is full. If the ink does not drain immediately, remove the bottle and properly reinsert it on the tank.

 **NOTE:** Do not squeeze the ink bottles when filling ink. The ink bottles you have might vary.

Screw-cap bottles

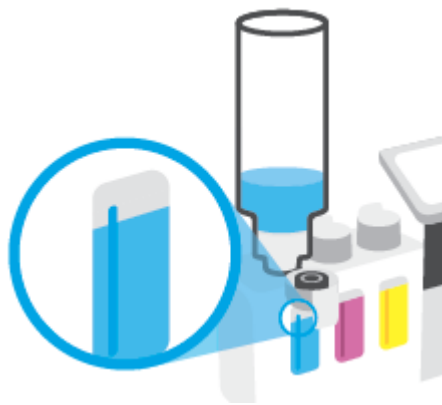

Flip-cap bottles



 **NOTE:** If there is leftover ink in the bottle, store the bottle in an upright position in a cool and dry location.

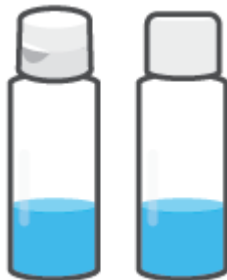

5. Close the ink tank cap securely.

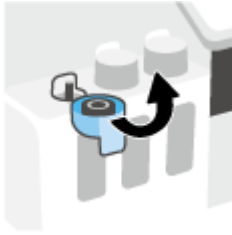

6. Repeat steps 2 to 5 to refill other ink tanks.
7. Close the front door of the printer.

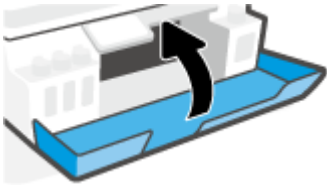

Precautions for working with ink bottles

Use the following tips to work with ink bottles:

- Keep the ink bottles beyond the reach of children.
- Open the ink bottles only when you plan to fill the ink tanks.
- Do not tilt, shake, or squeeze the ink bottle when it is open to prevent ink leaks.
- Store the ink bottles in a cool, dark place.
- Do not drink or place in mouth.

Order ink supplies

Before ordering ink bottles, visually check the labels on the ink bottles to locate the ink bottle numbers. You can also find this information on the product label located on the inside of the front door.

To order original HP supplies for the printer, go to www.hp.com/buy/supplies. If prompted, choose your country/region, and then follow the prompts to find the right ink bottles for your printer.



NOTE: Ordering ink bottles online is not supported in all countries/regions. If it is not available in your country/region, you may still view supplies information and print a list for reference when shopping at a local HP reseller.

Print with black ink only

To print with black ink only(Windows)

1. From your software, select **Print**.
2. Make sure your printer is selected.
3. Click the button that opens the **Properties** dialog box.

Depending on your software application, this button might be called **Properties**, **Options**, **Printer Setup**, **Printer Properties**, **Printer**, or **Preferences**.

4. Select the appropriate options.

Windows 10

- Click **Paper/Quality** tab.
- Under **Print in Grayscale**, select **Black Ink Only** from the list, and then click **OK**.

Windows 7

- On the **Layout** or **Paper/Quality** tab, click the **Advanced** button to open the **Advanced Options** dialog box.
- From the **Print in Grayscale** drop-down list, select **Black Ink Only**, and then click **OK**.

Improve print quality

You can print a diagnostics page to determine if cleaning or aligning the printheads is recommended to improve print quality.

From the HP Smart app, you can also improve the print quality. For more information about the app, see [Use the HP Smart app to print, scan, and troubleshoot on page 12](#).

To print a print quality diagnostics page from the printer display

1. Load Letter or A4 unused plain white paper into the input tray.
2. From the Home screen on the printer control panel display, touch  (**Setup**).
3. Touch **Tools** , and then touch **Print Quality Report**.

To print a print quality diagnostics page (Windows)

1. Load Letter or A4 unused plain white paper into the input tray.
2. In the HP printer software (available from the **Start** menu), click **Print & Scan** at the top of the window.
3. In the **Print** section, click **Maintain Your Printer** to access the Toolbox.
4. In the Toolbox, click the **Device Services** tab, and then click **Print Quality Diagnostics Page**.

5. Review the cyan, magenta, yellow, and black boxes along with the other content on the diagnostics page.

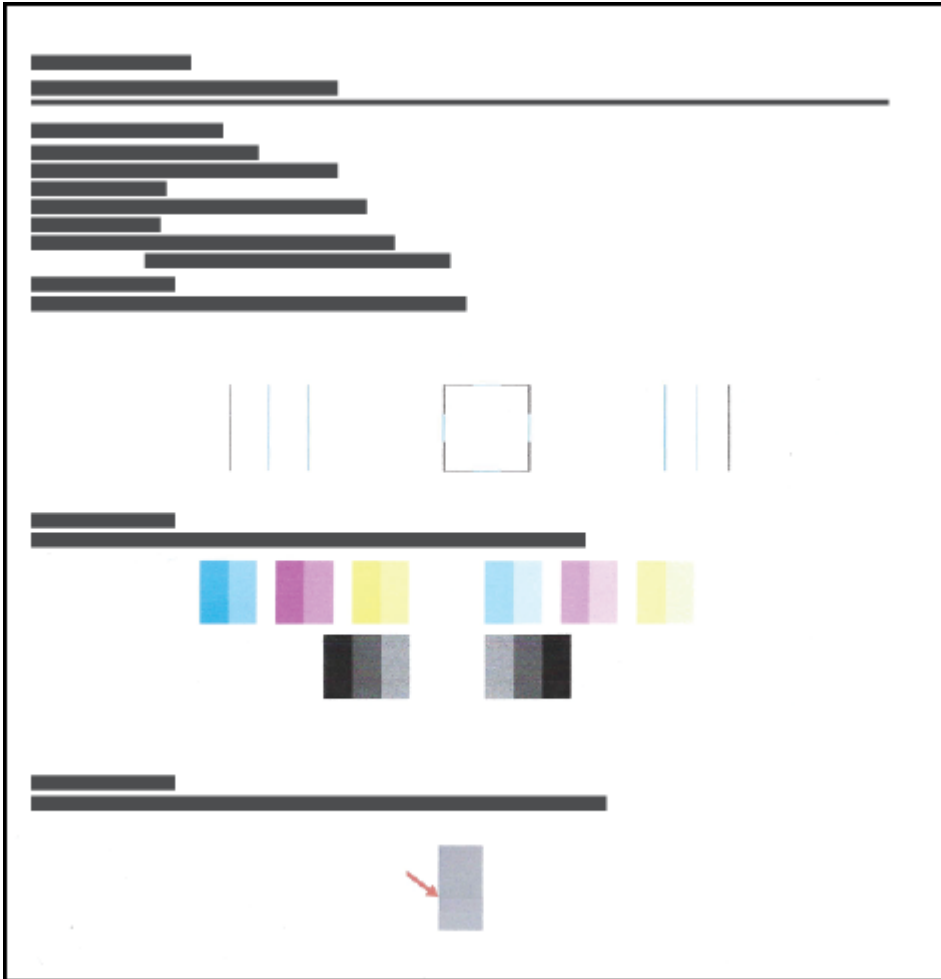

6. Clean the printheads, if the diagnostic page shows streaks or missing portions of the color and black boxes.
For more information, see [Clean printheads on page 62](#).
7. Align the printheads, if straight lines appear jagged on printouts, or if the diagnostic page indicates aligning printheads might help.
For more information, see [Align printheads on page 61](#).
8. If print quality problems persist after cleaning and aligning printheads, contact HP support.

Align printheads

Aligning the printheads can improve print quality. If you notice misaligned colors or lines in your printouts or on the print quality diagnostics page, you should perform an alignment. For more information about the print quality diagnostics page, see [Improve print quality on page 59](#).

To align the printheads (Windows)

1. Load Letter or A4 unused plain white paper into the input tray.
2. In the HP printer software (available from the **Start** menu), click **Print & Scan** at the top of the window.
3. In the **Print** section, click **Maintain Your Printer** to access the Toolbox.
4. In the Toolbox, click the **Device Services** tab, click the desired option, and then follow the onscreen instructions.

To align the printhead from the printer display

1. Load Letter or A4 unused plain white paper into the input tray.
2. From the Home screen on the printer control panel display, touch  (**Setup**).
3. Touch **Tools**, touch **Align Cartridges**, and then follow the onscreen instructions.

Clean printheads

If your prints are streaked or have incorrect or missing colors, the printheads might need to be cleaned. You can also check the print quality diagnostics page to determine if cleaning is recommended. The cleaning process prints one page to attempt to clean the printheads. For more information about the print quality diagnostics page, see [Improve print quality on page 59](#).



NOTE: Clean the printheads only when necessary. Unnecessary cleaning wastes ink and shortens the life of the printheads.

To clean the printheads (Windows)

1. Load Letter or A4 unused plain white paper into the input tray.
2. In the HP printer software (available from the **Start** menu), click **Print & Scan** at the top of the window.
3. In the **Print** section, click **Maintain Your Printer** to access the Toolbox.
4. In the Toolbox, click the **Device Services** tab, click the desired option, and then follow the onscreen instructions.

To clean the printhead from the printer display

1. Load Letter or A4 unused plain white paper into the input tray.
2. From the Home screen on the printer control panel display, touch  (**Setup**).
3. Touch **Tools**, touch **Clean Cartridges**, and then follow the onscreen instructions.

Clean printer

You can run a cleaning routine from the printer software to prevent back of page smearing.

To clean the printer from the printer software (Windows)

1. Load Letter or A4 unused plain white paper into the input tray.
2. In the HP printer software (available from the **Start** menu), click **Print & Scan** at the top of the window.
3. In the **Print** section, click **Maintain Your Printer** to access the Toolbox.
4. In the Toolbox, click the **Device Services** tab, click the desired option, and then follow the onscreen instructions.

Tips for working with ink and printhead

Printhead tips

Use the following tips to work with printheads:

- Use original HP printheads.
- To protect the printheads from drying out, always turn the printer off using the Power button, and wait until the Power button light goes out.
- Do not open or untape printheads until you are ready to install them. Leaving tape on the printheads reduces ink evaporation.
- Install both the black and color printheads correctly.

For more information, see [Printhead \(cartridge\) problem on page 94](#).

- After you have set up the printer, do not open the printhead latch unless instructed to do so.
- Align the printer for best print quality. See [Improve print quality on page 59](#) for more information.
- If you remove a printhead from the printer for any reason, try to replace it again as soon as possible. Outside of the printer, if unprotected, the printhead may begin to dry out.

Ink tips

Use the following tips to work with ink:

- Make sure the ink tanks are not low on ink before printing.

For more information, see [Ink levels on page 53](#).

- Refill the ink tanks when they are low on ink. Printing with the ink tanks low on ink may cause damage to your printer.
- Do not tilt the printer.



NOTE: Original HP printheads and ink are designed and tested with HP printers and papers to help you easily produce great results, time after time.

HP cannot guarantee the quality or reliability of non-HP supplies. Product service or repairs required as a result of using a non-HP supply will not be covered under warranty.

Move printer

To prevent damage to the printer or ink leakage, follow these instructions.

If you are moving the printer within your home or office, keep the printhead latch closed, and keep the printer level.

If you are moving the printer outside your home or office, see the instructions provided in box for moving printer, or visit www.support.hp.com.

6 Connect

- [Before you begin](#)
- [To place the printer in setup mode](#)
- [Connect your printer to a wireless network with a router](#)
- [Connect wirelessly to the printer without a router \(Wi-Fi Direct\)](#)
- [Connect your printer by using the HP Smart app](#)
- [Change wireless settings](#)
- [Connect your printer to your computer with a USB cable \(non-network connection\)](#)
- [Change from a USB connection to a wireless network](#)
- [Use advanced printer management tools \(for networked printers\)](#)
- [Tips for setting up and using a networked printer](#)

Before you begin

Ensure the following:

- The wireless network is set up and working properly.
- The printer and the computers that use the printer are on the same network (subnet).

While connecting the printer, you might be prompted to enter the wireless network name (SSID) and a wireless password.

- The wireless network name is the name of your wireless network.
- The wireless password prevents other people from connecting to your wireless network without your permission. Depending on the level of security required, your wireless network might use either a WPA passphrase or WEP key.

If you have not changed the network name or the security passkey since setting up your wireless network, you can sometimes find them on the back or side of the wireless router.

If you cannot find the network name or the security password or cannot remember this information, see the documentation provided with your computer or with the wireless router. If you still cannot find this information, contact your network administrator or the person who set up the wireless network.

To place the printer in setup mode

If more than two hours have passed since you first turned on the printer and you have not set up the printer wirelessly, place the printer in network setup mode by restoring the printer network settings. The setup mode will last for two hours. For information on how to restore the printer network settings, see [Restore original factory defaults and settings on page 109](#).

Connect your printer to a wireless network with a router

- [Connect your printer to a wireless network using HP printer software](#)
- [Connect your printer to a wireless network using the printer control panel](#)

Connect your printer to a wireless network using HP printer software

To connect the printer to an integrated wireless WLAN 802.11 network, make sure you have the following:

- A wireless 802.11b/g/n network that includes a wireless router or access point.



NOTE: The printer supports connections using 2.4GHz and 5GHz.

- A computer that is already connected to the wireless network that you want to use to connect your printer.
- Network name (SSID).
- WEP key or WPA Passphrase (if needed).

Connect your printer using HP printer software (Windows)

If connecting the printer wirelessly using HP software, place the printer in network setup mode by restoring the printer network settings. The setup mode will last for two hours. For information on how to restore the printer network settings, see [Restore original factory defaults and settings on page 109](#).

1. In the HP printer software (available from the **Start** menu), click **Tools**.

For information about the software, see [Open the HP printer software on page 11](#).

2. Click **Device Setup & Software**.
3. Click **Connect a new device**.
4. Select **Manual Setup**, select the wireless option, and then follow the onscreen instructions.

Connect your printer to a wireless network using the printer control panel

Use the Wireless Setup Wizard from the printer control panel display to set up wireless communication.



NOTE: Before you proceed, go through the list at [Before you begin on page 67](#).

1. From the Home screen of the printer control panel display, touch (Wireless).
2. Touch (Settings).
3. Touch **Wireless Setup Wizard** or **Wi-Fi Protected Setup**.
4. Follow the display instructions to complete the setup.

Connect wirelessly to the printer without a router (Wi-Fi Direct)

With Wi-Fi Direct, you can print wirelessly from a computer, smart phone, tablet, or other wireless-capable device—without connecting to an existing wireless network.

Guidelines for using Wi-Fi Direct



NOTE: For more information about Wi-Fi Direct, visit www.hp.com/go/wifidirectprinting.

- Make sure Wi-Fi Direct for your printer is turned on. See the section [To turn on or off Wi-Fi Direct on page 70](#).
- Make sure your computer or mobile device has the necessary software.
 - If you are using a computer, make sure you have installed the printer software provided with the printer.

If you have not installed the HP printer software on the computer, connect your computer to Wi-Fi Direct for your printer first and then install the printer software. Select **Wireless** when prompted by the printer software for a connection type.
 - If you are using a mobile device, make sure you have installed a compatible printing app.
- Up to five computers and mobile devices can use the same Wi-Fi Direct connection at the same time.
- Wi-Fi Direct can be used while the printer is also connected either to a computer using a USB cable or to a network using a wireless connection.
- Wi-Fi Direct cannot be used to connect a computer, mobile device, or printer to the Internet.

To turn on or off Wi-Fi Direct

1. From the Home screen on the printer control panel display, touch (Wi-Fi Direct).
2. Touch (Settings).
3. If the display shows that Wi-Fi Direct is **Off**, touch the toggle button next to **Wi-Fi Direct** to turn it on.



TIP: You can also turn on Wi-Fi Direct from the EWS. For more information about using the EWS, see [Open the embedded web server on page 77](#).

To change connection method

1. From the Home screen on the printer control panel display, touch (Wi-Fi Direct).
2. Touch (Settings).
3. Touch **Connection Method** and then select **Automatic** or **Manual**.

To find the Wi-Fi Direct name or password

- From the Home screen on the printer control panel display, touch (Wi-Fi Direct).

The Wi-Fi Direct name and password are displayed onscreen.

To print from a wireless-capable mobile device that supports Wi-Fi Direct

For Google Android devices, make sure you have installed the latest version of HP Print Service Plugin on your mobile device. You can download this plugin from the Google Play application store.

1. Make sure you have turned on Wi-Fi Direct on the printer.
2. Turn on Wi-Fi Direct on your mobile device. For more information, see the documentation provided with the mobile device.
3. From your mobile device, select a document from a print enabled application, and then select the option to print the document.

The list of available printers appears.

4. From the list of available printers, choose the Wi-Fi Direct name shown such as DIRECT-**-HP Smart Tank (where ** are the unique characters to identify your printer) to connect your mobile device.

If the mobile device is not automatically connected to the printer, follow the instructions on the printer control panel to connect to the printer. If a PIN code is displayed on the printer control panel, enter the PIN code on your mobile device.

When the mobile device is successfully connected to the printer, the printer starts printing.

To print from a wireless-capable mobile device that does not support Wi-Fi Direct

1. Make sure you have installed a compatible printing app on your mobile device. For more information, visit www.hp.com/global/us/en/eprint/mobile_printing_apps.html.
2. Make sure you have turned on Wi-Fi Direct on the printer. For more information, see [To turn on or off Wi-Fi Direct on page 70](#).
3. Turn on the wireless (Wi-Fi) connection on your mobile device. For more information, see the documentation provided with the mobile device.
4. From the mobile device, use the process you normally use to connect to a new wireless network or hotspot. Choose the Wi-Fi Direct name from the list of wireless networks shown such as DIRECT-**-HP Smart Tank (where ** are the unique characters to identify your printer).



NOTE: To find the Wi-Fi Direct name or password, see [To find the Wi-Fi Direct name or password on page 70](#).

5. Enter the Wi-Fi Direct password of your printer when prompted.
6. Print your document.

To print from a wireless-capable computer (Windows)

1. Make sure you have turned on Wi-Fi Direct on the printer. For more information, see [To turn on or off Wi-Fi Direct on page 70](#).
2. Turn on the computer's Wi-Fi connection. For more information, see the documentation provided with the computer.



NOTE: If your computer does not support Wi-Fi, you are not able to use Wi-Fi Direct.

3. From the computer, use the process you normally use to connect to a new wireless network or hotspot. Choose the Wi-Fi Direct name from the list of wireless networks shown such as DIRECT-**-HP Smart Tank (where ** are the unique characters to identify your printer).

Enter the Wi-Fi Direct password when prompted.

To find the Wi-Fi Direct name or password, see [To find the Wi-Fi Direct name or password on page 70](#).

4. Proceed to step 5 if the printer has been installed and connected to the computer over a wireless network. If the printer has been installed and connected to your computer with a USB cable, follow the steps below to install the printer software using the Wi-Fi Direct connection.
 - a. Depending on your operating system, do one of the following:
 - **Windows 10:** From the computer desktop, click **Start**, select **HP** from the app list, and then select the icon with the printer name.
 - **Windows 7:** From the computer desktop, click **Start**, select **All Programs**, click **HP**, click the folder for the printer, and then select the icon with the printer name.
 - b. In the printer software, click **Tools**.
 - c. Click **Device Setup & Software**, and then select **Connect a new device**.
 - d. When the **Connection Options** software screen appears, select **Wireless**.
Select your HP printer from the list of detected printers.
 - e. Follow the onscreen instructions.
5. Print your document.

Connect your printer by using the HP Smart app

To connect the printer to the wireless network using the HP Smart app

You can use the HP Smart app to set up the printer on your wireless network. The HP Smart app is supported on iOS, Android, Windows, and Mac devices. For information about the app, see [Use the HP Smart app to print, scan, and troubleshoot on page 12](#).

1. Make sure the device you are using to connect the printer is connected to the same network you want to connect the printer to.
2. If more than two hours have passed since you first turned on the printer and you have not set up the printer wirelessly, place the printer in the network setup mode by restoring the printer network settings. For information on how to restore the printer network settings, see [Restore original factory defaults and settings on page 109](#).
3. If you are using an iOS or Android mobile device, make sure the device has Bluetooth turned on.



NOTE:

- HP Smart uses Bluetooth for printer setup only. This helps to make the setup process faster and easier on iOS and Android mobile devices.
 - Printing using Bluetooth is not supported.
-
4. Open the HP Smart app on your device. To learn how to install the app, see [Use the HP Smart app to print, scan, and troubleshoot on page 12](#).
 5. On the Home screen of HP Smart, click or tap **+** (Plus icon), and then select or add a printer.

Follow the onscreen instructions on your device to add the printer to your network.



To connect the printer with a USB cable using the HP Smart app

1. Connect the USB cable to the printer from your device.
2. Open the HP Smart app on your device. For information, see [Use the HP Smart app to print, scan, and troubleshoot on page 12](#).
3. On the Home screen of HP Smart, click or tap **+** (Plus icon), and then select your printer.

Change wireless settings



You can set up and manage your printer wireless connection and perform a variety of network management tasks. This includes printing information about network settings, turning the wireless function on or off, and changing wireless settings.

To configure the wireless settings



1. From the Home screen of the printer control panel display, touch  (Wireless), and then touch  (Settings).
2. Select **Wireless Setup Wizard**, and then follow the onscreen instructions to find your network name and enter your security password (WEP/WPA/WPA2).

To turn on or off the wireless capability of the printer

The blue Wireless light on the printer control panel is lit when the wireless capability of the printer is on.



1. From the Home screen of the printer control panel display, touch  (Wireless), and then touch  (Settings).
2. Touch the toggle button next to **Wireless** to turn the wireless capability on or off.

To print the wireless network test report

1. From the Home screen of the printer control panel display, touch  (Wireless), and then touch  (Settings).
2. Touch **Print Reports**.
3. Touch **Wireless Test Report**.

To print network settings

Do one of the following:

- From the Home screen of the printer control panel display, touch  (Wireless) to display the network status screen. Touch **Print** to print the network configuration page.
- From the Home screen of the printer control panel display, touch  (**Setup**), touch **Tools**, and then touch **Network Configuration Report**.

To change wireless settings using the HP Smart app

1. If more than two hours have passed since you first turned on the printer and you have not set up the printer wirelessly, place the printer in network setup mode by restoring the printer network settings.

The setup mode will last for two hours. For information on how to restore the printer network settings, see [Restore original factory defaults and settings on page 109](#).
2. Tap  (Plus icon) on the Home screen of HP Smart, and then select the option to add a new printer.

Connect your printer to your computer with a USB cable (non-network connection)

The printer supports a rear USB 2.0 High Speed port for connection to a computer.

If the HP printer software has been installed, the printer will operate as a plug-and-play device. If the software has not been installed, follow the steps below to connect the printer with the USB cable.

If you are using the HP Smart app instead of the printer software, see [To connect the printer with a USB cable using the HP Smart app on page 73](#).

To connect the printer with the USB cable

1. Enter 123.hp.com in a web browser on your computer to download and install the HP printer software. You can also use the HP printer software CD (if provided), or download the software from www.support.hp.com.



NOTE: Do not connect the USB cable to the printer until you are prompted to do so.

2. Follow the onscreen instructions. When you are prompted, connect the printer to the computer by selecting **USB** on the **Connection Options** screen.
3. Follow the onscreen instructions.

Change from a USB connection to a wireless network

If you first set up your printer and installed the software with a USB cable, directly connecting the printer to your computer, you can easily change to a wireless network connection. You will need a wireless 802.11b/g/n network that includes a wireless router or access point.

Before changing from a USB connection to a wireless network, make sure that:

- The printer is connected to your computer with the USB cable until you are prompted to disconnect the cable.
- Your computer is already connected to the wireless network that you want to connect the printer.



NOTE: If you are unable to set up the connection following the steps in this section, see [Network and connection issues on page 105](#).

To change from a USB connection to a wireless network (Windows)

1. In the HP printer software (available from the **Start** menu), click **Tools**.
2. Click **Device Setup & Software**.
3. Select **Convert a USB connected device to wireless**. Follow the onscreen instructions.

To change from a USB connection to a wireless network using the HP Smart app (Windows 10)

1. Before you proceed, make sure your computer and printer meet the following requirements:
 - Your printer is currently connected to your computer through USB.
 - Your computer is currently connected to a wireless network.
2. Open the HP Smart app. For information, see [Use the HP Smart app to print, scan, and troubleshoot on page 12](#).
3. Make sure your printer is selected.



TIP: If a printer is already set up, you can select it from the Home screen of HP Smart by swiping left or right and selecting it.

To use a different printer, click or tap **+** (Plus icon) on the Home screen, and then select a different printer or add a new printer.

4. Click **Learn More** when you see “Make printing easier by connecting your printer wirelessly” on top of the home page of the app.
5. Follow the onscreen instructions to complete the connection.

Use advanced printer management tools (for networked printers)

When the printer is connected to a network, you can use the embedded web server (EWS) to view status information, change settings, and manage the printer from your computer.

 **NOTE:** You can open and use the EWS without being connected to the Internet. However, some features are not available.

 **NOTE:** To view or change some settings, you might need a password.

- [Open the embedded web server](#)
- [About cookies](#)

Open the embedded web server

You can use one of the following ways to open the embedded web server.

To open the embedded web server through a network

1. Find out the IP address of the printer by touching  (Wireless) or by printing a network configuration page.

 **NOTE:** The printer and the computer or mobile device must be connected to the same network. Also, the printer must have an IP address.

2. In a supported web browser on your computer or mobile device, type the IP address assigned to the printer.

For example, if the IP address is 123.123.123.123, type the following address into the web browser:
`http://123.123.123.123.`

To open the embedded web server from the HP printer software (Windows)

1. Open the printer software. For more information, see [Open the HP printer software on page 11](#).
2. Click the **Print & Scan** tab, and then click **Maintain Your Printer**.
3. In Toolbox, click the **Device Information** tab.
4. After the printer information is retrieved, click **Printer EWS Home Page** near the bottom right of the page.

To open the embedded web server from the HP Smart app



1. Open the HP Smart app on your device. For more information, see [Use the HP Smart app to print, scan, and troubleshoot on page 12](#).
2. On the Home screen of HP Smart, make sure your printer is selected.

 **TIP:** If a printer is already set up, you can select it from the Home screen of HP Smart by swiping left or right and selecting it.

To use a different printer, click or tap **+** (Plus icon) on the Home screen, and then select a different printer or add a new printer.

3. Click or tap the printer.
4. **iOS/Android:** Select **Advanced Setting** under **Advanced**.
Windows 10/Mac: Click **Printer Home Page (EWS)** under **Advanced**.

To open the embedded web server through Wi-Fi Direct

1. From the Home screen of the printer control panel display, touch  (Wi-Fi Direct).
2. Touch  (Settings).
3. If the display shows that Wi-Fi Direct is **Off**, touch the toggle button next to **Wi-Fi Direct** to turn it on.
4. From your wireless computer or mobile device, turn wireless on, search for and connect to Wi-Fi Direct name, for example: DIRECT-**-HP Smart Tank (where ** are the unique characters to identify your printer).

Enter Wi-Fi Direct password when prompted.



NOTE: To find the Wi-Fi Direct name or password, touch  (Wi-Fi Direct) from the Home screen on the printer control panel display.

5. In a supported web browser on your computer or mobile device, type the following address: `http://192.168.223.1`.

About cookies

The embedded Web server (EWS) places very small text files (cookies) on your hard drive when you are browsing. These files let the EWS recognize your computer the next time you visit. For example, if you have configured the EWS language, a cookie helps remember which language you have selected so that the next time you access the EWS, the pages are displayed in that language. Some cookies (such as the cookie that stores customer-specific preferences) are stored on the computer until you clear them manually.

You can configure your browser to accept all cookies, or you can configure it to alert you every time a cookie is offered, which allows you to decide which cookies to accept or refuse. You can also use your browser to remove unwanted cookies.



NOTE: Depending on your printer, if you disable cookies, you also disable one or more of the following features:

- Starting where you left the application (especially useful when using setup wizards)
- Remembering the EWS browser language setting
- Personalizing the EWS Home page

For information about how to change your privacy and cookie settings and how to view or delete cookies, see the documentation available with your Web browser.

Tips for setting up and using a networked printer

Use the following tips to set up and use a networked printer:

- When setting up the wireless networked printer, make sure your wireless router or access point is powered on. The printer searches for wireless routers, then lists the detected network names on the computer.
- If your computer is connected to a Virtual Private Network (VPN), you need to disconnect from the VPN before you can access any other device on your network, including the printer.
- Learn more about configuring your network and the printer for wireless printing. [Click here to go online for more information.](#)
- Learn how to find your network security settings. [Click here to go online for more information.](#)
- Make sure your wireless network provides an Internet connection.
- Make sure the printer is on the network.

If not, use the Wireless Setup Wizard from the printer control panel display to set up wireless communication.

- Make sure the printer and device are turned on and connected to the same wireless network.
- If more than two hours have passed since you first turned on the printer and you have not set up the printer wirelessly, place the printer in network setup mode by restoring the printer network settings. The setup mode will last for two hours. For information on how to restore the printer network settings, see [Restore original factory defaults and settings on page 109.](#)
- If you are using a mobile device, make sure the device has Bluetooth turned on.
- Learn about the HP Print and Scan Doctor. [Click here to go online for more information.](#)



NOTE: This utility is only available for the Windows operating system.

- Learn how to change from a USB to wireless connection. [Click here to go online for more information.](#)
- Learn how to work with your firewall and antivirus programs during printer setup. [Click here to go online for more information.](#)

7 Solve a problem

This section contains the following topics:

- [Get help with HP online troubleshooting](#)
- [Get more help](#)
- [Get help from the printer control panel](#)
- [Get help from the HP Smart app](#)
- [Jams and paper-feed issues](#)
- [Printhead \(cartridge\) problem](#)
- [Printing issues](#)
- [Copy issues](#)
- [Scan issues](#)
- [Network and connection issues](#)
- [Printer hardware issues](#)
- [Solve problems using Web Services](#)
- [Restore original factory defaults and settings](#)
- [Maintain the printer](#)
- [HP support](#)

Get help with HP online troubleshooting

Use an HP online troubleshooting tool to solve your printer issues. Use the table below to identify your problem and click the appropriate link.



NOTE: The HP online troubleshooting wizards might not be available in all languages.

Online troubleshooting tool	Use this tool to learn how to:
Troubleshoot paper jam issues	Clear jammed paper from the printer or document feeder and resolve paper or paper feed issues.
Troubleshoot a print carriage jam	Clear obstructions that are blocking the print carriage.
Troubleshoot issues with print job not printing	Resolve issues with printer responsiveness, pages not printing, or “Unable to print” errors.
Troubleshoot copy and scan issues	Determine why the printer will not copy or scan, or improve the quality of your copies or scans.
Troubleshoot print quality issues	Improve the quality of your prints.
Find network settings for a wireless connection	Find your wireless network name (SSID) and password.
Troubleshoot wireless network connection issues	Resolve wireless networking issues, including issues with setting up a wireless connection for the first time or fixing a connection that is no longer working.
Convert a USB connection to wireless	Convert your printer-to-computer connection from USB to wireless.
Troubleshoot a firewall or antivirus issue	Determine if a firewall or antivirus program is preventing your computer from connecting to the printer and resolve the issue.
Troubleshoot Wi-Fi Direct connection issues	Resolve Wi-Fi Direct problems or configure Wi-Fi Direct.
Troubleshoot mobile network issues	Resolve issues with connecting a mobile device to your printer.
HP Print and Scan Doctor	Automatically diagnose and resolve printer issues.
(For Windows operating systems only)	
HP Virtual Agent	Chat with HP Virtual Agent to troubleshoot issues.

Get more help



Solve printer issues with HP online troubleshooting tools

[Get help with HP online troubleshooting on page 81](#)



Diagnose and resolve printer issues

[HP Print and Scan Doctor](#)

(For Windows operating systems only)



Get printer documentation, troubleshooting information, software updates, and more

www.support.hp.com



Use my device to print, scan, and manage my printer with the HP Smart app

- **iOS/Android:** www.hp.com/go/hpsmart-help
- **Windows:** www.hp.com/go/hpsmartwin-help
- **Mac:** www.hp.com/go/hpsmartmac-help



Scan with HP Scan software

[HP Scan software](#)



Order ink supplies

[HP Sure Supply](#)



Contact HP support

[Contact support website](#)



Print from anywhere to my HP ePrint-enabled printer

[HP ePrint](#)



Register my product

www.register.hp.com



View printer warranty options

www.support.hp.com

Get help from the printer control panel

You can use the printer's help topics to learn more about the printer, and some help topics include animations that guide you through procedures, such as loading paper.

To access the Help menu from the Home screen or contextual help for a screen, touch **?** on the printer control panel.

Get help from the HP Smart app

The HP Smart app provides alerts for printer issues (jams and other problems), links to help content, and options to contact support for additional assistance. For more information about the app, see [Use the HP Smart app to print, scan, and troubleshoot on page 12](#).

1. Open the HP Smart on your device.
2. On the Home screen of HP Smart, make sure your printer is selected.

 **TIP:** If a printer is already set up, you can select it from the Home screen of HP Smart by swiping left or right and selecting it.

To use a different printer, click or tap **+** (Plus icon) on the Home screen, and then select a different printer or add a new printer.

3. To view the printer status, click or tap the printer icon.

Jams and paper-feed issues

Clear a paper or print carriage jam

Solve paper jam issues.	Use an HP online troubleshooting wizard Get step-by-step instructions for clearing paper jams and resolving issues with paper or the paper feed.
Resolve a print carriage jam.	Use an HP online troubleshooting wizard If something is blocking the print carriage or it does not move easily, get step-by-step instructions.

 **NOTE:** The HP online troubleshooting wizards may not be available in all languages.

Read general instructions in the Help for clearing jams

Paper jams can occur in several locations. For print carriage jams, remove any objects, including paper, that are blocking the print carriage in the printhead access area.

 **NOTE:** Do not use any tools or other devices to remove jammed objects. Always use caution when removing jammed objects from inside the printer.

To clear a paper jam from the input tray

1. Pull the paper gently out of the input tray.



2. Make sure there is no foreign object in the paper path, and then reload paper.

 **NOTE:** The input tray shield can prevent foreign debris from falling into the paper path and causing serious paper jams. Do not take down the input tray shield.

To clear a paper jam from the output tray

- ▲ Pull the paper gently out of the output tray.



To clear a paper jam in the document feeder

1. Lift the cover of the document feeder.



2. Gently pull the jammed paper out of the rollers.



⚠ CAUTION: If the paper tears when you are removing it from the rollers, check the rollers and wheels for torn pieces of paper that might remain inside the printer.

If you do not remove all the pieces of paper from the printer, more paper jams are likely to occur.

3. Close the document feeder cover, pressing down firmly until it snaps into place.

To clear paper or other objects from the printhead (cartridge) access area

1. Close the output tray extender, and then close the output tray.



2. Open the front door of the printer.

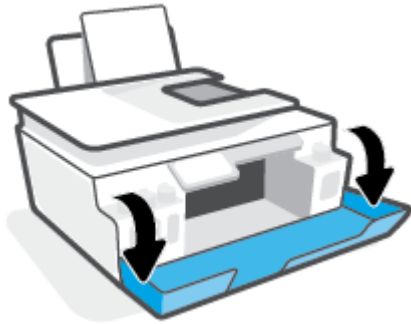

3. Open the printhead access door.

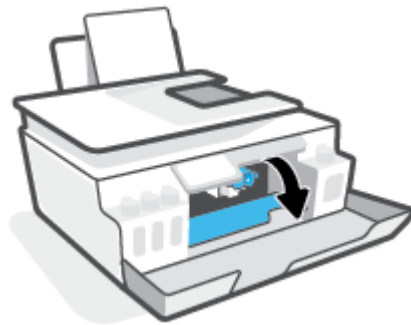

4. Make sure the print carriage is not obstructed. You might need to slide the carriage to the right side.

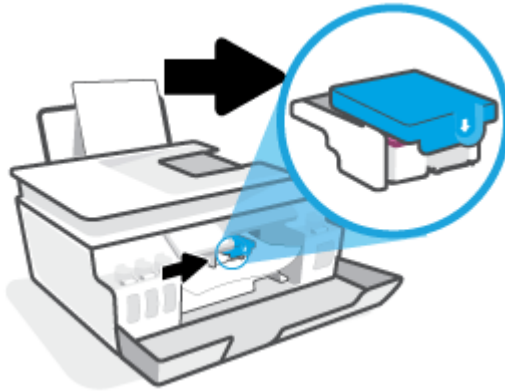

Remove any jammed paper or other objects blocking the carriage.

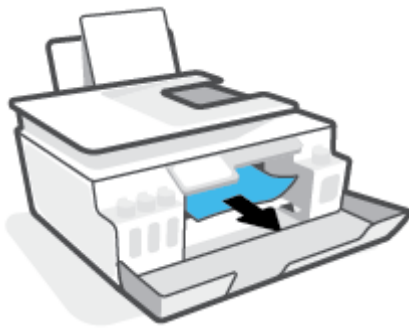

5. Make sure the printhead latch is properly closed.

NOTICE: After you have set up the printer, do not open the printhead latch unless instructed to do so.

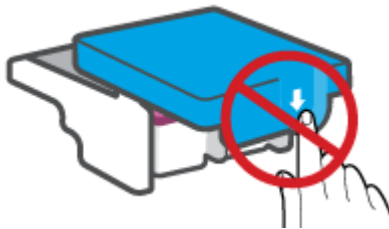

6. Close the front door of the printer.
7. Pull out the output tray and the tray extender.



To clear a paper jam inside of the printer

 **NOTE:** Follow the instructions in this section after you have tried other ways to clear paper jams. Before you begin, make sure the ink tank caps are firmly closed to prevent ink from leaking.

1. Press  (the Power button) to turn off the printer.
2. Open the front door, and then open the printhead access door.

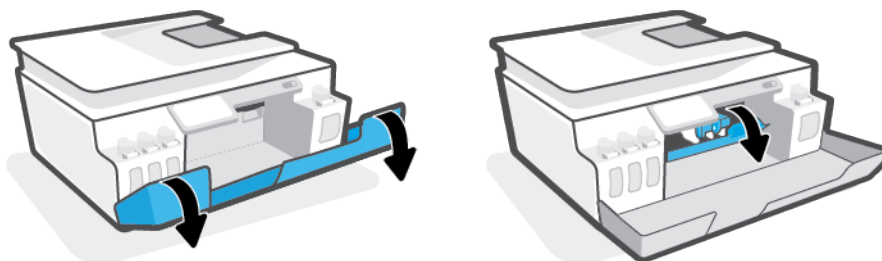

 **NOTE:** If the print carriage is not on the left side, manually move it to far left.

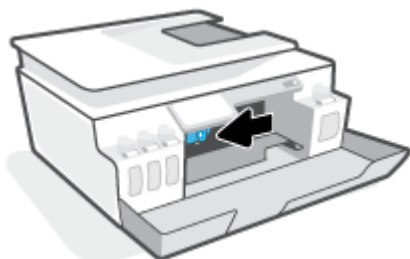

3. Press down on the side of the printhead latch to open.

 **NOTE:** After you have set up the printer, do not open the printhead latch unless instructed to do so.

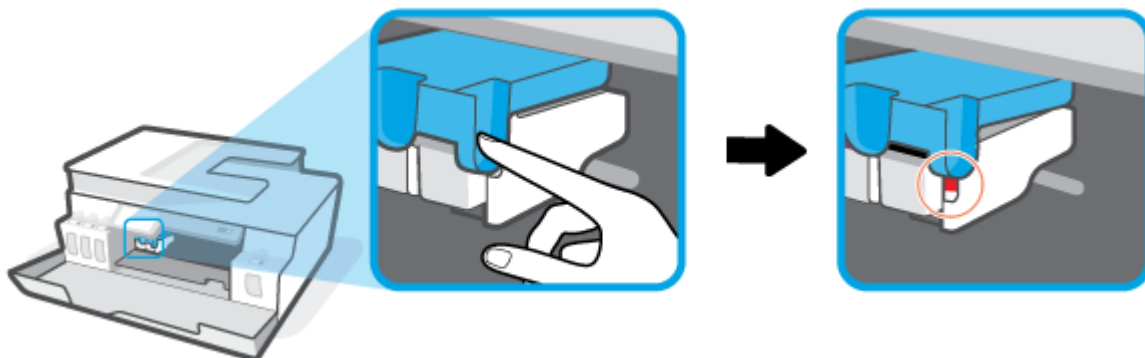

4. Close the doors.

5. Lift the front of the printer so that the printer is resting on its rear, to expose the bottom cleanout. Locate the cleanout door on the bottom of the printer, and then pull both tabs on the cleanout door to open it.



NOTE: Do not keep the printer in a tilted position for too long to prevent ink from leaking.

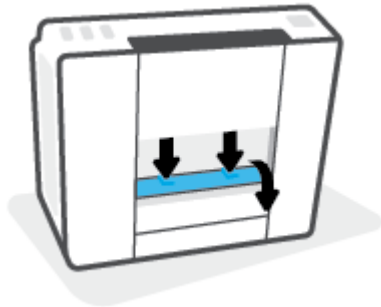

6. Remove the jammed paper.

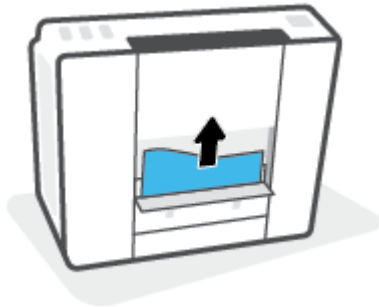

7. Close the cleanout door. Gently push the door towards the printer until both latches snap into place.

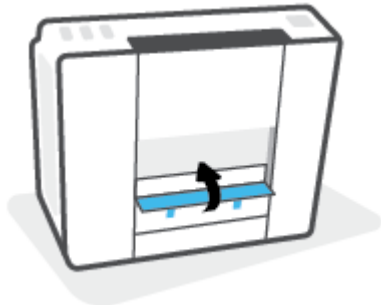

8. Turn the printer upright.
9. Open the front door, and then open the printhead access door.

10. Close the printhead latch, and then close the doors.

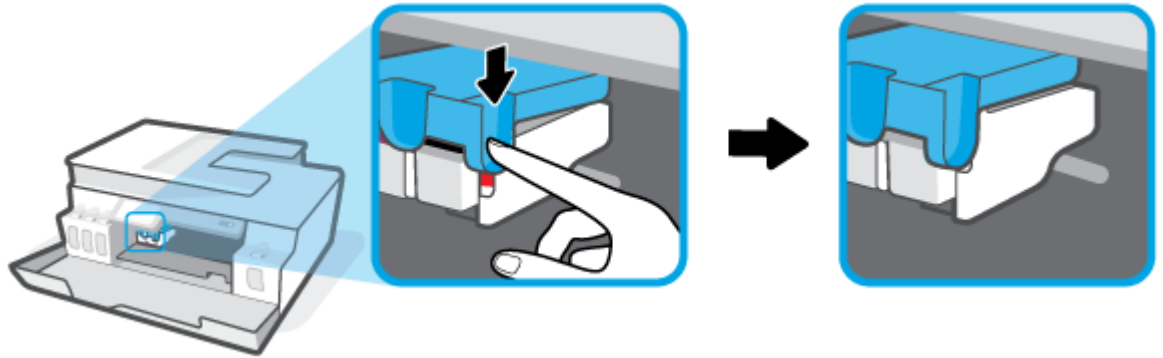

11. Connect the power cord, and then turn on the printer.

Learn how to avoid paper jams

To help avoid paper jams, follow these guidelines.

- Do not overfill the input tray, but make sure that you have at least 5 pages loaded, for best results.
- Keep your printer free of dust and debris by removing paper and closing the input tray when not in use.
- Remove printed papers from the output tray frequently.
- Ensure that paper loaded in the input tray lays flat, and the edges are not bent or torn.
- Do not combine different paper types and paper sizes in the input tray; the entire stack of paper in the input tray must be the same size and type.

Use HP paper for optimum performance. See [Paper basics on page 9](#) for more information about HP paper.

- Adjust the paper-width guide in the input tray to fit snugly against all paper. Make sure the paper-width guide does not bend the paper in the input tray.
- Do not force paper too far down in the input tray.
- Do not add paper while the printer is printing. If the printer is about to run out of paper, wait until the out of paper message appears before adding paper.

Solve paper-feed problems

What kind of problem are you having?

- **Paper is not picked up from the input tray**
 - Make sure paper is loaded in the input tray. For more information, see [Load media on page 19](#).
 - Adjust the paper-width guide in the input tray to fit snugly against all paper. Make sure the paper-width guide does not bend the paper in the input tray.

- Make sure paper in the input tray is not curled. Uncurl paper by bending it in the opposite direction of the curl.
- Clean the paper rollers.
- **Pages are skewing**
 - Make sure the paper is loaded in the far-right side of the input tray and the paper-width guide is fit against the left side of the paper.
 - Load paper into the printer only when it is not printing.
- **Multiple pages are being picked up**
 - Adjust the paper-width guide in the input tray to fit snugly against all paper. Make sure the paper-width guide does not bend the paper in the input tray.
 - Make sure the input tray is not overloaded with paper.
 - Make sure the pieces of the loaded paper are not sticking together.
 - Use HP paper for optimum performance and efficiency.
 - Clean the paper rollers.

To clean the paper rollers manually

1. Gather the following materials:
 - A long, lint-free cotton swab
 - Distilled, filtered, or bottled water (tap water might damage the printer)
2. Press  (the Power button) to turn off the printer.
3. Disconnect the power cord from the rear of the printer.
4. Disconnect the USB cable, if it is not already disconnected.
5. Raise the input tray.
6. Lift and hold the input tray shield.



NOTE: Do not remove the input tray shield. The input tray shield prevents foreign debris from falling into the paper path and causing paper jams.

7. Look down through the open input tray and find the gray paper pick rollers. You might need a flashlight to illuminate the area.
8. Dampen a long cotton swab with bottled or distilled water, and then squeeze any excess water from the cloth.
9. Press the swab against the rollers, and then rotate them upward with your fingers. Apply a moderate amount of pressure to remove dust or dirt buildup.
10. Lower the input tray shield.
11. Allow the rollers to dry for 10 or 15 minutes.
12. Reconnect the power cord to the rear of the printer.

13. Reconnect the USB cable to the printer if necessary.
14. Press the Power button to turn on the printer.

Printhead (cartridge) problem

If a message indicates a printhead problem, try the following in order:

1. Verify that the indicated printhead is correctly installed.
2. Clean the printhead contacts.
3. Contact HP support for assistance. Go to www.support.hp.com.

To verify the printhead installed properly

NOTICE: The instructions here are only applicable in this section. After you have set up the printer, do not open the printhead latch unless instructed to do so.

1. Make sure the printer is turned on.
2. Close the output tray extender, and then close the output tray.



3. Remove and reinsert the printhead.
 - a. Open the front door of the printer.

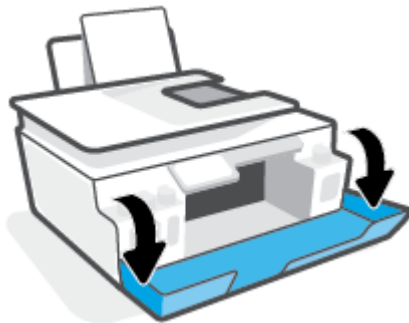

- b. Open the printhead access door.

NOTICE: After you have set up the printer, do not open the printhead latch unless instructed to do so.

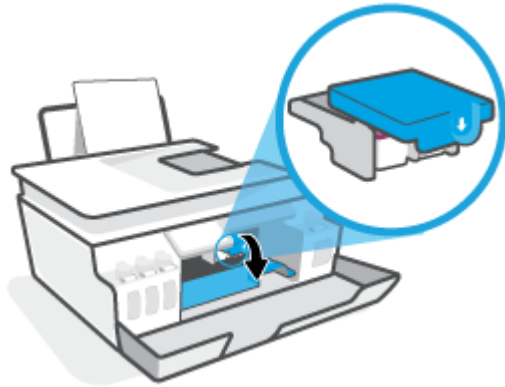

- c. Push down to open the printhead latch.

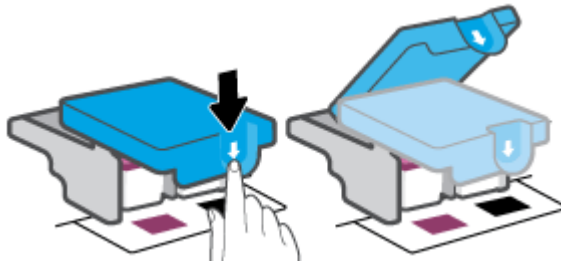

- d. Remove the printhead from the carriage.



- e. Check if there is a plug on top of the printhead or plastic tape on the printhead contacts. If there is, remove the plug from top of the printhead and the plastic tape from contacts.

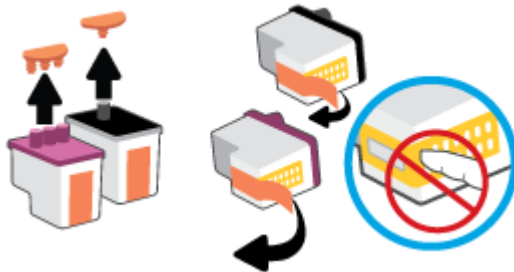

NOTICE: Do not touch the electrical contacts on the printhead.

- f. Slide the printhead into the slot until it clicks into place.

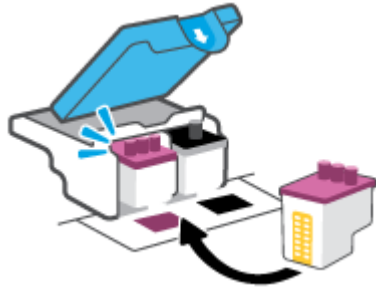

- g. Close the printhead latch. Make sure the printhead latch is properly closed to avoid problems such as carriage jams.

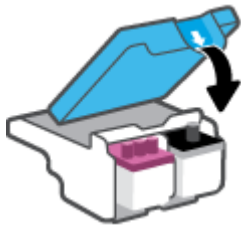

- h. Close the front door of the printer.

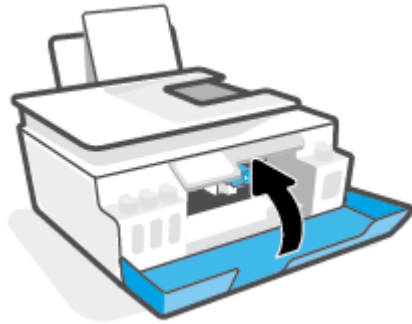

4. Pull out the output tray and the tray extender.



To clean printhead contacts

 **NOTE:**

- Open the printhead latch and clean printhead contacts only when necessary; for example, if a printhead cannot be detected.

The instructions here are only applicable in this section. After you have set up the printer, do not open the printhead latch unless instructed to do so.

- The cleaning procedure should take only a few minutes. Make sure that the printheads are reinstalled in the printer as soon as possible. It is not recommended to leave the printheads outside of the printer longer than 30 minutes. This could result in damage to the printheads.

1. Make sure the printer is turned on.
2. Close the output tray extender, and then close the output tray.



3. Open the front door of the printer.

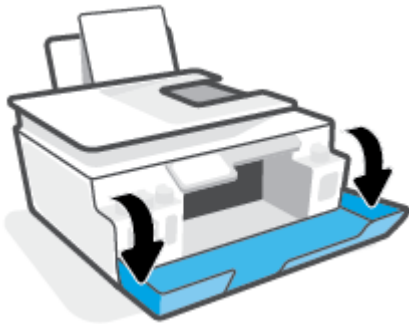

4. Open the printhead access door.

 **NOTE:** After you have set up the printer, do not open the printhead latch unless instructed to do so.

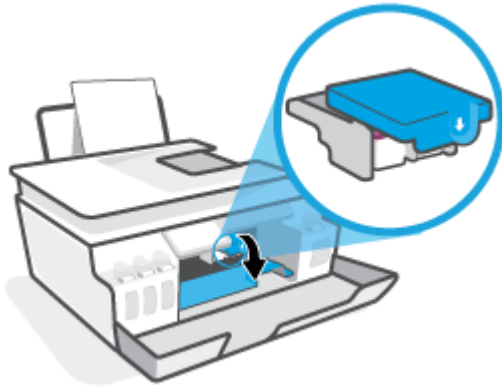

5. Push down to open the printhead latch.

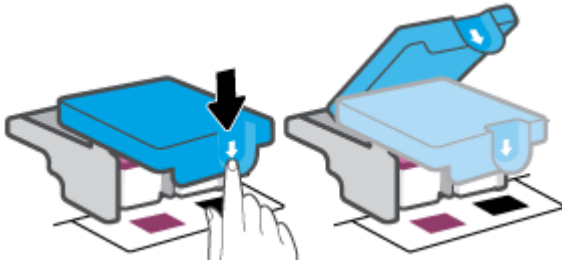

6. Remove the printhead indicated in the error message.



7. Clean the printhead contacts and printer contacts.

- a. Hold the printhead by its sides and locate the electrical contacts on the printhead.
The electrical contacts are the small gold-colored dots on the printhead.



- b. Wipe only the contacts with a dry swab or lint-free cloth.

 **NOTE:** Be careful to wipe only the contacts, do not smear any ink or other debris on the contacts.

- c. On the inside of the printer, locate the contacts for the printhead.

The printer contacts are the set of gold-colored bumps positioned to meet the contacts on the printhead.

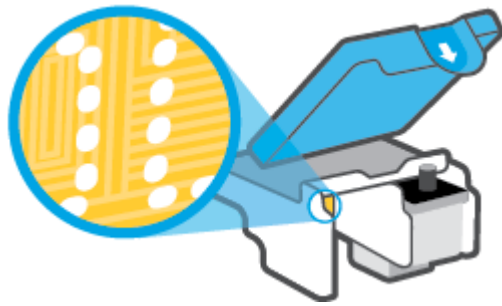

- d. Use a dry swab or lint-free cloth to wipe the contacts.

 **NOTE:** Be careful to wipe only the contacts, do not smear any ink or other debris on the contacts.

8. Reinstall the printhead.

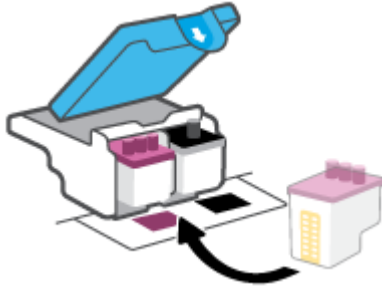

9. Close the printhead latch. Make sure the printhead latch is properly closed to avoid problems such as carriage jams.

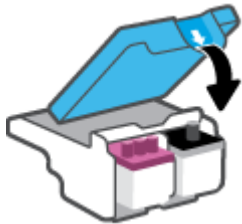

10. Close the front door of the printer.
11. Check if the error message has gone away. If you still receive the error message, turn the printer off, and then on.

Printing issues

Fix problems with page not printing (unable to print)

HP Print and Scan Doctor	The HP Print and Scan Doctor is a utility that will try to diagnose and fix the issue automatically. NOTE: This utility is only available for the Windows operating system.
Troubleshoot problems with print jobs not printing.	Use an HP online troubleshooting wizard Get step-by-step instructions if the printer is not responding or printing.



NOTE: The HP Print and Scan Doctor and the HP online troubleshooting wizards may not be available in all languages.

Read general instructions in the Help for unable to print issues

To resolve print issues (Windows)

Make sure that the printer is turned on and that there is paper in the input tray. If you are still unable to print, try the following in order:

1. Check for error messages from the printer software and resolve them by following the on-screen instructions.
2. If your computer is connected to the printer with a USB cable, disconnect and reconnect the USB cable.
If your computer is connected to the printer with a wireless connection, confirm that the connection is working.
3. Verify that the printer is not paused or offline.

To verify that the printer is not paused or offline

- a. Depending upon your operating system, do one of the following:
 - **Windows 10:** From the Windows **Start** menu, select **Windows System** from the app list, select **Control Panel**, and then click **View devices and printers** under **Hardware and Sound**.
 - **Windows 7:** From the Windows **Start** menu, click **Devices and Printers**.
 - b. Either double-click or right-click the icon for your printer and select **See what's printing** to open the print queue.
 - c. On the **Printer** menu, make sure there are no check marks next to **Pause Printing** or **Use Printer Offline**.
 - d. If you made any changes, try to print again.
4. Verify that the printer is set as the default printer.

To verify that the printer is set as the default printer

- a. Depending upon your operating system, do one of the following:

- **Windows 10:** From the Windows **Start** menu, select **Windows System** from the app list, select **Control Panel**, and then click **View devices and printers** under **Hardware and Sound**.
 - **Windows 7:** From the Windows **Start** menu, click **Devices and Printers**.
- b. Make sure the correct printer is set as the default printer.
- The default printer has a check mark in a black or green circle next to it.
- c. If the wrong printer is set as the default printer, right-click the correct printer and select **Set as Default Printer**.
- d. Try using your printer again.
5. Restart the print spooler.

To restart the print spooler

- a. Depending upon your operating system, do one of the following:
- **Windows 10 :** From the Windows **Start** menu, click **Windows System**, and then click **Control Panel**.
 - **Windows 7:** From the Windows **Start** menu, click **Control Panel**.
- b. Click **System and Security**, and then click **Administrative Tools**.
- c. Double-click **Services**.
- d. Right-click the **Print Spooler**, and then click **Properties**.
- e. On the **General** tab, make sure **Automatic** is selected from the **Startup type** drop-down list.
- f. Under **Service status**, check the status.
- If the service is not running, click **Start**.
 - If the service is running, click **Stop**, and then click **Start** to restart the service.
- Then click **OK**.
6. Restart the computer.
7. Clear the print queue.

To clear the print queue

- a. Depending upon your operating system, do one of the following:
- **Windows 10:** From the Windows **Start** menu, click **Windows System**, and then click **Control Panel**. Under **Hardware and Sound**, click **View devices and printers**.
 - **Windows 7:** From the Windows **Start** menu, click **Devices and Printers**.
- b. Right-click the printer, and then select the option to see what is printing.
- c. On the **Printer** menu, click **Cancel all documents** or **Purge Print Document**, and then click **Yes** to confirm.

- d. If there are still documents in the queue, restart the computer and try printing again after the computer has restarted.
- e. Check the print queue again to make sure it is clear, and then try to print again.

To resolve print issues (macOS)

1. Check for error messages and resolve.
2. Disconnect and reconnect the USB cable.
3. Verify that the product is not paused or offline.

To verify that the product is not paused or offline

- a. In **System Preferences**, click **Printers & Scanners**.
- b. Click the **Open Print Queue** button.
- c. Click a print job to select it.

Use the following buttons to manage the print job:

- **Delete:** Cancel the selected print job.
 - **Hold:** Pause the selected print job.
 - **Resume:** Continue a paused print job.
 - **Pause Printer:** Pause all print jobs in the print queue.
- d. If you made any changes, try to print again.
4. Restart the computer.

Fix print quality issues

[Step-by-step instructions for resolving most print quality issues.](#)

Troubleshoot print quality issues online

Read general instructions in the Help for resolving print quality issues



NOTE: To avoid print quality problems, always turn the printer off using the Power button, and wait until the Power button light goes out before you pull the plug or turn off a power strip. This allows the printer to move the printheads to a capped position, where they are protected from drying out.

To improve print quality, see [Improve print quality on page 59](#).

Copy issues

For more information, see [Tips for successful scanning and copying on page 51](#).

Troubleshoot copy problems.	Use an HP online troubleshooting wizard Get step-by-step instructions if the printer does not create a copy, or if your printouts are low quality.
---	---



NOTE: The HP online troubleshooting wizards may not be available in all languages.

Scan issues

For more information, see [Tips for successful scanning and copying on page 51](#).

HP Print and Scan Doctor	The HP Print and Scan Doctor is a utility that will try to diagnose and fix the issue automatically. NOTE: This utility is only available for the Windows operating system.
Solve scan problems	Use an HP online troubleshooting wizard. Get step-by-step instructions if you cannot scan or if your scans are low quality.



NOTE: The HP Print and Scan Doctor and the HP online troubleshooting wizards might not be available in all languages.

Network and connection issues

Fix network connection issues

Choose one of the following troubleshooting options.

HP Print and Scan Doctor	The HP Print and Scan Doctor is a utility that will try to diagnose and fix the issue automatically. NOTE: This utility is only available for the Windows operating system.
Use an HP online troubleshooting wizard	<ul style="list-style-type: none">• Troubleshoot your wireless problem, whether your printer has never been connected or it was connected and is no longer working.• Troubleshoot a firewall or antivirus issue, if you suspect that it is preventing your computer from connecting to the printer.• Find network settings for a wireless connection, if you do not remember your wireless network name (SSID) or password.• Convert a USB connection to wireless, to eliminate the USB cable between your devices and operate the printer over a wireless network.



NOTE: The HP Print and Scan Doctor and the HP online troubleshooting wizards may not be available in all languages.

Read general instructions in the Help for wireless troubleshooting

- ▲ Print the wireless network test report and network configuration page. For more information, see [Change wireless settings on page 74](#).

Find network settings for wireless connection

Choose one of the following troubleshooting options.

HP Print and Scan Doctor	The HP Print and Scan Doctor is a utility that can tell you the network name (SSID) and password (network key). NOTE: This utility is only available for the Windows operating system.
Use an HP online troubleshooting wizard	Learn how to find your network name (SSID) and wireless password.



NOTE: The HP Print and Scan Doctor and the HP online troubleshooting wizards may not be available in all languages.

Fix Wi-Fi Direct connection

For more information on Wi-Fi Direct, see [Connect wirelessly to the printer without a router \(Wi-Fi Direct\) on page 70](#).

Use an HP online troubleshooting wizard	Troubleshoot your Wi-Fi Direct problem or learn how to configure Wi-Fi Direct.
---	--



NOTE: The HP online troubleshooting wizards may not be available in all languages.

Read general instructions in the Help for Wi-Fi Direct troubleshooting

1. Make sure that the Wi-Fi Direct icon on the printer display is on. To turn on Wi-Fi Direct, see [Connect wirelessly to the printer without a router \(Wi-Fi Direct\) on page 70](#).
2. From your wireless computer or mobile device, turn on the wireless (Wi-Fi) connection, and then search for and connect to the Wi-Fi Direct name of your printer.



NOTE: To find the Wi-Fi Direct name or password, touch  (Wi-Fi Direct) from the Home screen on the printer control panel display.

3. Enter the Wi-Fi Direct password when prompted.
4. If you are using a mobile device, make sure you have installed a compatible printing app. For more information about mobile printing, visit www.hp.com/global/us/en/eprint/mobile_printing_apps.html.

Convert USB connection to wireless

To change the connection type, see [Change from a USB connection to a wireless network on page 76](#).

Choose one of the following troubleshooting options.

HP Print and Scan Doctor	The HP Print and Scan Doctor is a utility that will try to diagnose and fix the issue automatically. NOTE: This utility is only available for the Windows operating system.
Use an HP online troubleshooting wizard	Convert a USB connection to wireless or Wi-Fi Direct.



NOTE: The HP Print and Scan Doctor and the HP online troubleshooting wizards may not be available in all languages.

Printer hardware issues

Close printer door

- Make sure the printhead access door and the front door are properly closed.

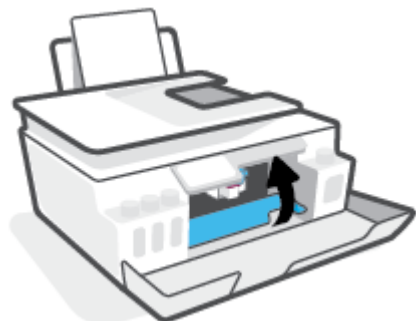

The printer shuts down unexpectedly

- Check the power and power connections.
- Make sure the printer's power cord is connected firmly to a functioning power outlet.



NOTE: When Auto-Off is enabled, the printer will automatically turn off after 2 hours of inactivity to help reduce energy use. For more information, see [Auto-Off on page 16](#).

Resolve printer failure

- Turn the printer off, then on. If that does not resolve the problem, contact HP.

Solve problems using Web Services

If you are having problems using Web Services, such as HP ePrint, check the following:

- Make sure the printer is connected to the Internet using a wireless connection.
- Make sure the latest product updates have been installed on the printer.
- Make sure Web Services is enabled on the printer. For more information, see [Set up Web Services on page 36](#).
- Make sure the network hub, switch, or router is turned on and working correctly.
- If you are connecting the printer using a wireless connection, make sure the wireless network is functioning properly. For more information, see [Network and connection issues on page 105](#).
- If you are using HP ePrint, check the following:
 - Make sure the printer's email address is correct.
 - Make sure that the printer's email address is the only address listed in the "To" line of the email message. If other email addresses are listed in the "To" line, the attachments you are sending might not print.
 - Make sure you are sending documents that meet the HP ePrint requirements. For more information, visit www.hpconnected.com (might not be available in all countries/regions).
- If your network uses proxy settings when connecting to the Internet, make sure the proxy settings you are entering are valid:
 - Check the settings being used by the web browser you are using (such as Internet Explorer, Firefox, or Safari).
 - Check with the IT administrator or person who set up your firewall.

If the proxy settings used by your firewall have changed, you must update these settings in either the printer control panel or the embedded web server. If these settings are not updated, you will not be able to use Web Services.

For more information, see [Set up Web Services on page 36](#).



TIP: For additional help on setting up and using Web Services, visit www.hpconnected.com. (might not be available in all countries/regions).



Restore original factory defaults and settings

- If you have made changes to the printer or network settings, you can restore the printer to the original factory settings or network settings.
- If more than two hours have passed since you first turned on the printer and you have not set up the printer wirelessly, place the printer in network setup mode by restoring the printer network settings. The setup mode will last for two hours.
- You can also troubleshoot network connection issues by restoring the printer network settings.

 **CAUTION:** If you restore the printer network settings, you will need to reconnect the printer to the network.

To restore the printer network settings from the printer control panel

You can place the printer in network setup mode by restoring the printer network settings.

1. From the Home screen, touch  (Wireless) and then touch  (Settings).
2. Touch **Restore Network Settings**, and then follow the onscreen instructions.
3. Print the network configuration page and verify that the network settings have been reset.

 **NOTE:** When you reset the printer network settings, previously configured wireless settings (such as the link speed or IP address) are removed. The IP address is set back to the Automatic mode.

 **TIP:** You can visit www.support.hp.com for information and utilities that can help you correct many common printer problems.

(Windows) Run the [HP Print and Scan Doctor](#) to diagnose and automatically fix printing, scanning, and copying issues. The application is only available in some languages.

To restore the printer to the original factory defaults

1. From the Home screen on the printer control panel display, touch  (**Setup**).
2. Touch **Tools**, touch **Restore Factory Defaults**, and then follow the onscreen instructions.

Maintain the printer

- [Clean the scanner glass](#)
- [Clean the exterior](#)
- [Clean the document feeder](#)

Clean the scanner glass

Dust or dirt on the scanner glass, scanner lid backing, or scanner frame can slow down performance, degrade the quality of scans, and affect the accuracy of special features such as fitting copies to a certain page size.

To clean the scanner glass

⚠ WARNING! Before cleaning the printer, turn the printer off by pressing  (the Power button), and unplug the power cord from the electrical socket.

1. Lift the scanner lid.



2. Clean the scanner glass and lid backing by using a soft, lint-free cloth that has been sprayed with a mild glass cleaner.



⚠ CAUTION: Use only glass cleaner to clean the scanner glass. Avoid cleaners that contain abrasives, acetone, benzene, and carbon tetrachloride, all of which can damage the scanner glass. Avoid isopropyl alcohol because it can leave streaks on the scanner glass.

⚠ CAUTION: Do not spray the glass cleaner directly on the scanner glass. If too much glass cleaner is applied, the cleaner could leak under the scanner glass and damage the scanner.

3. Close the scanner lid, and turn on the printer.

Clean the exterior

⚠ WARNING! Before cleaning the printer, turn the printer off by pressing the power button  (the Power button), and unplugging the power cord from the electrical socket.

Use a soft, damp, lint-free cloth to wipe dust, smudges, and stains off of the case. Keep fluids away from the interior of the printer, as well as from the printer control panel.

Clean the document feeder

If the document feeder picks up multiple pages or if it does not pick up plain paper, you can clean the rollers and separator pad.

To clean the rollers or separator pad

⚠ WARNING! Before cleaning the printer, turn the printer off by pressing  (the Power button), and unplug the power cord from the electrical socket.

1. Remove all originals from the document feeder tray.

2. Lift the document feeder cover.



This provides easy access to the rollers (1) and separator pad (2).

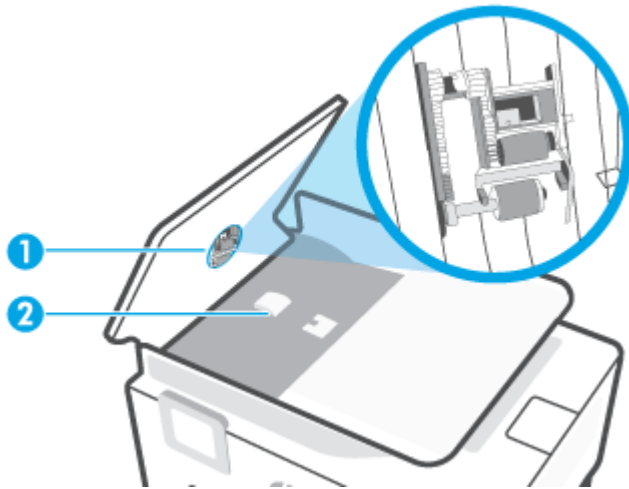

-
- | | |
|---|----------------|
| 1 | Rollers. |
| 2 | Separator pad. |
-

3. Lightly dampen a clean lint-free cloth with distilled water, then squeeze any excess liquid from the cloth.
 4. Use the damp cloth to wipe any residue off the rollers or separator pad.
-
-  **NOTE:** If the residue does not come off using distilled water, try using isopropyl (rubbing) alcohol.
-
5. Close the cover of the document feeder.

HP support

For the latest product updates and support information, visit www.support.hp.com. HP online support provides a variety of options for help with your printer:



Drivers & downloads: Download software drivers and updates, as well as product manuals and documentation that came in the box with your printer.



HP support forums: Visit HP Support Forums for answers to common questions and issues. You can view questions posted by other HP customers, or sign in and post your own questions and comments.



Troubleshooting: Use HP online tools to detect your printer and find recommended solutions.



NOTE: You can also use the HP Smart app to check printer errors and get troubleshooting assistance. For information about this app, see [Use the HP Smart app to print, scan, and troubleshoot on page 12](#).

Contact HP

If you need help from an HP technical support representative to solve a problem, visit the [Contact Support website](#). The following contact options are available at no cost for in-warranty customers (HP agent-assisted support for out-of-warranty customers may require a fee):



Chat with an HP support agent online.



Call an HP support agent.

When contacting HP support, be prepared to provide the following information:

- Product name (located on the printer)
- Product number (located inside the front door)

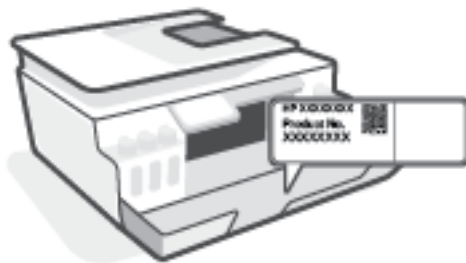

- Serial number (located on the back or bottom of the printer)

Register printer

By taking just a few quick minutes to register, you can enjoy quicker service, more efficient support, and product support alerts. If you did not register your printer while installing the software, you can register now at <http://www.register.hp.com>.

Additional warranty options

Extended service plans are available for the printer at additional costs. Go to www.support.hp.com, select your country/region and language, then explore the extended warranty options available for your printer.

A Technical information

The information contained herein is subject to change without notice.

This section contains the following topics:

- [Specifications](#)
- [Regulatory notices](#)
- [Environmental product stewardship program](#)

Specifications

For more information, visit www.support.hp.com .

System requirements

- For information about future operating system releases and support, visit www.support.hp.com .

Environmental specifications

- Recommended operating temperature range: 15°C to 30°C (59°F to 86°F)
- Operating temperature range: 5°C to 40°C (41°F to 104°F)
- Recommended Operating Humidity range: 20% to 80% RH non-condensing
- Operating Humidity range: 15% to 80% RH non-condensing
- Nonoperating (Storage) temperature range: -40°C to 60°C (-40°F to 140°F)
- In the presence of high electromagnetic fields, it is possible the output from the printer may be slightly distorted
- HP recommends using a USB cable less than or equal to 3 m (10 feet) in length to minimize injected noise due to potential high electromagnetic fields

Input tray capacity

- Plain paper sheets (75 g/m² [20lb]): Up to 100
- Envelopes: Up to 10
- Index cards: Up to 30
- Photo paper sheets: Up to 30

Output tray capacity

- Plain paper sheets (75 g/m² [20lb]): Up to 30
- Envelopes: Up to 10
- Index cards: Up to 30
- Photo paper sheets: Up to 30

Paper type and size

- For a complete list of supported media, see the printer software or the embedded web server (EWS). To open EWS, see [Open the embedded web server on page 77](#).

Paper weights

- Plain Paper: 60 to 90 g/m² (16 to 24 lb)
- Envelopes: 75 to 90 g/m² (20 to 24 lb)

- Cards: Up to 200 g/m² (110-lb index maximum)
- Photo Paper: Up to 300 g/m² (80 lb)

Print specifications

- Print speeds vary according to the complexity of the document
- Method: drop-on-demand thermal inkjet
- Language: PCL3 GUI

Copy specifications

- Resolution: up to 600 dpi
- Digital image processing
- Copy speeds vary according to the complexity of the document and model

Scan specifications

- Resolution: up to 1200 x 1200 ppi optical
For more information about ppi resolution, see the scanner software.
- Color: 24-bit color, 8-bit grayscale (256 levels of gray)
- Maximum scan size from glass: 21.6 x 29.7 cm (8.5 x 11.7 inches)

Print resolution

- For supported print resolutions, visit www.support.hp.com.

Acoustic information

- If you have Internet access, you can access acoustic information from the [HP website](#).

Regulatory notices

The printer meets product requirements from regulatory agencies in your country/region.

This section contains the following topics:

- [Regulatory model number](#)
- [Power cord instructions](#)
- [Visual display workplaces statement for Germany](#)
- [Noise emission statement for Germany](#)
- [European Union Regulatory Notice](#)
- [Declaration of conformity](#)
- [Regulatory wireless and wired statements](#)

Regulatory model number

For regulatory identification purposes, your product is assigned with a Regulatory Model Number. The regulatory model number should not be confused with the marketing names or product numbers.

Power cord instructions

Make sure your power source is adequate for the product voltage rating. The voltage rating is on the product. The product uses either 100-240 Vac or 200-240 Vac and 50/60 Hz.

⚠ CAUTION: To prevent damage to the product, use only the power cord that is provided with the product.

Visual display workplaces statement for Germany

GS-Erklärung (Deutschland)

Das Gerät ist nicht für die Benutzung im unmittelbaren Gesichtsfeld am Bildschirmarbeitsplatz vorgesehen. Um störende Reflexionen am Bildschirmarbeitsplatz zu vermeiden, darf dieses Produkt nicht im unmittelbaren Gesichtsfeld platziert werden.

Noise emission statement for Germany

Geräuschemission

LpA < 70 dB am Arbeitsplatz im Normalbetrieb nach DIN 45635 T. 19

European Union Regulatory Notice



Products bearing the CE marking comply to applicable EU Directives and related European Harmonised Standards. The full Declaration of Conformity can be found at the following website:

www.hp.eu/certificates (Search with the product model name or its Regulatory Model Number (RMN), which may be found on the regulatory label.)

The point of contact for regulatory matters is HP Deutschland GmbH, HQ-TRE, 71025, Boeblingen, Germany.

Products with wireless functionality

EMF

- This product meets international guidelines (ICNIRP) for exposure to radio frequency radiation.

If it incorporates a radio transmitting and receiving device that in normal use, a separation distance of 20 cm ensures that radio frequency exposure levels comply with EU requirements.

Wireless functionality in Europe

- For products with 802.11 b/g/n or Bluetooth radio:
 - This product operates on radio frequency between 2400 MHz and 2483.5 MHz, with a transmit power of 20 dBm (100 mW) or less.
- For products with 802.11 a/b/g/n radio:
 - This product operates on radio frequencies between 2400 MHz and 2483.5 MHz, and between 5170 MHz and 5710 MHz, with a transmit power of 20 dBm (100 mW) or less.



AT	BE	BG	CH	CY
CZ	DE	DK	EE	EL
ES	FI	FR	HR	HU
IE	IS	IT	LI	LT
LU	LV	MT	NL	NO
PL	PT	RO	RS	SE
SI	SK	TR	UK	

CAUTION: IEEE 802.11x wireless LAN with 5.15-5.35 GHz frequency band is restricted for **indoor use only** for all countries reflected in the matrix. Using this WLAN application outdoor might lead to interference issues with existing radio services.

Declaration of conformity

Declaration of conformity can be found at www.hp.eu/certificates.

Regulatory wireless and wired statements

This section contains the following regulatory information pertaining to wireless and wired products:

- [Notice to users in Brazil](#)
- [Notice to users in Taiwan](#)
- [Notice to users in Mexico](#)
- [Notice to users in Ukraine](#)
- [Notice to users in Taiwan \(5 GHz\)](#)
- [Notice to users in Serbia \(5 GHz\)](#)

- [Notice to users in Thailand \(5 GHz\)](#)

Notice to users in Brazil

Este equipamento não tem direito à proteção contra interferência prejudicial e não pode causar interferência em sistemas devidamente autorizados.

Notice to users in Taiwan

低功率電波輻射性電機管理辦法

第十二條

經型式認證合格之低功率射頻電機，非經許可，公司、商號或使用者均不得擅自變更頻率、加大功率或變更設計之特性及功能。

第十四條

低功率射頻電機之使用不得影響飛航安全及干擾合法通信；經發現有干擾現象時，應立即停用，並改善至無干擾時方得繼續使用。

前項合法通信，指依電信法規定作業之無線電通信。低功率射頻電機須忍受合法通信或工業、科學及醫藥用電波輻射性電機設備之干擾。

Notice to users in Mexico

La operación de este equipo está sujeta a las siguientes dos condiciones: (1) es posible que este equipo o dispositivo no cause interferencia perjudicial y (2) este equipo o dispositivo debe aceptar cualquier interferencia, incluyendo la que pueda causar su operación no deseada.

Para saber el modelo de la tarjeta inalámbrica utilizada, revise la etiqueta regulatoria de la impresora.

Notice to users in Ukraine

Повідомлення для користувачів в Україні

Технологія, що використовується	Радіочастотні діапазони	Максимальна потужність передавання
WLAN Wi-Fi 802.11x (2,4 ГГц)	2400–2483,5 МГц	< 100 мВт (20 дБм) ЕІВП
Bluetooth з низьким енергоспоживанням (2,4 ГГц)	2400–2483,5 МГц	< 100 мВт (20 дБм) ЕІВП
Bluetooth (2,4 ГГц)	2400–2483,5 МГц	< 100 мВт (20 дБм) ЕІВП
WLAN Wi-Fi 802.11x (5 ГГц)	5150–5350 МГц 5470–5835 МГц	< 100 мВт (20 дБм) ЕІВП



NOTE: Відповідні частотні діапазони та максимальна потужність передавання застосовуються, лише якщо в пристрої використовується зазначена технологія підключення.

Notice to users in Taiwan (5 GHz)

在 5.25-5.35 赫茲頻帶內操作之無線資訊傳輸設備，限於室內使用。應避免影響附近雷達系統之操作。

Notice to users in Serbia (5 GHz)

Upotreba ovog uređaja je ogranična na zatvorene prostore u slučajevima koriscenja na frekvencijama od 5150-5350 MHz.

Notice to users in Thailand (5 GHz)

เครื่องวิทยุคมนาคมนี้มีระดับการแผ่คลื่นแม่เหล็กไฟฟ้าสอดคล้องตามมาตรฐานความปลอดภัยต่อสุขภาพของมนุษย์จากการใช้เครื่องวิทยุคมนาคมที่คณะกรรมการกิจการโทรคมนาคมแห่งชาติประกาศกำหนด

This radio communication equipment has the electromagnetic field strength in compliance with the Safety Standard for the Use of Radio Communication Equipment on Human Health announced by the National Telecommunications Commission.

Environmental product stewardship program

HP is committed to providing quality products in an environmentally sound manner. Design for recycling has been incorporated into this product. The number of materials has been kept to a minimum while ensuring proper functionality and reliability. Dissimilar materials have been designed to separate easily. Fasteners and other connections are easy to locate, access, and remove using common tools. High priority parts have been designed to access quickly for efficient disassembly and repair.

For more information, visit HP's Commitment to the Environment Web site at:

www.hp.com/sustainableimpact.

- [Eco-Tips](#)
- [European Union Commission Regulation 1275/2008](#)
- [Paper](#)
- [Plastics](#)
- [Safety data sheets](#)
- [Recycling program](#)
- [HP inkjet supplies recycling program](#)
- [Power consumption](#)
- [Disposal of waste equipment by users](#)
- [Waste disposal for Brazil](#)
- [Chemical substances](#)
- [The Table of Hazardous Substances/Elements and their Content \(China\)](#)
- [Declaration of the Presence Condition of the Restricted Substances Marking \(Taiwan\)](#)
- [Restriction of hazardous substance \(India\)](#)
- [Regulation on the Control of Waste Electrical and Electronic Equipment \(Turkey\)](#)
- [EPEAT](#)
- [SEPA Ecolabel User Information \(China\)](#)
- [China Energy Label for Printer, Fax and Copier](#)
- [Battery disposal in Taiwan](#)
- [European Union Battery Directive](#)
- [Battery notice for Brazil](#)
- [California Perchlorate Material Notice](#)

Eco-Tips

HP is committed to helping customers reduce their environmental footprint. Please visit the HP Eco Solutions website for more information on HP's environmental initiatives.

www.hp.com/sustainableimpact

European Union Commission Regulation 1275/2008

For product power data, including the power consumption of the product in networked standby if all wired network ports are connected and all wireless network ports are activated, please refer to section P15 'Additional Information' of the product IT ECO Declaration at www.hp.com/hpinfo/globalcitizenship/environment/productdata/itecodesktop-pc.html.

Paper

This product is suited for the use of recycled paper according to DIN 19309 and EN 12281:2002.

Plastics

Plastic parts over 25 grams are marked according to international standards that enhance the ability to identify plastics for recycling purposes at the end of product life.

Safety data sheets

Safety Data Sheets, product safety and environmental information are available at www.hp.com/go/ecodata or on request.

Recycling program

HP offers an increasing number of product return and recycling programs in many countries/regions, and partners with some of the largest electronic recycling centers throughout the world. HP conserves resources by reselling some of its most popular products. For more information regarding recycling of HP products, please visit:

www.hp.com/recycle

HP inkjet supplies recycling program

HP is committed to protecting the environment. The HP Inkjet Supplies Recycling Program is available in many countries/regions, and lets you recycle used print cartridges and ink cartridges free of charge. For more information, go to the following website:

www.hp.com/hpinfo/globalcitizenship/environment/recycle/

Power consumption

HP printing and imaging equipment marked with the ENERGY STAR® logo is certified by the U.S. Environmental Protection Agency. The following mark will appear on ENERGY STAR certified imaging products:



Additional ENERGY STAR certified imaging product model information is listed at: www.hp.com/go/energystar

Disposal of waste equipment by users



This symbol means do not dispose of your product with your other household waste. Instead, you should protect human health and the environment by handing over your waste equipment to a designated collection point for the recycling of waste electrical and electronic equipment. For more information, please contact your household waste disposal service, or go to <http://www.hp.com/recycle>.

Waste disposal for Brazil



Não descarte o produto eletrônico em lixo comum

Este produto eletrônico e seus componentes não devem ser descartados no lixo comum, pois embora estejam em conformidade com padrões mundiais de restrição a substâncias nocivas, podem conter, ainda que em quantidades mínimas, substâncias impactantes ao meio ambiente. Ao final da vida útil deste produto, o usuário deverá entregá-lo à HP. A não observância dessa orientação sujeitará o infrator às sanções previstas em lei.

Após o uso, as pilhas e/ou baterias dos produtos HP deverão ser entregues ao estabelecimento comercial ou rede de assistência técnica autorizada pela HP.

Para maiores informações, inclusive sobre os pontos de recebimento, acesse:

www.hp.com.br/reciclar

Chemical substances

HP is committed to providing our customers with information about the chemical substances in our products as needed to comply with legal requirements such as REACH (*Regulation EC No 1907/2006 of the European Parliament and the Council*). A chemical information report for this product can be found at: www.hp.com/go/reach.

The Table of Hazardous Substances/Elements and their Content (China)

产品中有害物质或元素的名称及含量

根据中国《电器电子产品有害物质限制使用管理办法》



部件名称	有害物质					
	铅 (Pb)	汞 (Hg)	镉 (Cd)	六价铬 (Cr(VI))	多溴联苯 (PBB)	多溴二苯醚 (PBDE)
外壳和托盘	0	0	0	0	0	0
电线	0	0	0	0	0	0
印刷电路板	X	0	0	0	0	0
打印系统	X	0	0	0	0	0
显示器	X	0	0	0	0	0

部件名称	有害物质					
	铅 (Pb)	汞 (Hg)	镉 (Cd)	六价铬 (Cr(VI))	多溴联苯 (PBB)	多溴二苯醚 (PBDE)
喷墨打印机墨盒	0	0	0	0	0	0
驱动光盘	X	0	0	0	0	0
扫描仪	X	0	0	0	0	0
网络配件	X	0	0	0	0	0
电池板	X	0	0	0	0	0
自动双面打印系统	0	0	0	0	0	0
外部电源	X	0	0	0	0	0

本表格依据 SJ/T 11364 的规定编制。

0：表示该有害物质在该部件所有均质材料中的含量均在 GB/T 26572 规定的限量要求以下。

X：表示该有害物质至少在该部件的某一均质材料中的含量超出 GB/T 26572 规定的限量要求。

此表中所有名称中含“X”的部件均符合欧盟 RoHS 立法。

注：环保使用期限的参考标识取决于产品正常工作的温度和湿度等条件。

Declaration of the Presence Condition of the Restricted Substances Marking (Taiwan)

台灣 限用物質含有情況標示聲明書

Taiwan Declaration of the Presence Condition of the Restricted Substances Marking

單元 Unit	限用物質及其化學符號 Restricted substances and its chemical symbols					
	鉛 (Pb)	汞 (Hg)	鎘 (Cd)	六價鉻 (Cr ⁺⁶)	多溴聯苯 (PBB)	多溴二苯醚 (PBDE)
列印引擎 Print engine	—	○	○	○	○	○
外殼和紙匣 External casing and trays	○	○	○	○	○	○
電源供應器 Power supply	—	○	○	○	○	○
電線 Cables	○	○	○	○	○	○
印刷電路板 Print printed circuit board	—	○	○	○	○	○
控制面板 Control panel	—	○	○	○	○	○
墨水匣 Cartridge	○	○	○	○	○	○
掃描器組件 Scanner assembly	—	○	○	○	○	○

備考 1. “超出 0.1 wt %” 及 “超出 0.01 wt %” 係指限用物質之百分比含量超出百分比含量基準值。

Note 1: “Exceeding 0.1 wt %” and “exceeding 0.01 wt %” indicate that the percentage content of the restricted substance exceeds the reference percentage value of presence condition.

備考 2. “○” 係指該項限用物質之百分比含量未超出百分比含量基準值。

Note 2: “○” indicates that the percentage content of the restricted substance does not exceed the percentage of reference value of presence.

備考 3. “—” 係指該項限用物質為排除項目。

Note 3: “—” indicates that the restricted substance corresponds to the exemption.

若要存取產品的最新使用指南或手冊，請前往 www.support.hp.com。選取搜尋您的產品，然後依照畫面上的指示繼續執行。

To access the latest user guides or manuals for your product, go to www.support.hp.com. Select **Find your product**, and then follow the onscreen instructions.

Restriction of hazardous substance (India)

This product, as well as its related consumables and spares, complies with the reduction in hazardous substances provisions of the "India E-waste Rule 2016." It does not contain lead, mercury, hexavalent chromium, polybrominated biphenyls or polybrominated diphenyl ethers in concentrations exceeding 0.1 weight % and 0.01 weight % for cadmium, except where allowed pursuant to the exemptions set in Schedule 2 of the Rule.

Regulation on the Control of Waste Electrical and Electronic Equipment (Turkey)

Türkiye Cumhuriyeti: AEEE Yönetmeliğine uygundur

EPEAT

Most HP products are designed to meet EPEAT. EPEAT is a comprehensive environmental rating that helps identify greener electronics equipment. For more information on EPEAT go to www.epeat.net. For information on HP's EPEAT registered products go to www.hp.com/hpinfo/globalcitizenship/environment/pdf/epeat_printers.pdf.

SEPA Ecolabel User Information (China)

中国环境标识认证产品用户说明

噪声大于 63.0 dB(A) 的办公设备不宜放置于办公室内，请在独立的隔离区域使用。

如需长时间使用本产品或打印大量文件，请确保在通风良好的房间内使用。

如您需要确认本产品处于零能耗状态，请按下电源关闭按钮，并将插头从电源插座断开。

您可以使用再生纸，以减少资源耗费。

China Energy Label for Printer, Fax and Copier

复印机、打印机和传真机能源效率标识实施规则

依据“复印机、打印机和传真机能源效率标识实施规则”，该打印机具有中国能效标识。标识上显示的能效等级和操作模式值根据“复印机、打印机和传真机能效限定值及能效等级”标准（“GB 21521”）来确定和计算。

1. 能效等级

产品能效等级分 3 级，其中 1 级能效最高。能效限定值根据产品类型和打印速度由标准确定。能效等级则根据基本功耗水平以及网络接口和内存等附加组件和功能的功率因子之和来计算。

2. 能效信息

喷墨打印机

- 操作模式功率

睡眠状态的能耗按照 GB 21521 的标准来衡量和计算。该数据以瓦特 (W) 表示。

- 待机功率

待机状态是产品连接到电网电源上功率最低的状态。该状态可以延续无限长时间，且使用者无法改变此状态下产品的功率。对于“成像设备”产品，“待机”状态通常相当于“关闭”状态，但也可能相当于“准备”状态或者“睡眠”状态。该数据以瓦特 (W) 表示。

- 睡眠状态预设延迟时间

出厂前由制造商设置的时间决定了该产品在完成主功能后进入低耗模式（例如睡眠、自动关机）的时间。该数据以分钟表示。

- 附加功能功率因子之和

网络接口和内存等附加功能的功率因子之和。该数据以瓦特 (W) 表示。

标识上显示的能耗数据是根据典型配置测量得出的数据，此类配置包含登记备案的打印机依据复印机、打印机和传真机能源效率标识实施规则所选的所有配置。因此，该特定产品型号的实际能耗可能与标识上显示的数据有所不同。

要了解规范的更多详情，请参考最新版的 GB 21521 标准。

Battery disposal in Taiwan



廢電池請回收

European Union Battery Directive



This product contains a battery that is used to maintain data integrity of real time clock or product settings and is designed to last the life of the product. Any attempt to service or replace this battery should be performed by a qualified service technician.

Battery notice for Brazil

A bateria deste equipamento nao foi projetada para removida pelo cliente.

California Perchlorate Material Notice

Perchlorate material - special handling may apply. See: www.dtsc.ca.gov/hazardouswaste/perchlorate

This product's real-time clock battery or coin cell battery may contain perchlorate and may require special handling when recycled or disposed of in California.

Index

- B**
 - buttons, control panel 5
- C**
 - clean
 - document feeder 111
 - exterior 111
 - scanner glass 110
 - control panel
 - buttons 5
 - features 5
 - lights 5
 - status icons 6
 - copy
 - specifications 117
 - customer support
 - warranty 114
- D**
 - document feeder
 - clean 111
 - feeding problems, troubleshoot 111
- E**
 - embedded web server
 - opening 77
 - Webscan 50
 - environment
 - Environmental product stewardship program 122
 - environmental specifications 116
- G**
 - glass, scanner
 - clean 110
- J**
 - jams
 - clear 85
- L**
 - lights, control panel 5
- M**
 - maintenance
 - clean 111
 - multi-feeds, troubleshoot 92
- N**
 - network connection
 - wireless connection 69
 - networks
 - view and print settings 74
- O**
 - operating systems supported 116
- P**
 - paper
 - clear jams 85
 - HP, order 10
 - skewed pages 92
 - troubleshoot feeding 91
 - paper-feed problems, troubleshoot 91
 - power
 - troubleshoot 107
 - print
 - specifications 117
 - troubleshoot 107
- R**
 - recycle
 - ink cartridges 123
- S**
 - regulatory notices 118
 - regulatory model identification number 118
 - wireless statements 119
 - scan
 - from Webscan 50
 - scan specifications 117
 - scanner glass
 - clean 110
 - skew, troubleshoot
 - print 92
 - software
 - Webscan 50
 - specifications
 - system requirements 116
 - status icons 6
 - system requirements 116
- T**
 - technical information
 - copy specifications 117
 - environmental specifications 116
 - print specifications 117
 - scan specifications 117
 - trays
 - clear paper jams 85
 - troubleshoot feeding 91
 - troubleshoot
 - control panel help system 83
 - multiple pages are picked 92
 - paper not picked up from tray 91
 - paper-feed problems 91
 - power 107
 - print 107
 - skewed pages 92

V

view

network settings 74

W

warranty 114

Webscan 50

Windows

system requirements 116