

# Quick Setup

Before using the projector, make sure you read the safety instructions in the online *User's Guide*.

**Note:** Your product may differ from the illustrations on this sheet, but the instructions are the same.

## Connect the projector

Choose from the following connections. See the sections below or the online *User's Guide* for details.

### Computer

#### PowerLite W39

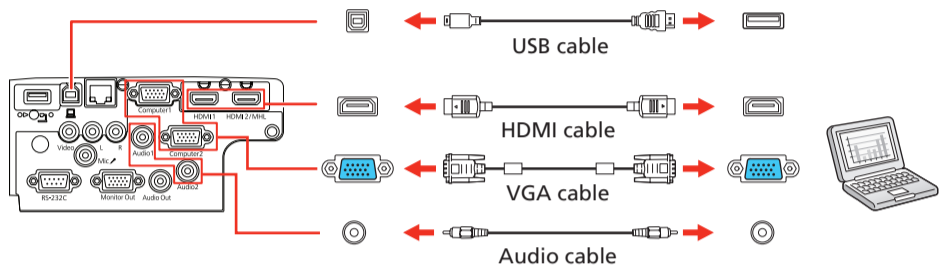

#### PowerLite S39/X39

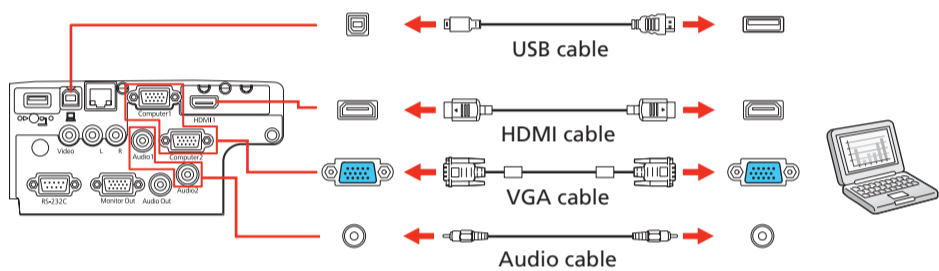

### HDMI port

Connect one end of an HDMI cable to one of the projector's HDMI ports shown above and the other end to an HDMI port on your computer.

### Computer port

Connect one end of a VGA cable to the projector's **Computer1** or **Computer2** port, and the other end to your laptop or computer's monitor port. Make sure to switch your laptop to external display (see "Troubleshooting" on the back of this sheet). You can also connect an audio cable.

### USB port

Connect the square end of a USB cable to the projector's USB-B (square) port. Connect the flat end of the cable to any USB port on your computer.

**Windows Vista® or later:** After turning on the projector, follow the on-screen instructions to install the Epson® USB Display software (**EMP\_UDSE.EXE**; only on first connection). If the software screen does not display automatically, open **My Computer**, **Computer**, or **This PC**, then double-click **EPSON\_PJ\_UD**.

**OS X 10.7.x or higher:** After turning on the projector, the setup folder for USB Display appears in the Finder. Double-click **USB Display Installer** and follow the on-screen instructions to install the Epson USB Display software (only on first connection).

### Video device

Connect multiple video devices and use the **Source Search** button on the projector or remote control to switch between them.

#### PowerLite W39

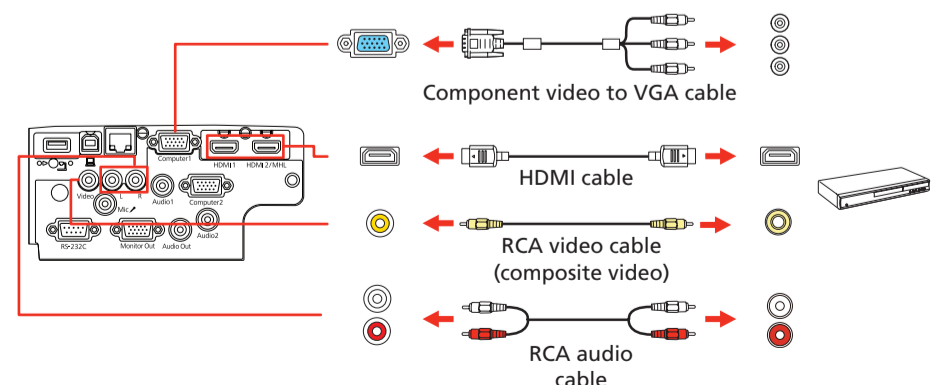

#### PowerLite S39/X39

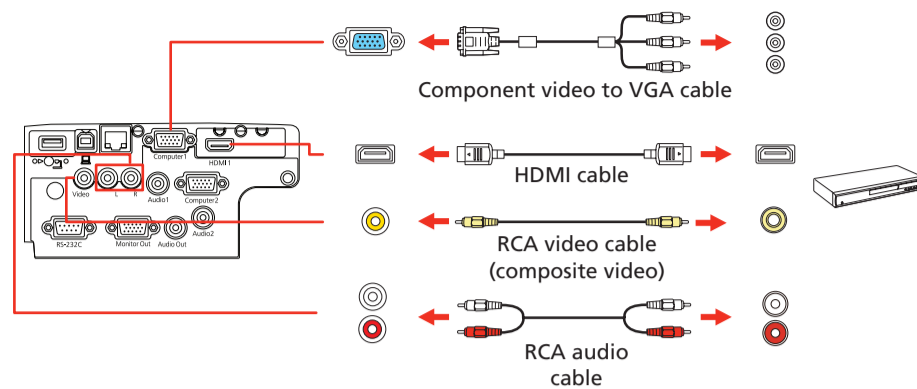

### USB device or Epson DC-07 document camera

Connect a digital camera, USB flash drive, USB storage device, or Epson DC-07 document camera to the projector's USB-A (flat) port.

#### PowerLite W39

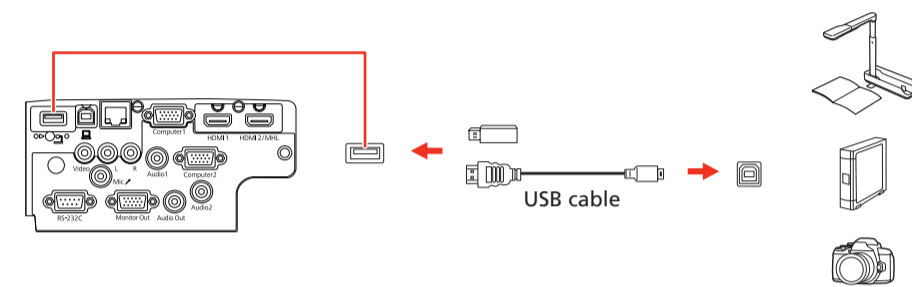

#### PowerLite S39/X39

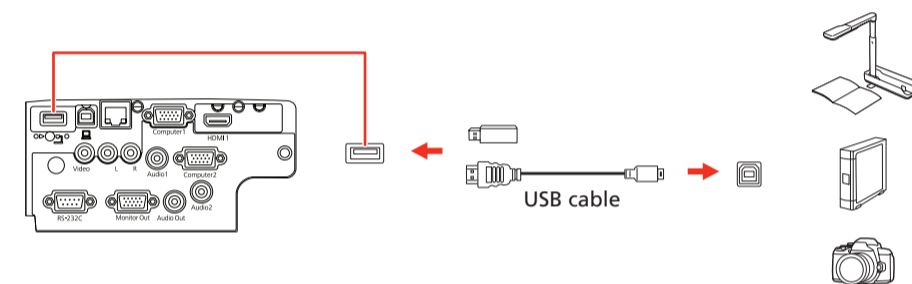

If you connect a digital camera, USB flash drive, or USB storage device, you can use the projector's PC Free feature. See the online *User's Guide* for details.

## Turn on your equipment

- 1 Turn on your computer or video source.
- 2 Plug in the projector. The power light on the projector turns blue.

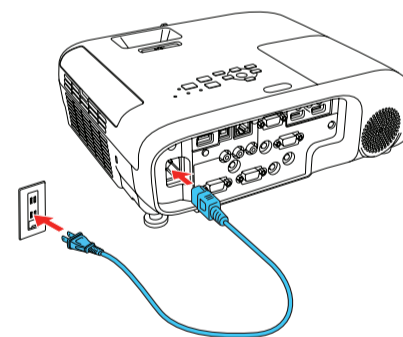

- 3 Open the A/V Mute slide all the way.

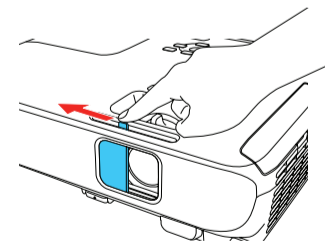

- 4 Press the power button on the projector or remote control. The projector beeps, the Status light flashes blue, and then stays on.

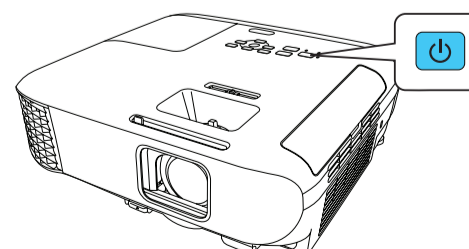

**Note:** To shut down the projector, press the power button twice.



- Use the arrow buttons on the remote control to highlight any of the options on the Home screen that appears, then press to select it. You can switch between projection sources and quickly access various adjustment options from this screen.



- The default language of the menu system is English. To select another language, press the **Menu** button on the projector or remote control. Select **Extended** and press . Select **Language** and press . Select your language and press . Press the **Menu** button to exit the menu system.

## Adjust the image

- If you don't see an image, press the **Source Search** button on the projector or remote control to select the image source.  
**Note:** If you still see a blank screen or have other display problems, see the troubleshooting tips on the back of this sheet.
- To raise the image, press the foot release button and lift the front of the projector. Release the button to lock the foot in position.

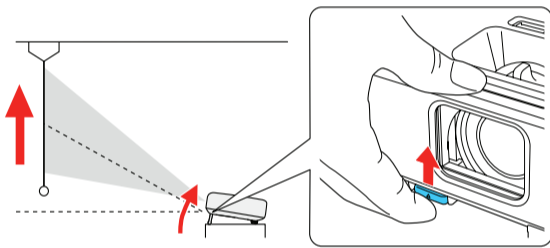

- To reduce or enlarge the image, turn the zoom ring.

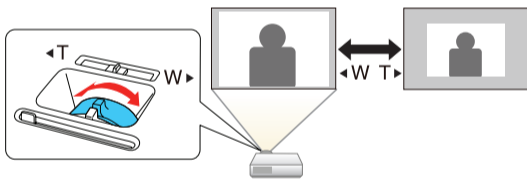

- To sharpen the image, turn the focus ring.

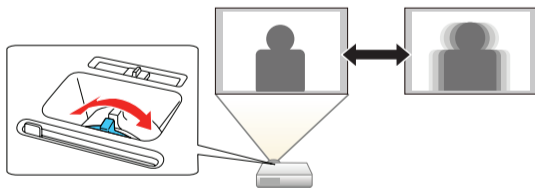

- If your image looks like or , you may have placed the projector off to one side of the screen at an angle. Place the projector directly in front of the center of the screen, facing the screen squarely. If you can't move the projector, use the horizontal keystone slider on the projector to correct the image shape.

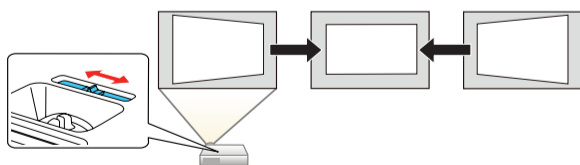

- Your projector automatically adjusts images that look like or , but if necessary you can press the or button on the projector to correct it.

## Using the remote control

Install the batteries as shown (two AA batteries).

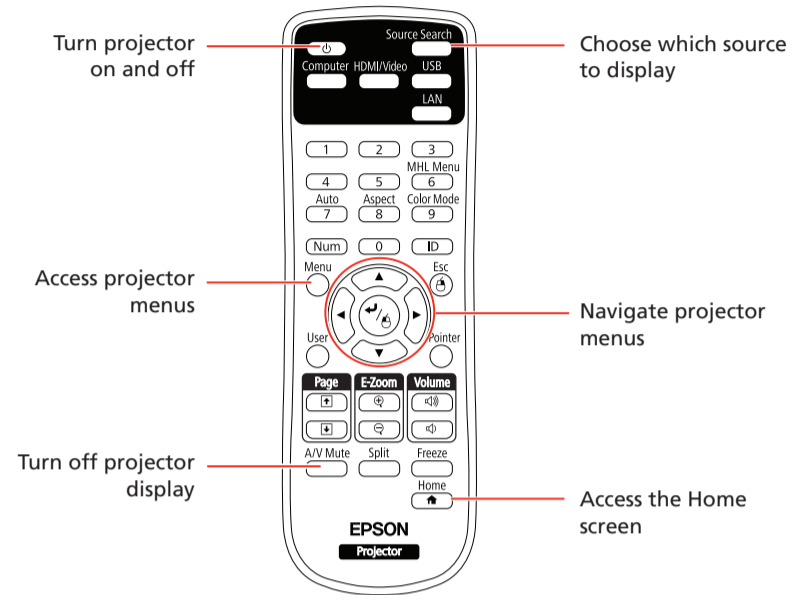
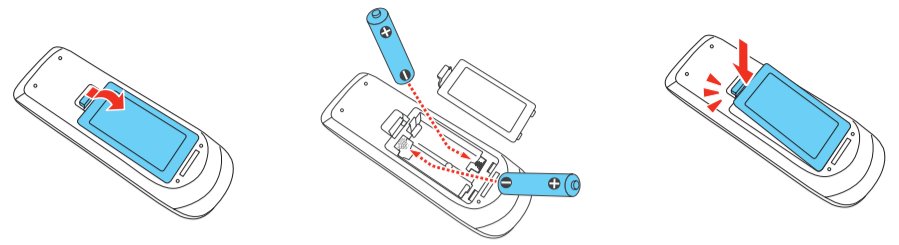

For more information on using the remote control, see the online *User's Guide*.

## Project over a wired network

Follow the steps here to configure your projector for your wired network using the projector's menu system (PowerLite X39/W39).

- Plug in and turn on the projector.
- Press the **Menu** button on the remote control, select the **Network** menu, and press .

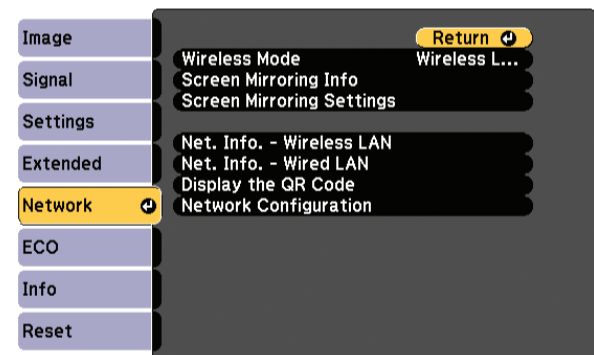

- Select **Network Configuration** and press .
- Select the **Basic** menu and press .

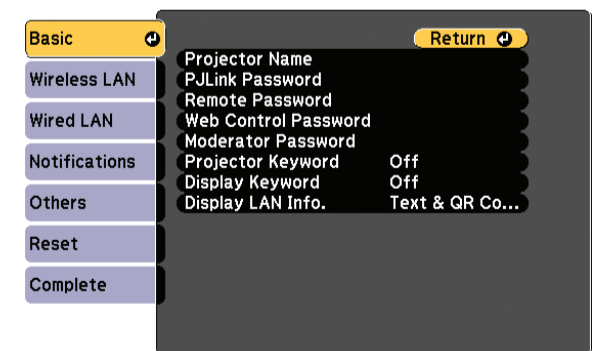

- Select the **Projector Name** setting and enter a name (up to 16 characters long) to identify your projector over the network.



Use the displayed keyboard to enter characters. Press the arrow buttons on the remote control to highlight the characters and press to select them.

**Note:** See the online *User's Guide* for information on adding passwords.

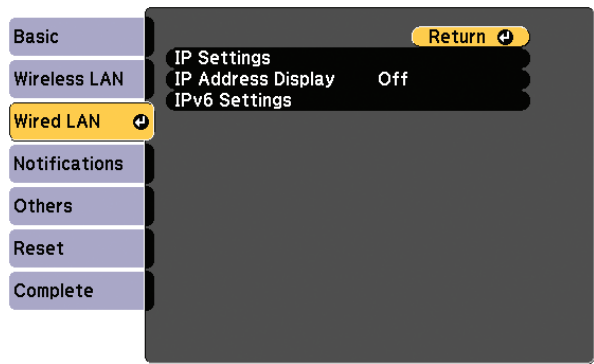

- 6 Select the **Wired LAN** menu and press .



- 7 Choose **IP Settings** and press .
- 8 If your network assigns addresses automatically, turn on the **DHCP** setting. If not, turn off the **DHCP** setting and enter the projector's **IP Address**, **Subnet Mask**, and **Gateway Address**, as needed. Then press **Esc**.
- 9 To prevent the IP address from appearing on the network standby screen, set the **IP Address Display** setting to **Off**.
- 10 When you are finished, select **Complete** and press , then press  again to save your settings.
- 11 Press the **Menu** button to exit the menu system.

## Setting up a wireless connection

Follow the steps here to set up the projector for a wireless connection. You will need the optional wireless LAN module (part number V12H731P02).

### Install the optional LAN module

- 1 Remove the wireless LAN module cover screw.

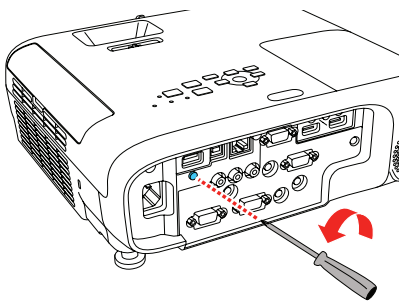

- 2 Insert the optional wireless LAN module into the USB-A port.

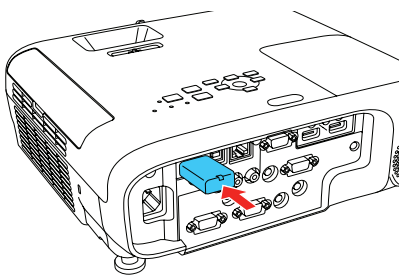

- 3 Attach the included wireless LAN module cover and secure it using the screw you removed.

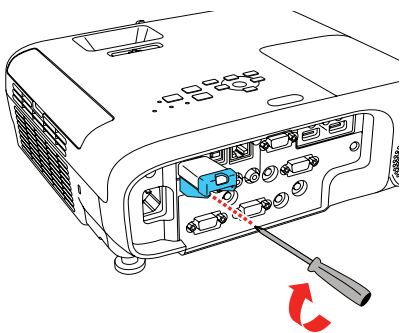



**Note:** The light on the wireless LAN module turns on when the module is installed and operating. The light flashes when the module is communicating over the network.

### Select wireless network settings

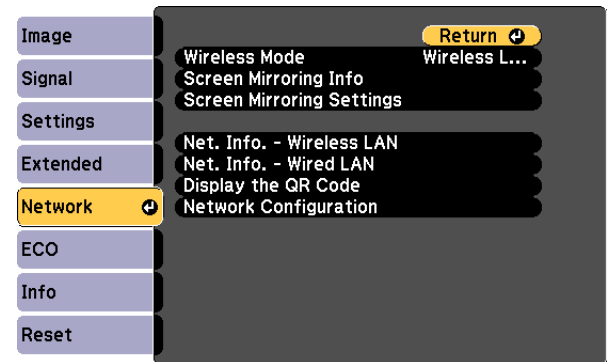
- 1 Press the **Menu** button on the remote control.
- 2 Select the **Network** menu and press .



- 3 Select **Wireless LAN On** as the **Wireless Mode** setting.
- 4 Select **Network Configuration** and press .
- 5 Select the **Wireless LAN** menu and press .

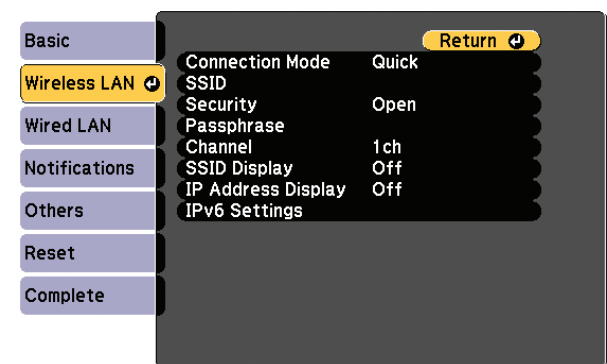

- 6 Select one of the following as the **Connection Mode** setting:
- **Quick** for a direct connection to a computer, tablet, or smartphone.
  - **Advanced** to connect your projector to a router or access point.
- 7 Select any other settings on the Wireless LAN menu as necessary. See the online *User's Guide* for details.
- 8 When you finish selecting settings, select **Complete** and follow the on-screen instructions to save your settings and exit the menus.

### Install the optional software

If you connected a computer to the projector, you can download and install optional software to perform various tasks wirelessly, such as monitoring or controlling your projector and projecting from multiple computers.

You can download the optional software and its manuals from the Epson website, as described in "Where to get help".

## Projecting from a mobile device

You can project wirelessly from a mobile device (iOS, Android™, or Chromebook™) using the Epson iProjection™ app and a QR code.

- 1 Use the following QR code to download and install the Epson iProjection app.



- 2 If you connected the projector to a network wirelessly, make sure to connect your mobile device to the same network.
- 3 Press the **LAN** button on the remote control to display a QR code on the projector screen.
- 4 Start Epson iProjection on your mobile device.

- 5 Use the QR code reader feature to read the QR code displayed.

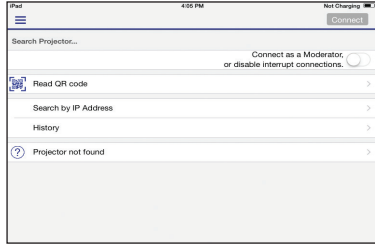

- 6 Follow the app instructions to connect your device to the projector.

For more information on setting up and using this app, visit [www.epson.com/projectorapp](http://www.epson.com/projectorapp) (U.S.) or [www.epson.ca/projectorapp](http://www.epson.ca/projectorapp) (Canada).

## Troubleshooting

If you see a blank screen or the **No signal** message after turning on your computer or video device, check the following:

- Make sure the Status light on the projector is blue and not flashing, and the A/V Mute slide is open.
- Press the **Source Search** button on the projector or remote control to switch to the correct image source, if necessary.
- Press the **Home** button on the projector or remote control to verify the source input and settings.
- On Windows® 7 or later, hold down the Windows key and press **P** at the same time, then click **Duplicate**.
- If you're using a Windows laptop, press the function key on your keyboard that lets you display on an external monitor. It may be labeled **CRT/LCD** or have an icon such as . You may have to hold down the **Fn** key while pressing it (such as **Fn + F7**). Wait a moment for the display to appear.
- If you're using a Mac laptop, open **System Preferences** and select **Displays**. Click the **Arrangement** tab and select the **Mirror Displays** checkbox.

## Where to get help

### Manuals

For more information about using the projector, you can view or download the online manuals from the Epson website, as described below.

### Internet support

Visit [www.epson.com/support](http://www.epson.com/support) (U.S.) or [www.epson.ca/support](http://www.epson.ca/support) (Canada) and search for your product to download software and utilities, view manuals, get FAQs and troubleshooting advice, or contact Epson.

### Telephone support services

To use the Epson PrivateLine® Support service, call (800) 637-7661. This service is available for the duration of your warranty period. You may also speak with a support specialist by calling (562) 276-4394 (U.S.) or (905) 709-3839 (Canada).

Support hours are 6 AM to 8 PM, Pacific Time, Monday through Friday, and 7 AM to 4 PM, Pacific Time, Saturday. Days and hours of support are subject to change without notice. Toll or long distance charges may apply.

### Registration

Register today to get product updates and exclusive offers. You can register online at [www.epson.com/webreg](http://www.epson.com/webreg).

## Optional accessories

For a list of optional accessories, see the online *User's Guide*.

You can purchase screens or other accessories from an Epson authorized reseller. To find the nearest reseller, call 800-GO-EPSON (800-463-7766). Or you can purchase online at [www.epsonstore.com](http://www.epsonstore.com) (U.S. sales) or [www.epsonstore.ca](http://www.epsonstore.ca) (Canadian sales).

**EPSON**  
EXCEED YOUR VISION



EPSON and PowerLite are registered trademarks, Epson iProjection is a trademark, and EPSON Exceed Your Vision is a registered logomark of Seiko Epson Corporation. PrivateLine is a registered trademark of Epson America, Inc.

Mac and OS X are trademarks of Apple Inc., registered in the U.S. and other countries.

Android and Chromebook are trademarks of Google Inc.

General Notice: Other product names used herein are for identification purposes only and may be trademarks of their respective owners. Epson disclaims any and all rights in those marks.

This information is subject to change without notice.

© 2017 Epson America, Inc., 7/17