

SAMSUNG

INSTALL GUIDE

UHD TV

HG43NJ678U HG50NJ678U
HG55NJ678U HG65NJ678U

Thank you for purchasing this Samsung product.

To receive more complete service, please register your product at www.samsung.com

Model _____ Serial No. _____

Before Reading This Install Guide

This TV B2B (Business to Business) model is designed for hotels or the other hospitality businesses, supports a variety of special functions, and lets you limit some user (guest) controls.

Figures and illustrations in this Install Guide are provided for reference only and may differ from the actual product appearance. Product design and specifications may change without notice.

Operational Modes

This TV has two modes: **Interactive** and **Standalone** mode.

- **Interactive** mode: In this mode, the TV communicates with and is fully or partially controlled by a connected Set Back Box (SBB) or Set Top Box (STB) provided by a hospitality System Integration (SI) vendor. When the TV is initially plugged in, it sends a command that attempts to identify the SSB or STB connected to it. If the TV identifies the SBB or STB and the SBB or STB identifies the TV, the TV gives full control to the SBB or STB.
- **Standalone** mode: In this mode, the TV works alone without an external SBB or the STB.

The TV has a **Hotel Option** menu that lets you easily set its various hospitality functions. Please see page 23.

The menu also lets you activate or de-activate some TV and hospitality functions so you can create your optimal hospitality configuration.







Still image warning

Avoid displaying still images (such as jpeg picture files) or still image elements (such as TV channel logos, panorama or 4:3 format images, stock or news bars or crawls) on the screen. Displaying still pictures continually can cause uneven screen wear, which will affect image quality. To reduce the chance that this effect will occur, please follow the recommendations below:

- Avoid displaying the same TV channel for long periods.
- Always try to display a full screen image.
- Reduce brightness and contrast to help prevent the occurrence of after-images.
- Use all TV features designed to reduce image retention and screen burn-in.

Warning! Important Safety Instructions

Please read the Safety Instructions before using your TV.

CAUTION			Class II product: This symbol indicates that a safety connection to electrical earth (ground) is not required.
RISK OF ELECTRIC SHOCK. DO NOT OPEN.			
CAUTION: TO REDUCE THE RISK OF ELECTRIC SHOCK, DO NOT REMOVE COVER (OR BACK). THERE ARE NO USER SERVICEABLE PARTS INSIDE. REFER ALL SERVICING TO QUALIFIED PERSONNEL.			AC voltage: Rated voltage marked with this symbol is AC voltage.
	This symbol indicates that high voltage is present inside. It is dangerous to make any kind of contact with any internal part of this product.		DC voltage: Rated voltage marked with this symbol is DC voltage.
	This symbol indicates that this product has included important literature concerning operation and maintenance.		Caution. Consult instructions for use: This symbol instructs the user to consult the install guide for further safety related information.

- The slots and openings in the cabinet and in the back or bottom are provided for necessary ventilation. To ensure reliable operation of this apparatus and to protect it from overheating, these slots and openings must never be blocked or covered.
 - Do not place this apparatus in a confined space, such as a bookcase or built-in cabinet, unless proper ventilation is provided.
 - Do not place this apparatus near or over a radiator or heat register, or where it is exposed to direct sunlight.
 - Do not place vessels (vases etc.) containing water on this apparatus, as this can result in a fire or electric shock.
- Do not expose this apparatus to rain or place it near water (near a bathtub, washbowl, kitchen sink, or laundry tub, in a wet basement, or near a swimming pool, etc.). If this apparatus accidentally gets wet, unplug it and contact an authorized dealer immediately.
- This apparatus uses batteries. In your community, there might be environmental regulations that require you to dispose of these batteries properly. Please contact your local authorities for disposal or recycling information.
- Do not overload wall outlets, extension cords, or adaptors beyond their capacity, since this can result in fire or electric shock.
- Power-supply cords should be placed so that they are not likely to be walked on or pinched by items placed upon or against them. Pay particular attention to cords at the plug end, at wall outlets, and at the point where they exit from the appliance.
- To protect this apparatus from a lightning storm, or when left unattended and unused for long periods of time, unplug it from the wall outlet and disconnect the antenna or cable system. This will prevent damage to the set due to lightning and power line surges.

- Before connecting the AC power cord to the DC adaptor outlet, make sure that the voltage designation of the DC adaptor corresponds to the local electrical supply.
- Never insert anything metallic into the open parts of this apparatus. This may cause a danger of electric shock.
- To avoid electric shock, never touch the inside of this apparatus. Only a qualified technician should open this apparatus.
- Be sure to plug in the power cord until it is firmly seated. When unplugging the power cord from a wall outlet, always pull on the power cord's plug. Never unplug it by pulling on the power cord. Do not touch the power cord with wet hands.
- If this apparatus does not operate normally - in particular, if there are any unusual sounds or smells coming from it - unplug it immediately and contact an authorized dealer or service center.
- Be sure to pull the power plug out of the outlet if the TV is to remain unused or if you are to leave the house for an extended period of time (especially when children, elderly, or disabled people will be left alone in the house).
 - Accumulated dust can cause an electric shock, an electric leakage, or a fire by causing the power cord to generate sparks and heat or by causing the insulation to deteriorate.
- Be sure to contact an authorized Samsung service center for information if you intend to install your TV in a location with heavy dust, high or low temperatures, high humidity, chemical substances, or where it will operate 24 hours a day such as in an airport, a train station, etc. Failure to do so may lead to serious damage to your TV.
- Use only a properly grounded plug and wall outlet.
 - An improper ground may cause electric shock or equipment damage. (Class I Equipment only.)
- To turn off this apparatus completely, disconnect it from the wall outlet. To ensure you can unplug this apparatus quickly if necessary, make sure that the wall outlet and power plug are readily accessible.
- Store the accessories (batteries, etc.) in a location safely out of the reach of children.
- Do not drop or strike the product. If the product is damaged, disconnect the power cord and contact a Samsung service center.
- To clean this apparatus, unplug the power cord from the wall outlet and wipe the product with a soft, dry cloth. Do not use any chemicals such as wax, benzene, alcohol, thinners, insecticide, air fresheners, lubricants, or detergents. These chemicals can damage the appearance of the TV or erase the printing on the product.
- Do not expose this apparatus to dripping or splashing.
- Do not dispose of batteries in a fire.
- Do not short-circuit, disassemble, or overheat the batteries.
- There is danger of an explosion if you replace the batteries used in the remote with the wrong type of battery. Replace only with the same or equivalent type.
- **WARNING - TO PREVENT THE SPREAD OF FIRE, KEEP CANDLES AND OTHER ITEMS WITH OPEN FLAMES AWAY FROM THIS PRODUCT AT ALL TIMES.**
- Use care when touching the TV after it has been on for some time. Some parts can be warm to the touch.



Contents

	Before Reading This Install Guide	2
	Warning! Important Safety Instructions	3
01	Package Content	
02	TV Installation	
	Assembling the swivel	8
	Installing the LED TV Stand	9
	Installing the wall mount kit	11
	Securing the TV to the Wall	11
	Wall Mount Kit Specifications (VESA)	12
	Providing proper ventilation for your TV	13
03	The Remote Control	
	About the Buttons on the Remote Control	14
	Installing batteries into the remote control	15
04	Using the TV Controller	
05	The Connection Panel	
06	Connections	
	Connecting the TV to a SBB or STB	19
	Connecting the TV to the game controller	19
	List of Hospitality SI Vendors and Compatible Data Cables Supplied with the TV	20
	Connecting the RJP (Remote Jack Pack)	21
07	Setting the Hotel Option Menus	
	Hotel Option menu items	24
	Welcome Message	31
	Hotel Logo	31
	USB Cloning	32
	Settings Cloned in the Hotel Menu	34
	Setting Auto Initialize	36
	Updating the TV's Software	38

08	Using a Multi Code Remocon	
09	Setting the Soundbar	
	Samsung Soundbar (AirTrack) and Hospitality TVs in 2018	40
10	Editing Channels	
	Channel Bank Editor (Smooovie TV Only)	41
	Using Channel Editor	42
11	Anti-theft Kensington Lock	
12	Specifications and Other Information	
	Specifications	46
	Environmental Considerations	47
	Decreasing power consumption	47
	Supported Resolutions for UHD Input Signals	48
	Display Resolution	48
	Dimensions	50
	Licenses	54
	Important Warranty Information Regarding Television	
	Format Viewing	55
	SAMSUNG ELECTRONICS NORTH AMERICAN LIMITED WARRANTY STATEMENT	56

01 Package Content

Make sure the following items are included with your TV. If any items are missing, contact your dealer.

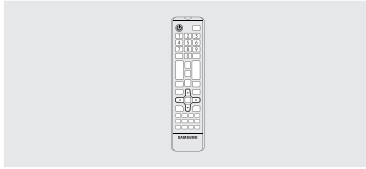

Remote Control
(AA59-00817A)

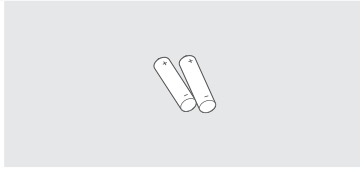

Batteries (AAA x 2)



Power Cord

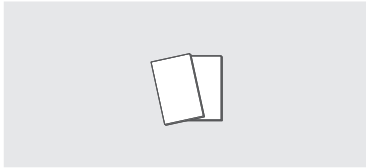

Safety Guide / Quick Setup Guide /
Regulatory Guide

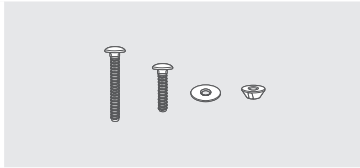

Hotel Mount Kit

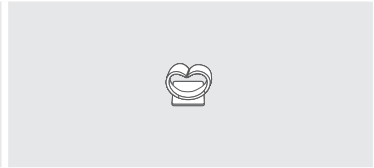

Cable Guide

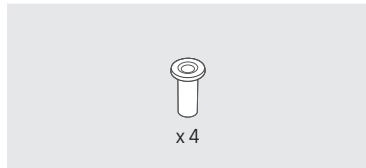

Wall Mount Adaptor
x 4

- The items' colors and shapes may vary depending on the models.
- Cables not included can be purchased separately.
- Check for any accessories hidden behind or in the packing materials when opening the box.



The screen can be damaged from direct pressure when handled incorrectly. As shown in the figure, make sure to grip the edges of the screen when you lift the TV.

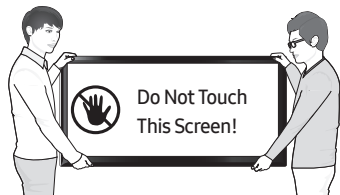

02 TV Installation

Assembling the swivel



WARNING: If you configure the TV to swivel, you must attach it securely to the floor, a desk, a dresser top, etc. as described in the installation instructions.

The LED TVs have swivel stands. You can configure these stands so that the TVs swivel 20 degrees left and right, 60 degrees left and right, or 90 degrees left and right using the BRACKET HOLDER SWIVEL.

* The product ships with its stand's swivel angle set to 20°.

20° swivel

To configure the TV so that it swivels 20° left and right, insert the prong on the bottom of the stand through the curved hole in the Bracket Holder Swivel marked 20°. Then, fix the Bracket Holder Swivel to the stand using the three supplied screws as shown below.

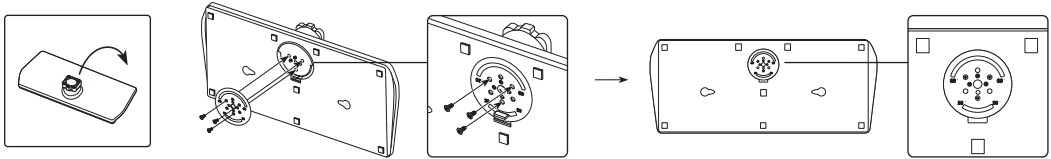

60° swivel

To configure the TV so that it swivels 60° left and right, insert the prong on the bottom of the stand through the curved hole in the Bracket Holder Swivel marked 60°. Then, fix the Bracket Holder Swivel to the stand using the three supplied screws as shown below.

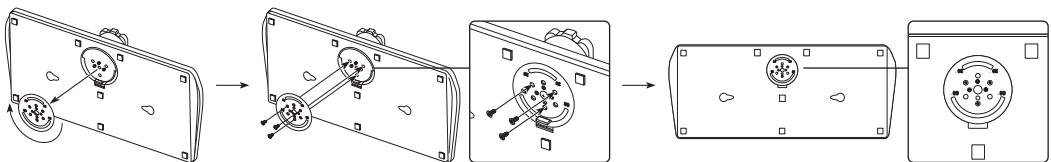

90° swivel



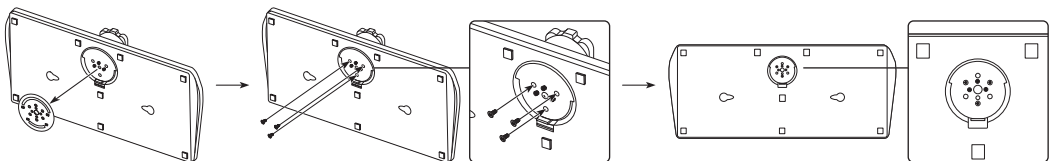

To configure the TV so that it swivels 90° left and right, remove the Bracket Holder Swivel, and then screw the three supplied screws into the stand as shown below.





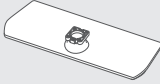

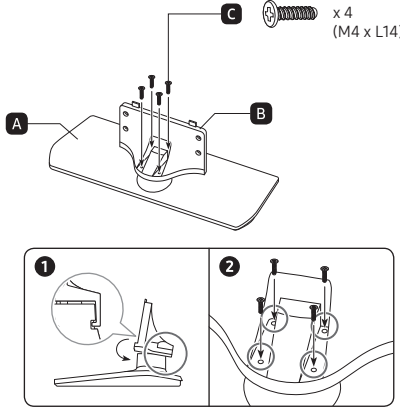

Installing the LED TV Stand

Assembling the Stand and Components

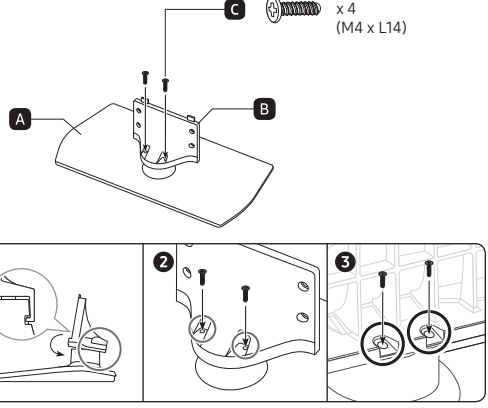
When installing the stand, use the provided components and parts.

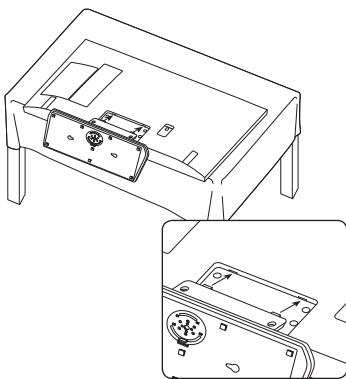
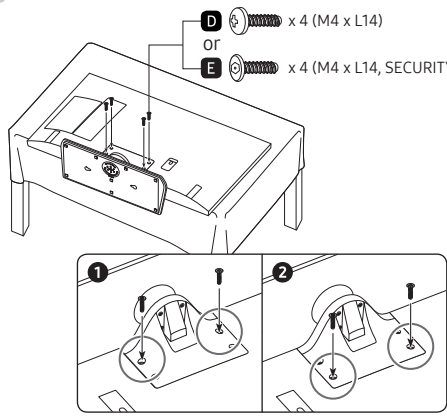
 <p>A</p>	 <p>B</p> <p>(43"-55") (65")</p>	<p>C  BN96-32380B x 4 (M4 x L14)</p> <p>D  BN96-36261A x 4 (M4 x L14)</p> <p>E  BN96-47100A x 4 (M4 x L14, SECURITY)</p>
Stand x1	Guide Stand x1	Screws

<p>1 43"-55"</p>  <p>C  x 4 (M4 x L14)</p>	<p>65"</p>  <p>C  x 4 (M4 x L14)</p>
<p>2</p>  <ul style="list-style-type: none"> Place a soft cloth over the table to protect the TV, and then place the TV so that its screen faces down toward the table surface. Insert the Stand Guide into the slot on the bottom of the TV. Slide and assemble it to the end line in the direction of arrow. 	<p>3</p>  <p>D  x 4 (M4 x L14) OR E  x 4 (M4 x L14, SECURITY)</p> <p>Tight the bottom screw first, and upper screw last.</p> <ul style="list-style-type: none"> Progress the assembly of screw in the manual's order.

4 43"

50"-65"

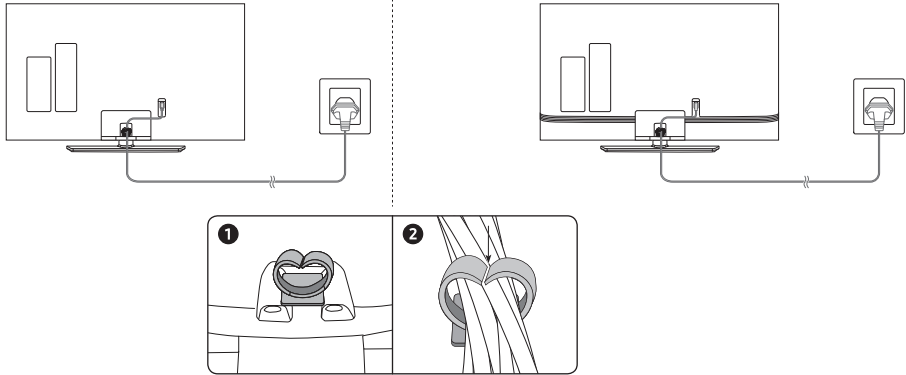

NOTE

- Make sure to distinguish between the front and back of each component when assembling them.
- Make sure that at least two persons lift and move the TV.

Assembling the Hotel Mount Kit

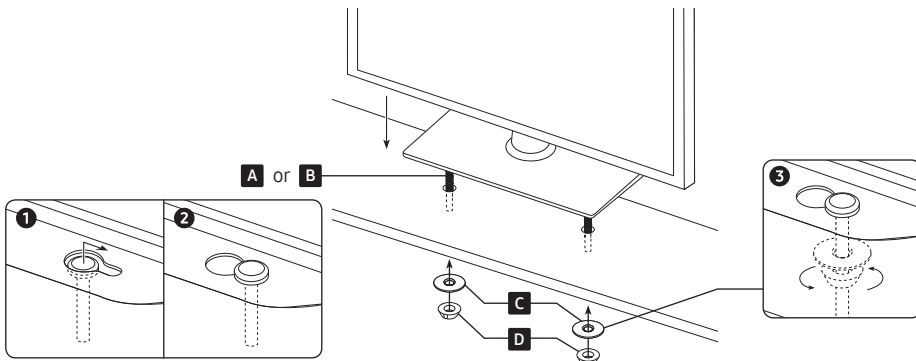
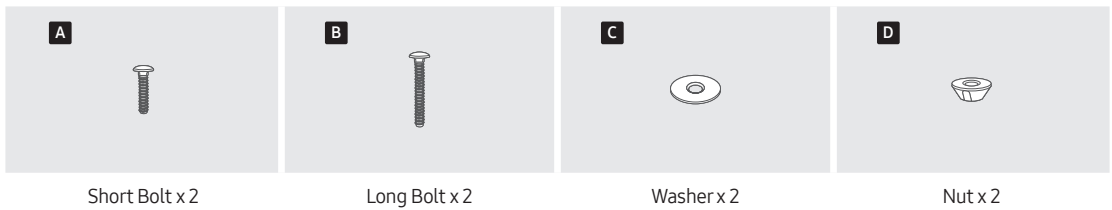

⚠ Affix the stand to a flat surface such as a dresser top, desk top, or entertainment center as shown.



WARNING: To prevent injury, you must attach this TV securely to the floor, a table, a dresser top, etc. with the Hotel Mount Kit as described in these instructions.

Installing the wall mount kit

You can mount the TV on the wall using a wall mount kit (sold separately).

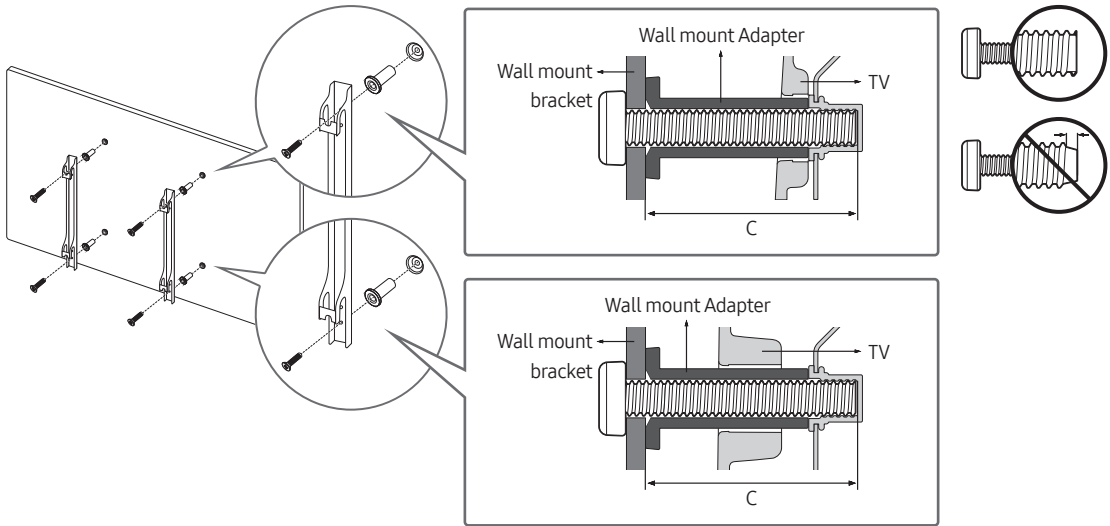

- The Product shape may differ depending on the model.

The wall mount kit (sold separately) allows you to mount the TV on a wall.

For detailed information on installing the wall mount, see the instructions provided with the wall mount. Contact a technician for assistance when installing the wall mount bracket. Samsung Electronics is not responsible for any damage to the product or injury to yourself or others if you select to install the TV on your own.

Securing the TV to the Wall



Caution: Pulling, pushing, or climbing on the TV may cause the TV to fall. In particular, ensure your children do not hang on or destabilize the TV. This action may cause the TV to tip over, causing serious injuries or death. Follow all safety precautions provided in the Safety Flyer included with your TV. For added stability and safety, you can purchase and install the anti-fall device.

To Prevent the TV from Falling

- TV Holder Kits are sold separately. To purchase a TV Holder Kit, contact Samsung Customer Care.
1. Insert the screws into the wall brackets and firmly fasten them to the wall. Make sure the screws are firmly fixed to the wall.
 - We strongly recommend you drive the screws into a stud.
 2. Insert the screws into the wall brackets and firmly fasten the screws to the top VESA screw holes on the back of the TV.
 3. Connect the brackets on the TV and the brackets on the wall with a strong string or cable, and then tie the string or cable tightly to the brackets.
 - Verify all connections are properly secured. Periodically check the connections for any sign of fatigue or failure. If you have any doubt about the security of your connections, contact a professional installer.
 - Install the TV close to the wall so that it does not fall.
 - Connect the string or cable so that the brackets on the wall are at the same height or lower than the brackets on the TV. Untie the string or cable before moving the TV.

Wall Mount Kit Specifications (VESA)

Install your wall mount on a solid wall perpendicular to the floor. If you are attaching the wall mount to building materials other than plaster board, contact your nearest dealer. If installed on a ceiling or slanted wall, the TV may fall and cause severe personal injury.

- The wall mount kit is not supplied, but sold separately.
- NOTE
 - Standard dimensions for wall mount kits are shown in the table below.
 - Samsung wall mount kits contain a detailed installation manual. All parts necessary for assembly are provided.
 - Do not use screws that do not comply with the VESA standard screw specifications.
 - Do not use screws that are longer than the standard dimension or do not comply with the VESA standard screw specifications. Screws that are too long may cause damage to the inside of the TV set.
 - For wall mounts that do not comply with the VESA standard screw specifications, the length of the screws may differ depending on the wall mount specifications.
 - Do not fasten the screws too firmly. This may damage the product or cause the product to fall, leading to personal injury. Samsung is not liable for these kinds of accidents.
 - Samsung is not liable for product damage or personal injury when a non-VESA or non-specified wall mount is used or the consumer fails to follow the product installation instructions.
 - Do not mount the TV at more than a 15 degree tilt.
 - Always have two people mount the TV onto a wall.

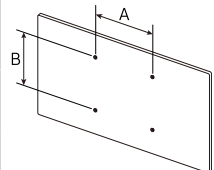
TV size in inches	VESA screw hole specs (A * B) in millimeters	C (mm)	Standard Screw	Quantity	
43-55	200 x 200	43-45	M8	4	
65	400 x 400				



Do not install your wall mount kit while your TV is turned on. This may result in personal injury from electric shock.

Providing proper ventilation for your TV

When you install your TV, maintain a distance of at least 4 inches (10 cm) between the TV and other objects (walls, cabinet sides, etc.) to ensure proper ventilation. Failing to maintain proper ventilation may result in a fire or a problem with the product caused by an increase in its internal temperature.

When you install your TV with a stand or a wall mount, we strongly recommend you use parts provided by Samsung Electronics only. Using parts provided by another manufacturer may cause difficulties with the product or result in injury caused by the product falling.

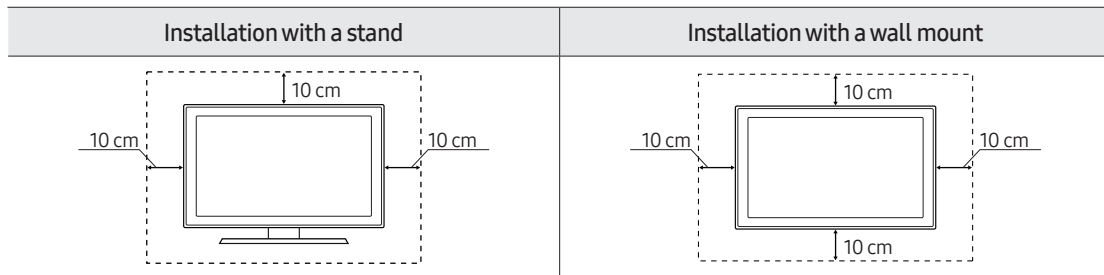

03 The Remote Control

About the Buttons on the Remote Control

- The images, buttons, and functions of the remote control may differ depending on the model.
- The remote control has Braille points on the Power, Channel, Volume, and Select buttons and can be used by visually impaired persons.

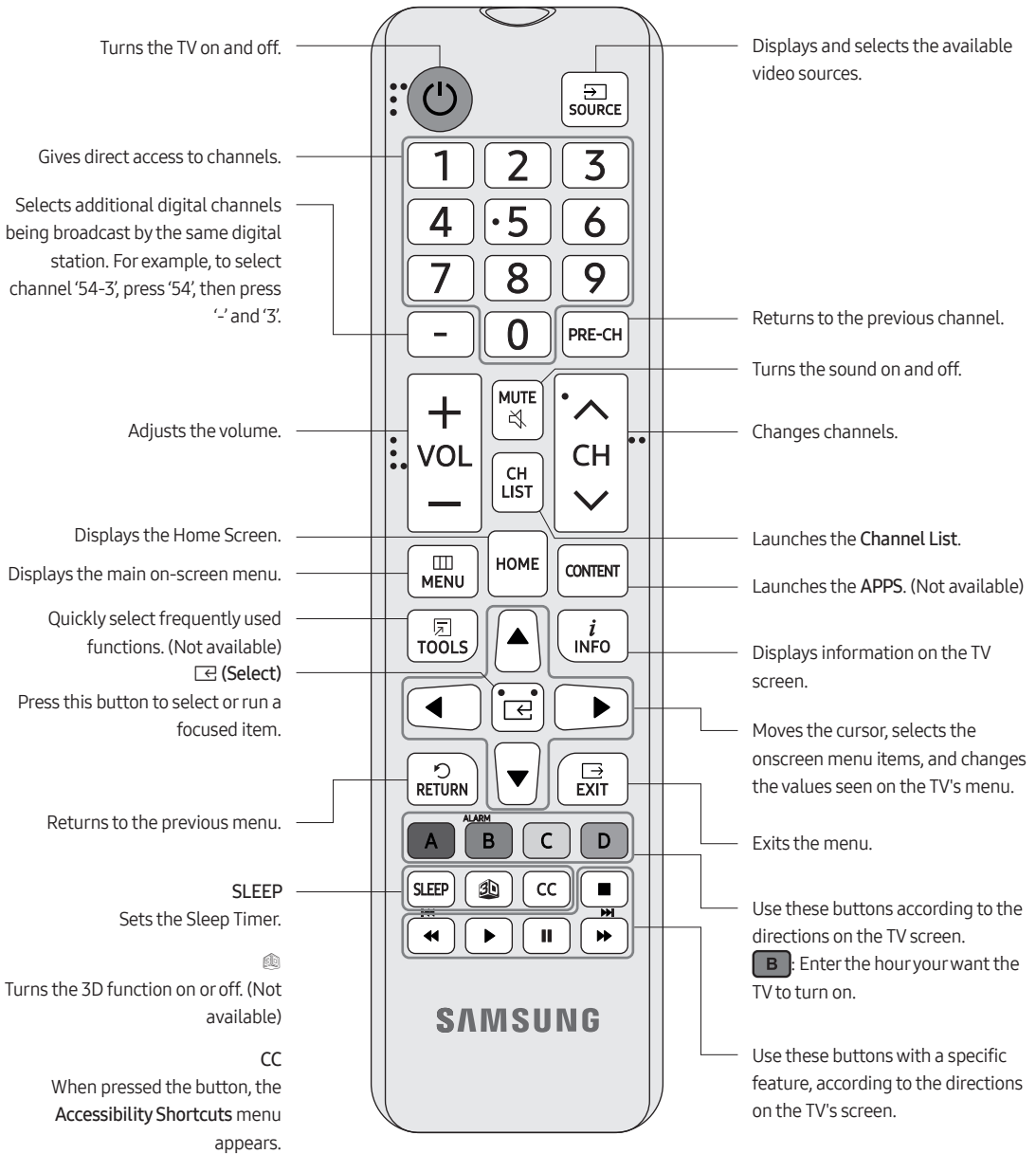

Installing batteries into the remote control

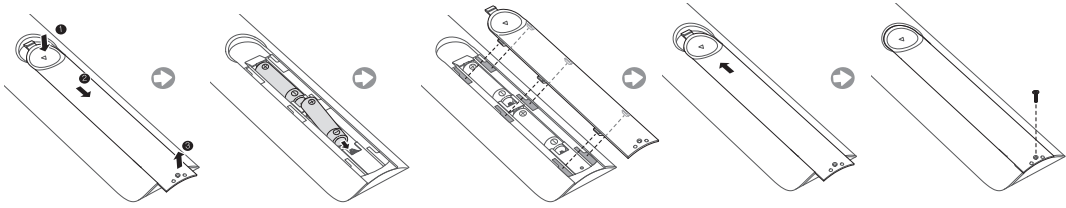

Match the polarity of the batteries to the symbols in the battery compartment.

- Use the remote control within 23 feet of the TV.
- Bright light may affect the performance of the remote control. Avoid using near bright fluorescent lights or neon signs.
- The color and shape of the remote may vary depending on the model.

04 Using the TV Controller

You can turn on the TV with the TV Controller button at the bottom of the TV, and then use the Control menu. The Control menu appears when the TV Controller is pressed while the TV is On. For more information about its usage, refer to the figure below.

- The screen may dim if the protective film on the SAMSUNG logo or the bottom of the TV is not detached. Please remove the protective film.

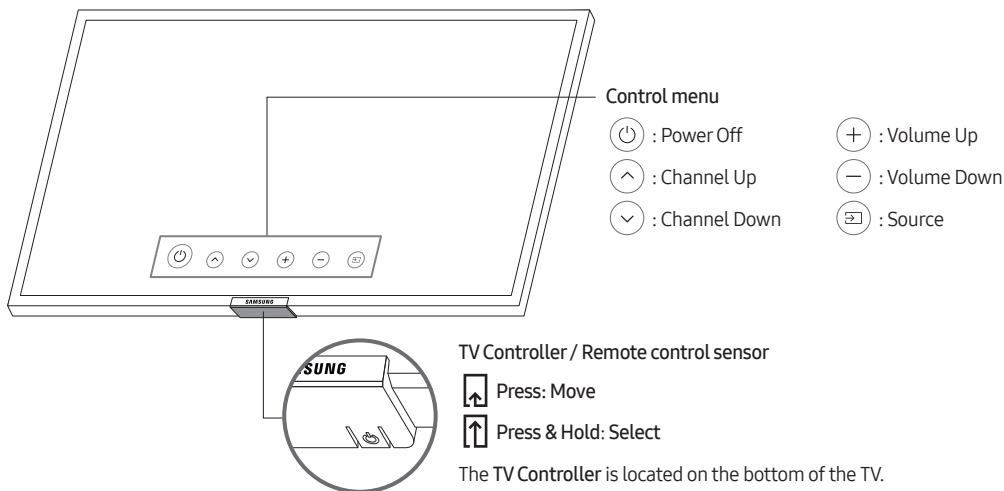

05 The Connection Panel

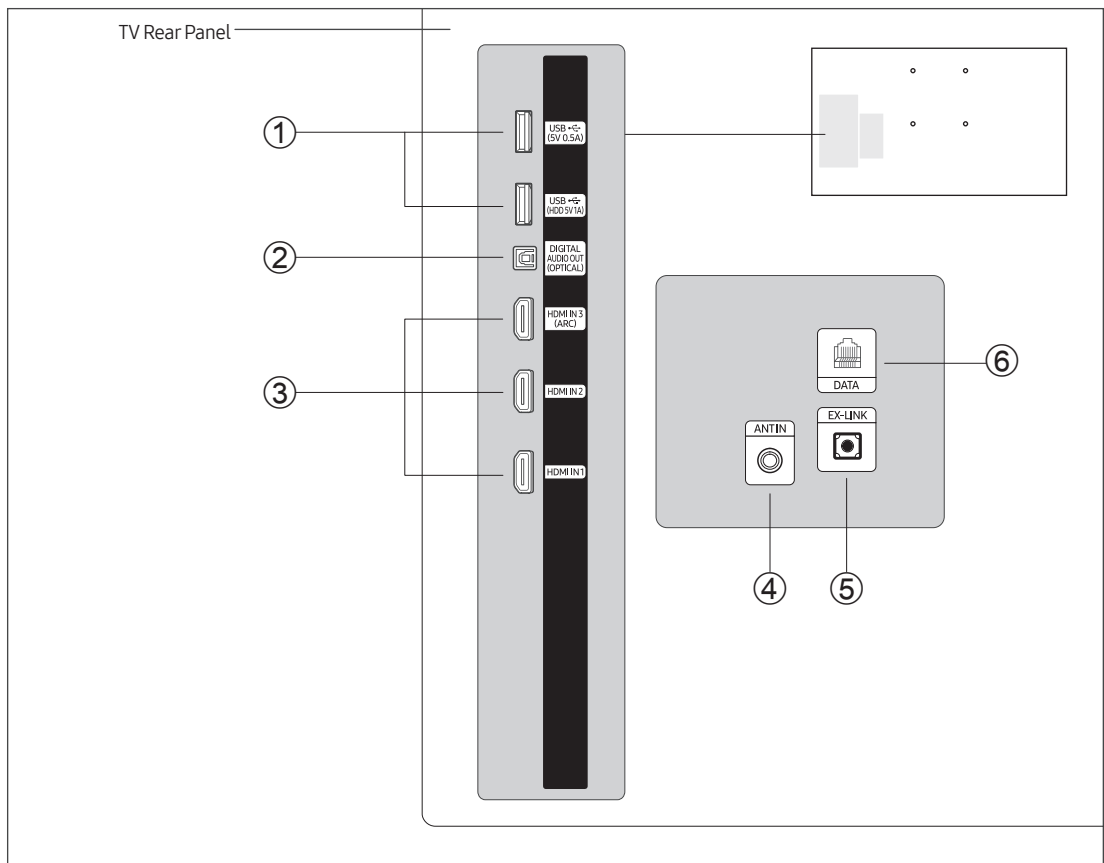

- Whenever you connect an external device to your TV, make sure that power on the TV and the device is turned off.

① **USB (5V 0.5A), USB (HDD 5V1A)**

- Connector for software upgrades and Media Play, etc.
- Service connection.

② **DIGITAL AUDIO OUT (OPTICAL)**

Connects to a Digital Audio component.

③ **HDMI IN 1, 2, 3 (ARC)**

Connects to the HDMI port of a device with an HDMI output.

- No separate sound connection is needed for an HDMI to HDMI connection. HDMI connections carry both audio and video.
- It is recommended that the external device of the HDMI 1.3 or 1.4 version will be used with this TV. If you meet the compatible problem like no sound or the abnormal screen or etc with the device of the HDMI 1.2 version, contact to the Samsung customer care center.

④ **ANT IN**

- To view television channels correctly, the TV must receive a signal from one of the following sources:
- An outdoor antenna / A cable television system
- To use BLAN, be sure to set the **BLAN Power** to **ON** in the **Hotel Option** menu.

⑤ **EX-LINK**

Connect this port to the port on the optional RJP (Remote Jack Pack). This will allow you to connect external devices (Camcorder, PC, DVD players etc.) easily.

⑥ **DATA**

- Used to connect the Lodgenet game controller in the Lodgenet system or support data communication between the TV and the external SBB or STB.
- Connects using RJ-12 TV type plugs.
- For more information about the data cables, refer to page 20.

06 Connections

Connecting the TV to a SBB or STB

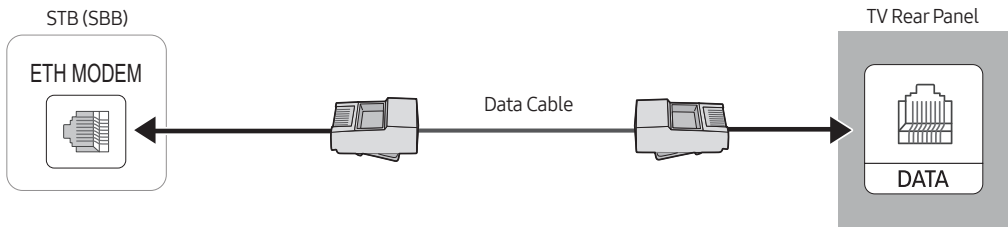

Connect the **DATA** port of the TV to the **ETH MODEM** port of the STB (SBB) with the Data cable.

- The **ETH MODEM** port name that you connect the Data Cable to may differ depending on the SBB or STB type.
- The remote control IR signal need to meet the following specification to use IR pass through function.

IR signal reciever specification

- Band pass filter center frequency: 37.9 kHz
- Carrier Frequency, Duty 50%
- Minimum Burst Length (tburst): 12 pulses (316 us)
- Minimum Gap Time Between the burst (tburst gap): 16 pulses (422 us)
- Minimum Gap Time between the data commands (tpause): 25 ms

Connecting the TV to the game controller

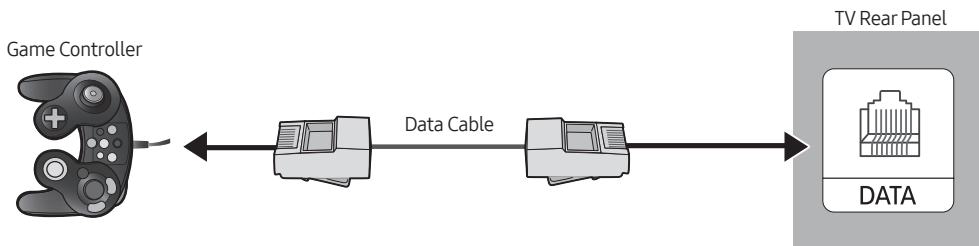

Connect the LodgeNet game controller to the **DATA** port of the TV.

List of Hospitality SI Vendors and Compatible Data Cables Supplied with the TV

- Confirm you are using the correct data cable for your SI vendor. Refer to the code label on the data cables.
- Contact your nearest dealer or your SI Vendor to buy the data cable not included in the TV.

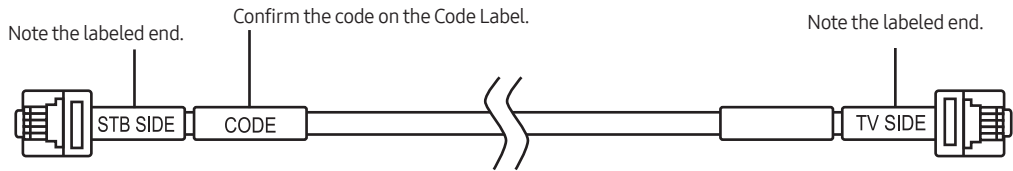

SI Vendor	Cable code	Pin assign	Remark														
Samsung OCC Enseo Guestek	BN39-00865B	<p>Diagram showing pin assignments for cable BN39-00865B. It includes two connector diagrams labeled <CON A> and <CON B>, and a central table of connections.</p> <table border="1"> <tr> <th>CON A</th> <th>CON B</th> </tr> <tr> <td>6</td> <td>1</td> </tr> <tr> <td>5</td> <td>2</td> </tr> <tr> <td>2</td> <td>5</td> </tr> <tr> <td>4</td> <td>6</td> </tr> </table>	CON A	CON B	6	1	5	2	2	5	4	6					
CON A	CON B																
6	1																
5	2																
2	5																
4	6																
Nstreams	BN39-01110A	<p>Diagram showing pin assignments for cable BN39-01110A. It includes two connector diagrams labeled <CON A> and <CON B>, and a central table of connections.</p> <table border="1"> <tr> <th>CON A</th> <th>CON B</th> </tr> <tr> <td>6</td> <td>3</td> </tr> <tr> <td>5</td> <td>4</td> </tr> <tr> <td>2</td> <td>1</td> </tr> <tr> <td>4</td> <td>5</td> </tr> </table>	CON A	CON B	6	3	5	4	2	1	4	5					
CON A	CON B																
6	3																
5	4																
2	1																
4	5																
Sonifi (MTI)	BN39-01011E	<p>Diagram showing pin assignments for cable BN39-01011E. It includes two connector diagrams labeled <CON A> and <CON B>, and a central table of connections.</p> <table border="1"> <tr> <th>CON A</th> <th>CON B</th> </tr> <tr> <td>6</td> <td>1</td> </tr> <tr> <td>5</td> <td>2</td> </tr> <tr> <td>4</td> <td>3</td> </tr> <tr> <td>3</td> <td>4</td> </tr> <tr> <td>2</td> <td>5</td> </tr> <tr> <td>1</td> <td>6</td> </tr> </table>	CON A	CON B	6	1	5	2	4	3	3	4	2	5	1	6	
CON A	CON B																
6	1																
5	2																
4	3																
3	4																
2	5																
1	6																

- Operation Specification of Data Cable(RJ12) : TTL

Connecting the RJP (Remote Jack Pack)

Connect the input ports on the TV to the RJP. The RJP lets guests connect audio and video sources to the TV.

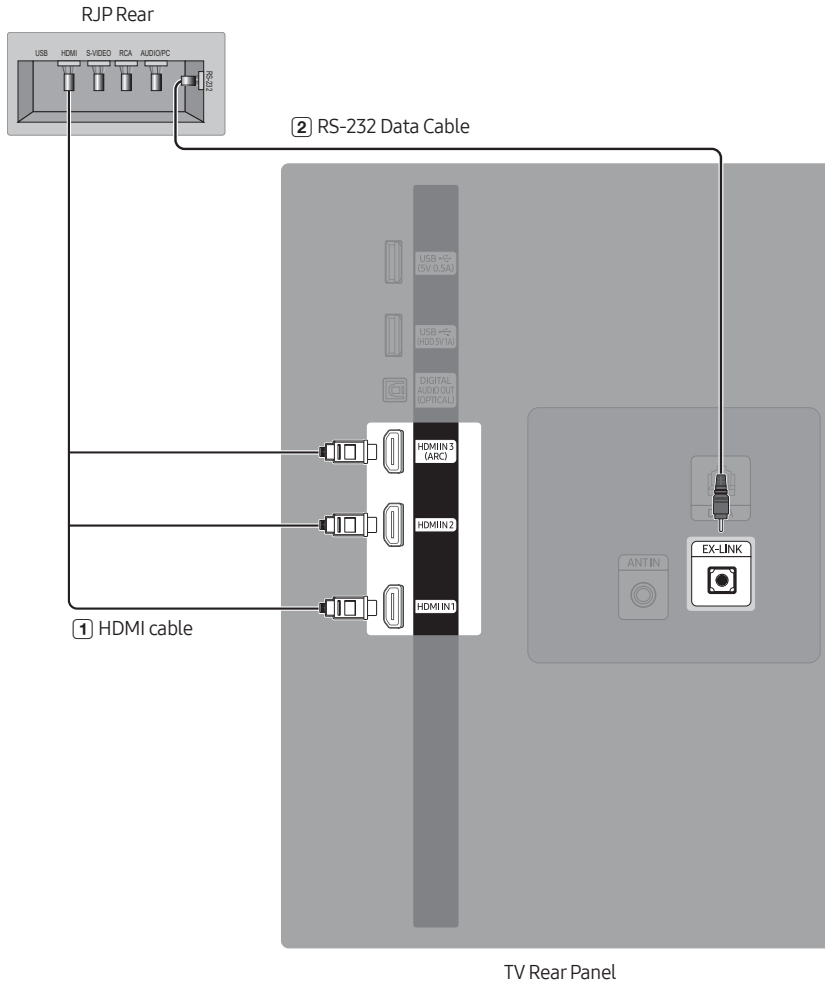

- The rear panel may differ depending on the model.
- 1 Connect the HDMI port of the TV to the HDMI port of the RJP.
 - 2 Connect the EX-LINK port of the TV to the RS-232 port of the RJP.
 - This Samsung TV is compatible with the TeleAdapt TA-7610 RJP only.

- **RJP (Remote Jack Pack):** The RJP is a hardware module that has various audio and video inputs (A/V video, A/V audio, PC and HDMI) and corresponding outputs. The corresponding outputs are connected from the RJP to the TV. The RJP communicates with the TV via RS232. The RJP communicates with the TV by sending messages regarding active or inactive sources.
- The RJP will automatically turn off any LEDs after 5 minutes to avoid unnecessary light pollution in the hotel room. The LEDs that were turned off will turn on again if the guest touches any of the buttons and the 5 minute timer will restart. If the guest then touches another source button, the TV will change to the selected source and the corresponding LED will be lit.
- After the RJP reset or the TV turns off/on, it takes approximately 10 seconds to establish communications between the TV and the RJP.
- The following table shows the approximate time in seconds it takes to switch from the TV to an input source, based on assigned or default priorities.

- When no inputs are connected.

Source	To Connect
HDMI	3.9 sec

- When two or more inputs are connected to the RJP and one of the input sources is disconnected and then reconnected.

Source	Disconnect	To Connect	Total
HDMI	3.9 sec	3.9 sec	7.8 sec

- If the RJP has all its live sources connected, HDMI has been assigned the highest priority, the RJP is in HDMI mode, and a guest removes and reconnects the HDMI source, the minimum time required to switch to the HDMI 1 source is 7.8 seconds.
- **HDMI Music Mode** is available for the G-LINK RJP only. For more information about **HDMI Music Mode**, refer to page 26.

07 Setting the Hotel Option Menus

To access the **Hotel Option** menus, press **MUTE > 1 > 1 > 9 > Select**  buttons on your remote control.

To control the TV functions in the **Hotel Option** menu, the TV has two modes, the **Standalone** mode and the **Interactive** mode. The menu items that differ between the modes are listed below.

Menu items in the **Standalone** mode only:

- **SI Vendor: Smoovie / SSCP**
- **Home Menu / REACH Solution / Room Number** and its submenus.

Menu items in the **Interactive** mode only:

- **SI Vendor:** Samsung and other vendors.

All other items appear in both modes.

After a menu appears, follow these general directions to navigate and change values:

- Use the directional buttons on the remote control to move from menu item to menu item.
- Press the **Select**  button on the remote control to select a menu item. The screen displays that menu item only.
- Press the left or right directional button to change a value. The right directional button increases numerical values. The left arrow button decreases numerical values.
- When the screen is displaying one menu item, you can press the up or down directional button to display the next or previous menu item.
- Press the **RETURN** or **MENU** button to exit the current menu item and go to a higher menu level.
- To exit a **Hotel Option** menu, turn off the TV, and then turn it on again. Any changes you made are saved except changes to SI (System Integration) vendor. For changes to SI vendor, you must turn the TV off, wait until the power indicator at the bottom of the TV glows steadily. And then unplug the TV, wait for the power indicator to go off, and then plug the TV in again.

To change menus between the **Interactive** mode and the **Standalone** mode, follow the steps below:

1. Highlight the **Hospitality Mode** menu item in the top left corner of the menu.
2. Press the **Select**  button on the remote control. Only the **Hospitality Mode** menu item is displayed.
3. Press the left or right directional button to change the **Hospitality Mode** item from **Standalone** to **Interactive** or from **Interactive** to **Standalone**.
4. Press the **RETURN** or **MENU** button on the remote control. The entire menu re-appears with your selection displayed in the **Hospitality Mode** field.
 - After you have set the values in one TV, you can clone those values to multiple TVs.
 - For more information about the USB cloning refer to page 32.

Hotel Option menu items

To enter this menu, press the MUTE > 1 > 1 > 9 > Select  buttons on the remote control in order.

To exit from this menu, turn off (or turn off and unplug the power cable if you have changed SI vendor) the TV, and then turn on again. Any changes you made are saved.

- The menu items may not be supported depending on the models.

Hotel Option menu Item	Description
Hospitality Mode	Select Hospitality Mode . <ul style="list-style-type: none"> • Interactive: TV works with an SI STB or SBB. • Standalone: TV works alone, without an SI STB or SBB.
SI Vendor	<ul style="list-style-type: none"> • Interactive: Samsung / OCC / MTI / Nstreams / Enseo / Cardinal / Guestek / SeaChange / MDC / Innvue / EBL • Standalone: OFF / Smoovie / SSCP
Power On	Power On Channel Set the channel to display when the TV is turned on. <ul style="list-style-type: none"> • User Defined: Lets you set the channel number manually on Power On Channel Num. See Power On Channel Num below. • Last Saved: If you select this item, when the TV is turned on, it displays the channel it was displaying when it was turned off.
	Power On Channel Num When the TV is turned on, it switches automatically to this channel.
	Power On Channel Type Select the type of the channel will be displayed when the TV is turned on. ATV (analog air band), DTV (digital air band), CATV (analog cable band), CDTV (digital cable band).
	Power On Volume Set volume level when the TV is turned on. <ul style="list-style-type: none"> • User Defined: Lets you set volume level manually. • Last Saved: When the TV is turned on, it returns to the volume that had been set when the power had been turned off.
	Power On Volume Num The TV turns on with set volume level in Standalone mode.
	Min Volume The minimum volume level the user can set in Standalone mode.
	Max Voume The maximum volume level the user can set in Standalone mode.
	Power On Source Select the input source to be displayed when the TV is turned on.
	Power On Option Determines the TV's state when power returns after a power failure or after you have unplugged the TV and then plugged it in again. <ul style="list-style-type: none"> • Last Option: Returns to its last power state. If it was in standby mode, it returns to standby mode. If it was on, it turns on. • Power ON: When the power returns, the TV turns on. • Standby: When the power returns, the TV enters the standby mode.

Hotel Option menu Item		Description
Channel	Channel Setup	Gives you direct, immediate access to some of the channel menu functions on the Broadcasting menu such as Auto Program , Audio Options , etc.
	Channel Editor	Lets you edit the channels stored in the TV's memory. <ul style="list-style-type: none"> Change the channel numbers and names, manage genre and language groups and delete channels. Apply the Screen Off to channels you select. The Screen Off blanks out the video from a channel and outputs only audio. Lets you view information about each channel easily, without your having to display each channel directly.
	Channel Bank Editor	Edits channels, with 3 different Bank options. There are specific channels customers can enjoy, depending on the Bank card. <ul style="list-style-type: none"> This function is only available when set to Hospitality Mode: Standalone, SI Vendor: Smoovie.
	Mixed Channel Map	Enables showing/browsing all antenna type (Air/Cable) channels at the same time. <ul style="list-style-type: none"> ON: When set to on, guests can access the complete channel map irrespective of the selected antenna type. The Channel List will also populate Air as well Cable type channels. OFF: When set to off, guest can access the channel map corresponding to the selected antenna type (Air/Cable) only. The Channel List/Channel Editor will only show the selected antenna type channels.
	Dynamic SI	<ul style="list-style-type: none"> ON: The TV will check the DTV program channel number automatically. (You can't edit DTV program channel number in Channel Editor.) OFF: You can't check the DTV program channel number. (You can edit DTV program channel number in Channel Editor. While TV do not support auto channel number update.)
	Mychannel	Enable or disable the My Channel function. <ul style="list-style-type: none"> This function is not available when set to Hospitality Mode: Standalone, SI Vendor: Smoovie.
Menu OSD	Picture Menu Lock	Enable or disable the Picture menu.
	Menu Display	<ul style="list-style-type: none"> ON: The main menu is displayed. OFF: The main menu is not displayed.
	Channel Menu Display	<ul style="list-style-type: none"> OFF: Broadcasting menu is disable for guest. ON: Broadcasting menu is enable for guest.
	Panel Button Lock	Turning the TV Controller button operations on or off. <ul style="list-style-type: none"> Unlock: Unlocks TV Controller button. Lock: Locks TV Controller button. OnlyPower: Locks TV Controller button except the power off function.

Hotel Option menu Item		Description
Clock	Local Time	Select the way to update the clock data <ul style="list-style-type: none"> • Manual: The clock is set automatically from the DTV channel or manually by the user when the TV is in Standalone mode. • Time Channel: The clock is set from the selected channel.
	Timer Type	Enable or disable the alarm function. <ul style="list-style-type: none"> • WakeUp: Enable the alarm function to turn on the device at the specified time. • OnOff: Disable the alarm function and enable on or off timer.
	Time Channel Type	Select the type of the channel to update the clock data. <ul style="list-style-type: none"> • This function is only available Local Time set to Time Channel.
	Time Channel Num	Select the number of the channel to update the clock data. <ul style="list-style-type: none"> • This function is only available Local Time set to Time Channel.
Remote Jack Pack	HDMI Option	Select which HDMI source of the TV is connected to the RJP port. (HDMI1/HDMI2/HDMI3)
	HDMI Music Mode	Allows music output from an mp3/audio player connected to an HDMI input source. When set to on, you can hear sound from the player through an HDMI input of the RJP whether there is a video signal or not. <ul style="list-style-type: none"> • This option is only compatible with the G-LINK RJP.
External Source	USB Pop-up Screen	When USB is connected to the TV : <ul style="list-style-type: none"> • Default: A popup window appears. • Automatic: This enters the USB content menu automatically. • Disable: Neither the popup window nor the menu appears.
	External Source Banner	If set to on, the TV displays the External Source Banner (information) when you change the TV source to another external source or when the TV turns on (set Power On Source value to other external source). <ul style="list-style-type: none"> • ON: The External Source Banner (information) is displayed on the TV screen. • OFF: The External Source Banner (information) is not displayed on the TV screen.
	Auto Source	<ul style="list-style-type: none"> • ON: When an external input source is connected to the TV, the TV identifies the input source, and then automatically switches to that input source. • OFF: Auto Source function is disabled.
	Anynet+ Return Source	Select the source to return after stopping an Anynet+ (HDMI-CEC) connection. <ul style="list-style-type: none"> • This function is especially useful for the G-LINK RJP.

Hotel Option menu Item		Description
Eco Solution	Power Saving Mode	Adjusts the brightness of the TV to reduce power consumption. <ul style="list-style-type: none"> • OFF: Turns off the energy saving function. • Low: Sets the TV to low energy saving mode. • Medium: Sets the TV to medium energy saving mode. • High: Sets the TV to high energy saving mode.
Logo/ Message	Welcome Message	Displays the welcome message for 60 seconds when the TV turns on.
	Edit Welcome Message	Edits the welcome message.
	Hospitality Logo	Turns the Hospitality Logo function is set to OFF, BMP, AVI, BOTH . If the function is not set to OFF , the TV is turned on, the logo is displayed, before the signal from the initial source, for the amount of time set in Logo Display Time . <ul style="list-style-type: none"> • The DivX codec is not supported.
	Hospitality Logo DL	You can download the startup logo from the connected USB flash drive. Hospitality logo file requirements: <ul style="list-style-type: none"> • Image or video files only. • The image file is supported up to 2 MB. • The video file is supported up to 50 MB. • File can only be named "samsung_image.*", "samsung_video.*"
	Logo Display Time	Set the time displayed Hospitality Logo . (3/5/7 second).
Cloning	Clone TV to USB	Clone the current TV options to a USB memory device.
	Clone USB to TV	Clone the saved TV options on a USB memory device to the TV.
	Setting Auto Initialize	If you set Setting Auto Initialize to On , and the TV's power is turned off and on, TV menu items are restored again to their values cloned initially.
System Manager		Gives you direct, immediate access to System Manager functions such as such as Time, Language, Change PIN , etc. System Manager allow you to adjust your TV's system and customise settings for your viewing environment.

Hotel Option menu Item	Description
Security	Factory Lock Disable entry to Hotel Option menu. <ul style="list-style-type: none"> • ON: The password is needed before entering Hotel Option menu. • OFF: Disable this function.
	Password Popup Enable or disable password input popup window. If this option is set to off, the TV will not display the password input popup window when entering the Hotel Option menu. If set to on, the password input popup window appears.
	Password Input If this function is enabled, the password input popup window appears which asks for an 8-character security password. The admin must enter a password before applying or updating security preferences. After the correct password is entered, options such as Password Setting , Password Reset and Security Mode are available.
	Password Setting User can change the password.
	Password Reset Password is reset to "00000000".
	Security Mode Provides password protected administrative functionality to enable or disable features of hospitality TV, such as USB , HDMI . To use this option, Security Mode set to on. After Security Mode set to on, options such as USB , HDMI are automatically enabled. Clone USB to TV and TV Reset will be disabled in the Hotel Option menu.
	USB Enable or disable USB access. If this function is set to disable, access to USB media is blocked.
	HDMI Enable or disable HDMI access. If this function is set to disable, Anynet+, HDMI source, HDMI type external channels will not be accessible to the user.
DRM	DRM Mode Configures DRM support. <ul style="list-style-type: none"> • OFF: Turns off DRM support. • LYNK DRM: Select to turn on S-LYNK DRM CAS support only. • Pro:Idiom: Select to turn on Pro:Idiom CAS support only. • LYNK DRM, PI: Select to have the TV support S-LYNK DRM CAS and Pro:Idiom CAS.

Hotel Option menu Item	Description	
System	Self Diagnosis for TV	Enter Self Diagnosis Menu. <ul style="list-style-type: none"> • Start Picture Test: Use this test when you experience a problem with your TV's picture. • Start Sound Test: Use this test when you experience a problem with your TV's sound. • Signal Information: Show digital broadcasting signal information. • Reset: Restore all TV settings, excluding network settings, to the factory defaults.
	Self Diagnosis for HTV	<ul style="list-style-type: none"> • STB SI Vendor Setting <ul style="list-style-type: none"> – Lets you check the communication with the SI STB or SBB. If you have any problems with the communications with the SI STB or SBB, use this diagnosis function. If your broadcasting system does not have a problem, contact Samsung Service. If STB SI Vendor Setting appears to have failed and communication with the SI STB or SBB has failed, first check your SI STB or SBB. If your SI STB or SBB does not have a problem, contact to Samsung Service. • RTC <ul style="list-style-type: none"> – If the time information is not correct when you turn the TV off and then on, use this function. – If the Real Time Clock (RTC) setting fails, contact a Samsung service centre.
	Software Update	Lets you upgrade the TV Software with a USB flash drive.
	Sound Bar Out	If the Samsung Sound Bar device is connected to this TV, this item lets you to select where the TV sound is outputted when the TV is turned on. <ul style="list-style-type: none"> • ON: When the TV is turned on, the TV sound is automatically outputted in the Sound Bar device only. • OFF: When the TV is turned on, the TV sound is automatically outputted in the TV speaker device only.
	Contact Samsung	Display the web site of related Samsung service center, and product and software information.
	Standby LED	When the TV is in standby mode, you can configure the settings of the power indicator. <ul style="list-style-type: none"> • ON: The LED is on. • OFF: The LED is off.
	Boot Logo	To enable or disable displaying the Samsung logo when the TV turns on.
	TV Reset	Returns all settings on the TV to their factory defaults.
BLAN Power	Turns the built-in BLAN module functions on or off. <ul style="list-style-type: none"> – This function is only available when Hospitality Mode is set to Interactive Mode and SI Vendor is set to EBL. 	

Hotel Option menu Item		Description
*Home Menu	Home Menu Display	<p>Activate Home Menu in Standalone mode for user.</p> <ul style="list-style-type: none"> • ON: Home Menu enabled. • OFF: Home Menu disabled. <p>In Standalone mode, you can quickly access to various features such as Alarm, Media Play etc and settings such as Picture Size, Language, etc.</p>
	Home Menu Editor	Edit and manage TV functions to be used from Home Menu .
	Home Menu Auto Start	<p>This option allows you to set Home Menu as first screen for user.</p> <ul style="list-style-type: none"> • ON: Home Menu is shown as first screen. • OFF: Do not show Home Menu as first screen.
REACH Solution	REACH RF Mode	Turn on or off the REACH RF Mode . When set to on, the TV can operate with the REACH Server (Modulator) through the RF cable.
	REACH Channel	This is a DTV cable channel PTC number for receiving REACH data when the REACH RF Mode set to on. The value must be same as the value set on the REACH Server (Modulator).
	Group ID	You can set the TV's group ID to manage TVs in groups on the REACH Server (Modulator).
	REACH Update Time	<p>You can set the specific time to receive and update REACH data from the REACH Server (Modulator). (Operates when the AC power cord is plugged in and the power is off.)</p> <ul style="list-style-type: none"> • OFF: You can turn off the REACH Update Time function. • 12:00 am: 12:00 am everyday • 2:00 am: 2:00 am everyday • 12:00 pm: 12:00 pm everyday • 2:00 pm: 2:00 pm everyday
	REACH Update Immediate	When set to on, the TV will receive and update REACH data from the REACH Server (Modulator) right after the power is off. (Operates when the AC power cord is plugged in and the power is off.)
	REACH Config Version	Displays the TV configuration data version received from the REACH Server.
Room Number	You can set the room number of the TV's location.	

*: The function may not be supported depending on **SI Vendor**.

- Refer to the manual of each solution for details about functions and settings of the solutions such as REACH.
- REACH (Remote Enhanced Active Control for Hospitality) is a professional, interactive remote controller that lets you deliver TV firmware updates, cloning data, channel mapping changes, REACH contents, and TICKER contents through RF cable to several hundred hospitality TVs simultaneously. The REACH functions are available only in **Standalone** mode. The REACH Server is sold separately. Refer to the REACH Server manual enclosed with the REACH Server product for more operating information.

Welcome Message

Hotel Option (MUTE > 1 > 1 > 9 > Select ) > Logo/Message > Welcome Message

Welcome Message function displays a custom message on the TV every time it is turned on.

- Set **Welcome Message** to on to display the message when the TV is powered on.
- You can make the welcome message and edit it.
- You can edit the welcome message by using on screen keyboard in the **Edit Welcome Message** (Hotel Option > Logo/Message > Edit Welcome Message).
- Use the directional buttons on the remote control to enter the title and message, and select **Save**.

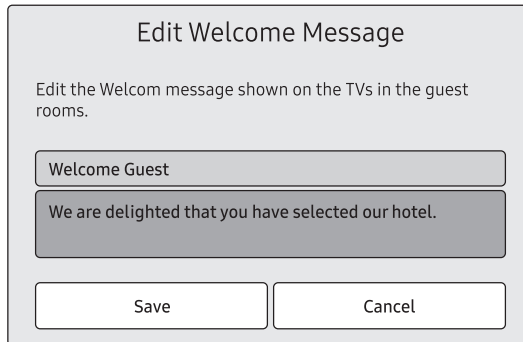

Edit Welcome Message

Edit the Welcom message shown on the TVs in the guest rooms.

Welcome Guest

We are delighted that you have selected our hotel.

Save Cancel

Hotel Logo

Hospitality Logo

Hotel Option (MUTE > 1 > 1 > 9 > Select ) > Logo/Message > Hospitality Logo

Hospitality Logo function displays the Hotel's picture image when the TV is powered on.

- When you set **Hospitality Logo** to AVI / BMP / BOTH, **Hospitality Logo DL** and **Logo Display Time** are enabled.
- If there is a logo image stored in memory and the **Hospitality Logo** is AVI / BMP / BOTH, the logo image is displayed when the TV is turned on.
- The logo image is not displayed when set **Hospitality Logo** to off, even if the logo image has been loaded into the TV.

Logo Download

Hotel Option (MUTE > 1 > 1 > 9 > Select ) > Logo/Message > Hospitality Logo DL

This option lets you download the logo image to the TV's memory from a USB device.

- The wait message appears while the image is being copied to the TV.
- The completed message appears when the copy operation finishes successfully.
- The failed message appears if the copy operation was unsuccessful.
- No USB appears if no USB device is connected.
- If there is no file to copy on the USB device or the file is in the wrong format, the message that there is no file appears.
- If message that there is no file appears and there is a logo file on the USB device, check the file format.
- Logo file format
 - TV Supports all file formats.
 - File name must be "samsung_image.*" and "samsung_video.*"
 - Maximum file size can be 50MB for Smart models.
 - The TV does not change the size or scale of the image.

USB Cloning



Hotel Option (MUTE > 1 > 1 > 9 > Select ) > Cloning

The USB cloning function lets you download user-configured settings (Picture, Sound, Channel, and Hotel Option) from one TV to a USB device, and then upload these settings from the USB device to other TV sets. This lets you create a standard file of settings and distribute that standard file to all the TVs in your facility.

- After cloning, certain features are applied when the TV is turned on again.

Cloning TV to USB: Copies stored menu settings from a TV to a USB device

Hotel Option (MUTE > 1 > 1 > 9 > Select ) > Cloning > Clone TV to USB

1. Insert a USB drive into the USB port on the rear of the TV.
2. Enter the **Hotel Option** menu by pressing buttons in order. (MUTE > 1 > 1 > 9 > Select )
3. Press the up or down directional button to select **Clone TV to USB**, and press the **Select**  button on the remote control.
4. When the message **Clone TV to USB** is displayed. Press the **Select**  button on the remote control.
 - The clone folder will be labeled T-KTM2AKUCB.
 - The cloned values include the values on the guest side menu (Brightness, Picture Size, Contrast, etc.) and the **Hotel Option** menu.

Cloning USB to TV: Copies menu settings and channel data in a USB device to a TV

Shortcut: Turn the TV off, insert the USB device, turn the TV on, and then press the **Select** button on the remote control for 5 seconds.

To clone data to the TV using the Hotel menu, follow these steps:

1. Turn the TV off.
2. Insert the USB drive into the USB port on the rear of the TV.
3. Turn the TV on.
4. Enter the **Hotel Option** menu by pressing buttons in order. (**MUTE** > **1** > **1** > **9** > **Select** button)
5. Press the up or down directional button to select **Clone USB to TV**, and press the **Select** button on the remote control.
6. The message **Clone USB to TV** is displayed. Press the **Select** button on the remote control.
 - If there is no file to copy on the USB device or the message that there is no file appears, check the folder on your USB device.
 - The folder name should be **T-KTM2AKUCB**.
 - Tables that list the settings that are cloned in the **Hotel Option** menu begin on the next page.

Pre-condition for cloning (check point)

- Cloning should be done between same model (same version).
- Before cloning, all displays should be updated at the latest version (same version).

Settings Cloned in the Hotel Menu

- The menu items may not be supported depending on the models.

Menu Item	Sub Item	Cloned or not	
Hospitality Mode	Standalone / Interactive	Yes	
SI Vendor	Interactive mode : Samsung / OCC / MTI / Nstreams / Enseio / Cardinal / Guestek / SeaChange / MDC / Innvue / EBL Standalone mode : OFF / Smoovie / SSCP	Yes	
Power On	Power On Channel	User Defined / Last Saved	Yes
	Power On Channel Num	***	Yes
	Power On Channel Type	ATV / DTV / CATV / CDTV	Yes
	Power On Volume	User Defined / Last Saved	Yes
	Power On Volume Num	0~100	Yes
	Min Volume	0~100	Yes
	Max Volume	0~100	Yes
	Power On Source	TV / HDMI1 / HDMI2 / HDMI3 / Last Saved	Yes
Power On Option	Power On / Standby / Last Option	Yes	
Channel	Channel Setup	—	No
	Channel Editor	—	No
	Channel Bank Editor	—	No
	Mixed Channel Map	ON / OFF	Yes
	Dynamic SI	ON / OFF	Yes
	MyChannel	ON / OFF	Yes
Menu OSD	Picture Menu Lock	ON / OFF	Yes
	Menu Display	ON / OFF	Yes
	Channel Menu Display	ON / OFF	Yes
	Panel Button Lock	Unlock / Lock / OnlyPower	Yes
Clock	Local Time	Standalone: Manual / Time Channel Interactive: Manual / Auto / Time Channel	Yes
	Timer Type	WakeUp / OnOff	Yes
	Time Channel Type	DTV / CDTV	Yes
	Time Channel Num	***	
Remote Jack Pack	HDMI Option	HDMI1 / HDMI2 / HDMI3	Yes
	HDMI Music Mode	ON / OFF	Yes
External Source	USB Pop-up Screen	Default / Automatic / Disable	Yes
	External Source Banner	ON / OFF	Yes
	Auto Source	ON / OFF	Yes
	Anynet+Return Source	Power On Src / Last Source / Each model source list (TV, HDMI1, HDMI2, etc.)	Yes
Eco Solution	Power Saving Mode	OFF / Low / Medium / High	Yes

Menu Item		Sub Item	Cloned or not	
Logo / Message	Welcome Message		ON / OFF	Yes
	Edit Welcome Message		—	Yes
	Hospitality Logo		OFF / BMP / AVI / BOTH	Yes
	Hospitality Logo DL		—	Yes
	Logo Display Time		3 second / 5 second / 7 second	Yes
Cloning	Clone TV to USB		—	No
	Clone USB to TV		—	No
	Setting Auto Intialize		ON / OFF	Yes
System Manager		—	No	
Security	FactoryLock		ON / OFF	Yes
	Password Popup		ON / OFF	Yes
	Password Input		—	No
	Password Setting		—	Yes
	Password Reset		—	No
	Security Mode		ON / OFF	Yes
	USB		Enable / Disable	Yes
	HDMI		Enable / Disable	Yes
DRM	DRM Mode		OFF / LYNK DRM / Pro:idiom / LYNK DRM, PI	Yes
System	Self Diagnosis for TV		—	No
	Self Diagnosis for HTV	PI DTV Channel Key Loss	Success / Failure	No
		STB SI Vendor-Setting	Si Name Success / Failure	
		RTC	Success / Failure	
	Software Update		—	No
	Sound Bar Out		ON / OFF	Yes
	Contact Samsung		—	No
	Standby LED		ON / OFF	Yes
	Boot Logo		ON / OFF	Yes
	TV Reset		—	No
BLAN Power		ON / OFF	Yes	
Home Menu	Home Menu Display		ON / OFF	Yes
	Home Menu Editor		—	Yes
	Home Menu Auto Start		ON / OFF	Yes
REACH Solution	REACH RF Mode		ON / OFF	Yes
	REACH Channel		***	Yes
	Group ID		ALL, 1 - 511	No
	REACH Update Time		OFF / 12:00 am / 2:00 am / 12:00 pm / 2:00 pm	Yes
	REACH Update Immediate		ON / OFF	Yes
	REACH Config Version		—	No
Room Number		—	No	

Setting Auto Initialize

Hotel Option (MUTE > 1 > 1 > 9 > Select ) > Cloning > Setting Auto Initialize

When you clone settings from one TV to another, you clone both the guest side menu and hotel side menu settings: **Picture, Sound, Channel, and Hotel Option** menu. This lets you set nearly all of the menu values on your hospitality TVs to the same, standard settings. If you allow guests access to the guest side menus, for example the **Picture** menu, they can change the settings in those menus so they are no longer standard. If you set the **Setting Auto Initialize** function to on, the TV automatically restores (initializes) any guest-side menu values to the cloned, standard values when the TV is turned off and then turned on again. Note that **Setting Auto Initialize** works on cloned guest side menu values only. Settings which have not been cloned are ignored.

The table below lists the settings that are restored to their cloned values when you set the **Setting Auto Initialize** function to on.

- The menu items may not be supported depending on the models.

Menu Item				
Picture	Picture Mode			
	Picture Size Settings	Picture Size		
		Fit to Screen		
		Zoom and Position		
	Expert Settings	Backlight		
		Brightness		
		Contrast		
		Sharpness		
		Color		
		Tint (G/R)		
		Apply Picture Settings		
		Digital Clean View		
		Auto Motion Plus Settings	Auto Motion Plus	
			Judder Reduction	
			LED Clear Motion	
		Contrast Enhancer		
	Film Mode			
	Color Tone			

Menu Item					
Picture	Expert Settings	White Balance	2 Point	R-Gain	
				G-Gain	
				B-Gain	
				R-Offset	
				G-Offset	
				B-Offset	
			20 Point Settings	20 Point	
				Interval	
			Red		
			Green		
			Blue		
			Gamma		
			HLG		
			ST.2084		
	BT.1886				
	RGB Only Mode				
	Color Space Settings	Color Space			
		Color			
		Red			
		Green			
		Blue			
Sound	Sound Output				
	Sound Mode				
	Expert Settings	Balance			
		Equalizer			
		HDMI Input Audio Format			
		Digital Output Audio Format			
		Audio Delay			
		Auto Volume			
Sound Feedback					
General	System Manager	Time	Clock	Clock Mode	
		Language			
		Auto Protection Time			
	External Device Manager	Anynet+ (HDMI-CEC)			
		HDMI UHD Color			
		HDMI Black Level			
		Input Device Manager	Keyboard Settings	Keyboard Language	
			Keyboard Type		
	Eco Solution	Auto Power Off			
	Accessibility	High Contrast			



Updating the TV's Software

DO NOT turn off the TV's power until the update is complete. The TV will turn off and on automatically after completing the software update. Video and audio settings will be reset to their defaults after a software update. We recommend you clone the TV's settings so that you can easily reset them after the upgrade.

- For more information about the USB cloning function, refer to page 32.

Updating through a USB device

To update the TV's software, follow these steps:

1. Insert a USB flash drive containing the software update file into the USB port of the TV.
 2. Run **Update Now**. (MENU  > Support > Software Update > Update Now)
 3. The TV displays a pop-up message that checks for the updated version.
 4. Move the focus to **OK**, and then press the **Select**  button on the remote control.
- Please be careful to not disconnect the power or remove the USB flash drive while upgrades are being applied. The TV will turn off and turn on automatically after completing the SW upgrade. Please check the SW version after the upgrades are complete.

08 Using a Multi Code Remocon

A Multi Code Remocon is a special remote which is designed to control multiple TVs. This function is useful where there is more than one TV in a location.

You can control up to 10 TVs with a different ID code of each remote with no conflicts between the TVs. ID numbers are displayed on each TV's OSD.

The Initial ID code for each TV is **0**.

- You can set and reset the ID code in analog TV mode or PC mode. (Not available in DTV mode.)
- You can set the ID code to any digit from **0** to **9**.
- To set a TV's ID code, follow these steps:
 1. Aim the remote at the TV, and then press the **MUTE** button and the **RETURN** button simultaneously for more than 7 seconds. When you stop pressing the buttons, the TV displays the current ID in the middle of the screen and a message appears.
 2. Press the number on the remote you want to assign to the TV. The TV displays a message.
 3. After you see the message, if you press **1**, the TV and Remote will be set to ID code **1**.
 - The TV can then only be controlled by a remote which has the same ID code **1**.
 - To reset the ID code, press the **MUTE** button and the **EXIT** button simultaneously for more than 7 seconds. When you stop pressing the buttons, the ID codes of the TV and Remote are reset to **0**.

09 Setting the Soundbar

Samsung Soundbar (AirTrack) and Hospitality TVs in 2018

- Samsung Soundbar (AirTrack) and hospitality TVs support the HDMI ARC feature. If you connect a compatible Samsung Soundbar (AirTrack) to a compatible Samsung hospitality TV using a single HDMI cable, guests can listen to the TV's sound through the Soundbar (AirTrack).
- **Sound bar Out** in **Hotel Option** menu makes you control to where the TV sound is outputted when the TV is turned on.
 - **Hotel Option (MUTE > 1 > 1 > 9 > Select [OK]) > System > Sound Bar Out**
- If **Sound bar Out** set to on, the TV sound is automatically outputted in the Soundbar (AirTrack) device only whenever TV is turned on.
- If **Sound bar Out** set to off, the TV sound is automatically outputted in the TV speaker only whenever TV is turned on.
- Models supporting the ARC function are listed below:
 - HW-M550/M500/M4500
 - HW-N650/N550/N450

Setting the Soundbar (AirTrack) to Hotel Mode

1. Set the following options in **Hotel Option (MUTE > 1 > 1 > 9 > Select [OK])**:
 - **System > Sound Bar Out > ON**
 - **Power On > Power On Volume > User Defined**
 - **Power On > Power On Volume Num > set greater than 0**
 - **Power On > Max Volume > set greater than 0**
2. Connect an HDMI cable from the HDMI out port of the Soundbar (AirTrack) to the HDMI port (supporting ARC) on the TV.
3. After the Soundbar (AirTrack) is connected to the TV, when the TV turns on, the Soundbar (AirTrack) automatically detects the TV, and then automatically switches to Hotel Mode.

Soundbar (AirTrack) features in Hotel mode



- Power on / off is synchronized with the TV.
- HDMI-CEC defaults set to on
- Available only through the HDMI out port.
- Disables the "Input mode" key on the VFD to prevent unexpected audio-source changes.
- Acquires adjustable **Power On** and **Max Volume** settings from the TV's **Hotel Option** menu. However Soundbar's **Power On Volume** and **Max Volume** values are set to half of **Power On Volume** and **Max Volume** settings in the TV's **Hotel Option** menu.
 - If the TV's **Power On Volume** = 20 and **Max Volume** = 90, then Soundbar's **Power On Volume** = 10 and **Max Volume** = 45.
- To use **Voice Guide** while an external device is connected to the **DIGITAL AUDIO OUT (OPTICAL)** or **HDMI IN (ARC)** terminal, be sure to select **PCM** at **MENU [OK] > Sound > Expert Settings > Digital Output Audio Format**.

10 Editing Channels

Channel Bank Editor (Smovie TV Only)

Channel Bank Editor in conjunction with the SMOOVIE remote lets you control the channels guests have access to. Channel Bank Editor provides three Banks of channels and lets you select which channels will be available from each bank. SMOOVIE remotes have installable Bank Cards which correspond to the channel banks in the Channel Bank Editor. The remotes only allow access to channels in the channel bank that correspond to the installed card. Consequently, the channels a guest can access depend on the Bank Card installed in their SMOOVIE remote.

Setting the Channel Bank Editor under Standalone Mode

1. Press MUTE > 1 > 1 > 9 > Select  buttons on the remote control to enter the Hotel Option menu.
2. Go to SI vendor, and then select Smovie.
3. Go to Channel > Channel Bank Editor. Press the Select  button on the remote control.
4. Enter the Channel Bank Editor. Edit the Channel Bank.
 - Bank1 (Free channel): Select the channels that will be accessible when a remote doesn't have a card.
 - Bank2 (Family Card - Green): Select the channels that will be accessible when a remote has a GREEN CARD.
 - Bank3 (Adult Card - Red): Select the channels that will be accessible when a remote has a RED CARD.

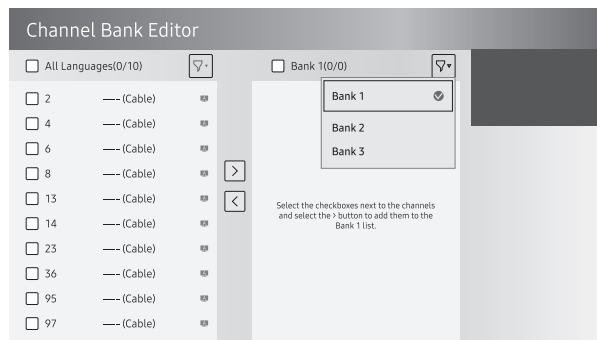

Information About SMOOVIE Remote Controls

- If you select SMOOVIE as the SI vendor, you should also use SMOOVIE remotes in your facility.
- Guests with remotes that do not have a card can only view channels from Bank 1.
- Guests using the numeric button on the remote control to change channels can only view channels from Bank 1.
- Guests with remotes that have Green or Red cards must use the channel up or down directional buttons to change channels.
- Guests can only see channels from the Bank 1 channel list in the Guide or the Channel List.

Smooovie Set Up Sequence

1. Complete the Initial Setup.
2. The TV displays the **Hotel Option** menu.
 - If the Initial Setup is already done, enter the **Hotel Option** menu. (MUTE > 1 > 1 > 9 > Select [EXIT])
3. Select the channel type. (Power On > Power On Channel Type)
 - ATV or ADTV for Air
 - CATV or CDTV for cable
4. Select **Smooovie** in the **SI Vendor** menu.
5. Select **Channel Setup** (Channel > Channel Setup).
6. Select **Air** or **Cable** to auto tune.
7. Set up channels in the **Channel Bank Editor** (Channel > Channel Bank Editor).
8. Turn off the TV, and then turn it on again. Then guests can use the TV.

Using Channel Editor

Hotel Option (MUTE > 1 > 1 > 9 > Select [EXIT]) > **Channel** > **Channel Editor**

Using **Channel Editor** you can edit the channels stored in the TV's memory.

- Change the channel numbers and names, edit the channel language and channel genre and delete channels.
 - This function is enabled when **My Channel** set to **On** in **Hotel Option** menu. (**Hotel Option** (MUTE > 1 > 1 > 9 > Select [EXIT]) > **Channel** > **My Channel**)
- If you apply the **Screen Off** function to the selected channels, a screen off message is displayed, and pictures are turned off by the **Screen Off** function and only audio is output from those channels.
- **Channel Editor** also lets you view information about each channel easily, without your having to display each channel directly.

General Steps for Using the Channel Editor in Standalone Mode

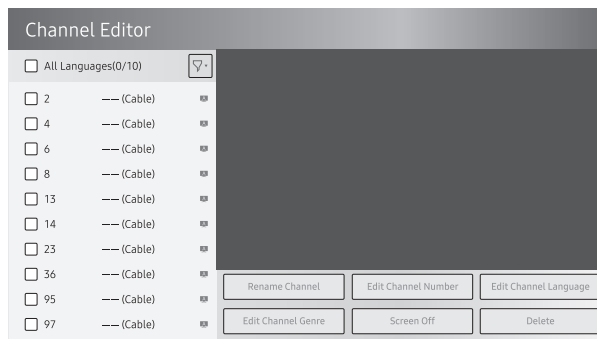

1. Run **Channel Setup** (Channel > Channel Setup) in the **Hotel Option** menu.
2. Enter **Channel Editor** (Channel > Channel Editor) in the **Hotel Option** menu.
3. On a piece of paper, compile a list of channels you want to have, arranged in the order you want.
4. Based on the list created in Step 3, rearrange the channels and edit the channel names.
5. Press the **EXIT** or **RETURN** button to exit.

Editing the Channel Number

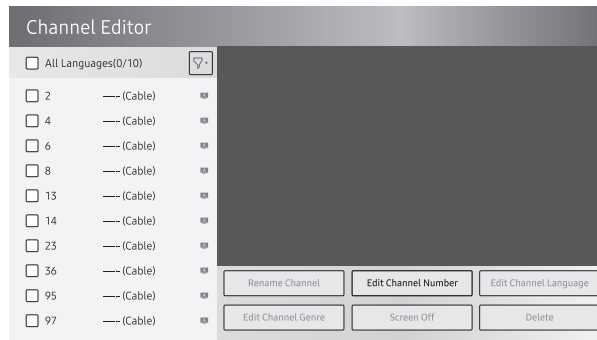

Change the channel number of a channel you select. To change a channel number, follow these steps:

1. Select a channel on the **Channel Edit** screen.
2. Use the directional buttons on the remote control, move the focus to **Edit Channel Number**, and **Select** button.
3. Use the up or down directional buttons on the remote control to change the channel number.
4. Select **OK** when done, and then press the **Select** button on the remote control.
 - When you change the channel number, the channel information is updated automatically.

Rename the Channel

Change the name of a channel you select. To change the name of a channel, follow these steps:

1. Select a channel on the **Channel Edit** screen.
2. Use the directional buttons on the remote control, move the focus to **Rename Channel**, and **Select** button.
3. Use the on-screen keyboard that appears to enter the new name for the channel. Use the directional buttons on the remote control, select a letter or number, and then press **Select** button. Repeat for each letter or number you want to select.
4. When finished, select **Done** on the bottom of the screen, and then press the **Select** button on the remote control.

Assigning the Channel Number to the external device

The external device source of the TV are displayed in the last page of the **Channel Editor** menu as shown below.

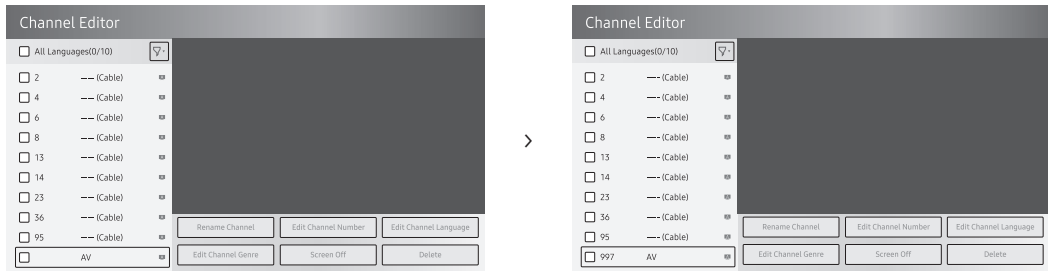



1. Select a external device source on the **Channel Edit** screen.
 2. Use the directional buttons on the remote control, move the focus to **Edit Channel Number**, and **Select** button.
 3. Use the up or down directional buttons on the remote control to assign the channel number.
 4. Select **OK** when done, and then press the **Select** button on the remote control.
- Once you assign a channel number to an external device, you can enter the external device without opening the TV source menu.

11 Anti-theft Kensington Lock

The Kensington Lock is a device you can use to physically fix a TV to a location when you use it in a public place. The appearance and locking method may differ from the illustration at right, depending on the manufacturer. Refer to the manual provided with the Kensington Lock for additional information on proper use.

- The Kensington Lock slot is only available on the HG43NJ678U model.

The Kensington Lock is not supplied by Samsung.

- Please find the  icon on the rear of the TV. A Kensington slot is beside the  icon.

To lock the product, follow these steps:

1. Wrap the Kensington lock cable around a large, stationary object such as desk or chair.
 2. Slide the end of the cable with the lock attached through the looped end of the Kensington lock cable.
 3. Insert the locking device into the Kensington slot on the product **1**.
 4. Lock the lock.
- These are general instructions. For exact instructions, see the User manual supplied with the locking device.
 - The locking device has to be purchased separately.
 - The location of the Kensington slot may be different depending on the TV model.

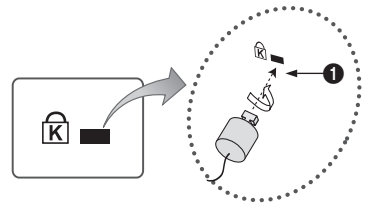

12 Specifications and Other Information

Specifications

Model Name	HG43NJ678U	HG50NJ678U
Display Resolution	3840 x 2160	3840 x 2160
Screen Size Diagonal Measured Diagonally	43" Class 42.5 inches	50" Class 49.5 inches
Sound (Output)	20 W	20 W
Stand Swivel (Left / Right)	20° / 60° / 90°	20° / 60° / 90°
Dimensions (W x H x D) Body With stand	38.2 x 22.2 x 2.3 inches (970.2 x 563.2 x 58.8 mm) 38.2 x 24.3 x 8.9 inches (970.2 x 618.1 x 226.5 mm)	44.3 x 25.6 x 2.4 inches (1124.8 x 650.2 x 59.7 mm) 44.3 x 27.7 x 8.9 inches (1124.8 x 704.2 x 226.5 mm)
Weight Without Stand With Stand	21.2 lbs (9.6 kg) 28.0 lbs (12.7 kg)	30.0 lbs (13.6 kg) 37.0 lbs (16.8 kg)
Model Name	HG55NJ678U	HG65NJ678U
Display Resolution	3840 x 2160	3840 x 2160
Screen Size Diagonal Measured Diagonally	55" Class 54.6 inches	65" Class 64.5 inches
Sound (Output)	20 W	20 W
Stand Swivel (Left / Right)	20° / 60° / 90°	20° / 60° / 90°
Dimensions (W x H x D) Body With stand	48.8 x 28.1 x 2.3 inches (1238.6 x 714.2 x 59.2 mm) 48.8 x 30.3 x 8.9 inches (1238.6 x 768.4 x 226.5 mm)	57.4 x 33.0 x 2.4 inches (1457.5 x 837.3 x 59.7 mm) 57.4 x 35.8 x 14.0 inches (1457.5 x 908.7 x 355.1 mm)
Weight Without Stand With Stand	38.1 lbs (17.3 kg) 45.2 lbs (20.5 kg)	55.1 lbs (25.0 kg) 66.6 lbs (30.2 kg)

Environmental Considerations

Operating Temperature	50°F to 104°F (10°C to 40°C)
Operating Humidity	10% to 80%, non-condensing
Storage Temperature	-4°F to 113°F (-20°C to 45°C)
Storage Humidity	5% to 95%, non-condensing

Notes

- Design and specifications are subject to change without prior notice.
- For information about the power supply, and more information about power consumption, refer to the information on the label attached to the product.
 - On most models, the label is attached to the back of the TV. (On some models, the label is inside the cover terminal.)
- Typical power consumption is measured according to Energy Star Program requirements for televisions.
- Your TV and its accessories may look different than the product images presented in this manual, depending on the model.
- All drawings are not necessarily to scale. Some dimensions are subject to change without prior notice. Refer to the dimensions before installing your TV. Not responsible for typographical or printed errors.

Decreasing power consumption

When you shut the TV off, it enters Standby mode. In Standby mode, it continues to draw a small amount of power. To decrease power consumption, unplug the power cord when you don't intend to use the TV for a long time.

Supported Resolutions for UHD Input Signals

- Resolution: 3840 x 2160p, 4096 x 2160p
 - An HDMI connection with HDMI UHD Color set to Off supports up to UHD 50P/60P 4:2:0 input signals, while an HDMI connection with HDMI UHD Color set to On supports up to UHD 50P/60P 4:4:4 and 4:2:2 input signals.
 - MENU > General > External Device Manager > HDMI UHD Color

If HDMI UHD Color is set to Off

Frame rate (fps)	RGB	YCbCr 4:4:4	YCbCr 4:2:2	YCbCr 4:2:0
24 / 25 / 30	0	0	0	-
50 / 60	-	-	-	0

If HDMI UHD Color is set to On

Frame rate (fps)	RGB	YCbCr 4:4:4	YCbCr 4:2:2	YCbCr 4:2:0
24 / 25 / 30	0	0	0	-
50 / 60	0	0	0	0

Display Resolution

When you use your TV as a computer monitor, you can also select one of the standard resolutions listed in the Resolution column. The TV will automatically adjust to the resolution you choose.

Mode	Resolution	Display format	Horizontal frequency (KHz)	Vertical frequency (Hz)	Clock frequency (MHz)	Polarity (horizontal / vertical)
IBM	720 x 400	70 Hz	31.469	70.087	28.322	-/+
MAC	640 x 480	67 Hz	35.000	66.667	30.240	-/-
	832 x 624	75 Hz	49.726	74.551	57.284	-/-
	1152 x 870	75 Hz	68.681	75.062	100.000	-/-
VESA DMT	640 x 480	60 Hz	31.469	59.940	25.175	-/-
	640 x 480	72 Hz	37.861	72.809	31.500	-/-
	640 x 480	75 Hz	37.500	75.000	31.500	-/-
	800 x 600	60 Hz	37.879	60.317	40.000	+/+
	800 x 600	72 Hz	48.077	72.188	50.000	+/+
	800 x 600	75 Hz	46.875	75.000	49.500	+/+
	1024 x 768	60 Hz	48.363	60.004	65.000	-/-
	1024 x 768	70 Hz	56.476	70.069	75.000	-/-
	1024 x 768	75 Hz	60.023	75.029	78.750	+/+
	1152 x 864	75 Hz	67.500	75.000	108.000	+/+
	1280 x 720	60 Hz	45.000	60.000	74.250	+/+
	1280 x 800	60 Hz	49.702	59.810	83.500	-/+
	1280 x 1024	60 Hz	63.981	60.020	108.000	+/+
	1280 x 1024	75 Hz	79.976	75.025	135.000	+/+
	1366 x 768	60 Hz	47.712	59.790	85.500	+/+
	1440 x 900	60 Hz	55.935	59.887	106.500	-/+
	1600 x 900RB	60 Hz	60.000	60.000	108.000	+/+
1680 x 1050	60 Hz	65.290	59.954	146.250	-/+	
1920 x 1080	60 Hz	67.500	60.000	148.500	+/+	
1920 x 1200	60 Hz	74.556	59.885	193.250	-/+	

Mode	Resolution	Display format	Horizontal frequency (KHz)	Vertical frequency (Hz)	Clock frequency (MHz)	Polarity (horizontal / vertical)
CEA-861	720(1440) x 576i	50 Hz	15.625	50.000	27.000	- / -
	720(1440) x 480i	60 Hz	15.734	59.940	27.000	- / -
	720 x 576	50 Hz	31.250	50.000	27.000	- / -
	720 x 480	60 Hz	31.469	59.940	27.000	- / -
	1280 x 720	50 Hz	37.500	50.000	74.250	+ / +
	1280 x 720	60 Hz	45.000	60.000	74.250	+ / +
	1920 x 1080i	50 Hz	28.125	50.000	74.250	+ / +
	1920 x 1080i	60 Hz	33.750	60.000	74.250	+ / +
	1920 x 1080	24 Hz	27.000	24.000	74.250	+ / +
	1920 x 1080	25 Hz	28.125	25.000	74.250	+ / +
	1920 x 1080	30 Hz	33.750	30.000	74.250	+ / +
	1920 x 1080	50 Hz	56.250	50.000	148.500	+ / +
	1920 x 1080	60 Hz	67.500	60.000	148.500	+ / +
	3840 x 2160	24 Hz	54.000	24.000	297.000	+ / +
	3840 x 2160	25 Hz	56.250	25.000	297.000	+ / +
	3840 x 2160	30 Hz	67.500	30.000	297.000	+ / +
	3840 x 2160	50 Hz	112.500	50.000	594.000	+ / +
	3840 x 2160	60 Hz	135.000	60.000	594.000	+ / +
	4096 x 2160	24 Hz	54.000	24.000	297.000	+ / +
	4096 x 2160	25 Hz	56.250	25.000	297.000	+ / +
4096 x 2160	30 Hz	67.500	30.000	297.000	+ / +	
4096 x 2160	50 Hz	112.500	50.000	594.000	+ / +	
4096 x 2160	60 Hz	135.000	60.000	594.000	+ / +	
HDMI	3840 x 2160	30 Hz	67.500	30.000	297.000	+ / +
	3840 x 2160	25 Hz	56.250	25.000	297.000	+ / +
	3840 x 2160	24 Hz	54.000	24.000	297.000	+ / +
	4096 x 2160	24 Hz	54.000	24.000	297.000	+ / +

- The interlaced mode is not supported.
- The set might operate abnormally if you select a non-standard video format.
- Separate and Composite modes are supported. SOG (Sync On Green) is not supported.

Dimensions

Front view / Side view

The displayed image may differ from your TV, depending on the model.

- 43"

(Unit: inches)

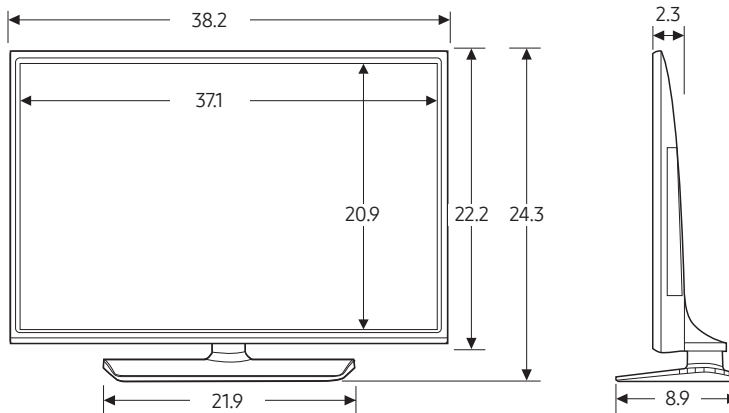

- 50"

(Unit: inches)

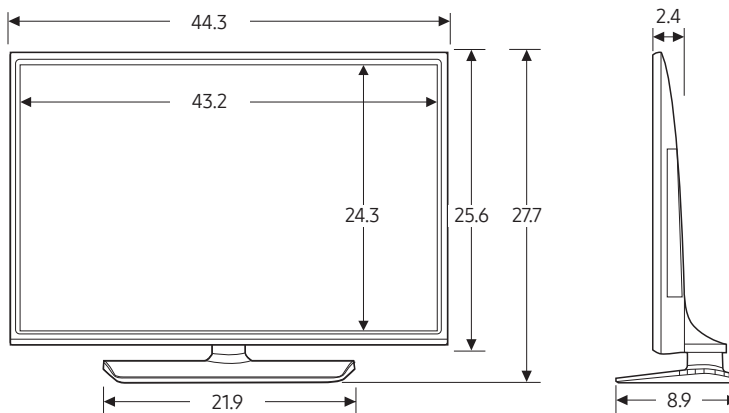

• 55"

(Unit: inches)

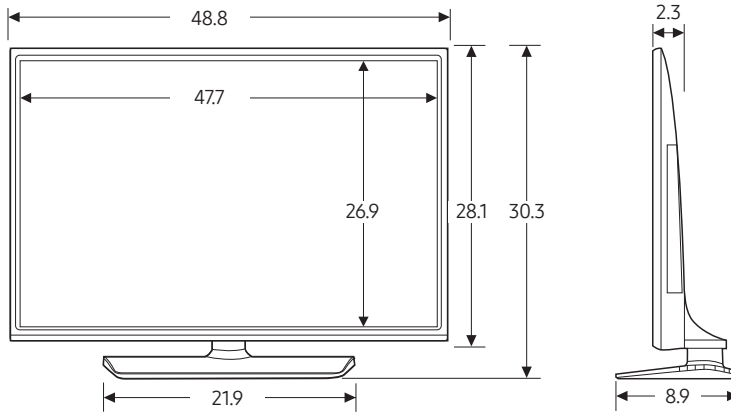

• 65"

(Unit: inches)

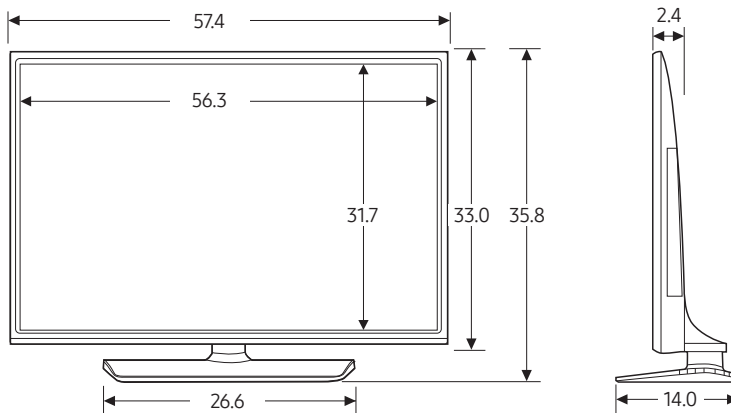

Port panel detail / Rear view

Detailed dimensions can be checked at Displaysolutions.samsung.com.

Base Stand detail

The displayed image may differ from your TV, depending on the model.

- 43"

(Unit: inches)

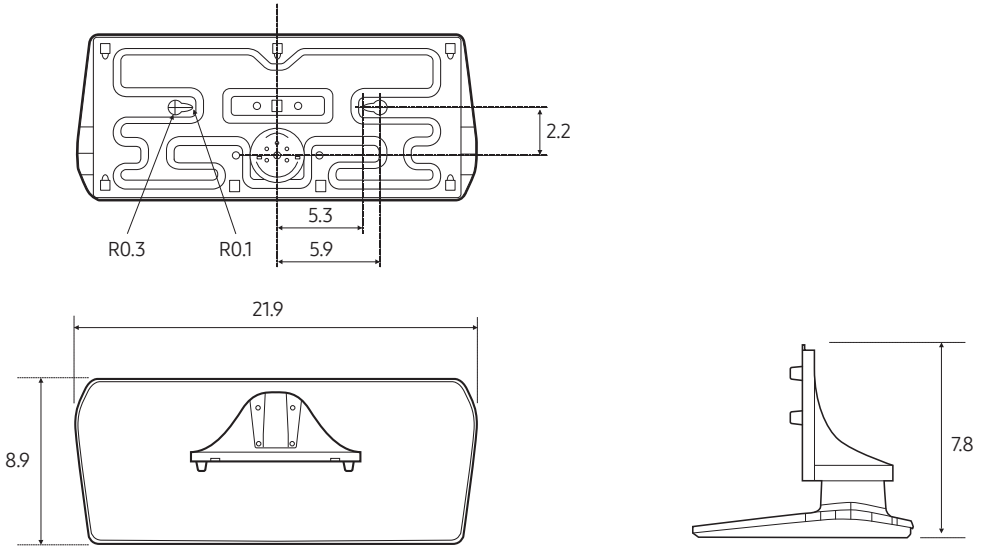

- 50"-55"

(Unit: inches)

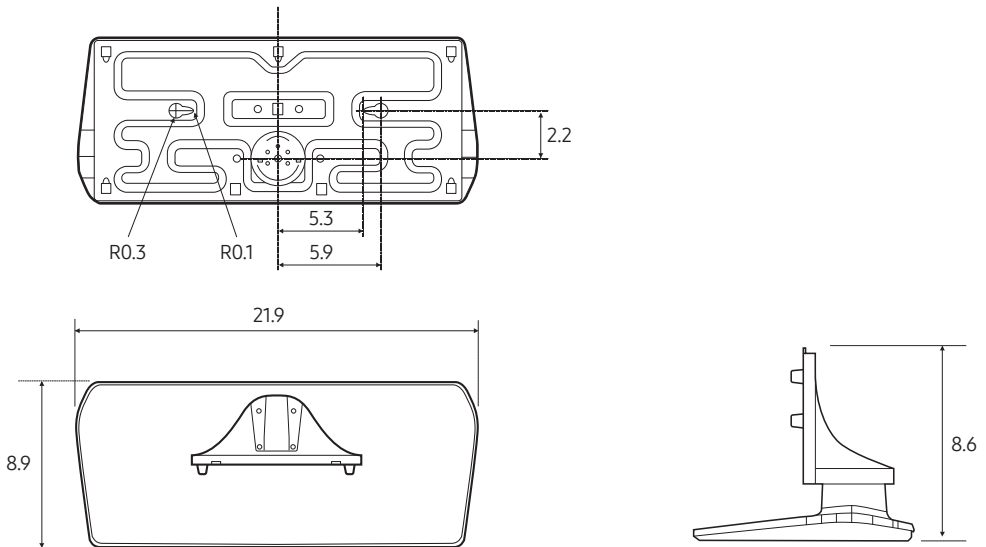

• 65"

(Unit: inches)

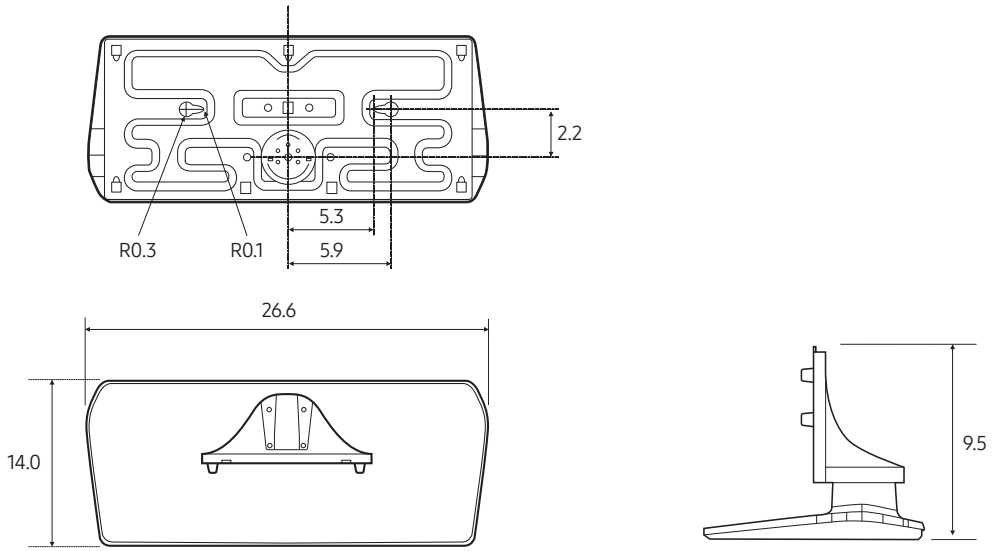

Licenses



Manufactured under license from Dolby Laboratories. Dolby, Dolby Audio, Pro Logic, and the double-D symbol are trademarks of Dolby Laboratories.



THIS PRODUCT IS SOLD WITH A LIMITED LICENCE AND IS AUTHORISED TO BE USED ONLY IN CONNECTION WITH HEVC CONTENT THAT MEETS EACH OF THE THREE FOLLOWING QUALIFICATIONS: (1) HEVC CONTENT ONLY FOR PERSONAL USE; (2) HEVC CONTENT THAT IS NOT OFFERED FOR SALE; AND (3) HEVC CONTENT THAT IS CREATED BY THE OWNER OF THE PRODUCT.

THIS PRODUCT MAY NOT BE USED IN CONNECTION WITH HEVC ENCODED CONTENT CREATED BY A THIRD PARTY, WHICH THE USER HAS ORDERED OR PURCHASED FROM A THIRD PARTY, UNLESS THE USER IS SEPARATELY GRANTED RIGHTS TO USE THE PRODUCT WITH SUCH CONTENT BY A LICENSED SELLER OF THE CONTENT.

YOUR USE OF THIS PRODUCT IN CONNECTION WITH HEVC ENCODED CONTENT IS DEEMED ACCEPTANCE OF THE LIMITED AUTHORITY TO USE AS NOTED ABOVE.



The terms HDMI and HDMI High-Definition Multimedia Interface, and the HDMI Logo are trademarks or registered trademarks of HDMI Licensing LLC in the United States and other countries.

Open Source License Notice

Open Source used in this product can be found on the following webpage. (<http://opensource.samsung.com>)

Open Source License Notice is written only English.

Important Warranty Information Regarding Television Format Viewing

- See the warranty card for more information on warranty terms.

Wide screen format LED Displays (16:9, the aspect ratio of the screen width to height) are primarily designed to view wide screen format full-motion video. The images displayed on them should primarily be in the wide screen 16:9 ratio format, or expanded to fill the screen if your model offers this feature and the images are constantly moving. Displaying stationary graphics and images on screen, such as the dark sidebars on nonexpanded standard format television video and programming, should be limited to no more than 5% of the total television viewing per week.

Additionally, viewing other stationary images and text such as stock market reports, video game displays, station logos, web sites or computer graphics and patterns, should be limited as described above for all televisions. Displaying stationary images that exceed the above guidelines can cause uneven aging of LED Displays that leave subtle, but permanent burned-in ghost images in the LED picture. To avoid this, vary the programming and images, and primarily display full screen moving images, not stationary patterns or dark bars. On LED models that offer picture sizing features, use these controls to view different formats as a full screen picture.

Be careful in the selection and duration of television formats used for viewing. Uneven LED aging as a result of format selection and use, as well as burned-in images, are not covered by your Samsung limited warranty.

SAMSUNG ELECTRONICS NORTH AMERICAN LIMITED WARRANTY STATEMENT

Subject to the requirements, conditions, exclusions and limitations of the original Limited Warranty supplied with Samsung Electronics (SAMSUNG) products, and the requirements, conditions, exclusions and limitations contained herein, SAMSUNG will additionally provide Warranty Repair Service in the United States on SAMSUNG products purchased in Canada, and in Canada on SAMSUNG products purchased in the United States, for the warranty period originally specified, and to the Original Purchaser only.

The above described warranty repairs must be performed by a SAMSUNG Authorized Service Center. Along with this Statement, the Original Limited Warranty Statement and a dated Bill of Sale as Proof of Purchase must be presented to the Service Center. Transportation to and from the Service Center is the responsibility of the purchaser. Conditions covered are limited only to manufacturing defects in material or workmanship, and only those encountered in normal use of the product.

Excluded, but not limited to, are any originally specified provisions for, in-home or on-site services, minimum or maximum repair times, exchanges or replacements, accessories, options, upgrades, or consumables.

For the location of a SAMSUNG Authorized Service Center, please call toll-free:

- In the United States: 1-866-sam4biz
- In Canada: 1-800-749-0205

