



DLP® Projector

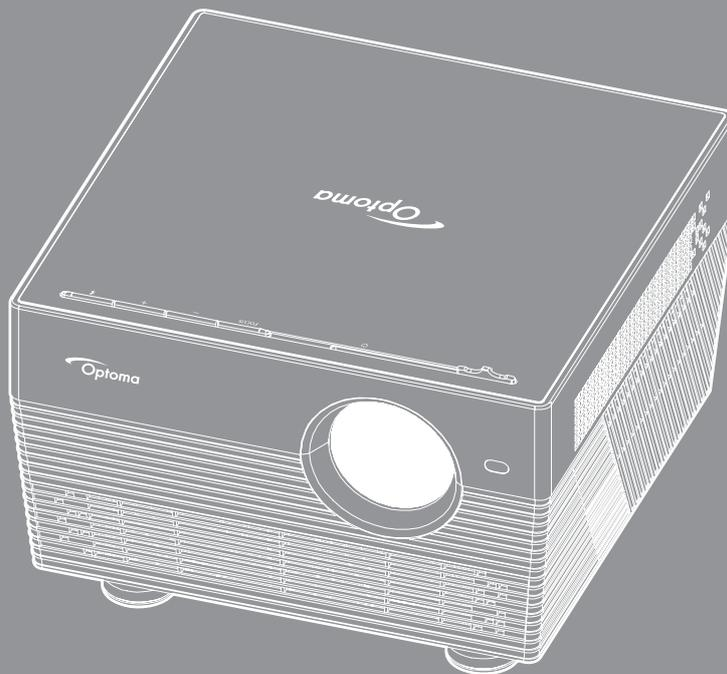

TABLE OF CONTENTS

SAFETY	4
<i>Important Safety Instruction.....</i>	<i>4</i>
<i>3D Safety Information.....</i>	<i>5</i>
<i>Copyright.....</i>	<i>6</i>
<i>Disclaimer.....</i>	<i>6</i>
<i>Trademark Recognition</i>	<i>6</i>
<i>FCC</i>	<i>6</i>
<i>Declaration of Conformity for EU countries</i>	<i>7</i>
<i>WEEE.....</i>	<i>7</i>
INTRODUCTION	8
<i>Package Overview.....</i>	<i>8</i>
<i>Standard accessories.....</i>	<i>8</i>
<i>Optional accessories.....</i>	<i>8</i>
<i>Product Overview</i>	<i>9</i>
<i>Connections.....</i>	<i>10</i>
<i>Keypad</i>	<i>10</i>
<i>IR remote control.....</i>	<i>11</i>
<i>Bluetooth remote control</i>	<i>12</i>
SETUP AND INSTALLATION	14
<i>Installing the projector</i>	<i>14</i>
<i>Connecting sources to the projector.....</i>	<i>15</i>
<i>Adjusting the projector image.....</i>	<i>16</i>
<i>Remote setup</i>	<i>18</i>
USING THE PROJECTOR.....	20
<i>Powering on / off the projector.....</i>	<i>20</i>
<i>Selecting an input source</i>	<i>23</i>
<i>Using the projector as wireless speaker.....</i>	<i>24</i>
<i>Home screen overview.....</i>	<i>26</i>
<i>Projector settings.....</i>	<i>27</i>
<i>Application settings.....</i>	<i>40</i>
<i>General settings</i>	<i>52</i>

ADDITIONAL INFORMATION 59

<i>Compatible resolutions</i>	59
<i>Image size and projection distance</i>	60
<i>Projector dimensions and ceiling mount installation</i>	61
<i>IR remote codes</i>	62
<i>Bluetooth remote codes</i>	63
<i>Troubleshooting</i>	64
<i>LED lightning messages</i>	66
<i>Specifications</i>	68
<i>Configuring Smart Home with the projector</i>	69
<i>Optoma global offices</i>	76

SAFETY

	The lightning flash with arrow head within an equilateral triangle is intended to alert the user to the presence of uninsulated "dangerous voltage" within the product's enclosure that may be of sufficient magnitude to constitute a risk of electric shock to persons.
	The exclamation point within an equilateral triangle is intended to alert the user to the presence of important operating and maintenance (servicing) instructions in the literature accompanying the appliance.

Please follow all warnings, precautions and maintenance as recommended in this user's guide.

Important Safety Instruction

- RG1 IEC 62471-5:2015.
- Do not block any ventilation openings. To ensure reliable operation of the projector and to protect from over heating, it is recommended to install the projector in a location that does not block ventilation. As an example, do not place the projector on a crowded coffee table, sofa, bed, etc. Do not put the projector in an enclosure such as a book case or a cabinet that restricts air flow.
- To reduce the risk of fire and/or electric shock, do not expose the projector to rain or moisture. Do not install near heat sources such as radiators, heaters, stoves or any other apparatus such as amplifiers that emits heat.
- Do not let objects or liquids enter the projector. They may touch dangerous voltage points and short out parts that could result in fire or electric shock.
- Do not use under the following conditions:
 - In extremely hot, cold or humid environments.
 - (i) Ensure that the ambient room temperature is within 5°C ~ 40°C
 - (ii) Relative humidity is 10% ~ 85%
 - In areas susceptible to excessive dust and dirt.
 - Near any appliance generating a strong magnetic field.
 - In direct sunlight.
- Do not use the unit if it has been physically damaged or abused. Physical damage/abuse would be (but not limited to):
 - Unit has been dropped.
 - Power supply cord or plug has been damaged.
 - Liquid has been spilled on to the projector.
 - Projector has been exposed to rain or moisture.
 - Something has fallen in the projector or something is loose inside.
- Do not place the projector on an unstable surface. The projector may fall over resulting in injury or the projector may become damaged.
- Do not block the light coming out of the projector lens when in operation. The light will heat the object and could melt, cause burns or start a fire.
- Please do not open or disassemble the projector as this may cause electric shock.
- Do not attempt to service the unit yourself. Opening or removing covers may expose you to dangerous voltages or other hazards. Please call Optoma before you send the unit for repair.
- See projector enclosure for safety related markings.
- The unit should only be repaired by appropriate service personnel.
- Only use attachments/accessories specified by the manufacturer.

- Do not look straight into the projector lens during operation. The bright light may harm your eyes.
- When switching the projector off, please ensure the cooling cycle has been completed before disconnecting power. Allow 90 seconds for the projector to cool down.
- Turn off and unplug the power plug from the AC outlet before cleaning the product.
- Use a soft dry cloth with mild detergent to clean the display housing. Do not use abrasive cleaners, waxes or solvents to clean the unit.
- Disconnect the power plug from AC outlet if the product is not being used for a long period of time.
- Do not setup the projector in places where it might be subjected to vibration or shock.
- Do not touch the lens with bare hands.
- Remove battery/batteries from remote control before storage. If the battery/batteries are left in the remote for long periods, they may leak.
- Do not use or store the projector in places where smoke from oil or cigarettes may be present, as it can adversely affect the quality of the projector performance.
- Please follow the correct projector orientation installation as non standard installation may affect the projector performance.
- Use a power strip and or surge protector. As power outages and brown-outs can KILL devices.

3D Safety Information

Please follow all warnings and precautions as recommended before you or your child use the 3D function.

Warning

Children and teenagers may be more susceptible to health issues associated with viewing in 3D and should be closely supervised when viewing these images.

Photosensitive Seizure Warning and Other Health Risks

- Some viewers may experience an epileptic seizure or stroke when exposed to certain flashing images or lights contained in certain Projector pictures or video games. If you suffer from, or have a family history of epilepsy or strokes, please consult with a medical specialist before using the 3D function.
- Even those without a personal or family history of epilepsy or stroke may have an undiagnosed condition that can cause photosensitive epileptic seizures.
- Pregnant women, the elderly, sufferers of serious medical conditions, those who are sleep deprived or under the influence of alcohol should avoid utilizing the unit's 3D functionality.
- If you experience any of the following symptoms, stop viewing 3D pictures immediately and consult a medical specialist: (1) altered vision; (2) light-headedness; (3) dizziness; (4) involuntary movements such as eye or muscle twitching; (5) confusion; (6) nausea; (7) loss of awareness; (8) convulsions; (9) cramps; and/ or (10) disorientation. Children and teenagers may be more likely than adults to experience these symptoms. Parents should monitor their children and ask whether they are experiencing these symptoms.
- Watching 3D projection may also cause motion sickness, perceptual after effects, disorientation, eye strain and decreased postural stability. It is recommended that users take frequent breaks to lessen the potential of these effects. If your eyes show signs of fatigue or dryness or if you have any of the above symptoms, immediately discontinue use of this device and do not resume using it for at least thirty minutes after the symptoms have subsided.
- Watching 3D projection while sitting too close to the screen for an extended period of time may damage your eyesight. The ideal viewing distance should be at least three times the screen height. It is recommended that the viewer's eyes are level with the screen.
- Watching 3D projection while wearing 3D glasses for an extended period of time may cause a headache or fatigue. If you experience a headache, fatigue or dizziness, stop viewing the 3D projection and rest.
- Do not use the 3D glasses for any other purpose than for watching 3D projection.
- Wearing the 3D glasses for any other purpose (as general spectacles, sunglasses, protective goggles, etc.) may be physically harmful to you and may weaken your eyesight.

- Viewing in 3D projection may cause disorientation for some viewers. Accordingly, DO NOT place your 3D PROJECTOR near open stairwells, cables, balconies, or other objects that can be tripped over, run into, knocked down, broken or fallen over.

Copyright

This publication, including all photographs, illustrations and software, is protected under international copyright laws, with all rights reserved. Neither this manual, nor any of the material contained herein, may be reproduced without written consent of the author.

© Copyright 2018

Disclaimer

The information in this document is subject to change without notice. The manufacturer makes no representations or warranties with respect to the contents hereof and specifically disclaims any implied warranties of merchantability or fitness for any particular purpose. The manufacturer reserves the right to revise this publication and to make changes from time to time in the content hereof without obligation of the manufacturer to notify any person of such revision or changes.

Trademark Recognition

Kensington is a U.S. registered trademark of ACCO Brand Corporation with issued registrations and pending applications in other countries throughout the world.

HDMI, the HDMI Logo, and High-Definition Multimedia Interface are trademarks or registered trademarks of HDMI Licensing LLC in the United States and other countries.

DLP®, DLP Link and the DLP logo are registered trademarks of Texas Instruments and BrilliantColor™ is a trademark of Texas Instruments.



Manufactured under license from Dolby Laboratories.

Dolby, Dolby Audio and the double-D symbol are trademarks of Dolby Laboratories.

Amazon, Alexa and all related logos are trademarks of Amazon.com, Inc. or its affiliates.

All other product names used in this manual are the properties of their respective owners and are Acknowledged.

FCC

This device has been tested and found to comply with the limits for a Class B digital device pursuant to Part 15 of the FCC rules. These limits are designed to provide reasonable protection against harmful interference in a residential installation. This device generates, uses and can radiate radio frequency energy and, if not installed and used in accordance with the instructions, may cause harmful interference to radio communications.

However, there is no guarantee that interference will not occur in a particular installation. If this device does cause harmful interference to radio or television reception, which can be determined by turning the device off and on is encouraged to try to correct the interference by one or more of the following measures:

- Reorient or relocate the receiving antenna.
- Increase the separation between the device and receiver.
- Connect the device into an outlet on a circuit different from that to which the receiver is connected.
- Consult the dealer or an experienced radio/television technician for help.

Notice: Shielded cables

All connections to other computing devices must be made using shielded cables to maintain compliance with FCC regulations.

Caution

Changes or modifications not expressly approved by the manufacturer could void the user's authority, which is granted by the Federal Communications Commission, to operate this projector.

Operation Conditions

This device complies with Part 15 of the FCC Rules. Operation is subject to the following two conditions:

1. This device may not cause harmful interference and
2. This device must accept any interference received, including interference that may cause undesired operation.

Notice: Canadian users

This Class B digital apparatus complies with Canadian ICES-003.

Remarque à l'intention des utilisateurs canadiens

Cet appareil numérique de la classe B est conforme à la norme NMB-003 du Canada.

Declaration of Conformity for EU countries

- EMC Directive 2014/30/EC (including amendments)
- Low Voltage Directive 2014/35/EC
- R & TTE Directive 1999/5/EC (if product has RF function)

WEEE



Disposal instructions

Do not throw this electronic device into the trash when discarding. To minimize pollution and ensure utmost protection of the global environment, please recycle it.

INTRODUCTION

Package Overview

Carefully unpack and verify that you have the items listed below under standard accessories. Some of the items under optional accessories may not be available depending on the model, specification and your region of purchase. Please check with your place of purchase. Some accessories may vary from region to region.

The warranty card is only supplied in some specific regions. Please consult your dealer for detailed information.

Standard accessories

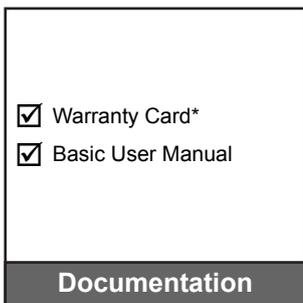
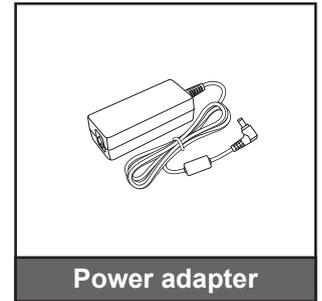
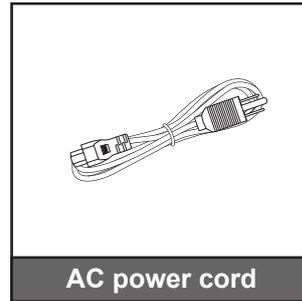

Note:

- The remote control is shipped with the battery.
- The actual remote control may vary depending on the region.
- * For European warranty information, please visit www.optoma.com.

Optional accessories

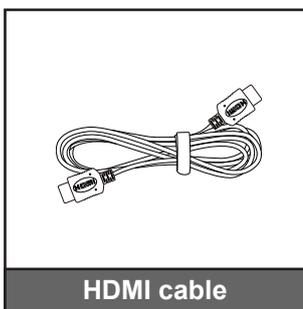

Note: Optional accessories vary depending on model, specification and region.

INTRODUCTION

Product Overview

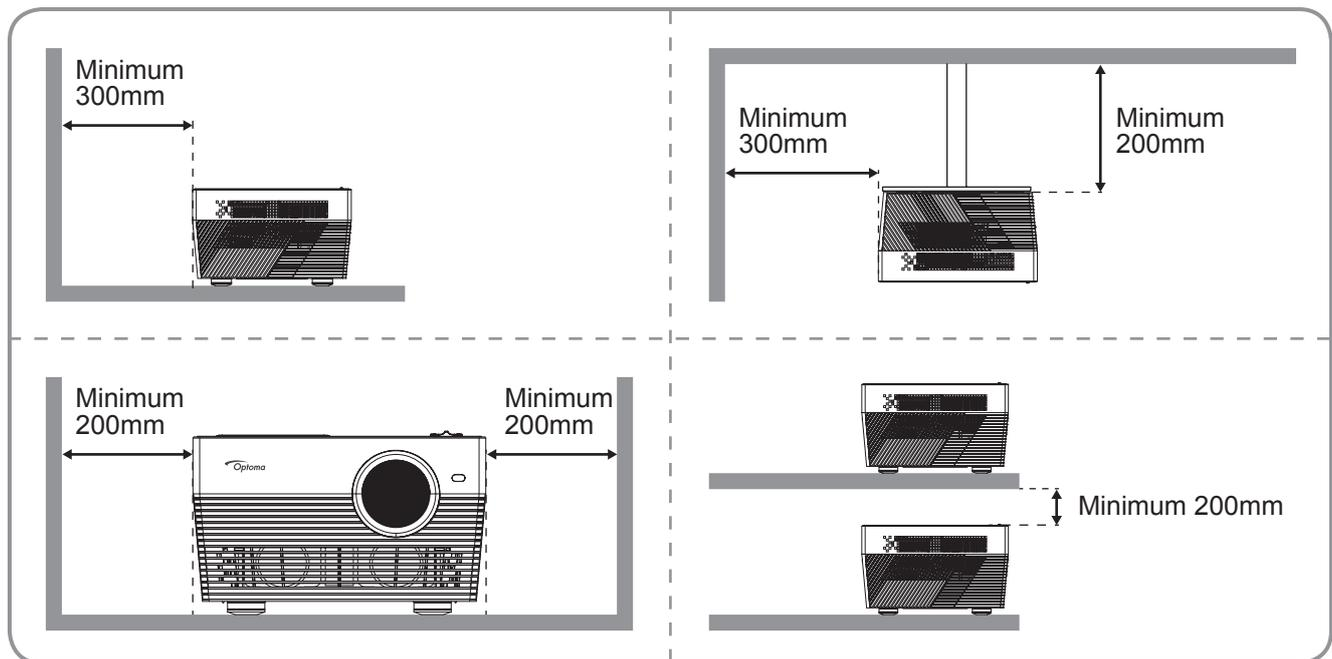
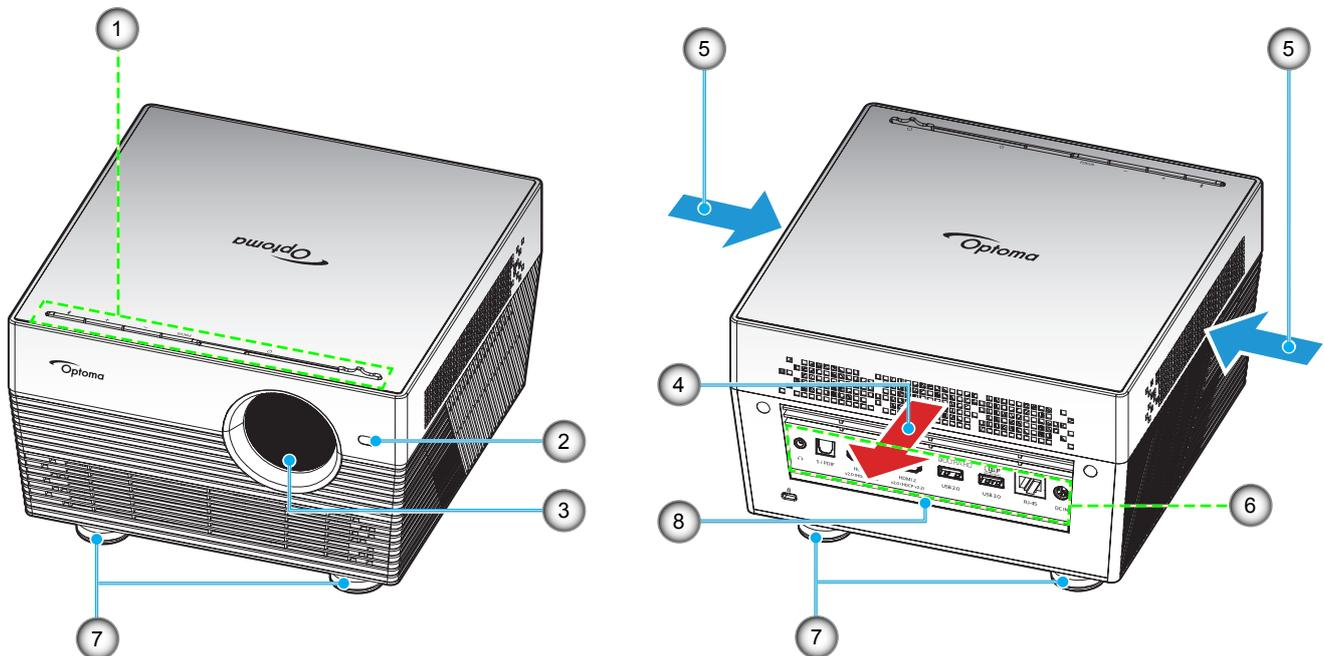

Note:

- Do not block projector intake and exhaust vents.
- When operating the projector in an enclosed space, allow at least 20cm clearance around the intake and exhaust vents.

No	Item	No	Item
1.	Keypad	5.	Ventilation (inlet)
2.	Auto Focus Sensor	6.	Input / Output
3.	Lens	7.	Tilt-Adjustment Foot
4.	Ventilation (outlet)	8.	IR Receiver

INTRODUCTION

Connections

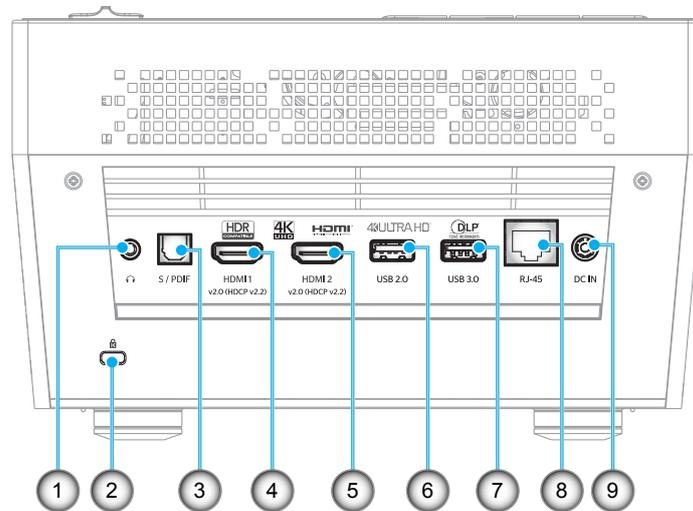

No	Item	No	Item
1.	Headphone Connector	6.	USB2.0 Connector (Power 5V 1A)
2.	Kensington™ Lock Port	7.	USB3.0 Connector (Power 5V 1.5A)
3.	S/PDIF Connector	8.	RJ-45 Connector
4.	HDMI 1 Connector	9.	DC IN Connector
5.	HDMI 2 Connector		

Keypad

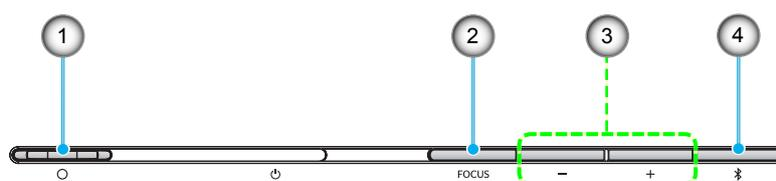

No	Item	No	Item
1.	Lens Cover Lever (Door Opened / Door Closed)	3.	Volume Adjustment / Manual Focus Adjustment / Media Selection
2.	Focus (Short press: Manual Focus; Long press: Auto Focus)	4.	Audio Mode / Power on/off / LED status

INTRODUCTION

IR remote control

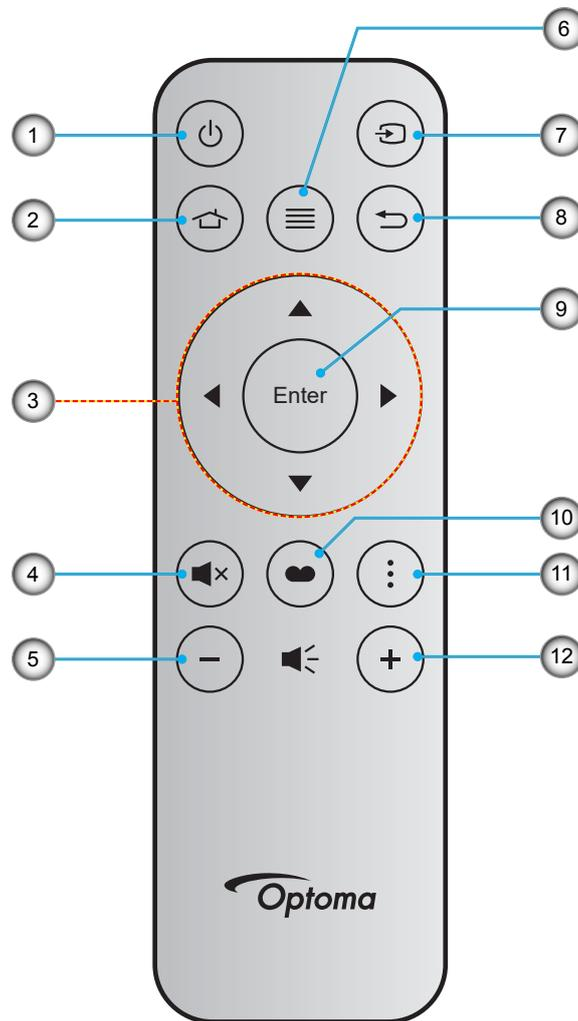

No	Item	No	Item
1.	Power On / Off	7.	Source
2.	Home	8.	Return
3.	Four Directional Select Keys	9.	Enter
4.	Mute	10.	Display Mode
5.	Volume -	11.	Option
6.	Menu	12.	Volume +

INTRODUCTION

Bluetooth remote control

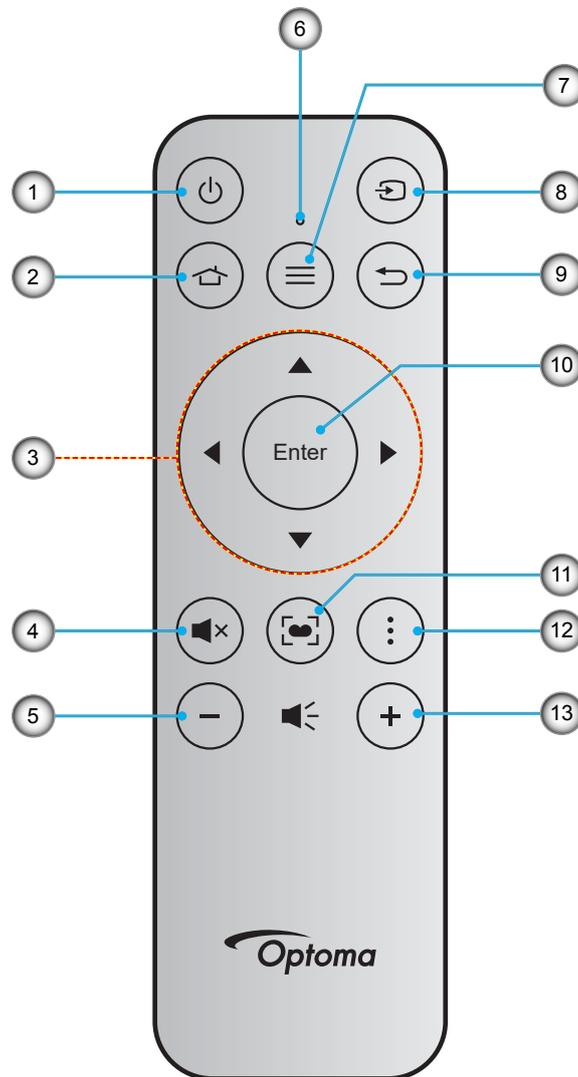

No	Item	No	Item
1.	Power On / Off	8.	Source
2.	Home	9.	Return
3.	Four Directional Select Keys	10.	Enter
4.	Mute	11.	Display Mode (Short press: Display Mode; Long press: Auto Focus)
5.	Volume -	12.	Option
6.	Status LED	13.	Volume +
7.	Menu		

INTRODUCTION

Pairing your Bluetooth remote control with the projector

Press the  and  buttons simultaneously for 2 seconds. The status LED on the Bluetooth remote control will flash, indicating the device is in pairing mode.

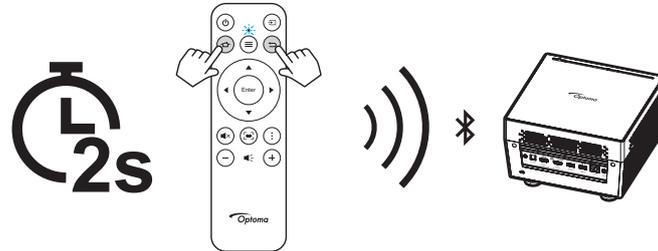

The pairing process will take approximately 20 seconds. If the pairing is successful, the status LED on the Bluetooth remote control will turn solid blue. Otherwise, the status LED on the Bluetooth remote control will turn solid red.

If the Bluetooth remote control is left idle for 10 minutes, it will automatically enter Sleep mode and the Bluetooth is disconnected.

Note:

- *The actual remote control may vary depending on the region.*
- *Some keys may have no function for models that do not support these features.*
- *Before using the remote control for the first time, remove the transparent insulation tape. See page 18 for battery installation.*

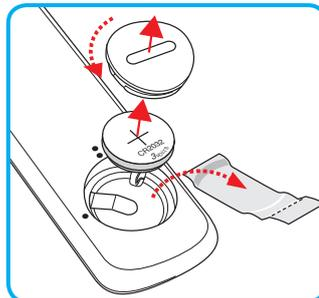

SETUP AND INSTALLATION

Installing the projector

Your projector is designed to be installed in one of four possible positions.

Your room layout or personal preference will dictate which installation location you select. Take into consideration the size and position of your screen, the location of a suitable power outlet, as well as the location and distance between the projector and the rest of your equipment.

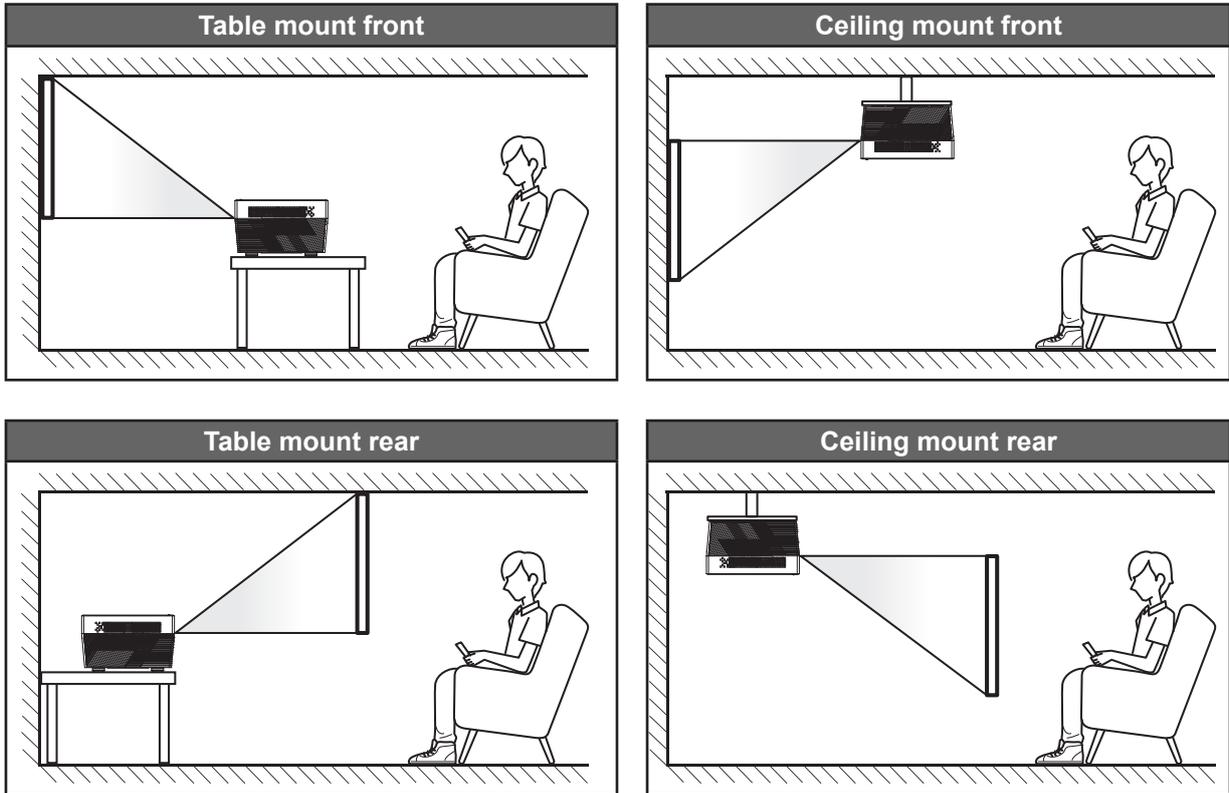

Projector should be placed flat on a surface and 90 degrees / perpendicular to the screen.

- How to determine projector location for a given screen size, please refer to distance table on page 60.
- How to determine screen size for a given distance, please refer to distance table on page 60.

Note: *The further away the projector is placed from the screen the projected image size increases and vertical offset also increases proportionally.*

IMPORTANT!

Do not operate the projector in any orientation other than table top or ceiling mount. The projector should be horizontal and not tilted either forwards/backwards or left/right. Any other orientation will invalidate the warranty and may shorten the lifetime of the projector itself. For non standard installation advise please contact Optoma.

SETUP AND INSTALLATION

Connecting sources to the projector

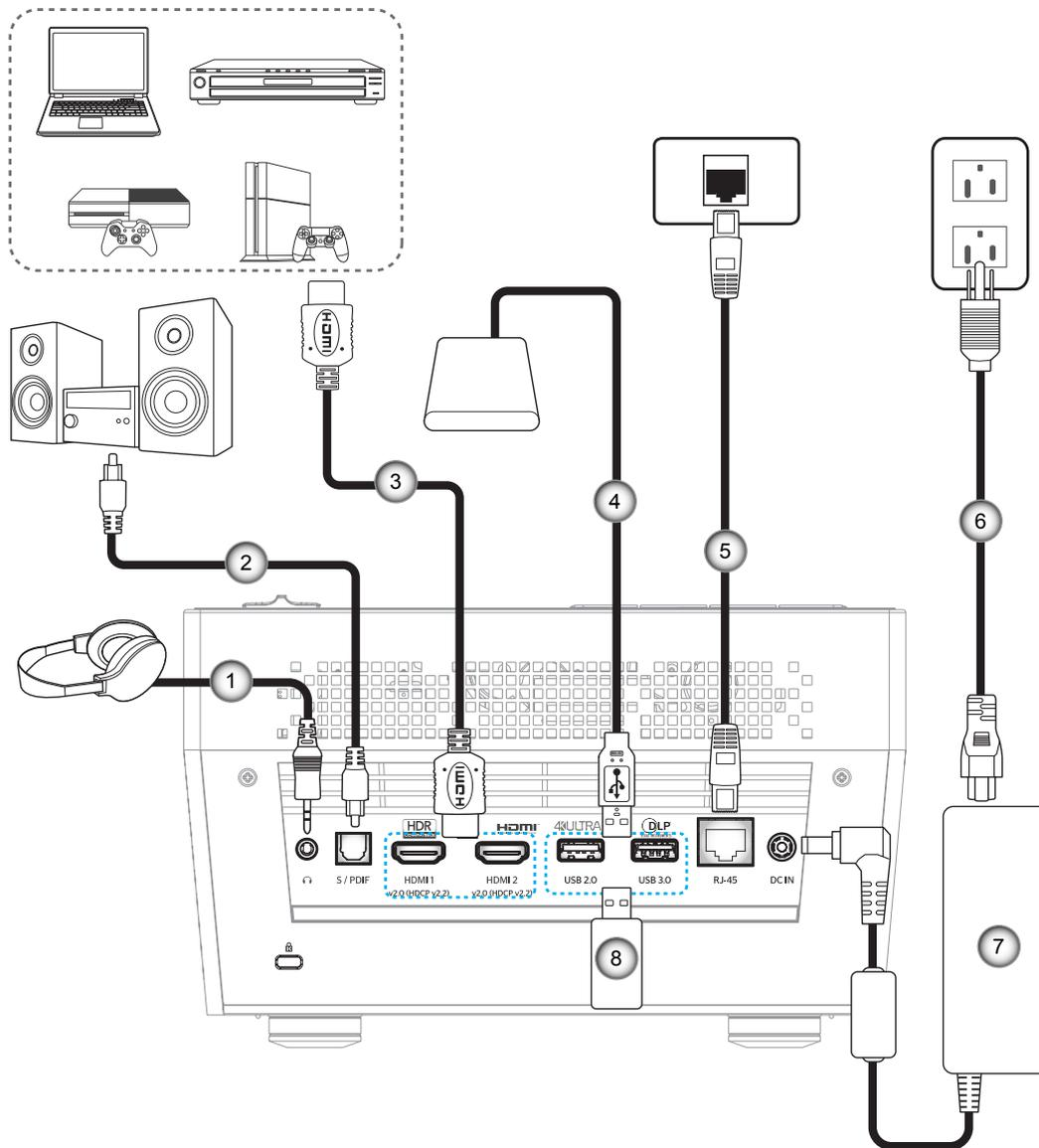

No	Item
1.	Audio Out Cable
2.	S/PDIF Out Cable
3.	HDMI Cable

No	Item
4.	USB Cable
5.	RJ-45 Cable
6.	Power Cord

No	Item
7.	Power Adapter
8.	USB Flash Drive

Note: You can connect a USB mouse or keyboard to the USB port.

SETUP AND INSTALLATION

Adjusting the projector image

Image height

The projector is equipped with elevator feet for adjusting the image height.

1. Locate the adjustable foot you wish to adjust on the underside of the projector.
2. Rotate the adjustable foot clockwise or counterclockwise to raise or lower the projector.

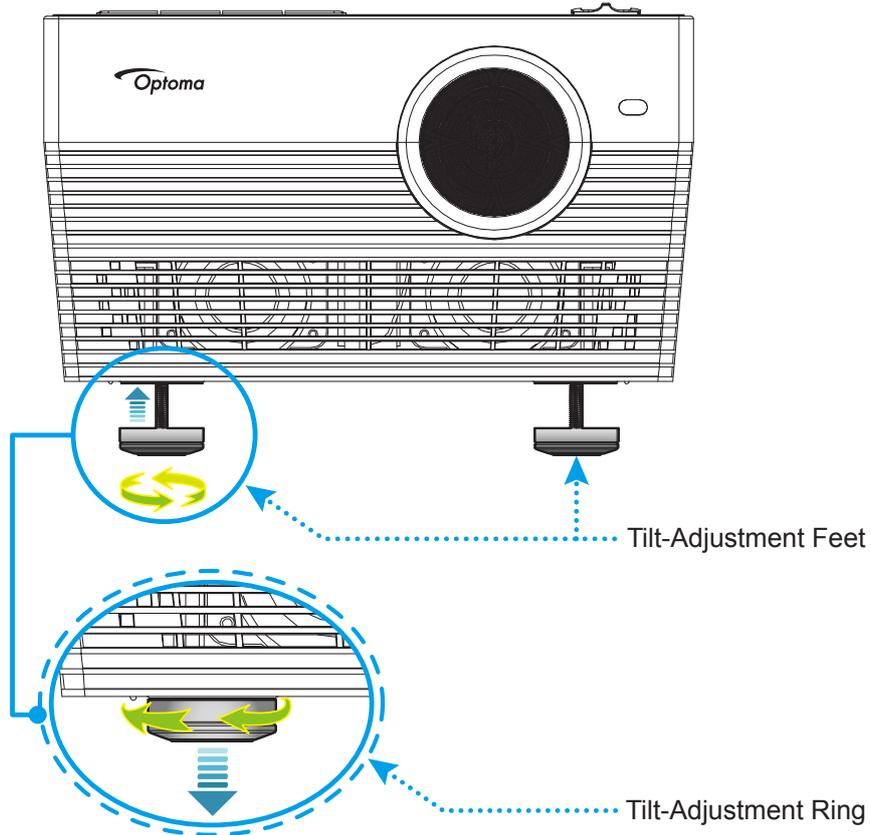

SETUP AND INSTALLATION

Focus

To adjust the focus, do one of the following:

- Press and hold the “FOCUS” button to allow the projector automatically adjust the focus.
- Press the “FOCUS” button, and then press the “+” or “-” button to manually adjust the focus until the image is sharp and legible.

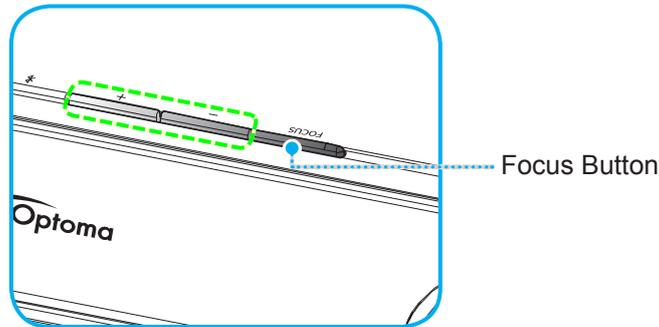

- If you are using the Bluetooth remote control, press and hold the [●] button to perform the automatic focus adjustment.

Note:

- *The Auto Focus range is between 0.8m~2m ±10%. If the projection distance is not within the specified range, you have to perform the manual focus adjustment to focus the projected image.*
- *To use the Bluetooth remote control to adjust the focus, make sure you have successfully paired the Bluetooth remote control with the projector and the connection remained active.*

SETUP AND INSTALLATION

Remote setup

Installing / replacing the battery

1. Use a coin to turn the battery cover counterclockwise until the cover opens.
2. Install new battery into the compartment.
Remove the old battery and install new one (CR2032). Ensure that the side with a "+" is facing up.
3. Put the cover back. Then use a coin to turn the battery cover clockwise to lock it in place.

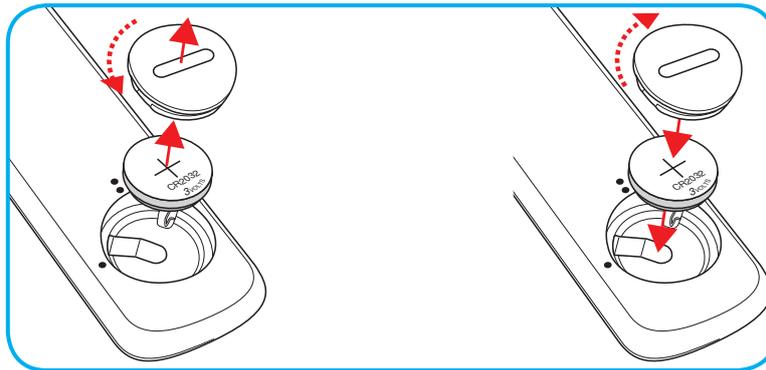

CAUTION:

To ensure safe operation, please observe the following precautions:

- Use CR2032 type battery.
- Avoid contact with water or liquid.
- Do not expose the remote control to moisture or heat.
- Do not drop the remote control.
- If the battery has leaked in the remote control, carefully wipe the case clean and install new battery.
- Risk of an explosion if battery is replaced by an incorrect type.
- Dispose of used battery according to the instructions.

SETUP AND INSTALLATION

Effective range

Infra-Red (IR) remote control sensor is located on the rear of the projector. Ensure to hold the remote control at an angle within 30° (horizontally) or 20° (vertically) perpendicular to the projector's IR remote control sensor to function correctly. The distance between the remote control and the sensor should not be longer than 7 meters (~22 feet).

You can also operate the remote control by pointing it to the projected image.

Note: When pointing the remote control directly (0 degrees angle) on the IR sensor, the distance between the remote control and the sensor should not be longer than 10 meters (~32 feet).

- Make sure that there are no obstacles between the remote control and the IR sensor on the projector that might obstruct the infra-red beam.
- Make sure the IR transmitter of the remote control is not being shined by sunlight or fluorescent lamps directly.
- Please keep the remote controller away from fluorescent lamps for over 2 meters or the remote controller might become malfunction.
- If the remote control is close to Inverter-Type fluorescent lamps, it might become ineffective from time to time.
- If the remote control and the projector are within a very short distance, the remote control might become ineffective.
- When you aim at the screen, the effective distance is less than 7 meters from the remote control to the screen and reflecting the IR beams back to the projector. However, the effective range might change according to screens.

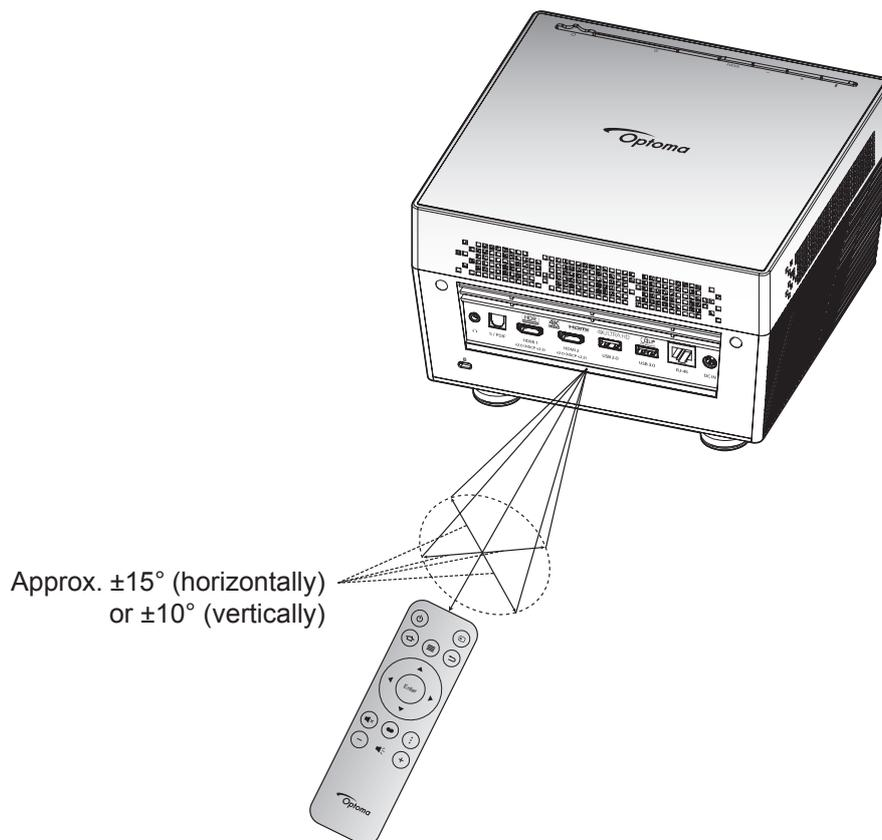

USING THE PROJECTOR

Powering on / off the projector

Powering on

1. Connect one end of the AC power cord to the power adapter. Then connect the power adapter to the DC IN connector on the projector.
2. Connect the other end of the AC power cord to the electrical outlet. When connected, the status LED will turn red.
3. Turn on the projector by one of the following methods:
 - If the lens door is closed, slide the lens cover lever to the  side.
 - If the lens door is open, press the  button to turn it on.

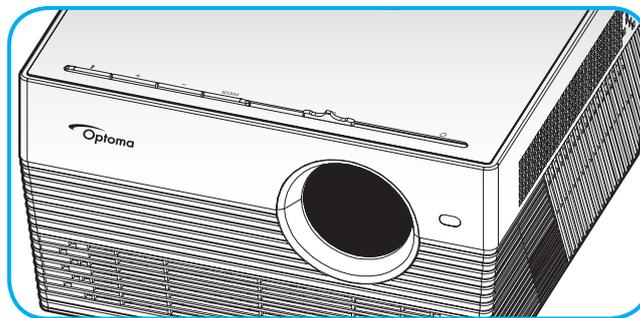

During startup, the status LED will flash green. When the status LED turns solid white, this indicates the projector is ready to use.

The first time the projector is turned on, you will be prompted to do the initial setup including selecting the preferred language, projection orientation, and power mode settings. Once the **Complete set** screen appears, this indicates the projector is ready to use.

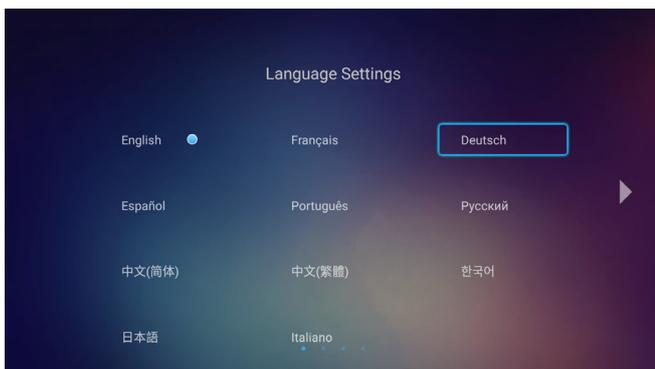

[Select Language]

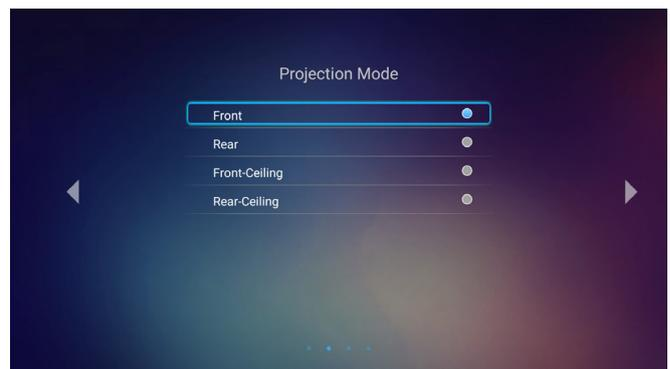

[Select Projection Mode]

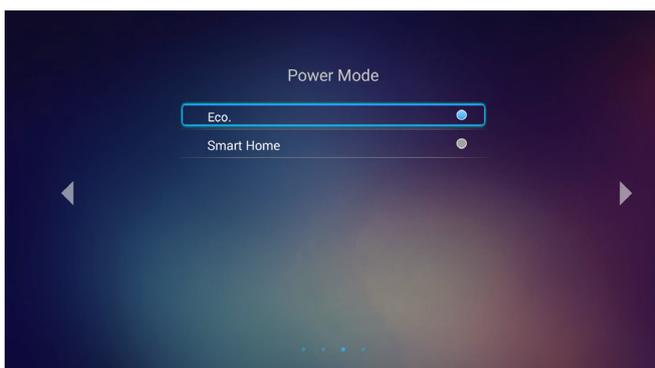

[Select Power Mode]

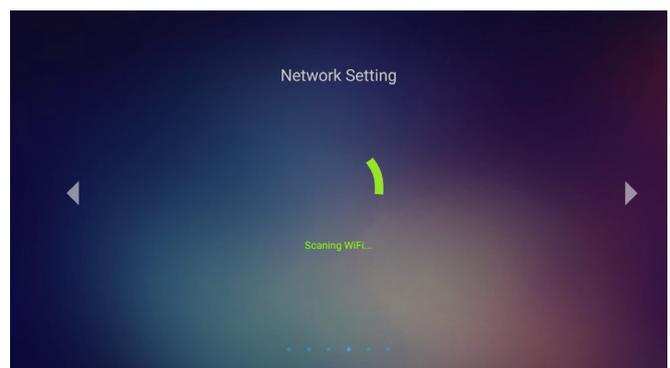

[Scanning Wi-Fi]

USING THE PROJECTOR

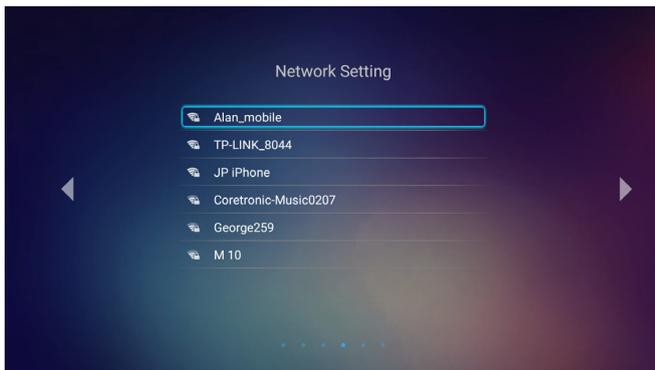

[Select Wi-Fi]

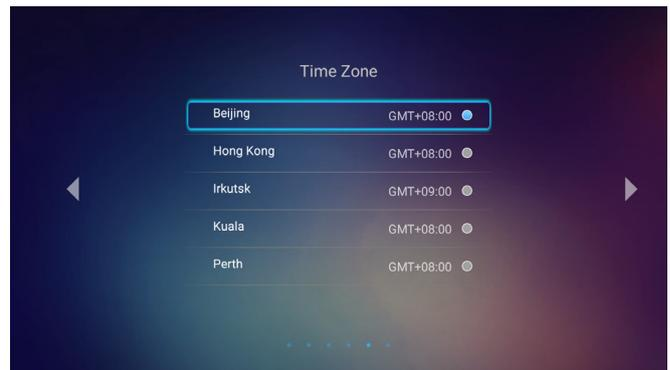

[Select Time Zone]

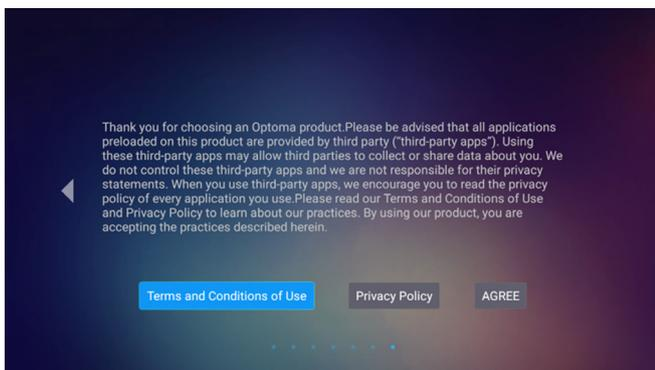

[Select Terms and Conditions of Use]

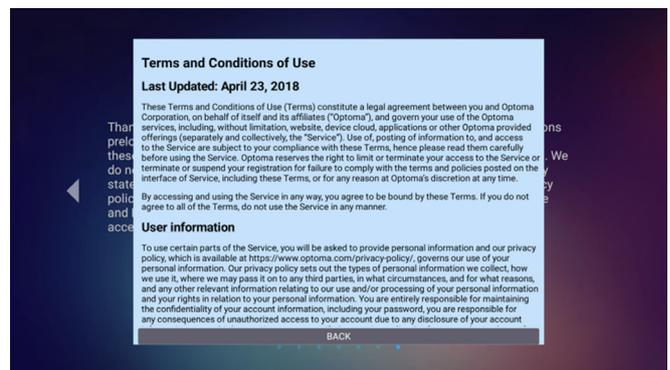

[Terms and Conditions of Use screen]

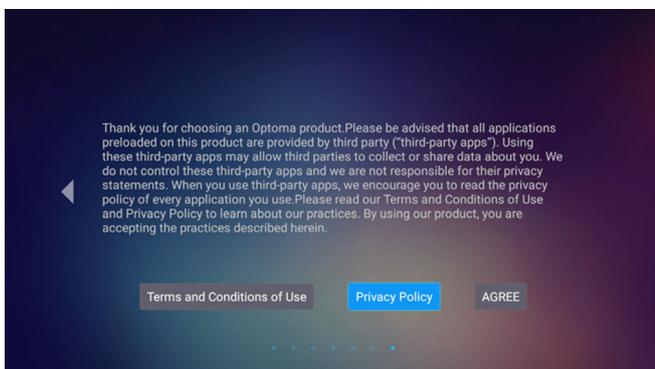

[Select Privacy Policy]

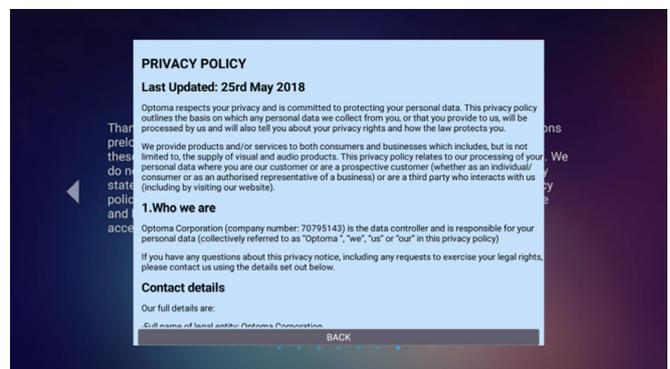

[Privacy Policy screen]

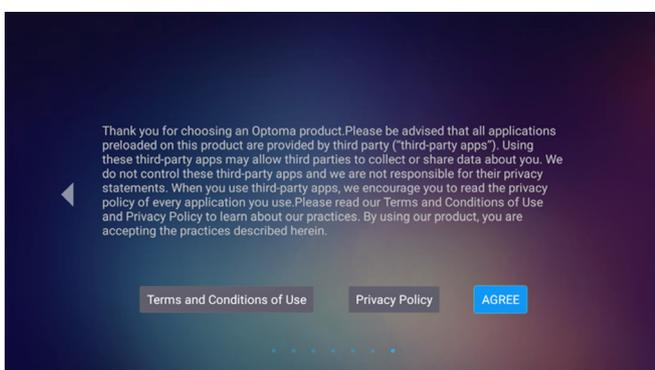

[Select AGREE]

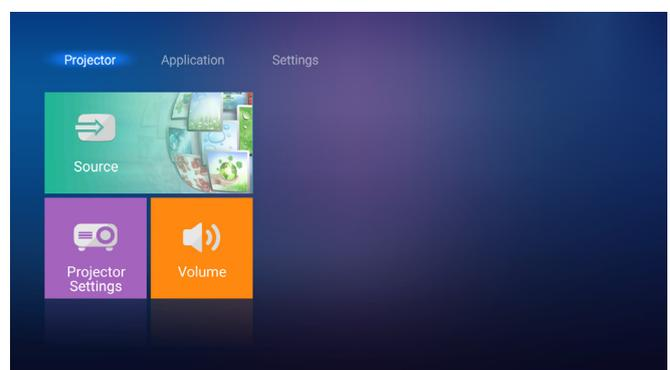

[Home screen]

USING THE PROJECTOR

Powering off

1. Turn off the projector by pressing the “” button on the projector keypad or the “” button on the remote control. The following message will be displayed:

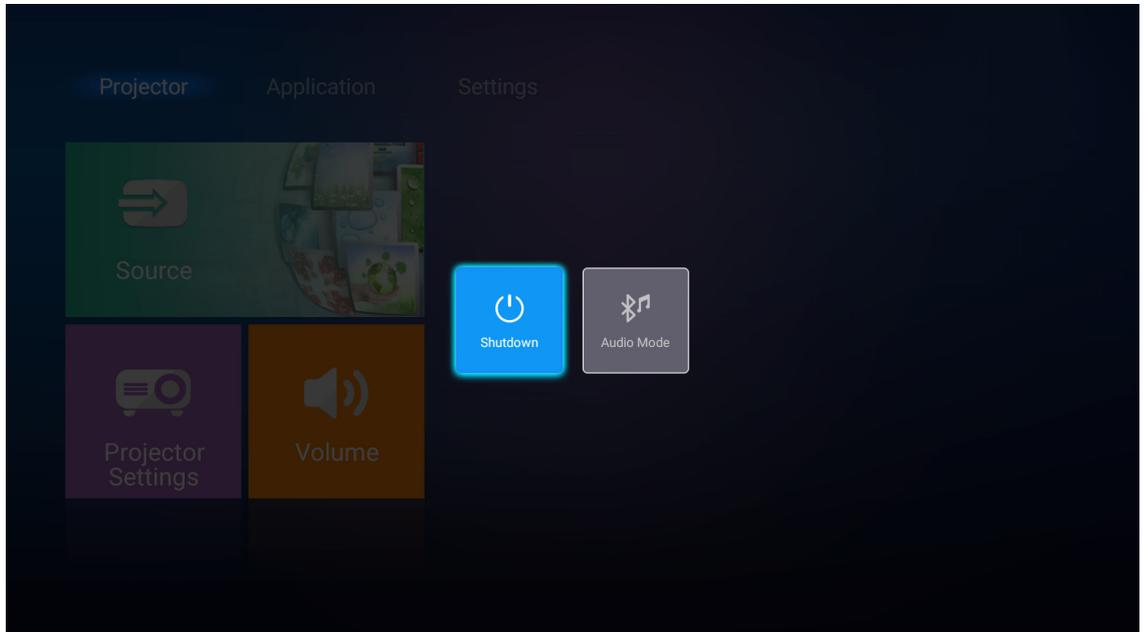

2. Press the “+”/“−” button on the projector keypad or the “◀”/“▶” button on the remote control to select **Shutdown**. Then pressing the “” button on the projector keypad or the **Enter** button on the remote control to confirm.
3. The cooling fans will continue to operate for about 10 seconds for the cooling cycle and the status LED will flash white. When the status LED turns solid red, this indicates the projector has entered standby mode. If you wish to turn the projector back on, you must wait until the cooling cycle has finished and the projector has entered standby mode. When the projector is in standby mode, simply press the “”/“” button again to turn on the projector.
4. Disconnect the power adapter from the projector and the AC power cord from the electrical outlet.

Note: *It is not recommended that the projector is turned on immediately, right after a power off procedure.*

USING THE PROJECTOR

Selecting an input source

Turn on the connected source that you want to display on the screen, such as computer, notebook, video player, etc. The projector will automatically detect the source. If multiple sources are connected, press the “↵” button on the remote control to select the desired input.

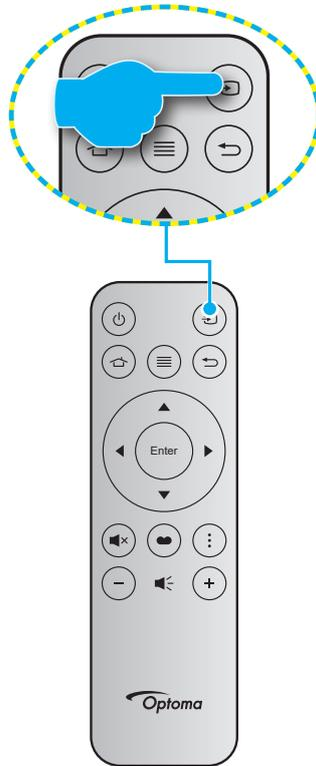

USING THE PROJECTOR

Using the projector as wireless speaker

With the built-in Bluetooth module, you can listen to your music wirelessly from your phone, tablet PC, or other Bluetooth-enabled device.

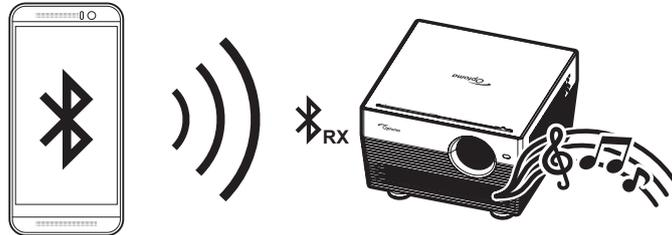

Switching to audio mode

You can switch to Audio mode by one of the following methods:

Status	Method 1	Method 2
Door Open (the lens cover lever position is at the ⏻ side)	<ul style="list-style-type: none"> If the projector is turned on, press the “⌘” button on the projector keypad to turn off the projector. When the confirmation message appears, select Audio Mode. 	<ul style="list-style-type: none"> If the projector is turned off, press the “⌘” button on the projector keypad or the “⏻” button on the remote control. Then press the “⌘” button again to turn off the projector. When the confirmation message appears, select Audio Mode.
Door Close (the lens cover lever position is at the ○ side)	<ul style="list-style-type: none"> Press the “⌘” button on the projector keypad. 	<ul style="list-style-type: none"> Press the “⏻” button on the remote control.

USING THE PROJECTOR

Pairing your Bluetooth device with the projector

1. Set the projector to Audio mode. Refer to the “Switching to audio mode” section on page 24.
On the projector, the status LED (alternating blue LED and red LED) will flash, indicating the device is in pairing mode.
2. On your Bluetooth device, tap **Settings** and enable the Bluetooth function. Then search for the projector.

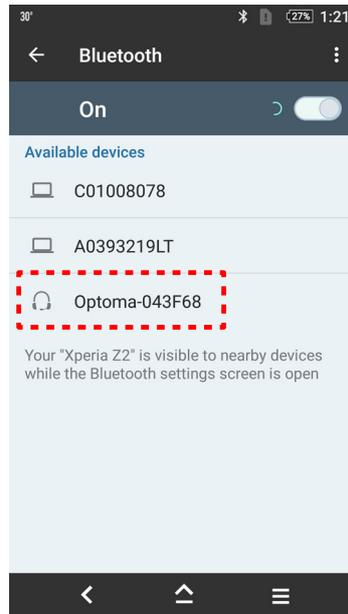

3. Tap the projector you want to connect and start pairing.
4. The projector will play an audible tone and the status LED will turn solid blue to indicate the pairing is successful and devices are connected.
5. On your Bluetooth device, browse and select the song to play.
You can use the “+”/“−” button on the projector keypad to adjust the volume level.

Note:

- *The projector can store pairing information of up to ten devices. However, only one Bluetooth device can be connected at a time.*
- *Make sure the distance between your Bluetooth device and the projector is less than 10 meters.*

USING THE PROJECTOR

Home screen overview

The Home screen is displayed every time you start the projector. From the main Home screen, it basically divided into 3 main categories: Projector, Application, and Settings.

To navigate the Home screen, simply use the buttons on the remote control or the projector keypad.

You can return to the main Home screen at any time by pressing the  button on the remote control, regardless of what page you are on.

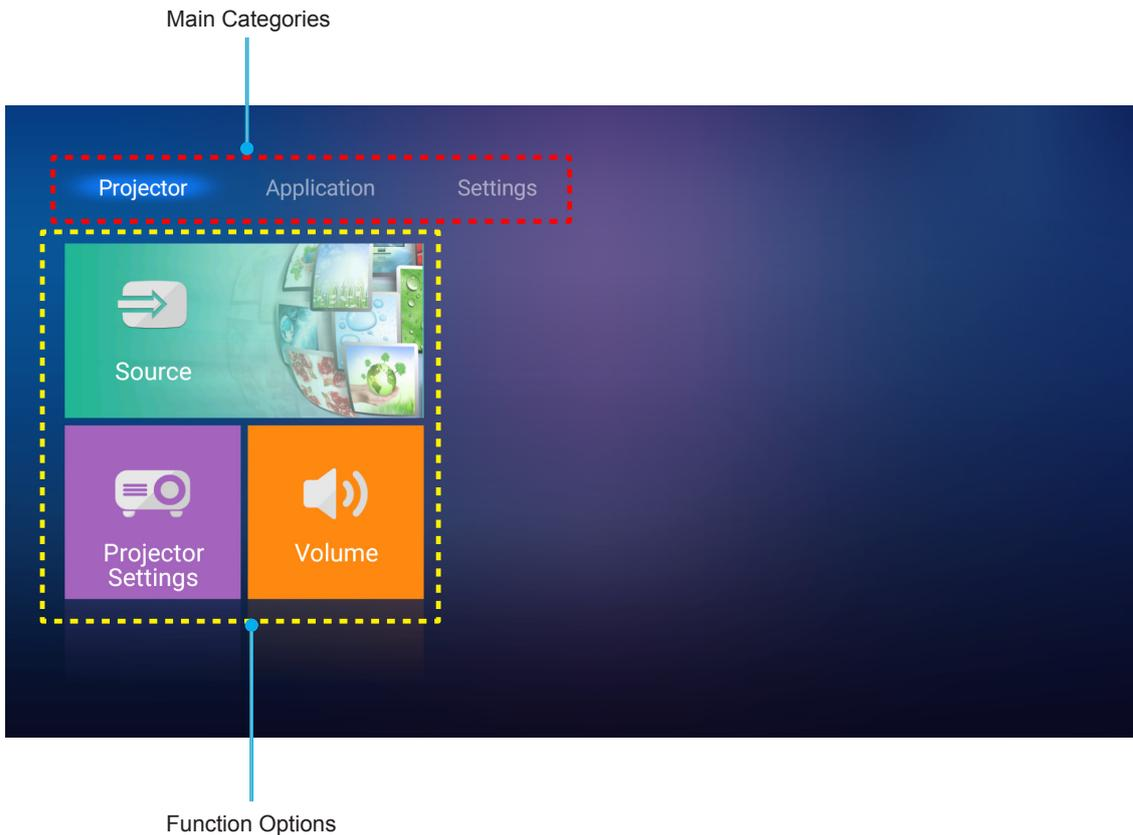

USING THE PROJECTOR

Projector settings

On the **Projector** home screen, you can change the input source, configure the projector settings, and adjust the volume level.

Selecting an input source

Besides pressing the “” button on the remote control to select the desired input, you can also change the input source by selecting **Source** option. Then press **Enter** on the remote control to enter the **Source** menu.

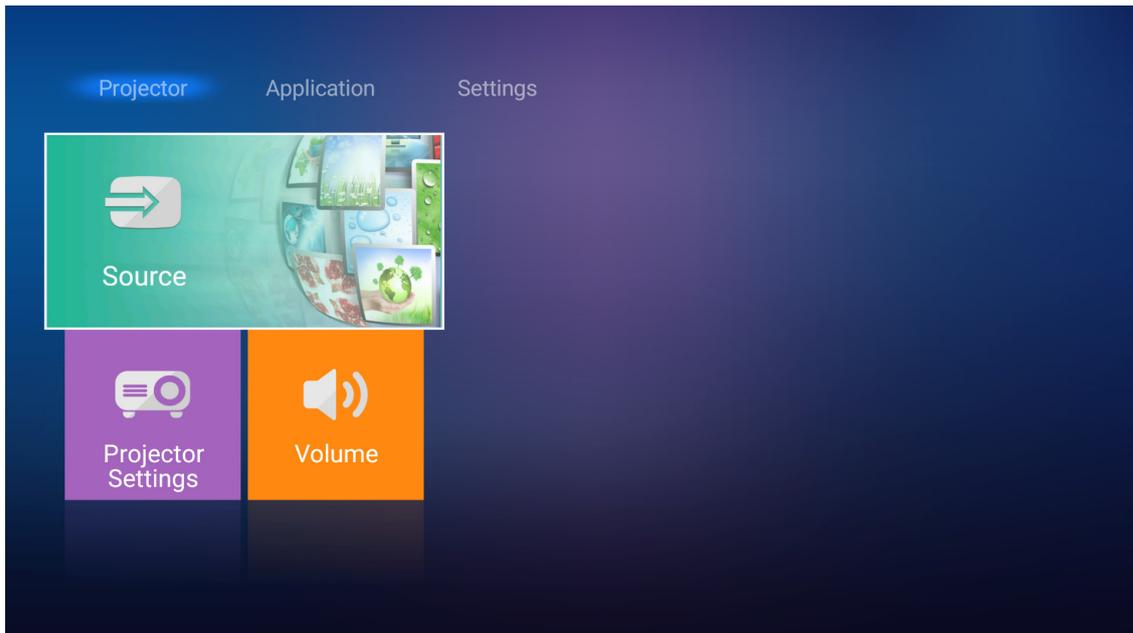

The available input source options appear on the screen.

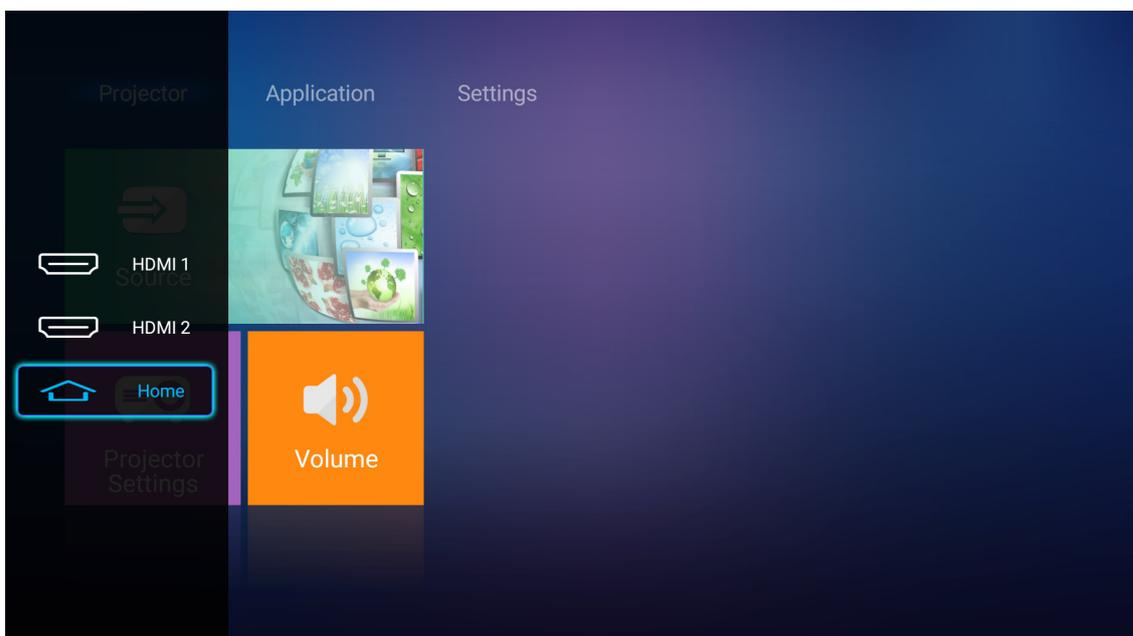

Select the desired input source and press **Enter** on the remote control to confirm the selection.

Note: By default, the input source is set to **Home**.

USING THE PROJECTOR

Configure the projector settings

Select **Projector Settings** to manage various device configurations including configuring the device settings, viewing the system information, and restore the system settings.

Note: Unless otherwise specified, this section describes the device operations using the IR remote control.

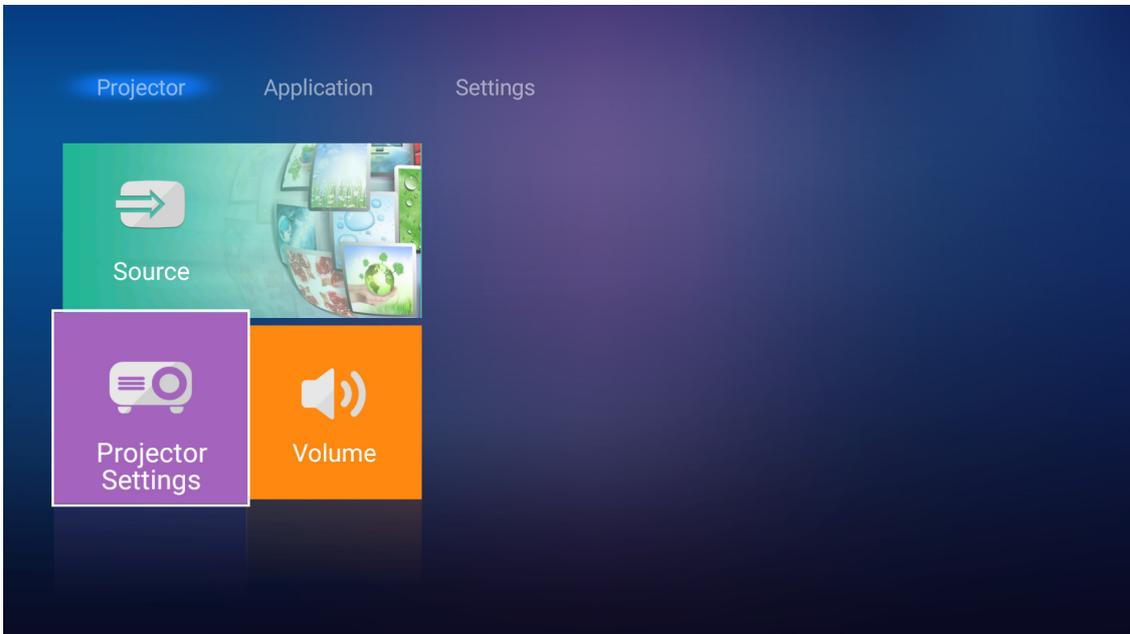

General menu navigation

1. Press **Enter** on the remote control to enter the **Projector Settings** menu.

Note: You can also directly access the **Projector Settings** menu by pressing  on the remote control.

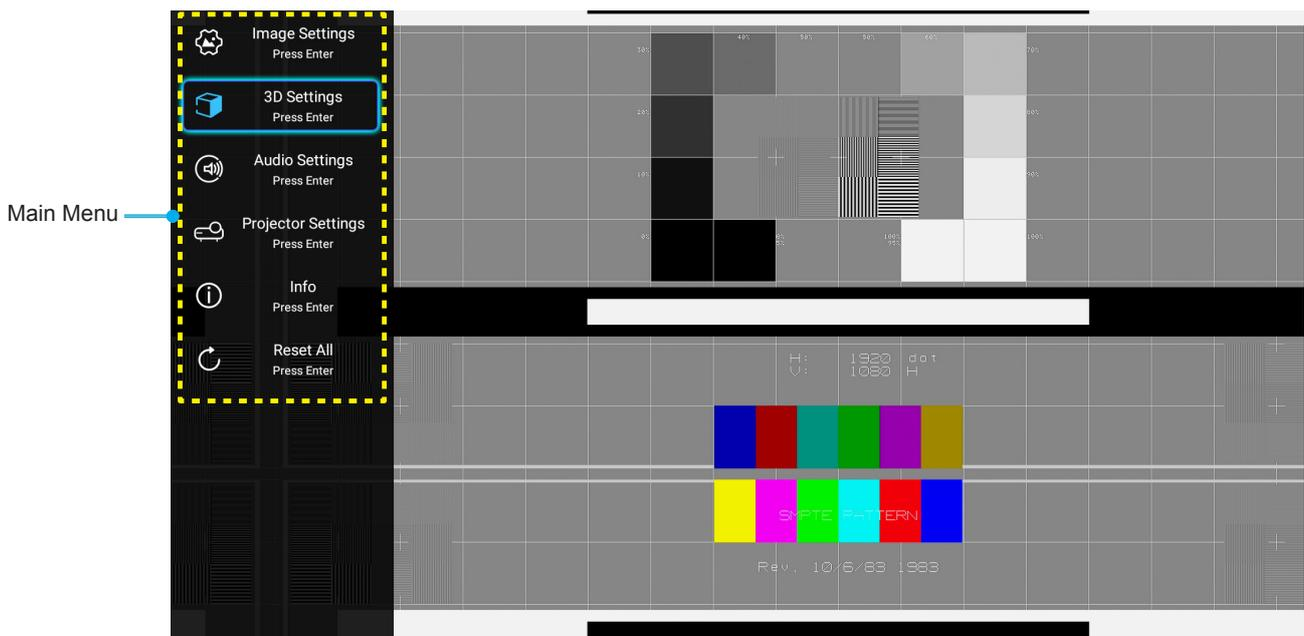

2. When OSD is displayed, use **▲▼** keys to select any item in the main menu. While making a selection on a particular page, press **Enter** on the remote control to enter submenu.
3. Use **▲▼** keys to select the desired item in the sub menu and then press **Enter** to view further settings. Adjust the settings by using **◀▶** keys.

USING THE PROJECTOR

4. Select the next item to be adjusted in the sub menu and adjust as described above.
5. To exit, press  again. The OSD menu will close and the projector will automatically save the new settings.

OSD Menu tree

Level 1	Level 2	Level 3	Level 4	Value	
Image Settings	Display Mode			Cinema	
				HDR	
				HDR SIM.	
				Game	
				Reference	
				Bright	
				User	
				3D	
				ISF Day	
				ISF Night	
	Dynamic Range	HDR			Auto [Default]
					Off
		HDR Picture Mode			Bright
					Standard [Default]
					Film
					Detail
	Brightness			-50 ~ +50	
	Contrast			-50 ~ +50	
	Sharpness			1 ~ 15	
	Color			-50 ~ +50	
	Tint			-50 ~ +50	
	Gamma [Not 3D Mode]				Film
					Video
					Graphics
					Standard(2.2)
					1.8
					2.0
	Gamma [3D Mode]				2.4
					3D
					Standard
	Color Settings	Color Temp.			Cool
					Cold
					Auto [Default]
Color Space					RGB(0~255)
					RGB(16~235)
					YUV(0~255)
					YUV(16~235)
					YUV(16~235)

USING THE PROJECTOR

Level 1	Level 2	Level 3	Level 4	Value	
Image Settings	Color Settings	Color Matching		Red [Default]	
				Green	
				Blue	
				Cyan	
				Yellow	
				Magenta	
				White	
			Hue or Red Gain	-100 ~ +100 [Default:0]	
			Saturation or Green Gain	-100 ~ +100 [Default:0]	
			Gain or Blue Gain	-100 ~ +100 [Default:0]	
			RGB Gain / Bias	Red Gain	-50 ~ +50 [Default:0]
				Green Gain	-50 ~ +50 [Default:0]
				Blue Gain	-50 ~ +50 [Default:0]
		Red Bias		-50 ~ +50 [Default:0]	
		Green Bias		-50 ~ +50 [Default:0]	
		Blue Bias		-50 ~ +50 [Default:0]	
		Brightness Mode		DynamicBlack 1	
				DynamicBlack 2	
				DynamicBlack 3	
				100%	
				95%	
				90%	
				85%	
				80%	
				75%	
				70%	
				65%	
				60%	
			55%		
			50%		
		Digital Zoom		-5 ~ 25 [Default:0]	
		Aspect Ratio		4:3	
				16:9	
			Native		
			Auto [Default]		
	PureMotion		Off		
			Low		
			Middle		
			High		
	Reset				

USING THE PROJECTOR

Level 1	Level 2	Level 3	Level 4	Value	
3D Settings	3D Mode			On	
				Off [Default]	
	3D Format			Auto [Default]	
				SBS	
				Top and Bottom	
				Frame Packing	
	3D Sync Invert			On	
			Off [Default]		
Audio Settings	Internal Speaker			On [Default]	
				Off	
	Sound Effect			Movie [Default]	
				Music	
	Audio Out			On	
				Off [Default]	
	SPIDF			Bitstream [Default]	
			PCM		
Mute			On		
			Off [Default]		
Volume			0 ~ 100 [Default:50]		
Projector Settings	Auto Focus				
	Manual Focus			Left	
				Right	
	Auto Focus Calibration				
	Auto Keystone			On	
				Off [Default]	
	Keystone			-40 ~ 40 [Default:0]	
	Power Settings	Direct Power On			On
					Off [Default]
		Auto Power Off(min.)			Off ~ 180 (5 min increments) [Default: 20]
		Sleep Timer(min.)			Off(0) ~ 990 (30 min increments) [Default: Off]
		Sleep Always On			Yes
					No [Default]
	Power Mode(Standby)			Eco. [Default]	
				Smart Home	
	Others	Test Pattern			Grid (Green)
					Grid (Magenta)
				Grid (White)	
				White	
Projection				Front  [Default]	
				Rear 	
				Front-Ceiling 	
				Rear-Ceiling 	

USING THE PROJECTOR

Level 1	Level 2	Level 3	Level 4	Value	
Projector Settings	Others	EDID Reminder		On [Default]	
				Off	
		HDMI EDID		2.0 [Default]	
				1.4	
		HDMI1 EQ		-16 ~ -1	
				Auto [Default]	
				1 ~ 16	
		HDMI2 EQ		-16 ~ -1	
				Auto [Default]	
				1 ~ 16	
		HDMI/USB Disk		Notification	
				Source Auto Change [Default]	
				None	
		High Altitude		On	
	Off [Default]				
Info	Regulatory				
	Serial Number				
	Source				
	Resolution				
	Display Mode				
	Brightness Mode				
	Power Mode(Standby)				
	Light Source Hours				
	Color Depth				
	Color Format				
	FW Version	SYSTEM			
		MCU			
		EDID			
System Update					
Reset All					

USING THE PROJECTOR

Image settings menu

Display mode

There are many factory presets optimized for various types of images.

- **Cinema:** Provides the best colors for watching movies.
- **HDR:** Decodes and displays High Dynamic Range (HDR) content for the deepest blacks, brightest whites, and vivid cinematic color using REC.2020 color gamut. This mode will be automatically enabled if HDR is set to ON (and HDR Content is sent to projector – 4K UHD Blu-ray, 1080p/4K UHD HDR Games, 4K UHD Streaming Video). While HDR mode is active, other display modes (Cinema, Reference, etc.) cannot be selected as HDR delivers color that is highly accurate, exceeding the color performance of the other display modes.
- **HDR SIM.:** Enhances non-HDR content with simulated High Dynamic Range (HDR). Choose this mode to enhance gamma, contrast, and color saturation for non-HDR content (720p and 1080p Broadcast/Cable TV, 1080p Blu-ray, non-HDR Games, etc). This mode can ONLY be used with non-HDR content.
- **Game:** Select this mode to increase the brightness and response time level for enjoying video games.
- **Reference:** This mode is intended to reproduce as close as possible the image the way the movie director intended. Color, color temperature, brightness, contrast and gamma settings are all configured to standard reference levels. Select this mode to watch a video.
- **Bright:** Maximum brightness from PC input.
- **User:** Memorize user's settings.
- **3D:** To experience the 3D effect, you need to have 3D glasses. Make sure a Blu-ray 3D DVD player is installed.
- **ISF Day:** Optimize the image with the ISF Day mode to be perfectly calibrated and high picture quality.
- **ISF Night:** Optimize the image with the ISF Night mode to be perfectly calibrated and high picture quality.

Note: For access and calibration of ISF daytime and night viewing modes, please contact your local dealer.

Dynamic Range

Configure the High Dynamic Range (HDR) setting and its effect when displaying video from 4K Blu-ray players and streaming devices.

➤ HDR

- **Auto:** Auto detect HDR signal.
- **Off:** Turn off HDR Processing. When set to Off, the projector will NOT decode HDR content.

➤ HDR Picture Mode

- **Bright:** Choose this mode for brighter more saturated colors.
- **Standard:** Choose this mode for natural looking colors with a balance of warm and cool tones.
- **Film:** Choose this mode for improved detail and image sharpness.
- **Detail:** Choose this mode for improved detail and image sharpness in dark scenes.

Brightness

Adjust the brightness of the image.

Contrast

The contrast controls the degree of difference between the lightest and darkest parts of the picture.

USING THE PROJECTOR

Sharpness

Adjust the sharpness of the image.

Color

Adjust a video image from black and white to fully saturated color.

Tint

Adjust the color balance of red and green.

Gamma

Set up gamma curve type. After the initial setup and fine tuning is completed, utilize the Gamma Adjustment steps to optimize your image output.

- **Film:** For home theater.
- **Video:** For video or TV source.
- **Graphics:** For PC / Photo source.
- **Standard(2.2):** For standardized setting.
- **1.8 / 2.0 / 2.4:** For specific PC / Photo source.

Note: *These options are only available if the 3D mode function is disabled. In 3D mode, user can only select 3D for Gamma setting.*

Color Settings

Configure the color settings.

- **Color Temp.:** Select a color temperature from Standard, Cool or Cold.
- **Color Space:** select an appropriate color matrix type from the following: Auto, RGB(0-255), RGB(16-235), YUV(0-255), and YUV(16-235).
- **Color Matching:** Adjust hue, saturation, and gain for the red, green, blue, cyan, yellow, magenta, or white color.
- **RGB Gain/Bias:** This settings allows to configure the brightness (gain) and contrast (bias) of an image.

Brightness Mode

Select the brightness mode setting.

Digital Zoom

Use to reduce or magnify an image on the projection screen.

Aspect ratio

Select the aspect ratio of the displayed image.

- **4:3:** This format is for 4:3 input sources.
- **16:9:** This format is for 16:9 input sources, like HDTV and DVD enhanced for Wide screen TV.
- **Native:** This format displays the original image without any scaling.
- **Auto:** Automatically selects the appropriate display format.

USING THE PROJECTOR

4K UHD scaling table:

16 : 9 screen	480i/p	576i/p	720p	1080i/p	2160p
4x3	Scale to 2880 x 2160.				
16x9	Scale to 3840 x 2160.				
Native mode	1:1 mapping centered. No scaling will be made; the displayed resolution depends on input source.				
Auto	-If source is 4:3, the screen type will be scaled to 2880 x 2160. -If source is 16:9, the screen type will be scaled to 3840 x 2160. -If source is 15:9, the screen type will be scaled to 3600 x 2160. -If source is 16:10, the screen type will be scaled to 3456 x 2160.				

Auto mapping rule:

	Input resolution		Auto/Scale	
	H-resolution	V-resolution	3840	2160
4:3	640	480	2880	2160
	800	600	2880	2160
	1024	768	2880	2160
	1280	1024	2880	2160
	1400	1050	2880	2160
	1600	1200	2880	2160
Wide Laptop	1280	720	3840	2160
	1280	768	3600	2160
	1280	800	3456	2160
SDTV	720	576	2700	2160
	720	480	3240	2160
HDTV	1280	720	3840	2160
	1920	1080	3840	2160

PureMotion

Use to preserve a natural motion of the displayed image.

Reset

Return the factory default settings for color settings.

USING THE PROJECTOR

3D settings menu

Note: *The maximum resolution is 1080P (4K resolution is not supported).*

3D Mode

Use this option to enable/disable the 3D mode function.

3D Format

Use this option to select the appropriate 3D format content.

- **Auto:** When a 3D identification signal is detected, the 3D format is selected automatically.
- **SBS:** Display 3D signal in “Side-by-Side” format.
- **Top and Bottom:** Display 3D signal in “Top and Bottom” format.
- **Frame Packing:** Display 3D signal in “Frame Packing” format.

3D Sync Invert

Use this option to enable/disable the 3D sync invert function.

Audio settings menu

Internal Speaker

Choose “On” or “Off” to turn on or off the internal speaker.

Sound Effect

Select the sound effect.

Audio Out

Enable or disable the audio out function.

SPIDF

Select the SPIDF audio output format.

Mute

Use this option to temporarily turn off the sound.

- **On:** Choose “On” to turn mute on.
- **Off:** Choose “Off” to turn mute off.

Note: *“Mute” function affects both internal and external speaker volume.*

Volume

Adjust the audio volume level.

Projector settings menu

Auto Focus

Perform the automatic focus adjustment.

Note: *The Auto Focus range is between 0.8m~2m ±10%. If the projection distance is not within the specified range, you have to perform the manual focus adjustment to focus the projected image.*

Manual Focus

Adjust the focus manually.

USING THE PROJECTOR

Auto Focus Calibration

Perform the lens focus calibration.

Note: This function is only available when the **Auto Focus** setting is enabled.

Auto Keystone

Automatically adjust the image distortion caused by tilting the projector.

Keystone

Adjust the image distortion caused by tilting the projector.

Power Settings

- **Direct Power On:** Choose “On” to activate Direct Power mode. The projector will automatically power on when AC power is supplied, without pressing the “Power” key on the projector keypad or on the remote control.
- **Auto Power Off(min.):** Sets the countdown timer interval. The countdown timer will start, when there is no signal being sent to the projector. The projector will automatically power off when the countdown has finished (in minutes).
- **Sleep Timer(min.):** Sets the countdown timer interval. The countdown timer will start, with or without a signal being sent to the projector. The projector will automatically power off when the countdown has finished (in minutes).
- **Sleep Always On:** Choose “On” to set the sleep timer always on.
- **Power Mode(Standby):** Set the power mode setting.
 - **Eco.:** Choose “Eco.” to save power dissipation further < 0.5W.
 - **Smart Home:** Choose “Smart Home” to return to normal standby (LAN on, Wi-Fi on).

Others

- **Test Pattern:** Select the test pattern from Grid (Green), Grid (Magenta), Grid (White), or White.
- **Projection:** Select the preferred projection between Front, Rear, Front-Ceiling, and Rear-Ceiling.
- **EDID Reminder:** Choose “On” to display a reminder message when the input source is changed to HDMI.
- **HDMI EDID:** Select the HDMI EDID type from 2.0 or 1.4.

Note: If you experience abnormal color issue, please adjust the EDID setting.
- **HDMI1 EQ:** Set the HDMI port EQ value for HDMI1.
- **HDMI2 EQ:** Set the HDMI port EQ value for HDMI2.

Note:

 - *HDMI EQ analyses the signal data and eliminates distortion due to signal loss when using long HDMI cables. The HDMI receiver also includes a timing adjustment circuit that removes timing jitter, restoring the HDMI signal to optimal transmission levels.*
 - *Optoma recommend the use of Premium Certified HDMI Cables.*
 - *Optoma only guarantee operational stability for Premium Certified HDMI Cable lengths up to 5 meters.*
- **HDMI/USB Disk:** Define how the system will react when one of the input sources (HDMI/USB flash drive) is connected to the projector.
 - **Notification:** Choose “Notification” to display the input switching confirmation message when an input source is detected.
 - **Source Auto Change:** Choose “Source Auto Change” to automatically switch to the currently detected input source.
 - **None:** Choose “None” to manually switch the input source.

USING THE PROJECTOR

- **High Altitude:** When “On” is selected, the fans will spin faster. This feature is useful in high altitude areas where the air is thin.

Info menu

View the projector information as listed below:

- Regulatory
- Serial Number
- Source
- Resolution
- Display Mode
- Brightness Mode
- Power Mode(Standby)
- Light Source Hours
- Color Depth
- Color Format
- FW Version

USING THE PROJECTOR

Reset all menu

Return the factory default settings for all settings.

Adjusting the volume level

Select **Volume** to adjust the audio volume level. Then press **Enter** on the remote control to enter the **Volume** menu.

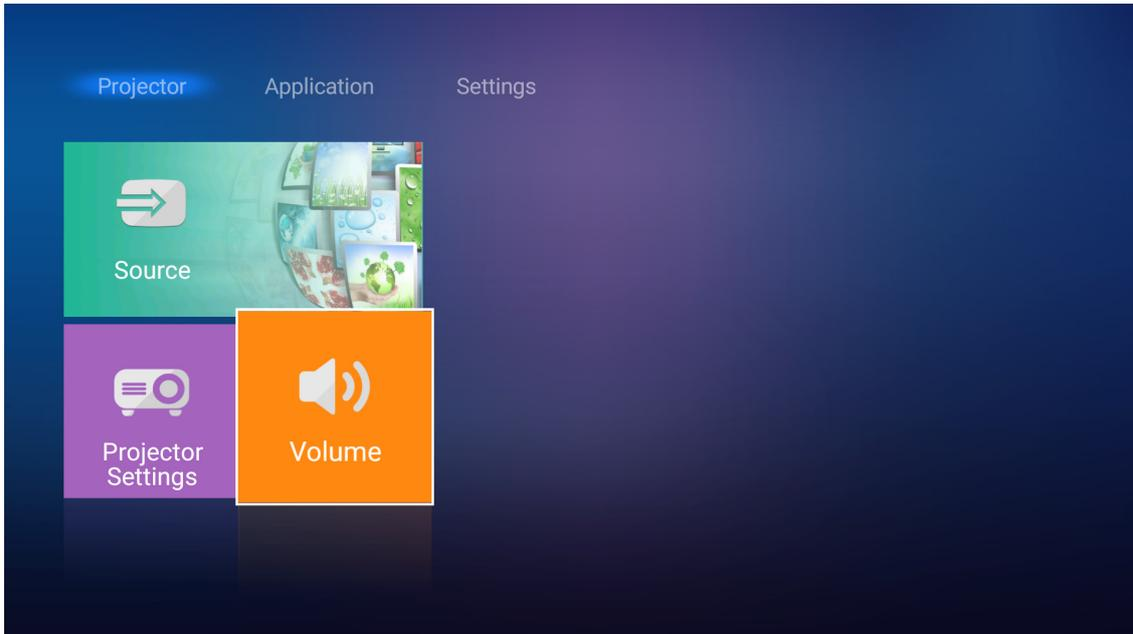

Use ◀▶ keys to adjust the desired volume level.

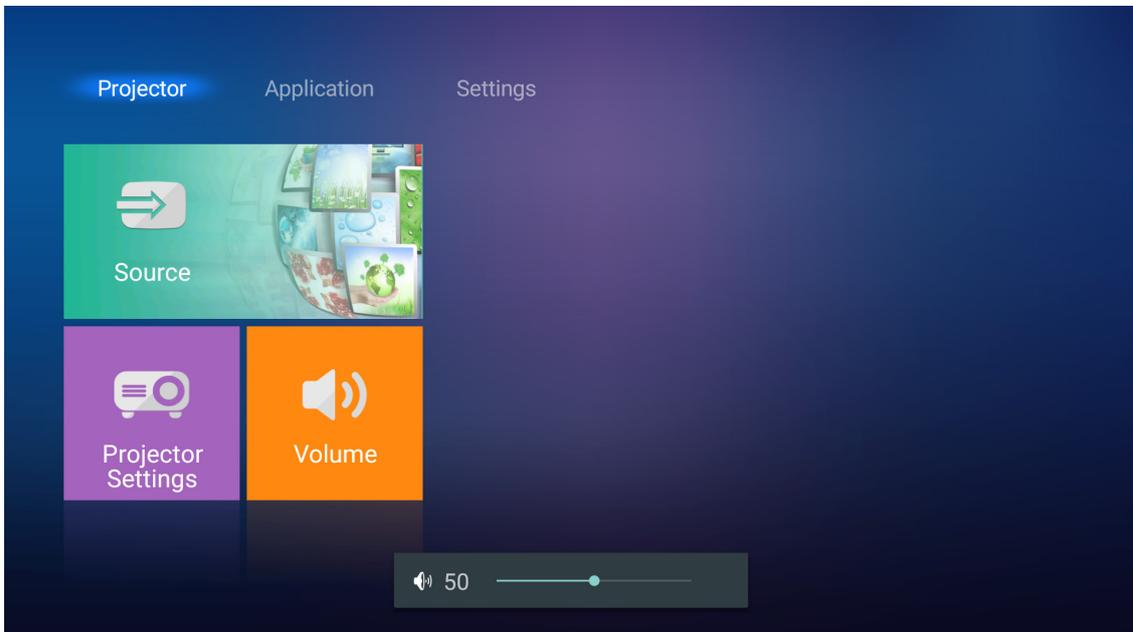

Note: You can set the volume level to 0 to activate the mute function.

USING THE PROJECTOR

Application settings

On the **Application** home screen, you can access the apps list, register the projector to the Device Cloud, and view the multimedia files. To switch to the **Application** home screen, select one of the main categories and use ◀▶ keys to select **Application**.

Accessing all apps

Select **Apps** to view the apps list. Then press **Enter** on the remote control to enter the **Apps** menu.

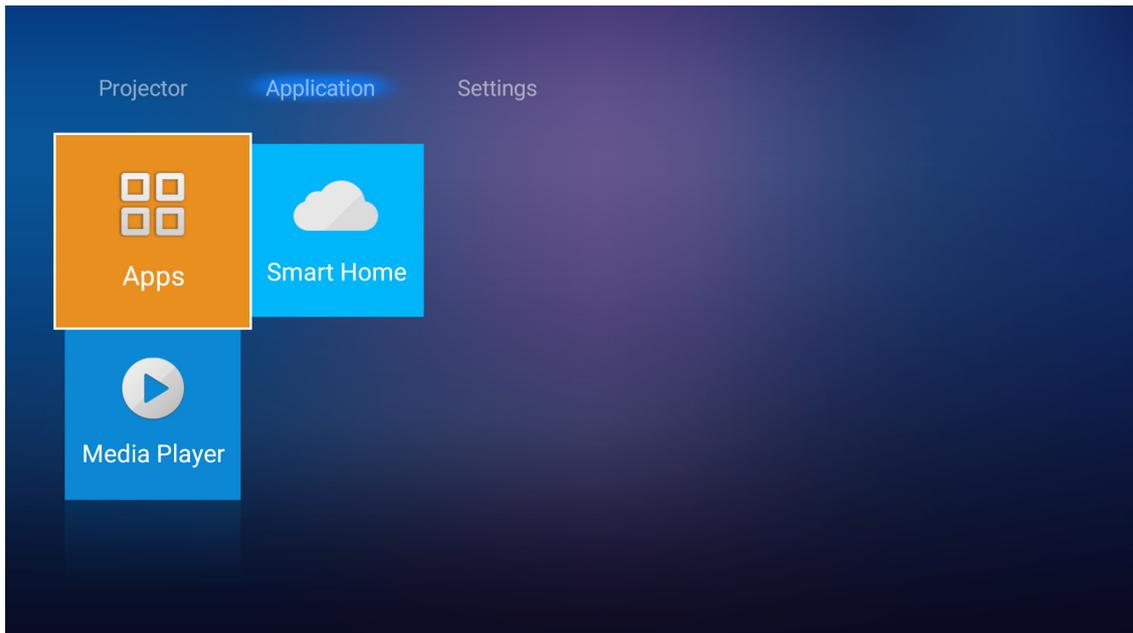

Use ◀▶ keys to select the desired application. Then press **Enter** on the remote control to launch the selected application.

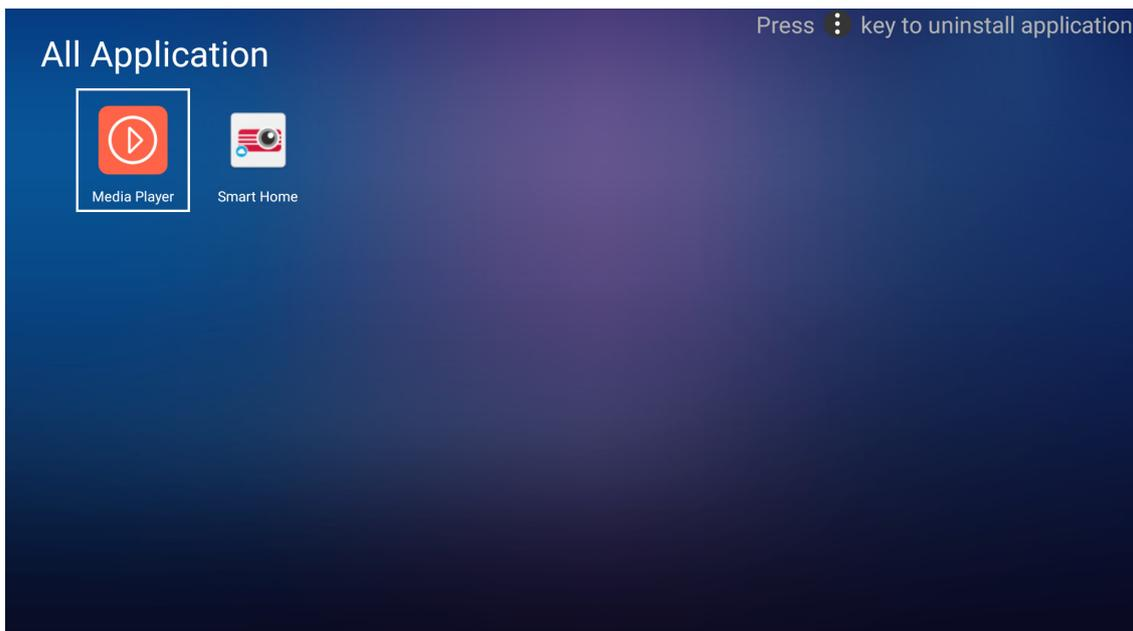

For more information about **Media Player** app, refer to the "Playing multimedia files" section on page 42.

For more information about **Smart Home**, refer to the "Registering the projector to Device Cloud" section on page 70.

USING THE PROJECTOR

Registering the projector to Device Cloud

Select **Smart Home** to register the projector to the Device Cloud. Then press **Enter** on the remote control to enter the **Smart Home** menu.

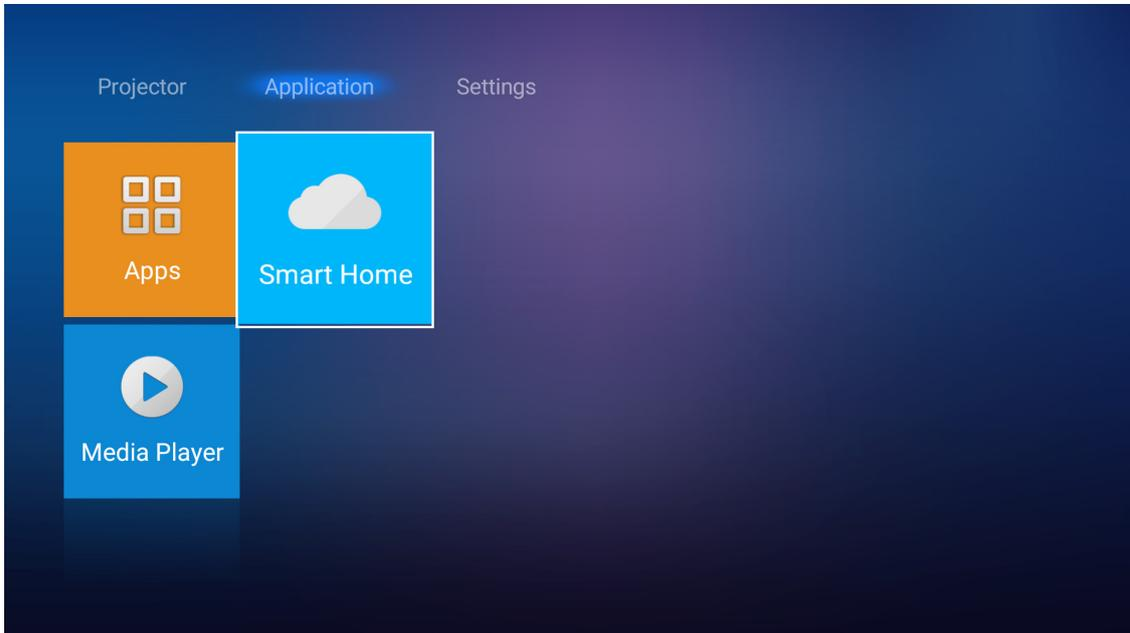

The current setting parameters are displayed on the screen. To register the projector to the Device Cloud, please refer to page 70.

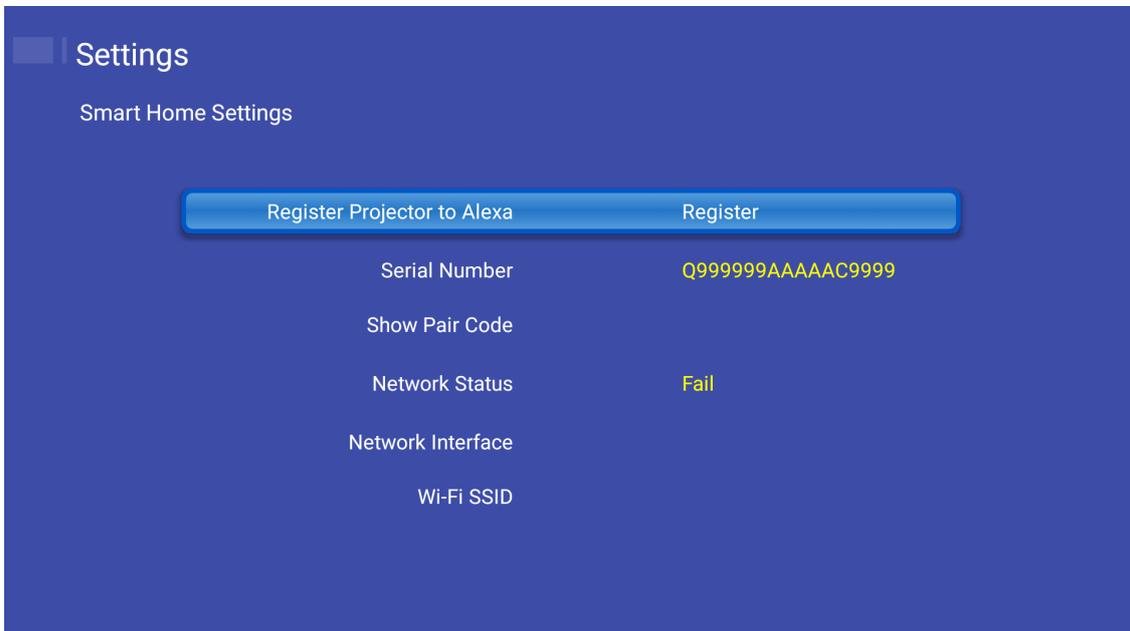

USING THE PROJECTOR

Playing multimedia files

Select **Media Player** to browse multimedia files stored in the USB flash drive after connecting to projector.

Note:

- *USB format is only supported on FAT and FAT32.*
- *The maximum file size of the USB flash drive is 64GB (NTFS).*

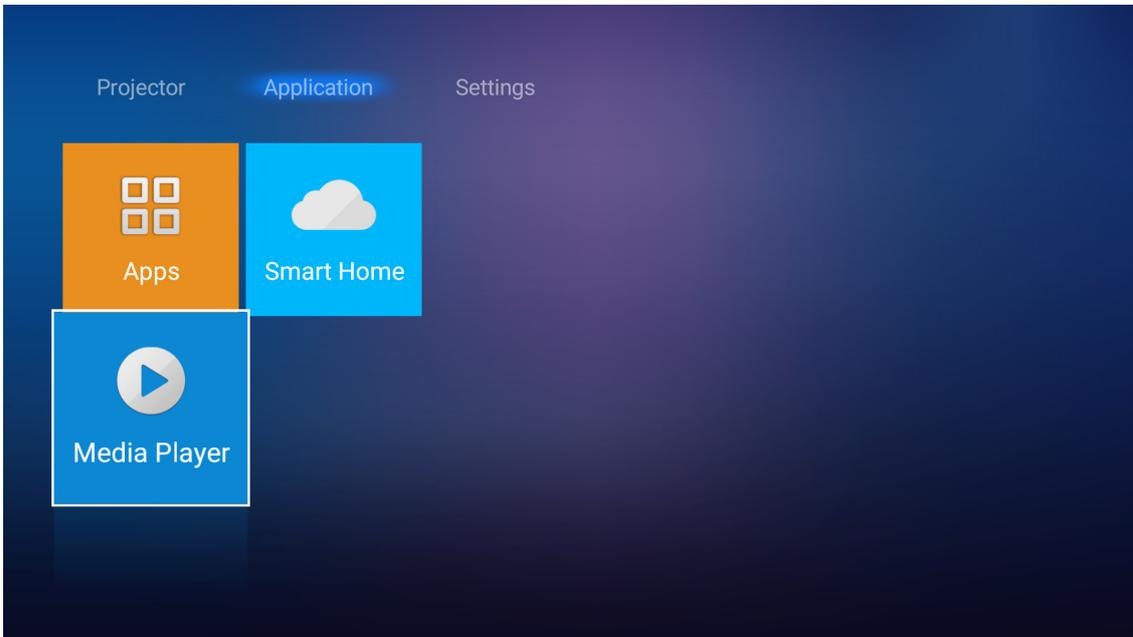

Multimedia support format

Video

File Format	Video Format	Decode Maximum Resolution	Maximum Bit Rate (bps)	Profile
MPG, MPEG	MPEG1/2	1920 x 1080 60fps	40M bps	MP@HP
MOV, MP4, MKV	H.264	4096 x 2176 30fps	135M bps	MP/HP @Level 5.1
AVI, MOV, MP4	MPEG4	1920 x 1080 60fps	40M bps	SP/ASP@Level 5.1
AVI, MP4, MOV, MKV	MJPEG	1920 x 1080 30fps	10M bps	Baseline
WMV, ASF	VC-1	1920 x 1080 60fps	40M bps	SP/MP/AP
3GP, MP4, AVI, MOV	H.263	1920 x 1080 60fps	40M bps	
MP4, MOV, MKV	HEVC/H.265	4096 x 2176 60fps	100M bps	Main/Main10 Profile, High Tier @Level 5.1
MKV	VP8	1920 x 1080 60fps	20M bps	
	VP9	4096 x 2176 60fps	100M bps	Profile0,2
MP4, MOV, TS, TRP, TP	AVS	1920 x 1080 60fps	40M bps	Jizhun profile @Level 6.0

USING THE PROJECTOR

Picture

Image Type (Ext name)	Sub Type	Maximum Pixels
Jpeg / Jpg	Baseline	8000 x 8000
	Progressive	6000 x 4000
PNG	Non-interlace	6000 x 4000
	Interlace	6000 x 4000
BMP		6000 x 4000

Music

Music Type (Ext name)	Sample Rate (KHz)	Bit Rate (Kbps)
MP3	16~48	8~320
WMA	8~48	128~320
ADPCM-WAV	8~48	32~384
PCM-WAV	8~48	64~1536
AAC	8~48	8~48

Doc

Document Format	Support Version and Format	Pages/Lines Limitation	Size Limitation
PDF	PDF 1.0 ~ 1.7 and above	Up to 1500 pages (One File)	Up to 100MB
Word	Kingsoft Writer Document (*.wps)	Since WPS Projector does not load the MS/Word files all at one time, there is no obvious limitation on the number of pages and rows of files.	Up to 150MB
	Kingsoft Writer Template (*.wpt)		
	Microsoft Word 97/2000/XP/2003 Document (*.doc)		
	Microsoft Word 97/2000/XP/2003 Template (*.dot)		
	RTF Files (*.rtf)		
	Text Files (*.txt, *.log, *.lrc, *.c, *.cpp, *.h, *.asm, *.s, *.java, *.asp, *.prg, *.bat, *.bas, *.cmd)		
	Web Page Files (*.html, *.htm)		
	Single Web Page Files (*.mht, *.mhtml)		
	Microsoft Word 2007/2010 Document (*.docx)		
	Microsoft Word 2007/2010 Template (*.dotx)		
	Microsoft Word 2007/2010 Macro-Enabled Document (*.docm)		
	Microsoft Word 2007/2010 Macro-Enabled Template (*.dotm)		
	XML Files (*.xml)		
OpenDocument Text			
Works 6-9 Document (*.wtf)			
Works 6.0&7.0 (*.wps)			

USING THE PROJECTOR

Document Format	Support Version and Format	Pages/Lines Limitation	Size Limitation
Excel	Kingsoft Spreadsheets Files (*.et)	Row Limit: up to 65,535 Column Limit: up to 256 Sheet: up to 200	Up to 30MB
	Kingsoft Spreadsheets Template (*.ett)		
	Microsoft Excel 97/2000/XP/2003 Workbook (*.xls)		
	Microsoft Excel 97/2000/XP/2003 Template (*.xlt)		
	Text Files (*.csv)		
	Web Pages (*.htm, *.html)		
	XML Files (*.xml)		
	Microsoft Excel 2007/2010 Files (*.xlsx, *.xlsm)		
	Microsoft Excel 2007/2010 Template (*.xltx)		
	Microsoft Excel 2007/2010 Binary Workbook (*.xlsb)		
PowerPoint	Kingsoft Presentation Files (*.dps)	Up to 1500 pages (One File)	Up to 30MB
	Kingsoft Presentation Templates (*.dpt)		
	Microsoft PowerPoint 97/2000/XP/2003 Presentations (*.ppt, *.pps)		
	Microsoft PowerPoint 97/2000/XP/2003 Presentation Templates (*.pot)		
	Microsoft PowerPoint 2007/2010 Presentations (*.pptx, *.ppsx)		
	Microsoft PowerPoint 2007/2010 Presentations Template (*.potx)		

Note:

- *Decoding may take a while for large files with complex contents.*
- *Objects embedded in files cannot be activated or viewed.*
- *For Microsoft Word*
 - *No support for advanced settings, such as drawing plug-in or table background settings.*
 - *Contents outside the defined borders in Microsoft Word will not be displayed.*
 - *Not support Bold Text in Simplified Chinese font.*
- *For Microsoft PowerPoint*
 - *Slide effects not supported.*
 - *Password-protected sheets are not protected.*
 - *Powerpoint animation is not supported.*
- *For Microsoft Excel*
 - *Worksheets are displayed individually and sequentially when the workbook has multiple worksheets.*
 - *Page layout and numbering may be changed during decoding.*

USING THE PROJECTOR

Entering the multimedia mode

1. Insert a USB flash drive to the USB connector on the rear side of the projector.

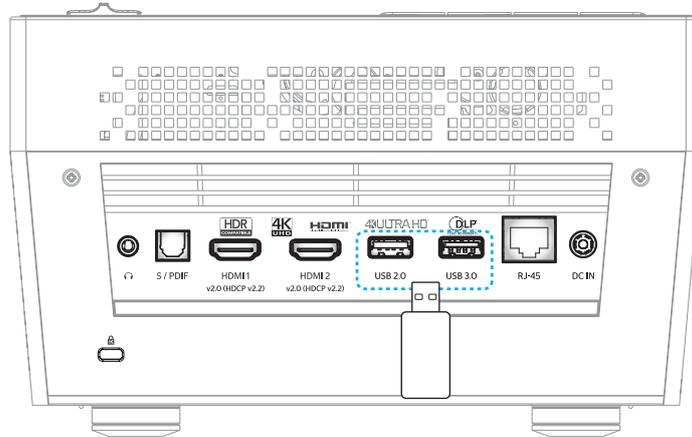

The available files appears on the screen.

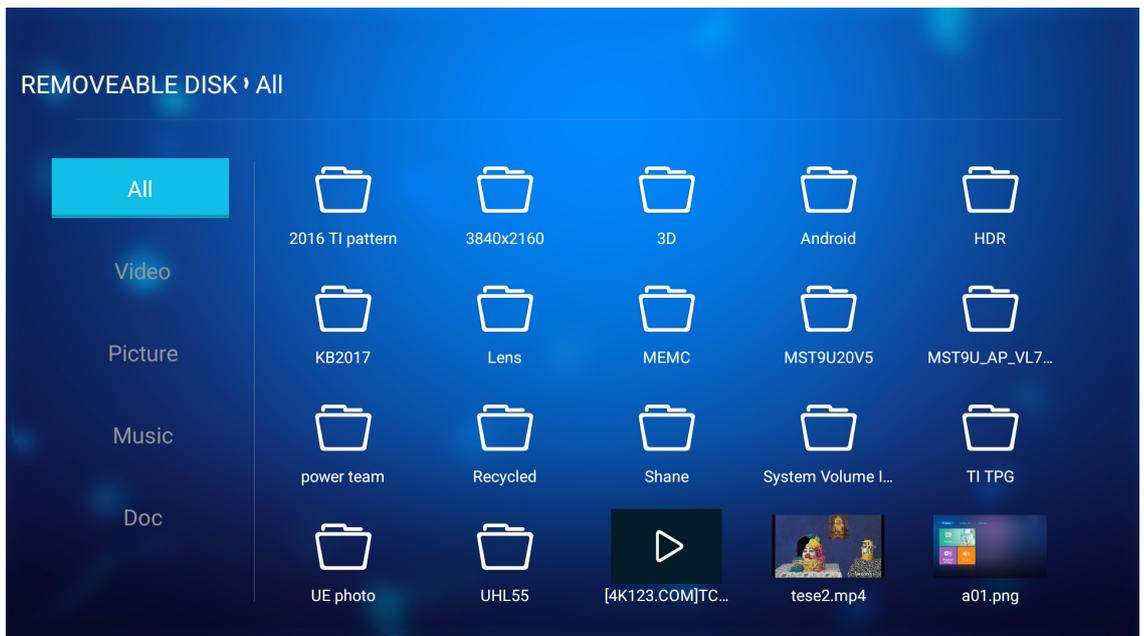

Note: To manually enter the multimedia mode, select **Application > Media Player**.

2. Browse and select the file you want to view.

USING THE PROJECTOR

Playing Videos

1. From the left panel, select **Video** to browse all video files.

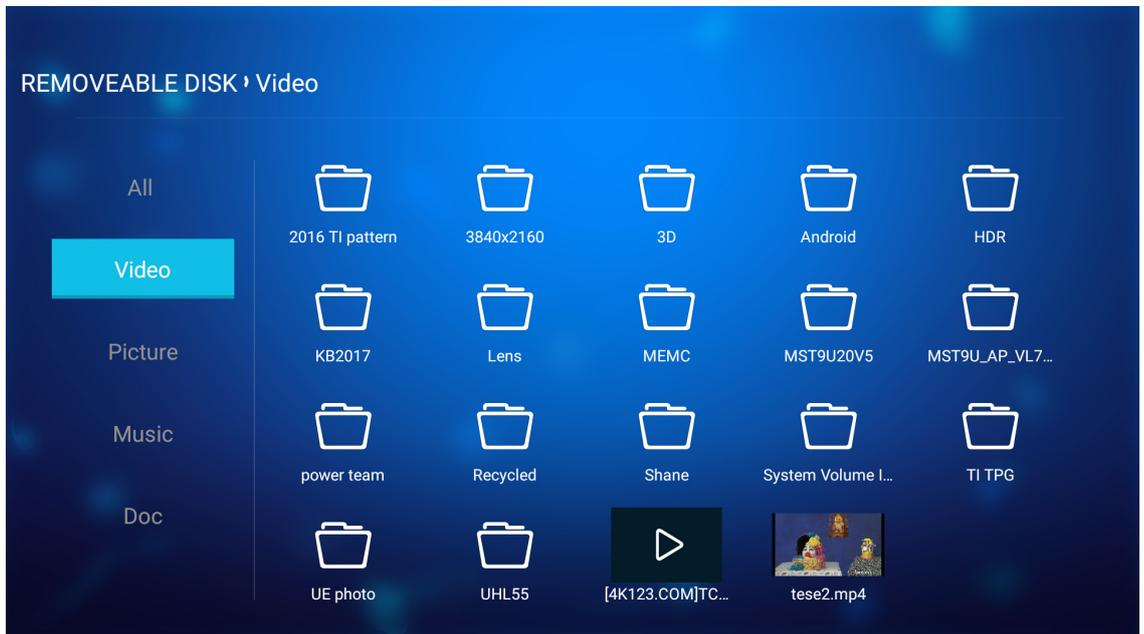

If there are several folders, press ▲▼◀▶ keys to select the desired folder, then press **Enter** to view the subfolder content.

2. Press ▲▼◀▶ keys to select the video you want play, then press **Enter** to start the playback.

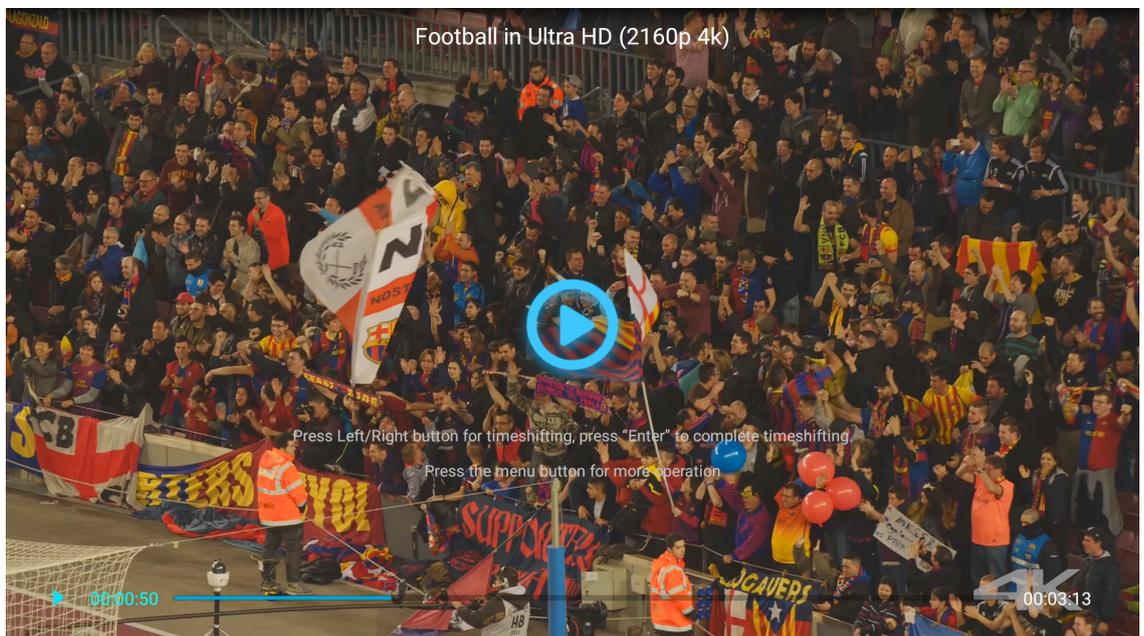

- Press **Enter** to pause the playback. While the video is being paused:
 - Press ◀▶ keys to rewind or fast forward the video.
 - To resume, press **Enter**.
- To adjust the volume level, press the “+”/“–” button on the projector keypad.
- To skip to the next/previous video, press and hold the “+”/“–” button on the projector keypad.
- To stop playback at any time, press ↶.

USING THE PROJECTOR

Viewing Photos

1. From the left panel, select **Picture** to browse all picture files.

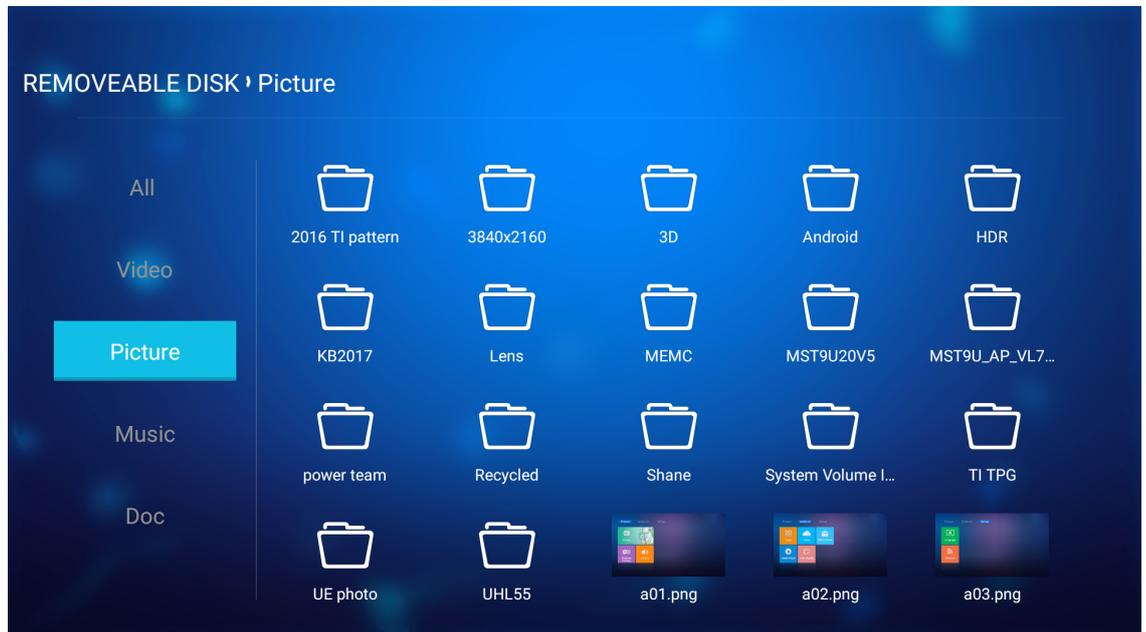

If there are several folders, press ▲▼◀▶ keys to select the desired folder, then press **Enter** to view the subfolder content.

2. Press ▲▼◀▶ keys select a photo, then press **Enter** to view the photo in full screen.

Photo Options

While viewing the photo in full screen:

- Use ◀▶ keys to view the previous or next photo.
- Press **Enter** to access the quick menu.

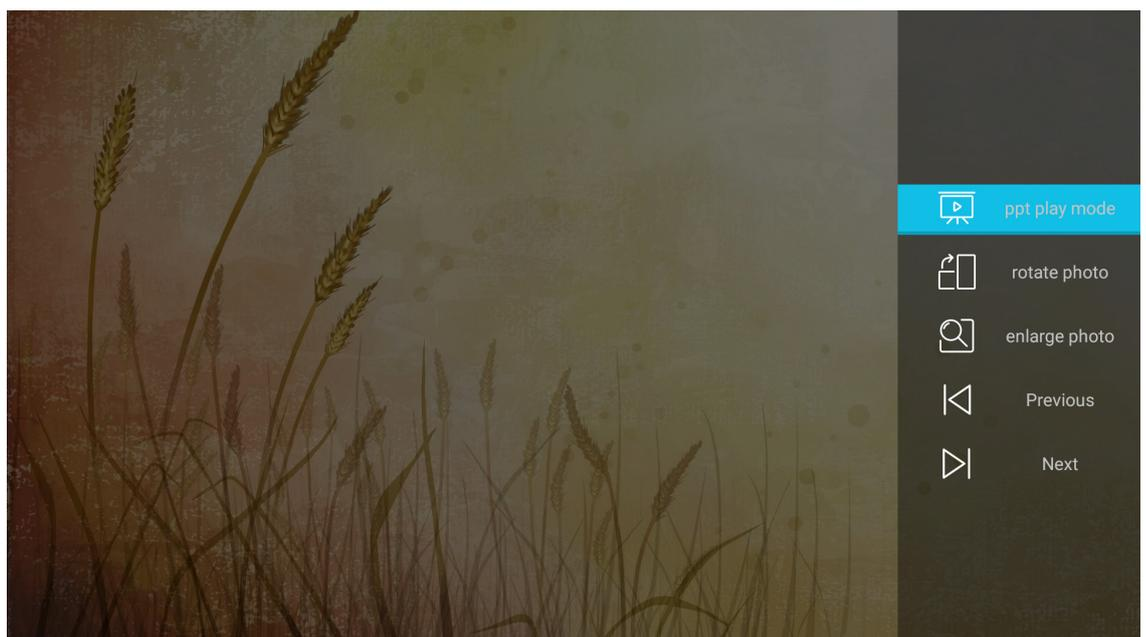

- Select **ppt play mode** to configure the slide show settings.
- Select **rotate photo** to rotate the photo 90-degree clockwise.

USING THE PROJECTOR

- Select **enlarge photo** to magnify the view of a photo.
- Select **Previous** to view the previous photo.
- Select **Next** to view the next photo.

Slide show Settings

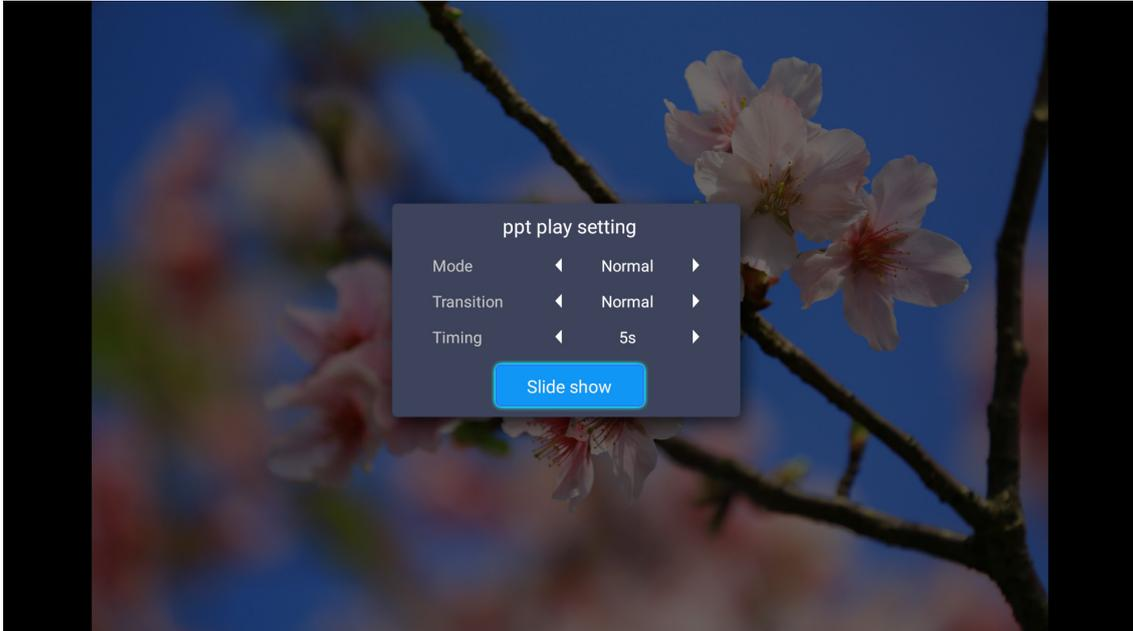

Mode

Set the slide show mode option.

Transition

Select the transition effect between each slide displays.

Timing

Set the interval time between each slide displays.

Slide show

Select to start the slide show.

Note:

- To pause the slide show, press *Enter*.
- To stop the slide show, press ↶.

USING THE PROJECTOR

Playing Music

1. From the left panel, select **Music** to browse all songs or audio files.

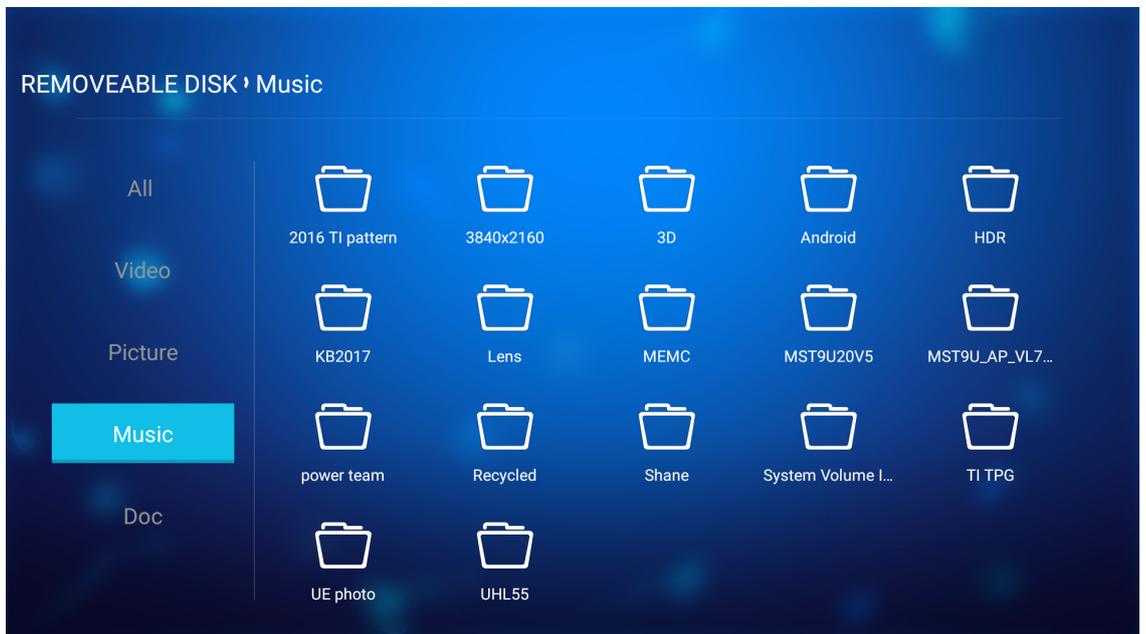

If there are several folders, press ▲▼◀▶ keys to select the desired folder, then press **Enter** to view the subfolder content.

2. Press ▲▼◀▶ keys to select the song you want play, then press **Enter** to start the playback.

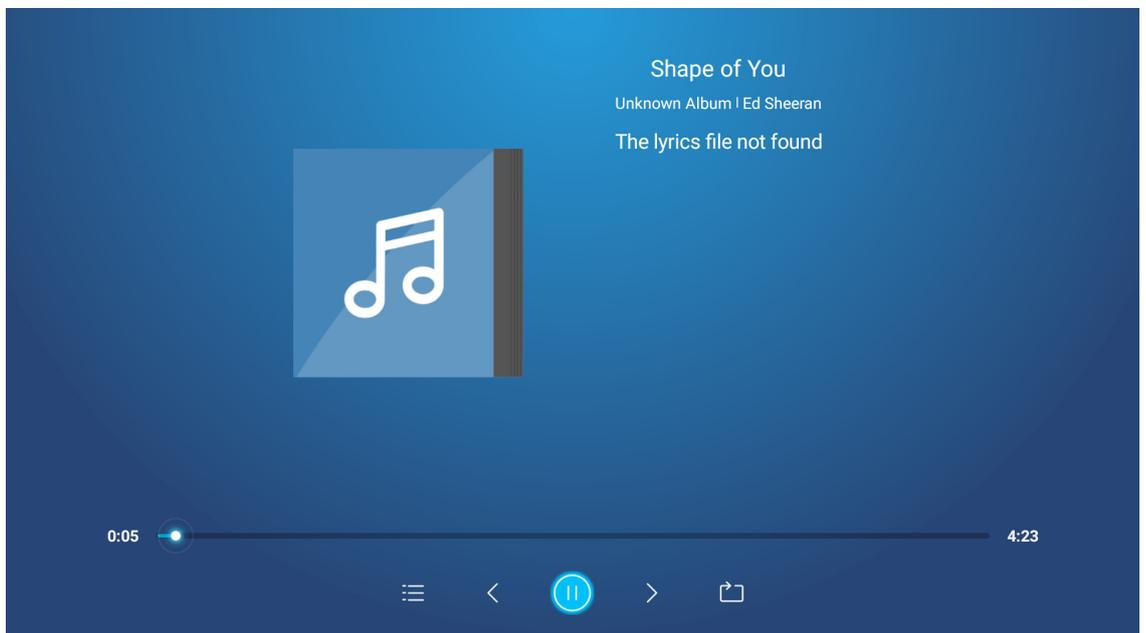

- To pause the playback, select ⏸ and press **Enter**. To resume, select ▶ and press **Enter**.
- To skip to the previous/next track, select ◀/▶ and press **Enter**.
- **Note:** You can also press and hold the “+”/“−” button on the projector keypad to change the song.
- To adjust the volume level, press the “+”/“−” button on the projector keypad.
- To switch the play mode, select 📺 and press **Enter** repeatedly to select the desired mode.
- To view the playlist, select ≡ and press **Enter**.
- To stop playback at any time, press ↶.

USING THE PROJECTOR

Viewing Document

1. From the left panel, select **Doc** to browse all document files.

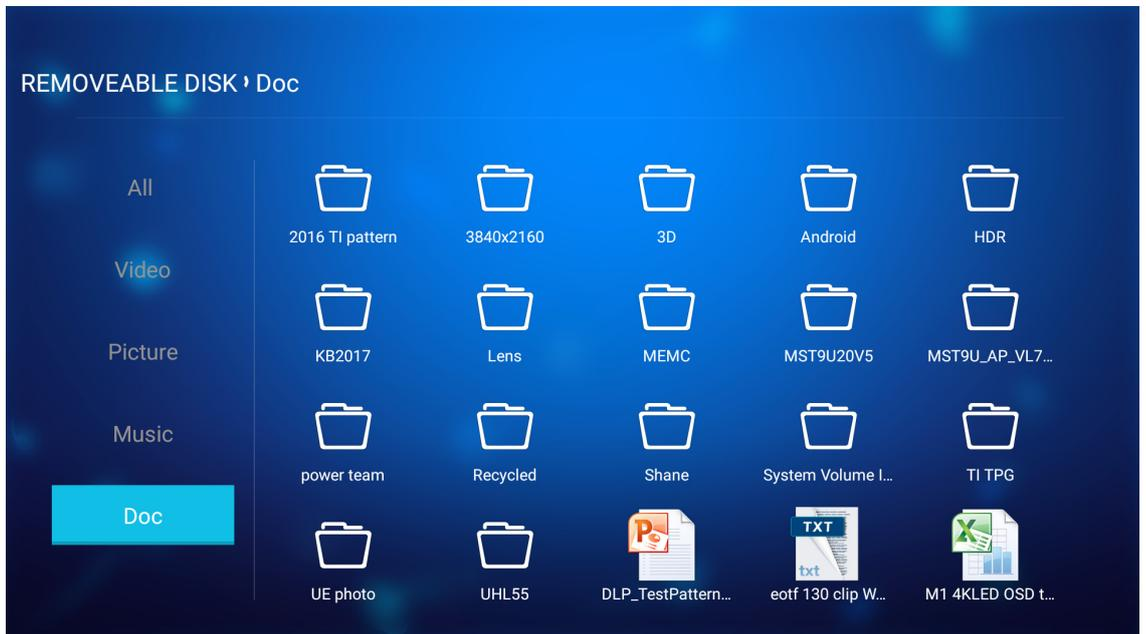

If there are several folders, press ▲▼◀▶ keys to select the desired folder, then press **Enter** to view the subfolder content.

2. Press ▲▼◀▶ keys to select the document you want to view, then press **Enter** to open the file.

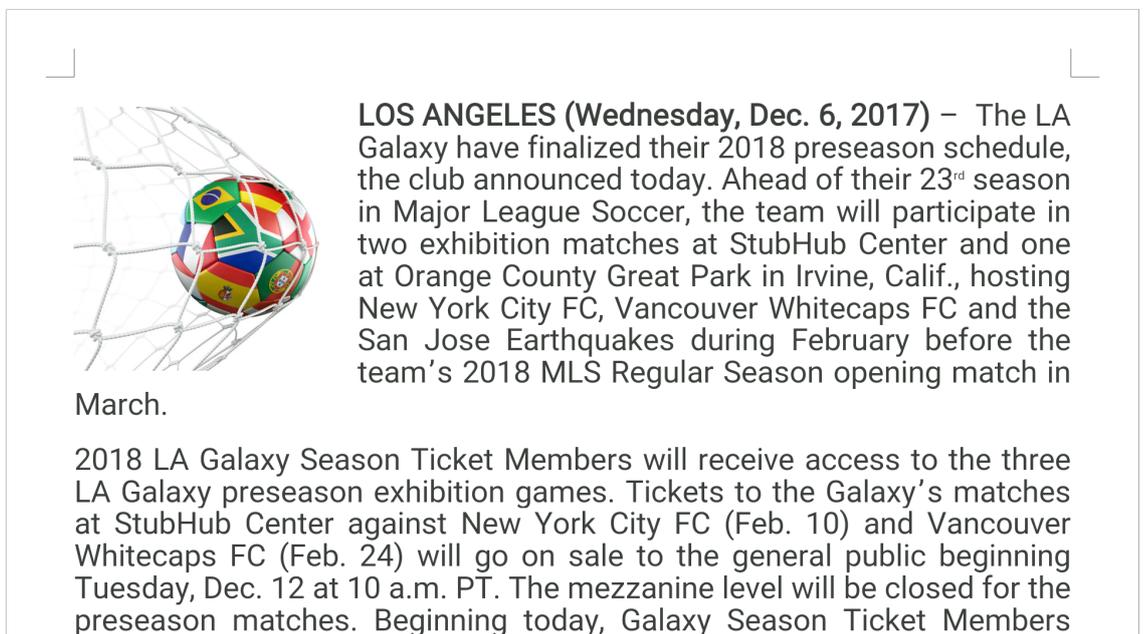

- Press ▲▼◀▶ keys to scroll the page up/down or navigate the page.
- To close the document at any time, press ↵.

USING THE PROJECTOR

Note: When opening a Powerpoint file, the Play Mode menu will appear on the screen. Then select the desired play mode and select **OK** to start browsing the file.

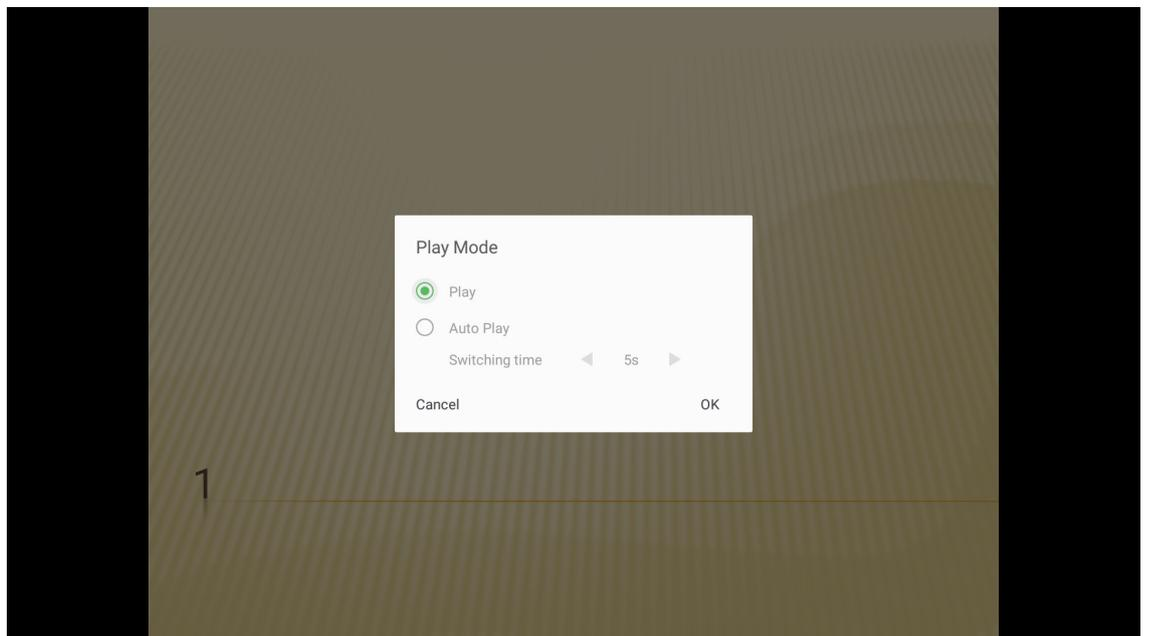

USING THE PROJECTOR

General settings

On the **Settings** home screen, you can set the on-screen display (OSD) language, update the firmware, and configure the network and time zone settings. To switch to the **Settings** home screen, select one of the main categories and use ◀▶ keys to select **Settings**.

Changing the OSD language

Select **Language** to set the on-screen display language. Then press **Enter** on the remote control to enter the **Language** menu.

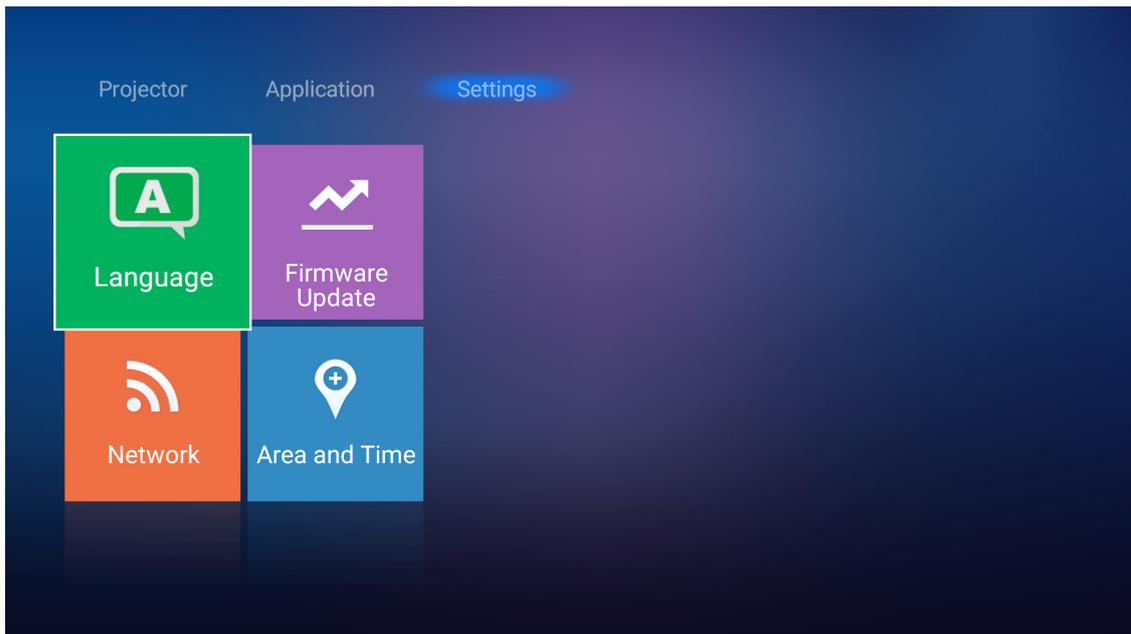

The available languages appear on the screen. Select the desired language and press **Enter** to confirm the selection.



USING THE PROJECTOR

Updating the projector firmware

Select **Firmware Update** to update the firmware. Then press **Enter** on the remote control to enter the **Firmware Update** menu.

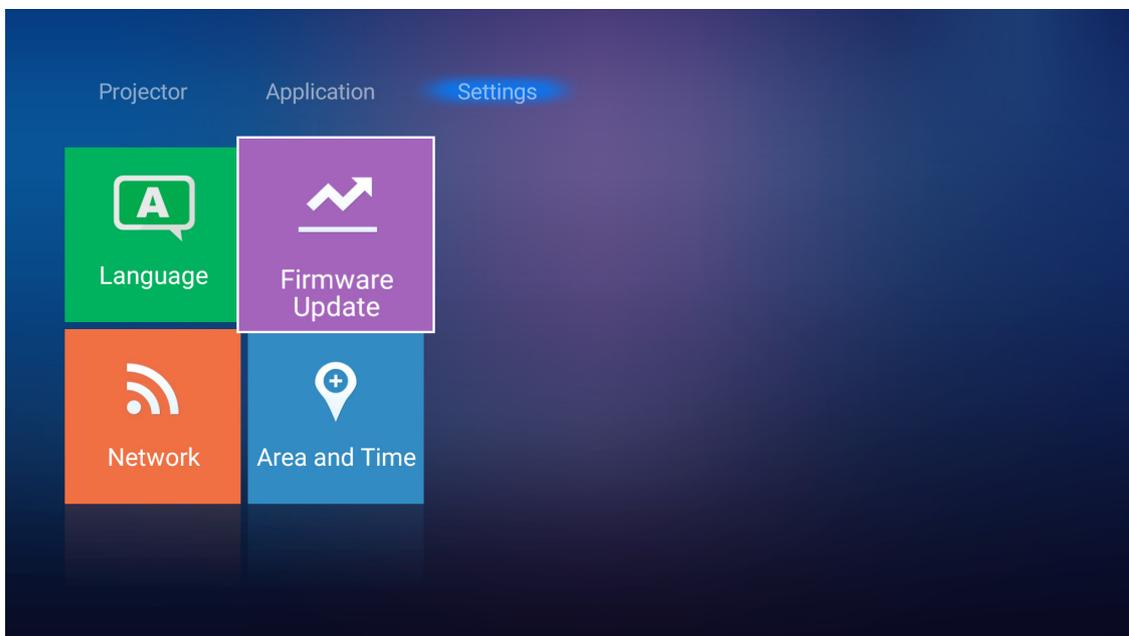

Select one of the available options and press **Enter** to confirm the selection.

USING THE PROJECTOR

Configuring the network settings

Select **Network** to configure the network setting. Then press **Enter** on the remote control to enter the **Network** menu.

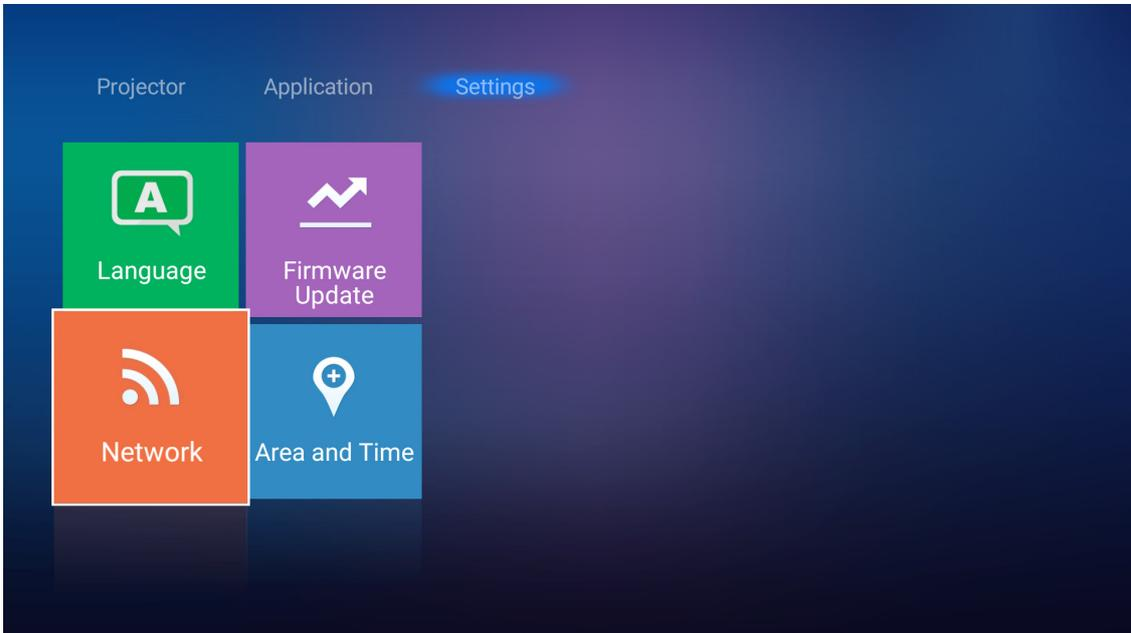

Select one of the available options and perform the necessary settings.

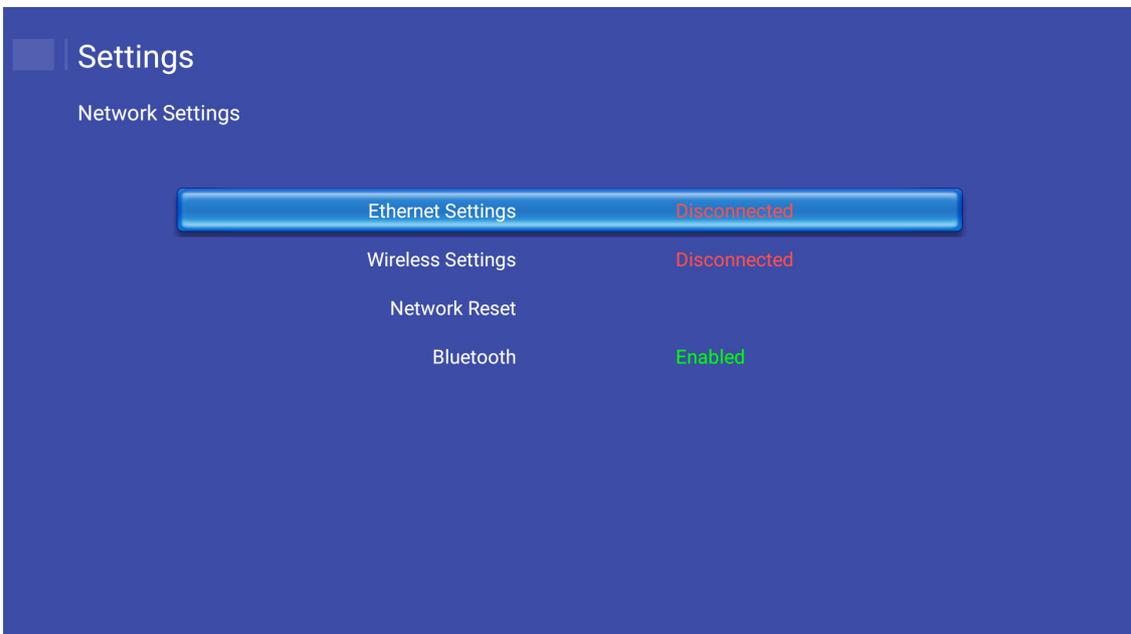

USING THE PROJECTOR

Ethernet Settings

Configure the network parameters.

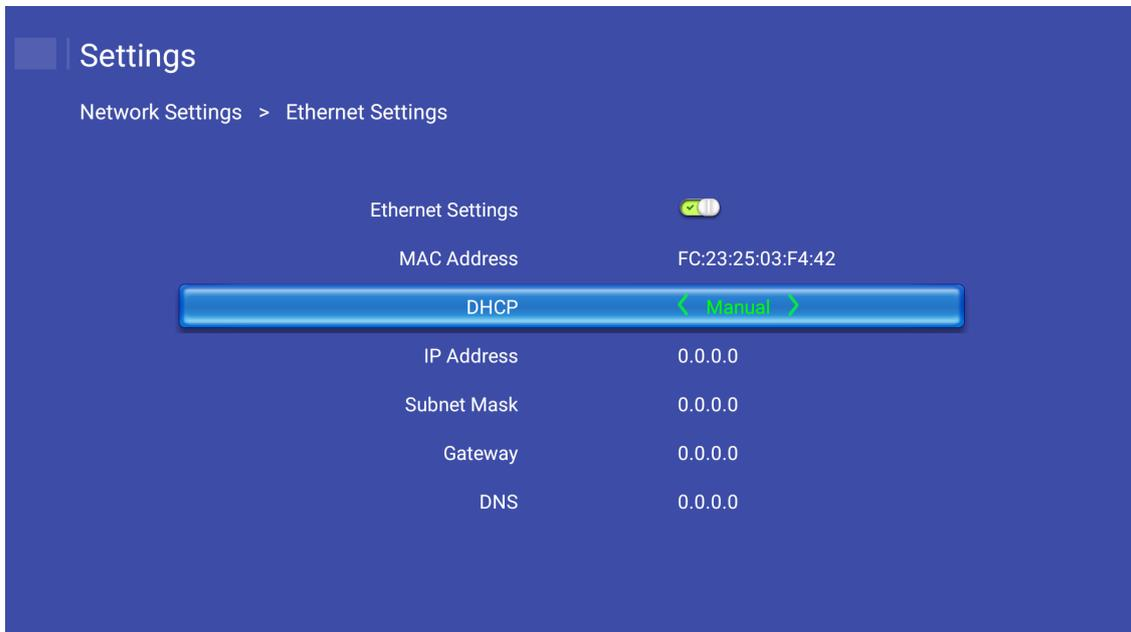

To manually configure the wired network settings, set the **DHCP** setting to **Manual** and enter the following connection parameters:

- IP Address: 192.168.0.100
- Subnet Mask: 255.255.255.0
- Gateway: 192.168.0.254
- DNS: 192.168.0.51

Note: *It is highly recommended to let the system to configure the wired network settings automatically (set the DHCP setting to “Auto”).*

USING THE PROJECTOR

Wireless Settings

Configure the wireless connection.

To connect the projector to a Wi-Fi network, do the following:

1. Go to **Settings** > **Network** > **Wireless Settings**. Then set the **Wi-Fi** setting to ON.
2. Connect to an available Wi-Fi network from the list.
If you connect to a secure Wi-Fi network, you must enter the password when prompted.

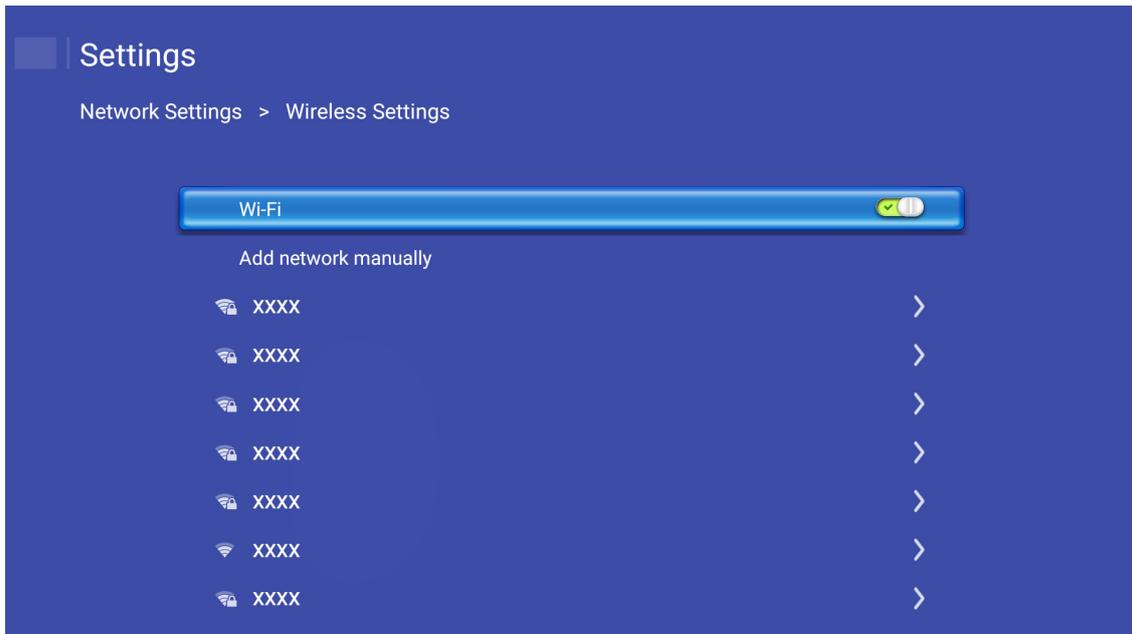

Network Reset

Reset the network parameters to factory default.

To reset all current network settings, use ◀▶ keys to select **OK** and press **Enter** to confirm.

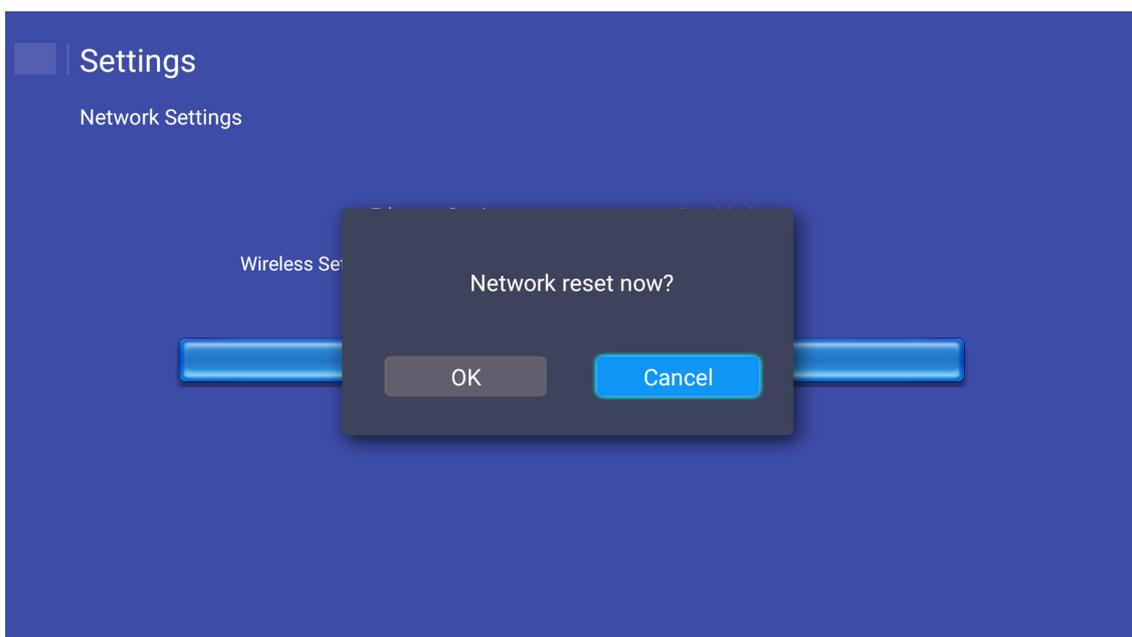

USING THE PROJECTOR

Bluetooth

Connect to the Bluetooth-enabled devices.

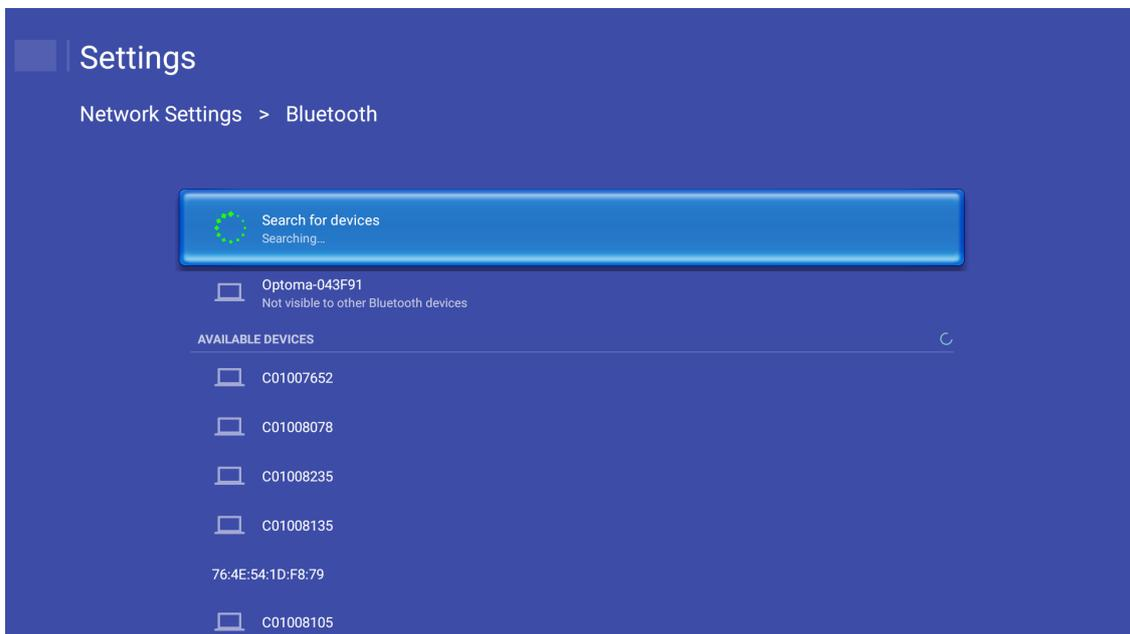

USING THE PROJECTOR

Selecting the time zone

Select **Area and Time** to select the time zone. Then press **Enter** on the remote control to enter the **Area and Time** menu.

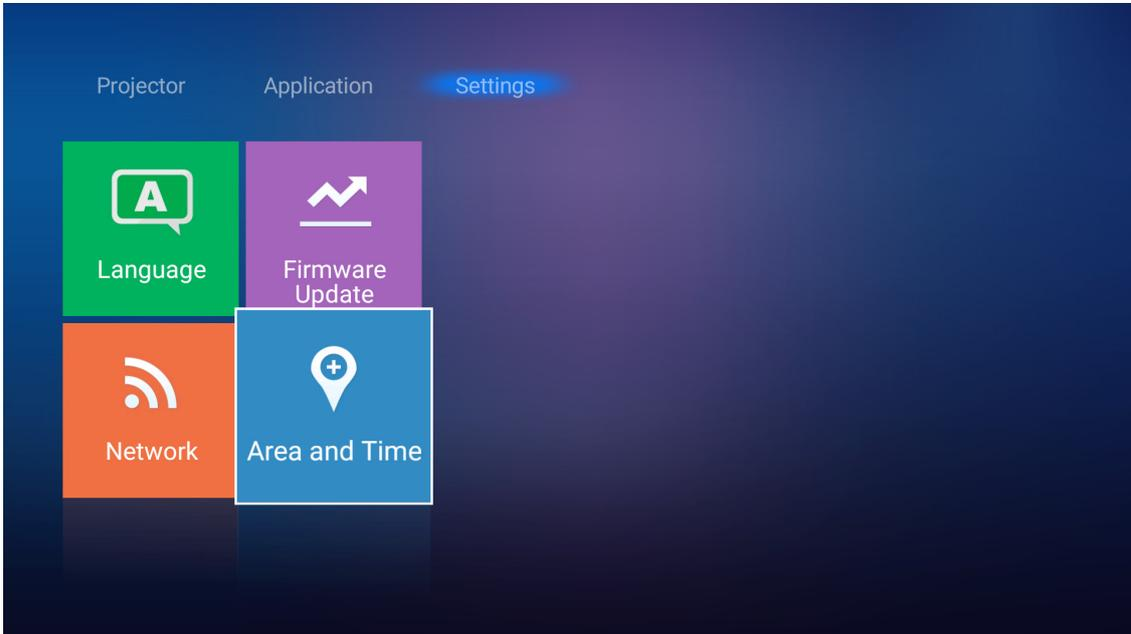

Select one of the available options and press **Enter** to confirm the selection.

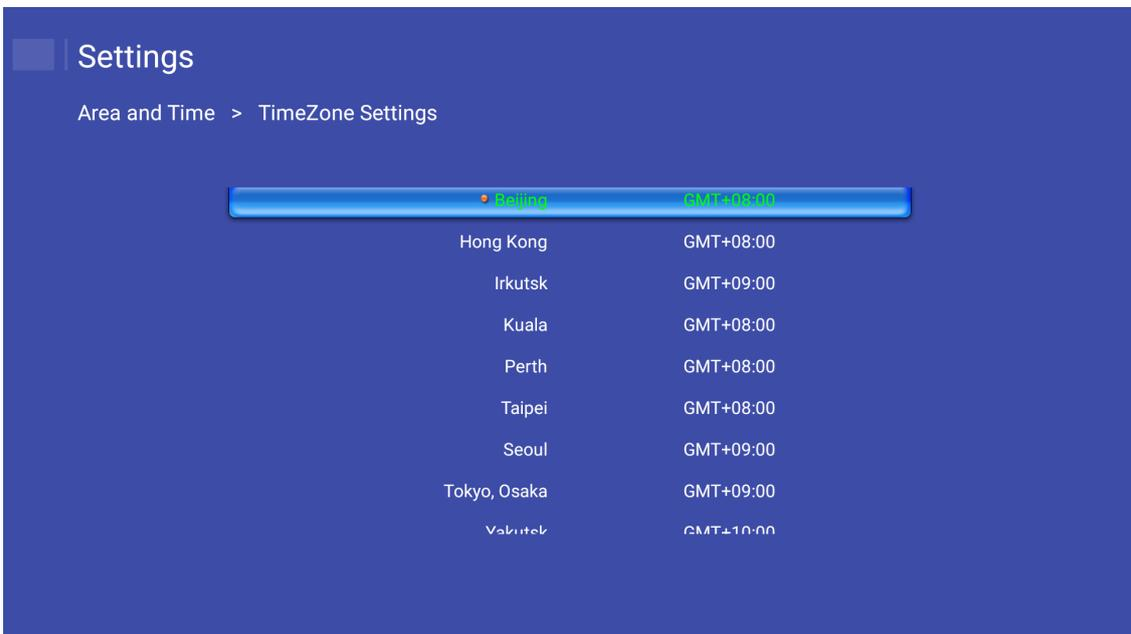

ADDITIONAL INFORMATION

Compatible resolutions

Digital (HDMI 1.4)

Established Timing	Standard Timing	Descriptor Timing	Supported Video Mode	Detail Timing
720 x 400 @ 70Hz	1280 x 720 @ 60Hz	1920 x 1080 @ 60Hz (default)	720 x 480i @ 60Hz 16:9	1920 x 1080p @ 60Hz
640 x 480 @ 60Hz	1280 x 800 @ 60Hz		720 x 480p @ 60Hz 4:3	
640 x 480 @ 67Hz	1280 x 1024 @ 60Hz		720 x 480p @ 60Hz 16:9	
640 x 480 @ 72Hz	1920 x 1200 @ 60Hz (reduced)		720 x 576i @ 50Hz 16:9	
640 x 480 @ 75Hz	1366 x 768 @ 60Hz		720 x 576p @ 50Hz 4:3	
800 x 600 @ 56Hz			720 x 576p @ 50Hz 16:9	
800 x 600 @ 60Hz			1280 x 720p @ 60Hz 16:9	
800 x 600 @ 72Hz			1280 x 720p @ 50Hz 16:9	
800 x 600 @ 75Hz			1920 x 1080i @ 60Hz 16:9	
832 x 624 @ 75Hz			1920 x 1080i @ 50Hz 16:9	
1024 x 768 @ 60Hz			1920 x 1080p @ 60Hz 16:9	
1024 x 768 @ 70Hz			1920 x 1080p @ 50Hz 16:9	
1024 x 768 @ 75Hz			1920 x 1080p @ 24Hz 16:9	
1280 x 1024 @ 75Hz			3840 x 2160 @ 24Hz	
1152 x 870 @ 75Hz			3840 x 2160 @ 25Hz	
			3840 x 2160 @ 30Hz	
			4096 x 2160 @ 24Hz	

Digital (HDMI 2.0)

B0 / Established Timing	B0 / Standard Timing	B1 / Video Mode	B1 / Detail Timing
720 x 400 @ 70Hz	1280 x 720 @ 60Hz	720 x 480i @ 60Hz 16:9	1920 x 1080p @ 60Hz
640 x 480 @ 60Hz	1280 x 800 @ 60Hz	720 x 480p @ 60Hz 4:3	
640 x 480 @ 67Hz	1280 x 1024 @ 60Hz	720 x 480p @ 60Hz 16:9	
640 x 480 @ 72Hz	1920 x 1200 @ 60Hz (reduced)	720 x 576i @ 50Hz 16:9	
640 x 480 @ 75Hz	1366 x 768 @ 60Hz	720 x 576p @ 50Hz 4:3	
800 x 600 @ 56Hz		720 x 576p @ 50Hz 16:9	
800 x 600 @ 60Hz		1280 x 720p @ 60Hz 16:9	
800 x 600 @ 72Hz		1280 x 720p @ 50Hz 16:9	
800 x 600 @ 75Hz		1920 x 1080i @ 60Hz 16:9	
832 x 624 @ 75Hz		1920 x 1080i @ 50Hz 16:9	
1024 x 768 @ 60Hz		1920 x 1080p @ 60Hz 16:9	
1024 x 768 @ 70Hz		1920 x 1080p @ 50Hz 16:9	
1024 x 768 @ 75Hz		1920 x 1080p @ 24Hz 16:9	
1280 x 1024 @ 75Hz		3840 x 2160 @ 24Hz	
1152 x 870 @ 75Hz		3840 x 2160 @ 25Hz	
		3840 x 2160 @ 30Hz	
		3840 x 2160 @ 50Hz	
		3840 x 2160 @ 60Hz	
		4096 x 2160 @ 24Hz	
		4096 x 2160 @ 25Hz	
		4096 x 2160 @ 30Hz	

ADDITIONAL INFORMATION

B0 / Established Timing	B0 / Standard Timing	B1 / Video Mode	B1 / Detail Timing
		4096 x 2160 @ 50Hz	
		4096 x 2160 @ 60Hz	

Note: Support 1920 x 1080 @ 50Hz.

Image size and projection distance

Diagonal length (inch) size of 16:9 Screen	Screen Size W x H				Projection Distance (D)			
	(m)		(inch)		(m)		(feet)	
	Width	Height	Width	Height	Wide	Tele	Wide	Tele
30	0.66	0.37	26.15	14.71	0.80	0.80	2.62	2.62
40	0.89	0.5	34.86	19.61	1.06	1.06	3.48	3.48
50	1.11	0.62	43.58	24.51	1.33	1.33	4.36	4.36
60	1.33	0.75	52.29	29.42	1.59	1.59	5.22	5.22
70	1.55	0.87	61.01	34.32	1.86	1.86	6.10	6.10
80	1.77	1	69.73	39.22	2.13	2.13	6.99	6.99
90	1.99	1.12	78.44	44.12	2.39	2.39	7.84	7.84
100	2.21	1.25	87.16	49.03	2.66	2.66	8.73	8.73
120	2.66	1.49	104.59	58.83	3.19	3.19	10.47	10.47
150	3.32	1.87	130.74	73.54	3.98	3.98	13.06	13.06
180	3.98	2.24	156.88	88.25	4.78	4.78	15.68	15.68
200	4.43	2.49	174.32	98.05	5.31	5.31	17.42	17.42

Note: Zoom ratio: 1.0x

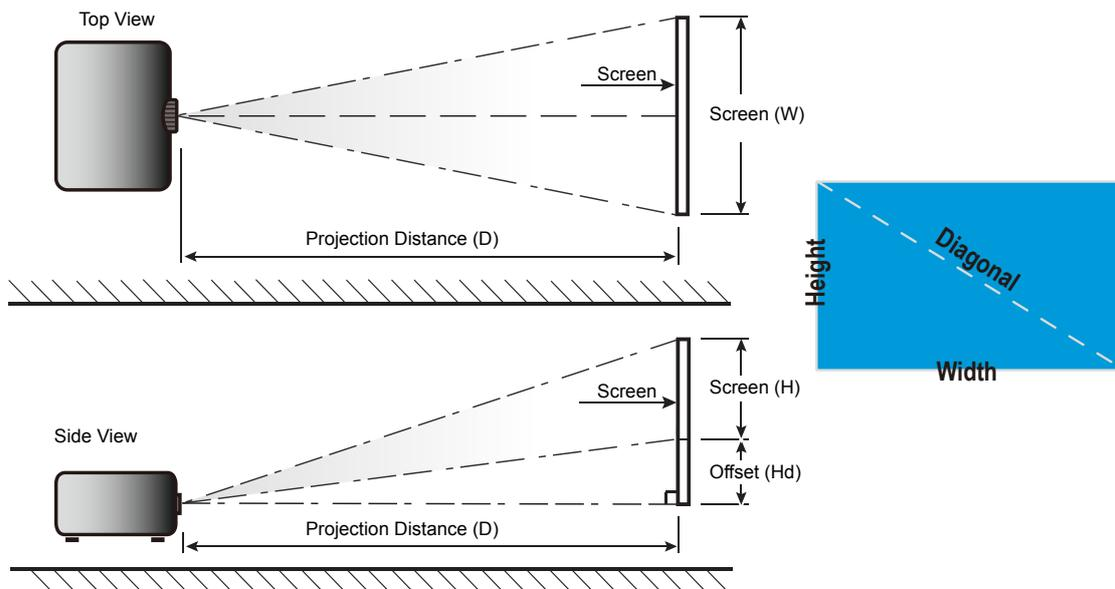

ADDITIONAL INFORMATION

Projector dimensions and ceiling mount installation

1. To prevent damage to your projector, please use the Optoma ceiling mount.
2. If you wish to use a third party ceiling mount kit, please ensure the screws used to attach a mount to the projector meet the following specifications:
 - Screw type: M4*4
 - Minimum screw length: 10mm

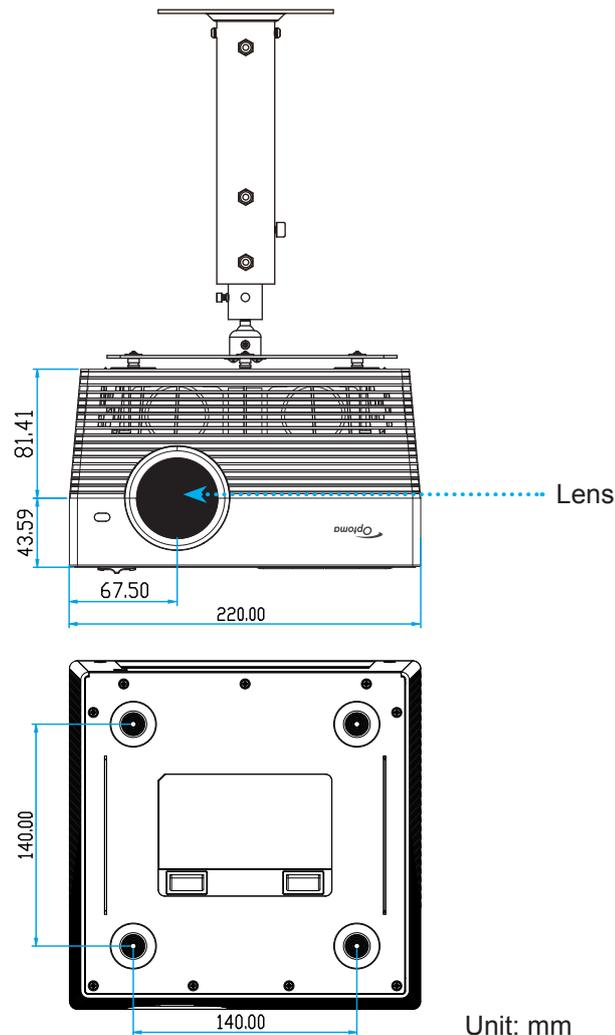

Unit: mm

Note:

- Please note that damage resulting from incorrect installation will void the warranty.
- After removing the four feet, you can install the projector directly to the ceiling mount bracket and secure them using the M4 screws.
- Do not block the speakers. This might affect the overall speaker sound quality.



Warning:

- If you buy a ceiling mount from another company, please be sure to use the correct screw size. Screw size will vary depending on the thickness of the mounting plate.
- Be sure to keep at least 10 cm gap between the ceiling and the bottom of the projector.
- Avoid installing the projector near a heat source.

ADDITIONAL INFORMATION

IR remote codes



Key	Key num	MTX.	Format	Data0	Data1	Data2	Data3	Description	
Power on / off		K12	04	F1	32	CD	71	8E	Refer to the "Powering on / off the projector" section on pages 20-22.
Source		K3	11	F1	32	CD	18	E7	Press to select an input signal.
Home		K13	03	F1	32	CD	92	6D	Press to return to the Home screen.
Menu		K8	17	F1	32	CD	0E	F1	Press to launch the on-screen display (OSD) menu. To exit OSD, press again.
Return		K4	10	F1	32	CD	86	79	Press to return to the previous page.
Up		K7	18	F2	32	CD	11	EE	Use to select items or make adjustments to your selection.
Left		K14	02	F2	32	CD	10	EF	
Right		K5	09	F2	32	CD	12	ED	
Down		K2	19	F2	32	CD	14	EB	
Enter	Enter	K9	16	F1	32	CD	0F	F0	Confirm your item selection.
Mute		K15	01	F1	32	CD	52	AD	Press to turn off/on the projector built-in speaker.
Display Mode		K10	15	F1	32	CD	91	6E	Press to display the Display Mode menu.
Option		K6	08	F1	32	CD	25	DA	Press to configure the projector settings.
Volume -	-	K11	12	F2	32	CD	0C	F3	Press - to decrease the volume.
Volume +	+	K1	05	F2	32	CD	09	F6	Press + to increase the volume.

ADDITIONAL INFORMATION

Bluetooth remote codes



Key	Bluetooth Signal		IR Signal	Description
	Usage Page	Usage ID		
Power on / off		0x07 0x66	71	Refer to the “Powering on / off the projector” section on pages 20-22.
Source		0x07 0x71	18	Press to select an input signal.
Home		0x0C 0x223	92	Press to return to the Home screen.
Menu		0x07 0x76	0E	Press to launch the on-screen display (OSD) menu. To exit OSD, press again.
Return		0x0C 0x224	86	Press to return to the previous page.
Up		0x07 0x52	11	Use to select items or make adjustments to your selection.
Left		0x07 0x50	10	
Right		0x07 0x58	0F	
Down		0x07 0x4F	12	
Enter	Enter	0x07 0x51	14	Confirm your item selection.
Mute		0x0C 0xE2	52	Press to turn off/on the projector built-in speaker.
Display Mode		0x07 0x72/0x70	6A/6B	<ul style="list-style-type: none"> Press to display the Display Mode menu. Press and hold to perform the automatic focus adjustment.
Option		0x07 0x73	25	Press to configure the projector settings.
Volume -		0x0C 0xEA	0C	Press to decrease the volume.
Volume +		0x0C 0xE9	09	Press to increase the volume.

ADDITIONAL INFORMATION

Troubleshooting

If you experience a problem with your projector, please refer to the following information. If a problem persists, please contact your local reseller or service center.

Image problems

- ❓ *No image appears on-screen*
 - Ensure all the cables and power connections are correctly and securely connected as described in the "Installation" section.
 - Ensure the pins of connectors are not crooked or broken.
 - Ensure that the "Mute" feature is not turned on.

- ❓ *Image is out of focus*
 - Adjust the focus using the "FOCUS" button. Please refer to page 17.
 - Make sure the projection screen is between the required distance from the projector. (Please refer to page 60).

- ❓ *The image is stretched when displaying 16:9 DVD title*
 - When you play anamorphic DVD or 16:9 DVD, the projector will show the best image in 16: 9 format on projector side.
 - If you play 4:3 format DVD title, please change the format as 4:3 in projector OSD.
 - Please setup the display format as 16:9 (wide) aspect ratio type on your DVD player.

- ❓ *Image is too small or too large*
 - Move the projector closer to or further from the screen.
 - Press "Menu" on the projector panel, go to "Display Settings → Aspect Ratio". Try the different settings.

- ❓ *Image has slanted sides:*
 - If possible, reposition the projector so that it is centered on the screen and below the bottom of the screen.

- ❓ *Image is reversed*
 - Select "Projector Settings → Projection" from the OSD and adjust the projection direction.

- ❓ *No sound*
 - Please refer to the supported audio file format on page 43.

- ❓ *Abnormal HDMI screen*
 - Select the HDMI EDID setting to 1.4 or 2.2. Please refer to page 37.

ADDITIONAL INFORMATION



Blurry double image

- Make sure “Display Mode” is not 3D to avoid normal 2D image appear blurry double image.



Two images, side-by-side format

- Set the “3D” → “3D Format” to “SBS”.

Other problems



The projector stops responding to all controls

- If possible, turn off the projector, then unplug the power cord and wait at least 20 seconds before reconnecting power.

Remote control problems



If the remote control does not work

- Check the operating angle of the remote control is pointed within $\pm 15^\circ$ (horizontally) or $\pm 10^\circ$ (vertically) to the IR receiver on the projector.
- Make sure there are not any obstructions between the remote control and the projector. Move to within 7 m (~22 ft) of the projector.
- Try to operate the remote control by pointing it to the projected image.
- Make sure battery is inserted correctly.
- Replace battery if it is exhausted.

ADDITIONAL INFORMATION

LED lightning messages

Message	Status LED			
	(Red)	(Green)	(Blue)	(White)
Standby state (Input power cord)	Steady light			
Power on				Steady light
System Boot Status		Steady Light		
Power off (Cooling)				Flashing (0.5 sec off / 0.5 sec on). Back to Red steady light when cooling fan turns off.
Bluetooth Speaker				Steady light
Bluetooth Paring	Flashing (Red 1/6 sec, then Blue 1/6 sec)		Flashing (Red 1/6 sec, then Blue 1/6 sec)	
Standby to Power On				Steady light
Smart Home state (standby)	Steady Light			Flashing (3 sec off / 0.5 sec on)
Error (Lamp Failed)	Flashing (0.5 sec off / 0.5 sec on)			
Error (Fan Failed)	Flashing (0.5 sec off / 0.5 sec on)	Flashing (0.5 sec off / 0.5 sec on)		
Error (Over Temp)	Steady light	Steady light		
USB FW upgrade	Flashing		Steady light	

ADDITIONAL INFORMATION

- Power off:

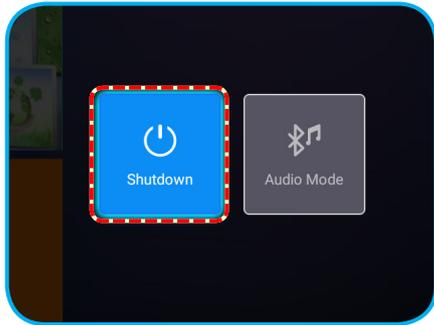

- Temperature warning:

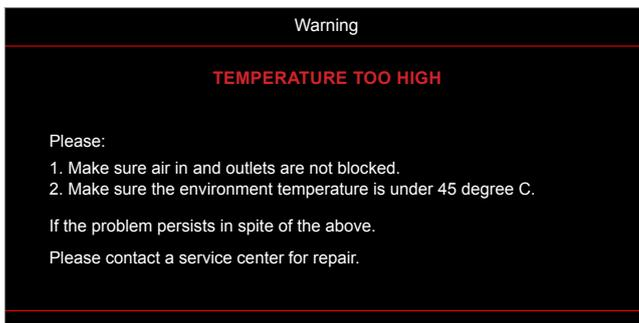

- Fan failed:

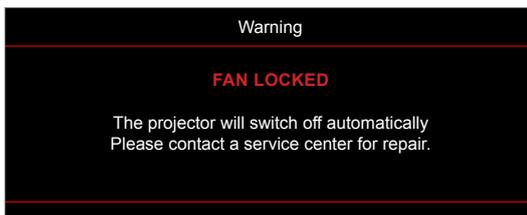

- Power down warning:

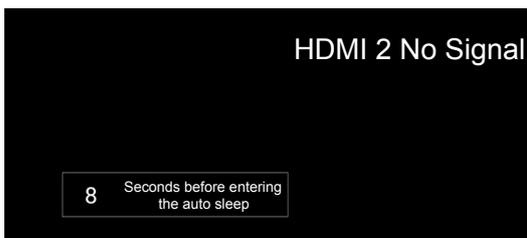

ADDITIONAL INFORMATION

Specifications

Optical	Description
Maximum resolution	- Graphic up to 2160p@60Hz - Maximum Resolution: HDMI1 (2.0): 2160p@60Hz HDMI2 (2.0): 2160p@60Hz
Lens	Fixed Lens
Image size (diagonal)	30" ~ 200"
Projection distance	0.8m ~ 5.3m

Electrical	Description
Inputs	- HDMI V2.0 x2 - USB3.0 (for USB Flash Drive (up to 64GB (NTFS) or Service) - USB2.0 (for USB Flash Drive (up to 64GB (NTFS) or Service) - RJ-45 (not support web control)
Outputs	- Headphone jack - USB3.0 (for Power 5V 1.5A) - USB2.0 (for Power 5V 1A) - SPDIF Out (PCM or Bitstream) Note: <i>PCM supports 2 channels and Bitstream supports 5.1 channel (i.e. Dolby pass through).</i>
Color reproduction	1073.4 Million color
Scan rate	- Horizontal scan rate: 31 ~ 135 KHz - Vertical scan rate: 24 ~ 120 Hz
Built-in speaker	2x 8W speakers
Power requirement	100 - 240V ±10%, AC 50/60Hz
Input current	3.8A-1.0A

Mechanical	Description
Installation orientation	Front, Rear, Front-Ceiling, Rear-Ceiling
Dimensions (W x D x H)	- 220 x 220 x 125 mm (without feet) - 220 x 220 x 135 mm (with feet)
Weight	3.76kg
Environmental conditions	Operating in 5 ~ 40°C , 10% to 85% humidity (non-condensing)

Note: All specifications are subject to change without notice.

ADDITIONAL INFORMATION

Configuring Smart Home with the projector

Creating the Device Cloud account

1. Open a web browser and connect to Optoma Device Cloud login page. Then click **New Account** to create a new account.

Note: Optoma Device Cloud URL: <https://mydevices.optoma.com>.

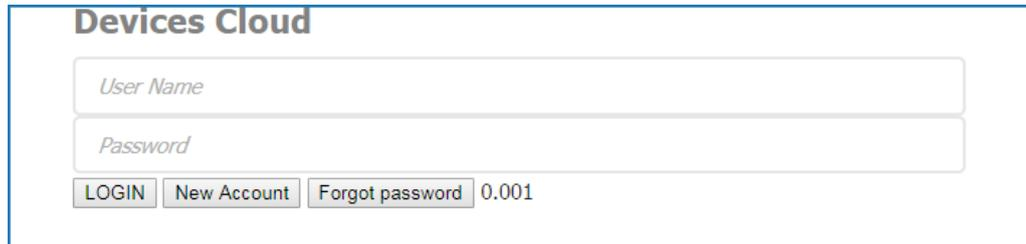

2. Enter the Optoma Device Cloud required account information and enter the authentication code in the *Verify Code* field.

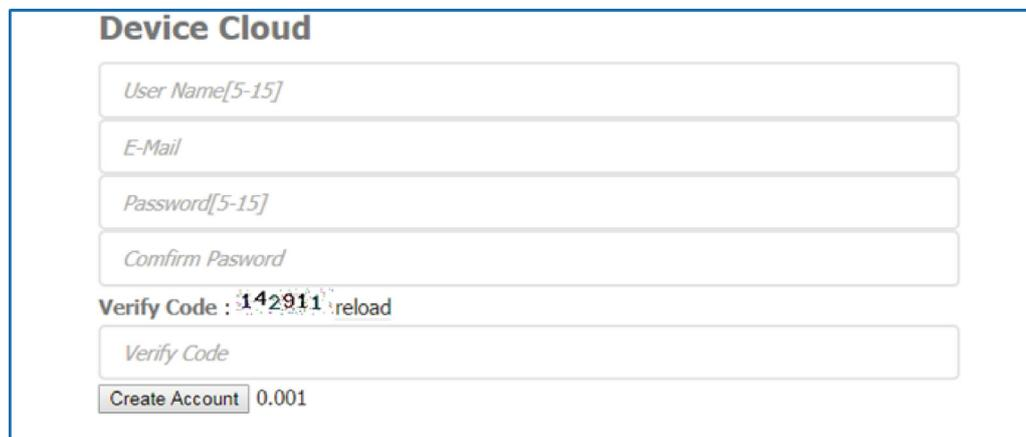

3. Click **Create Account** to create an account. If the account registration is successful, a message will appear on the screen.

Account create successfully.
Click to Login

Once your account is set up, you can continue to log in to the system.

ADDITIONAL INFORMATION

Registering the projector to Device Cloud

1. Open a web browser and connect to Optoma Device Cloud login page. Then enter your user name and password, and click **LOGIN** to enter to the system.

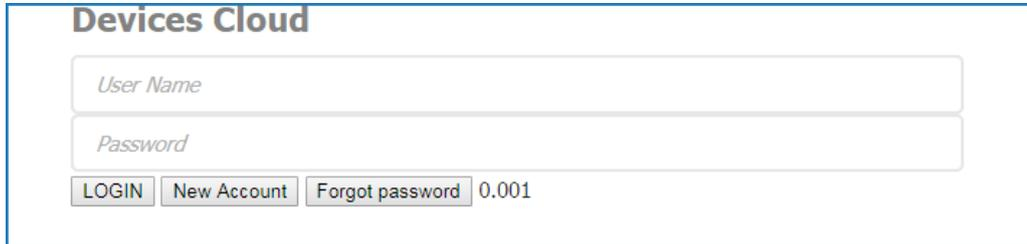

2. Click **Add** to add the new projector information. The following step requires the **Pair Code** data. Make sure to remain in this page and perform the following projector settings.

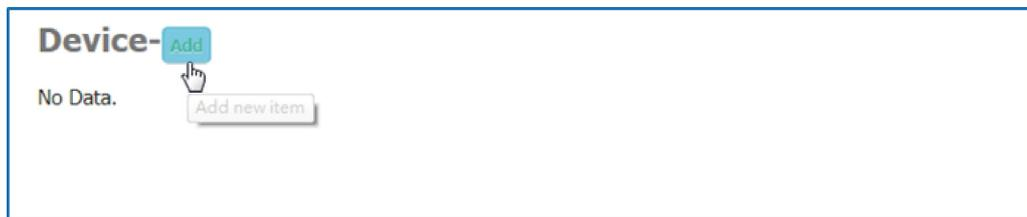

3. On the projector, go to **Application > Smart Home**.

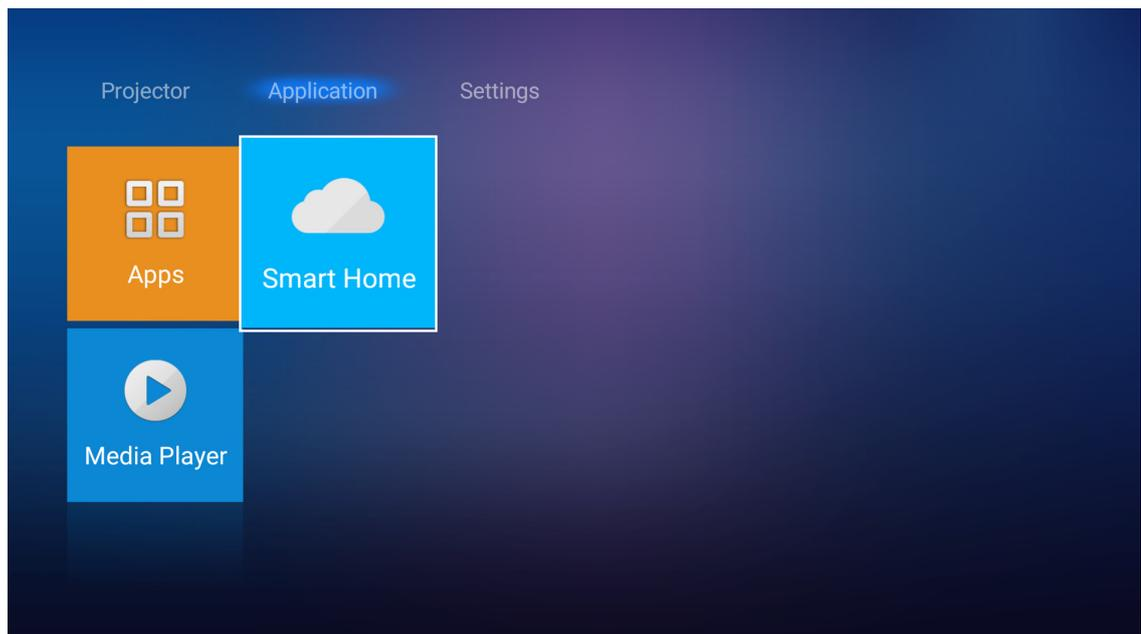

ADDITIONAL INFORMATION

- Click **Register** to oBluetoothain the 4-digit pair code from the Device Cloud. After the pair code is generated, it will appear on the **Show Pair Code** field.

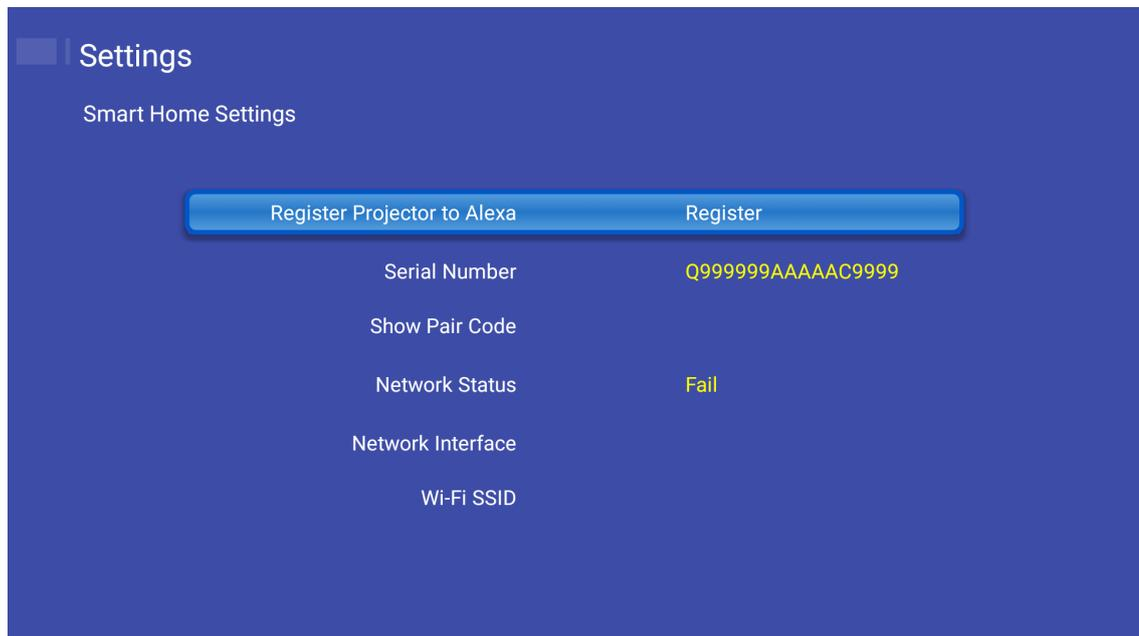

Note: If the pair code does not appear, please check if there is a proper network connection and repeat the above steps again.

- On the *Device Cloud* page, enter the serial number, pair code, and projector name on its respective field. Then click **Submit** to register the projector.

The 'Add new Device' form has a 'Submit' button and a 'Back' button. Below the buttons, it says 'The fields of bule are need fill data.' There are three input fields: 'Serial Number:', 'Pair Code:', and 'Alias:'.

Note:

- The serial number and pair code information can be oBluetoothained from the *Smart Home Settings* page (see *Step 4*).
 - The data of the "Alias" field can be changed later.
- Once the registration process is complete, the serial number and projector name appear on the *Device* page.



ADDITIONAL INFORMATION

To edit the information, do the following:

- Click **Alias** to change the projector name.
- Click **Remove** to delete the serial number.

Enabling Alexa Skills

1. Open a web browser and go to Amazon website ("https://alexa.amazon.com"). Then log in using your Alexa account.

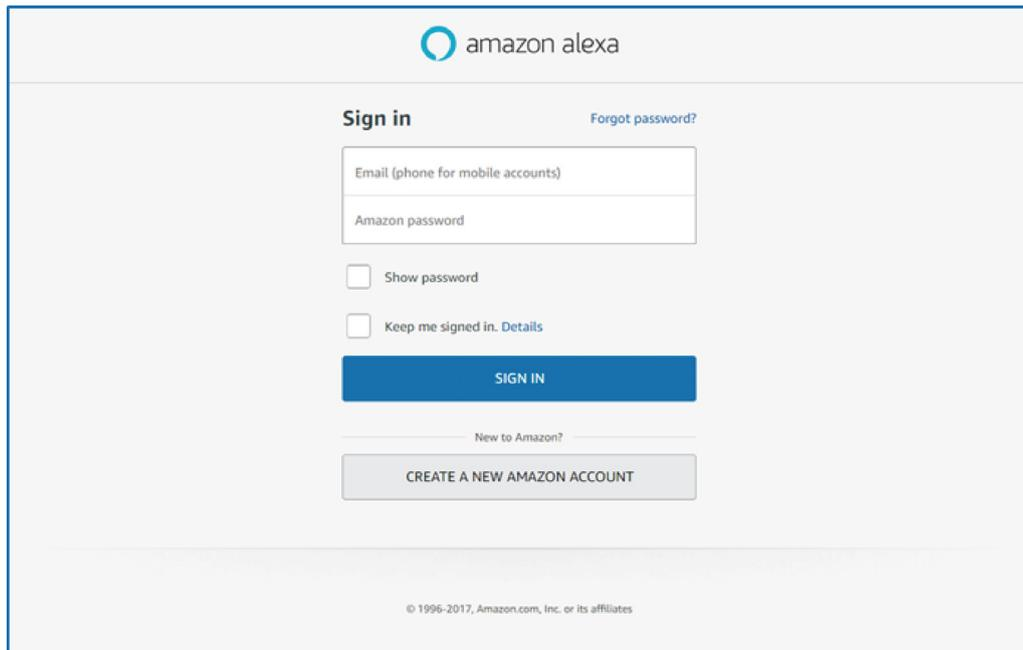

2. Go to the menu and select **Skills**. Then enter the keyword (i.e. Optoma, Projector, Smarthome, Smart home, Smartprojector, projector, UHD51A, UHD400X, UHD41A, Display, Voice) in the search text box and click Search (🔍).

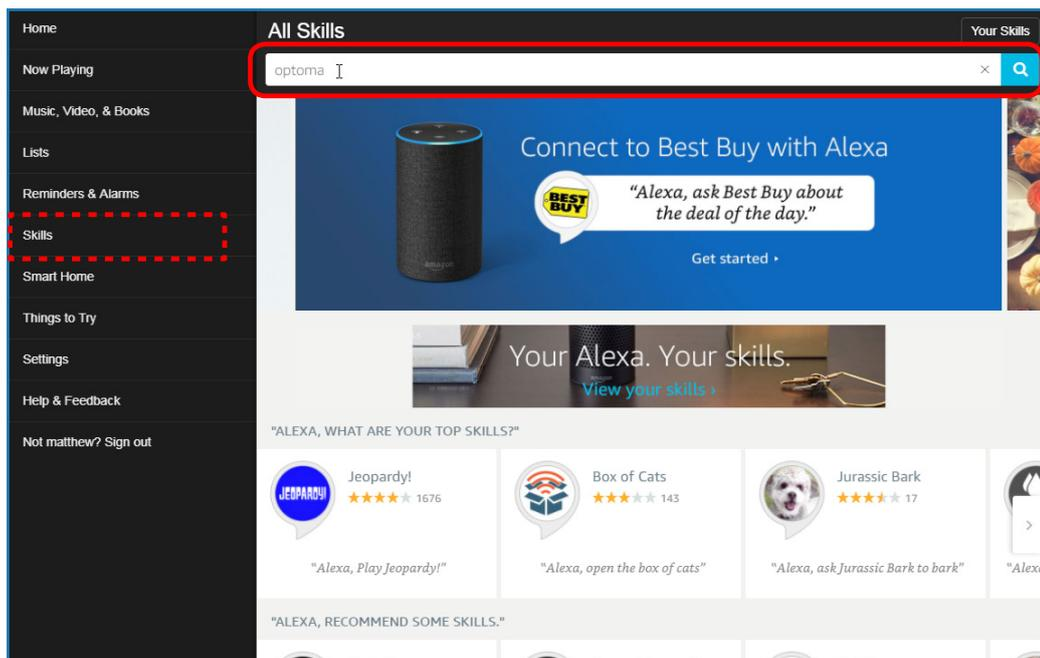

ADDITIONAL INFORMATION

3. Select a skill you want to use from the list.

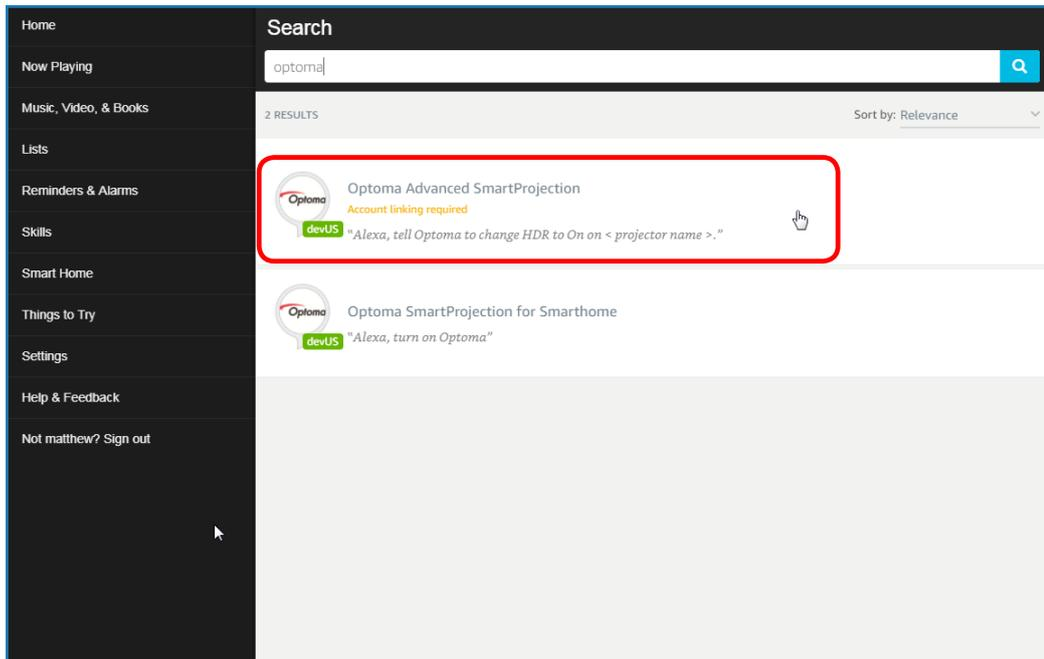

4. On the selected skill page, click **ENABLE** to use the skill.

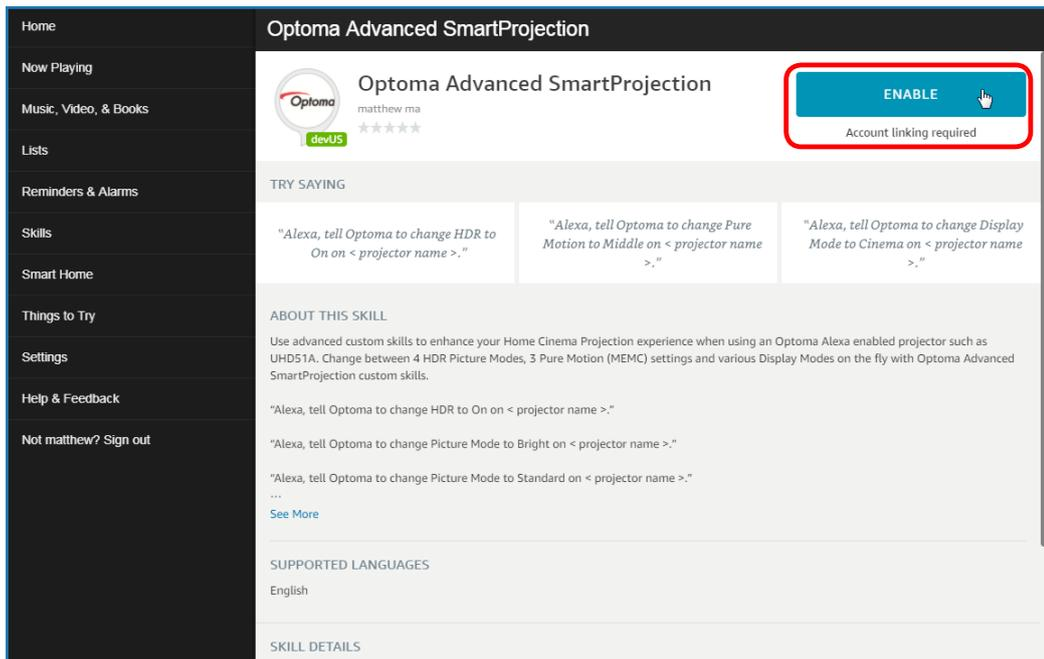

ADDITIONAL INFORMATION

5. The browser will then be directed to the Device Cloud account authentication page. Enter the Device Cloud account and password you want to authenticate. Then click **Login** to verify your account.

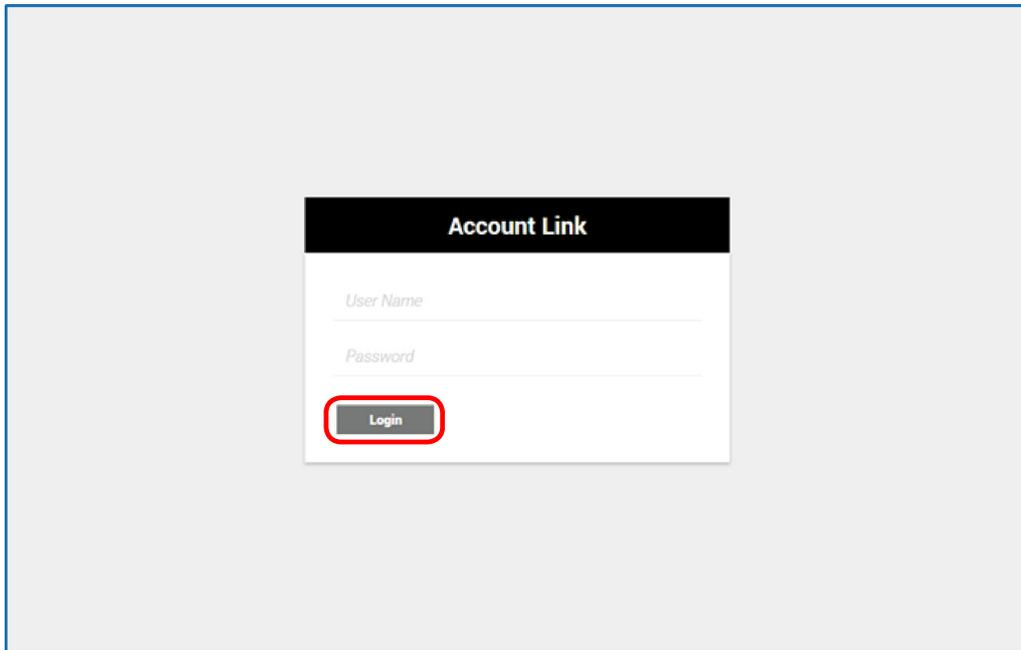

6. After the authentication process is complete, the subsequent steps will vary depending on the selected skill type: Smart Home Skill or Custom Skill.

Smart Home Skill

- a. After the authentication process is complete, close the window to discover the devices you can control with Alexa.

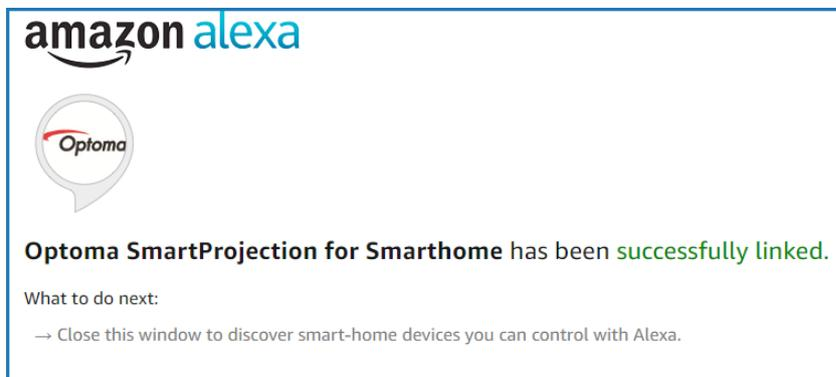

- b. A pop-out window appears on the screen. Click **DISCOVER DEVICES** to detect the Smart Home devices.

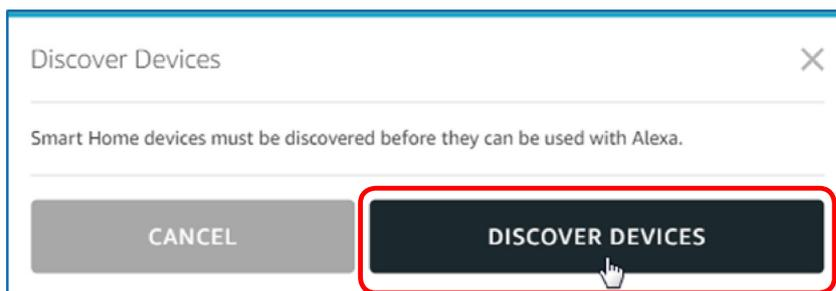

ADDITIONAL INFORMATION

c. Searching for Smart Home devices.

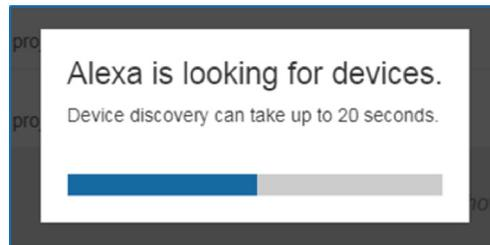

d. Under your Device Cloud account, the list of the discovered devices will be displayed on the **Devices** page.

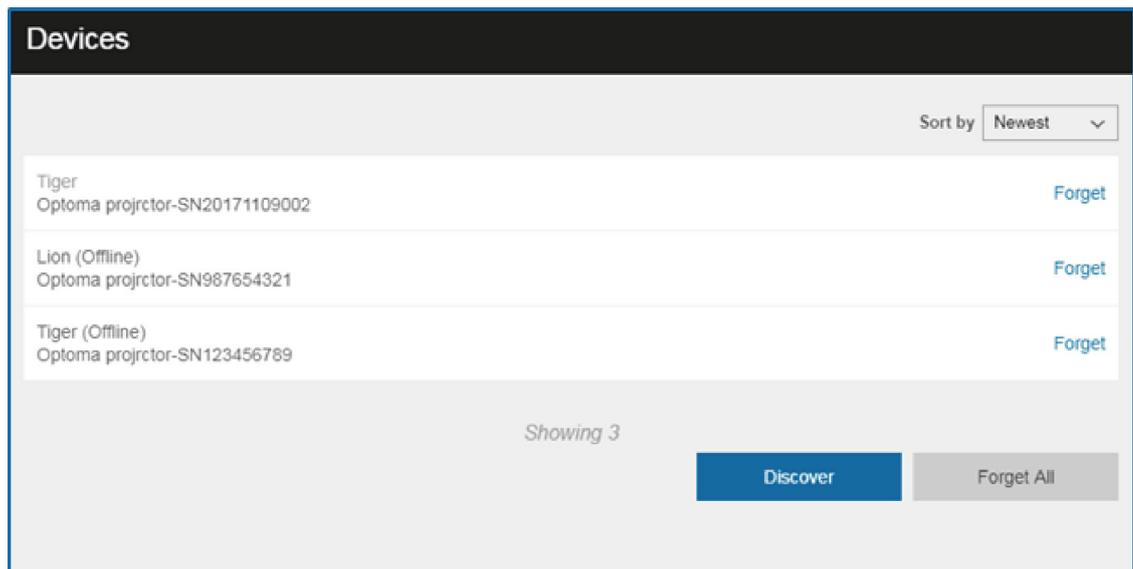

e. Now you can control the Smart Home devices using the voice commands.

Custom Skill

a. After the authentication process is complete, the *Custom Skill Linking Successful* message will appear on the screen. Then you can close the window and web page.



b. Now you can control the device using the voice commands defined by the Custom Skill.

ADDITIONAL INFORMATION

Optoma global offices

For service or support, please contact your local office.

USA

47697 Westinghouse Drive,
Fremont, CA 94539, USA
www.optomausa.com

 888-289-6786
 510-897-8601
 services@optoma.com

Canada

47697 Westinghouse Drive,
Fremont, CA 94539, USA
www.optomausa.com

 888-289-6786
 510-897-8601
 services@optoma.com

Latin America

47697 Westinghouse Drive,
Fremont, CA 94539, USA
www.optomausa.com

 888-289-6786
 510-897-8601
 services@optoma.com

Europe

Unit 1, Network 41, Bourne End Mills,
Hemel Hempstead, Herts,
HP1 2UJ, United Kingdom
www.optoma.eu
Service Tel : +44 (0)1923 691865

 +44 (0) 1923 691 800
 +44 (0) 1923 691 888
 service@tsc-europe.com

Benelux BV

Randstad 22-123
1316 BW Almere
The Netherlands
www.optoma.nl

 +31 (0) 36 820 0252
 +31 (0) 36 548 9052

France

Bâtiment E
81-83 avenue Edouard Vaillant
92100 Boulogne Billancourt, France

 +33 1 41 46 12 20
 +33 1 41 46 94 35
 savoptoma@optoma.fr

Spain

C/ José Hierro,36 Of. 1C
28522 Rivas VaciaMadrid,
Spain

 +34 91 499 06 06
 +34 91 670 08 32

Deutschland

Wiesenstrasse 21 W
D40549 Düsseldorf,
Germany

 +49 (0) 211 506 6670
 +49 (0) 211 506 66799
 info@optoma.de

Scandinavia

Lerpeveien 25
3040 Drammen
Norway

 +47 32 98 89 90
 +47 32 98 89 99
 info@optoma.no

PO.BOX 9515
3038 Drammen
Norway

Korea

WOOMI TECH.CO.,LTD.
4F, Minu Bldg.33-14, Kangnam-Ku,
Seoul,135-815, KOREA
korea.optoma.com

 +82+2+34430004
 +82+2+34430005

Japan

東京都足立区綾瀬3-25-18
株式会社オーエス
コンタクトセンター:0120-380-495

 info@os-worldwide.com
www.os-worldwide.com

Taiwan

12F., No.213, Sec. 3, Beixin Rd.,
Xindian Dist., New Taipei City 231,
Taiwan, R.O.C.
www.optoma.com.tw

 +886-2-8911-8600
 +886-2-8911-6550
 services@optoma.com.tw
asia.optoma.com

Hong Kong

Unit A, 27/F Dragon Centre,
79 Wing Hong Street,
Cheung Sha Wan,
Kowloon, Hong Kong

 +852-2396-8968
 +852-2370-1222
www.optoma.com.hk

China

5F, No. 1205, Kaixuan Rd.,
Changning District
Shanghai, 200052, China

 +86-21-62947376
 +86-21-62947375
www.optoma.com.cn



P/N:36.7DE01G002-A