

SAMSUNG

Galaxy Watch Active



User manual

Table of contents

Device features	1
Work out in the water	1
Goodnight mode	1
Water and dust resistances	1
Get started	2
Device Layout	3
Assemble your device	4
Wear the Watch	5
Start using your device	7
Galaxy Wearable app	7
Lock or unlock your device	8
Navigation	9
Change the watch face	9
Status panel	14
Notifications	15
Water lock mode	17
Do not disturb	17
Theater mode	17

Goodnight mode	18
Apps	19
Using apps	20
Access apps	20
Auto open apps	20
Sort apps	20
App permissions	20
Recent apps	21
Hide apps	21
Uninstall apps	21
Samsung apps	22
Messages	22
Phone	24
Contacts	25
Bixby	26
Samsung Health	27
Galaxy Apps	33
Weather	33
Alarm	34

Calendar	34
Reminder	35
Email	36
Music app	37
Gallery	38
Find My Phone	40
World clock	41
Additional apps	42
Spotify	42
Settings	43
Access Settings	44
Connections	44
Bluetooth	44
Wi-Fi	44
NFC	45
Connection alerts	45
Airplane mode	46
Location	46
Connect to a new phone	46

Vibration	46
Vibration intensity	46
Long vibration	47
Ringtone vibration	47
Notification vibration	47
Display	47
Watch faces	47
Adjust screen brightness	48
Set the screen timeout	48
Show last app	48
Background style	48
Font style	48
Font size	48
Device maintenance	49
Date and time	49
Power saving mode	49
Watch only mode	50
Reset the Watch	50
Watch status	50

Lock screen and security	51
Set a screen lock	51
Remote security	51
Accessibility	52
Visibility enhancements	52
Advanced settings	52
Text to speech	53
Other settings	53
Custom shortcut	53
Wake-up gesture	53
Touch sensitivity	54
Watch info	54
Learn more	55
Videos	55
Tips	55
Smart Simulator	55
Samsung Care	55
Talk to an agent	55

Legal information	56
Intellectual property	56
Open source software	57
Disclaimer of warranties; exclusion of liability	57
Modification of software	58
Samsung Knox	58
Maintaining water and dust resistance	58
Restricting children’s access to your mobile device	59
Samsung Electronics America, Inc.	60

Device features

Meet Bixby

Bixby responds to your voice commands and can help you understand your settings and set up your Samsung device. For more information, see [Bixby](#) on page 26.

Work out in the water

Use Water lock mode when you exercise in the water. See [Water lock mode](#) on page 17.

Goodnight mode

Goodnight mutes all alerts, except for alarms and notifications. For more information, see [Goodnight mode](#) on page 1

Water and dust resistances

This device is rated 5ATM, and passed military specification (MIL-STD-810G) testing. See [Maintaining water and dust resistance](#) on page 58.

Get started

Device Layout

Assemble your device

Start using your device



Device Layout



Assemble your device

Learn more about your device hardware, assembly procedures, and how to get started using your new device.



⚠ WARNING Do not disassemble, modify, or repair your device. Placing objects, such as magnetic stripe cards, including credit cards, phone cards, passbooks, and boarding passes, next to the device or charger may cause damage from the charger or device's magnetic field.

⚠ CAUTION The charging head for plugging the USB cable into a wall outlet is not included. Use only Samsung charging devices rated with an output voltage of [5v] and an output current of over [150mA] (sold separately). Samsung accessories are designed for your device to maximize battery life. Using other accessories may void your warranty and may cause damage.

While charging, the device and the charger may become hot. This does not affect the device's lifespan or performance and is in the device's normal range of operation.

The charger may stop charging if the battery becomes too hot.

If the device heats up while charging the battery:

1. Disconnect the charger from the device and close any running apps.
2. Wait for the device to cool down and then begin charging the device again.

 **NOTE** Prevent the USB charger port and the small end of the charger from coming into contact with conductive materials, such as liquids, dust, metal powders, and pencil leads.

Wear the Watch

Wear the Watch firmly around your lower arm just above your wrist as shown below. Do not fasten the Watch too tightly.

1. Open the buckle and place the strap around your wrist.
2. Fit the strap to your wrist, insert the pin into an adjustment hole, and then secure the buckle to close it.

 **WARNING** Wear the Gear or device correctly. If you feel discomfort while using the device, stop using it. If your device becomes hot, please remove it until it cools.

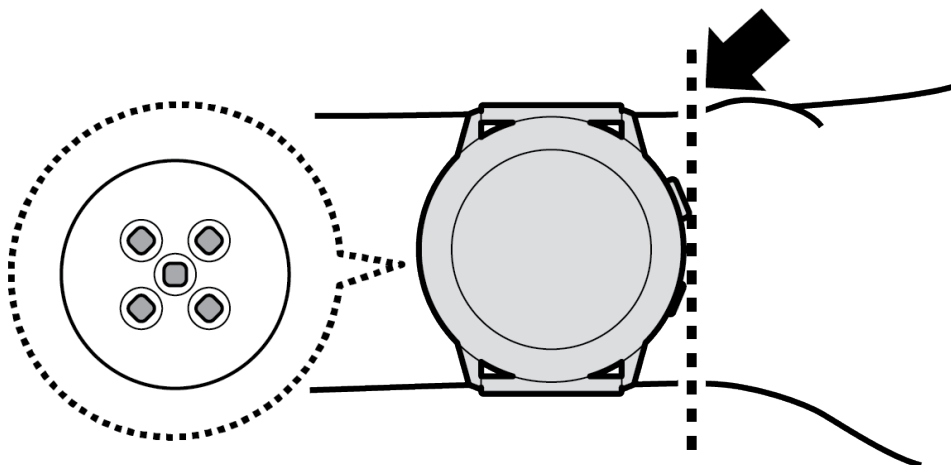

Strap tips and precautions

- Some people may experience discomfort when wearing the Watch for prolonged periods.
- If you have sensitive skin or fasten the Watch too tightly, you may feel some discomfort.
- Do not expose the straps to very wet conditions. Wet straps can cause skin irritations. Dry the straps first. If you experience skin irritation when wearing the device, stop wearing the device and consult a physician.

Replace the strap

Detach the strap from the Watch to replace it with a new one.

To remove the strap:

- Slide the strap's spring bar inwards and pull the strap away from the Watch.

To replace the strap:

- Insert one end of the spring bar into the lug, slide the spring bar inwards, and connect the new strap.

Start using your device

The instructions below explain how to turn your device on or off.

To turn the device on:

- Press and hold the **Power** button until the device turns on.

To turn the device off:

1. Press and hold the **Power** button.
2. Tap **Power off**.



Galaxy Wearable app

To connect your Watch to a smartphone, install the Galaxy Wearable app on the smartphone. You can download the app from Galaxy Apps, or the Google Play™ store.

Compatible with select devices using Android 5.0 and later, with at least 1.5 GB RAM. Supported devices may vary by carrier and device. Some features may not be available. For best results, connect with compatible Samsung Galaxy devices. Visit samsung.com/us/support/owners/app/galaxy-wearable-watch for a list of compatible smartphones.

Connect the Watch to a smartphone

Turn on the Watch.

1. From the Apps screen of the smartphone, tap  **Galaxy Wearable**.
2. If necessary, update the app to the latest version.
3. Tap **Start the Journey**, and follow the prompts to select your device.
4. When the Bluetooth® pairing request window is displayed, confirm the passkeys displayed on your Watch and smartphone match, and then tap  **OK**.
5. Follow the prompts to complete the connection.

When the devices are connected, a tutorial is displayed on the Watch's screen. Follow the prompts to learn basic controls.

Connect the Watch to a new smartphone

When you connect the Watch to another smartphone, the Watch automatically resets and all data is removed from its memory. Make sure you back up any important data stored on your Watch.

Back up your Watch's data on your smartphone as follows:

1. From  **Galaxy Wearable**, tap the **Home** tab.
2. Tap **Account and backup** > **Back up and restore** > **Backup settings**.

Remote connection

Set the Watch to remotely connect to the smartphone when a Bluetooth connection between the devices is not available. With this connection, you can still receive notifications from your smartphone.



To enable or disable this feature:

1. From  **Galaxy Wearable**, tap the **Home** tab.
2. Tap **Account and backup** > **Remote connection**.



NOTE The Watch and smartphone must be connected to the same wi-fi network in order to receive notifications and calls.

Disconnect

1. From  **Galaxy Wearable**, tap the **Home** tab.
2. Tap  **Menu** > **Disconnect**, and confirm when prompted. The Watch disconnects from your smartphone.

Lock or unlock your device

Use the screen lock features to secure your device. Your Watch locks when you remove it from your wrist or when the screen times out while you are wearing it.

To unlock the Watch:

- Press the **Power** button or **Back** button.

The default Screen lock on your device is None. To choose a secure screen lock, see **Set a screen lock** on page 51.

Navigation

Please note that a touchscreen responds best to a light touch from the pad of your finger or a capacitive stylus. Using excessive force or a metallic object on the touchscreen may damage the tempered glass surface and void the warranty.

Tap

Lightly tap the screen to launch an app, select a menu item, or press a button.

Double-tap

Lightly tap an image twice to zoom in and out.

Touch and hold

Touch and hold items to access edit mode or view available options.

Swipe

Lightly drag your finger vertically or horizontally across the screen to view panels.

Drag

Touch and hold an item, and then move it to a new location.

Change the watch face

From the Watch:

1. Touch and hold the Watch screen, and then swipe to view available watch faces.
 - You can add more watch faces from Galaxy Apps.
2. Touch and hold the watch face to select it.
 - You can customize the watch face by tapping **Customize**.

From the smartphone:

1. From  **Galaxy Wearable**, tap the **Watch faces** tab.
2. Tap a desired watch face. The watch face you selected is applied on the Watch screen.
3. Tap **Customize** to select a background and items to display on the watch face.

Widgets

You can add widgets to the Home screens. Widgets are small apps that offer limited functionality to provide information and convenient access.

Add Widgets

To add more widgets on the Home screen:

1. Swipe to the end of the Widget screens, and tap **Add widget**.
2. Select a widget.

The selected widget is displayed in a new panel.

Move Widgets

- Touch and hold a widget and then drag it to the desired location.

Remove Widgets

- Touch and hold a widget, and then tap  **Remove**.

Enter text

Text can be entered by speaking or by using a keyboard.

A text input screen is displayed automatically when you are able to enter text. Select an emoji or text template to enter a message. You can also use voice input or the keyboard to type texts.







Default keyboard

Select a default keyboard type for text input.

- From  **Settings**, tap **General** > **Input** > **Default keyboard** and select your default keyboard.

Voice input

Instead of typing your text, you can speak it.

- From the keyboard, tap  **Voice input** and speak the message you want to enter. Tap **Send** when you are finished.
 - Tap  **More options** > **Input languages** to change the language. Voice input is not supported in some languages.
- From the keyboard, tap  **Voice input** and speak the message you want to enter. Tap **Send** when you are finished.
 - Tap  **More options** > **Input languages** to change the language. Voice input is not supported in some languages.

Emojis

You can add emojis to your message.

- From the keyboard, tap  **Emojis**, and select an emoji to include in your message.
 - To draw an image, tap **Doodle**.

Keyboard

Use the keyboard to enter your message.

- Tap  **Keyboard**, and then use your finger to write text, or swipe right to view the keyboard mode options.

Keyboard settings

Change the Samsung keyboard settings.

- From  **Settings**, tap **General** > **Input** > **Keyboard settings**, and tap options to customize:
 - **English (US)**: Choose the keyboard layout.
 - **Select input languages**: Select languages for text input.
 - **Check for updates**: Set the Watch to check for and download the latest version of the Samsung keyboard.

- **Handwriting:** Enable handwriting mode.
- **Smart typing:** Customize features like predictive text, auto capitalize, and auto punctuate.
- **Key-tap feedback:** Set the watch to vibrate when you tap a key on the keyboard.
- **Reset keyboard settings:** Return your keyboard to the default settings.
- **Clear personalized data:** Remove word predictions and other personalized data.

Status panel

To open the Status panel:





- On the Watch screen, swipe down from the top of the screen.



Status Bar

Indicator icons display at the top of the screen in the Status bar.

Indicator icons

-  Battery full
-  Bluetooth connected
-  Bluetooth enabled but not connected
-  Bluetooth headset connected
-  Wi-Fi connected

Quick settings

You can quickly access settings through the status panel.

- Tap a quick setting to open it.
- Touch and hold a quick setting to edit the placement, remove a setting, or add a new setting.



TIP You can also edit quick settings from  **Settings** > **Advanced** > **Edit quick settings**.

Notifications

Stay up to date with events, notifications, and messages from your smartphone.

When you receive a notification, information about the notification, such as its type, is displayed on the screen while the Watch is vibrating.

- From the Watch screen, swipe left and tap a notification to view details.

View the notifications list

To view a list of notifications from the same app:

1. From the Watch screen, swipe left to view notifications.
2. Tap the number at the bottom of the notification.

Clear all notifications

To clear all notifications:

1. From the Watch screen, swipe right to view notifications.
2. Swipe right to the end of the notifications screens, and then tap **Clear all**.

Block notifications



To block notifications from an app:

1. From the Watch screen, swipe right to view notifications.
2. Tap a notification from the app that you want to block.

3. Tap the notification to view the details.
4. Tap  **More options** > **Block notifications**.

Notification settings

Change settings for the notification feature.

1. From the Apps screen of the smartphone, tap  **Galaxy Wearable** > **Home** tab > **Notifications**.
2. Tap  to activate it, and then tap to select items:
 - **Manage notifications:** Select apps on the smartphone to send notifications to the Watch.
 - **Show only while wearing watch:** Show notifications on your Watch only while it is being worn.
 - **Mute connected phone:** Mute notifications on your phone while receiving them on your Watch.
 - **Auto show details:** Set the Watch to show details for notifications when they are received.
 - **Notification indicator:** Show an indicator the watch face when there are unread notifications.
 - **Turn on screen:** Set the Watch to turn on the screen when the notification is received.
 - **Show while using phone:** Show notifications from your phone on your Watch while you are using your phone.
 - **Smart relay:** Set the smartphone to display notification information from the Watch when you pick up the smartphone.

Water lock mode

You can use Water lock mode to exercise in the water. While in Water lock mode touchscreen, wake-up gestures, and watch always on will be disabled.

- From  **Settings**, tap **Advanced** > **Water lock mode**, and tap  to enable this feature.



 **TIP** You can also access Water lock mode from quick settings.

Exit water lock mode

- Press and hold the **Home** button for two seconds to turn off the mode.



Do not disturb

Use these options to determine block out time where notifications are turned off, and during which time periods you want to enter this mode.

- From  **Settings**, tap **Advanced** > **Do not disturb**, and tap  to enable an option:
 - **Turn on now:** Enable this option, and set the time period.
 - **Turn on as scheduled:** When you select this option, tap **Set schedule** to configure the start time, end time, and days that you want to enable Do not disturb.

Theater mode



You can use Theater mode to silence your Watch during a movie. This will keep the screen off and the Watch silent.

- From  **Settings**, tap **Advanced** > **Theater mode**, and tap  to enable this feature.

 **NOTE** When enabled, the theater mode symbol will display at the top of the screen.

Goodnight mode

Goodnight mutes all alerts, except for alarms and notifications. This keeps the screen off and the Watch silent while you sleep.

- From  **Settings**, tap **Advanced** > **Goodnight mode**, and tap  to enable this feature.

 **TIP** You can also access Goodnight mode from quick settings.

Apps

Using apps

Samsung apps

Additional apps



Using apps

The Apps list displays all preloaded and downloaded apps. Apps can be downloaded from Galaxy Store and the Google Play store.

Access apps

The Apps screen displays icons for all apps.

1. From the Watch screen, press the **Home** button to go to the Apps screen.
2. To view other panels, swipe the screen to the left or right.

Auto open apps

Set an app to launch without tapping the app. When the indicator icon hovers over an app, the app will be launched automatically.

- From  **Settings**, tap **Apps** > **Auto open apps** to enable this feature.

Sort apps

Choose how to arrange the apps on the Apps screen.

- From  **Settings**, tap **Apps** > **App order**, and choose an option:
 - **Most recent first:** Recently used apps to appear first.
 - **Custom:** Arrange the apps to your preference.
 - From the Apps screen, touch and hold an app, and then drag it to the desired location.

App permissions

Configure permissions for each installed app.



1. From the Apps screen, and tap  **Settings**.
2. Tap **Apps** > **Permissions**.
3. Tap an app to view its permissions. Tap each feature to enable or disable permission to access or use the feature.

Recent apps

- From the Apps screen, tap  Recent apps.

Hide apps

You can hide apps that you do not want to see on your Watch.

1. From  Galaxy Wearable on your phone, tap the Home tab > Apps.
2. Tap  More options > Hide.
3. Tap the apps you want to hide, and then tap Apply.

Uninstall apps

Uninstall apps you have download.

1. From Apps, touch and hold an app.
2. Tap  Uninstall. This option is not available for all apps.



Samsung apps

The following apps come pre-installed or downloaded over-the-air to your device.

Messages



View messages and reply to or call the sender using the Watch.

Send messages

1. From Apps, tap  Messages.
2. Tap  Compose.
3. Add recipients and tap **Next**.
4. Enter text using one of the available methods.
 - If you use Quick responses or emojis, the message is automatically sent to the recipients when you tap it.
 - If you create a message using voice input or the keyboard, tap **Send** to send the message.

Edit Quick messages

Edit or add templates used for replying to messages.

1. From  Galaxy Wearable, tap the **Home** tab > **Apps**.
2. Tap **Settings** next to Messages.
 - To edit a message, select it and edit the text.
 - To create additional templates, tap  **Add**.
 - To uninstall or rearrange messages, tap  **Edit**.

Send audio recordings



Change the message feature settings.

1. From  **Settings**, tap **Apps** > **Messages**.
2. Tap **Send as audio** to set the Watch to send a voice message as an audio file.



Send SOS requests

In an emergency situation, quickly press the Watch's **Home** button three times. The device sends messages to your emergency contacts. The first time you enable this feature, you will be prompted to designate your emergency contacts.

The messages include your location information. You can also send sound recordings along with the message to the recipients.

1. From  **Galaxy Wearable**, tap the **Home** tab > **Send SOS requests**.
2. Tap  to enable this feature, and then customize options:
 - **Send SOS messages to:** Follow the prompts to add an emergency contact to send SOS messages to.
 - **Count down before sending:** Wait five seconds before sending SOS requests to allow them to be canceled.

Read messages

1. From  **Messages**, tap a conversation to view it.
2. Tap  **More options** for additional options:
 - **Call:** Call the sender.
 - **Send my location:** Use your GPS to send a map link to your location.
 - **Show on phone:** View the message on your smartphone.
 - **Add to contacts:** Add the sender as a contact.
 - **Delete:** Delete the message.

 **NOTE** You may not be able to reply to messages depending on the smartphone that you connect to the Watch.





Reply to messages

1. From  **Messages**, tap a conversation to view it.
2. Tap an icon or a quick reply to compose and send your message.



Make calls

The call feature automatically launches on your smartphone.

1. From the Apps screen, tap  **Phone**.
2. Use one of the following methods to make a call:
 - Tap  **Keypad**, enter a number using the keypad, and then tap  **Call**.
 - Tap  **Contacts**, select a contact, and then tap  **Dial** or select a phone number.
 - Scroll through the log list, and tap a log entry.

Answer calls

To answer an incoming call:

- Drag  **Answer** to the right.

Reject a call

Reject incoming calls.

- Drag  **Reject** to the left.



Decline with Message

Reject an incoming call and send a message to the caller.

- Swipe up from the bottom of the screen to open the Decline messages, and select a quick message.

Edit decline messages

Edit or add templates used for rejecting phone calls.

1. From  Galaxy Wearable, tap the **Home** tab > **Apps**.
2. Tap **Settings** next to Phone.
 - To edit a message, select it and edit the text.
 - To create additional templates, tap  **Add**.
 - To delete or rearrange messages, tap  **Edit**.

Missed calls

If a call is missed, a notification is displayed on the screen.



- From the Watch screen, swipe right to view missed call notifications, or on the Apps screen, tap  **Phone** to view missed calls in the Call log.

Contacts

View your smartphone's contact list.



Create a contact

You can search for a contact or scroll through the list to find one by name.

1. From the Apps screen, tap  **Contacts**.
2. Tap  **Add**, and then enter the contact information.
3. Tap **Save**.

Find a contact

You can search for a contact or scroll through the list to find one by name.

- From  **Contacts**, tap  **Search**, and then enter characters to find contacts that match.

Call or message a contact

You can send a message or make a phone call from Contacts.

- From  **Contacts**, tap the contact you want to connect with, and tap an option:
 - **Call:** Begin a phone call with the contact.
 - **Message:** Type a message to the contact.





Bixby is a voice service that helps you use your Watch more conveniently. You can talk to Bixby to launch a function or provide you with information.

1. From Apps, tap  **Bixby**.
2. Follow the prompts to set up Bixby.

 **NOTE** To use Bixby, your mobile device must be connected to a Wi-Fi or mobile network, and you must sign in to your Samsung account.

Enable voice launch

You can launch Bixby using your own voice wake-up command. You can only use this feature when your Watch's screen is turned on.

- From  **Bixby**, tap  **More options** > **Voice wake-up** to enable this feature.

Change the language

Change the speech recognition language.

- From  **Bixby**, tap  **More options** > **Language**, and then choose a language.

Use Bixby

To launch Bixby for voice commands:

- Quickly press the **Home** button twice, or say "Hi Bixby."



Samsung Health helps you manage your wellness and fitness. Set fitness goals and regularly record and check your progress.

When the Watch is synced with the Samsung Health app, you can save and manage health-related data and receive useful information about your health every day.

Only your most recent activity records are stored on your Watch. You can view previous data on the smartphone where the Samsung Health app is installed.

○ From the Apps screen, tap  **Samsung Health**.

 **CAUTION** The information gathered from this device, Samsung Health, or related software is not intended for use in the diagnosis of disease or other conditions, or in the cure, mitigation, treatment or prevention of disease.

The accuracy of the information and data provided by this device and its related software, including heart rate readings, may be affected by factors such as environmental conditions, skin condition, specific activity performed while using/wearing the device, settings of the device, user configuration/user-provided information, placement of the sensor on the body, and other end-user interactions. For more information on proper wear and use, visit samsung.com/us/heartratesensor.

Before you start exercising

Although the Samsung Health application is a great companion to your exercise routine, it is always best to make sure you consult with your physician before beginning any exercise regimen. While moderate physical activity, such as brisk walking, is safe for most people, health experts suggest that you talk with your doctor before you start an exercise program, particularly if you have any of the following conditions:

- Heart disease; Asthma or lung disease; Diabetes, or liver or kidney disease; and Arthritis.

Before beginning your exercise regimen check with your doctor if you have symptoms suggestive of heart, lung, or other serious disease, such as:

- Pain or discomfort in your chest, neck, jaw, or arms during physical activity;
- Dizziness or loss of consciousness;
- Shortness of breath with mild exertion or at rest, or when lying down or going to bed;
- Ankle swelling, especially at night;
- A heart murmur or a rapid or pronounced heartbeat;
- Muscle pain when walking upstairs or up a hill that goes away when you rest.



It is recommended that before engaging in an exercise routine, you consult with your doctor or medical practitioner. If you are unsure of your health status, have several health problems, or are pregnant, you should speak with your doctor before starting a new exercise program.

Steps

The Watch counts the number of steps you have taken and measures the distance traveled.

- From  **Samsung Health**, swipe to and tap **Steps** to view a graph of your step count records.

To set your steps target:



1. From  **Samsung Health**, swipe to Steps.
2. Swipe down, tap  **Settings**, and then tap **Step target**.
3. Swipe up or down to set the target.
4. Tap **Done**.

Floors

Record and track the number of floors you walk up.

1. From  **Samsung Health**, swipe to Floors.
2. View a graph of your floor count records.

To set your floors target:

1. From  **Samsung Health**, swipe Floors.
2. Swipe down, tap  **Settings**, and then tap **Floor target**.
3. Swipe up or down to set the target.
4. Tap **Done**.

Exercise

Record your exercise information and calories burned using Samsung Health's exercise feature.

Exercise with the Watch

1. From  **Samsung Health**, swipe to Exercise.
2. Tap **Work out** and tap an activity type.
3. Enter the exercise information.
4. Tap **Start [activity type]** to start monitoring your exercise. Your heart rate measurement begins.
 - When you swipe right or left you can view exercise information, such as calories burned and current speed.
5. Press the **Back** button to pause the workout.
 - Press the **Back** button again to resume the workout.
 - Tap **Finish** to complete your workout and view your workout summary.
6. Swipe to and tap **View log** to see your workout log.

 **NOTE** Measured distance may differ from the actual distance due to uneven strides, walking in place, and pacing around.

Sleep

Automatically track your sleep patterns.

1. From  **Samsung Health**, swipe to Sleep.
2. Swipe up to view your sleep data.



Heart rate

Measure and record your heart rate. Take heart rate measurements when you are seated and relaxed.

1. From  **Samsung Health**, swipe to Heart rate.
2. Tap **Measure** to begin measuring your heart rate.
 - After a moment, your current heart rate is displayed on the screen.
3. Tap **Tag** to select a status tag for your measured heart rate.
 - The Watch displays information about your heart rate in relation to your selected tag.

Track your heart rate

The Watch can automatically measure and track your heart rate. Your Watch measures your heart rate at regular intervals.

1. From  **Samsung Health**, swipe to Heart rate.
2. Swipe up, tap  **Auto HR settings**, and select a measuring interval.
 - **Always:** The Watch measures your heart rate continuously, regardless of your movement.
 - **Frequent:** The Watch measure your heart rate regularly when you are relaxed.
 - **Never:** The Watch does not measure your heart rate automatically.
3. Tap **Help** to view help information for using the auto HR feature.

Stress

Keep track of your stress. Breathing exercises are also available to help reduce stress.

1. From  **Samsung Health**, swipe to Stress.
2. Tap **Measure** to measure your current stress level



Breathing exercise

Use the Breathe feature to help reduce stress.

1. From  **Samsung Health**, swipe to Stress.
2. After taking a stress measurement, the Breathe feature is available. Tap **Breathe** for the following options:
 - **Start:** Begin the breathing exercise.
 - **Target:** Adjust the target cycles per minute.
 - **Inhale/Exhale:** Adjust the time for inhaling and exhaling.
 - **Sound:** Enable or disable sound for the breathing exercise.
 - **Haptic:** Vibrate the Watch between inhale and exhale prompts.



Automatic tracking

Automatically measure and record your stress level at regular intervals.



1. From  **Samsung Health**, swipe to Stress.
2. Swipe down, tap  **Settings**, and tap  **Auto stress settings**.
3. Tap **Always** to enable or disable the feature.

Water

Record and track how many glasses of water you drink.



1. From  **Samsung Health**, swipe to Water.
2. Tap  **Add** when you drink a glass of water.
 - If you accidentally added an incorrect value, tap  **Remove**.

To set your daily water target:



1. From  **Samsung Health**, swipe to Water.
2. Swipe down, tap  **Settings**, and tap  **Set target**.
3. Tap **Daily target** and set the number.
4. Tap **Done**.

Caffeine

Record and track how many cups of caffeinated beverages you drink each day.

1. From  **Samsung Health**, swipe to Caffeine.
2. Tap  **Add** when you drink a caffeinated beverage.
 - If you accidentally added an incorrect value, tap  **Remove**.

To set your daily caffeine target:

1. From  **Samsung Health**, swipe to Caffeine.
2. Swipe down, tap  **Settings**, and tap  **Set target**.
3. Tap **Set target** to enable this feature.
4. Tap **Daily target**, and set the number.
5. Tap **Done**.

Together

Compete with other Samsung Health users.

Steps leaderboard

Add challenges through Samsung Health on your smartphone.

1. From  **Galaxy Wearable**, tap the **Settings** tab.
2. Tap **Samsung Health** > **Together** tab. Here you can add friends and challenges.

View challenges on your Watch

View your challenges and rank on the Steps leaderboard.

- From  **Samsung Health**, swipe to **Together**, and tap a list to see your challenges.

Settings

Customize your Samsung Health settings.

1. From  **Samsung Health**, swipe to **Settings**.
2. Tap an item to customize:
 - **Profile**: Update your personal profile.
 - **Units**: Change units for distance, temperature, and volume.
 - **Workout detection**: Set the Watch to recognize and encourage you when it detects that you are exercising.
 - **Inactive time alerts**: Set the Watch to alert you if you have been still for almost an hour.
 - **Data permissions**: Configure access permissions to your health data.
3. Tap **Help** for a description of Samsung Health.

Galaxy Apps

Samsung Galaxy Apps provides a quick and easy way to find and download free premium apps that are compatible with your Galaxy device.

- From Apps, tap  **Galaxy Apps**.

 **TIP** A Samsung account is required to purchase and download apps.

Weather

View weather information on the Watch for locations set on the smartphone when the devices are connected.



1. From the Apps screen, tap  **Weather**.
2. Tap the screen and swipe to view weather information.
 - Swipe right to add cities on your phone.

Alarm



Set an alarm to ring at a specific time.

Create an alarm

Create an alarm event. You can set one-time or recurring alarms.

1. From Apps , tap  **Alarm**.
2. Tap  **Add** and enter the time.
3. Tap **Next**, and select the days to repeat the alarm.
4. Tap **Save** when finished.

Stop or snooze an alarm

- Drag  **Cancel** to the right to stop an alarm or drag  **Snooze** to the left to snooze.

Delete an alarm

You can delete an alarm that you created.

- From  **Alarm**, tap and hold an alarm, and then tap **Delete**.



Calendar

View the events scheduled on the smartphone.

- From Apps, tap  **Calendar**.
 - Swipe to view other months.
 - Tap a day on the monthly calendar.
 - The day's events list is displayed.
 - Tap an event to view its details.
 - Swipe to view other scheduled events.



Create an event

You can use your Calendar to create events.

1. From Apps, tap  **Calendar**.
2. Tap the day of the event, and tap  **Create** . Enter the event details, and set a reminder.
3. Tap **Save** when finished.

Delete an event

You can delete an event that you created.

1. From Apps, tap  **Calendar**.
2. Tap the day of the event, and tap the event you want to remove to view it.
3. Tap  **More options** >  **Delete**.



Reminder



Add reminders for events and set alarms outside of the Calendar app.

Create a reminder

1. From the Apps screen, tap  **Reminder**.
2. Tap **Add** and choose a keyboard.
3. Follow the prompts to name and set the time for your reminder.
4. Tap **Save** when finished.

Complete a reminder



To mark reminders complete:

1. From  **Reminder**, tap the reminder you want to complete.
2. Tap the checkbox to mark it as complete.
3. To delete the reminder, tap  **More options** >  **Delete**.

Email

View emails received on your smartphone and reply to them.

Read emails



1. From the Apps screen, tap  **Email**.
2. Tap a message to view its content.
3. Tap  **More options** for additional options:
 - **Star**: Mark the email as important.
 - **Show on phone**: View the email on your smartphone.
 - **Delete**: Delete the email.

Note: You may not be able to reply to emails depending on the smartphone that you connect to the Watch.

Reply to emails

1. From  **Email**, tap an email to open the email screen.
2. Tap an icon or a quick reply to compose and send your message.





Delete emails

1. From  **Email**, scroll through the inbox to the email you want to delete.
2. Tap  **More options** > **Delete**.
3. Select the email again, and then tap **Delete**.

Music app





Play music from the Watch

You can play music from the Watch through Bluetooth headphones (not included).

1. From the Apps screen, tap  **Music**.
2. Tap the output until the  **Watch** icon is displayed.
3. Tap  **More options** for the following options:
 - **Turn on shuffle:** Enable or disable shuffle.
 - **Repeat:** Tap to repeat all songs, tap again to repeat once, and tap again to turn off repeat.
4. Tap  **Play music** to play music.
5. Swipe up from the bottom of the screen to open the library screen, where you can view the current song, playlist, and queue music.

Play music on your smartphone

When you select a smartphone to play music from, you can control playback of the music with your Watch. The music plays on your smartphone.

1. From the Apps screen, tap  **Music**.
2. Tap the output until the  **Phone** icon is displayed.
3. Tap  **Play music** to play music on your smartphone.
4. The music plays on your smartphone and the Watch displays the music controller screen.

Import music

Import music saved in your smartphone to your Watch.

1. From the Apps screen of the smartphone, tap  **Galaxy Wearable** > **Home tab** > **Add content to your watch**.
2. Tap **Add tracks**.
3. Select files and tap **Done**.

To sync recently added music in your smartphone with your Watch:

1. From the Apps screen of the smartphone, tap  **Galaxy Wearable** > **Home tab** > **Add content to your watch**.
2. Tap **Auto sync**, and then tap **OK** to confirm. Music will be synced while the Watch battery power is at least 15 percent.

Gallery

View and manage images stored on the Watch.

View images



1. From the Apps screen, tap  **Gallery**.
2. Swipe through the image list and then tap an image to view it.

Zoom in or out

While viewing an image:

- Double-tap the image to zoom in or out.

Delete images

1. From  Gallery, touch and hold an image to delete, or tap  **More options**.
2. Tap **Delete**, and then tap  **Ok** to confirm.

Import and export images

Images can be exchanged between your Watch and smartphone.

Import images from your smartphone



Send images or entire albums from your smartphone to your Watch.

1. From  Galaxy Wearable, tap the **Home** tab.
2. Tap **Add content to your watch** > **Copy images**.
3. Select files or albums and tap **Done**.

To automatically sync images on your smartphone with your Watch:

1. From  Galaxy Wearable, tap the **Home** tab.
2. Tap **Add content to your watch** > **Auto sync** to enable. Images will be synced while the Watch battery power is at least 15 percent.
 - **Image limit:** Set a limit to the number of images that can be synced to your Watch.
 - **Albums to sync:** Select which Gallery albums to sync to your Watch.

Export images to your smartphone

1. From  Gallery, tap the image you want to send to the smartphone.
2. Tap  **More options** >  **Send to phone**.

Take a screenshot

Capture an image of your screen. It is automatically saved to the Gallery app.

To enable the screen capture feature:



- From  **Settings**, tap **Advanced** > **Screen capture** to enable this feature.

To take a screenshot:

- From any screen, press and hold the **Power** key, and swipe the screen from left to right.





Find My Phone

If you misplace your smartphone, the Watch can help you find it.

1. From Apps, tap  **Find My Phone**.
2. Select an option:
 - Tap  **Start**, and the smartphone emits sounds and turns on the screen.
 - Tap  **Stop** on the Watch to terminate the search, or tap **Dismiss** on the smartphone.

Find your Watch

You can also locate your Watch by making it light up and make sounds from the Galaxy Wearable app.

1. From  **Galaxy Wearable**, tap the **Home** tab > **Find My Watch**.
2. Tap  **Start**.
 - The Watch vibrates and the screen turns on.
3. Drag  **Stop** to the right on the Watch or tap  **Stop** on the smartphone..



 **World clock**

The World clock lets you keep track of the current time in multiple cities around the globe.

Add cities

1. From the Apps screen, tap  **World clock**.
2. Tap **Add** to add a city to your World clock.
3. Tap a location on the map, or tap **All cities** to search for the city you want to add.
4. Tap the city to add it to your World clock.
 - To add more cities, tap **Add**.

Remove cities

1. From  **World clock**, tap  **More options** by the city you want to remove.
2. Tap  **Delete**, and select the city again.
3. Tap **Delete** to confirm.

Additional apps

The following apps are preloaded or downloaded over-the-air to your device.



With Spotify, you have access to a world of music and podcasts. You can listen to artists and albums, or create your own playlist of your favorite songs. Want to discover new music? Choose a ready-made playlist that suits your mood or get personalized recommendations.

- From **Apps**, tap  **Spotify**.

Settings

Access Settings

Connections

Vibration

Display

Device maintenance

Lock screen and security



Accessibility

Other settings



Access Settings

You can personalize your device by configuring various setting options.



- From Apps, tap  **Settings**, or swipe down from the top of the screen to open the status panel and tap  **Settings**.

Connections

Manage connections between your device and a variety of networks and other devices.

Bluetooth



Use Bluetooth to connect the Watch to a smartphone and a headset (not included).

1. From  **Settings**, tap **Connections** > **Bluetooth**.
2. Tap  to turn on the feature.
 - Tap **BT headset** to connect a headset to the Watch.

 **NOTE** Headsets can only be used for playing music on the Watch.

Wi-Fi

Activate the Wi-Fi feature to connect to a Wi-Fi network.

1. From  **Settings**, tap **Connections** > **Wi-Fi**.
2. Tap  to enable the feature, and then choose to set Wi-Fi to **Auto**, **Always on**, or **Always off**.

Connect to a Wi-Fi network

This feature is available when the Watch is not connected to the smartphone through Bluetooth.

1. From  **Settings**, tap **Connections** > **Wi-Fi**.
2. Tap **Wi-Fi networks** > **Scan**, and select a network from the list.
 - Networks that require a password display a lock icon.

3. Enter the password if required, and tap **Connect**.

 **NOTE** Once the Watch connects to a Wi-Fi network, the Watch reconnects to that network each time it is available without requiring a password. To prevent the Watch connecting to the network automatically, select the network, and then tap **Forget**.



Sync Wi-Fi profiles

Set the device to sync the list of saved Wi-Fi networks with your Watch.

1. From  **Galaxy Wearable**, tap the **Home** tab.
2. Tap **Sync phone settings** > **Sync Wi-Fi profiles**.

NFC

The Watch lets you use the built-in technology to make payments and buy tickets for transportation or events after downloading and configuring the required apps.

1. From  **Settings**, tap **Connections** > **NFC**.
2. Tap  to enable the feature, and tap **Tap and pay** to set the default payment app for mobile payments.

Make payments with the NFC feature

Before you can use the NFC feature to make payments, you must register for the mobile payment service. To register or get more information about the service, contact your service provider.

1. From  **Settings**, tap **Connections** > **NFC**.
2. Touch the top of the Watch's touchscreen to the card reader.

 **NOTE** The payment services list may not include all available payment apps.

Connection alerts

Receive alerts when disconnected from Bluetooth.

- From  **Settings**, tap **Connections** > **Alerts** to enable or disable this option.



Airplane mode

Airplane mode disconnects your device from all networks and turns off connectivity features, such as phone calls and Wi-Fi.

- From  **Settings**, tap **Connections** > **Airplane mode** to enable this option.

Location

Some apps may require location services to be turned on for full functionality.

1. From  **Settings**, tap **Connections** > **Location**.
2. Tap  to enable this feature, and select a mode.
 - **GPS and wireless networks:** Use GPS and wireless networks.
 - **Wireless networks:** Use wireless networks only.
 - **GPS:** Use GPS only.

Connect to a new phone

Connect your Watch to a new mobile device. The Watch can connect to another mobile device after performing a light reset to delete data.

- From  **Settings**, tap **Connect to a new phone** and follow the prompts.

 **NOTE** This feature is available when the Watch is connected to a smartphone. Otherwise, **Connect to phone** is displayed.

Vibration

Configure the vibrations used to indicate notifications, screen touches, and other interactions.

Vibration intensity

Configure the vibration intensity.

- From  **Settings**, tap **Vibration** > **Vibration intensity**, and select your preferred intensity level. Tap **OK** to confirm.

Long vibration

Increase the duration of the vibration for calls and notifications.

- From  **Settings**, tap **Vibration** > **Long vibration** to enable this feature.

Ringtone vibration

Vibrate for calls.

1. From the Apps screen, rotate the bezel and tap  **Settings**.
2. Tap **Vibration** > **Ringtone vibration** and select a vibration pattern.
3. Tap **OK** to confirm.

Notification vibration

Choose a vibration pattern for new notifications.

- From  **Settings**, tap **Vibration** > **Notification vibration** and select a vibration pattern. Tap **OK** to confirm.

Display

You can configure the screen brightness, timeout delay, font size, and many other display settings.

Watch faces

Change the style settings.

- From  **Settings**, tap **Watch faces**. The following options are available:
 - **Watch faces**: Select a watch type.
 - **Watch always on**: Set the Watch to display a watch when the screen is turned off.
 - **Watch face order**: Set a sort order.
 - **Notification indicator**: Enable or disable the notification indicator.
 - **Status indicator**: Indicators are icons that show the current status of your Watch on the watch face.

Adjust screen brightness

Manually adjust the brightness of the display.

- From  **Settings**, tap **Display** and select an option:
 - **Brightness**: Manually adjust the brightness of the display.
 - **Auto low brightness**: Set the Watch to automatically adjust the brightness depending on ambient light conditions.

Set the screen timeout

Set the length of time the Watch waits before turning off the display's backlight.

- From  **Settings**, tap **Display** > **Screen timeout**, and select a timeout value.

Show last app

Set the length of time the Watch wakes up to the last app used.

- From  **Settings**, tap **Display** > **Show last app**, and select a timeout value.

Background style

Select a background for the watch screens. This will be applied to every screen except your main watch screen.

- From  **Settings**, tap **Display** > **Background style** and select a background.

Font style

Customize the font used on your Watch.

1. From  **Settings**, tap **Display** > **Font**.
2. Tap **Font style**, and select a font.

Font size

Customize the font size used on your Watch.

1. From  **Settings**, tap **Display** > **Font**.
2. Tap **Font size**, and select from small, medium, and large.

Device maintenance

View the status of your device's battery, storage, and memory. You can also automatically optimize your device's system resources.

Date and time

You can set the date and time manually.



- From  **Settings**, tap **General** > **Date and time**.
 - **Set date:** Set the date manually.
 - **Set time:** Set the time manually.
 - **Select time zone:** Select the time zone manually.



NOTE The Date and time options are only available when your Watch is not connected to your mobile device.

Power saving mode

Activate Power saving mode to save battery power by limiting the Watch's functions, such as:



- Uses a grayscale Home screen
- Turns off all functions except calls, messages, and notifications
- Turns off Wi-Fi and mobile networks (if applicable)
- Limits performance
 1. From  **Settings**, tap **Battery**.
 2. Tap **Power saving**, and then tap  **OK**.

To disable Power saving mode:

- From the Home screen, tap **Turn off**, and then tap  **OK**.

Watch only mode

Activate Watch only mode to save battery power by limiting the Watch's functions to only showing the time.



1. From  **Settings**, tap **Battery**.
2. Tap **Watch only**, and then tap  **OK**.

To disable Watch only mode:

- Touch and hold the **Power** button for three seconds.

Reset the Watch

Reset settings to their factory default values and delete all data.

1. From  **Settings**, tap **General** > **Reset**.
2. Tap  **OK**.

Watch status

Access information about the Watch.

1. From  **Galaxy Wearable**, tap the **Home** tab > **About watch**.
2. Tap an option below:
 - **Update watch software:** Update the Watch to the latest software.
 - **Legal information:** View the legal information for the Watch.
 - **Install unknown apps:** Set the Watch to allow the installation of apps from unknown sources.
 - **Device name:** Change the Watch's name.
 - **Device information:** View identification codes for your Watch.

Lock screen and security

You can secure your device and protect your data by setting a screen lock.

Set a screen lock

It is recommended that you secure your device using a Screen lock.

1. From  **Settings**, tap **Security** > **Lock**.
2. Tap **Type** to select a screen lock type:
 - **Pattern**: Create a pattern that you draw on the screen to unlock your device. This option provides medium security.
 - **PIN**: Set a PIN to use for unlocking the device when it removed from your wrist and the screen is turned off.
 - **None**: Do not lock the screen.
3. Tap **Help** to view help information for using the screen lock feature.

Remote security

You can lock and reset your Watch remotely if it is lost. You can also prevent others from reactivating your device if it is lost or stolen. Sign in to your Samsung account to use this feature.

1. From  **Galaxy Wearable**, tap the **Home** tab > **Find My Watch**.
2. Tap **Set security** for the following options:
 - **Remote lock**: Prevent unauthorized use by locking your Watch remotely. Your Watch will unlock automatically when it connects to your mobile device with Bluetooth.
 - **Reset watch**: Remotely delete all data on your Watch. Once it is reset, you can no longer use Find My Mobile to locate your Watch.
 - **Reactivation lock**: Use your Samsung account to stop anyone from reactivating your watch without your permission.

Accessibility

Accessibility services are special features that make using the device easier for those with certain physical disabilities.

For more information about Accessibility for Samsung products, please contact us at accessibility@sea.samsung.com.

Visibility enhancements

You can configure Accessibility features to assist with visual aspects of your device.

- From  **Settings**, tap **Accessibility** > **Visibility enhancements** for the following options:
 - **Zoom**: Use gestures to zoom in or out.
 - **Grayscale**: Remove all colors from the display, and use shades of gray.
 - **Negative colors**: Reverse the display of colors from white text on a black background to black text on a white background.
 - **Vibration watch**: The watch will use vibrations to communicate the time.

Advanced settings

You can configure Accessibility features.

- From  **Settings**, tap **Accessibility** > **Advanced settings** for the following options:
 - **Notification reminder**: Enable and customize notification reminders.
 - **Two finger triple tap**: Use two fingers when using the gesture triple tap.

Text to speech

To set accessibility settings related to Text to speech:

- From  **Settings**, tap **General** > **Text-to-speech** and select a mode:
 - **Language:** Choose the language for spoken text.
 - **Speech rate:** Set the speed at which the text is spoken.
 - **Read notifications aloud:** Set the Watch to read out notifications received on your Watch.
 - **Check for updates:** Search for any updates to the Text-to-speech feature.

Other settings

Configure features on your device that make it easier to use.

Custom shortcut

You can set up a custom shortcut when the Home key is double pressed.

- From  **Settings**, tap **Advanced** > **Double press Home key**, and select an action to perform.



Wake-up gesture

Change the Watch's button and motion settings.

- From  **Settings**, tap **Advanced** and select an option to customize:
 - **Wake-up gesture:** Set the Watch to turn on the screen when you raise your wrist.
 - **Touch wake-up:** Wake up your watch by touching the screen.

Touch sensitivity

Set the Watch to allow use of the touch screen with gloves on.

1. From  **Settings**, tap **Advanced** > **Touch sensitivity**.
2. Tap  to enable this feature.



TIP You can also enable touch sensitivity by holding the **Back** button, and tapping **Touch sensitivity**.

Watch info

View the Watch's information.

- From  **Settings**, tap **About watch** to view the following information about your Watch:
 - **Model number:** Check your Watch's model number.
 - **Serial number:** View your Watch's serial number.
 - **Storage:** Check the available storage space.
 - **Device:** Access device information about the Watch.
 - **Software:** Check your Watch's software version and security status.
 - **Battery:** Check the Watch's battery voltage and capacity.
 - **Open source licenses:** View the guide for checking the Watch's open source license.
 - **Report diagnostic and usage info:** Give consent to provide diagnostic and usage data to Samsung to help improve the quality and performance of its products and services.
 - **Debugging:** Activate or deactivate USB debugging mode when developing apps for the Watch.

Learn more

Videos

samsung.com/us/support/videos

Tips

samsung.com/us/support/tips

Smart Simulator

samsungsimulator.com

Samsung Care

samsung.com/us/support

Talk to an agent

Contact us on Facebook Messenger

Find us on Facebook

Follow us on Twitter

Legal information

READ THIS INFORMATION BEFORE USING YOUR MOBILE DEVICE.

Arbitration Agreement - This Product is subject to a binding arbitration agreement between you and SAMSUNG ELECTRONICS AMERICA, INC. (“Samsung”). You can opt out of the agreement within 30 calendar days of the first consumer purchase by emailing optout@sea.samsung.com or calling 1-800-SAMSUNG (726-7864) and providing the applicable information. For complete terms and conditions that bind you and Samsung, refer to the “Arbitration Agreement” section of the Terms & Conditions, included with the Product.

Find Legal Information Online

The full Arbitration Agreement, Standard Limited Warranty, and Health & Safety Information for your device are available online:

<https://www.samsung.com/us/Legal/Gear-HSGuide/>

The full End User License Agreement (EULA) for your device can be found in the Galaxy Wearable application, which is required for operation of your device, and online:

- Online: www.samsung.com/us/Legal/SamsungLegal-EULA-GEAR
- Galaxy Wearable application: Settings > About watch > Legal information > Samsung legal

Intellectual property

All Intellectual Property, as defined below, owned by or which is otherwise the property of Samsung or its respective suppliers relating to the SAMSUNG mobile device, including but not limited to, accessories, parts, or software relating thereto (the “mobile device”), is proprietary to Samsung and protected under federal laws, state laws, and international treaty provisions. Intellectual Property includes, but is not limited to, inventions (patentable or unpatentable), patents, trade secrets, copyrights, software, computer programs, and related documentation and other works

of authorship.

You may not infringe or otherwise violate the rights secured by the Intellectual Property. Moreover, you agree that you will not (and will not attempt to) modify, prepare derivative works of, reverse engineer, decompile, disassemble, or otherwise attempt to create source code from the software. No title to or ownership in the Intellectual Property is transferred to you. All applicable rights of the Intellectual Property shall remain with SAMSUNG and its suppliers.

Open source software

Some software components of this product, including but not limited to 'PowerTOP' and 'e2fsprogs', incorporate source code covered under GNU General Public License (GPL), GNU Lesser General Public License (LGPL), OpenSSL License, BSD License and other open source licenses. To obtain the source code covered under the open source licenses, please visit: opensource.samsung.com

Disclaimer of warranties; exclusion of liability

The information below explains that a user accepts this Product as sold, including the hardware and software components as created and packaged for sale. If the user changes these parameters through a unique modification, Samsung will not be held responsible for damages or issues that result from these end-user changes.

Except as set forth in the Standard Limited Warranty that accompanies the Product, the purchaser takes the product "as is", and Samsung makes no express or implied warranty of any kind whatsoever with respect to the Product, including but not limited to the:

- merchantability of the Product or its fitness for any particular purpose or use;
- design, condition or quality of the Product;
- performance of the Product;
- workmanship of the Product or the components contained therein; or

- compliance of the Product with the requirements of any law, rule, specification or contract pertaining thereto.

Nothing contained in the User Manual or any other document shall be construed to create an express or implied warranty of any kind whatsoever with respect to the Product. Neither Samsung nor the wireless carrier are responsible for, and the Standard Limited Warranty does not apply to, any damage or injury arising from disassembly or repairs by persons not authorized or approved by Samsung to service this Product. In addition, Samsung shall not be liable for any damages of any kind resulting from the purchase or use of the Product or arising from the breach of the express warranty, including incidental, special or consequential damages, or loss of anticipated profits or benefits.

Modification of software

Samsung is not liable for performance issues or incompatibilities caused by your editing of registry settings, or your modification of Operating System (OS) software.

Using custom OS software may cause your device and applications to work improperly. Your carrier may not permit users to download certain software, such as custom OS.

Samsung Knox

Samsung Knox is Samsung's security platform and is a mark for a Samsung device tested for security with enterprise use in mind. Additional licensing fee may be required. For more information about Knox, please refer to: samsung.com/us/knox.

Maintaining water and dust resistance

- ▲ To avoid electric shock and damage to your device, do not charge device while it is wet or in an area where it could get wet. Do not handle device, charger or cords with wet hands while charging.

This device is rated 5ATM. Your device is water resistant up to 50 meters per ISO standard 22810:2010. Not intended for scuba diving. Avoid excessive, sudden

temperature changes, and high velocity activities. Falls and shocks may breach integrity. After use in sea water, rinse in fresh water and dry device. Despite this classification, your device is not impervious to water damage in any situation. It is important that all compartments are closed tightly.



NOTE If any liquid is found to have entered your device components or an internally sealed system, this condition will void your device warranty.

Follow these tips carefully to prevent damage to the device.

- Whenever your device gets wet, dry it thoroughly with a clean, soft cloth. Failure to rinse the device in fresh water and dry it as instructed may cause the device to suffer from operability or cosmetic issues.
- Do not expose the device to water at high pressure.
- If the device is dropped or receives an impact, the water and dust resistant features of the device may be damaged.



NOTE This device passed military specification (MIL-STD-810G) testing against specific conditions, including drops from 4.9 feet, extreme temperatures, dust, shock/vibration, and low pressure/high altitude. Device may not perform as described in all extreme conditions.

Restricting children's access to your mobile device

Your device is not a toy. Do not allow children to play with it because they could hurt themselves and others, damage the device, or make calls that increase your device bill. Keep the device and all its parts and accessories out of the reach of small children.

Samsung Electronics America, Inc.

Address:

85 Challenger Road
Ridgefield Park
New Jersey 07660

Phone: 1-800-SAMSUNG (726-7864)

Internet: samsung.com

©2019 Samsung Electronics America, Inc. Samsung, Samsung Galaxy and Samsung Galaxy Watch are all trademarks of Samsung Electronics Co., Ltd.

Other marks are the property of their respective owners.



Some multimedia (audio/video) files contain Digital Rights Management (DRM) technology to verify you have the right to use the files. Preloaded apps on your device may not be compatible with DRM-protected files.

Screen images are simulated. Appearance of device may vary.

The actual available capacity of the internal memory is less than the specified capacity because the operating system and default applications occupy part of the memory. The available capacity may change when you upgrade the device.

Please check with your service provider to verify qualifying services/features.