

User Guide

Rack Automatic Transfer Switch (ATS)

AP4421, AP4422, AP4423, AP4424, AP4430, AP4431, AP4432, AP4452X631
AP4433, AP4434, AP4450, AP4452, AP4452J, AP4453, AP4430X914

990-5844C-001

Publication Date: 9/2020

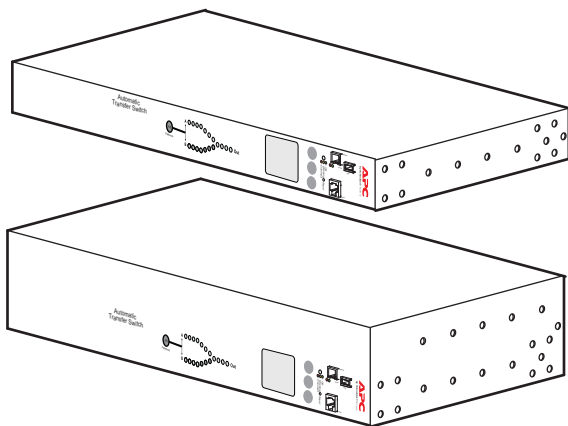

APC by Schneider Electric Legal Disclaimer

The information presented in this manual is not warranted by the APC by Schneider Electric to be authoritative, error free, or complete. This publication is not meant to be a substitute for a detailed operational and site specific development plan. Therefore, APC by Schneider Electric assumes no liability for damages, violations of codes, improper installation, system failures, or any other problems that could arise based on the use of this Publication.

The information contained in this Publication is provided as is and has been prepared solely for the purpose of evaluating data center design and construction. This Publication has been compiled in good faith by APC by Schneider Electric. However, no representation is made or warranty given, either express or implied, as to the completeness or accuracy of the information this Publication contains.

IN NO EVENT SHALL APC BY SCHNEIDER ELECTRIC, OR ANY PARENT, AFFILIATE OR SUBSIDIARY COMPANY OF APC by Schneider Electric OR THEIR RESPECTIVE OFFICERS, DIRECTORS, OR EMPLOYEES BE LIABLE FOR ANY DIRECT, INDIRECT, CONSEQUENTIAL, PUNITIVE, SPECIAL, OR INCIDENTAL DAMAGES (INCLUDING, WITHOUT LIMITATION, DAMAGES FOR LOSS OF BUSINESS, CONTRACT, REVENUE, DATA, INFORMATION, OR BUSINESS INTERRUPTION) RESULTING FROM, ARISING OUT, OR IN CONNECTION WITH THE USE OF, OR INABILITY TO USE THIS PUBLICATION OR THE CONTENT, EVEN IF APC BY SCHNEIDER ELECTRIC HAS BEEN EXPRESSLY ADVISED OF THE POSSIBILITY OF SUCH DAMAGES. APC BY SCHNEIDER ELECTRIC RESERVES THE RIGHT TO MAKE CHANGES OR UPDATES WITH RESPECT TO OR IN THE CONTENT OF THE PUBLICATION OR THE FORMAT THEREOF AT ANY TIME WITHOUT NOTICE.

Copyright, intellectual, and all other proprietary rights in the content (including but not limited to software, audio, video, text, and photographs) rests with APC by Schneider Electric or its licensors. All rights in the content not expressly granted herein are reserved. No rights of any kind are licensed or assigned or shall otherwise pass to persons accessing this information.

This Publication shall not be for resale in whole or in part.

Contents

Important Safety Information	1
Overview	2
Product Features	2
Internal Protection Measures	3
How Switching Works	3
Types of User Accounts	5
Watchdog Features	5
Network interface watchdog mechanism	5
Resetting the network timer	5
Getting Started	6
Establish Network Settings	6
IPv4 Initial Setup	6
IPv6 Initial Setup	6
TCP/IP Configuration Methods	6
.ini file utility	6
Device IP Configuration Wizard	7
DHCP and BOOTP configuration	7
Local access to the CLI	8
Remote access to the CLI	9
Configure TCP/IP settings in the CLI	9
Network Management with Other Applications	10
Recover from a Lost Password	10
Front Panel	11
Load Status LED	12
Network Status LED	12
10/100 Status LED	12
LCD Display Screens	13
Default screens	13
Menu screens	14
Alarm status indicators	16
Command Line Interface	17
Log on to the CLI	17
Local access to the CLI	17
Remote access to the CLI	17
About the Main Screen	18
Using the CLI	19

Command Syntax	20
Command Response Codes	21
Prompting for User Input during Command Execution	21
Command Editing	22
History	22
Auto Completion	22
Delimiter	22
Options and Arguments Inputs	23
Command Console and CLI Response Format	23
Response Format and Message Codes	23
Rack ATS System Command Descriptions	24
? or help	24
about	25
alarmcount	26
boot	27
bye, exit, or quit	28
cd	28
cipher	29
crrst	31
console	31
date	32
delete	32
dir	33
dns	34
eapol	35
email	36
eventlog	37
exit	37
firewall	38
format	38
ftp	39
help	39
lang	39
lastrst	40
ledblink	40
logzip	40
netstat	41
ntp	41
ping	42
portSpeed	42
prompt	43
pwd	43
radius	44
reboot	45
resetToDef	45
session	46
smtp	47

snmp	48
snmpv3	49
snmptrap	50
system	51
tcpip	52
tcpip6	53
user	54
userdfit	55
web	56
whoami	56
xferINI	57
xferStatus	57
Device Command Descriptions	58
aboutATS	58
atsStatus	58
atsMeasure	59
bkLowLoad	60
bkNearOver	61
bkOverLoad	62
bkPeakLoad	63
bkReading	64
eventCounts	65
freqDeviat	65
frontPanel	66
lcd	66
lcdBlink	66
lineVRMS	67
phLowLoad	67
phNearOver	68
phOverLoad	68
phPeakLoad	68
phReading	69
prodInfo	69
sourceAName	69
sourceBName	70
sourcePref	70
vMediumLmt	70
vNarrowLmt	71
vSensitivty	71
vWideLmt	72
vXferRange	72
Web User Interface	73
Log on to the Web UI	73
URL address formats	74
First log on	74
Limited Status Access	74

Web UI Features	75
Tabs	75
Limited Status Access	75
Device status icons	75
Quick Links	76
Home Tab	77
Status Tab	78
View ATS Status	78
View device alarms	78
View device status	78
View the unit status	79
View load status	80
View power measurements	80
View Network Status	81
Current IPv4 settings	81
Current IPv6 settings	82
Domain name system status	82
Port Speed	82
Control Tab	83
Manage User Sessions	83
Reset the Network Interface	84
Configuration Tab	85
Configure the ATS	85
Configure ATS name and location	85
Set preferred power source	85
Configure switching behavior	86
Configure warning thresholds	88
Manage Security Settings	89
Manage user sessions	89
Enable ping response	89
Manage local user settings	90
Configure default user settings	92
Manage remote user settings	93
Configure a RADIUS server	94
Firewall menus	95
802.1X Security Configuration	97
Configure Network Settings	98
Protocol Configuration Summary	98
Configure TCP/IP and communication settings for IPv4 and IPv6	99
Configure network port speed	101
Configure DNS	102
Test DNS configuration	102
Configure Web access	103

Configure SSL certificate	104
Configure CLI access	104
Configure SSH host key	105
SNMP options	105
SNMPv1	106
SNMPv3	107
Configure FTP server	108
Configure Notifications	109
Configure notifications by event	109
Configure notifications by group	110
Set up e-mail notifications	111
SNMP traps	114
General Configuration	115
Configure identification	115
Configure date, time, and daylight savings	116
Create and import settings with the config file	117
Configure links	117
Configure Logs	117
Identify Syslog servers	117
Configure Syslog settings	118
Test Syslog servers	118
Tests Tab	119
Set the LCD/LED Lights to Blink	119
Set the LED Lights to Blink	119
Logs Tab	120
View and configure the Event Log	120
View and configure the Data Log	122
Firewall log	123
Use FTP or SCP to retrieve log files	123
About Tab	125
About the Rack ATS	125
About the network	125
Support resources	126
How to Export Configuration Settings	127
Summary of the procedure	127
Contents of the .ini file	127
Detailed procedures	128
Retrieve .ini file	128
Edit .ini file	128
Transfer the file to a single ATS	129
Transfer the file to multiple ATS units	129

The Upload Event and Error Messages	130
The event and its error messages	130
Messages in config.ini	130
Errors generated by overridden values	130
Related Topics	130
File Transfers	131
Upgrading Firmware	131
Benefits of upgrading firmware	131
Firmware module files	131
Firmware File Transfer Methods	132
Use the Firmware Upgrade Utility	132
Use FTP or SCP to upgrade one Rack ATS	133
Use XMODEM to upgrade one Rack ATS	134
Use a USB drive to transfer and upgrade files	134
How to upgrade multiple ATS units	135
Use the Firmware Upgrade Utility for multiple upgrades	135
Verifying Upgrades and Updates	136
Verify the success or failure of the transfer	136
Last Transfer Result codes	136
Verify the version numbers of installed firmware	136
Troubleshooting	137
Rack ATS Access Problems	137
SNMP Issues	138
Source Code Copyright Notice	139

Important Safety Information

Read the instructions carefully to become familiar with the equipment before trying to install, operate, service, or maintain it. The following special messages may appear throughout this manual or on the equipment to warn of potential hazards or to call attention to information that clarifies or simplifies a procedure.



The addition of this symbol to a Danger or Warning safety label indicates that an electrical hazard exists which will result in personal injury if the instructions are not followed.



This is the safety alert symbol. It is used to alert you to potential personal injury hazards. Obey all safety messages that follow this symbol to avoid possible injury or death.

DANGER

DANGER indicates an imminently hazardous situation which, if not avoided, **will result in** death or serious injury.

WARNING

WARNING indicates a potentially hazardous situation which, if not avoided, **can result in** death or serious injury.

CAUTION

CAUTION indicates a potentially hazardous situation which, if not avoided, **can result in** minor or moderate injury.

NOTICE

NOTICE addresses practices not related to physical injury including certain environmental hazards, potential damage or loss of data.

Overview

The APC by Schneider Electric™ Rack Automatic Transfer Switch (ATS) with Network Management Card 2 provides redundant power to single-corded equipment loads, such as servers. The Rack ATS has two input power cords that supply power to the connected loads from both a primary and secondary power source. If the primary source becomes unavailable or goes out of the configured power range, the Rack ATS will switch to draw power from the secondary source without interrupting critical loads. You can manage a Rack ATS through its Web User Interface (Web UI), its Command Line Interface (CLI), StruxureWare™ Data Center Expert®, EcoStruxure IT, or Simple Network Management Protocol (SNMP). (To use the PowerNet® MIB with an SNMP browser, see the *Management Information Base (MIB) Reference Guide*, available at www.apc.com.)

Product Features

The Rack ATS has these additional features:

- LED indicators on the front panel of the unit indicate operation conditions such as preferred source, overload current, and Web connectivity. These conditions can also be monitored via the CLI and Web UI.
- Various levels of access: Super User, Administrator, Device User, Read-Only, and Network-Only User. (These have user name and password requirements.)
- A multiple-user login feature, which allows up to four users to be logged in simultaneously.
- Event and data logging. The event log is accessible by Telnet, Secure CoPy (SCP), File Transfer Protocol (FTP), serial connection, or Web browser (using HTTPS access with SSL/TLS, or using HTTP access). The data log is accessible by Web browser, SCP, or FTP.
- SNMP traps, Syslog messages, and e-mail notifications based on the severity level or category of the Rack ATS and NMC system event.
- Security protocols for authentication and encryption.
- The ability to monitor sources and set source-transfer parameters via Web and CLI interfaces.
- Set alarm thresholds that provide network and visual alarms to help you prevent overloaded circuits.
- Internal protection measures against short circuits. (See “Internal Protection Measures” on page 3 for details.)

NOTE: It is always recommended that you connect each ATS source to a Double Conversion On-Line Uninterruptible Power Supply (UPS).

Internal Protection Measures

ATS units may include the following internal protection measures:

- Input relays in every model open when their source is disconnected to help prevent electric backfeed from one input cord into another (ATS 1).
- Two or four non-replaceable fuses (depending on the model) help to protect the ATS from short circuits (ATS 2).
- Some 2U models have circuit breakers to help protect against bank overload (ATS 3).

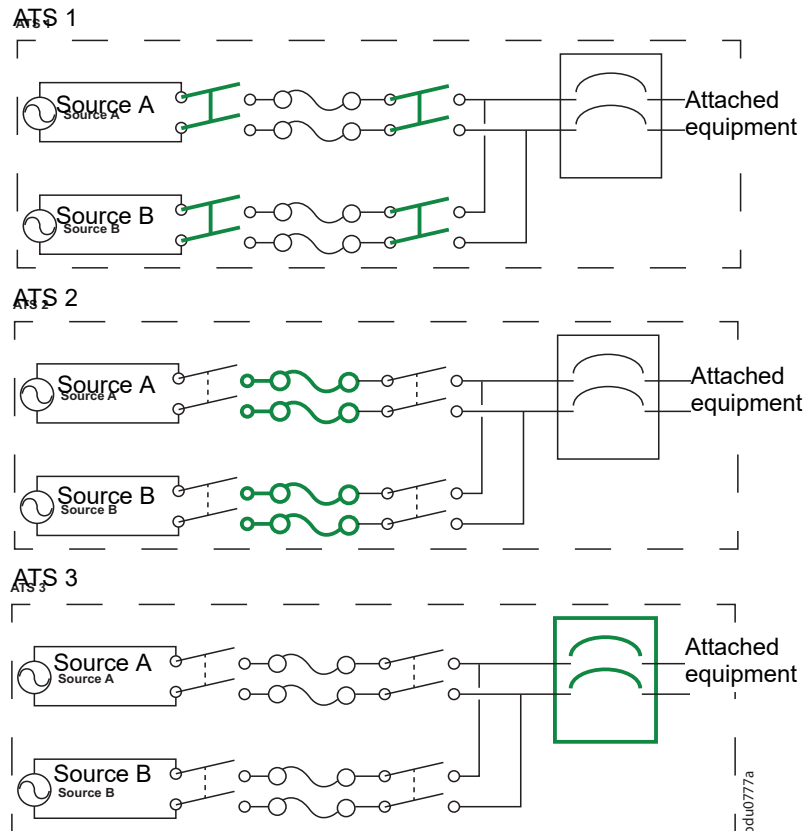

The rack ATS does not include power surge protection. To help protect your ATS from external power surges, it is always recommended that you connect each ATS source to a Double Conversion On-Line Uninterruptible Power Supply (UPS).

How Switching Works

1. You configure the ATS to accept power that meets the needs of your equipment by adjusting the following settings (see “Configuration Tab” on page 85 for more details).
 - **Line VRMS:** The ideal voltage for your equipment. Acceptable line voltages vary per ATS model (see the specification sheet for your ATS model on www.apc.com).
 - **Transfer limits:** The maximum and minimum voltages the ATS will accept before switching sources. Transfer limits are meant to allow for small, acceptable surges and drops in power. The ATS should not operate near the upper transfer limit for long periods of time.
 - **Transfer ranges:** Pre-defined sets of transfer limits. You can configure up to three transfer ranges, but you can enable only one transfer range at a time.
 - **Sensitivity:** How long the ATS waits to determine whether or not it will switch sources. High sensitivity provides extra responsiveness for delicate equipment. Low sensitivity helps to prevent excessive switching in cases of fluctuating power inputs.

2. The ATS constantly monitors the quality and amount of power coming from sources A and B. If one source begins to supply power that does not meet your settings, the ATS will disqualify that source.
 - a. If the disqualified source *is not* in use, the ATS will generate an alarm to indicate that redundancy has been lost.
 - b. If the disqualified source *is* in use, the ATS will switch to draw power from the other available source.

If a preferred source is set, the ATS will wait 30 seconds to monitor that source. After 30 seconds, if the preferred source becomes usable again, the ATS will switch back to the preferred source. See how the switch happens in the illustration below.

Source A is providing power to the attached equipment, while Source B is isolated from the attached equipment.

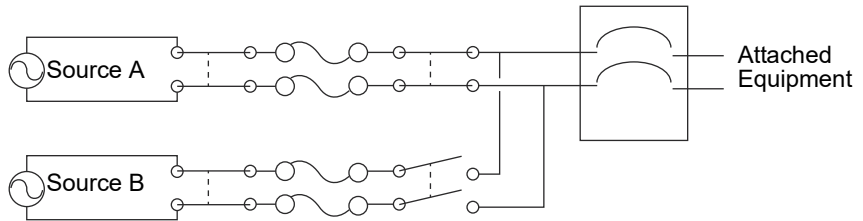

Firmware detects that Source A is out of the user-specified transfer range. The input power from Source A is removed by disengaging the relays.

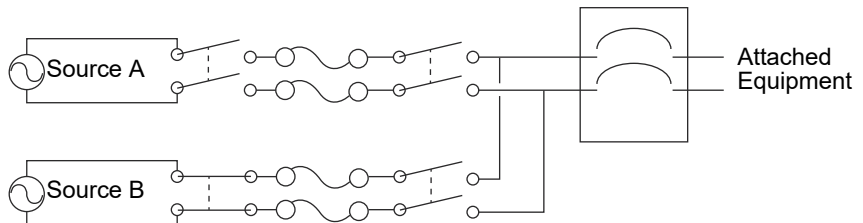

(This allows for out-of-phase switching and significantly reduces the opportunity for relay welding.)

Source B relays are engaged. Source B provides power to the attached equipment.

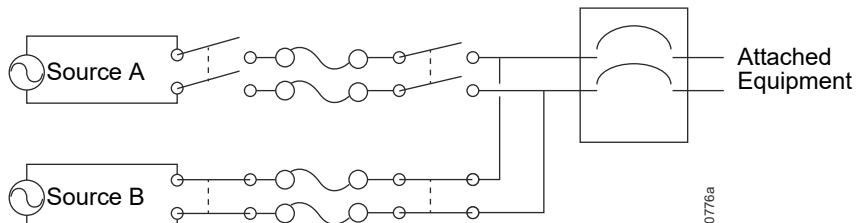

psd0776a

NOTE: The entire switching process (described in step 2) takes a maximum of 10 milliseconds (ms) at high sensitivity, and 12 ms at low sensitivity. (This applies to both 50 Hz and 60 Hz sources.)

Types of User Accounts

The Rack ATS has various levels of access (Super User, Administrator, Device User, Read-Only User, and Network-Only User), which are protected by user name and password requirements. Up to four users are allowed to log on to the same Rack ATS simultaneously.

NOTE: You will be prompted to enter a new password the first time you connect to the device with the Super User account. The Administrator, Device User, Read-Only User, and Network-Only user accounts are disabled by default, and cannot be enabled until the Super User default password (apc) is changed.

- An **Administrator** or the **Super User** can use all of the menus in the Web UI and all of the commands in the CLI. Administrator user types can be deleted, but the Super User cannot be deleted. The default user name and password for the Super User or an Administrator are both **apc**.
NOTE: The Super User or an Administrator can manage another Administrator's account (enable, disable, change password, etc).
- A **Device User** has read and write access to device-related screens. Administrative functions like **Session Management** under the **Security** menu and **Firewall** under **Logs** are unavailable.
- A **Read-Only User** has access to the same menus as a Device User, but without the ability to change configurations, control devices, delete data, or use file transfer options. Links to configuration options are visible but disabled. The event and data logs display no button to clear the log. The default user name for this account is **readonly**, and the default password is **apc**.
- A **Network-Only User** can only log on using the Web UI and CLI (Telnet or SSH). A user with network-only access has read/write permission to the network related menus only.

Watchdog Features

To detect internal problems and recover from unanticipated inputs, the Rack ATS uses internal, system-wide watchdog mechanisms. When it restarts to recover from an internal problem, a **Network Interface Restarted** event is recorded in the event log.

Network interface watchdog mechanism

The Rack ATS implements internal watchdog mechanisms to help protect itself from becoming inaccessible over the network. For example, if the Rack ATS does not receive any network traffic for 9.5 minutes (either direct traffic, such as SNMP, or broadcast traffic, such as an Address Resolution Protocol [ARP] request), it assumes that there is a problem with its network interface and restarts. The network interface watchdog mechanism is only enabled on an ATS that discovers an active network interface connection at start-up.

Resetting the network timer

To help ensure that the Rack ATS does not restart if the network is quiet for 9.5 minutes, the Rack ATS attempts to contact the default gateway every 4.5 minutes. If the gateway is present, it responds to the Rack ATS, and the response restarts the 9.5-minute timer. If your application does not require or have a gateway, specify the IP address of a computer that is running on the network and is on the same subnet. The network traffic of that computer should restart the 9.5-minute time frequently enough to prevent the Rack ATS from restarting.

Getting Started

To start using the Rack ATS:

1. Install the Rack ATS using the *Installation and Quick Start* on www.apc.com.
2. Apply power and connect to your network. Follow the directions in the *Installation and Quick Start*.
3. Establish your network settings.
4. Begin using the Rack ATS with one of the following:
 - The front panel. See “Front Panel” on page 11.
NOTE: The front panel allows you to view Rack ATS settings, but not configure them.
 - The CLI. See “Command Line Interface” on page 17.
 - The Web UI. See “Web User Interface” on page 73.

Establish Network Settings

IPv4 Initial Setup

You must define three TCP/IP settings for the Rack ATS before it can operate on the network:

- The IP address of the Rack ATS
- The subnet mask of the Rack ATS
- The IP address of the default gateway (only needed if you are going off segment)

NOTE: Do **NOT** use the loopback address (127.0.0.1) as the default gateway. Doing so disables the network connection of the Rack ATS. To enable the network connection again, you must log on using a serial connection and reset the TCP/IP settings to their defaults.

For detailed information on how to use a DHCP server to configure the TCP/IP settings at a Rack ATS, see “DHCP response options” on page 99

IPv6 Initial Setup

IPv6 network configuration provides flexibility to accommodate your requirements. IPv6 can be used anywhere an IP address is entered on this interface. You can configure IPv6 using the CLI, the Web UI, or DHCP.

TCP/IP Configuration Methods

Use one of the following methods to define the TCP/IP settings needed by the Rack ATS:

- Device IP Configuration Wizard (see “Device IP Configuration Wizard” on this page).
- BOOTP or DHCP server (see “DHCP and BOOTP configuration” on page 7).
- Local computer (see “Local access to the CLI” on page 8).
- Networked computer (see “Remote access to the CLI” on page 9).

.ini file utility

You can use the .ini file export utility to export .ini file settings from a configured Rack ATS to an unconfigured Rack ATS. For more information, see “Create and import settings with the config file” on page 117.

Device IP Configuration Wizard

The Device IP Configuration Wizard runs on Microsoft® Windows® 2000, Windows Server® 2003, Windows Server 2012, and on 32- and 64-bit versions of Windows XP®, Windows Vista®, Windows 2008, Windows 7, Windows 8, and Windows 10 operating systems. The Device IP Configuration Wizard supports cards that have firmware version 3.0.x or higher and is for IPv4 only.

To install the Device IP Configuration Wizard:

1. Go to www.apc.com.
2. Download the latest version of the Device IP Configuration Wizard.
3. Run the executable file (DeviceIPConfigurationWizard.exe).

NOTE: If you leave the **Start a Web browser when finished** option enabled, you can use **apc** for both the user name and password to access the Rack ATS through your browser.

When Installed, the Device IP configuration Wizard is available through the Windows **Start** menu options.

Configure TCP/IP settings with the Wizard

The Device IP Configuration Wizard can discover Rack ATS units that do not have an IP address assigned. Once discovered, you can configure the IP address settings for the Network Management Cards (NMCs). You can also search for devices already on the network by entering an IP range to define the search. The Utility scans the IP addresses in the defined range and discovers Rack ATS units that already have a DHCP-assigned IP address.

NOTE: For detailed information on the Utility, see FAQ article FA156064: go to www.apc.com, navigate to **Support > Resources & Tools > FAQs**, then enter the article number in the search bar.

NOTE: To use the DHCP Option 12 (AOS 5.1.5 or higher), see FAQ article FA156110.

DHCP and BOOTP configuration

The default TCP/IP configuration setting, **DHCP**, assumes that a properly configured DHCP server is available to provide TCP/IP settings to the Rack ATS. You can also configure the setting for BOOTP.

A user configuration (INI) file can function as a BOOTP or DHCP boot file. For more information, see “Create and import settings with the config file” on page 117.

If neither of these servers is available, see “Device IP Configuration Wizard” on page 7.

BOOTP

For the Rack ATS to use a BOOTP server to configure its TCP/IP settings, it must find a properly configured RFC951-compliant BOOTP server.

1. In the BOOTPTAB file of the BOOTP server, enter the Rack ATS’s MAC address, IP address, subnet mask, and default gateway, and, optionally, a bootup file name. Look for the MAC address on the bottom of the Rack ATS.
2. When the Rack ATS reboots, the BOOTP server provides it with the TCP/IP settings.
 - If you specified a bootup file name, the Rack ATS attempts to transfer that file from the BOOTP server using TFTP or FTP. The Rack ATS assumes all settings specified in the bootup file.
 - If you did not specify a bootup file name, you can configure the other settings of the Rack ATS remotely through its Web UI (see “Web User Interface” on page 73) or CLI (see “Remote access to the CLI” on page 9) The default user name and password are **apc** for both interfaces. To create a bootup file, see your BOOTP server documentation.

DHCP

You can use an RFC2131/RFC2132-compliant DHCP server to configure the TCP/IP settings for the Rack ATS.

1. The Rack ATS sends out a DHCP request that uses the following to identify itself:
 - A Vendor Class Identifier (APC by default)
 - A Client Identifier (by default, the MAC address of the Rack ATS)
 - A User Class Identifier (by default, the identification of the application firmware installed on the Rack ATS)
 - A Host Name (by default, apcXXYYZZ with XXYYZZ being the last six digits of the ATS serial number). This is known as DHCP Option 12.
2. A properly configured DHCP server responds with a DHCP offer that includes all the settings that the Rack ATS needs for network communication. The DHCP offer also includes the Vendor Specific Information option (DHCP option 43). The Rack ATS can be configured to ignore DHCP offers that do not encapsulate the APC cookie in DHCP option 43 using the following hexadecimal format. (The Rack ATS does not require this cookie by default.)

```
Option 43 = 01 04 31 41 50 43
```

- The first byte (01) is the code.
 - The second byte (04) is the length.
 - The remaining bytes (31 41 50 43) are the APC cookie.
- See your DHCP server documentation to add code to the Vendor Specific Information option.
- NOTE:** By selecting the **Require vendor specific cookie to accept DHCP Address** check box in the Web UI, you can require the DHCP server to provide an “APC” cookie, which supplies information to the Rack ATS.

For additional information on supported DHCP options, see “Configure TCP/IP and communication settings for IPv4 and IPv6” on page 99.

Local access to the CLI

You can use a local computer to connect to the ATS and access the CLI.

1. Select a serial port at the local computer and disable any service that uses that port.
2. Use the serial communication cable (940-0144A) to connect the selected port to the serial port on the front panel of the ATS.
3. Run a terminal program (such as HyperTerminal®) and configure the selected port for 9600 bps, 8 data bits, no parity, 1 stop bit, and no flow control. Save the changes.
4. Press ENTER up to 3 times to display the **User Name** prompt.
5. Use **apc** for the user name and password.
6. See “Configure TCP/IP settings in the CLI” on page 9 to finish the configuration.

Remote access to the CLI

From any computer on the same network as the Rack ATS, you can use ARP and Ping to assign an IP address to the Rack ATS, and then use Telnet to access the CLI of that Rack ATS and configure the other TCP/IP settings. SSH is enabled by default.

NOTE: After the IP address of the Rack ATS is configured, you can access the Rack ATS using Telnet or SSH, without first using ARP and Ping but Telnet is required for initial CLI configuration. You can use the console command to enable or disable Telnet or SSH. If needed, you can also use the Web UI to enable or disable Telnet or SSH.

1. Use ARP to define an IP address for the Rack ATS and use the MAC address of the Rack ATS in the ARP command. For example, to define an IP address of 156.205.14.141 for a Rack ATS that has a MAC address of 00 c0 b7 63 9f 67, use one of the following commands:
 - Windows command format:

```
arp -s 156.205.14.141 00-c0-b7-63-9f-67
```
 - LINUX command format:

```
arp -s 156.205.14.141 00:c0:b7:63:9f:67
```**NOTE:** The MAC address can be found on the bottom of the ATS.
2. Use Ping with a size of 113 bytes to assign the IP address defined by the ARP command. For example:
 - Windows command format:

```
ping 156.205.14.141 -l 113
```
 - LINUX command format:

```
ping 156.205.14.141 -s 113
```
3. Use Telnet to access the Rack ATS at its newly assigned IP address. (For example: `telnet 156.205.14.141`) Use **apc** for both user name and password. (See “Remote access to the CLI” on page 17)

See “Configure TCP/IP settings in the CLI” on page 9 to finish the configuration.

Configure TCP/IP settings in the CLI

1. Log on to the CLI. See “Log on to the CLI” on page 17.
2. Contact your network administrator to obtain the IP address, subnet mask, and default gateway for the Rack ATS.
3. Use these three commands to configure network settings. (Text in italics indicates a variable.)

```
tcpip -i yourIPaddress  
tcpip -s yourSubnetMask  
tcpip -g yourDefaultGateway
```

For each variable, type a numeric value that has the format `xxx.xxx.xxx.xxx`. For example, to set a system IP address of 156.205.14.141, type the following command and press ENTER:

```
tcpip -i 156.205.14.141
```

NOTE: You can also enter all three command options on the same line:

```
tcpip -i yourIPaddress -s yourSubnetMask tcpip -g yourDefaultGateway
```

4. Type `exit`, and then press ENTER. The Rack ATS restarts to apply the changes.

Network Management with Other Applications

These applications and utilities work with a Rack ATS that is connected to the network.

- PowerNet Management Information Base (MIB) with a standard MIB browser: Perform SNMP SETs and GETs and use SNMP traps
- EcoStruxure IT: Collects, organizes, and distributes critical alerts and key information, providing a unified view of complex physical infrastructure environments from anywhere on the network or from your smart phone.
- StruxureWare Data Center Expert: Collects, organizes, and distributes critical alerts and key information, providing a unified view of complex physical infrastructure environments from anywhere on the network.
- Device IP Configuration Utility: Configure the basic settings of one or more Rack ATS units over the network (see “Device IP Configuration Utility”).
- Security Wizard: Create components needed to help with security for the Rack ATS units when you are using Secure Sockets Layer (SSL)/Transport Layer Security (TLS) and related protocols and encryption routines.

Recover from a Lost Password

You can use a local computer (a computer that connects to the Rack ATS through the serial port) to access the CLI.

1. Select a serial port at the local computer, and disable any service that uses that port.
2. Connect the serial communication cable (940-0144A) to the selected port on the computer and to the Serial port on the Rack ATS.
3. Run a terminal program (such as Tera Term[®] or HyperTerminal[®]) and configure the selected port for 9600 bps, 8 data bits, no parity, 1 stop bit, and no flow control.
4. Press ENTER up to 3 times to display the **User Name** prompt. If you are unable to display the User Name prompt, verify the following:
 - The serial port is not in use by another application.
 - The terminal settings are correct as specified in step 3.
 - The correct cable is being used as specified in step 2.
5. Press the **Reset** button. The Status LED will flash alternately orange and green within 5 to 7 seconds of pressing the **Reset** button. When the LED begins flashing, immediately press the **Reset** button a second time to temporarily reset the user name and password to their defaults.
6. Press ENTER, repeatedly if necessary, to display the **User Name** prompt again, then use **apc** for the user name and password. (If you take longer than 30 seconds to log on after the **User Name** prompt is re-displayed, you must repeat step 5 and log on again.)
7. At the CLI, use the following commands to change the password from **apc** to a password of your choice:

```
user -n <user name> -pw <user password>
```

or

```
user -n <user name> -cp <current password> apc -pw <new password>
```

For example, to change the Super User password to **XYZ**, type:

```
user -n apc -cp apc -pw XYZ
```

8. Type **quit** or **exit**, and then press ENTER to log off.
9. Reconnect any serial cable you disconnected, and restart any service you disabled.

Front Panel

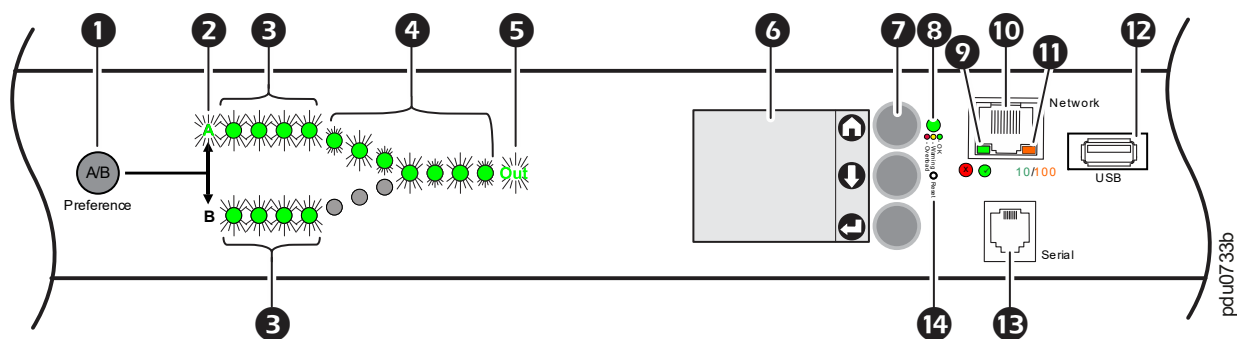

NOTE: Your Rack ATS is configured so the display back light turns off after 10 minutes of inactivity. Press any display navigation button to illuminate the back light.

| Item | Function |
|------------------------------|-----------------------------------------------------------------------------------------------------------------------------------------------------------------------------------------------------------------------------------------------------------------------------------------------------------------------------------------------------------------------------------------------------------------------------------------------------------|
| ❶ Preference A/B Button | Press to set a preferred source: the first press sets source A, the second press sets source B, and the third press sets no preference. |
| ❷ Source A and B LEDs | Indicate preferred source. If no source is preferred, both LEDs are illuminated. You can also see preferred source on the LCD Display. |
| ❸ Input Connector LEDs | Provide information about input voltage from each source. If the RMS input voltage and measured frequency are within the selected tolerance range, the corresponding indicator will be illuminated. In a normal operating condition (full source redundancy) both sets of LEDs are illuminated. |
| ❹ Output Connector LEDs | Indicate which source is being used for the output (only one path will be illuminated at any time). Together, the Source Preference LEDs, the Connector LEDs, and the Output LED show the power flow through the ATS. |
| ❺ Output LED | Shows that voltage is available at the output of the ATS. |
| ❻ LCD Display | View ATS status, settings, and product information. See “LCD Display Screens” on page 13 for more information on LCD display screens. |
| ❼ Display navigation buttons | On the LCD Display, icons indicate the purpose of adjacent buttons.
🏠 Home: Press to move through default screens or return to default screens from menu screens.
⬇️ Down: Press to move through default screens, menu items, or menu screens.
⌂ Select: Press to navigate to the main menu from default screens, select menu items, or return to the main menu from menu screens.
See “LCD Display Screens” on page 13 for more information. |
| ❽ Load Status LED | See “Load Status LED” on page 12 |
| ❾ Network Status LED | See “Network Status LED” on page 12 |
| ❿ 10/100 Base-T Connector | Connects the ATS to the network. |
| ⓫ 10/100 Status LED | See “10/100 Status LED” on page 12. |
| ⓬ USB port | Use a USB drive to upgrade the firmware or download log files. |
| ⓭ Serial port | Connect your computer to the ATS for local access to the CLI. Use the supplied Serial Communication cable (APC by Schneider Electric part number 940-0144A). |
| ⓮ Reset button | Restarts ATS network and serial communication. |

Load Status LED

This LED identifies overload and warning conditions for the ATS. For more information on warning conditions, see “Configure warning thresholds” on page 88.

| Condition | Description |
|-----------|---------------------------------------------------------------------------|
| Green | The Rack ATS current is below the Near Overload Warning threshold. |
| Yellow | The Rack ATS current is above the Near Overload Warning threshold. |
| Red | The Rack ATS current is above the Overload Alarm threshold. |

Network Status LED

This LED indicates the network status.





| Condition | Description |
|-----------------------|-------------------------------------------------------------------------------------------------------------------------------------------------------------------------------------------------------------------------------------------------------------------------------------------------------------------------------------------------------------------------------------------------------------------------------------------------------------------------------------------------------------------------------------------------------------------------------------------|
| Off | One or more of the following situations exists: <ul style="list-style-type: none">• The Rack ATS is not receiving input power.• The cable that connects the Rack ATS to the network is disconnected or defective.• The device that connects the Rack ATS to the network is off or not operating correctly.• The Rack ATS is connected to an unknown network.• The Rack ATS is not operating properly. It may need to be repaired or replaced. Contact customer support at www.apc.com/support. |
| Flashing green | The Rack ATS is receiving data packets from the network at 10 Megabits per second (Mbps). |
| Flashing orange | The Rack ATS is receiving data packets from the network at 100 Megabits per second (Mbps). |
| Solid green or orange | The Rack ATS is receiving no network traffic. |

10/100 Status LED

This LED indicates the network status of the Rack ATS.

| Condition | Description |
|-----------------------------------------------------------------------------------------------------------|--------------------------------------------------------------------------------------------------------------------------------------------------------------------------------------------------------------------------------------------------------------------------------------------------------------------------------------------------------------------------------------------------------------------------------------------------------------------------------------------------------------------------------------------------------------------------------------------------------------------------------------------------------------------|
| Off | One or more of the following situations exists: <ul style="list-style-type: none">• The Rack ATS is not receiving input power.• The cable that connects the Rack ATS to the network is disconnected or defective.• The device that connects the Rack ATS to the network is disconnected or defective.• The device that connects the Rack ATS to the network is turned off.• The Rack ATS is connected to an unknown network.• The Rack ATS is not operating properly. It may need to be repaired or replaced. Contact customer support at www.apc.com/support. |
| Solid green | The Rack ATS has valid TCP/IP settings. |
| Flashing green | The Rack ATS does not have valid TCP/IP settings.* |
| Solid orange | A hardware failure has been detected in the Rack ATS. |
| Flashing orange | The Rack ATS is making BOOTP requests. |
| Flashing orange and green (alternating) | The Rack ATS is making DHCP requests. |
| *If you do not use a BOOTP or DHCP server, see “TCP/IP Configuration Methods” on page 6 for more options. | |

LCD Display Screens

The front panel LCD Display automatically rotates between four default screens. You can press Home  or Down  to move through these screens manually. You can press Select  to go to the main menu or select menu items. Down  allows you to move through menu items and menu screens.

After 30 seconds without activity, the LCD display will revert to the default screens. You can also press Home  to return to the default screens.

Default screens

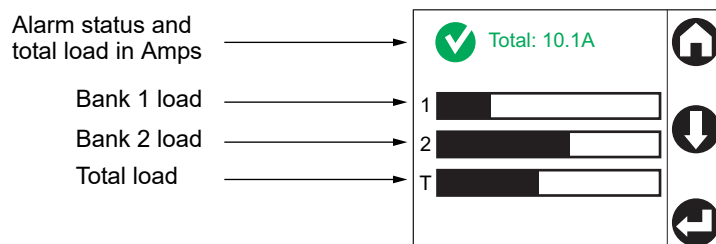
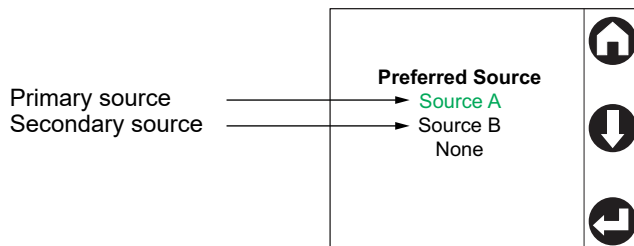
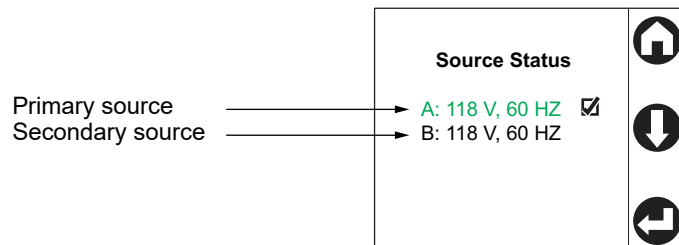
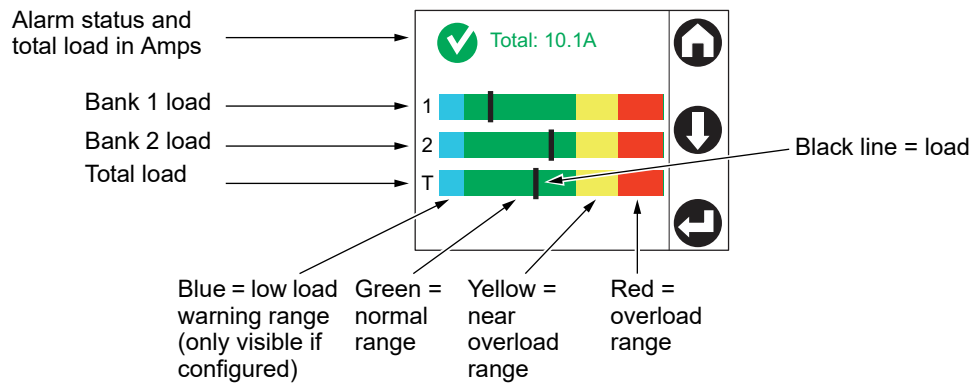

pdu0559b

NOTE: The number of banks varies by model.

Menu screens

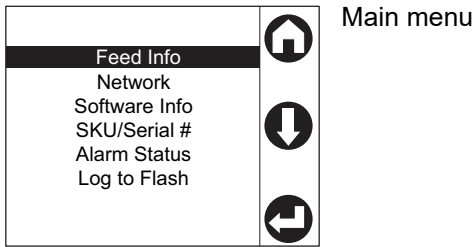

Feed Info View information for each power source (**Feed A** and **Feed B**), or view the **Preferred Source** (in green text).

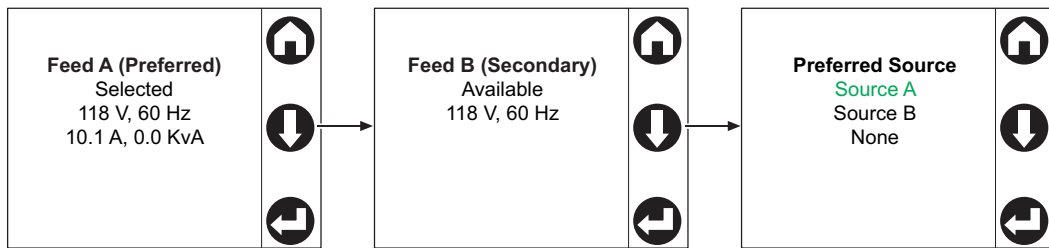

Network View the **IPv4 Address**, the **IPv6 Address**, or the **MAC Address**.

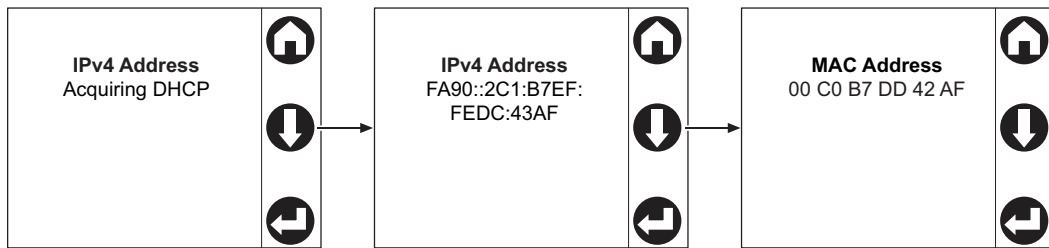

Software info View the current software version for each firmware module.

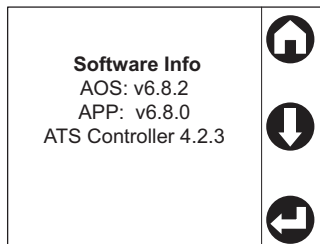

SKU/Serial# View the model and serial number for your ATS.

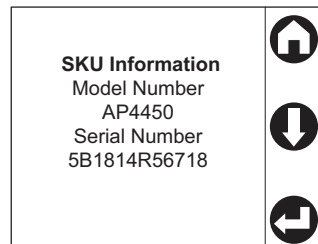

Alarm Status View active alarms.

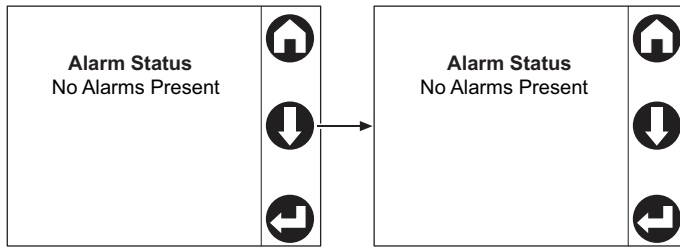

Log to Flash Use a USB drive at the USB port to download compressed log files. Extract the files on your computer to view the logs.

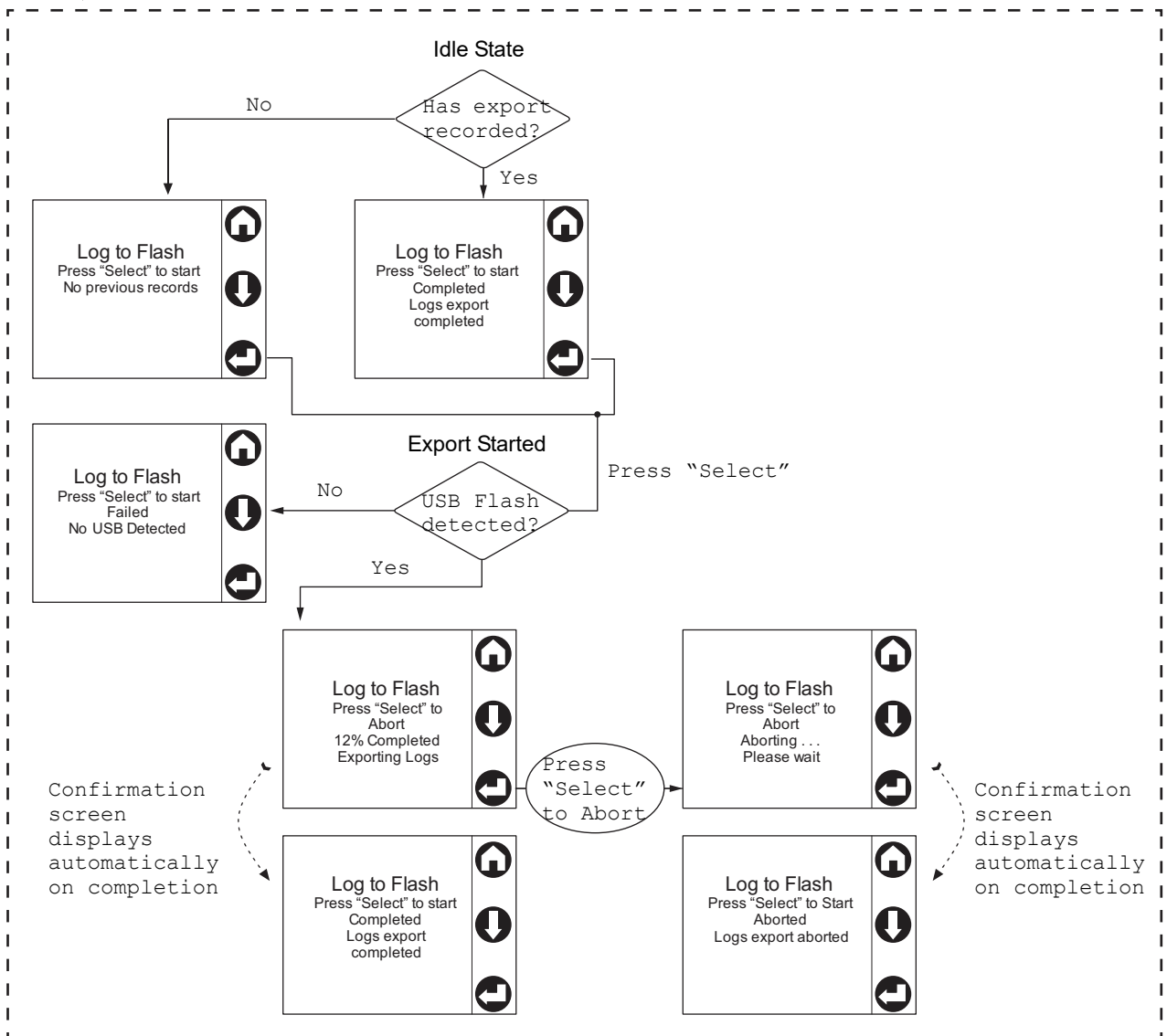

pdu0589c

Alarm status indicators

When an alarm is generated, alarm status indicators show the level of the alarm (**Warning** or **Critical**).

No Alarm screens

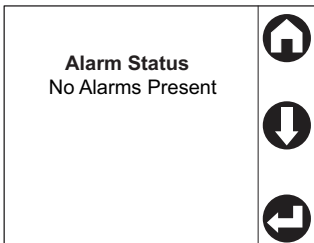
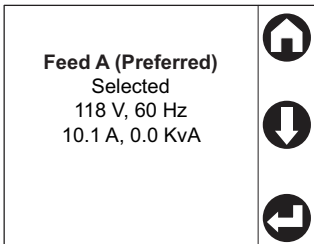
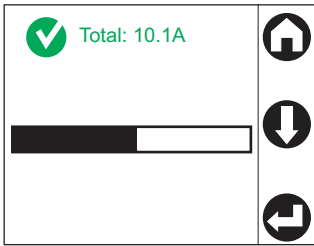
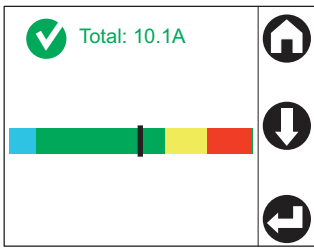

Warning Alarm (Low Load and Near Overload)

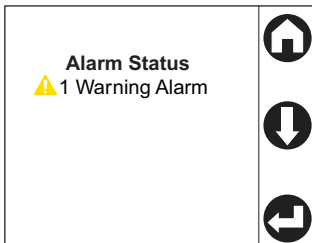
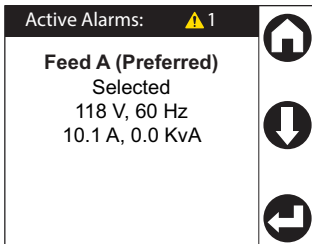
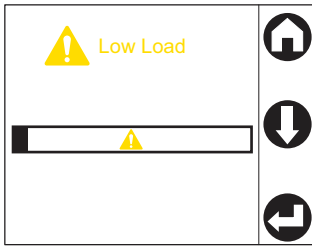
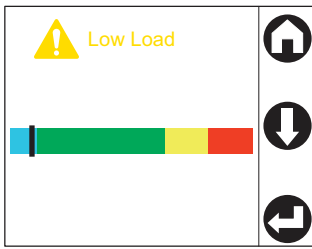

Critical Alarm (Overload) screens

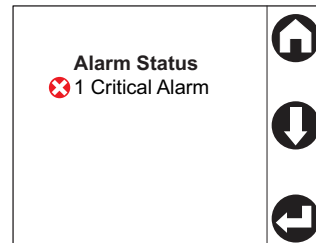
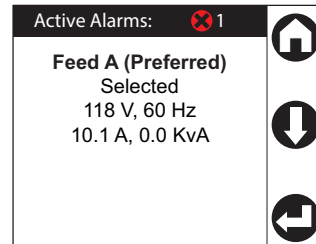
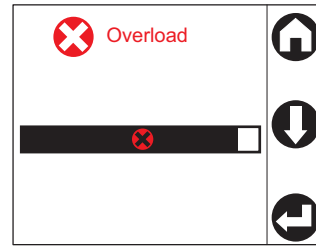
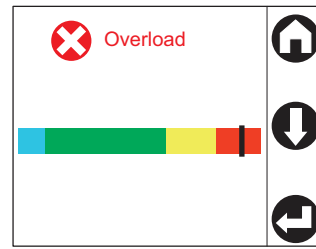

p085910

Command Line Interface

You can use the Command Line Interface (CLI) to configure, manage, and monitor the status of the Rack ATS. Additionally, the CLI enables you to create scripts for automated operation. You can configure all parameters of a Rack ATS (including those for which there are not specific CLI commands) by using the CLI to transfer an INI file to the Rack ATS. The CLI uses XMODEM to perform the transfer. However, you cannot read the current INI file through XMODEM.

Log on to the CLI

To access the CLI, you can use either a local (serial) connection or a remote (Telnet or SSH) connection with a computer on the same network as the Rack ATS.

Local access to the CLI

For local access, use a computer that connects to the Rack ATS through the serial port to access the CLI:

1. Select a serial port at the computer and disable any service that uses that port.
2. Connect the serial communication cable (940-0144A) from the selected serial port on the computer to the **Serial** port on the Rack ATS.
3. Run a terminal program (e.g., HyperTerminal) and configure the selected port for 9600 bps, 8 data bits, no parity, 1 stop bit, and no flow control.
4. Press ENTER. At the prompts, enter your user name and password (by default, `apc` and `apc` for the Super User). If this is your first log on, you will be prompted to change the default password.

Remote access to the CLI

You can choose to access the CLI through Telnet and/or SSH. SSH is enabled by default. You can use the console command (see “console” on page 31) to enable or disable either Telnet or SSH. If needed, you can also use the Web UI (see “Configure CLI access” on page 104) to enable or disable Telnet or SSH.

Telnet for basic access

Telnet provides the basic security measure of authentication by user name and password, but not the high-security benefits of encryption. Telnet is disabled by default.

To use Telnet to access the CLI:

1. At a command prompt, type `telnet` and the IP address for the Rack ATS (for example, `telnet 139.225.6.133`, when the Rack ATS uses the default Telnet port of 23), and press ENTER.

If the Rack ATS uses a non-default port number (from 5000 to 32768), you must include a colon or a space, depending on your Telnet client, between the IP address (or DNS name) and the port number. (These are commands for general usage; some clients do not allow you to specify the port as an argument and some types of Linux might require extra commands).

2. Enter the user name and password. If you cannot remember your user name or password, see “Recover from a Lost Password” on page 10.

SSH for high-security access

If you use the high security of SSL/TLS for the Web UI, use SSH for access to the CLI. SSH encrypts user names, passwords, and transmitted data. The interface, user accounts, and user access rights are the same whether you access the CLI through SSH or Telnet, but to use SSH, you must first configure SSH and have an SSH client program installed on your computer. See the *Security Handbook* on www.apc.com for more information on configuring and using SSH. SSH is enabled by default.

About the Main Screen

The following screen is displayed when you log on to the CLI of a Rack ATS.

```
Schneider Electric                Network Management Card AOS    vx.x.x
(c) Copyright 2020 All Rights Reserved  ATS 4g APP                    vx.x.x
-----
Name      : Test Lab                Date       : 9/17/20
Contact   : Don Adams              Time       : 5:58:30
Location  : Building 3             User       : Administrator
Up Time   : 0 Days 21 Hours 21 Minutes  Stat      : P+ N4+ N6+ A+
-----
IPv4      : Enabled                IPv6      : Enabled
Ping response : Enabled
-----
HTTP      : Disabled              HTTPS     : Enabled
FTP       : Disabled              Telnet   : Disabled
SSH/SCP   : Enabled               SNMPv1   : Disabled
SNMPv3    : Disabled
-----
Super User : Enabled              RADIUS   : Disabled
Administrator : Disabled        Device User : Disabled
Read-only User : Disabled        Network-Only User : Disabled

Type ? For command listing
Use tcpip for IP address (-i), subnet (-s), and gateway (-g)

apc>
```

- Two fields identify the operating system (AOS) and application (APP) firmware versions. The application firmware name identifies the type of device that connects to the network (for example, a Rack ATS).
Network Management Card AOS vx.x.x
ATS4g APP vx.x.x
- Three fields identify the system name, contact person, and location of the Rack ATS.
Name : Test Lab
Contact : Don Adams
Location : Building 3
- An **Up Time** field reports how long the Rack ATS Management Interface has been running since it was last turned on or reset.
Up Time: 0 Days, 21 Hours, 21 Minutes

- Two fields identify when you logged in, by date and time.
Date: 11/2/2019
Time: 09:06:45
- The **User** field identifies whether you logged in through the **Super User, Administrator, Device User, Read-Only, or Network-Only** account.

User: Administrator

- A **Stat** field reports the Rack ATS status.

Stat:P+ N4+ N6+ A+

| | |
|----|---------------------------------------------------------|
| P+ | The APC operating system (AOS) is functioning properly. |
|----|---------------------------------------------------------|

| IPv4 only | IPv6 only | IPv4 and IPv6* | Description |
|-----------|-----------|----------------|--------------------------------------------------|
| N+ | N+ | N4+ N6+ | The network is functioning properly. |
| N? | N6? | N4? N6? | A BOOTP request cycle is in progress. |
| N- | N6- | N4- N6- | The Rack ATS failed to connect to the network. |
| N! | N6! | N4! N6! | Another device is using the Rack ATS IP address. |

* The N4 and N6 values can be different from one another: you could, for example, have N4- N6+.

| | |
|----|-------------------------------------------------|
| A+ | The application is functioning properly. |
| A- | The application has a bad checksum. |
| A? | The application is initializing. |
| A! | The application is not compatible with the AOS. |

NOTE: If P+ is not displayed, contact the APC by Schneider Electric Customer Care Center at www.apc.com/support.

- The remaining fields show which protocols and user accounts are enabled.

Using the CLI

At the CLI, you can use commands to configure the Rack ATS. To use a command, type the command and press ENTER. Commands and arguments are valid in lowercase, uppercase, or mixed case. Options are case-sensitive.

While using the CLI, you can also do the following:

- Type `help` or `?` and press ENTER to view a list of available commands, based on your account type.
- To obtain information about the purpose and syntax of a specified command, type the command, a space, and `?` or the word `help`.
- Press the UP arrow key to view the command that was entered most recently in the session. Use the UP and DOWN arrow keys to scroll through a list of up to ten previous commands.
- Type at least one letter of a command and press the TAB key to scroll through a list of valid commands that match the text you have typed in the command line.
- Type `bye`, `exit` or `quit` to close the connection to the CLI.

Command Syntax

| Item | Description |
|------|------------------------------------------------------------------------------------------------------------------------------------------------------|
| - | Options are preceded by a hyphen. |
| < > | Definitions of options are enclosed in angle brackets.
For example: <code>-dp <device password></code> |
| [] | If a command accepts multiple options or an option accepts mutually exclusive arguments, the values may be enclosed in brackets. |
| | A vertical line between items enclosed in brackets or angle brackets indicates that the items are mutually exclusive. You must use one of the items. |

Example of a command that supports multiple options:

```
ftp [-p <port number>] [-S <enable | disable>]
```

In this example, the `ftp` command accepts the option `-p`, which defines the port number, and the option `-S`, which enables or disables the FTP feature.

To change the FTP port number to 5010, and enable FTP:

1. Enter the `ftp` command, the port option, and the argument 5010:

```
ftp -p 5010
```
2. After the first command succeeds, enter the `ftp` command, the enable/disable option, and the enable selection:

```
ftp -S enable
```

Example of a command that accepts mutually exclusive arguments for an option:

```
alarmcount -p [all | warning | critical]
```

In this example, the option `-p` accepts only three arguments: `all`, `warning`, or `critical`. For example, to view the number of active critical alarms, type:

```
alarmcount -p critical
```

The command will fail if you type an argument that is not specified.

Command Response Codes

The command response codes enable scripted operations to detect error conditions reliably without having to match error message text:

The CLI reports all command operations with the following format:

```
E [0-9] [0-9] [0-9] : Error message
```

| Code | Message |
|------|------------------------------------------------------------------------------------------------------------------------------------------|
| E000 | Success |
| E001 | Successfully Issued |
| E002 | Reboot required for change to take effect |
| E100 | Command failed |
| E101 | Command not found |
| E102 | Parameter Error
Reported when there is any problem with the arguments supplied to the command:
too few, too many, wrong type, etc. |
| E103 | Command Line Error |
| E104 | User Level Denial |
| E105 | Command Prefill |
| E106 | Data Not Available |
| E107 | Serial Communications Lost |
| E108 | EAPoL disabled due to invalid/encrypted certificate. |
| E200 | Input error. Only reported when an error occurs during the execution of a command. |
| E201 | No Response. Reported when a sensor fails to respond. |
| E202 | Invalid value |
| E203 | Device busy or lost communication. Please try again. |

Prompting for User Input during Command Execution

Certain commands require additional user input (ex. transfer .ini prompting for baud rate). There is a fixed timeout of 1 minute for such prompts. Should the user not enter any text within the timeout period, then the command will print "E100: Command Failed." and the command prompt will be redisplayed.

Command Editing

The <backspace> key will delete the last character of the command string the user is currently entering and is the only editing function available to the user during command entry.

History

The Rack ATS CLI implements a command history buffer, recalling the 10 previous commands. The user can navigate backwards and forwards through entered commands using the <up arrow> and <down arrow> keys respectively.

Auto Completion

The Rack ATS CLI supports command auto-completion. If a partial command is entered, then the <TAB> key can be used to complete the command to the first available matched command. If such a match exists, the command line shall be completed by the system.

Additional presses of the <TAB> key will select the next available command match. Once all available commands have been scrolled through, the original partially entered command is displayed.

Delimiter

The Rack ATS CLI will use <space> (ASCII 0x20) as the delimiter between commands and arguments. Extra white space between commands and arguments will be ignored.

Command responses will have all fields delimited with commas for efficient parsing.

Options and Arguments Inputs

Entering a command with *no options or arguments* returns the current value of all options available from that command.

Entering the command and an option with *no arguments* returns the current value of that option only. Any command followed by a question mark "?" returns help explaining the command.

```
<space> ::= (" " | multiple" ")
<valid letter_number> ::= (a-z | A-Z | 0-9)
<string> ::= (1 - 64 consecutive printable valid ASCII characters
[ranging from hex 0x20 to 0x7E inclusive] )
```

NOTE: If the string includes a blank, the entire string **MUST** be surrounded by quotes (" ").

```
<option> ::= "-"(<valid letter_number> | <valid letter_number><valid
letter_number>)
<argument> ::=
<helpArg> | <alarmcountArg> | <bootArg> | <cdArg> | <consoleArg> |
<dateArg> | <deleteArg> | <ftpArg> | <pingArg> | <portspeedArg> |
<promptArg> | <radiusArg> | <resettodefArg> | <systemArg> |
<tcpipArg> | <userArg> | <webArg> | <string>
<optionArg> ::= <option><argument>
```

Command Console and CLI Response Format

All **CLI** commands will issue:

```
<three digit response code>:<space> (followed by a readable text (response message))
```

This can be followed by <cr><lf> and the output of the command (if applicable).

Response Format and Message Codes

Successful command operations will have an error code less than 100. Any error code of 100 or greater, indicates a failure of some type.

```
E[0-9][0-9][0-9]: Error message
```

See "Command Response Codes" on page 21 for more information.

Example:

```
E000: Success (followed by the output of the command, if applicable)
```

Rack ATS System Command Descriptions

? or help

Access: Super User, Administrator, Device User, Read Only, Network Only

Description: View a list of all the CLI commands available to your account type, or view help text for a specific command.

Parameters: [<command>]

Example 1:

```
apc> ?  
System Commands:  
-----  
For command help: command ?  
  
?          about      alarmcount  boot        bye         cd  
cipher     clrrst      console     date        delete      dir  
dns        email       eventlog    exit        firewall    format  
ftp        help        lang        lastrst     ledblink    logzip  
netstat    ntp         ping        portspeed   prompt      pwd  
quit       radius      reboot      resetToDef  session     smtp  
snmp       snmptrap    snmpv3      system      tcpip       tctpip6  
user       userdfmt    web         whoami      xferINI     xferStatus  
  
Device Commands:  
-----  
aboutATS   atsMeasure  atsStatus   bkLowLoad   bkNearOver  bkOverLoad  
bkPeakLoad bkReading   freqDeviat  eventCounts  frontPanel  lcd  
lcdBlink   lineVRMS    prodInfo    sourceAName  sourceBName  sourcePref  
vMediumLmt vNarrowLmt  vSensitivty vWideLmt    vXferRange
```

Example 2:

```
apc> boot help  
Usage: boot -- Configuration Options  
boot [-b <dhcp | Bootp | manual>] (IPv4 Boot Mode)  
      [-c <enable | disable>]      (Require DHCP Cookie)  
      [-v <vendor class>]  
      [-i <client id>]  
      [-u <user class>]
```

Error Message: E000, E102

about

Access: Super User, Administrator, Device User, Read Only

Description: Displays system information (Model Number, Serial Number, Manufacture Dates, etc.)

Parameters: None

Example:

```
apc> about
E000: Success
Hardware Factory
-----
Model Number:          AP44XX
Serial Number:         ST181313012345
Hardware Revision:     R05
Manufacture Date:      05/06/19
MAC Address:           00 C0 B7 18 00 01
Management Uptime:    0 Days 1 Hour 42 Minutes

Network Management Card
-----
Model Number:          AP9538
Serial Number:         ZA1821008486
Hardware Revision:     05
Manufacture Date:      5/11/2019

Application Module
-----
Name:                  ats4g
Version:               v6.9.4
Date:                  Aug 3 2019
Time:                  18:46:52

APC OS (AOS)
-----
Name:                  aos
Version:               v6.9.4
Date:                  Aug 3 2019
Time:                  16:00:07

APC Boot Monitor
-----
Name:                  bootmon
Version:               v1.0.8
Date:                  Apr 8 2014
Time:                  10:59:40
```

Error Message: E000

alarmcount

Access: Super User, Administrator, Device User, Read Only

Description: Displays alarms present in the system. Information about the alarms is provided in the event log.

Parameters:

Option	Argument	Description
-p	all	View the total number of active alarms reported by the Rack ATS.
	warning	View the number of any kind of active alarm reported by the Rack ATS.
	critical	
	informational	

Example: To view all active warning alarms, type:

```
apc> alarmcount -p warning
E000: Success
WarningAlarmCount: 3

apc> alarmcount -p all
E000: Success
AlarmCount: 7
```

Error Message: E000, E102

boot

Access: Super User, Administrator

Description: Allows the user to get/set the network startup configuration of the device, such as setting boot mode.

Parameters:

Option	Argument	Description
-b	<dhcp bootp manual>	Define how the TCP/IP settings will be configured when the Rack ATS turns on, resets, or restarts. See "Configure TCP/IP and communication settings for IPv4 and IPv6" on page 99 for information about each boot mode setting.
-c	<enable disable>	dhcp boot mode only: Enable or disable the requirement that the DHCP server provide the APC cookie.
-v	<vendor class>	dhcp boot mode only: the Vendor Class is APC.
-i	<client id>	dhcp boot mode only: the MAC address of the NMC, Which uniquely identifies it on the network.
-u	<user class>	dhcp boot mode only: the name of the application firmware module.

Example: Using a DHCP server to obtain network settings:

```
apc> boot
E000: Success
Boot Mode:                manual
Non-Manual Mode Shared Settings
-----
Vendor class:             <device class>
Client id:                XX XX XX XX XX XX
User class:               <user class>
After IP assignment:      gotoDhcpOrBootp

DHCP Settings
-----
Retry then stop:         4
DHCP cookie is:         enable

BOOTP Settings
-----
Retry then fail:         never
On retry failure:        prevSettings
```

Error Message: E000, E102

bye, exit, or quit

Access: Super User, Administrator, Device User, Read Only, Network-Only User

Description: Exit from the CLI session.

Parameters: None

Example:

```
apc> exit
Bye
```

Error Message: None

cd

Access: Super User, Administrator, Device User, Read Only

Description: Allows the user to set the working directory of the file system. The working directory is set back to the root directory '/' when the user logs out of the CLI.

Parameters: <directory name>

Example:

```
apc> cd logs
E000: Success

apc> cd /
E000: Success
```

Error Message: E000, E102

cipher

Access: Super User, Administrator

Description: Enable or disable cryptographic algorithms for Web UI sessions. You cannot enable or disable these algorithms directly from the Web interface. You must reboot your NMC after enabling or disabling algorithms for changes to take effect.

There are three categories of algorithms: Authentication Algorithms, Block Cipher Algorithms, and MAC Algorithms. Available and Blocked Cipher Suites are also listed.

NOTE: Disabling the only algorithm in a category will block all SSL/TLS sessions and HTTPS access may not work depending on your browser and its configuration.

NOTE: In v6.7.2 and higher, you must explicitly enable or disable an algorithm.

Option	Argument	Description
-3des	enable disable	Enable or disable Triple DES.
-aes	enable disable	Enable or disable Advanced Encryption Standard (AES).
-dh	enable disable	Enable or disable Diffie-Hellman (DH).
-rsake	enable disable	Enable or disable RSA key exchange.
-rsaau	enable disable	Enable or disable RSA authentication.
-sha1	enable disable	Enable or disable Secure Hash Algorithm 1 (SHA-1).
-sha2	enable disable	Enable or disable Secure Hash Algorithm 2(SHA-2).
-ecdhe	enable disable	Enable or disable Elliptic Curve Diffie-Hellman Exchange (ECDHE).

Example: Disable triple-DES.

```
cipher -3des disable
E000: Success
Reboot required for change to take effect.
```

Error Message: E000, E102

Example 2: Retrieve a list of each available cryptographic algorithm and its status.

```
apc> cipher

E000: Success
Key Exchange Algorithms
-----

                DH                enabled
                RSA Key Exchange   enabled

Authentication Algorithms
-----

(Warning: disabling the only algorithm in category
          will block all SSL/TLS sessions)

                RSA Authentication  enabled

Block Cipher Algorithms
-----

                triple-DES         enabled
                RC4                 enabled
                AES                 enabled

MAC Algorithms
-----

                MD5                 enabled
                SHA                 enabled
                SHA256              enabled

Available Cipher Suites
-----

1      TLS_DHE_RSA_WITH_3DES_EDE_CBC_SHA
2      TLS_DHE_RSA_WITH_AES_128_CBC_SHA
3      TLS_DHE_RSA_WITH_AES_128_CBC_SHA256
4      TLS_DHE_RSA_WITH_AES_256_CBC_SHA
5      TLS_DHE_RSA_WITH_AES_256_CBC_SHA256
6      SSL_RSA_WITH_3DES_EDE_CBC_SHA
7      TLS_RSA_WITH_AES_128_CBC_SHA
8      TLS_RSA_WITH_AES_256_CBC_SHA
9      TLS_RSA_WITH_AES_128_CBC_SHA256
10     TLS_RSA_WITH_AES_256_CBC_SHA256
11     SSL_RSA_WITH_RC4_128_SHA
12     SSL_RSA_WITH_RC4_128_MD5
13     SSL_RSA_EXPORT_WITH_RC4_40_MD5

Blocked Cipher Suites
-----

None
```

Error Message: E000, E102

clrrst

Access: Super User, Administrator, Device User

Description: Clear reset reason.

Parameters: None

Example: None

Error Message: None

console

Access: Super User, Administrator

Description: Define whether users can access the CLI using Telnet, which is disabled by default, or Secure SHell (SSH), which is enabled by default and provides protection by transmitting user names, passwords, and data in encrypted form. You can change the Telnet or SSH port setting for additional security. Alternately, disable network access to the CLI.

Parameters:

Option	Argument	Description
-s	<enable disable>	Enable or disable SSH access to the device. Enabling SSH enables SCP.
-t	<enable disable>	Enable or disable Telnet access to the device.
-pt	<telnet port>	Define the Telnet port used to communicate with the Rack ATS (23 by default, optional 5000–32768).
-ps	<SSH port>	Define the SSH port used to communicate with the Rack ATS (22 by default, optional 5000–32768).
-b	<2400 9600 19200 38400>	Configure the speed of the serial port connection (serial baud rate) in bits per second (bps). The default is 9600 bps.

Example 1: To enable SSH access to the CLI:

```
apc> console -s enable
E000: Success
SSH: enabled
```

Example 2: To view the serial baud rate:

```
apc> console -b
E000: Success
Baud Rate: 9600
```

Error Message:E100, E102

date

Access: Super User, Administrator

Description: Get and set the date and time of the system. To configure an NTP server to define the date and time for the Rack ATS, see “Configure date, time, and daylight savings” on page 116.

Parameters:

Option	Argument	Description
-d	<"datestring">	Set the current date. The format must match the current -f setting.
-t	<00:00:00>	Configure the current time, in hours, minutes, and seconds. Use the 24-hour clock format.
-f	<mm/dd/yy dd.mm.yyyy mmm-dd-yy dd-mmm-yy yyyy-mm-dd>	Select the numerical format in which to display all dates in this user interface. Each letter m (for month), d (for day), and y (for year) represents one digit. Single-digit days and months are displayed with a leading zero.
-z	<time zone offset>	Set the difference with GMT in order to specify your time zone. This enables you to synchronize with other people in different time zones.

Example 1: To display the date:

```
apc> date
E000: Success
Date: 11/02/2019
Time: 09:06:45
Format: mm/dd/yyyy
Time Zone: -05:00
```

Example 2: To define the date as November 3, 2019 using the yyyy/mm/dd format:

```
date -d "2019/11/03"
```

Example 3: To define the time as 5:21:03 p.m., type:

```
date -t 05:21:03
```

Error Message: E000, E100, E102

delete

Access: Super User, Administrator

Description: Delete a file in the file system.

Parameters:

Argument	Description
<file name>	Type the name of the file to delete.

Example:

```
apc> delete /db/prefs.dat
E000: Success
```

Error Messages: E000, E102

dir

Access: Super User, Administrator, Device User, Read Only

Description: Displays the content of the working directory.

Parameters

Argument	Description
<all dir name>	Show the contents of the current (or specified) directory.

Example:

```
apc> dir
E000: Success
2978816 Aug  3  17:46  apc_hw05_aos_694.bin
1803460 Sep 19  17:44  apc_hw05_ats4g_6.9.4.bin
45000   Nov  2   7:45  config.ini
      0 Oct 31  14:04  db/
      0 Oct 31  14:04  ssl/
      0 Oct 31  14:04  ssh/
      0 Oct 31  14:04  logs/
      0 Oct 31  14:04  sec/
      0 Oct 31  14:04  dbg/
      0 Oct 31  14:04  fwl/
      0 Oct 31  14:04  email/
      0 Oct 31  14:04  lang/
      0 Oct 31  14:04  rms/
```

Error Messages: E000

dns

Access: Super User, Administrator

Description: Configure the manual Domain Name System (DNS) settings.

Parameters

Option	Argument	Description
-OM	<enable disable>	Override the manual DNS.
-p	<primary DNS server>	Set the primary DNS server.
-s	<secondary DNS server>	Set the secondary DNS server.
-d	<domain name>	Set the domain name.
-n	<domain name IPv6>	Set the domain name IPv6.
-h	<host name>	Set the host name.
-y	<enable disable>	System-host name sync

Example:

```
apc> dns
E000: Success
Active Primary DNS Server:      x.x.x.x
Active Secondary DNS Server:    x.x.x.x

Override Manual DNS Settings:   enabled
Primary DNS Server:            x.x.x.x
Secondary DNS Server:          x.x.x.x
Domain Name:                   example.com
Domain Name IPv6:              example.com
System Name Sync:              Enabled
Host Name:                     ExampleHostName
```

Error Message: E000, E102

eapol

Access: Super User, Administrator, User

Description: Configure EAPoL (802.1X Security) settings.

Parameters:

Option	Argument	Definition
-S	<enable disable>	Enable or disable EAPoL.
-n	<supplicant name>	Set the supplicant name.
-p	<private key passphrase>	Set the private key passphrase.

Example 1: To display the result of an eapol command:

```
apc>eapol
E000: Success
Active EAPoL Settings
-----
Status:enabled
Supplicant Name:NMC-Supplicant
Passphrase:<hidden>
CA file Status:Valid Certificate
Private Key Status:Valid Certificate
Public Key Status:Valid Certificate
Result:Success
```

Example 2: To enable EAPoL:

```
apc>eapol -S enable
E002: Success
Reboot required for change to take effect.
```

Example 3: To change the supplicant name:

```
apc>eapol -n "NMC-Supplicant"
E000: Success
```

Example 4: To set the passphrase:

```
apc>eapol -p "client_password"
E000: Success
```

email

Access: Super User, Administrator, Device User

Description: View email

Parameters:

Option	Argument	Description
-g[n]	<enable disable>	Enable/disable generation.
-t[n]	<To Address>	Set the To address.
-o[n]	<long short>	Set the format (long or short).
-l[n]	<Language Code>	Set the language code; this should be supported by current language pack.
-r[n]	<Local recipient custom>	Set the route (local, recipient, or custom).
Custom Route Option		
-f[n]	<From Address>	Set the From address.
-s{n}	<SMTP Server>	Set the smtp server address.
-p[n]	<Port>	Set the port.
-a[n]	<enable disable>	Enable/disable authentication.
-u[n]	<User Name>	Set the user name.
-w[n]	<Password>	Set the password.
-e[n]	<none ifsupported always implicit>	Set the encryption.
-c[n]	<enable disable >	Enable/disable the requiring of certificates.
-i[n]	<Certificate File Name>	Set the certificate file name.
n = Email Recipient Number (1,2,3 or 4)		

Example:

```
apc> email
E000: Success

Recipient:    1
Generation:   enabled
Address:      example@example.com
Format:       long
Language:     enUs - English
Route:        local
```

Error Message: E000, E102

eventlog

Access: Super User, Administrator, Device User, Read Only

Description: View the date and time you retrieved the event log, the status of the Rack ATS, and the status of sensors connected to the Rack ATS. View the most recent device events and the date and time they occurred. Use the following keys to navigate the event log:

Key	Description
ESC	Close the event log and return to the CLI.
ENTER	Update the log display. Use this command to view events that were recorded after you last retrieved and displayed the log.
SPACEBAR	View the next page of the event log.
B	View the preceding page of the event log. This command is not available at the main page of the event log.
D	Delete the event log. Follow the prompts to confirm or deny the deletion. Deleted events cannot be retrieved.

Example:

```
apc> eventlog
---- Event Log -----
Date: 11/02/2019 Time: 09:06:45
-----
Automatic Transfer Switch: Source B selected, Switchover Possible

Date          Time          User          Event
-----
11/02/2019 07:17:22  apc          CLI user 'apc' logged in from
10.218.116.179
11/02/2019 12:16:57  apc          CLI user 'apc' logged out from
10.218.116.179
11/01/2019 13:16:49  apc          CLI user 'apc' logged in from
10.218.116.179
11/03/2019 14:16:35  apc          CLI user 'apc' logged out from
10.218.116.179
10/28/2019 13:15:30  System      CLI user 'apc' logged out from
serial port.
10/28/2019 13:15:00  ATS         Automatic Transfer Switch: Voltage
Transfer Range Configuration change.

<ESC>- Exit, <ENTER>- Refresh, <SPACE>- Next, <D>- Delete
```

Error Message: E000, E100

exit

See “bye, exit, or quit” on page 28.

firewall

Access: Super User, Administrator

Description: Establishes a barrier between a trusted, secure internal network and another network.

Parameters:

Option	Argument	Description
-S	<enable disable>	Enable or disable the Firewall.
-f	<file name to activate>	Name of the firewall to activate.
-t	<file name to test> <duration time in minutes>	Name of firewall to test and duration time in minutes.
-fe	No argument. List only	Shows active file errors.
-te	No argument. List only	Shows test file errors.
-c	No argument. List only	Cancel a firewall test.
-r	No argument. List only	Shows active firewall rules.
-l	No argument. List only	Shows firewall activity log.
-Y	No argument.	Skip firewall test prompt.

Example 1:

```
apc> firewall -S enable
Firewall should be tested with "firewall -t example.fwl" before
enabling it. Are you sure you want to enable it now?
Enter 'YES' to continue or <ENTER> to cancel : YES
E000: Success
```

Example 2:

```
apc> firewall -S enable -Y
E000: Success
```

Error Message: E000, E100, E102

format

Access: Super User, Administrator

Description: Allows the user to format the FLASH file system. This will delete all configuration data (including network settings), event and data logs, certificates and keys, and reset the card to the factory defaults. See "resetToDef" on page 45.

Parameters: None

Example:

```
apc> format
Format FLASH file system
Warning: This will delete all configuration data,
        event and data logs, certs and keys.
Enter 'YES' to continue or <ENTER> to cancel:
apc> YES
```

Error Message: None

ftp

Access: Super User, Administrator

Description: Get/set the FTP configuration data,

NOTE: The system will reboot if any configuration is changed.

Parameters:

Option	Argument	Description
-p	<port number>	Define the TCP/IP port that the FTP server uses to communicate with the Rack ATS (21 by default). The FTP server uses both the specified port and the port one number lower than the specified port. Valid values are 21 and 5000-32768.
-S	<enable disable>	Configure access to the FTP server.

Example: To change the TCP/IP port:

```
apc> ftp -p 5001
E000: Success
Reboot required for change to take effect.
```

```
apc> ftp
E000: Success
Service:          Enabled
Ftp Port:         5001
```

```
apc> ftp -p 21
E000: Success
Reboot required for change to take effect
```

Error Message: E000, E102

help

See “? or help” on page 24.

lang

Access: Super User, Administrator, Device User, Read Only

Description: Displays the language in use.

Parameters: None

Example:

```
apc> lang
E000: Success

Languages
enUs - English
```

Error Message: None

lastrst

Access: Super User, Administrator, Device User

Description: Last reset reason

Parameters: None

Example:

```
apc> lastrst
04 Requested Reset
E000: Success
```

Error Message: None

ledblink

Access: Super User, Administrator, Device User

Description: Sets the LED on the Rack ATS to blink.

Parameters:

Argument	Description
<duration time in minutes>	Set the number of minutes for the LED to blink.

Example:

```
apc> ledblink 2
E000 Success
```

Error Message: None

logzip

Access: Super User, Administrator, Device User

Description: Places large logs into a zip file before sending.

Parameters:

Option	Argument	Description
-m	<email recipient>	Email recipient number (1-4)

Example:

```
apc> logzip -m 1
Generating files
Compressing files into /dbg/debug_ZA1023006009.tar
E000: Success
```

Error Message: E000

netstat

Access: Super User, Administrator, Device User, Read Only

Description: Displays incoming and outgoing network connections.

Parameters: None

Example:

```
apc> netstat
```

```
Current IP Information:
```

Family	mHome	Type	IPAddress	Status
IPv6	4	auto	FE80::2C0:B7FF:FE51:F304/64	configured
IPv4	0	dhcp	10.218.117.43/24	configured
IPv6	0	manual	::1/128	configured
IPv4	0	manual	127.0.0.1/32	configured

Error Message: E000, E102

ntp

Access: Super User, Administrator

Description: Synchronizes the time of a computer client or server.

Parameters

Option	Argument	Description
-OM	<enable disable>	Override the manual settings.
-p	<primary NTP server>	Specify the primary server.
-s	<secondary NTP server>	Specify the secondary server.

Example 1: To enable the override of manual setting, type:

```
apc> ntp -OM enable
E000: Success
NTP status: Enabled
```

Example 2: To specify the primary NTP server, type:

```
apc> ntp -p 150.250.6.10
E000: Success
Primary NTP Server: 150.250.6.10
```

Error Message: E000, E102

ping

Access: Super User, Administrator, Device User

Description Perform a network 'ping' to any external network device.

Parameters

Argument	Description
<IP address or DNS name>	Type an IP address with the format xxx.xxx.xxx.xxx, or the DNS name configured by the DNS server.

Example:

```
apc> ping 192.168.1.50
E000: Success
Reply from 192.168.1.50: time(ms)= <10
Reply from 192.168.1.50: time(ms)= <10
Reply from 192.168.1.50: time(ms)= <10
Reply from 192.168.1.50: time(ms)= <10
```

Error Message: E000, E100, E102

portSpeed

Access: Super User, Administrator

Description: Allows the user to get/set the network port speed.

NOTE: The system will reboot if any configuration is changed.

Parameters

Option	Argument	Description
-s	<auto 10H 10F 100H 100F>	Define the communication speed of the Ethernet port. The auto command enables the Ethernet devices to negotiate to transmit at the highest possible speed. See "Configure network port speed" on page 101 for more information about the port speed settings.
	H = Half Duplex	10 = 10 Meg Bits
	F = Full Duplex	100 = 100 Meg Bits

Example:

```
apc> portspeed
E000: Success
Port Speed: Auto_negotiation
Current Port Speed: 100 Full_Duplex
```

Error Message: E000, E102

prompt

Access: Super User, Administrator, Device User

Description: Change the format of the prompt, either short or long

Parameters

Option	Argument	Description
-s	long	The prompt includes the account type of the currently logged-in user.
	short	The default setting. The prompt is four characters long: APC>

Example:

```
apc> prompt -s long
E000: Success

apc@apc> prompt -s short
E000: Success

apc>_
```

Error Message: E000, E102

pwd

Access: Super User, Administrator, Device User, Read Only

Description: Used to output the path of the current working directory.

Parameters: None

Example:

```
apc> pwd
/

apc> cd logs
E000: Success

apc> pwd
/logs
```

Error Message: E000, E102

radius

Access: Super User, Administrator

Description: View the existing RADIUS settings, enable or disable RADIUS authentication, and configure basic authentication parameters for up to two RADIUS servers.

For a summary of RADIUS server configuration and a list of supported RADIUS servers, see “Configure a RADIUS server” on page 94.

Additional authentication parameters for RADIUS servers are available at the Web UI of the Rack ATS. See “Manage remote user settings” on page 93 for more information.

For detailed information about configuring your RADIUS server, see the *Security Handbook*, available at www.apc.com.

Parameters

Option	Argument	Description
-a	<local radiusLocal radius>	Configure RADIUS authentication: <ul style="list-style-type: none">• local: RADIUS is disabled. Local authentication is enabled.• radiusLocal: RADIUS, then Local Authentication. RADIUS and local authentication are enabled. Authentication is requested from the RADIUS server first. If the RADIUS server fails to respond, local authentication is used.• radius: RADIUS is enabled. Local authentication is disabled.
-p1 -p2	<server IP>	The server name or IP address of the primary or secondary RADIUS server. NOTE: RADIUS servers use port 1812 by default to authenticate users. To use a different port, add a colon followed by the new port number to the end of the RADIUS server name or IP address. The Rack ATS supports ports 1812, 5000 to 32768.
-o1 -o2	<server port>	The port for the primary or secondary RADIUS sever.
-s1 -s2	<server secret>	The shared secret between the primary or secondary RADIUS server and the Rack ATS.
-t1 -t2	<server timeout>	The time in seconds that the Rack ATS waits for a response from the primary or secondary RADIUS server.

Example 1: To view the existing RADIUS settings for the Rack ATS, type `radius` and press ENTER.

```
apc> radius
E000: Success
Access:                               Local Only
Primary Server:                        0.0.0.0
Primary Server Port:                   1812
Primary Server Secret:                  <Password Hidden>
Primary Server Timeout:                 5
Secondary Server:                       0.0.0.0
Secondary Server Port:                  1812
Secondary Server Secret:                <Password Hidden>
Secondary Server Timeout:                5
```

Error Message: E000, E102

reboot

Access: Super User, Administrator

Description: Restart the NMC interface of the Rack ATS only. Forces the network device to reboot. User must confirm this operation by entering a “YES” after the command has been entered.

Parameters:

Option	Description
-Y	Skip confirmation prompt. (Uppercase Y only.)

Example 1:

```
apc> reboot
E000: Success
Reboot Management Interface
Enter 'Y' to continue or <ENTER> to cancel : <user enters 'YES'>
Rebooting...
```

Example 2:

```
apc> reboot -Y
E000: Success
Reboot Management Interface
Rebooting...
```

Error Message: E000, E100

resetToDef

Access: Super User, Administrator

Description: Reset all parameters to their default. Deletes all accounts and clears event and data logs. Resets all configuration changes, including event actions, device settings, and, optionally, TCP/IP configurations settings.

Parameters:

Option	Argument	Description
-p	<all keepip>	<ul style="list-style-type: none">• all: all configuration data, including the IP address.• keepip: all configuration data, except the IP address. Reset all configuration changes, including event actions, device settings, and, optionally, TCP/IP configuration settings.

Example: To reset all of the configuration changes *except* the TCP/IP settings for the Rack ATS, type:

```
resetToDef -p keepip
Enter 'YES' to continue or <ENTER> to cancel : : <user enters 'YES'>
all User Names, Passwords.
Please wait...

Please reboot system for changes to take effect!
```

Error Message: E000, E100

session

Access: Super User, Administrator, Device User

Description: Records who is logged in, the serial, time and ID.

Parameters:

Option	Argument	Description
-d	<session ID>	End user session.
-m	<enable disable>	Allow multiple users to be logged on at once.
-a	<enable disable>	Enable or disable Serial Remote Authentication Override, which allows users to Bypass RADIUS by using a serial connection to the CLI.

Example:

```
apc> session
User          Interface  Address      Logged In Time  ID
-----
apc           Web        x.x.x.x      00:00:08       156
apc           Telnet    x.x.x.x      00:00:02       157
E000: Success
```

Error Message: E000, E102

smtp

Access: Super User, Administrator

Description: Internet standard for electronic mail.

Parameters:

Option	Argument	Description
-f	<From Address>	Set e-mail From address.
-s	<SMTP Server>	Set the SMTP server address.
-p	<Port>	Set e-mail recipient port number. Options include 25, 2525, 465, 587, and 5000 to 32768.
-a	<enable disable>	Enable or disable authentication
-u	<User Name>	Set user name for authentication.
-w	<Password>	Set e-mail password for authentication.
-e	<none ifavail always implicit>	Define when to use encryption.
-c	<enable disable>	Enable or disable certificate requirement.
-i	<Certificate File Name>	Set the certificate file name.

Example:

```
apc> smtp
E000: Success
```

```
From:          address@example.com
Server:        mail.example.com
Port:          25
Auth:          disabled
User:          User
Password:      <not set>
Encryption:    none
Req. Cert:     disabled
Cert File:     <n/a>
```

Error Message: E000, E102

snmp

Access: Super User, Administrator

Description: Enable or disable SNMPv1. Set configuration for up to 4 Access Control groups.

NOTE: SNMPv2c uses SNMPv1 configuration settings.

Parameters:

Option	Argument	Description
-S	<enable disable>	Enable or disable SNMPv1. SNMPv1 is disabled by default,
-c[n]	<Community>	Identify the group of Rack ATS units for access control.
-a[n]	<read write writeplus disable>	Set the access level.
-n[n]	<IP or Domain Name>	Set the host's name or address
[n] = Access Control # (1, 2, 3, or 4)		

Example:

```
apc> snmp
E000: Success
SNMPv1:      enabled

Access Control summary:
Access Control #:      1
Community:           public
Access Type:         read
Address:             0.0.0.0

Access Control #:      2
Community:           private
Access Type:         write +
Address:             0.0.0.0

Access Control #:      3
Community:           public2
Access Type:         disabled
Address:             0.0.0.0

Access Control #:      4
Community:           private2
Access Type:         disabled
Address:             0.0.0.0
```

Error Message: E000, E102

snmpv3

Access: Super User, Administrator

Description: View the existing SNMPv3 settings, enable or disable SNMPv3 and configure basic SNMP parameters. Configure up to 4 SNMPv3 user profiles.

NOTE: SNMPv3 is disabled by default. A valid user profile must be enabled with passphrases (-a[n], -c[n]) set before SNMPv3 communications can be established.

Parameters

Option	Argument	Description
-S	<enable disable>	Enable or disable SNMPv3.
-u[n]	<User Name>	Set the User Name for access control.
-c[n]	<Crypt Phrase>	Set the encryption phrase of User profile.
-a[n]	<Auth Phrase>	Set the authentication phrase of User profile.
-n[n]	<IP or Domain Name>	Set the host's name or address for access control.
-ap[n]	<sha md5 none>	Set the authentication protocol for access control.
-pp[n]	<aes des none>	Set the privacy protocol for access control.
-ac[n]	<enable disable>	Enable or disable access for this user profile.
-au[n]	<User profile name>]	Access User Profile
[n] = Access Control # (1, 2, 3, or 4)		

Example:

```
apc> snmpv3
E000: Success
SNMPv3 Configuration
  SNMPV3:          disabled

SNMPv3 User Profiles

  Index:           1
  User Name:       apc snmp profile1
  Authentication:  None
  Encryption:      None

  Index:           2
  User Name:       apc snmp profile2
  Authentication:  None
  Encryption:      None

SNMPv3 Access Control

  Index:           1
  User Name:       apc snmp profile1
  Access:          disabled
  NMS IP/Host Name: 0.0.0.0

  Index:           2
  User Name:       apc snmp profile2
  Access:          disabled
  NMS IP/Host Name: 0.0.0.0
```

Error Message: None

snmptrap

Access: Super User, Administrator

Description: Enable or disable SNMP trap generation

Parameters:

Option	Argument	
-c[n]	<Community>	Set the community for the trap receiver.
-r[n]	<Receiver NMS IP>	Set the NMS IP address for the trap receiver.
-l[n]	<Language>	Enter the language code for the trap receiver.
-t[n]	<snmpV1 snmpV3>	Set the trap type for the trap receiver.
-g[n]	<enable disable>	Enable or disable trap generation for the trap receiver.
-a[n]	<enable disable>	Enable or disable trap authentication traps for the trap receiver.
-u[n]	<profile1 profile2 profile3 profile4>	Set the user name for a trap receiver profile.
[n]	= Trap receiver # (1,2,3,4,5 or 6)	

Example:

```
apc> snmptrap
E000: Success
```

SNMP Trap Configuration

```
Index:          1
Receiver IP:    x.x.x.x
Community:     public
Trap Type:     SNMPV1
Generation:    disabled
Auth Traps:    enabled
User Name:     apc snmp profile1
Language:      enUs - English
```

Error Message: E000, E102

system

Access: Super User, Administrator

Description: View and set the system name, the contact, the location and view up time as well as the date and time, the logged-on user, and the high-level system status P, N, A (see “About the Main Screen” on page 18 for more information about system status).

Parameters:

Option	Argument	Description
-n	<system-name>	Define the device name, the name of the person responsible for the device, and the physical location of the device. These values are also used by StruxureWare Data Center Expert, EcoStruxure IT, and the Rack ATS's SNMP agent. NOTE: If you define a value with more than one word, you must enclose the value in quotation marks.
-c	<system-contact>	
-l	<system-location>	
-m	<system-message>	When defined, a custom message will appear on the log on screen for all users.
-s	<enable disable>]	Allow the host name to be synchronized with the system name so both fields automatically contain the same value. NOTE: When enabling this feature, the system name identifier can no longer contain a space character (since it will be synchronized to the host name field).

Example 1:

```
apc> system
E000: Success
Host Name Sync: Disabled
Name: apcB76B83
Contact: Unknown
Location: Unknown
Message:
DateTime: 11/02/2019:09:06:45
User: apc
Up Time: 5 Days 2 Hours 35 Minutes
Stat: P+ N4+ N6+ A+
Bootmon: bootmon:v1.0.8
AOS: aos:v6.6.4
App: ats4g:v6.6.4
```

Error Message: E000, E102

tcpip

Access: Super User, Administrator

Description: View and manually configure these network settings for the Rack ATS.

Parameters:

Option	Argument	Description
-i	<IPv4 address>	Enter the IPv4 address of the Rack ATS, using the format xxx.xxx.xxx.xxx
-s	<subnet mask>	Enter the subnet mask for the Rack ATS.
-g	<gateway>	Enter the IP address of the default gateway. Do not use the loopback address (127.0.0.1) as the default gateway.
-d	<domain name>	Enter the DNS name configured by the DNS server.
-h	<host name>	Enter the host name that the Rack ATS will use.
-S	<enable disable>	Enable or disable IPv4.

Example 1: To view the network settings of the Rack ATS, type `tcpip` and press ENTER.

```
apc> tcpip
E000: Success

Active IPv4 Settings
-----
Active IPv4 Address:      192.168.1.50
Active IPv4 Subnet Mask:  255.255.255.0
Active IPv4 Gateway:     192.168.1.1

Manually Configured IPv4 Settings
-----
IPv4:                     enabled
Manual Settings:         disabled

IPv4 Address:             0.0.0.0
Subnet Mask:              0.0.0.0
Gateway:                  0.0.0.0
Mac Address:              00 c0 b7 f4 39 d5
Domain Name:              example.com
Host Name:                 HostName
```

Example 2: To manually configure an IP address of 150.250.6.10 for the Rack ATS, type:

```
apc> tcpip -i 150.250.6.10
E000: Success
```

Error Messages: E000, E102

tcpip6

Access: Super User, Administrator

Description: Enable IPv6 and view and manually configure network settings for the Rack ATS.

Parameters:

Option	Argument	Description
-S	<enable disable>	Enable or disable IPv6.
-man	<enable disable>	Enable or disable manual addressing for the IPv6 address.
-auto	<enable disable>	Enable or disable automatic configuration for the IPv6 address.
-i	<IPv6 address>	Set the IPv6 address of the Rack ATS.
-g	<IPv6 gateway>	Set the IPv6 address of the default gateway.
-d6	<router stateful stateless never>	Set the DHCPv6 mode: <ul style="list-style-type: none">• router: DHCPv6 is controlled by the flags received in IPv6 router advertisements.• statefull: DHCPv6 is used to obtain addresses AND other configuration settings.• stateless: DHCPv6 is used to configure settings other than addresses.• never: Disable DHCP.

Example: To view the network settings of the Rack ATS, type `tcpip6` and press ENTER.

```
apc> tcpip6
E000: Success

IPv6:                enabled
Manual Settings:    disabled

IPv6 Address:        ::/64
MAC Address:         XX XX XX XX XX XX
Gateway:             ::
IPv6 Manual Address: disabled
IPv6 Autoconfiguration: enabled
DHCPv6 Mode:         router controlled
```

Error Message: E000, E102

user

Access: Super User, Administrator

Description: Configure individual user accounts. All users must have a user name, password, and account type. You can edit a user account, but not a user name. You must delete the account and then create a new user. User values left unconfigured will be controlled by the userdfit command. For information on the permissions granted to each account type, see “Types of User Accounts” on page 5.

Parameters

Option	Argument	Description
-n	<user>	Set user name, or define the user for whom you are changing settings.
-cp	<current password>	Required to create a Super User account.
-pw	<user password>	Set a new user password.
-pe	<Administrator Device Read-Only Network-Only>	Set the user permission level.
-d	<user description>	Provide additional details about the user.
-e	<enable disable>	Enable or disable access to the ATS.
-st	<session timeout>	Specify how long a session waits before logging off a user when the keyboard is idle.
-sr	<enable disable>	Enable or disable Serial Remote Authentication Override, which allows users to Bypass RADIUS by using a serial connection to the CLI.
-el	<enable disable>	Enable or disable Event Log color coding.
-lf	<tab csv>	Set the format for exporting a log file.
-ts	<us metric>	Set the temperature scale: Fahrenheit or Celsius.
-df	<mm/dd/yyyy dd.mm.yyyy mmm-dd-yy dd-mmm-yy yyyy-mm-dd>	Set a date format.
-lg	<language code>	Set the user language.
-del	<user name>	Delete a user.
-l	none	Show the current user list.

Example:

```
apc> user -n apc
E000: Success
Access: Enabled
User Name: apc
Password: <hidden>
User Permission: Super User
User Description: User Description
Session Timeout: 3 minutes
Serial Remote Authentication Override: Disabled
Event Log Color Coding: Enabled
Export Log Format: Tab
Temperature Scale: Metric
Date Format: mm/dd/yyyy
Language: English (enUs)
```

Error Message: E000, E102

userdflt

Access: Super User, Administrator

Description: Complimentary function to “user” establishing default user preferences. There are two main features for the default user settings:

- Determine the default values to populate in each of the fields when the Super User or Administrator-level account creates a new user. These values can be changed before the settings are applied to the system.
- For remote users (user accounts not stored in the system that are remotely authenticated such as RADIUS) these are the values used for those that are not provided by the authenticating server. For example, if a RADIUS server does not provide the user with a temperature preference, the value defined in this section will be used.

Parameters:

Options	Argument	Description
-e	<enable disable>	By default, user will be enabled or disabled upon creation.
-pe	<Administrator Device Read-Only Network-Only>	Specify the default permission level and account type.
-d	<user description>	Provide additional details about the user.
-st	<session timeout>	Enter the number of minutes the ATS waits before logging out an inactive user.
-bl	<bad login attempts>	Number of incorrect login attempts allowed. Upon reaching this limit, a message is displayed saying the account has been locked. The Super User or an Administrator-level account is needed to re-enable the account. NOTE: A Super User account cannot be locked out, but can be manually disabled if necessary.
-el	<enable disable>	Enable or disable event log color coding.
-lf	<tab csv>	Specify the log export format, tab or CSV.
-ts	<us metric>	Specify the user's temperature scale: Fahrenheit or Celsius.
-df	<mm/dd/yyyy dd.mm.yyyy mmm-dd-yy dd-mmm-yy yyyy-mm-dd>	Specify the user's preferred date format.
-lg	<language code>	User language (enUs, etc).
-sp	<enable disable>	Enable or disable strong password requirements.
-pp	<interval in days>	Number of days before a password must be changed. Enter 0 to disable this requirement.

Example:

```
apc> userdflt
E000: Success
Access: Disabled
User Permission: Administrator
User Description: User Description
Session Timeout: 3 minutes
Bad Login Attempts: 0
Event Log Color Coding: Enabled
Export Log Format: Tab
Temperature Scale: Metric
Date Format: mm/dd/yyyy
Language: English (enUs)
Strong Passwords: Disabled
Require Password Change: 0 day(s) (Disabled)
```

Error Message: E000, E102

web

Access: Super User, Administrator

Description: Enable access to the Web UI using HTTP or HTTPS.

For additional security, you can change the port setting for HTTP and HTTPS to any unused port from 5000 to 32768. Users must then use a colon (:) in the address field of the browser to specify the port number. For example, for a port number of 5000 and an IP address of 152.214.12.114, type:

```
http://152.214.12.114:5000
```

Parameters:

Option	Argument	Description
-h	<enable disable>	Enable or disable access to the user interface for HTTP. HTTP is disabled by default.
-s	<enable disable>	Enable or disable access to the user interface for HTTPS. HTTPS is enabled by default. When HTTPS is enabled, data is encrypted during transmission and authenticated by a digital certificate.
-ph	<http port #>	Specify the TCP/IP port used by HTTP to communicate with the Rack ATS (80 by default). The other available range is 5000–32768.
-ps	<https port #>	Specify the TCP/IP port used by HTTPS to communicate with the Rack ATS (443 by default). The other available range is 5000–32768.
-mp	<SSL3.0 TLS1.0 TLS1.1 TLS1.2>	Enter the minimum security protocol.

Example 1: To prevent all access to the Web UI, type:

```
apc> web -h disable -s disable
```

Example 2: To define the TCP/IP port used by HTTP, type:

```
apc> web
E000: Success
Http:           enabled
Https:          disabled
Http Port:      80
Https Port:     443
Minimum Protocol: TLS1.1

apc> web -ph 80
E000: Success
Reboot required for change to take effect.
```

Error Message: E000, E102

whoami

Access: Super User, Administrator, Device Only, Read Only

Description: Provides login information on the current user.

Parameters: None

Example:

```
apc> whoami
E000: Success
admin
```

Error Message: E000, E102

xferINI

Access: Super User, Administrator

Description: Use XMODEM to upload an .ini file to the NMC while you are accessing the CLI through a serial connection. After the upload completes:

- If there are any system or network changes, the CLI restarts and you must log on again.
- If you selected a baud rate for the file transfer that is not the same as the default baud rate for the Rack ATS, you must reset the baud rate to the default to reestablish communication with the Rack ATS.

Parameters: None

Example:

```
apc> xferINI
Enter 'YES' to continue or <ENTER> to cancel : <user enters 'YES'>
----- File Transfer Baud Rate-----
      1- 2400
      2- 9600
      3- 19200
      4- 38400
> <user enters baudrate selection>
Transferring at current baud rate (9600), press <ENTER>...
<user presses <ENTER>>
Start XMODEM-CRC Transfer Now!
CC
<user starts sending INI>
150 bytes have successfully been transmitted.
apc>
```

Error Message: E000, E100

xferStatus

Access: Super User, Administrator

Description: View the result of the last file transfer. See “Verifying Upgrades and Updates” on page 136 for descriptions of the transfer result codes.

Parameters: None

Example:

```
apc> xferStatus
E000: Success
Result of last file transfer: OK
```

Error Message: E000

Device Command Descriptions

The device command descriptions include the ATS command's units, resolution/scale, and ranges.

aboutATS

Access: Super User, Administrator, Device User, Read Only User

Description: Display ATS controller information.

Parameters: None

Example:

```
apc> aboutATS
E000: Success
Model:                AP4450
Firmware Rev:         6.9.4
Firmware Date:        08/03/19
Hardware Rev:         R01
Manufacture Date:     03/29/19
Serial Number:        5AXXXXXXXXXX
Downloader Rev:       4.0
```

Error Messages: E000, E102

atsStatus

Access: Super User, Administrator, Device User, Read Only User

Description: Read ATS status information.

Parameters: None

Example:

```
apc> atsStatus
E000: Success
Communication Status:      OK
Selected Source:           Source B
Preferred Source:          Source B
Switch Status:             OK
Front Panel:               Unlocked
Source A: OK
Source B:                   Selected
Phase Synchronization:    Sync
Source A 24V Power Supply: OK
Source B 24V Power Supply: OK
Source A 24V Boost Voltage: OK
Source B 24V Boost Voltage: OK
3.3V Power Supply:         OK
1.0V Power Supply:         OK
```

Error Messages: E000, E102

atsMeasure

Access: Super User, Administrator, Device User, Read Only User

Description: Read source power measurements and ATS power measurements.

Parameters: None

Example:

```
apc> atsMeasure
E000: Success
Source A Freq:           60 Hz
Source A Voltage:       121 V
Source B Freq:           60 Hz
Source B Voltage:       121 V
Total Output Power:     1.00 kVA
Source A 24V Power Supply: 24 V
Source B 24V Power Supply: 24 V
Source A Boost Voltage:  40 V
Source B Boost Voltage:  40 V
3.3 V Power Supply:     3.3 V
1.0 V Power Supply:     1.0 V
```

Error Messages: E000, E102

bkLowLoad

Access: Super User, Administrator, Device User

Description: Set or view the bank low-load threshold current in amps. Only single phase SKUs with two or more circuit breakers support this command.

Parameters:

Argument	Description
<all bank#>	<ul style="list-style-type: none">• all: all bank numbers• bank#: A single number, a range of numbers separated with a dash, or a comma-separated list of single bank number and/or number ranges.
<current>	The new bank threshold (Amps)
NOTE: The maximum bank number is 3. If the ATS has only two circuit breakers, a total load for the two circuit breakers is provided.	

Example:

```
apc> bkLowLoad all
E000: Success
1: 0 A
2: 0 A
total: 0 A

apc> bkLowLoad 1
E000: Success
1: 0 A

apc> bkLowLoad 1 1
E000: Success

apc> bkLowLoad 1-2 1
E000: Success
```

Error Messages: E000, E102:

bkNearOver

Access: Super User, Administrator, Device User

Description: Set or view the bank near-overload threshold current in amps. Only single phase SKUs with two or more circuit breakers support this command.

Parameters:

Argument	Description
<all bank#>	<ul style="list-style-type: none">• all: all bank numbers• bank#: A single number, a range of numbers separated with a dash, or a comma-separated list of single bank number and/or number ranges.
<current>	The new bank threshold (Amps)
NOTE: The maximum bank number is 3. If the ATS has only two circuit breakers, a total bank threshold is provided.	

Example:

```
apc> bkNearOver all 10
E000: Success
```

```
apc> bkNearOver all
E000: Success
1: 10 A
2: 10 A
total: 16 A
```

```
apc> bkNearOver 1
E000: Success
1: 10 A
```

```
apc> bkNearOver 1 12
E000: Success
```

```
apc> bkNearOver 1-2 10
E000: Success
```

Error Messages: E000, E102:

bkOverLoad

Access: Super User, Administrator, Device User

Description: Set or view the bank overload threshold current in amps. Only single phase SKUs with two or more circuit breakers support this command.

Parameters:

Argument	Description
<all bank#>	<ul style="list-style-type: none">• all: all bank numbers• bank#: A single number, a range of numbers separated with a dash, or a comma-separated list of single bank number and/or number ranges.
<current>	The new bank threshold (Amps)
NOTE: The maximum bank number is 3. If the ATS has only two circuit breakers, a total bank threshold is provided.	

Example:

```
apc> bkOverLoad all
E000: Success
1: 14 A
2: 14 A
total: 24 A

apc> bkOverLoad 1
E000: Success
1: 14 A

apc> bkOverLoad 1 16
E000: Success

apc> bkOverLoad 1-2 16
E000: Success
```

Error Messages: E000, E102

bkPeakLoad

Access: Super User, Administrator, Device User

Description: Display the peak load measurement from a bank(s). Only single phase SKUs with two or more circuit breakers support this command.

Parameters:

Argument	Description
<all bank#>	<ul style="list-style-type: none">• all: all bank numbers• bank#: A single number, a range of numbers separated with a dash, or a comma-separated list of single bank number and/or number ranges.
NOTE: The maximum bank number is 3. If the ATS has only two circuit breakers, a total bank threshold is provided.	

Example:

```
apc> bkPeakLoad all
E000: Success
1: 5.0 A
2: 5.0 A
total: 11.0 A|
```

```
apc> bkPeakLoad 1
E000: Success
1: 5.0 A
```

```
apc> bkPeakLoad 1-2
E000: Success
1: 5.0 A
2: 6.0 A
```

Error Messages: E000, E102

bkReading

Access: Super User, Administrator, Device User, Read Only

Description: View the current reading (measurement) in amps for a bank. Only single phase SKUs with two or more circuit breakers support this command.

Parameters:

Argument	Description
<all bank#>	<ul style="list-style-type: none">• all: all bank numbers• bank#: A single number, a range of numbers separated with a dash, or a comma-separated list of single bank number and/or number ranges.
NOTE: The maximum bank number is 3. If the ATS has only two circuit breakers, a total bank threshold is provided.	

Example:

```
apc> bkReading 1
E000: Success
1: 6.3 A

apc> bkReading all
E000: Success
1: 6.3 A
2: 5.1 A
total: 11.4 A

apc> bkReading 1-2
E000: Success
1: 6.3 A
2: 5.1 A
```

Error Messages: E000, E102

eventCounts

Access: Super User, Administrator, Device User

Description: Display or clear the event counts reported from the ATS controller.

Parameters: Enter a <0> argument to set all event counts to 0.

Example:

```
apc> eventCounts
E000: Success
Event Counts
-----
Redundancy Loss:           15
Source Switch:             80
Over Current:              0
Source Preference Change:  7
Spike/Dropout:            95
Surge/Droop:               0
Frequency out of Range:    9
```

Error Messages: E000, E100, E102

freqDeviat

Access: Super User, Administrator, Device User

Description: Read or set the range of acceptable frequency fluctuation (Hz).

Parameters:

Argument	Description
<3 5 10>	The new range of acceptable frequency deviation: 3, 5, or 10 Hz above or below the nominal frequency.
If the Frequency (see "atsMeasure" on page 59) is at 50 Hz and vSensitivity (page 71) is set to High , freqDeviat should be 3 or 5.	

Example:

```
apc> freqDeviat
E000: Success
Frequency Deviation: 3 Hz
```

Error Messages: E000, E100, E102

frontPanel

Access: Super User, Administrator, Device User

Description: Set or view control for the source button on the front panel.

Parameters:

Argument	Description
<locked unlocked>	Lock or unlock the front panel for use.

Example:

```
apc> frontPanel
E000: Success
Front Panel: unlocked

apc> frontPanel locked
E000: Success
```

Error Messages: E000, E100, E102

lcd

Access: Super User, Administrator, Device User

Description: Turn the LCD On/Off

Parameters: <on | off>

Example:

```
apc> lcd off
E000: Success
```

Error Message: E000, E100, E102

lcdBlink

Access: Super User, Administrator

Description: Specify a number of minutes to blink the display. This command can be canceled by pressing a button on the LCD. Valid range is [1-10].

Parameters: <time>

Example:

```
apc> lcdBlink 2
E000: Success
```

Error Messages: E000, E102

lineVRMS

Access: Super User, Administrator

Description: Read or set the nominal source line voltage (V). Acceptable values depend on the SKU# of your ATS.

Parameters: [<voltage>]

SKU	Acceptable values
AP4421, AP4422, AP4423, AP4424	230
AP4430, AP4430X914, AP4432	200 or 208
AP4431, AP4433, AP4434	208
AP4450	100 or 120
AP4452, AP4452X631, AP4453	120
AP4452J	100

Example:

```
apc> lineVRMS
E000: Success
Nominal Line Voltage: 120
```

```
apc> lineVRMS 124
E000: Success
```

Error Messages: E000, E100, E102

phLowLoad

NOTE: Only units without circuit breakers are supported by this command.

Access: Super User, Administrator, Device User

Description: Set or view the phase low-load threshold in amps.

Parameters: <current>

Example:

```
apc> phLowLoad
E000: Success
0 A
```

```
apc> phLowLoad 3
E000: Success
```

Error Message: E000, E102

phNearOver

NOTE: Only units without circuit breakers are supported by this command.

Access: Super User, Administrator, Device User

Description: Set or view the phase near-overload threshold in amps.

Parameters: <current>

Example:

```
apc> phNearOver
E000: Success
8 A

apc> phNearOver 9
E000: Success
```

Error Message: E000, E102

phOverLoad

NOTE: Only units without circuit breakers are supported by this command.

Access: Super User, Administrator, Device User

Description: Set or view the phase overload threshold in amps.

Parameters: <current>

Example: To set the overload threshold for all phases to 13 A, type:

```
apc> phOverLoad
E000: Success
10 A

apc> phOverLoad 9
E000: Success
```

Error Message: E000, E102

phPeakLoad

NOTE: Only units without circuit breakers are supported by this command.

Access: Super User, Administrator, Device User, Read Only User

Description: View the phase peak load.

Parameters: None

Example:

```
apc> phPeakLoad
E000: Success
4.0 A
```

Error Message: E000, E102

phReading

NOTE: Only units without circuit breakers are supported by this command.

Access: Super User, Administrator, Device User

Description: View the phase load in Amps.

Parameters: None

Example:

```
apc> phReading
E000: Success
4.0 A
```

Error Message: E000, E102

prodInfo

Access: Super User, Administrator, Device User, Read Only

Description: View information about the ATS.

Parameters: None

Example: To view the product information for this Rack ATS, type:

```
apc> prodInfo
E000: Success
AOS:                6.9.4
APP                 6.9.4
Model:              AP4450
Name:               apcRack_01
Location:           Data Center Row 3
Contact:            Don Adams
Outlets:            10
Rated Load:         12 A
Phases:             1
Uptime:             15 Days 1 Hours 8 Minutes
Network Link:       Link Active
```

Error Messages: None

sourceAName

Access: Super User, Administrator, Device User

Description: Set or view the name assigned to power source A.

Parameters: <sourceAName>

Example:

```
apc> sourceAName
E000: Success
Wall Box Phase L1
```

```
apc> sourceAName "Wall Box N2 Phase L2"
E000: Success
```

Error Messages: E000, E102

sourceBName

Access: Super User, Administrator, Device User

Description: Set or view the name of power source B.

Parameters: <sourceBName>

Example:

```
apc> sourceBName
E000: Success
Wall Box Phase L2
```

```
apc> sourceBName "Wall Box N2 Phase L3"
E000: Success
```

Error Messages: E000, E102

sourcePref

Access: Super User, Administrator, Device User

Description: Set or view the desired source preference.

Parameters: <A | B | None>

Example:

```
apc> sourcePref
E000: Success
Preferred Source: Source A
```

```
apc> sourcePref B
E000: Success
```

Error Messages: E000, E102

vMediumLmt

Access: Super User, Administrator, Device User

Description: Set or view the voltage range to use when the Voltage Transfer Range is set to Medium. This value must be greater than the Narrow Transfer Limit and less than the Wide Limit (V).

Parameters: [<limit>]

The value range depends on the SKU:

SKU	Acceptable values
AP4421, AP4422, AP4423, AP4424	16–25
AP4430, AP4430X914, AP4432, AP4433, AP4434	15–30
AP4452J	10–15
AP4450, AP4452, AP4452X631, AP4453	10–23

Example:

```
apc> vMediumLmt
E000: Success
Voltage Medium Limit: 12 V
```

```
apc> vMediumLmt 14
E000: Success
```

Error Messages: E000, E100, E102

vNarrowLmt

Access: Super User, Administrator, Device User

Description: Set or view the voltage range to use when the Voltage Transfer Range is set to Narrow. This value must be less than the Medium Limit.

Parameters: [<limit>]

The value range depends on the SKU:

SKU	Acceptable values
AP4421, AP4422, AP4423, AP4424	16–25
AP4430, AP4430X914, AP4432, AP4433, AP4434	15–30
AP4452J	10–15
AP4450, AP4452, AP4452X631, AP4453	10–23

Example:

```
apc> vNarrowLmt
E000: Success
Voltage Narrow Limit: 15 V
```

Error Messages: E000, E100, E102

vSensitvty

Access: Super User, Administrator, Device User

Description: Set or view the sensitivity.

Parameters:

Argument	Description
<High Low>	Set the sensitivity of the ATS. <ul style="list-style-type: none">• High: The ATS will switch power sources after 2ms when there is a disturbance in the power supply.• Low: The ATS will switch sources after 4ms when there is a disturbance in the power supply
NOTE: If the Frequency is at 50 Hz (see “atsMeasure” on page 59) and FreqDeviat is set to 10, vSensitvty should be set to Low .	

Example:

```
apc> vSensitvty
E000: Success
Voltage Sensitivity: Low
```

```
apc> vSensitvty High
E000: Success
```

Error Messages: E000, E100, E102

vWideLmt

Access: Super User, Administrator, Device User

Description: Set or view the voltage range to use when Voltage Transfer Range is set to Wide. This value must be greater than the Medium Limit.

Parameters: [<limit>]

The configurable limit depends on the SKU:

SKU	Acceptable values
AP4421, AP4422, AP4423, AP4424	16–25
AP4430, AP4430X914, AP4432, AP4433, AP4434	15–30
AP4452J	10–15
AP4450, AP4452, AP4452X631, AP4453	10–23

Example:

```
apc> vWideLmt
E000: Success
Voltage Wide Limit: 20
```

```
apc> vWideLmt 24
E000: Success
```

Error Messages: E000, E102

vXferRange

Access: Super User, Administrator, Device User

Description: Set or view the Voltage Transfer Range. If the voltage of an ATS exceeds the Transfer Range, it generates an alarm.

Parameters:

Argument	Description
<Wide Medium Narrow>	Set the Voltage transfer range. <ul style="list-style-type: none">• Wide: corresponds to configured values for vWideLmt.• Medium: corresponds to configured values for vMediumLmt.• Narrow: corresponds to configured values for vNarrowLmt.

Example:

```
apc> vXferRange
E000: Success
Voltage Transfer Range: Medium
apc> vXferRange Wide
E000: Success
```

Error Messages: E000, E102

Web User Interface

You can use the latest version of Microsoft Internet Explorer® (IE) or Edge®, Google Chrome®, Apple Safari®, or Mozilla Firefox® to access the Rack PDU through its Web UI. Other commonly available browsers and versions may work but have not been fully tested.

To access the Web UI on any operating system, use the latest releases of Mozilla Firefox®, or Google Chrome®. Other commonly available browsers also may work but have not been fully tested by APC by Schneider Electric.

The ATS cannot work with a proxy server. Before accessing the Web UI of the ATS, do one of the following:

- Configure the browser to disable the use of a proxy server for your ATS.
- Configure the proxy server so that it does not proxy the specific IP address of your ATS.

Log on to the Web UI

To access the Web UI and configure the security settings of your unit on the network:

1. Type the DNS name or IP address of the Rack ATS in the Web browser's URL address field and press ENTER.
2. Enter the user name and password. (By default, both values are **apc** for the Super User and Administrator. The **Super User**, or an **Administrator** created by the **Super User**, should define the user name, password, and account characteristics for other users).

NOTE: If you are using HTTPS (SSL/TLS) as your access protocol, your login credentials are compared with information in a server certificate. If the certificate was created with the Security Wizard, and an IP address was specified as the common name in the certificate, you must use an IP address to log on to the Rack ATS. If a DNS name was specified as the common name on the certificate, you must use a DNS name to log on.

You may receive a message that the Web page is not secure. This is normal, and you can continue to the Web UI. The warning is generated because your Web browser does not recognize the default certificate used for encryption over HTTPS. However, information transmitted over HTTPS is still encrypted. See the *Security Handbook* on www.apc.com for more details on HTTPS and instructions to resolve the warning.

URL address formats

Type the DNS name or IP address of the ATS in the Web browser's URL address field and press ENTER. Until HTTP is enabled, you must include `https://` in the URL. When you specify a non-default Web server port in Internet Explorer, you must include `http://` or `https://` in the URL.

Common browser error messages at log on

Error Message	Browser	Cause of the Error
"This page cannot be displayed."	Internet Explorer	Web access is disabled, or the URL was not correct.
"Unable to connect."	Firefox	

URL format examples

NOTE: HTTP is disabled by default, and HTTPS is enabled by default.

- For a DNS name of Web1:
 - `http://Web1` if HTTP is your access mode
 - `https://Web1` if HTTPS (HTTP with SSL/TLS) is your access mode
- For a System IP address of 139.225.6.133 and the default Web server port (80):
 - `http://139.225.6.133` if HTTP is your access mode
 - `https://139.225.6.133` if HTTPS (HTTP with SSL/TLS) is your access mode
- For a System IP address of 139.225.6.133 and a non-default Web server port (5000):
 - `http://139.225.6.133:5000` if HTTP is your access mode
 - `https://139.225.6.133:5000` if HTTPS (HTTP with SSL/TLS) is your access mode
- For a System IPv6 address of 2001:db8:1::2c0:b7ff:fe00:1100 and a non-default Web server port (5000):
 - `http://[2001:db8:1::2c0:b7ff:fe00:1100]:5000` if HTTP is your access mode
 - `https://[2001:db8:1::2c0:b7ff:fe00:1100]:5000` if HTTPS (HTTP with SSL/TLS) is your access mode

First log on

When you log on to the NMC for the first time, you will be prompted to change the default Super User account password (**apc**). After you log in, you will be directed to the **Configuration Summary** screen. This screen is an overview of all system protocols, and their current values (e.g. enabled/disabled). You can access this screen at any time afterwards by following the path: **Configuration > Network > Summary**.

Limited Status Access

The RPDU Limited Status (**Configuration > Network > Web > Access**) page provides limited information, without requiring you to log on. Using a Web browser, access the RPDU's IP address to view the log on page. When enabled, there is a "Limited Status" hyperlink toward the lower right corner of the frame. Clicking on "Limited Status," instead of the regular user name / password fields, a limited summary of Device and System Information is made available to viewing. A "Log On" hyper link, as seen immediately above, allows for easy access to the standard Log In page.

Web UI Features

Read the following to familiarize yourself with basic Web UI features for your Rack ATS.

Tabs

The following tabs are available:

- **Home:** Appears when you log on. View active alarms, the load status of the Rack ATS, and the most recent Rack ATS events. For more information, see “Home Tab” on page 77.
NOTE: Home is the default tab when you log on. To change the login page, go to the desired login page and then click the green pushpin  at the top right of the browser window.
- **Status:** Gives the user the status of the **ATS** and **Network**. The **ATS** tab covers the status of Alarms, Device, Unit, Load, and Measurement. The **Network** tab covers just the Network. For more information, see “Status Tab” on page 78.
- **Control:** The **Control** tab covers **Security** and **Network**. Much more information is covered under these tabs and will be described under “Control Tab” on page 83.
- **Configuration:** The **Configuration** tab covers **ATS**, **Security**, **Network**, **Notification**, **General** and **Logs**. Much more information is covered under each of these tabs and will be under “Configuration Tab” on page 85.
- **Tests:** The **Tests** tab covers **ATS** and **Network**. The **ATS** tab covers LCD Blink and the **Network** tab covers LED Blink. Both will be further described under “Tests Tab” on page 119.
- **Logs:** The **Logs** section covers **Event**, **Data** and **Firewall**. The **Event** and **Data** tabs cover more information which will be further discussed under “Logs Tab” on page 120.
- **About:** The **About** section covers **ATS**, **Network**, and **Support**, which will be further discussed under “About Tab” on page 125.

Limited Status Access

The Limited Status (**Configuration > Network > Web > Access**) page provides limited information, without requiring a login. Using a web browser, access the Rack ATS unit’s IP address to view the log in page. There is a “Limited Status” hyperlink, towards the lower left corner of the frame.

Clicking on **Limited Status** instead of the regular user name / password fields, a limited summary of Device and System Information is made available to viewing. A “Log On” hyper link allows for easy access to the standard Log In page.

Device status icons

The *Quick Status* area, displayed in the upper right corner of every screen, displays a warning of any alarms. Clicking on any of the *Quick Status* icons will take you to the home screen.



Critical: A critical alarm exists, which requires immediate action.



Warning: An alarm condition requires attention and could jeopardize your data or equipment if its cause is not addressed.



No Alarms: No alarms are present, and the Rack ATS and NMC are operating normally.

Quick Links

At the lower left on each page of the interface, there are three configurable links. By default, the links access the URLs for these Web pages:

- Link 1: The home page of APC by Schneider Electric website
- Link 2: Demonstrations of Schneider Electric Web-enabled products
- Link 3: Information on [EcoStruxure IT](#)

Located in the upper right hand corner of each page:

- **User name:** select to change user preferences
- **Log Off:** select to log the current user off of the Web UI
- **Help:** select to view context-sensitive information
- : click to set the current Web page to be the log in page

Example:

Log In Home: To make any screen the “logon” screen (i.e., the screen that displays first when you log on), go to that screen, and click  in the top right corner.

Click  to revert to displaying the Home screen when you log on.

Home Tab

Active Alarms: view alarms, which will also be displayed at the top right of every page. If no alarms exist, a green check mark with the words “No Alarms Present” will show.

Switch/Source Status: shows the selected source and whether switchover is possible.

Load Status: View the load for the device in kVA and the load for the phases and banks in A, as applicable. The meter shows the current load status: normal (green), near overload (yellow), or overload (red). To see the **Device Status**, click the **More** button.

NOTE: If a low load threshold is configured, the meter will also include a blue segment on the left.

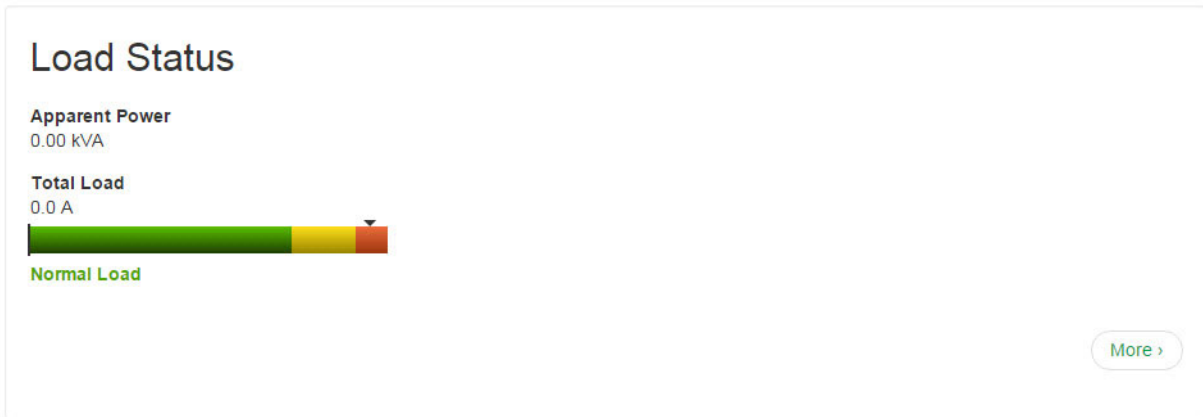

Parameters

- **Name:** The configured name for the Rack ATS
- **Location:** The physical location of the Rack ATS
- **Contact:** The person responsible for the Rack ATS
- **Model Number:** Also called SKU number. Acceptable voltage configurations are specific to model numbers. For details, see the Specification Sheet for your ATS model on www.apc.com.
- **Rating:** Provides the number of metered phases and banks on the unit, in addition to the phase rating of the ATS.
- **User Type:** Type of user account accessing the Rack ATS. Your user type defines what permissions you have. See “Types of User Accounts” on page 5 for details.
- **Uptime:** Amount of time the Rack ATS has been operating since the last reboot from either a power cycle or a reboot of the Management Interface

Recent Device Events: View the most recent Events, including the dates and times they occurred. A maximum of five Events are shown at one time. Click **More Events** to go to the **Logs** tab and view the entire event log.

Status Tab

View ATS Status

View device alarms

Path: **Status > ATS > Alarms**

View current device alarms, including alarm status icons (see “Device status icons” on page 75) and descriptions.

View device status

Path: **Status > ATS > Device**

The screenshot displays the Schneider Electric Automatic Transfer Switch Application interface. At the top, the Schneider Electric logo is on the left, and the EcoStruxure IT logo is on the right. The page title is "Automatic Transfer Switch Application". A navigation bar contains links for Home, Status, Control, Configuration, Tests, Logs, and About. The main content area is titled "Status" and contains a "Device Status" section. This section includes a "Load" indicator showing 0.5 A with a color-coded bar (green, yellow, red) and a "Normal Load" label. It also shows "Output Apparent Power" as 0.06 kVA. Below this are "Properties" and "Configuration" sections. The Properties section lists Model Number (AP4452), Serial Number (5A1713T59925), and Outlets (10). The Configuration section lists Name (apcD8F074), Location (Unknown), and Contact (Unknown). A link "Configure device settings" is provided. At the bottom, there is a footer with "APC's Web Site | Testdrive Demo | EcoStruxure™ IT" and "© 2020, Schneider Electric. All rights reserved. Site Map | Updated: 09/17/2020 at 11:40 (apcd8f074.us.ddns.schneider-electric.com)".

View the **Device Status**, **Properties**, and **Configuration** information. Select **Configure device settings** to edit the **Name**, **Location**, or **Contact** information.

View the unit status

Path: Status > ATS > Unit

The screenshot displays the Schneider Electric Automatic Transfer Switch Application web interface. The page title is "Status". The main content area is titled "Unit Status" and shows a green checkmark indicating "Source A selected, Switchover Possible".

Source Status

Selected Source	Preferred Source	Source A
Source A	Source A	Selected

Source B
OK

Power Supplies

Source A 24V	Source B 24V	Source A Boost Voltage
OK	OK	OK
Source B Boost Voltage	3.3V	1.0V
OK	OK	OK

Others

Phase Synchronization	Front Panel
Sync	Unlocked

Event Counts

Redundancy Loss	Source Switch	Over Current
0	0	0
Source Preference Change	Spike/Dropout	Surge/Droop
0	0	0
Freq Out of Range		
0		

Reset Event Count (last reset at 09/17/2020 09:29:18)

Apply Cancel

APC's Web Site | Testdrive Demo | EcoStruxure™ IT

© 2020, Schneider Electric. All rights reserved.
Site Map | Updated: 09/17/2020 at 11:47 (apcd8074.us.ddns.schneider-electric.com)

View the status of the primary and secondary power source, available power supplies, phase synchronization, and other available features.

View the following Event counts: **Redundancy Loss**, **Source Switch**, **Over Current**, **Source Preference Change**, **Spike/Dropout**, **Surge/Droop**, and **Frequency Out of Range**. To reset these counts to 0, select **Reset Event Count** and click **Apply**. Event counts are set to zero automatically if power is removed from the device or if the ATS controller is updated.

View load status

Path: Status > ATS > Load

A marker on a colored green, yellow, and red sliding bar represents the ATS load.

- Green: Normal load range
- Yellow: Near overload range
- Red: Overload range

View power measurements

Path: Status > ATS > Measurement

The screenshot displays the Schneider Electric Automatic Transfer Switch Application web interface. The page title is "Status". The main content area is titled "ATS Measurement" and displays the following data:

Input Frequency	
Source A 60 Hz	Source B 60 Hz

Input Voltage (AC)	
Source A 117 V	Source B 117 V

Power Supplies (DC)	
Source A 24V Power Supply 24 V	Source B 24V Power Supply 24 V
Source A Boost Voltage 47 V	Source B Boost Voltage 47 V
3.3V Power Supply 3.3 V	1.0V Power Supply 1.0 V

At the bottom of the page, there is a footer with the following text: "APC's Web Site | Testdrive Demo | EcoStruxure™ IT" on the left, and "© 2020, Schneider Electric. All rights reserved. Site Map | Updated: 09/17/2020 at 13:16 (apcd8f074.us.ddns.schneider-electric.com)" on the right.

View measurements for **Input Frequency**, **Input Voltage (AC)**, and source **Power Supplies (DC)**.

View Network Status

Path: Status > Network > Network

The screenshot shows the Schneider Electric Automatic Transfer Switch Application web interface. The page title is "Automatic Transfer Switch Application". The top navigation bar includes "Home", "Status", "Control", "Configuration", "Tests", "Logs", and "About". The "Status" section is active. The "Current IPv4 Settings" section displays the following information:

System IP	Subnet Mask	Default Gateway	MAC Address
10.218.117.199	255.255.255.0	10.218.117.1	00 C0 B7 D8 F0 74
Mode	DHCP Server:	Lease Acquired	Lease Expires
DHCP	10.218.99.23	09/17/2020 09:38	09/20/2020 09:37

The "Current IPv6 Settings" section displays the following information:

Type	IP Address	Prefix Length
Auto	FE80::2C0:B7FF:FED8:F074	64

The "Domain Name System Status" section displays the following information:

Active Primary DNS Server	Active Secondary DNS Server	Active Host Name
10.169.10.10	10.218.99.55	apcD8F074
Active Domain Name (IPv4/IPv6)	Active Domain Name (IPv6)	
nam.gad.schneider-electric.com	example.com	

The "Port Speed" section displays the following information:

Current Speed
100 Full-Duplex

At the bottom of the page, there is a footer with the following text: "APC's Web Site | Testdrive Demo | EcoStruxure™ IT" and "© 2020, Schneider Electric. All rights reserved. Site Map | Updated: 09/17/2020 at 10:12 (apod8f074.us.ddns.schneider-electric.com)".

Current IPv4 settings

System IP: The IP address of the unit.

Subnet Mask: The IP address of the sub-network.

Default Gateway: The IP address of the router used to connect to the network.

MAC Address: The MAC address of the unit.

Mode: How the IPv4 settings are assigned: **Manual**, **DHCP**, or **BOOTP**.

DHCP Server: The IP address of the DHCP server. This is only displayed if Mode is DHCP.

Lease Acquired: The date/time that the IP address was accepted from the DHCP server.

Lease Expires: The date/time the IP address from the DHCP server expires and will need to be renewed.

Current IPv6 settings

Type: How the IPv6 settings are assigned: automatic or manual.

IP Address: The IP address of the unit.

Prefix Length: The range of addresses for the sub-network.

Domain name system status

Active Primary DNS Server: The IP address of the primary DNS server.

Active Secondary DNS Server: The IP address of the secondary DNS server.

Active Host Name: The host name of the active DNS server.

Active Domain Name (IPv4/IPv6): The IPv4/IPv6 domain name that is currently in use.

Active Domain Name (IPv6): The IPv6 domain name that is currently in use.

Port Speed

Current Speed: The current speed assigned to the Ethernet port in Mbps.

Control Tab

The **Control** menu options enable you to take immediate actions affecting active user management and the security of your network.

Manage User Sessions

Path: Control > Security > Session Management

The screenshot shows the Schneider Electric Automatic Transfer Switch Application interface. The top navigation bar is green and contains the following items: Home, Status, Control, Configuration, Tests, Logs, and About. The main content area is titled "Current Sessions" and contains a "Session Management" table. The table has four columns: User, Interface, Address, and Logged In Time. The table contains one row with the following data: User: apc, Interface: Web, Address: 10.252.104.43, Logged In Time: 00:02:20. The footer of the page contains the following text: APC's Web Site | Testdrive Demo | EcoStruxure™ IT | © 2020, Schneider Electric. All rights reserved. | Site Map | Updated: 09/17/2020 at 10:13 (apc08f074.us.ddns.schneider-electric.com)

User	Interface	Address	Logged In Time
apc	Web	10.252.104.43	00:02:20

The **Session Management** menu displays all active users currently connected to the ATS. To view information about a user, select their user name. The **Session Details** screen displays basic information about the user including the interface they are logged in to, their IP address, and log in time. At the bottom of the **Session Details** page, there is a **Terminate Session** button. The Administrator can terminate the session of a user.

Reset the Network Interface

Path: Control > Network > Reset/Reboot



Automatic Transfer Switch Application



No Alarms

apc | English | Log Off | Help



Reset/Reboot

Reset/Reboot Network Interface

Reboot Management Interface

Reset All

Exclude TCP/IP

Reset Only

TCP/IP

Event Configuration

Apply Cancel

[APC's Web Site](#) | [Testdrive Demo](#) | [EcoStruxure™ IT](#)

© 2020, Schneider Electric. All rights reserved.
[Site Map](#) | Updated: 09/17/2020 at 11:11 (apcd8f074.us.ddns.schneider-electric.com)

This menu gives you the option to reset and reboot various components of the network interface.

NOTE: Rebooting only restarts the Rack ATS's Network Management Interface; it does not affect the ON/Off status of the ATS.

Reset All: Clear the **Exclude TCP/IP** check box to reset all configured values, including settings that determine how this device obtains TCP/IP and the EAPoL configuration values. The default for TCP/IP configuration setting is DHCP and that for EAPoL access is disabled. Select the **Exclude TCP/IP** check box to reset all configuration values except for settings that determine how this device obtains TCP/IP and the EAPoL configuration values.

Reset Only: Resetting may take up to a minute. Options include

- **TCP/IP settings:** Resets only the setting that determines how this device must obtain its TCP/IP configuration values including the EAPoL configuration. The default for TCP/IP configuration setting is DHCP and that for EAPoL access is disabled.
- **Event Configuration:** Resets events to their default configuration. Any specially configured event or group will also revert to the default value.

Configuration Tab

Configure the ATS

Configure ATS name and location

Path: Configuration > ATS > Device

Status: View the ATS load in A and the Output Power in kVA.

Name: Enter a descriptive name for the ATS. This will appear on the **Home** tab.

Location: Enter the physical location of the ATS. This will appear on the **Home** tab.

Contact: Enter the person responsible for the ATS. This will appear on the **Home** tab.

Click **Apply** to save your changes or **Cancel** to erase your changes.

Set preferred power source

Path: Configuration > ATS > Source

Status: View the status of the preferred power source.

Source A Name, Source B Name: Enter names of your choice for Source A and Source B.

Preferred Source: Select the power source the ATS will draw from when both sources are available.

Front Panel: Lock or unlock the Front Panel.

Click **Apply** to save your changes or **Cancel** to erase your changes.

Configure switching behavior

Path: Configuration > ATS > Frequency/Voltage

⚠ ⚠ DANGER

HAZARDOUS VOLTAGE
Do not operate the Rack ATS outside Rated Voltage (+/- 10%). Voltage limits and transfer ranges represent software control of switching behavior, not input voltages for use.
Failure to follow these instructions will result in death or serious injury.



Automatic Transfer Switch Application



No Alarms

apc | English | Log Off | Help |

Home Status - Control - Configuration - Tests - Logs - About -

Frequency/Voltage Configuration

Configuration

Line Frequency
60 Hz

Frequency Deviation
 3 Hz
 5 Hz
 10 Hz

Line VRMS [108 to 132]
 Vrms

VRMS Wide Limit [10 to 23]
 V

VRMS Medium Limit [10 to 23]
 V

VRMS Narrow Limit [10 to 23]
 V

Sensitivity
 High
 Low

Voltage Transfer Range
 Wide
 Medium
 Narrow

[APC's Web Site](#) | [Testdrive Demo](#) | [EcoStruxure™ IT](#)

© 2020, Schneider Electric. All rights reserved.
[Site Map](#) | Updated: 09/17/2020 at 11:13 (apod8f074.us.ddns.schneider-electric.com)

Frequency Deviation: Frequency deviation beyond the set value will cause the Rack ATS to switch power sources.

NOTE: If the frequency is at 50 Hz (see “View power measurements” on page 80) and the **Sensitivity** is set to **High**, this value should be 3 or 5.

Line VRMS: Rated voltage for the Rack ATS (also called **Nominal Input**). VRMS limits and transfer ranges are based on this value.

Sensitivity: Control how much power fluctuation the Rack ATS tolerates before switching to the secondary power source. With a **Low** sensitivity, the Rack ATS waits 4 milliseconds (ms) before switching to the alternate power source. (This can help prevent excessive switching if your source voltage has excessive or frequent fluctuation.) With a **High** sensitivity, the Rack ATS waits 2 ms before switching to the alternate power source.

NOTE: If the frequency is at 50 Hz and the **Frequency Deviation** is set to 10, **Sensitivity** should be set to **Low**.

Limits and Transfer Range: The **Transfer Range** is the **Line VRMS** plus or minus a configured **Limit** (**Wide, Medium, or Narrow**). The **Transfer Range** determines the switching behavior for the Rack ATS based on source voltage: when the source voltage moves outside the **Transfer Range**, the Rack ATS switches to the secondary power source.

- **VRMS Wide, Medium, and Narrow Limit:** set configuration options for the **Transfer Range**.
- **Transfer Range:** Decide whether the Rack ATS will switch power sources based on the **Wide, Medium, or Narrow VRMS Limit**. The **Transfer Range** can only be set to one **Limit** at a time.

Example: A Rack ATS is set to the following configuration:

Line VRMS = 208,
VRMS Wide Limit = 10,
Transfer Range = Wide.

The ATS will switch sources when the voltage goes below 198 VRMS or above 218 VRMS (208 ±10 VRMS).

NOTE: The **Voltage Transfer Range** and **Limit** must remain within the absolute maximum ratings of the Rack ATS: 85–265 VRMS. At any voltage below 85 VRMS or above 265 VRMS, the Rack ATS will switch power sources regardless of configuration.

Click **Apply** to save your changes or **Cancel** to erase your changes.

Configure warning thresholds

Path: Configuration > ATS > Load

The screenshot shows the Schneider Electric Automatic Transfer Switch Application web interface. At the top, there is a navigation bar with 'Home', 'Status', 'Control', 'Configuration', 'Tests', 'Logs', and 'About'. The main content area is titled 'Load Configuration' and is divided into two sections: 'Status' and 'Configuration'.
The 'Status' section displays 'Current' at 0.5 A and 'Peak Current' at 0.7 A. A horizontal bar chart below these values shows the load status, with a green segment for 'Normal Load'.
The 'Configuration' section contains three input fields for warning thresholds: 'Low Load Warning' (0 to 16 A), 'Near Overload Warning' (12 to 16 A), and 'Overload Alarm' (16 to 16 A). Below these fields is a 'Peak Current' section with a 'Reset' checkbox and a timestamp '(last reset at 09/17/2020 09:30:34)'. At the bottom of the configuration section are 'Apply' and 'Cancel' buttons.

Status: View the current in A, and the Peak Current in kVA, for the device, phases, and banks. The indicator in the green, yellow, and red meter shows the load status: normal, near overload, or overload.

Warning Thresholds: The Rack ATS generates an alarm when any bank exceeds its rated value. Set the number of amps to trigger a **Low Load Warning**, **Near Overload Warning**, and **Overload Alarm**.

NOTE: If a circuit breaker trips, there is no definitive indication that the circuit breaker is open. However, the current for that bank will drop. Set the Low Load Warning to 1 amp for these reasons :

- The default setting for the Low Load Warning is 0 amps. This effectively disables the warning; with this setting, the Web UI will not indicate that a circuit breaker may have tripped.
- A 1-amp detection threshold for the Low Load Warning will help to indicate that a circuit breaker may have tripped.

Peak Current: Reset the peak current.

Click **Apply** to save your changes or **Cancel** to erase your changes.

Manage Security Settings

Manage user sessions

Path: Configuration > Security > Session Management

The screenshot shows the Schneider Electric Automatic Transfer Switch Application web interface. The top navigation bar includes the Schneider Electric logo, the application name, the EcoStruxure IT logo, and a 'No Alarms' status indicator. Below the navigation bar is a green menu with options: Home, Status, Control, Configuration, Tests, Logs, and About. The main content area is titled 'Session Configuration' and contains a 'Session Details' form. The form has two sections: 'Allow Concurrent Logins' with an 'Enable' checkbox checked, and 'Remote Authentication Override' with an 'Enable' checkbox unchecked. At the bottom of the form are 'Apply' and 'Cancel' buttons. The footer of the page contains copyright information and a site map link.

Allow Concurrent Logins: Select the **Enable** check box to allow two or more users to log on at the same time. Each user has equal access and each interface (HTTP, FTP, telnet, serial connection, etc.) counts as a logged-in user.

Remote Authentication Override: The Rack ATS supports RADIUS storage of passwords on a server. However, if you enable this override, the Rack ATS will allow a local user to log on using the password stored locally on the Rack ATS. See also “Manage local user settings” on this page and “Manage remote user settings” on page 93”.

Enable ping response

Path: Configuration > Security > Ping Response

IPv4 Ping Response: Select the **Enable** check box to allow the Rack ATS to respond to network pings. Clear the check box to disable a Rack ATS response. If the ping response is enabled and the ATS does not respond, see “Unable to ping the ATS” on page 137.

This does not apply to IPv6.

Manage local user settings

Path: Configuration > Security > Local Users > Management

User Management Configuration

Super User Management

User Name	User Type	User Description
apc	Super User	User Description

General User Management

User Name	User Type	User Description
device	Device	User Description
readonly	Read-Only	User Description

Click **Add User** to add a new user, or select a **User Name** to edit that user's configuration:

- **Access:** Select the **Enable** check box to allow access to the ATS.
- **User Name:** Enter a new user name.
- **Current Password, New Password, Confirm Password:** Enter a new password in both the New Password and Confirm Password fields. You must enter a password for new users. Blank passwords, (passwords with no characters) are not allowed.
NOTE: The maximum length for both the name and password is 64 bytes, with less than 64 characters for multi-byte characters. Values greater than 64 bytes for **Name** and **Password** may be truncated. To change an Administrator/Super User setting, you must enter all three fields.
- **User Type:** Select the user type from the drop-down list.
 - **Administrator:** Read-write access to all menus.
 - **Device:** Read-write access to device-related menus. Can be enabled or disabled by Administrators.
 - **Read-Only:** Read-only access. Can be enabled or disabled by Administrators.
 - **Network-Only:** Read-write access to network-related menus. Can be enabled or disabled by Administrators.
- **User Description:** Enter any additional identification details here.
- **Session Timeout:** Enter the number of minutes (3 by default) the ATS waits before logging off an inactive user. If you change this value, you must log off for the change to take effect.
NOTE: If a user closes the Web UI without logging off, they are still considered logged on for the time specified in the **Session Timeout** field. This can help prevent other users from taking the place of a user who leaves the Web UI.
- **Serial Remote Authentication Override:** Use Serial Remote Authentication Override to bypass RADIUS by using the serial console (CLI) connection. This screen enables Serial Remote Authentication Override for the selected user, but, in order to work, it must also be enabled globally through the Session Management screen (see “Manage User Sessions” on page 83).
- **User Preferences:**
 - **Event Log Color Coding:** Mark the check box to enable color-coding of alarm text recorded in the event log. System event entries and configuration change entries do not change color.

Text Color	Alarm Severity
Red	Critical: A critical alarm exists, which requires immediate action.
Orange	Warning: An alarm condition requires attention and could jeopardize your data or equipment if its cause is not addressed.
Green	Alarm Cleared: The conditions that caused the alarm have improved.
Black	Normal: No alarms are present. The Rack ATS and all connected devices are operating normally.

- **Export Log Format:** Configure which format the event log should be displayed in when exported (downloaded). Tab (default) allows fields to be tab-delimited whereas CSV is comma-separated.
- **Temperature scale:** Select the default temperature scale, US Customary (Fahrenheit) or Metric (Celsius).
- **Date Format:** Select the numerical format in which to display all dates in this user interface. In the selections, each letter (m for month, d for day, and y for year) represents one digit. Single-digit days and months are displayed with a leading zero.
- **Language:** Select the user interface display languages from the drop-down box.

Click **Next**, and then click **Apply** to save or **Cancel** to return to the User Management Configuration page.

Configure default user settings

Path: Configuration > Security > Local Users > Default Settings

Determine the default values to populate in each of the fields when the Super User or Administrator-level account creates a new user. These values can be changed before the settings are applied to the system.

For remote users (user accounts not stored in the system that are remotely authenticated such as RADIUS) these are the values used for those that are not provided by the authenticating server. For example, if a RADIUS server does not provide the user with a temperature preference, the value defined in this section will be used.

- **Access:** Select the **Enable** check box to allow access to the ATS.
- **User Type:** Select the user type from the drop-down list.
 - **Administrator:** Read-write access to all menus.
 - **Device:** Read-write access to device-related menus. Can be enabled or disabled by Administrators.
 - **Read-Only:** Read-only access. Can be enabled or disabled by Administrators.
 - **Network-Only:** Read-write access to network-related menus. Can be enabled or disabled by Administrators.
- **User Description:** Enter any additional identification details here.
- **Session Timeout:** Enter the number of minutes (3 by default) the ATS waits before logging off an inactive user. If you change this value, you must log off for the change to take effect.
NOTE: If a user closes the Web UI without logging off, they are still considered logged on for the time specified in the **Session Timeout** field. This can help prevent other users from taking the place of a user that leaves the Web UI.
- **Bad Login Attempts:** Set the number of failed login attempts the user can have. Select from 0 to 99 attempts. 0= unlimited.

- **User Preferences:**

- **Event Log Color Coding:** Mark the checkbox to enable color-coding of alarm text recorded in the event log. System event entries and configuration change entries do not change color.

Text Color	Alarm Severity
Red	Critical: A critical alarm exists, which requires immediate action.
Orange	Warning: An alarm condition requires attention and could jeopardize your data or equipment if its cause is not addressed.
Green	Alarm Cleared: The conditions that caused the alarm have improved.
Black	Normal: No alarms are present. The Rack ATS and all connected devices are operating normally.

- **Export Log Format:** Configure which format the event log should be displayed in when exported (downloaded). Tab (default) allows fields to be tab-delimited whereas CSV is comma-separated.
 - **Temperature scale:** Select the default temperature scale, US Customary (Fahrenheit) or Metric (Celsius).
 - **Date Format:** Select the numerical format in which to display all dates in this user interface. In the selections, each letter (m for month, d for day, and y for year) represents one digit. Single-digit days and months are displayed with a leading zero.
- **Password Requirements:**
 - **Strong Passwords:** Configure whether new passwords created for user accounts will require at least one lowercase character, one uppercase character, one number, and one symbol.
 - **Password Policy:** Enter the number of days after which users will be required to change their passwords. A value of 0 days (the default) disables this feature.

Manage remote user settings

Path: Configuration > Security > Remote Users > Authentication

APC by Schneider Electric supports the authentication and authorization functions of RADIUS (Remote Access Dial-In User Service).

- When a user accesses a Rack ATS that has RADIUS enabled, an authentication request is sent to the RADIUS server to determine the user's permission level.
- RADIUS user names used with the Rack ATS are case-sensitive, and have a 64 byte maximum, supporting up to 64 ASCII characters; less for multi-byte languages. Passwords with no characters (blank passwords) are not allowed.

Specify how you want remote users to be authenticated at logon. Select one of the following:

- **Local Authentication Only:** RADIUS is disabled. Local authentication is enabled.
- **RADIUS, then Local Authentication:** RADIUS and local authentication are enabled. Authentication is requested from the RADIUS server first. If the RADIUS server fails to respond, local authentication is used.
- **RADIUS Only:** RADIUS is enabled. Local authentication is disabled.
NOTE: If **RADIUS Only** is selected, and the RADIUS server is unavailable or improperly configured, remote access is unavailable to all users. You must use a serial connection to the CLI and change the **access** setting to **local** or **radiusLocal** to regain access. For example, the command to change the access setting to **local** would be `radius -a local`.

For information about local authentication (not using the centralized authentication of a RADIUS server), see the *Security Handbook* on www.apc.com.

Configure a RADIUS server

Path: Configuration > Security > Remote Users > RADIUS

Use this option to do the following:

- List the RADIUS servers (a maximum of two) available to the Rack ATS and the Reply Timeout period for each.
- Select a server, and configure the parameters for authentication by a new RADIUS server.
- Select a listed RADIUS server to display and modify its parameters.

Setting	Definition
RADIUS Server	The server name or IP address (IPv4 or IPv6) of the RADIUS server. Select a link to configure the server. NOTE: RADIUS servers use port 1812 by default to authenticate users. The Rack ATS supports ports 1812, and 5000 to 32768.
Secret	The shared secret between the RADIUS server and the Rack ATS.
Reply Timeout	The time in seconds that the Rack ATS waits for a response from the RADIUS server.
Test Settings	Enter the Super User or Administrator user name and password to test the RADIUS server path that you have configured.
Skip Test and Apply	Do not test the RADIUS server path. (Not recommended)

Summary of the configuration procedure: You must configure your RADIUS server to work with the Rack ATS. For examples of the RADIUS users file with Vendor Specific Attributes (VSAs) and an example of an entry in the dictionary file on the RADIUS server, see the *Security Handbook* on www.apc.com.

1. Add the IP address of the Rack ATS to the RADIUS server client list (file).
2. Users must be configured with Service-Type attributes unless Vendor Specific Attributes (VSAs) are defined. If no Service-Type attributes are configured, users will have read-only access (on the Web UI only). See your RADIUS server documentation for information about the RADIUS users file, and see the *Security Handbook* (www.apc.com) for an example.
3. VSAs can be used instead of the Service-Type attributes provided by the RADIUS server. VSAs require a dictionary entry and a RADIUS users file. In the dictionary file, define names for ATTRIBUTE and VALUE keywords, but not for numeric values. If you change numeric values, RADIUS authentication and authorization will fail. VSAs take precedence over standard RADIUS attributes.

Configuring a RADIUS server on UNIX® with shadow passwords: If UNIX shadow password files are used (/etc/passwd) with the RADIUS dictionary files, the following two methods can be used to authenticate users:

- If all UNIX users have administrative privileges, add the following to the RADIUS “user” file. To allow only Device Users, change the APC-Service-Type to *Device*.

```
DEFAULTAuth-Type = System
APC-Service-Type = Admin
```

- Add user names and attributes to the RADIUS “user” file, and verify the password against /etc/passwd. The following example is for users *bconners* and *thawk*:

```
bconnersAuth-Type = System
APC-Service-Type = Admin
thawkAuth-Type = System
APC-Service-Type = Device
```

Supported RADIUS servers: FreeRADIUS v1.x and v2.x, and Microsoft Server 2008 and 2012 Network Policy Server (NPS) are supported. Other commonly available RADIUS applications may work but may not have been fully tested

Firewall menus

Path: Configuration > Security > Firewall > Configuration

Enable or disable the firewall functionality. The configured policy is listed by default. Select the **Enable** check box to enable the firewall. The check box is un-checked by default.

- Click **Apply** to confirm a firewall policy you have selected to enable. The **Firewall Confirmation** page will open.
 - The **Confirmation** page contains a recommendation to test the firewall before enabling. It is not mandatory.
 - The first hyperlink goes to the **Firewall Policy** page.
 - The second hyperlink goes to the **Firewall Test** page.
 - Click **Apply** to enable the firewall and return to the **Configuration** page.
 - Click **Cancel** to return to the **Configuration** page without enabling the firewall.
- Click **Cancel**: No new selection will be enabled. You stay on the **Configuration** page.

Path: Configuration > Security > Firewall > Active Policy

Select an active policy from the **Available Policies** drop-down list, and view the validity of that policy. The current active policy is displayed by default; you can select another from the list.

- Click **Apply** to enable your changes. If a different firewall was selected and enabled, the change is effective immediately. If a newly configured firewall policy has been selected, it is recommended that you test the new firewall before enabling it. (See Configuration above.)
- Click **Cancel** to restore the original active policy and stay on the **Active Policy** page.

Path: Configuration > Security > Firewall > Active Rules

When a firewall is enabled, this read-only page lists the individual rules that are being enforced by a current active policy. See the **Create/Edit Policy** section (page 95) for descriptions of the fields (**Priority**, **Destination**, **Source**, **Protocol**, **Action**, and **Log**).

Path: Configuration > Security > Firewall > Create/Edit Policy

Create a new policy; delete or edit an existing policy

NOTE: While deleting an active enabled firewall policy cannot be done, editing a running policy can be done but is not recommended as changes are applied immediately. Instead, disable the firewall, edit the policy, test it, and then re-enable the policy.

Create a new policy: Click **Add Policy**, and type in the file name for the new firewall file. The filename should have a .fwl file extension. If left without a file extension, .fwl will be appended to the name automatically.

- Click **Apply**: If the filename is legal, the empty file firewall policy file will be created. It will be located in the **/fwl** folder with the other policies on the system.
- Click **Cancel** to return to the previous page without creating a new firewall file.

Edit an existing policy: Select **Edit Policy** to go to the edit page. You can edit an firewall policy which is not active.

Warning page: If you attempt to edit the active enabled policy, a warning page will open. **“Editing the active firewall policy will cause all changes made to be applied immediately. It is recommended to disable the firewall and test the policy before enabling it.”**

- Click **Apply** to leave the Warning page and return to the **Edit Policy** page.
- Click **Cancel** to leave the Warning page and return to the **Create/Edit Policy** page.

1. Select the policy you want to edit from the **Policy Name** drop-down list, and click **Edit Policy**.
2. Click **Add Rule** or select the **Priority** of an existing rule to go to the **Edit Rule** page. From this page, you can change the rule settings or delete the selected rule.

Setting	Description
Priority	If 2 rules conflict, the rule with the higher priority will determine what happens. The highest priority is 1; the lowest is 250.
Type	host: In the IP/any field, you will enter a single IP address. subnet: In the IP/any field, you will enter a subnet address. range: In the IP/any field, you will enter a range of IP addresses.
IP/any	Specify the IP address or range of addresses this rule applies to, or select one of the following: any: The rule applies regardless of the IP address. anyipv4: The rule applies for any IPv4 address. anyipv6: The rule applies for any IPv6 address.
Port	Specify a port the rule will apply to. • None: The rule will apply to any port. • Common Configured ports: Select a standard port. • Other: Specify a non-standard port number.
Protocol	Specify which protocol the rule applies to. • any: any protocol. • tcp: used for more reliable information transfer between applications. • udp: alternative to TCP using for faster, lower bandwidth information transfer. Though it has fewer delays, UDP is less reliable than TCP. • icmp: used to report errors for troubleshooting. • icmpv6: used to report errors for troubleshooting on applications using IPv6.
Action	allow: Allow the packet that matches this rule. discard: Discard the packet that matches this rule.
Log	If this rule applied to a packet, regardless of whether the packet is blocked or allowed, this will add an entry to the Firewall Log (see “Firewall log” on page 123).

It is recommended that you add one of the following as the lowest priority rule in your firewall policy:

- To use the firewall as a white list, add
250 Dest any / Source any / protocol any / discard
- To use the firewall as a black list, add
250 Dest any / Source any / protocol any / allow

Delete a policy:

Select **Delete Policy** to open the Confirm Deletion page.

Click **Apply** to confirm and the selected firewall file is removed from the file system.

Path: Configuration > Security > Firewall > Load Policy

Upload a policy (with the .fwl suffix) from a source external to this device.

Path: Configuration > Security > Firewall > Test

Temporarily enforce the rules of a chosen policy for a time that you specify.

802.1X Security Configuration

Path: Configuration > Security > 802.1X Security

The NMC takes the role of a supplicant in an EAPoL (Extensible Authentication Protocol over LAN) architecture used in IEEE 802.1X port-based network access control. The NMC supports EAP-TLS as an authentication method which requires the user to upload 3 client-side certificates. The private key is stored in an encrypted format. The user needs to provide a valid passphrase to be able to enable 802.1X security access.

NOTE: The NMC supports only EAP-TLS authentication method.

The Web UI offers the following options for EAPoL configuration:

Setting	Description
EAPoL Access	Used to enable or disable 802.1X Security Access. NOTE: The 802.1X security access is disabled by default. The user can enable only when valid certificates and a valid passphrase for the private key are provided by the user.
Supplicant Identifier	Allows the users to set their own supplicant identifier (up to 32 characters including whitespace). NOTE: By default, the supplicant identifier is set to “NMC-Supplicant-xx:xx:xx:xx:xx:xx” where six octets of ‘xx’ are the MAC ID of the NMC.
CA Certificate	Upload/replace or remove a CA root certificate. The supported file formats are PEM (Privacy Enhanced Mail) or the DER (Distinguished Encoding Rules) format with permitted file extensions .pem, .PEM, .der, or .DER.
Private Key Certificate	Upload/replace or remove an encrypted private key. The supported file formats are PEM (Privacy Enhanced Mail) or the DER (Distinguished Encoding Rules) format with permitted file extensions .key or .KEY. NOTE: Unencrypted private key is not accepted.
Private Key Passphrase	Provide the passphrase to decrypt the encrypted private key. Allows up to 64 characters including whitespace.
User/Public Certificate	Upload/replace or remove a user/public certificate. The supported file formats are PEM (Privacy Enhanced Mail) or the DER (Distinguished Encoding Rules) format with permitted file extensions .pem, .PEM, .der, or .DER.

Configure Network Settings

Protocol Configuration Summary

Path: Configuration > Network > Summary

You can use this page to view all protocols enabled or disabled on your Rack PDU. Select a link for any protocol to go to the appropriate configuration page.



Automatic Transfer Switch Application



No Alarms

apc | English | Log Off | Help |

Home Status ▾ Control ▾ Configuration ▾ Tests ▾ Logs ▾ About ▾

Configuration Summary

IPv4	Enabled	Configure
IPv6	Enabled	Configure
Ping Response	Enabled	Configure

HTTP	Enabled	Configure		
HTTPS	Enabled	Access	SSL Certificate	
FTP	Enabled	Configure		
Telnet	Enabled	Configure		
SSH/SCP	Enabled	Access	SSH Host Key	
SNMPv1	Read/Write	Access	Access Control	
SNMPv3	Disabled	Access	Access Control	User Profiles

Super User	Enabled	Configure	
RADIUS	Disabled	Authentication	RADIUS
Administrator	Disabled	Configure	
Device User	Disabled	Configure	
Read-Only User	Disabled	Configure	
Network-Only User	Disabled	Configure	

[APC's Web Site](#) | [Testdrive Demo](#) | [EcoStruxure™ IT](#)

© 2020, Schneider Electric. All rights reserved.
Site Map | Updated: 09/17/2020 at 10:01 (apcd8f074.us.ddns.schneider-electric.com)

Configure TCP/IP and communication settings for IPv4 and IPv6

Path: Configuration > Network > TCP/IP > IPv4

View the current IPv4 address, subnet mask, default gateway, MAC address, and boot mode of the Rack ATS. For information on DHCP and DHCP options, see [RFC2131](#) and [RFC2132](#).

Setting	Description
Enable	Enable or disable IPv4 with this check box.
Manual	Configure IPv4 manually by entering the IP address, subnet mask, and default gateway.
BOOTP	<p>A BOOTP server provides the TCP/IP settings. At 32-second intervals, the Rack ATS requests network assignment from any BOOTP server:</p> <ul style="list-style-type: none">• If the Rack ATS receives a valid response, it starts the network services.• If the Rack ATS finds a BOOTP server, but a request to that server fails or times out, the Rack ATS stops requesting network settings until it is restarted.• By default, if previously configured network settings exist, and the Rack ATS receives no valid response to five requests (the original and four retries), it uses the previously configured settings so that it remains accessible. <p>Click Next>> to access the BOOTP Configuration page to change the number of retries or the action to take if all retries fail:</p> <ul style="list-style-type: none">• Maximum retries: Enter the number of retries that will occur when no valid response is received, or zero (0) for an unlimited number of retries.• If retries fail: Select Use prior settings (the default) or Stop BOOTP request.
DHCP	<p>The default setting. At 32-second intervals, the Rack ATS requests network assignment from any DHCP server.</p> <ul style="list-style-type: none">• If the Rack ATS receives a valid response, it does not (as previously) require the APC cookie from the DHCP server in order to accept the lease and start the network services.• If the Rack ATS finds a DHCP server, but the request to that server fails or times out, it stops requesting network settings until it is restarted.¹ <p>Require vendor specific cookie to accept DHCP Address: By selecting this check box, you can require the DHCP server to provide a cookie which supplies information to the Rack ATS.</p>
<p>NOTE: The default values for these three settings on configuration pages generally do not need to be changed:</p> <ul style="list-style-type: none">• Vendor Class: APC• Client ID: The MAC address of the ATS, which uniquely identifies it on the local area network (LAN)• User Class: The name of the application firmware module	

DHCP response options

Each valid DHCP response contains options that provide the TCP/IP settings that the Rack ATS needs to operate on a network, and other information that affects the operation of the Rack ATS.

Vendor Specific Information (option 43)

The Rack ATS uses this option in a DHCP response to determine whether the DHCP response is valid. This option contains an APC-specific option in a TAG/LEN/DATA format, called the APC Cookie. This is disabled by default.

- APC Cookie. Tag 1, Len 4, Data "1APC"

Option 43 communicates to the Rack ATS that a DHCP server is configured to service devices.

Following, in hexadecimal format, is an example of a Vendor Specific Information option that contains the APC cookie:

```
Option 43 = 0x01 0x04 0x31 0x41 0x50 0x43
```

TCP/IP options

The Rack ATS uses the following options within a valid DHCP response to define its TCP/IP settings. All of these options except the first are described in [RFC2132](#).

- **IP Address** (from the **yiaddr** field of the DHCP response, described in [RFC2131](#)): The IP address that the DHCP server is leasing to the Rack ATS.
- **Subnet Mask** (option 1): The Subnet Mask value that the Rack ATS needs to operate on the network.
- **Router**, i.e., Default Gateway (option 3): The default gateway address that the Rack ATS needs to operate on the network.
- **IP Address Lease Time** (option 51): The time duration for the lease of the IP Address to the Rack ATS.
- **Renewal Time**, T1 (option 58): The time that the Rack ATS must wait after an IP address lease is assigned before it can request a renewal of that lease.
- **Rebinding Time**, T2 (option 59): The time that the Rack ATS must wait after an IP address lease is assigned before it can seek to rebind that lease.

Other options

The Rack ATS also uses these options within a valid DHCP response. All of these options except the last are described in [RFC2132](#).

- **Network Time Protocol Servers** (option 42): Up to two NTP servers (primary and secondary) that the Rack ATS can use.
- **Time Offset** (option 2): The offset of the Rack ATS unit's subnet, in seconds, from Coordinated Universal Time (UTC).
- **Domain Name Server** (option 6): Up to two Domain Name System (DNS) servers (primary and secondary) that the Rack ATS can use.
- **Host Name** (option 12): The host name that the Rack ATS will use (32-character maximum length).
- **Domain Name** (option 15): The domain name that the Rack ATS will use (64-character maximum length).
- **Boot File Name** (from the file field of the DHCP response, described in [RFC2131](#)): The fully qualified directory-path to a user configuration file (.ini file) to download. The **siaddr** field of the DHCP response specifies the IP address of the server from which the Rack ATS will download the .ini file. After the download, the .ini file is used as a boot file to reconfigure the settings.

Path: Configuration > Network > TCP/IP > IPv6 settings

Setting	Description
IPv6	Enable or disable IPv6 with this check box.
Manual Configuration	Configure IPv6 manually by entering the IP address and the default gateway.
Auto Configuration	When the Auto Configuration check box is selected, the system obtains addressing prefixes from the router (if available). It uses those prefixes to automatically configure IPv6 addresses.
DHCPv6 Mode	<p>Router Controlled: Selecting this option means that DHCPv6 is controlled by the Managed (M) and Other (O) flags received in IPv6 router advertisements. When a router advertisement is received, the ATS checks whether the M or the O flag is set. The NMC interprets the state of the M (Managed Address Configuration Flag) and O (Other Stateful Configuration Flag) "bits" for the following cases:</p> <ul style="list-style-type: none"> • <i>Neither is set:</i> Indicates the local network has no DHCPv6 infrastructure. The ATS uses router advertisements and manual configuration to get addresses that are not link-local and other settings. • <i>M, or M and O are set:</i> In this situation, full DHCPv6 address configuration occurs. DHCPv6 is used to obtain addresses AND other configuration settings. This is known as DHCPv6 <i>stateful</i>. Once the M flag has been received, the DHCPv6 address configuration stays in effect until the interface in question has been closed. This is true even if subsequent router advertisement packets are received in which the M flag is not set. If an O flag is received first, then an M flag is received subsequently, the ATS performs full address configuration upon receipt of the M flag • <i>Only O is set:</i> In this situation, the NMC sends a DHCPv6 Info-Request packet. DHCPv6 will be used to configure "other" settings (such as location of DNS servers), but NOT to provide addresses. This is known as DHCPv6 <i>stateless</i>. <p>Address and Other Information: With this radio box selected, DHCPv6 is used to obtain addresses AND other configuration settings. This is known as DHCPv6 <i>stateful</i>.</p> <p>Non-Address Information Only: With this radio box selected, DHCPv6 will be used to configure "other" settings (such as location of DNS servers), but NOT to provide addresses. This is known as DHCPv6 <i>stateless</i>.</p> <p>Never: Select this to disable DHCPv6.</p>

Configure network port speed

Path: Configuration > Network > Port Speed

The **Port Speed** setting defines the communication speed of the TCP/IP port.

- For **Auto-negotiation** (the default), Ethernet devices negotiate to transmit at the highest possible speed, but if the supported speeds of two devices are unmatched, the slower speed is used.
- Alternatively, you can choose **10 Mbps** or **100 Mbps**, each with the option of **half-duplex** (communication in only one direction at a time) or **full-duplex** (communication in both directions on the same channel simultaneously).

Configure DNS

Path: Configuration > Network > DNS > Configuration

Use the options under **Configuration** to configure and test the Domain Name System (DNS):

- **Override Manual DNS Settings:** When enabled, configuration data from other sources (typically DHCP) takes precedence over the manual configurations set here.
- **Primary DNS Server or Secondary DNS Server:** Select one of these to specify the IPv4 or IPv6 addresses of the primary and optional secondary DNS server. For the Rack ATS to send e-mail, you must at least define the IP address of the primary DNS server.
 - The Rack ATS waits up to 15 seconds for a response from the primary DNS server or secondary DNS server (if specified). If the Rack ATS does not receive a response within that time, e-mail cannot be sent. Use DNS servers on the same segment as the Rack ATS or on a nearby segment (but not across a wide-area network [WAN]).
 - Define the IP addresses of the DNS servers, then enter the DNS name of a computer on your network to look up the IP address for that computer to verify correct operation.
- **System Name Synchronization:** Allow the system name to be synchronized with the host name so both fields automatically contain the same value.
NOTE: When enabling this feature, the system name identifier can no longer contain a space character (since it will be synchronized to the host name field).
- **Host Name:** Configure a host name here and a domain name in the **Domain Name** field. Users can then enter a host name in any field in the NMC interface (except e-mail addresses) that accepts a domain name.
- **Domain Name (IPv4/IPv6):** Configure the domain name here only. In all other fields in the NMC interface (except e-mail addresses) that accept domain names, the Rack ATS adds this domain name when only a host name is entered.
 - To override all instances of the expansion of a specified host name by the addition of the domain name, set the domain name field to its default, *somedomain.com*, or to *0.0.0.0*.
 - To override the expansion of a specific host name entry, include a trailing period. The NMC recognizes a host name with a trailing period (such as *mySnmpServer.*) as if it were a fully-qualified domain name and does not append the domain name.
- **Domain Name (IPv6):** Specify the IPv6 domain name here.

Test DNS configuration

Path: Configuration > Network > DNS > Test

Use this option to send a DNS query that tests the setup of your DNS servers by looking up the IP address. View the result of a test in the **Last Query Response** field, or identify the value to be used for the selected query type:

Query Type Selected	Query Question to Use
by Host	The URL name of the server
by FQDN	The fully qualified domain name of the server, <i>my_server.my_domain</i>
by IP	The IP address of the server
by MX	The mail exchange address of the server

Configure Web access

Path: Configuration > Network > Web > Access

To activate changes to any of these selections, all users must log off:

- **Enable HTTP:** Enables Hypertext Transfer Protocol (HTTP), which provides Web access by user name and password, but does not encrypt user names, passwords, and data during transmission. HTTP is disabled by default.
- **Enable HTTPS:** Enables Hypertext Transfer Protocol (HTTPS) over Secure Sockets Layer (SSL)/Transport Layer Security (TLS). SSL and TLS encrypt user names, passwords, and data during transmission, and authenticate the Rack ATS by digital certificate. When HTTPS is enabled, your browser displays a small lock icon. For more information on HTTPS, see “Creating and Installing Digital Certificates” in the *Security Handbook*, available at www.apc.com. HTTPS is enabled by default.
- **HTTP Port:** The TCP/IP port (80 by default) used to communicate by HTTP with the Rack ATS.
- **HTTPS Port:** The TCP/IP port (443 by default) used to communicate by HTTPS with the Rack ATS.

NOTE: For either port, you can change the port setting to any unused port from 5000 to 32768 for additional security. Users must then use a colon (:) in the address field of the browser to specify the port number. For example, for a port number of 5000 and an IP address of 152.214.12.114:

```
http://152.214.12.114:5000  
https://152.214.12.114:5000
```

- **Minimum Protocol:** Select minimum HTTPS security protocol from the drop-down list.
- **Require Authentication cookie:** When the cookie is enabled, the user accessing the unit must have the correct session ID (present in the Web URL), the same remote IP address used to create the session, and the cookie present. When the cookie is disabled or has been deleted, a user can copy and paste the same URL with session ID to a new tab in the same web browser without being required to log in.

For more information, see FAQ article FA235784: go to www.apc.com, navigate to **Support > Resources & Tools > FAQs**, then enter the article number in the search bar.

- **Limited Status Access:** Select **Enable** to display a public, read-only Web page with basic device status. Select **Use as Default Page** to make this status page the landing page for the ATS.

Configure SSL certificate

Path: Configuration > Network > Web > SSL Certificate

View current certificate status. Add, replace, or remove a security certificate.

Status:

- **Not installed:** A certificate is not installed, or was installed by FTP or SCP to an incorrect location. Using **Add or Replace Certificate File** installs the certificate to the correct location, `/ssl` on the Rack ATS.
- **Generating:** The Rack ATS is generating a certificate because no valid certificate was found.
- **Loading:** A certificate is being activated on the Rack ATS.
- **Valid certificate:** A valid certificate was installed or was generated by the Rack ATS. Select this link to view the contents of the certificate.

NOTE: If you install an invalid certificate, or if no certificate is loaded when you enable SSL/TLS, the Rack ATS generates a default certificate, a process which delays access to the interface for up to one minute. You can use the default certificate for basic encryption-based security measures, but a security alert message displays whenever you log on.

Certificate Action:

- **Add or Replace:** Enter or browse to the certificate file created with the Security Wizard. See “Creating and Installing Digital Certificates” in the *Security Handbook*, available at www.apc.com, to choose a method for using digital certificates created by the Security Wizard or generated by the Rack ATS.
- **Remove:** Delete the current certificate.

Configure CLI access

Path: Configuration > Network > Console > Access

Enable Telnet: Telnet transmits user names, passwords, and data without encryption. Telnet is disabled by default.

Enable SSH: SSH transmits user names, passwords, and data in encrypted form, which helps to protect against attempts to intercept, forge, or alter data during transmission. SSH is enabled by default.

Telnet Port: The Telnet port (23 by default) is used to communicate with the Rack ATS. You can change the port setting to any unused port from 5000 to 32768 for additional security. Users must then use a colon (:) or a space, as required by your Telnet client program, to specify the non-default port. For example, for port 5000 and an IP address of 152.214.12.114, your Telnet client requires one of these commands:

```
telnet 152.214.12.114:5000
telnet 152.214.12.114 5000
```

SSH Port: The SSH port (22 by default) is used to communicate with the Rack ATS. You can change the port setting to any unused port from 5000 to 32768 for additional security. See the documentation for your SSH client for the command line format required to specify a non-default port.

Configure SSH host key

Path: Configuration > Network > Console > SSH Host Key

Status indicates the status of the host key (private key):

- **SSH Disabled: No host key in use:** When disabled, SSH cannot use a host key.
- **Generating:** The Rack ATS is creating a host key because no valid host key was found.
- **Loading:** A host key is being activated on the Rack ATS.
- **Valid:** One of the following valid host keys is in the `/ssh` directory (the required location on the Rack ATS):
 - A 1024-bit or 2048-bit host key created by the Security Wizard
 - A 2048-bit RSA host key generated by the Rack ATS

Certificate Action:

- **Add or Replace:** Browse to and upload a host key file created by the Security Wizard. To use the Security Wizard, see the *Security Handbook*, available at www.apc.com.
NOTE: To reduce the time required to enable SSH, create and upload a host key in advance. If you enable SSH with no host key loaded, the Rack ATS takes up to one minute to create a host key, and the SSH server is not accessible during that time.
- **Host Key Fingerprint:** A fingerprint helps authenticate a server. If the Security Wizard is used to generate the host key, it also generates the fingerprint, which is displayed here when SSH is enabled and the host key is in use. When you first connect to the device using SSH, compare the fingerprint presented by the SSH client to the fingerprint that the Security Wizard generated to ensure that they match. (Almost all SSH clients display the fingerprint.)
- **Remove:** Remove the current host key.

NOTE: To use SSH, you must have an SSH client installed. Most Linux and other UNIX platforms include an SSH client, but Microsoft Windows operating systems do not. Clients are available from various vendors.

SNMP options

All user names, passwords, and community names for SNMPv1 are transferred over the network as plain text. If your network requires the high security of encryption, disable SNMPv1 access and use SNMPv3 instead.

When using StruxureWare to manage a Rack ATS on the public network, you must have the same version of SNMP (1 or 3) enabled on both the Rack ATS interface and the StruxureWare interface. Read access will allow the StruxureWare to receive traps from the Rack ATS, but Write access is required while you set the StruxureWare as a trap receiver.

For detailed information on enhancing and managing the security of your system, see the *Security Handbook*, available at www.apc.com.

SNMPv1

NOTE: SNMPv1 is disabled by default. SNMPv2c is supported under SNMPv1 in this configuration.

Path: Configuration > Network > SNMPv1 > Access

Enable SNMPv1 Access: Enables SNMP version 1 as a method of communication with this device.

Path: Configuration > Network > SNMPv1 > Access Control

You can configure up to four access control entries to specify which Network Management Systems (NMSs) have access to this device. The opening page for access control, by default, assigns one entry to each of the four available SNMPv1 communities, but you can edit these settings to apply more than one entry to any community to grant access by several specific IPv4 and IPv6 addresses, host names, or IP address masks. To edit the access control settings for a community, select its community name.

- If you leave the default access control entry unchanged for a community, that community has access to this device from any location on the network.
- If you configure multiple access control entries for one community name, the limit of four entries requires that one or more of the other communities must have no access control entry. If no access control entry is listed for a community, that community has no access to this device.

Community Name: The name that an NMS must use to access the community. The maximum length is 15 ASCII characters.

NMS IP/Host Name: The IPv4 or IPv6 address, IP address mask, or host name that controls access by NMSs. A host name or a specific IP address (such as 149.225.12.1) allows access only by the NMS at that location. IP addresses that contain 255 restrict access as follows:

- 149.225.12.**255**: Access only by an NMS on the 149.225.12 segment.
- 149.225.**255.255**: Access only by an NMS on the 149.225 segment.
- 149.**255.255.255**: Access only by an NMS on the 149 segment.
- 0.0.0.0 (the default) or 255.255.255.255: Access by any NMS on any segment.

Access Type: The actions an NMS can perform through the community.

- **Read:** GETs only, at any time
- **Write:** GETs at any time, and SETs when no user is logged onto the Web UI or CLI.
- **Write+:** GETs and SETs at any time.
- **Disable:** No GETs or SETs at any time.

SNMPv3

For SNMP GETs, SETs, and trap receivers, SNMPv3 uses a system of user profiles to identify users. An SNMPv3 user must have a user profile assigned in the MIB software program to perform GETs and SETs, browse the MIB, and receive traps.

NOTE: To use SNMPv3, you must have an MIB program that supports SNMPv3.

Path: Configuration > Network > SNMPv3 > Access

SNMPv3 Access: Enables SNMPv3 as a method of communication with this device.

Path: Configuration > Network > SNMPv3 > User Profiles

By default, this page lists the settings of four user profiles configured with the user names **apc snmp profile1** through **apc snmp profile4**, and no authentication or privacy (no encryption). To edit the following settings for a user profile, select a user name in the list.

User Name: The identifier of the user profile. SNMPv3 maps GETs, SETs, and traps to a user profile by matching the user name of the profile to the user name in the data packet being transmitted. A user name can have up to 32 ASCII characters.

Authentication Passphrase: A phrase of 15 to 32 ASCII characters that verifies that the NMS communicating with this device through SNMPv3 is the NMS it claims to be, that the message has not been changed during transmission, and that the message was communicated in a timely manner, indicating that it was not delayed and that it was not copied and sent again later at an inappropriate time.

Privacy Passphrase: A phrase of 15 to 32 ASCII characters (`hidden crypt.phrase`, by default) that increases the privacy of the data (by means of encryption) that an NMS is sending to this device or receiving from this device through SNMPv3.

Authentication Protocol: The APC by Schneider Electric implementation of SNMPv3 supports SHA or MD5 authentication. Authentication will not occur unless an authentication protocol is selected.

Privacy Protocol: The implementation of SNMPv3 supports AES or DES as the protocols for encrypting and decrypting data. Privacy of transmitted data requires that a privacy protocol is selected and that a privacy passphrase is provided in the request from the NMS. When a privacy protocol is enabled but the NMS does not provide a privacy passphrase, the SNMP request is not encrypted.

NOTE: You cannot select the privacy protocol if no authentication protocol is selected.

Path: Configuration > Network > SNMPv3 > Access Control

You can configure up to four access control entries to specify which NMSs have access to this device. The opening page for access control, by default, assigns one entry to each of the four user profiles, but you can edit these settings to apply more than one entry to any user profile to grant access by several specific IP addresses, host names, or IP address masks.

- If you leave the default access control entry unchanged for a user profile, all NMSs using that profile have access to this device.
- If you configure multiple access entries for one user profile, the limit of four entries requires that one or more of the other user profiles must have no access control entry. If no access control entry is listed for a user profile, no NMS that uses that profile has any access to this device.

To edit the access control settings for a user profile, select its user name.

Access: Select the **Enable** check box to activate the access control specified by the parameters in this access control entry.

User Name: From the drop-down list, select the user profile to which this access control entry will apply. The choices available are the four user names that you configure on the **user profiles** page (see “Path: Configuration > Network > SNMPv3 > User Profiles” on page 107).

NMS IP/Host Name: The IP address, IP address mask, or host name that controls access by the NMS. A host name or a specific IP address (such as 149.225.12.1) allows access only by the NMS at that location. An IP address mask that contains 255 restricts access as follows:

- 149.225.12.**255**: Access only by an NMS on the 149.225.12 segment.
- 149.225.**255.255**: Access only by an NMS on the 149.225 segment.
- 149.**255.255.255**: Access only by an NMS on the 149 segment.
- 0.0.0.0 (the default) or 255.255.255.255: Access by any NMS on any segment.

Configure FTP server

Path: Configuration > Network > FTP Server

The **FTP Server** settings enable or disable access to the FTP server. FTP is disabled by default.

By default, the FTP server communicates with the ATS through TCP/IP port 21. The FTP server uses both the specified port and the port one number lower than the specified port.

You can change the **Port** setting to the number of any unused port from 5001 to 32768 for added security. Users must then use a colon (:) to specify the non-default port number.

For example, for port 5001 and IP address 152.214.12.114, the command would be

```
ftp 152.214.12.114:5001.
```

NOTE: FTP transfers files without encryption. For higher security, transfer files with Secure CoPy (SCP). Secure SHell (*SSH*) is enabled by default, and enables SCP automatically. However, SCP will not allow a file transfer until the Super User default password (*apc*) is changed. At any time that you want an ATS to be accessible for management by StruxureWare Data Center Expert, FTP server access must be enabled in the ATS interface.

NOTE: You can use FTP or SCP to configure and update the ATS with StruxureWare Data Center Expert or EcoStruxure IT as long as the same protocol is enabled on both the ATS and StruxureWare or EcoStruxure. See your StruxureWare Data Center Expert or EcoStruxure IT documentation for details.

For detailed information on enhancing and managing the security of your system, see the *Security Handbook*, available at www.apc.com.

Configure Notifications

You can configure event actions to occur in response to an event or group of events. These actions notify users of the event in any of several ways:

- Active, automatic notification. The specified users or monitoring devices are contacted directly.
 - E-mail notification
 - SNMP traps
 - Syslog notification
- Indirect notification
 - Event log. If no direct notification is configured, users must check the log to determine which events have occurred.
You can also log system performance data to use for device monitoring. See “Configure Logs” on page 117 for information on how to configure and use this data logging option.
 - Queries (SNMP GETs).
For more information, see “SNMP options” on page 105. SNMP enables an NMS to perform informational queries. For SNMPv1, which does not encrypt data before transmission, configuring the most restrictive SNMP access type (READ) enables informational queries without the risk of allowing remote configuration changes.

Configure notifications by event

Path: Configuration > Notification > Event Actions > By Event

By default, logging an event is selected for all events. To define event actions for an individual event:

1. To find an event, select a column heading to see the lists under **ATS (device events)** or **System** categories. Alternatively, you can select a sub-category under these headings, such as **Security** or **Power Supply**.
2. Select an event name to view the current configuration, such as recipients to be notified by e-mail, or Network Management Systems (NMSs) to be notified by SNMP traps. If no Syslog server is configured, items related to Syslog configuration are not displayed. You can also disable event logging or Syslog, or disable notification for specific e-mail recipients or trap receivers.

NOTE: When viewing details of an event configuration, you cannot add or remove recipients or receivers. To add or remove recipients or receivers, see the following:

- “Identify Syslog servers” on page 117
- “Path: Configuration > Notification > E-mail > Recipients” on page 112
- “Path: Configuration > Notification > SNMP Traps > Trap Receivers” on page 114

Configure notifications by group

Path: Configuration > Notification > Event Actions > By Group

To configure a group of events simultaneously:

1. Select how to group events for configuration:
 - Select **Events by Severity**, and then select one or more severity levels. You cannot change the severity of an event.
 - Select **Events by Category**, and then select events in one or more pre-defined categories.
2. Click **Next** to select an event action:
 - To select any action except **Logging** (the default), you must first have at least one relevant recipient or receiver configured.
3. Click **Next** to do one of the following:
 - If you selected **Logging** on the previous screen and have not configured a Syslog server, select the **Configure Event Log** check box.
 - If you selected **Logging** on the previous screen and have configured a Syslog server, select **Event Log** or **Syslog**. See “Configure Logs” on page 117.
 - If you selected **Email Recipients** on the previous screen, select the e-mail recipients to configure.
 - If you selected **Trap Receivers** on the previous screen, select the trap receiver to configure.
4. Click **Next** to configure notification parameters. These configuration fields define e-mail parameters for sending notifications of events:
 - If you are configuring **Logging** settings, select **Enable Notification** or **Disable Notification**.
 - If you are configuring **Email Recipients** or **Trap Receivers**, select **Enable Notification** or **Disable Notification** and set the notification parameters.
5. Click **Next** to view pending actions and do one of the following:
 - Click **Apply** to accept the changes.
 - Click **Cancel** to revert to the previous settings.

Notification parameters

These configuration fields define e-mail parameters for sending notifications of events. They are usually accessed by selecting the receiver or recipient name.

Field	Description
Delay n time before sending	If the event persists for the specified time, the notification is sent. If the condition clears before the time expires, no notification is sent.
Repeat at an interval of n	The notification is sent repeatedly at the specified interval (the default is every 2 minutes until the condition clears).
Up to n times or Until condition clears	During an active event, the notification repeats for this number of times. The notification is sent repeatedly until the condition clears or is resolved.

NOTE: For events that have an associated clearing event, you can also set these parameters.

Set up e-mail notifications

Use Simple Mail Transfer Protocol (SMTP) to send e-mail to up to four recipients when an event occurs. To use the e-mail feature, you must define the following settings:

- The IP addresses of the primary and, optionally, the secondary Domain Name System (DNS) servers.
- The IP address or DNS name for the SMTP Server and From Address.
- The e-mail addresses for a maximum of four recipients.
- You can use the To Address setting of the recipients option to send e-mail to a text-based screen.

Path: Configuration > Notification > E-mail > Server

This screen lists your primary and secondary DNS servers and displays the following fields:

Outgoing Mail Configuration

- **From Address:** The contents of the From field in e-mail messages sent by the Rack ATS:
 - In the format user@[IP_address] (if an IP address is specified as Local SMTP Server)
 - In the format user@domain (if DNS is configured and the DNS name is specified as Local SMTP Server) in the e-mail messages.
NOTE: The local SMTP server may require that you use a valid user account on the server for this setting. See the server documentation.
- **SMTP Server:** The IPv4/ IPv6 address or DNS name of the local SMTP server.
NOTE: This definition is required only when the SMTP server is set to **Local**.
- **Port:** The SMTP port number, with a default of 25. Supported ports include 25, 465, 587, 2525, and 5000 to 32768.
- **Authentication:** Select **Enable** if the SMTP server requires authentication.
- **User Name, Password, and Confirm Password:** If your mail server requires authentication, enter your user name and password here. This performs a simple authentication, not SSL/TLS.

Advanced

- **Use SSL/TLS:** Select when encryption is used.
 - **Never:** The SMTP server does neither requires nor supports encryption.
 - **If Supported:** The SMTP server advertises support for STARTTLS but doesn't require the connection to be encrypted. The STARTTLS command is sent after the advertisement is given.
 - **Always:** The SMTP server requires the STARTTLS command to be sent on connection to it.
 - **Implicitly:** The SMTP server only accepts connections that begin encrypted. No STARTTLS message is sent to the server.
- **Require CA Root Certificate:** This should only be enabled if the security policy of your organization does not allow for implicit trust of SSL/TLS connections. If this is enabled, a valid root CA certificate must be loaded onto the ATS for encrypted e-mails to be sent.
- **File Name:** This field is dependent on the root CA certificates installed on the ATS and whether or not a root CA certificate is required.

Path: Configuration > Notification > E-mail > Recipients

Specify up to four e-mail recipients. Click **Add Recipient**, or select a name to configure the settings.

E-mail Recipient

- **Generation:** Enable (default) or disable sending e-mail to the recipient.
- **To Address:** The user name and domain name of the recipient. To use e-mail for paging, use the e-mail address for the recipient's pager gateway account (for example, myacct100@skytel.com). The pager gateway will generate the page.

To bypass the DNS lookup of the IP address of the mail server, type the IP address in brackets instead of the e-mail domain name, e.g., use jsmith@[xxx.xxx.x.xxx] instead of jsmith@company.com. This is useful when DNS lookups are not working correctly.

- **Format:** The long format contains name, location, contact, IP address, serial number of the device, date and time, event code, and event description. The short format provides only the event description.
- **Language:** The language the e-mail notification will be sent in. This depends on the installed language pack (if applicable).
- **Server:** Select one of the following methods for routing e-mail:
 - **Local:** This is through the site-local SMTP server. This recommended setting uses a site-local SMTP server to send e-mail. Choosing this setting limits delays and network outages and retries sending e-mail for many hours. When choosing the Local setting you must also enable forwarding at the SMTP server of your device and set up a special external e-mail account to receive the forwarded e-mail. Check with your SMTP server administrator before making these changes.
 - **Recipient:** This is the SMTP server of the recipient. The ATS performs an MX record look-up on the recipients e-mail address and uses that as its SMTP server. The e-mail is only sent once so it could easily be lost.
 - **Custom:** This setting enables each e-mail recipient to have its own server settings. These settings are independent of the settings given under "SMTP Server" above.

Custom E-mail server Settings

- **From Address:** The contents of the From field in e-mail messages sent by the Rack ATS:
 - In the format user@ [IP_address] (if an IP address is specified as Local SMTP Server)
 - In the format user@domain (if DNS is configured and the DNS name is specified as Local SMTP Server) in the e-mail messages.

NOTE: The local SMTP server may require that you use a valid user account on the server for this setting. See the server documentation.
- **SMTP Server:** The IPv4/ IPv6 address or DNS name of the local SMTP server.

NOTE: This definition is required only when the SMTP server is set to **Local**.
- **Port:** The SMTP port number, with a default of 25. Supported ports include 25, 465, 587, 2525, and 5000 to 32768.
- **Authentication:** Enable this if the SMTP server requires authentication.
- **User Name, Password, and Confirm Password:** If your mail server requires authentication, enter your user name and password here. This performs a simple authentication, not SSL/TLS.

Advanced

- **Use SSL/TLS:** Select when encryption is used.
 - **Never:** The SMTP server does not require nor support encryption.
 - **If Supported:** The SMTP server advertises support for STARTTLS but doesn't require the connection to be encrypted. The STARTTLS command is sent after the advertisement is given.
 - **Always:** The SMTP server requires the STARTTLS command to be sent on connection to it.
 - **Implicitly:** The SMTP server only accepts connections that begin encrypted. No STARTTLS message is sent to the server.
- **Require CA Root Certificate:** This should only be enabled if the security policy of your organization does not allow for implicit trust of SSL/TLS connections. If this is enabled, a valid root CA certificate must be loaded onto the ATS for encrypted e-mails to be sent.
- **File Name:** This field is dependent on the root CA certificates installed on the ATS and whether or not a root CA certificate is required.

Path: Configuration > Notification > E-mail > SSL Certificates

Load a mail SSL/TLS certificate on the ATS for greater security. The file must have an extension of `.cert` or `.cer`. Up to five files can be loaded at any given time.

When installed, the certificate details also display here. An invalid certificate will display "n/a" for all fields except **File Name**.

Certificates can be deleted using this screen. Any e-mail recipients using the certificate should be manually modified to remove reference to this certificate.

Path: Configuration > Notification > E-mail > Test

Send a test message to a configured recipient.

SNMP traps

With Simple Network Management Protocol (SNMP) traps, you can automatically get notifications for significant ATS events. They are a useful tool for monitoring devices on your network.

Path: Configuration > Notification > SNMP Traps > Trap Receivers

The trap receivers are displayed by **NMS IP/Host Name**, (NMS stands for Network Management System). You can configure up to six trap receivers. To configure a new trap receiver, click **Add Trap Receiver**. To edit (or delete) a trap receiver, select its IP address/host name.

Trap Generation: Enable (the default) or disable trap generation for this trap receiver.

NMS IP/Host Name: The IPv4/ IPv6 address or host name of this trap receiver. The default, 0.0.0.0, leaves the trap receiver undefined.

Language: Select a language from the drop-down list. This can differ from the Web UI and from other trap receivers.

Select either **SNMPv1** or **SNMPv3** to specify the trap type. For an NMS to receive both types of traps, you must separately configure two trap receivers for that NMS, one for each trap type.

SNMPv1: Settings for SNMPv1.

- **Community Name:** The name used as an identifier when SNMPv1 traps are sent to this trap receiver.
- **Authenticate Traps:** When this option is enabled (the default), the NMS identified by the NMS IP/ Host Name setting will receive authentication traps (traps generated by invalid attempts to log on to this device).

SNMPv3: Settings for SNMPv3.

- **User Name:** Select the identifier of the user profile for this trap receiver.

If you delete a trap receiver, all notification settings configured under “Configuring event actions” for the deleted trap receiver are set to their default values.

Path: Configuration > Notification > SNMP Traps > Test

Last Test Result: The result of the most recent SNMP trap test. A successful SNMP trap test verifies only that a trap was sent; it does not verify that the trap was received by the selected trap receiver. A trap test succeeds if all of the following are true:

- The SNMP version (SNMPv1 or SNMPv3) configured for the selected trap receiver is enabled on this device.
- The trap receiver itself is enabled.
- If a host name is selected for the **To** address, that host name can be mapped to an valid IP address.

To: Select the IP address or host name to which a test SNMP trap will be sent. If no trap receiver is configured, a link to the **Trap Receiver** configuration screen (**snmp receiver**) is displayed.

General Configuration

This menu contains miscellaneous configuration items including device identification, date and time, exporting and importing your ATS configuration options, quick links, and data consolidation for troubleshooting.

Configure identification

Path: Configuration > General > Identification

Host Name Synchronization: Allows the host name to be synchronized with the system name so both fields automatically contain the same value.

NOTE: When enabling this feature, the system name identifier can no longer contain a space character (since it will be synchronized to the host name field).

Name, Contact, and Location: Define the **Name**, the **Contact** (the person responsible for the device), and the **Location** (the physical location), used by the SNMP agent of the ATS and StruxureWare.

These fields are used by the **sysName**, **sysContact**, and **sysLocation** object identifiers (OIDs) in the SNMP agent of the Rack ATS. For more information about MIB-II OIDs, see the PowerNet® *SNMP Management Information Base (MIB) Reference Guide*, available at www.apc.com.

The **Name** and **Location** fields also identify the device when you register for the Remote Monitoring Service.

System Message: When defined, a custom message will appear on the log on screen for all users.

Configure date, time, and daylight savings

Path: Configuration > General > Date/Time > Mode

Set the time and date used by the ATS. You can change the current settings manually or through a Network Time Protocol (NTP) Server:

Time Zone: This is your local time difference with Coordinated Universal Time (UTC), also known as Greenwich Mean Time (GMT).

Manual Mode: Do one of the following:

- Enter the date and time for the ATS.
- Select the **Apply Local Computer Time** check box to apply the date and time settings of the computer you are using.

Synchronize with NTP Server: Have an NTP (Network Time Protocol) Server define the date and time for the ATS. By default, any ATS on the private side of StruxureWare Server obtains its time settings by using StruxureWare as an NTP server.

- **Override Manual NTP Settings:** If you select this, data from other sources (typically DHCP) take precedence over the NTP configurations you set here.
- **Primary NTP Server:** Enter the IP address or domain name of the primary NTP server.
- **Secondary NTP Server:** Enter the IP address or domain name of the secondary NTP server, when a secondary server is available.
- **Update Interval:** Define, in hours, how often the ATS accesses the NTP Server for an update. Minimum: 1; Maximum: 8760 (1 year).
- **Update Using NTP Now:** Initiate an immediate update of the date and time by the NTP Server.

Path: Configuration > General > Date /Time > Daylight Saving

Daylight Saving Time (DST) is disabled by default. You can enable traditional United States DST, or enable and configure a customized daylight saving time to match how Daylight Saving Time is implemented in your local area.

When customizing DST, the system puts the clock forward by an hour when the time and date you specify under **Start** is reached, and puts the clock back an hour when the time and date you specify under **End** is reached.

- If your local DST always starts or ends on the fourth occurrence of a specific weekday of a month (e.g., the fourth Sunday), choose Fourth/Last. If a fifth Sunday occurs in that month, you should still choose Fourth/Last.
- If your local DST always starts or ends on the last occurrence of a specific weekday of a month, whether it is the fourth or the fifth occurrence, choose Fifth/Last.

Create and import settings with the config file

Path: Configuration > General > User Config File

Use the settings from one ATS to configure another. Retrieve the configuration file (*config.ini*) from the configured ATS, customize that file (e.g., change the IP address), and upload the customized file to the new ATS. The file name can be up to 64 characters, and must have the .ini suffix.

Status	Reports the progress of the upload. <ul style="list-style-type: none">• No configuration file uploaded: The ATS has not been configured with a <i>config.ini</i> file.• Configuration file successfully uploaded: The ATS has been configured with a <i>config.ini</i> file. You may need to refresh the page to see this message. NOTE: The upload succeeds even if the file contains errors, but a system event reports the errors in the event log.
Upload	Browse to the customized file and upload it so that the current ATS can use it to set its own configuration.
Download	Allows the download of the <i>config.ini</i> file directly through the Web browser to your computer.

To retrieve and customize the file of a configured ATS, see “How to Export Configuration Settings” on page 127. Instead of uploading the file to one ATS, you can export the file to multiple ATS units by using an FTP or SCP script.

Configure links

Path: Configuration > General > Quick Links

View and change the URL links displayed at the bottom left of each page of the interface.

By default, these links access the following Web pages:

- Link 1: The home page of the [APC by Schneider Electric](#) website.
- Link 2: Demonstrations of [APC by Schneider Electric](#) web-enabled products.
- Link 3: Information on [EcoStruxure IT](#).

Configure Logs

Identify Syslog servers

Path: Configuration > Logs > Syslog > Servers

Click **Add Server** to configure a new Syslog server.

Syslog Server: Uses IPv4/ IPv6 addresses or host names to identify from one to four servers to receive Syslog messages sent by the ATS.

Port: The port that the ATS will use to send Syslog messages. The default UDP port assigned to Syslog is 514.

Language: Select the language for any Syslog messages.

Protocol: Select either UDP or TCP.

Click **Apply** to save or **Cancel** to leave without saving.

Configure Syslog settings

Path: Configuration > Logs > Syslog > Settings

Message Generation: Enable the generation and the logging of Syslog messages for events that have Syslog configured as a notification method.

Facility Code: Selects the facility code assigned to the Syslog messages of the ATS (User, by default).

NOTE: User best defines the Syslog messages sent by the ATS. Do not change this selection unless advised to do so by the Syslog network or system administrator.

Severity Mapping: This section maps each severity level of the ATS or environment events to available Syslog priorities. The local options are Critical, Warning, and Informational. You should not need to change the mappings.

- **Emergency:** The system is unusable
- **Alert:** Action must be taken immediately
- **Critical:** Critical conditions
- **Error:** Error conditions
- **Warning:** Warning conditions
- **Notice:** Normal but significant conditions
- **Info:** Informational messages
- **Debug:** Debug-level messages

The following are the default settings for **Local Priority:**

- **Critical** is mapped to **Critical**
- **Warning** is mapped to **Warning**
- **Informational** is mapped to **Info**

Test Syslog servers

Path: Configuration > Logs > Syslog > Test

Send a test message to the Syslog servers (configured through the “Syslog servers” page). The result will be sent to all configured Syslog servers.

Select a severity to assign to the test message and then define the test message. Format the message to consist of the event type (for example, APC, System, or Device) followed by a colon, a space, and the event text. The message can have a maximum of 50 characters.

- The priority (PRI): the Syslog priority assigned to the message event, and the facility code of messages sent by the ATS.
- The Header: a time stamp and the IP address of the ATS.
- The message (MSG) part.
- The **TAG** field, followed by a colon and space, identifies the event type.
- The **CONTENT** field is the event text, followed (optionally) by a space and the event code.

Example: APC: Test Syslog is valid.

Tests Tab

Set the LCD/LED Lights to Blink

Path: Tests > ATS > LCD Blink

If you are having trouble finding your ATS, enter a number of minutes in the **LCD Blink Duration** field, and click **Apply**. The LCD display will blink for the specified number of minutes.

Set the LED Lights to Blink

Path: Tests > Network > LED Blink

The screenshot shows the Schneider Electric Automatic Transfer Switch Application web interface. The page title is "Network Test". The main content area is titled "LED Blink" and contains a form with the following elements:

- A label "LED Blink Duration" above a text input field containing the number "1".
- A "minutes" label to the right of the input field.
- "Apply" and "Cancel" buttons below the input field.

At the bottom of the page, there is a footer with the following text:

APC's Web Site | Testdrive Demo | EcoStruxure™ IT © 2020, Schneider Electric. All rights reserved. [Site Map](#) | Updated: 09/17/2020 at 17:12 (apod81074.us.ddns.schneider-electric.com)

If you are having trouble finding your ATS, enter a number of minutes in the **LED Blink Duration** field, and click **Apply**. The Network Status and 10/100 Status LED lights on the display will blink for the specified number of minutes.

Logs Tab

View and configure the Event Log

By default, the Event Log displays all events recorded during the last two days, starting with the latest events.

Additionally, the log records any event that sends an SNMP trap, except SNMP authentication failures, and abnormal internal system events.

You can enable color coding for events on the **Local User Management** screen (see “Manage local user settings” on page 90).

Path: Logs > Events > Log

The screenshot shows the Schneider Electric Automatic Transfer Switch Application interface. At the top, there is a navigation bar with the Schneider Electric logo, the application name "Automatic Transfer Switch Application", and the EcoStruxure IT logo. The navigation bar includes links for Home, Status, Control, Configuration, Tests, Logs, and About. The main content area is titled "Event Log Filtering" and contains a form for filtering logs. The "Event Time" section has a radio button for "Last" selected and a dropdown menu set to "All Logs". The "From" section has a date range from "01/01/2001 00:00" to "09/17/2020 10:05". Below the form are buttons for "Apply", "Clear Log", "Filter Log", and "Launch Log in New Window".

Below the filtering section is the "Event Log" section, which displays a table of events. The table has columns for Date, Time, User, and Event. The events are listed in descending order of time. The table is paginated with 8 pages and a "Next >" button.

Date	Time	User	Event
09/17/2020	10:05:00	apc	Web user 'apc' logged in from 10.252.104.43.
09/17/2020	10:04:24	System	Web user 'apc' logged out from 10.252.104.43.
09/17/2020	10:00:45	apc	User 'apc' edited.
09/17/2020	10:00:00	apc	Web user 'apc' logged in from 10.252.104.43.
09/17/2020	09:59:24	System	Web user 'apc' logged out from 10.252.104.43.
09/17/2020	09:47:36	apc	Web user 'apc' logged in from 10.252.104.43.
09/17/2020	09:46:11	System	Web user 'apc' logged out from 10.252.104.43.
09/17/2020	09:41:54	System	Web user 'apc' logged out from 10.218.125.23.
09/17/2020	09:39:17	apc	Web user 'apc' logged in from 10.252.104.43.
09/17/2020	09:38:36	apc	Web user 'apc' logged in from 10.218.125.23.
09/17/2020	09:38:30	System	Detected an unauthorized user attempting to access the Web interface from 10.218.125.23.
09/17/2020	09:38:06	System	Network service started. System IP is 10.218.117.199 from DHCP server 10.218.99.23 with 259192 second lease.

At the bottom of the page, there is a footer with the text "APC's Web Site | Testdrive Demo | EcoStruxure™ IT" on the left and "© 2020, Schneider Electric. All rights reserved. Site Map | Updated: 09/17/2020 at 10:05 (apc@6074.us.ddns.schneider-electric.com)" on the right.

To open the log in a text file or to save the log to a disk, click on the floppy disk  on the same line as the **Event Log** heading.

To see the events listed together on a Web page, click **Launch Log in New Window**.

You can also use FTP or Secure CoPy (SCP) to view the event log. See “Use FTP or SCP to retrieve log files” on page 123.

Event Log Filtering: Use filtering to omit information you don't want to display.

- Filter the log by date or time: Use **Last** or **From** to define the time in which the events were logged. (The filter configuration is saved until the ATS restarts.)
- Filter the log by event severity or category:
 - a. Click **Filter Log**.
 - b. Clear a check box to remove it from view.
 - c. After you click **Apply**, text at the upper right corner of the **Event Log** page indicates that a filter is active. The filter is active until you clear it or until the ATS restarts.
 - d. As a Super User or Administrator, click **Save As Default** to save this filter as the new default log view for all users.
- Remove an active filter:
 - a. Click **Filter Log**.
 - b. Click **Clear Filter (Show All)**.

Important points on filtering:

- Events are processed through the filter using OR logic. If you apply a filter, it works regardless of the other filters.
- Events that you cleared in the **Filter By Severity** list do not display in the filtered Event Log, even if selected in the **Filter by Category** list.
- Similarly, events that you clear in the Filter by Category list do not display in the filtered Event Log.

Clear Log: To delete all events, click **Clear Log**. Deleted events cannot be retrieved.

To disable the logging of events based on their assigned severity level or their event category, see “Configure Notifications” on page 109

Path: Logs > Events > Reverse Lookup

With reverse lookup enabled, when a network-related event occurs, both the IP address and the domain name for the networked device with the event are logged in the event log. If no domain name entry exists for the device, only its IP address is logged with the event.

Since domain names generally change less frequently than IP addresses, enabling reverse lookup can improve the ability to identify addresses of networked devices that are causing events.

Reverse lookup is disabled by default. You should not need to enable it if you have no DNS server configured or have poor network performance because of heavy network traffic.

Path: Logs > Events > Size

Event Log Size: Specify the maximum number of log entries.

NOTE: When you resize the event log in order to specify a maximum size, all existing log entries are deleted. When the log subsequently reaches the maximum size, the older entries are deleted.

View and configure the Data Log

Use the data log to display measurements about the Rack ATS, the power input to the Rack ATS, and the ambient temperature of the Rack ATS.

The steps to display and resize the data log are the same as for the event log, except that you use menu options under **Data** instead of **Events**.

Path: Logs > Data > Log

View the log by date or time: Use **Last** or **From** to define the time in which the data was logged, and click **Apply** to save your changes. (The filter configuration is saved until the unit restarts.)

Clear Data Log: Delete all data log records. Deleted data log records cannot be retrieved.

Launch Log in New Window: View the log on a separate Web page.

Path: Logs > Data > Graphing

Graph Data: Scroll through the list and select the data you would like to graph. Click **Apply** to save your changes.

Filter the graph by date or time: Use **Last** or **From** to define the time in which the events were logged. Click **Apply** to save your changes. (The filter configuration is saved until the ATS restarts.)

Launch Graph in New Window: View the graph on a separate Web page.

Path: Logs > Data > Interval

Define, in the **Log Interval** setting, how frequently data is searched for and stored in the data log. When you click **Apply**, the number of possible storage days is recalculated and displays at the top of the screen. When the log is full, the oldest entries are deleted.

NOTE: Because the interval specifies how often the data is recorded, small intervals will cause data to be recorded more quickly and thus to hold entries for shorter periods of time.

Path: Logs > Data > Rotation

Rotation causes the contents of the data log to be appended to the file you specify by name and location. Use this option to set up password-protection and other parameters.

- **FTP Server:** The IP address or host name of a user-supplied server where the file will reside.
- **User Name, Password:** The user name and password required to send data to the repository file. This user must also be configured to have read and write access to the data repository file and the directory (folder) in which it is stored.
- **File Path:** The path to the repository file.
- **Filename:** The name of the repository file (an ASCII text file), e.g. *datalog.txt*. Any new data is appended to this file: it does not overwrite it.
- **Unique Filename:** Select this check box to save the log as *mmddyyyy_<filename>.txt*, where *filename* is what you specified in the **Filename** field above. Any new data is appended to the file but each day has its own file.
- **Delay n hours between uploads:** The number of hours between data uploads (max. 24 hours).
- **Upon failure, try uploading every n minutes:** The number of minutes between attempts to upload data to the file after a failed upload.
 - **Maximum Attempts:** The maximum number of upload attempts after an initial upload failure.
 - **Until upload succeeds:** Attempt to upload the file until the transfer is completed.

Click **Apply** to save these settings, **Cancel** to erase your changes, or **Upload Now!** to rotate log data.

Path: Logs > Data > Size

Data Log Size: specify the maximum number of log entries.

NOTE: When you change the maximum log size, all existing entries are deleted. When the log subsequently reaches the maximum size, the older entries are deleted.

Firewall log

Path: Logs > Firewall

If you create a firewall policy (see “Firewall menus” on page 95), firewall events will be logged here. The information in the log can be useful to help the technical support team solve problems. Log entries contain information about the traffic and the rules action (allowed or discarded). When logged here, these events are not logged in the main Event Log (see “View and configure the Event Log” on page 120).

A firewall log contains up to 50 of the most recent events. The firewall log is cleared when the management interface reboots.

Use FTP or SCP to retrieve log files

An Administrator or Device User can use FTP or SCP to retrieve a tab-delineated event log file (*event.txt*) or data log file (*data.txt*) and import it into a spreadsheet.

- The file reports all recent stored events. If the log has been deleted or truncated because it reached maximum size, the deleted or truncated information will not be included in the file.
- The file includes information that the event log or data log does not display.
 - The version of the file format (first field)
 - The date and time the file was retrieved
 - The **Name**, **Contact**, and **Location** values and IP address of the ATS
 - The unique **Event Code** for each recorded event (*event.txt* file only)

NOTE: The ATS uses a four-digit year for log entries. You may need to select a four-digit date format in your spreadsheet application to display all four digits.

If you are using the encryption-based security protocols for your system, use SCP to retrieve the log file.

If you are using unencrypted authentication methods for the security of your system, use FTP to retrieve the log file.

NOTE: By default, FTP is disabled and SCP (via SSH) is enabled.

See the *Security Handbook* on www.apc.com for information on available security protocols and methods.

Use SCP to retrieve the files

To retrieve the *event.txt* file, use the following command:

```
scp -c <cipher> username@hostname_or_ip_address:event.txt ./event.txt
```

To use SCP to retrieve the *data.txt* file, use the following command:

```
scp -c <cipher> username@hostname_or_ip_address:data.txt ./data.txt
```

NOTES:

- This SCP command is for OpenSSH. The command may differ depending on the SSH tool used.
- When using OpenSSH, <cipher> can be either aes256-cbc or 3des-cbc.

Use FTP to retrieve the *event.txt* or *data.txt* files

1. At a command prompt, type `ftp` and the IP address of the ATS, and press ENTER. If the **Port** setting for the **FTP Server** option (set through the **Network** menu of the **Administration** tab) has been changed from its default (**21**), you must use the non-default value in the FTP command. For Windows FTP clients, use the following command, including spaces. (For some FTP clients, you must use a colon instead of a space between the IP address and the port number.)

```
ftp>open ip_address port_number
```

To set a non-default port value to enhance security for the FTP Server, see “Configure FTP server” on page 108. You can specify any port from 5001 to 32768.

2. Use the case-sensitive **User Name** and **Password** for Administrator or Device User to log on. For Administrator, **apc** is the default for **User Name** and **Password**. For the Device User, the defaults are **device** for **User Name** and **apc** for **Password**.
3. Use the `get` command to transmit the text of a log to your local drive.

```
ftp>get event.txt
```

or

```
ftp>get data.txt
```

4. Type `quit` at the `ftp>` prompt to exit from FTP.

About Tab

About the Rack ATS

Path: About > ATS

Automatic Transfer Switch

Name apcD8F074	Location Unknown	Contact Unknown
Model Number AP4452	Rating 1ø, 16 A	Serial Number 5A1713T59925
Hardware Revision R01	Manufacture Date 07/17/2019	Phases 1
Circuit Breakers 0	Outlets 10	NMC Serial Number AABBAA
NMC Uptime 0 Days 0 Hours 29 Minutes	Network Link Link Active	

ATS Controller Firmware

Firmware Version 4.3.4	Firmware Date 09/24/19	Downloader Version 4.0
----------------------------------	----------------------------------	----------------------------------

[APC's Web Site](#) | [Testdrive Demo](#) | [EcoStruxure™ IT](#)

© 2020, Schneider Electric. All rights reserved.
[Site Map](#) | Updated: 09/17/2020 at 10:07 (apcd8f074.us.ddns.schneider-electric.com)

The hardware information is useful to APC by Schneider Electric Customer Support for troubleshooting problems with the ATS. The serial number and MAC address are also available on the ATS itself.

Management Uptime is the length of time the network management interface has been running continuously.

About the network

Path: About > Network

Information for the Application Module, APC OS (AOS), and APC Boot Monitor indicates the name, the firmware version, and the date and time each firmware module was created. This information is also useful in troubleshooting and enables you to determine if updated firmware is available at the website, www.apc.com.

Support resources

Path: About > Support

This page provides links to multiple support resources:

- **Knowledge Base:** Direct link to FAQs on the APC by Schneider Electric website.
- **Company Contact Information:** Provides phone numbers for multiple support services provided by APC by Schneider Electric.
- **Software & Firmware Downloads:** Download software upgrades for your product.

You can also generate and download a file of data needed for technical support. The data included in the file will be compiled from existing logs and will depend on your current log configurations (see Logs, page 117).

How to Export Configuration Settings

Summary of the procedure

A Super User/Administrator can retrieve the .ini file of an ATS and export it to another ATS or to multiple ATS units. The steps are below; see details in the sections following.

1. Configure an ATS with the desired settings, and retrieve the .ini file from that ATS.
2. Edit the file to change the TCP/IP settings at least.
3. Using a file transfer protocol supported by the ATS, transfer the .ini file to one or more other ATS units. For a transfer to multiple ATS units, use an FTP or SCP script, or the .ini file utility. Each receiving ATS uses the file to reconfigure its own settings and then deletes it.

NOTE: FTP is disabled by default. See “Configure FTP server” on page 108 to enable FTP.

NOTE: Managing Users via the config.ini - Users are no longer managed via the config.ini in any form. Users are now managed via a separate file with the .csf extension. For further information on this topic, refer to FAQ article FA176542: go to www.apc.com, navigate to **Support > Resources & Tools > FAQs**, then enter the article number in the search bar.

Contents of the .ini file

The config.ini file you retrieve from an ATS contains the following:

- Section headings and keywords (only those supported for the particular device from which you retrieve the file): **Section headings** are category names enclosed in brackets ([]). **Keywords**, under each section heading, are labels describing specific ATS settings. Each keyword is followed by an equals sign and a value (either the default or a configured value).
- The `Override` keyword: With its default value, this keyword helps prevent the exporting of one or more keywords and their device-specific values. For example, in the `[NetworkTCP/IP]` section, the default value for `Override` (the MAC address of the ATS) blocks the exporting of values for the `SystemIP`, `SubnetMask`, `DefaultGateway`, and `BootMode`.

Detailed procedures

Retrieve .ini file

To set up and retrieve an .ini file:

1. If possible, use the interface of an ATS to configure it with the settings to export. (Directly editing the .ini file risks introducing errors).
2. Use FTP or SCP to retrieve *config.ini* from the configured ATS:

- a. Open a connection to the ATS using its IP address:

```
ftp> open ip_address
```

- b. Log on using the Super User/Administrator user name and password.
- c. Retrieve the *config.ini* file containing the settings of the ATS:

```
ftp> get config.ini
```

The file is written to the folder from which you launched the FTP.

To export configuration settings to multiple ATS units, see FAQ article FA156117: go to www.apc.com, navigate to **Support > Resources & Tools > FAQs**, then enter the article number in the search bar.

- To use SCP, use the following command:

```
scp -c <cipher> username@hostname_or_ip_address:config.ini ./config.ini
```

Then enter the correct password.

NOTES:

- This SCP command is for OpenSSH. The command may differ depending on the SSH tool used.
- When using OpenSSH, <cipher> can be either aes256-cbc or 3des-cbc.

Edit .ini file

Edit the file carefully before you transfer it to other ATS units.

1. Use a text editor to make your changes.
 - Section headings, keywords, and pre-defined values are not case-sensitive, but string values that you define are case-sensitive.
 - Use adjacent quotation marks to indicate no value. For example, `LinkURL1=""` indicates that the URL is intentionally undefined.
 - Enclose in quotation marks any values that contain leading or trailing spaces or are already enclosed in quotation marks.
 - To export scheduled events, configure the values directly in the .ini file.
 - To export a system time with the greatest accuracy, if the receiving ATS units can access a Network Time Protocol server, configure `enabled` for `NTPEnable`:

```
NTPEnable=enabled
```

Alternatively, reduce transmission time by exporting the `[SystemDate/Time]` section as a separate .ini file.
 - To add comments, start each comment line with a semicolon (;).
2. Copy the customized file to another file name in the same folder:
 - The file name can have up to 64 characters and must have the .ini suffix.
 - Retain the original customized file for future use. **The file that you retain is the only record of your comments.**

Transfer the file to a single ATS

To transfer the .ini file to another ATS, do either of the following:

- From the Web UI of the receiving ATS, select **Configuration > General > User Config File**. Enter the full path of the file, or use Browse on your local PC.
- Use any file transfer protocol supported by ATS units, i.e., FTP, FTP Client, SCP, or TFTP. The following example uses FTP:
 - a. From the folder containing the copy of the customized .ini file, use FTP to log in to the ATS to which you are exporting the .ini file:

```
ftp> open ip_address
```
 - b. Export the copy of the customized .ini file to the root directory of the receiving ATS:

```
ftp> put filename.ini
```

Transfer the file to multiple ATS units

To transfer the .ini file to multiple ATS units, do one of the following:

- Use FTP or SCP, but write a script that incorporates and repeats the steps used for exporting the file to a single ATS.
- Use a batch processing file and the .ini file utility.
To create the batch file and use the utility, see FAQ article FA156117: go to www.apc.com, navigate to **Support > Resources & Tools > FAQs**, then enter the article number in the search bar.

The Upload Event and Error Messages

The event and its error messages

The following event occurs when the receiving ATS completes using the .ini file to update its settings.

```
Configuration file upload complete, with number valid values
```

If a keyword, section name, or value is invalid, the upload by the receiving ATS succeeds, and additional event text states the error.

Event text	Description
Configuration file warning: Invalid keyword on line number. Configuration file warning: Invalid value on line number.	A line with an invalid keyword or value is ignored.
Configuration file warning: Invalid section on line number.	If a section name is invalid, all keyword/value pairs in that section are ignored.
Configuration file warning: Keyword found outside of a section on line number.	A keyword entered at the beginning of the file (i.e., before any section headings) is ignored.
Configuration file warning: Configuration file exceeds maximum size.	If the file is too large, an incomplete upload occurs. Reduce the size of the file, or divide it into two files, and try uploading again.

Messages in config.ini

A Rack ATS from which you download the config.ini file must be discovered successfully in order for its configuration to be included. If the ATS is not present or is not discovered, the config.ini file contains a message under the appropriate section name, instead of keywords and values. For example: `Rack
ATS not discovered`

If you did not intend to export the ATS configuration as part of the .ini file import, ignore these messages.

Errors generated by overridden values

The `Override` keyword and its value will generate error messages in the event log when it blocks the exporting of values. See “Contents of the .ini file” on page 127 for information about which values are overridden.

Because the overridden values are device-specific and not appropriate to export to other ATS units, ignore these error messages. To prevent these error messages, delete the lines that contain the `Override` keyword and the lines that contain the values that they override. Do not delete or change the line containing the section heading.

Related Topics

On Windows operating systems, instead of transferring .ini files, you can use the Device IP Configuration Wizard to update the basic TCP/IP settings of the ATS and configure other settings through its user interface. See “Device IP Configuration Wizard” on page 7.

File Transfers

Upgrading Firmware

Benefits of upgrading firmware

When you upgrade the firmware on the ATS:

- You obtain the latest bug fixes and performance improvements.
- New features become available for immediate use.

Keeping the firmware versions consistent across your network helps ensure that all ATS units support the same features in the same manner. Here, upgrading simply means placing the module files on the ATS; there is no installation required. Check regularly on www.apc.com for any new upgrades

Firmware module files

A firmware release has three modules, and they *must* be upgraded (that is, placed on the Rack ATS) in the same order as shown in the table below. **NOTE:** It is possible to skip upgrading the bootmon file if it is already the same version as the file located on the card

Order	Module	Description
1	Boot Monitor (bootmon)	Roughly equivalent to the BIOS of a PC
2	APC Operating System (AOS)	Can be considered the operating system of the ATS
3	Application	Specific to the Rack ATS device type

(Each module contains one or more Cyclical Redundancy Checks (CRCs) to help protect its data from corruption).

The boot monitor module, the AOS, and the application file names share the same basic format:

```
apc_hardware-version_type_firmware-version.bin
```

- `apc`: Indicates the context.
- `hardware-version:hw0n` where `n` identifies the hardware version on which you can use this file.
- `type`: Identifies which module.
- `version`: The version number of the file.
- `bin`: Indicates that this is a binary file.

Firmware File Transfer Methods

NOTE: Upgrade the bootmon module first, then the AOS module, and finally, the application module by placing them on the ATS in that order.

Obtain the free, latest firmware version from the APC by Schneider Electric website. To upgrade the firmware of one or more ATS units, use 1 of these 5 methods:

- On a Windows operating system, use the **Firmware Upgrade Utility** downloaded from the website www.apc.com.
- On any supported operating system, use **FTP** or **SCP** to transfer the individual AOS and application firmware modules.
- For a Rack ATS that is NOT on your network, use **XMODEM** through a serial connection to transfer the individual firmware modules from your computer to the Rack ATS.
- Use a **USB drive** to transfer the individual firmware modules from your computer.
- For upgrades to multiple ATS units, see “How to upgrade multiple ATS units” on page 135.

Use the Firmware Upgrade Utility

This Firmware Upgrade Utility is part of the firmware upgrade package available on the www.apc.com website. (Never use an Upgrade Utility designated for one product to upgrade the firmware of another product).

Use the Utility for upgrades on Windows-based systems

On any supported Windows operating system, the Firmware Upgrade Utility automates the transferring of the firmware modules *in the correct module order*.

Unzip the downloaded firmware upgrade file and double-click the .exe file. Then enter the IP address, the user name, and the password in the dialog fields and click **Upgrade Now**. You can use the **Ping** button to test your entered details.

Use the Utility for manual upgrades, primarily on Linux

On non-Windows operating systems, the Firmware Upgrade Utility extracts the individual firmware modules, but does not upgrade the Rack ATS. See “Firmware File Transfer Methods” on page 132 for the different upgrade methods after extraction.

To extract the firmware files:

1. After extracting files from the downloaded firmware upgrade file, run the **Firmware Upgrade Utility** (the .exe file).
2. At the prompts, click **Next>**, then specify the directory location to which the files will be extracted.
3. When the **Extraction Complete** message displays, close the dialog box.

Use FTP or SCP to upgrade one Rack ATS

FTP: To use FTP to upgrade a Rack ATS over the network:

- The Rack ATS must be on the network with its system IP, subnet mask, and default gateway configured.
- The FTP server must be enabled at the Rack ATS, see “Configure FTP server” on page 108.

NOTE: The following procedure assumes the bootmon file does not need upgrading. It is always necessary to upgrade the other two firmware module files.

To transfer the files:

1. Firmware module files must be extracted, see “Use the Firmware Upgrade Utility” on this page.
2. At a computer on the network, open a command prompt window. Go to the directory that contains the firmware files, and list the files:

```
C:\>cd apc
C:\apc>dir
```

3. Open an FTP client session: `C:\apc>ftp`
4. Type `open` with the **IP address** of the Rack ATS, and press ENTER. If the **port** setting for the FTP Server has changed from its default of **21**, you must use the non-default value in the FTP command.
 - For Windows FTP clients, separate a non-default port number from the IP address by a space. For example (showing a space before 21000):
`ftp> open 150.250.6.10 21000`
 - Some FTP clients require a colon instead before the port number.
5. Log on as Super User (**apc** is the default user name and password).
6. Upgrade the AOS. (Always upgrade the AOS before the application module).

```
ftp> bin
ftp> put apc_hw05_aos_ nnn.bin (where nnn is the firmware version number)
```
7. When FTP confirms the transfer, type `quit` to close the session.
8. After 20 seconds, repeat steps 3 through 7 using the application module file name in step 6.

SCP: To use Secure CoPy (SCP) to upgrade firmware for the Rack ATS, follow these steps (this procedure assumes bootmon does not need upgrading, it is always necessary to upgrade the other two though):

NOTE: As SCP is part of SSH, enabling SSH also enables SCP. SSH is enabled by default.

1. Locate the firmware modules, see “Use the Utility for manual upgrades, primarily on Linux” on page 132.
2. Use an SCP command line to transfer the AOS firmware module to the Rack ATS. The following example uses *nnn* to represent the version number of the AOS module:

```
scp -c <cipher> apc_hw05_aos_ nnn.bin
apc@158.205.6.185:apc_hw05_aos_ nnn.bin
```

NOTE: This SCP command is for OpenSSH. The command may differ depending on the SSH tool used. `<cipher>` can be either `aes256-cbc` or `3des-cbc`.

3. Use a similar SCP command line, with the name of the application module, to transfer the application firmware module to the Rack ATS. (Always upgrade the AOS before the application module).

Use XMODEM to upgrade one Rack ATS

To use XMODEM to upgrade one Rack ATS that is not on the network, you must extract the firmware files from the Firmware Upgrade Utility (see “To extract the firmware files:”).

To transfer the files (this procedure assumes bootmon does not need upgrading, it is always necessary to upgrade the other two though):

1. Select a serial port at the local computer and disable any service that uses the port.
2. Connect the provided serial configuration cable (part number 940-0144A) to the selected port and to the RJ-12 style serial port at the Rack ATS.
3. Run a terminal program such as TeraTerm or HyperTerminal, and configure the selected port for 57600 bps, 8 data bits, no parity, 1 stop bit, and no flow control.
4. Press the **Reset** button on the Rack ATS, then immediately press the **Enter** key twice, or until the Boot Monitor prompt displays: `BM>`
5. Type `XMODEM`, then press ENTER.
6. From the terminal program’s menu, select **XMODEM**, then select the binary AOS firmware file to transfer using XMODEM. After the XMODEM transfer is complete, the Boot Monitor prompt returns.
NOTE: Always upgrade the AOS before the application module.
7. To install the application module, repeat step 5 and step 6. In step 6, use the application module file name.
8. Type `reset` or press the **Reset** button to restart the Rack ATS’s management interface.

Use a USB drive to transfer and upgrade files

Use a USB drive to transfer and upgrade files. Before starting the transfer, make sure the USB drive is formatted in FAT32.

1. Download the firmware upgrade files and unzip them.
2. Create a folder named **apcfirm** on the USB flash drive.
3. Place the extracted module files in the **apcfirm** directory.
4. Use a text editor to create a file named *upload.rcf*. (The file extension must be `.rcf`, not `.txt` for example.)
5. In *upload.rcf*, add a line for each firmware module that you want to upgrade. For example, to upgrade to **bootmon** v1.0.8, **AOS** v6.9.4, and device application v6.9.4, type:

```
BM=apc_hw05_bootmon_108.bin
AOS=apc_hw05_aos_694.bin
APP=apc_hw05_ats4g_694.bin
```
6. Place *upload.rcf* in the **apcfirm** folder on the flash drive.
7. Insert the flash drive into a USB port on your ATS.
8. Press the **Reset** button on the front of the unit and wait for the Network Management Card to reboot fully, including the automatic ATS Controller reboot.
9. Check that the upgrade was completed successfully using the procedures in “Verifying Upgrades”.

How to upgrade multiple ATS units

Use one of these methods:

- **StruxureWare Data Center Expert or EcoStruxure IT:** See your StruxureWare or EcoStruxure documentation for instructions to update multiple ATS units.
- **Firmware Upgrade Utility:** Use this for multiple firmware updates in IPv4 if you have Windows. The utility records all upgrade steps in a log as a good reference to validate the upgrade. See “Use the Firmware Upgrade Utility” on page 132 or FAQ article FA156099 on www.apc.com for more information.
- **Export configuration settings:** You can create batch files and use the .ini file utility to retrieve configuration settings from multiple ATS units and export them to other ATS units. See FAQ article FA156117 on www.apc.com to download the .ini file utility and read the release notes (release notes are included with the utility file).
- **Use FTP or SCP to upgrade multiple ATS units:** To upgrade multiple ATS units using an FTP client or using SCP, write a script which automatically performs the procedure.

NOTE: To find an FAQ article, go to www.apc.com, navigate to **Support > Resources & Tools > FAQs**, then enter the article number in the Search bar.

Use the Firmware Upgrade Utility for multiple upgrades

After downloading the Upgrade Utility, double click on the .exe file to run the utility (which ONLY works with IPv4) and follow these steps to upgrade your ATS firmware:

1. Type in an IP address, a user name, and a password, and choose the **Ping** button if you need to verify an IP address.
2. Choose the **Device List** button to open the *iplist.txt* file. This should list any device IP, user name, and password. For example,
SystemIP=192.168.0.1
SystemUserName=apc
SystemPassword=apc
You can use an existing *iplist.txt* file if it already exists.
3. Select the **Upgrade From Device List** check box to use the *iplist.txt* file.
4. Choose the **Upgrade Now** button to start the firmware version update(s).
5. Choose **View Log** to verify any upgrade.

Verifying Upgrades and Updates

Verify the success or failure of the transfer

To verify whether a firmware upgrade succeeded, use the `xferStatus` command in the CLI to view the last transfer result, or use an SNMP GET to the `mfiletransferStatusLastTransferResult` OID.

Last Transfer Result codes

Possible transfer errors include the TFTP or FTP server not being found, or the server refusing access, the server not finding or not recognizing the transfer file, or a corrupt transfer file.

Code	Description
Successful	The file transfer was successful.
Result not available	There are no recorded file transfers.
Failure unknown	The last file transfer failed for an unknown reason.
Server inaccessible	The TFTP or FTP server could not be found on the network.
Server access denied	The TFTP or FTP server denied access.
File not found	The TFTP or FTP server could not locate the requested file.
File type unknown	The file was downloaded but the contents were not recognized.
File corrupt	The file was downloaded but at least one Cyclical Redundancy Check (CRC) failed.

Verify the version numbers of installed firmware

Path: **About > Network**

Use the Web UI to verify the versions of the upgraded firmware modules. You could also use an SNMP GET to the MIB II `sysDescr` OID. In the CLI, use the `about` command.

Troubleshooting

Rack ATS Access Problems

For problems that persist or are not described here, contact the APC by Schneider Electric Customer Care at www.apc.com.

Problem	Solution
Unable to ping the ATS	<p>If the ATS's Status LED is green, try to ping another node on the same network segment as the ATS. If that fails, it is not a problem with the Rack ATS. If the Status LED is not green, or if the ping test succeeds, perform the following checks:</p> <ul style="list-style-type: none">• Verify all network connections.• Verify the IP addresses of the Rack ATS and the NMS.• If the NMS is on a different physical network (or subnetwork) from the Rack ATS, verify the IP address of the default gateway (or router).• Verify the number of subnet bits for the Rack ATS's subnet mask.
Cannot allocate the communications port through a terminal program	<p>Before you can use a terminal program to configure the Rack ATS, you must shut down any application, service, or program using the communications port.</p>
Cannot access the CLI through a serial connection	<p>Make sure that you did not change the baud rate. Try 2400, 9600, 19200, or 38400.</p>
Cannot access the CLI remotely	<ul style="list-style-type: none">• Make sure you are using the correct access method, Telnet or Secure Shell (SSH). The Super User or an Administrator can enable these access methods. By default, Telnet is disabled, and SSH is enabled. SSH and Telnet can be enabled/disabled independently.• For SSH, the Rack ATS may be creating a host key. The Rack ATS can take up to one minute to create the host key, and SSH is inaccessible for that time.
Cannot access the Web UI	<ul style="list-style-type: none">• Verify that HTTP or HTTPS access is enabled.• Make sure you are specifying the correct URL — one that is consistent with the security system used by the Rack ATS. This requires https, not http, at the beginning of the URL.• Verify that you can ping the Rack ATS.• Verify that you are using a Web browser supported for the Rack ATS. See "Web User Interface" on page 73.• If the Rack ATS has just restarted and SSL/TLS security is being set up, the Rack ATS may be generating a server certificate. The Rack ATS can take up to one minute to create this certificate, and the SSL/TLS server is not available during that time.

SNMP Issues

Problem	Solution
Unable to perform a GET	<ul style="list-style-type: none"> • Verify the read (GET) community name (SNMPv1) or the user profile configuration (SNMPv3). • Use the CLI or Web UI to confirm that the NMS has access. See “SNMP options” on page 105
Unable to perform a SET	<ul style="list-style-type: none"> • Verify that SNMP is enabled. SNMPv1 and SNMPv3 are disabled by default. • Verify the read/write (SET) community name (SNMPv1) or the user profile configuration (SNMPv3). • Use the CLI or Web UI to confirm that the NMS has write (SET) access (SNMPv1) or is granted access to the target IP address through the access control list (SNMPv3). See “SNMP options” on page 105.
Unable to receive traps at the NMS	<ul style="list-style-type: none"> • Make sure the trap type (SNMPv1 or SNMPv3) is correctly configured for the NMS as a trap receiver. • For SNMP v1, query the mconfigTrapReceiverTable MIB OID to verify that the NMS IP address is listed correctly and that the community name defined for the NMS matches the community name in the table. If either is not correct, use SETs to the mconfigTrapReceiverTable OIDs, or use the CLI or Web UI to correct the trap receiver definition. • For SNMPv3, check the user profile configuration for the NMS, and run a trap test. See “SNMP options” on page 105, “Configure Notifications” on page 109, and “SNMP traps” on page 114.
Traps received at an NMS are not identified	See your NMS documentation to verify that the traps are properly integrated in the alarm/trap database.

Source Code Copyright Notice

cryptlib copyright Digital Data Security New Zealand Ltd 1998.

Copyright © 1990, 1993, 1994 The Regents of the University of California. All rights reserved.

This code is derived from software contributed to Berkeley by Mike Olson.

Redistribution and use in source and binary forms, with or without modification, are permitted provided that the following conditions are met:

1. Redistributions of source code must retain the above copyright notice, this list of conditions and the following disclaimer.
2. Redistributions in binary form must reproduce the above copyright notice, this list of conditions and the following disclaimer in the documentation and/or other materials provided with the distribution.
3. All advertising materials mentioning features or use of this software must display the following acknowledgment: This product includes software developed by the University of California, Berkeley and its contributors.
4. Neither the name of the University nor the names of its contributors may be used to endorse or promote products derived from this software without specific prior written permission.

THIS SOFTWARE IS PROVIDED BY THE REGENTS AND CONTRIBUTORS "AS IS" AND ANY EXPRESS OR IMPLIED WARRANTIES, INCLUDING, BUT NOT LIMITED TO, THE IMPLIED WARRANTIES OF MERCHANTABILITY AND FITNESS FOR A PARTICULAR PURPOSE ARE DISCLAIMED. IN NO EVENT SHALL THE REGENTS OR CONTRIBUTORS BE LIABLE FOR ANY DIRECT, INDIRECT, INCIDENTAL, SPECIAL, EXEMPLARY, OR CONSEQUENTIAL DAMAGES (INCLUDING, BUT NOT LIMITED TO, PROCUREMENT OF SUBSTITUTE GOODS OR SERVICES; LOSS OF USE, DATA, OR PROFITS; OR BUSINESS INTERRUPTION) HOWEVER CAUSED AND ON ANY THEORY OF LIABILITY, WHETHER IN CONTRACT, STRICT LIABILITY, OR TORT (INCLUDING NEGLIGENCE OR OTHERWISE) ARISING IN ANY WAY OUT OF THE USE OF THIS SOFTWARE, EVEN IF ADVISED OF THE POSSIBILITY OF SUCH DAMAGE.

Worldwide Customer Support

Customer support is available at www.apc.com.

© 2020 APC by Schneider Electric. APC, PowerNet, and StruxureWare are trademarks owned by Schneider Electric, S.E. All other trademarks may be property of their respective owners.