

WF-4740 User's Guide

Contents

WF-4740 Series User's Guide	13
Product Basics	14
Using the Control Panel	14
Control Panel Buttons and Lights	15
Status Icon Information	15
Selecting the Date and Time	16
Entering Characters on the LCD Screen	19
Using Presets	19
Changing LCD Screen Language	22
Adjusting Control Panel Sounds	22
Adjusting the Screen Brightness	23
Turning Off the Operation Time Out Setting	24
Preventing PC Connection via USB	25
Product Parts Locations	26
Product Parts - Front	27
Product Parts - Inside	29
Product Parts - Back	31
Checking for Software Updates	31
Using Power Saving Settings	32
Changing the Sleep Timer Settings	32
Changing the Power Off Timer Settings	34
Epson Connect Solutions for Smartphones, Tablets, and More	34
Setting Up Epson Connect Services	35
Using Epson Email Print	36
Using the Epson iPrint Mobile App	37
Using Epson Remote Print	37
Using Epson Scan to Cloud	38
Using AirPrint	39
Using Google Cloud Print	39
Android Printing Using the Epson Print Enabler	40

Using Fire OS Printing	41
Using Windows 10 Mobile Printing	41
Using Epson Print and Scan App with Windows Tablets	42
Printing and Scanning with NFC from Your Android Device	42
Wi-Fi or Wired Networking.....	45
Wi-Fi Infrastructure Mode Setup.....	45
Selecting Wireless Network Settings from the Control Panel	46
Wi-Fi Direct Mode Setup	48
Enabling Wi-Fi Direct Mode	49
Wi-Fi Protected Setup (WPS).....	50
Using WPS to Connect to a Network	51
Printing a Network Status Sheet.....	52
Configuring Email Server Settings.....	53
Changing or Updating Network Connections	54
Accessing the Web Config Utility	55
Changing a USB Connection to a Wi-Fi Connection.....	55
Changing a Wi-Fi Connection to a Wired Network Connection.....	55
Connecting to a New Wi-Fi Router	56
Disabling Wi-Fi Features	56
Loading Paper	58
Loading Paper in the Cassette	58
Paper Loading Capacity	64
Double-sided Printing Capacity	65
Borderless Paper Type Compatibility	66
Available Epson Papers	67
Paper or Media Type Settings - Printing Software.....	68
Selecting the Paper Settings for Each Source - Control Panel	69
Paper Type Settings - Control Panel	70
Selecting the Default Paper Source Settings.....	71
Paper Source Settings Options	72
Selecting the Universal Print Settings	72
Universal Print Settings Options	73

Placing Originals on the Product	75
Placing Originals on the Scanner Glass	75
Placing Originals in the Automatic Document Feeder	78
ADF Original Document Specifications.....	80
Copying	82
Copying Documents or Photos.....	82
Copying Options.....	83
Printing from a Computer	86
Printing with Windows	86
Selecting Basic Print Settings - Windows	86
Paper Source Options - Windows	89
Print Quality Options - Windows	89
Multi-Page Printing Options - Windows.....	89
Selecting Double-sided Printing Settings - Windows	90
Double-sided Printing Options - Windows.....	92
Print Density Adjustments - Windows	93
Selecting Additional Layout and Print Options - Windows	94
Custom Color Correction Options - Windows.....	96
Image Options and Additional Settings - Windows.....	97
Header/Footer Settings - Windows	98
Selecting a Printing Preset - Windows.....	99
Selecting Extended Settings - Windows	100
Extended Settings - Windows	101
Printing Your Document or Photo - Windows.....	102
Locking Printer Settings - Windows	103
Locked Setting Options.....	105
Selecting Default Print Settings - Windows.....	106
Changing the Language of the Printer Software Screens	107
Changing Automatic Update Options	108
Printing on a Mac	108
Selecting Basic Print Settings - Mac	109
Paper Source Options - Mac.....	112
Print Quality Options - Mac	112

Print Options - Mac	113
Selecting Page Setup Settings - Mac	113
Selecting Print Layout Options - Mac.....	114
Selecting Double-sided Printing Settings - Mac.....	115
Double-sided Printing Options and Adjustments - Mac.....	116
Managing Color - Mac	117
Color Matching and Color Options - Mac	118
Selecting Printing Preferences - Mac	119
Printing Preferences - Mac.....	120
Printing Your Document or Photo - Mac	121
Checking Print Status - Mac.....	122
Printing From a Chromebook	122
Cancelling Printing Using the Product	123
Scanning	124
Starting a Scan.....	124
Starting a Scan Using the Product Control Panel	124
Scanning to Email	126
Scanning to a Network Folder or FTP Server.....	128
Adding and Assigning Scan Jobs with Document Capture Pro or Document Capture	130
Control Panel Scanning Options	131
Starting a Scan Using the Epson Scan 2 Icon	134
Starting a Scan from a Scanning Program.....	136
Starting a Scan from a Smart Device.....	138
Scanning with Document Capture Pro or Document Capture	138
Scanning in Epson Scan 2	141
Additional Scanning Settings - Main Settings Tab	144
Additional Scanning Settings - Advanced Settings Tab.....	144
Saving Scanned Documents as a Searchable PDF.....	145
Image Format Options	146
Scan Resolution Guidelines	147
Scanning Special Projects.....	148
Scanning to a SharePoint Server or Cloud Service	148
Scanning Multi-Page Originals as Separate Files.....	150

Creating Contacts for Scanning	152
Faxing.....	154
Connecting a Telephone or Answering Machine	154
Setting Up Fax Features	157
Setting Up Basic Fax Features	158
Using the Fax Setup Wizard	158
Selecting the Line Type.....	160
Setting the Number of Rings to Answer	161
Selecting Advanced Fax Settings.....	163
Print Settings - Fax.....	164
Basic Settings - Fax	165
Security Settings - Fax	167
Setting Up the Fax Utility - Windows.....	167
Setting Up Fax Features Using the Fax Utility - Mac	169
Setting Up Contacts and Contact Groups.....	170
Setting Up Contacts Using the Product Control Panel	171
Creating a Contact	171
Editing or Deleting a Contact	173
Creating a Contact Group	174
Editing or Deleting a Contact Group.....	176
Importing Contacts Using the Fax Utility - Windows	177
Setting Up Speed/Group Dial Lists Using the Fax Utility - Mac.....	180
Sending Faxes	182
Sending Faxes from the Product Control Panel.....	182
Sending a Fax Using the Keypad, Contact List, or History	182
Fax Sending Options	185
Sending a Fax at a Specified Time	186
Sending Faxes Using the Fax Utility - Windows	187
Sending Faxes Using the Fax Utility - Mac	190
Receiving Faxes.....	193
Fax Reception	193
Receiving Faxes Automatically	194
Receiving Faxes Manually.....	194

Receiving a Fax by Polling	195
Viewing a Fax on the LCD Screen (Using the Inbox).....	196
Saving Faxes to a USB Memory Device	198
Selecting Received Fax Options Using the Fax Utility - Windows	198
Checking Fax Status	201
Printing Fax Reports.....	202
Fax Report Options	202
Using External USB Devices with Your Product.....	204
Connecting a USB Device	204
USB Device Photo File Specifications	204
Disconnecting a USB Device.....	205
Viewing and Printing from the LCD Screen	205
Printing JPEG Photos.....	205
Printing TIFF Files	206
Print Setting Options - Device Mode.....	207
Transferring Files on a USB Device	208
Setting Up File Sharing for File Transfers from Your Computer.....	209
Transferring Files from a USB Device to Your Computer	210
Replacing Ink Cartridges and Maintenance Boxes.....	212
Check Cartridge and Maintenance Box Status.....	212
Checking Cartridge Status on the LCD Screen.....	212
Checking Cartridge and Maintenance Box Status with Windows	213
Checking Cartridge and Maintenance Box Status - Mac	216
Purchase Epson Ink Cartridges and Maintenance Box	217
Ink Cartridge and Maintenance Box Part Numbers.....	217
Removing and Installing Ink Cartridges.....	217
Printing with Black Ink and Expended Color Cartridges	223
Printing with Expended Color Cartridges - Windows	223
Printing with Expended Color Cartridges - Mac	224
Conserving Low Black Ink with Windows	225
Replacing the Maintenance Box.....	226
Adjusting Print Quality.....	229
Print Head Maintenance.....	229

Print Head Nozzle Check.....	229
Checking the Nozzles Using the Product Control Panel	229
Checking the Nozzles Using a Computer Utility	231
Print Head Cleaning	233
Cleaning the Print Head Using the Product Control Panel	234
Cleaning the Print Head Using a Computer Utility.....	235
Aligning the Print Head Using the Product Control Panel	237
Cleaning the Paper Guide	239
Cleaning and Transporting Your Product	241
Cleaning Your Product	241
Transporting Your Product	245
Solving Problems	248
Product Status Messages	248
Running a Product Check	250
Resetting Control Panel Defaults	251
Solving Setup Problems	252
Product Does Not Turn On or Off.....	253
Noise After Ink Installation	253
Software Installation Problems	253
Solving Network Problems	254
Product Cannot Connect to a Wireless Router or Access Point	254
Network Software Cannot Find Product on a Network.....	255
Product Does Not Appear in Mac Printer Window	256
Cannot Print Over a Network.....	257
Cannot Scan Over a Network	258
Solving Copying Problems	259
Product Makes Noise, But Nothing Copies.....	259
Product Makes Noise When It Sits for a While.....	260
Originals Do Not Feed From the Automatic Document Feeder.....	260
Solving Paper Problems	261
Paper Feeding Problems	262
Paper Jam Problems in the Cassette	262
Paper Jam Problems in the Rear Cover	264

Document Jams in the Automatic Document Feeder	265
Paper Ejection Problems	268
Solving Problems Printing from a Computer.....	268
Nothing Prints	269
Product Icon Does Not Appear in Windows Taskbar	269
Printing is Slow	270
Solving Page Layout and Content Problems	271
Inverted Image.....	272
Too Many Copies Print	272
Blank Pages Print	272
Incorrect Margins on Printout.....	273
Incorrect Characters Print.....	273
Incorrect Image Size or Position	273
Slanted Printout	274
Solving Print Quality Problems	274
White or Dark Lines in Printout	275
Blurry or Smearred Printout	276
Faint Printout or Printout Has Gaps	277
Grainy Printout.....	278
Incorrect Colors	279
Solving Scanning Problems	279
Scanning Software Does Not Operate Correctly	280
Cannot Start Epson Scan 2	280
Scanning is Slow	281
Solving Scanned Image Quality Problems	281
Image Consists of a Few Dots Only.....	282
Line of Dots Appears in All Scanned Images.....	282
Straight Lines in an Image Appear Crooked	282
Image is Distorted or Blurry	283
Image Colors are Patchy at the Edges	283
Image is Too Dark	283
Back of Original Image Appears in Scanned Image	284
Ripple Patterns Appear in an Image	284

Scanned Image Colors Do Not Match Original Colors	284
Scanned Image Edges are Cropped	285
Solving Faxing Problems.....	285
Cannot Send or Receive Faxes.....	285
Cannot Receive Faxes with a Telephone Connected to Your Product	287
Fax Memory Full Error Appears.....	287
Sent Fax Quality is Poor	288
Sent Fax is Received in an Incorrect Size	288
Received Fax Quality is Poor	289
Received Fax is Not Printed	289
Solving USB Device Problems	289
Cannot View or Print from a USB Device.....	290
Cannot Save Files on a USB Device	290
Cannot Transfer Files To or From a USB Device.....	291
Uninstall Your Product Software.....	291
Uninstalling Product Software - Windows.....	291
Uninstalling Product Software - Mac.....	293
Where to Get Help.....	293
Technical Specifications	295
Windows System Requirements	295
Mac System Requirements	296
Paper Specifications	296
Printable Area Specifications	297
Scanning Specifications	299
Fax Specifications	300
Ink Cartridge Specifications.....	301
Dimension Specifications	301
Electrical Specifications	302
Environmental Specifications	302
Interface Specifications	303
External USB Device Specifications.....	303
Network Interface Specifications	303
Safety and Approvals Specifications	304

Notices	306
Important Safety Instructions.....	306
General Product Safety Instructions	306
Ink Cartridge Safety Instructions.....	308
LCD Screen Safety Instructions.....	309
Wireless Connection Safety Instructions	309
Telephone Equipment Safety Instructions	310
FCC Compliance Statement.....	310
Binding Arbitration and Class Waiver	313
Trademarks	316
Copyright Notice.....	316
libTIFF Software Acknowledgment.....	317
A Note Concerning Responsible Use of Copyrighted Materials.....	318
Default Delay Times for Power Management for Epson Products	318
Copyright Attribution	318

WF-4740 Series User's Guide

Welcome to the WF-4740 Series *User's Guide*.

For a printable PDF copy of this guide, [click here](#).

Product Basics

See these sections to learn about the basic features of your product.

[Using the Control Panel](#)

[Product Parts Locations](#)

[Checking for Software Updates](#)

[Using Power Saving Settings](#)

[Epson Connect Solutions for Smartphones, Tablets, and More](#)

[Using AirPrint](#)

[Using Google Cloud Print](#)

[Android Printing Using the Epson Print Enabler](#)

[Using Fire OS Printing](#)

[Using Windows 10 Mobile Printing](#)

[Using Epson Print and Scan App with Windows Tablets](#)

[Printing and Scanning with NFC from Your Android Device](#)

Using the Control Panel

See these sections to learn about the control panel and select control panel settings.

[Control Panel Buttons and Lights](#)

[Selecting the Date and Time](#)

[Entering Characters on the LCD Screen](#)

[Using Presets](#)

[Changing LCD Screen Language](#)

[Adjusting Control Panel Sounds](#)

[Adjusting the Screen Brightness](#)





[Turning Off the Operation Time Out Setting](#)

[Preventing PC Connection via USB](#)

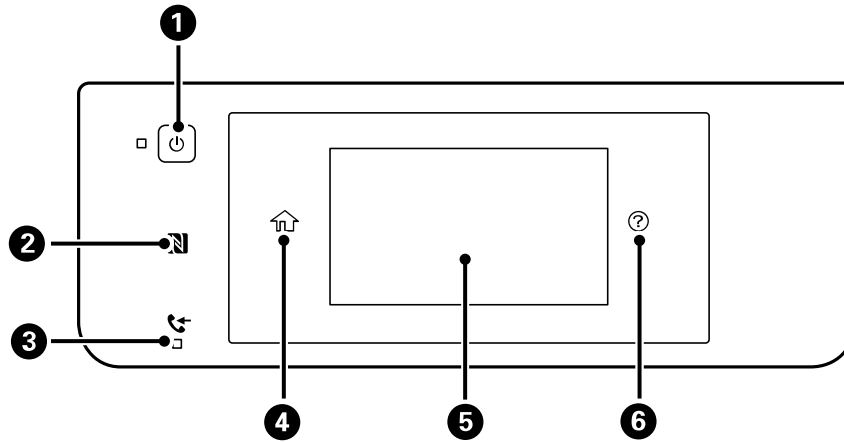
Parent topic: [Product Basics](#)

Control Panel Buttons and Lights





- 1 The  power button and light
- 2 The NFC (Near Field Communication) tag
- 3 The  received fax light
- 4 The  home button
- 5 The LCD screen
- 6 The  help button













Status Icon Information

Parent topic: [Using the Control Panel](#)

Status Icon Information

Your product displays status icons on the LCD screen for certain product status conditions. Press the   icon to view or change the current network settings.

Icons	Description
	Displays additional information or instructions, such as loading paper or placing a document.

Icons	Description
	Displays the Supply Status screen.
	Quiet Mode is enabled. Noise is reduced during printing, but the print speed may be reduced. Press this icon to change the settings.
	Quiet Mode is disabled. Press this icon to change the settings.
	Displays the Fax Data Information screen.
	The indicated setting has changed.
	There is a problem with the indicated setting. Press the icon to resolve the problem.
	No Ethernet connection.
	An Ethernet connection is established.
	No Wi-Fi connection.
	A Wi-Fi network error has occurred or the product is searching for a connection.
	A Wi-Fi connection is established. The number of bars indicates the connection's signal strength.
	No Wi-Fi Direct connection.
	A Wi-Fi Direct connection is established.

Parent topic: [Control Panel Buttons and Lights](#)

Selecting the Date and Time

Before faxing, select the current date, time, and daylight saving phase in your area, and choose your preferred date and time format.

1. Press the  home button, if necessary.
2. Select **Settings**.

3. Select **General Settings**.



4. Select **Basic Settings**.



5. Select **Date/Time Settings**.

You see a screen like this:

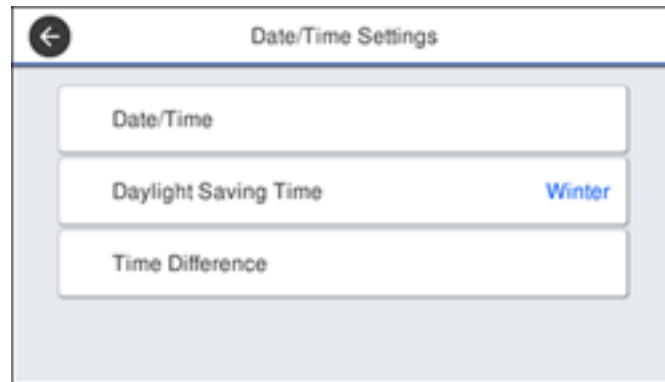

6. Select **Daylight Saving Time**.
7. Select the setting that applies to your area:
 - **Winter**: it is winter or your region does not use Daylight Saving Time (DST)
 - **Summer**: it is spring or summer and your region uses Daylight Saving Time (DST)

Note: If your region uses Daylight Saving Time (DST), you must change this setting to match the season. When you change from **Winter** to **Summer**, your product automatically sets its clock ahead one hour. When you change from **Summer** to **Winter**, it sets its clock back one hour.



8. Select **Date/Time**.
9. Select the date format you want to use.
10. Use the numeric keypad to enter the current date.
11. Select the time format you want to use.
12. Use the numeric keypad to enter the current time.

Parent topic: [Using the Control Panel](#)

Entering Characters on the LCD Screen

Follow these guidelines to enter characters for passwords and other settings.



- To move the cursor, select the left or right arrows.
- To change the case of letters, select .
- To delete the previous character, select .
- To enter numbers or symbols, select .
- To enter a space, select **Space**.

Parent topic: [Using the Control Panel](#)

Using Presets

You can save frequently used copy, fax, and scan settings as presets. This lets you easily reuse them whenever necessary.

1. Press the  home button, if necessary.
2. Select **Presets**.

You see a screen like this:

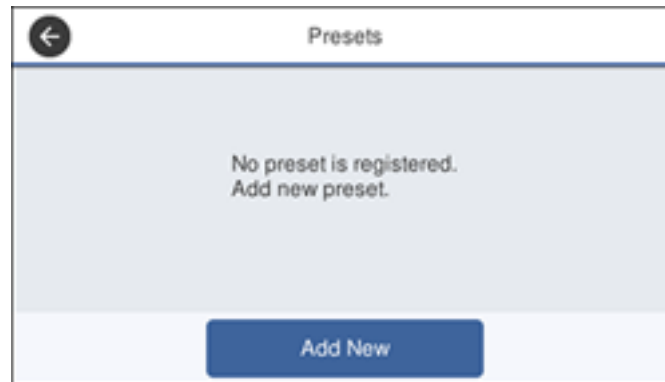

3. Select **Add New**.
4. Select the function for which you want to set up a preset.

You see the main screen for that function, such as the Copy screen:

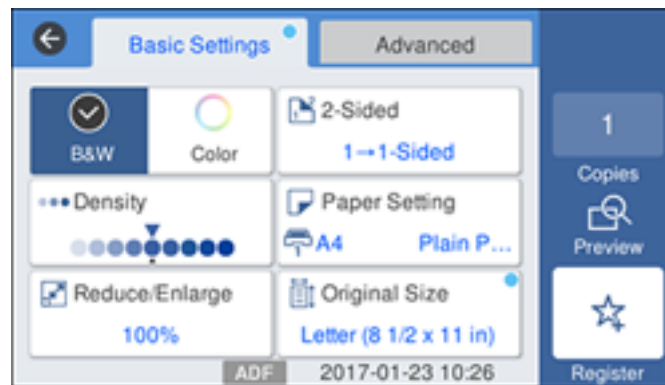

5. Select the settings you want to save and select **Register**.

You see a screen like this:



6. Select **Name**.

You see a screen like this:



7. Use the displayed keyboard to enter a name for the preset and select **OK**.

8. Select **OK**.

When you copy, fax, or scan, you can use the preset by selecting **Presets** and selecting your preset name from the list.

Parent topic: [Using the Control Panel](#)

Related tasks

[Entering Characters on the LCD Screen](#)

Changing LCD Screen Language

You can change the language used on the LCD screen.

1. Press the  home button, if necessary.
2. Select **Settings**.
3. Select **General Settings**.

You see a screen like this:



4. Select **Basic Settings**.
5. Scroll down and select **Language**.
6. Select a language.

Parent topic: [Using the Control Panel](#)

Adjusting Control Panel Sounds

You can adjust the sound level heard when you press buttons on the control panel.



1. Press the  home button, if necessary.
2. Select **Settings**.
3. Select **General Settings**.

You see a screen like this:



4. Select **Basic Settings**.
5. Select **Sound**.
6. Select **Normal Mode** or **Quiet Mode**.

Note: Press the  icon on the home screen to switch between Normal Mode and Quiet Mode.

7. Select **Button Press**.
8. Press  to decrease or  to increase the sound.
9. Select **OK** to exit.

Note: You can also adjust the **Sound Type** and the sound level for various product functions.

Parent topic: [Using the Control Panel](#)

Adjusting the Screen Brightness

You can adjust the brightness of the LCD screen.

1. Press the  home button, if necessary.
2. Select **Settings**.
3. Select **General Settings**.

You see a screen like this:



4. Select **Basic Settings**.
5. Select **LCD Brightness**.
6. Do one of the following:
 - Press the – or + icons to decrease or increase the brightness.
 - Press the brightness level on the LCD screen, select a number from the on-screen keypad, and press **OK**.
7. Select **OK** to exit.

Parent topic: [Using the Control Panel](#)

Turning Off the Operation Time Out Setting

The Operation Time Out setting causes the LCD screen to return to the Home screen after a few minutes of inactivity. This feature is enabled by default, but you can turn it off.

1. Press the  home button, if necessary.
2. Select **Settings**.
3. Select **General Settings**.

You see a screen like this:



4. Select **Basic Settings**.
5. Scroll down and set **Operation Time Out** to **Off**.

Parent topic: [Using the Control Panel](#)

Preventing PC Connection via USB

You can disable access from a USB-connected computer. This restricts non-network access to the product and protects the security of confidential scanned documents.

1. Press the  home button, if necessary.
2. Select **Settings**.
3. Select **General Settings**.

You see a screen like this:



4. Select **Printer Settings**.

You see a screen like this:

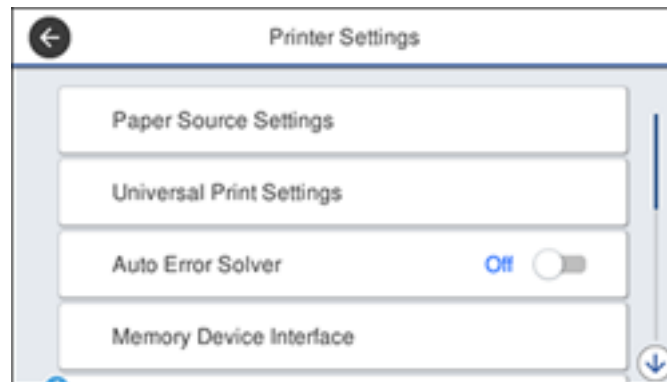

5. Scroll down and select **PC Connection via USB**.
6. Select **Disable**.

Parent topic: [Using the Control Panel](#)

Product Parts Locations

See these sections to identify the parts on your product.

[Product Parts - Front](#)

[Product Parts - Inside](#)

[Product Parts - Back](#)

Parent topic: [Product Basics](#)

Product Parts - Front

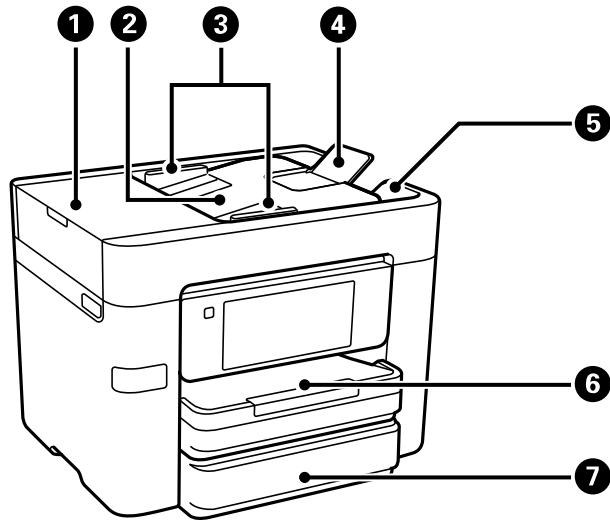

- 1 Automatic Document Feeder (ADF) cover
- 2 ADF input tray
- 3 ADF edge guides
- 4 ADF document support
- 5 ADF output tray
- 6 Paper cassette 1

7 Paper cassette 2

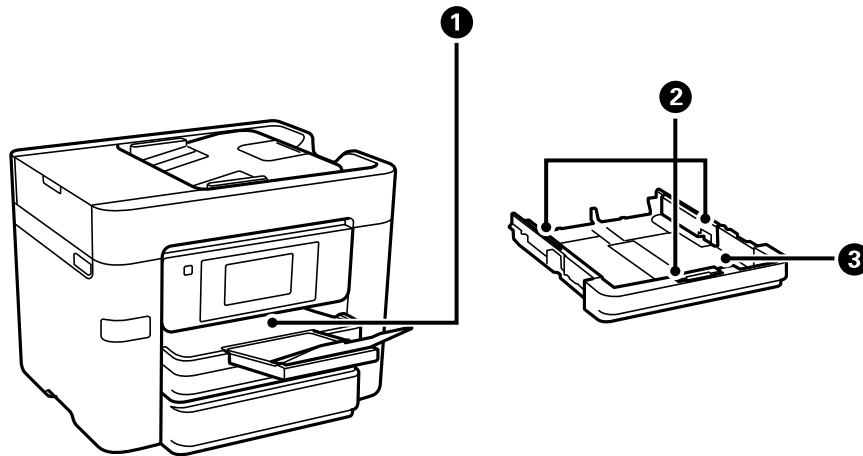

- 1 Output tray
- 2 Paper cassette edge guides
- 3 Paper cassette

Parent topic: [Product Parts Locations](#)

Product Parts - Inside

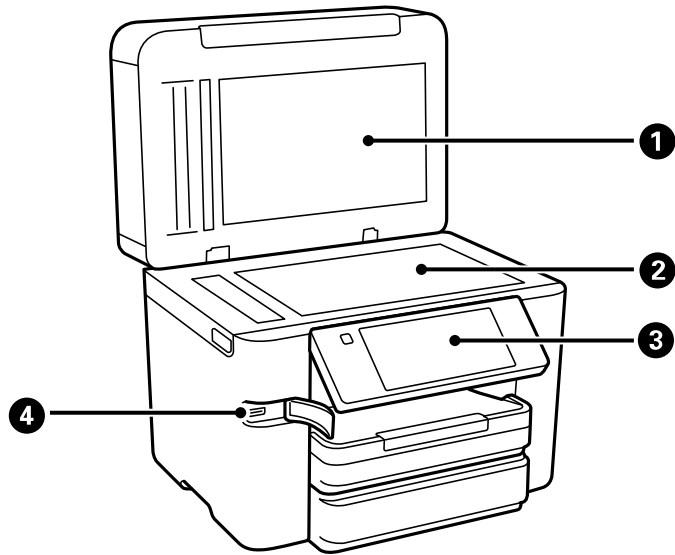

- 1 Document cover
- 2 Scanner glass
- 3 Control panel

4 USB Type A port for external devices

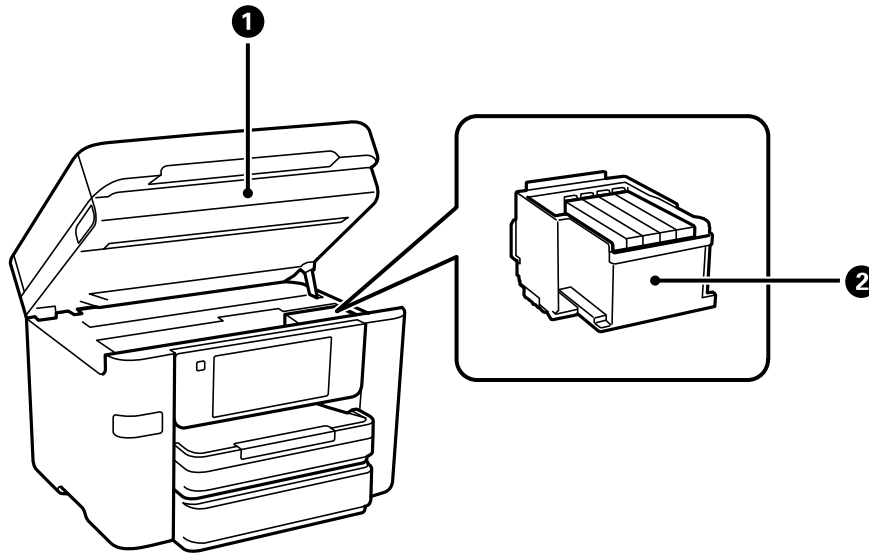

- 1 Scanner unit
- 2 Ink cartridge holder (do not remove)

Parent topic: [Product Parts Locations](#)

Product Parts - Back

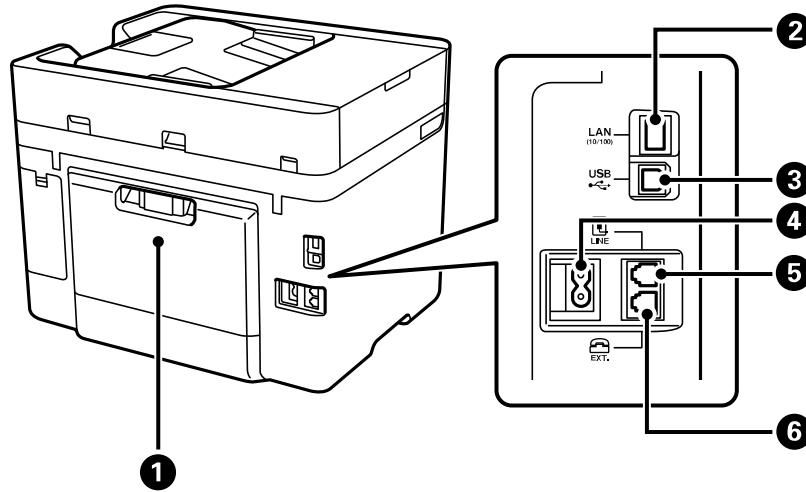

- 1 Rear cover
- 2 **LAN** port
- 3 **USB** port
- 4 AC inlet
- 5 **LINE** port
- 6 **EXT** port

Parent topic: [Product Parts Locations](#)

Checking for Software Updates

Periodically, it's a good idea to check Epson's support website for free updates to your product software. Visit epson.com/support (U.S.), epson.ca/support (Canada), or epson.com.jm/support (Caribbean) and select your product.

- **Windows:** Your printer software automatically checks for updates. You can also manually update the software by selecting **Software Update** here:
 - Accessing the Windows Desktop and right-clicking the product icon in the Windows taskbar

- On the **Maintenance** tab in the printer settings window

You can also update the software by selecting **EPSON Software Updater** in the **EPSON** or **EPSON Software** program group, accessible by the **Start** button, or on the **Start** or **Apps** screens, depending on your version of Windows.

- **OS X:** You can manually update the software by opening the **Applications > Epson Software** folder and selecting **EPSON Software Updater**.
- **macOS 10.12.x:** You can manually update the software by opening the **App Store**, selecting **Updates**, searching for a software update option for Epson Software, and selecting **Update**.

Parent topic: [Product Basics](#)

Using Power Saving Settings

Your product enters sleep mode automatically and turns off the LCD screen if it is not used for a period of time. You can make the time period shorter and select other options to save energy and resources.

[Changing the Sleep Timer Settings](#)

[Changing the Power Off Timer Settings](#)

Parent topic: [Product Basics](#)

Changing the Sleep Timer Settings

You can adjust the time period before your product enters sleep mode and turns off the LCD screen.

1. Press the  home button, if necessary.
2. Select **Settings**.
3. Select **General Settings**.

You see a screen like this:



4. Select **Basic Settings**.

5. Select **Sleep Timer**.

You see a screen like this:

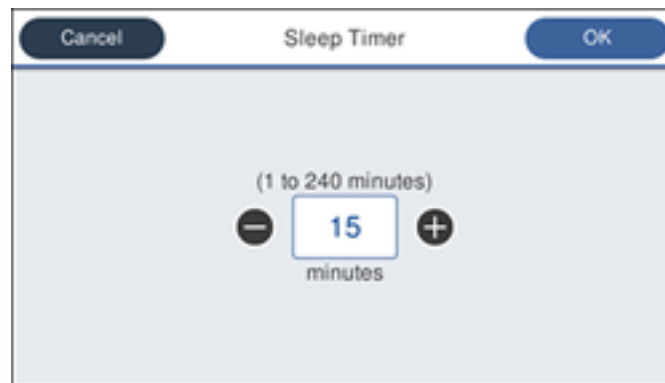

6. Do one of the following:

- Press the – or + icon to decrease or increase the number of minutes.
- Press the number of minutes on the LCD screen, select the number of minutes from the on-screen keypad, and press **OK**.

7. Select **OK**.

Parent topic: [Using Power Saving Settings](#)

Changing the Power Off Timer Settings

You can have the product turn off automatically if it is not used for a specified period of time.

1. Press the  home button, if necessary.
2. Select **Settings**.
3. Select **General Settings**.

You see a screen like this:



4. Select **Basic Settings**.
5. Select **Power Off Timer**, then select a time period between **30minutes** and **12h** (12 hours).

Parent topic: [Using Power Saving Settings](#)

Epson Connect Solutions for Smartphones, Tablets, and More

Use your smartphone, tablet, or computer to print and scan documents, photos, emails, and web pages from your home, office, or even across the globe.

Print from anywhere with these Epson Connect solutions:

- Epson Email Print
- Epson iPrint Mobile App

- Epson Remote Print

Scan and send a file as an email or upload it to an online service directly from your Epson product with Epson Scan to Cloud or the Epson iPrint Mobile App.

[Setting Up Epson Connect Services](#)

[Using Epson Email Print](#)

[Using the Epson iPrint Mobile App](#)

[Using Epson Remote Print](#)

[Using Epson Scan to Cloud](#)

Parent topic: [Product Basics](#)

Related topics

[Wi-Fi or Wired Networking](#)

Setting Up Epson Connect Services

If you did not activate your product's email address for use with Epson Connect when you set up your product, you can activate it using the product control panel.

1. Press the  home button, if necessary.
2. Select **Settings**.
3. Select **General Settings**.

You see a screen like this:



4. Select **Web Service Settings**.

5. Select **Epson Connect Services**.

You see a screen like this:

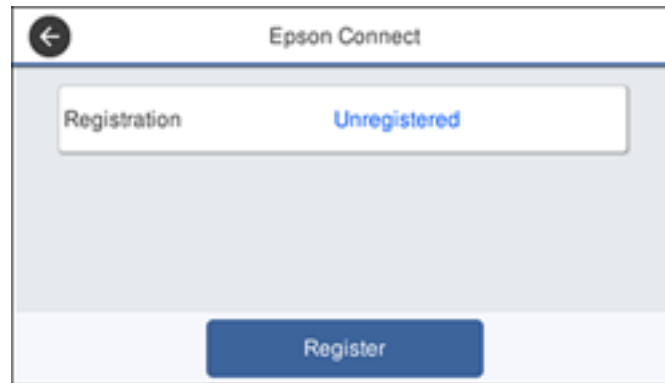

6. Select **Register**.
7. Follow the instructions on the screen to activate your product's email address.

Parent topic: [Epson Connect Solutions for Smartphones, Tablets, and More](#)

Related topics

[Wi-Fi or Wired Networking](#)

Using Epson Email Print

With Epson Email Print, you can print from any device that can send email, such as your smartphone, tablet, or laptop. Just activate your product's unique email address. When you want to print, attach a PDF, Microsoft Office document, or photo to an email and send it to your product. Both the email and the attachments will print automatically.

1. Connect your product to your network. See the link below.
2. If you did not already set up Email Print when you installed your product software, see the link below to use your product control panel to activate your unique email address. Or visit epson.com/connect (U.S), epson.ca/connect (Canada), or epsonconnect.com (Caribbean) to learn more about Email Print, create your Epson Connect account, and register your product to the Epson Connect service.
3. Now you are ready to send and print emails to your product's Email Print address.

Note: Go to epsonconnect.com and log into your Epson Connect account to personalize your product's email, adjust print settings, and set up other Epson Connect services.

Parent topic: [Epson Connect Solutions for Smartphones, Tablets, and More](#)

Related topics

[Wi-Fi or Wired Networking](#)

Using the Epson iPrint Mobile App

Use this free Apple and Android app to print and scan with networked Epson products. Epson iPrint lets you print PDFs, Microsoft Office documents, photos, and web pages over a wireless network. You can scan and save a file on your device, send it as an email, or upload it to an online service such as Box, Dropbox, Evernote, or Google Drive.

1. Connect your product to your wireless network. See the link below.
2. Visit epson.com/connect (U.S), epson.ca/connect (Canada), or epson.com.jm/connect (Caribbean) to learn more about Epson iPrint and check the compatibility of your mobile device.
3. Download Epson iPrint from the Apple App Store or Google Play.
4. Connect your mobile device to the same wireless network as your product.
5. Open Epson iPrint and select your Epson product.

Now you are ready to print or scan with your mobile device and your Epson product.

Parent topic: [Epson Connect Solutions for Smartphones, Tablets, and More](#)

Related topics

[Wi-Fi or Wired Networking](#)

Using Epson Remote Print

With Epson Remote Print software, you can print from your laptop or desktop computer to an Epson Email-enabled product anywhere in the world.

1. Connect your Epson product to your wireless network. See the link below.
2. If you did not already set up an Epson Connect account when you installed your product software, visit epsonconnect.com to create your account and register your product to the Epson Connect service.

Note: Make a note of your product's email address.

3. Visit epsonconnect.com to learn more about Remote Print and how to download the Remote Print Driver software.
4. Download and install the Remote Print software.
5. Enter the email address and optional access key of your Epson product during Remote Print setup.
6. Now you are ready to print remotely. Select the print command in your laptop or desktop computer application and choose the Remote Print option for your Epson product.

Parent topic: [Epson Connect Solutions for Smartphones, Tablets, and More](#)

Related topics

[Wi-Fi or Wired Networking](#)

Using Epson Scan to Cloud

The Epson Scan to Cloud service allows you to scan and send a file as an email or upload it to an online service directly from your Epson product. Register an email address or online services such as Box, DropBox, Evernote, or Google Drive with your Epson Connect account.

1. Connect your Epson product to your network. See the link below.
2. If you did not already set up an Epson Connect account when you installed your product software, visit epsonconnect.com to create your account and register your product to the Epson Connect service.

Note: Make a note of your product's email address and password.

3. Visit epsonconnect.com to sign into your account with the email address and password you selected.
4. Select your product, select **Scan to Cloud**, and select **Destination List**.
5. Click **Add**, then follow the instructions on the screen to create your destination list.
6. Now you are ready to use Scan to Cloud. Select the setting for scanning to Scan to Cloud on your Epson product control panel.

Parent topic: [Epson Connect Solutions for Smartphones, Tablets, and More](#)

Related topics

[Wi-Fi or Wired Networking](#)

Using AirPrint

AirPrint enables instant wireless printing from iPhone, iPad, and iPod touch with the latest version of iOS, and Mac with the latest version of OS X or macOS.

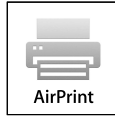

Note: If you disabled paper configuration messages on your product control panel, you cannot use AirPrint. See the link below to enable the messages, if necessary.

1. Load paper in your product.
2. Set up your product for wireless printing. See the link below.
3. Connect your Apple device to the same wireless network that your product is using.
4. Print from your device to your product.

Note: For details, see the AirPrint page on the Apple website.

Parent topic: [Product Basics](#)

Related references

[Paper Source Settings Options](#)

Related topics

[Wi-Fi or Wired Networking](#)

Using Google Cloud Print

With a Google Account, you can print from your Apple or Android device to your Epson product. You can also print from Chromebooks and the Google Chrome browser without drivers or cables.

1. Connect your Epson product to your wireless network. See the link below.
2. Note your product's IP address by checking your network status. See the link below.
3. Connect your computer or your Apple or Android device to the same wireless network as your Epson product.
4. Enter your product's IP address into the address bar of a web browser.

5. Select the **Google Cloud Print Services** option.

Note: If you don't see the **Google Cloud Print Services** option, turn your product off and back on. If the option still doesn't appear, select the **Firmware Update** option and follow the on-screen instructions to update your product.

6. Click **Register**.
7. Select the checkbox to agree to the Usage Advisory and click **Next**.
8. Click **OK** to launch the sign-in page.
A separate browser window opens.
9. Enter your Google Account username and password and click **Sign in**, or, if you don't have an account, click **Sign up for a new Google Account** and follow the on-screen instructions.
10. Click **Finish printer registration** to complete setup and print a test page.

Your product is now linked to your Google Account and can be accessed from any Chromebook, computer, Apple or Android device with Internet access. Visit [Epson Support for Google Cloud Print \(U.S\)](#) or [Epson Support for Google Cloud Print \(Canada\)](#) for more information on using Google Cloud Print, or the [Google Cloud Print](#) website for a list of [supported apps](#).

Parent topic: [Product Basics](#)

Related tasks

[Printing From a Chromebook](#)

Related topics

[Wi-Fi or Wired Networking](#)

Android Printing Using the Epson Print Enabler

You can wirelessly print your documents, emails, photos, and web pages right from your Android phone or tablet (Android v4.4 or later). With a few taps, your Android device will discover your nearby Epson product and print.

1. Connect your Epson product to your wireless network. See the link below.
2. On your Android device, download the Epson Print Enabler plug-in from Google Play.
3. Go to **Settings** on your Android device, select **Printing**, and enable the Epson plug-in.
4. Connect your Android device to the same wireless network as your product.

5. Now you are ready to print. From an Android application such as Chrome or Gmail, tap the menu icon and print whatever is on the screen.

Note: If you do not see your product, tap **All Printers** and select your product.

Parent topic: [Product Basics](#)

Related topics

[Wi-Fi or Wired Networking](#)

Using Fire OS Printing

You can wirelessly print from Amazon Fire tablets and phones to your nearby networked Epson product. There is no software to download, no drivers to install, and no cables to connect. With just a few taps in Email, Calendar, Contacts, and WPS Office, you can send whatever is on the screen to an Epson product.

1. Connect your Epson product to your wireless network. See the link below.
2. Connect your Amazon device to the same wireless network as your product.
3. Now you are ready to print. From your Amazon application, tap the print option and select your product to print whatever is on the screen.

Note: If you see a message telling you that a plug-in is required, tap **OK** and tap **Download**. If your Amazon Fire product uses Fire OS 5 and above, your device automatically uses the built-in Mopria Print Service app to print.

Visit epson.com/connect (U.S), epson.ca/connect (Canada), or epson.com.jm/connect (Caribbean) to learn more about Fire OS Printing (one of many Epson Connect Partner Solutions) and check the compatibility of your mobile device.

Parent topic: [Product Basics](#)

Related topics

[Wi-Fi or Wired Networking](#)

Using Windows 10 Mobile Printing

You can wirelessly print from Windows 10 Mobile tablets and phones to your nearby networked Epson product. There is no software to download, no drivers to install, and no cables to connect. Look for the print option in your Windows 10 application to send whatever is on the screen to an Epson product.

1. Connect your Epson product to your wireless network. See the link below.

2. Connect your Windows 10 Mobile device to the same wireless network as your product.
3. Now you are ready to print. From your Windows 10 application, tap the print option and select your product to print whatever is on the screen.

Visit epson.com/connect (U.S), epson.ca/connect (Canada), or epson.com.jm/connect (Caribbean) to learn more about Windows 10 Mobile Printing (one of many Epson Connect Partner Solutions) and check the compatibility of your mobile device.

Parent topic: [Product Basics](#)

Related topics

[Wi-Fi or Wired Networking](#)

Using Epson Print and Scan App with Windows Tablets

You can use this free app to print photos and scan from your Windows (Windows 8 or higher) Surface RT or Pro tablet with networked Epson products. Epson Print and Scan App allows you to scan and capture images right to your tablet or to Microsoft OneDrive.

Note: The Epson Print and Scan App does not support Windows 10 Mobile printing.

1. Connect your Epson product to your wireless network. See the link below.
2. Download Epson Print and Scan App from the Microsoft Windows Store.
3. Connect your Windows tablet to the same wireless network as your product.
4. Open Epson Print and Scan App and select your Epson product.

Now you are ready to print photos or scan.

Visit epson.com/connect (U.S), epson.ca/connect (Canada), or epson.com.jm/connect (Caribbean) to learn more about Epson Print and Scan App.

Parent topic: [Product Basics](#)

Related topics

[Wi-Fi or Wired Networking](#)

Printing and Scanning with NFC from Your Android Device

You can easily connect your Android 4.0 or later device to your product using NFC (Near Field Communication). Once connected, you can print and scan using Epson iPrint.

1. Make sure Epson iPrint is installed on your mobile device.

2. Make sure Simple AP mode or Wi-Fi Direct is enabled on your product and that you are using the default Wi-Fi Direct password.

Note: NFC printing and scanning will not work if you changed the Wi-Fi Direct password from the default.

3. Do one of the following:
 - If you are going to print, make sure paper is loaded in the product.
 - If you are going to scan, place your original on the product for scanning.
4. Touch the NFC antenna of your mobile device to the NFC tag on your product.

Note: The location of your mobile device's NFC antenna varies. See your mobile device documentation for more details.

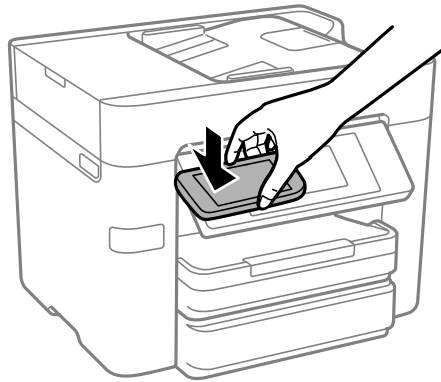

Epson iPrint opens on your device.

Note: If you do not have Epson iPrint installed, the app store page for the Epson iPrint app opens on your device. Install Epson iPrint and repeat this step.

5. Touch the NFC antenna of your mobile device to the product NFC tag on your product again.
The printer and mobile device connect.

Note: If the mobile device and product disconnect, try to print or scan a document. The mobile device and product should reconnect automatically.

6. If you are going to print, open the file you want to print in Epson iPrint.
7. Touch the NFC antenna of your mobile device to the NFC tag on your product to start printing or scanning.

Parent topic: [Product Basics](#)

Related topics

[Wi-Fi or Wired Networking](#)

Wi-Fi or Wired Networking

See these sections to use your product on a Wi-Fi or wired network.

[Wi-Fi Infrastructure Mode Setup](#)

[Wi-Fi Direct Mode Setup](#)

[Wi-Fi Protected Setup \(WPS\)](#)

[Printing a Network Status Sheet](#)

[Configuring Email Server Settings](#)

[Changing or Updating Network Connections](#)

Wi-Fi Infrastructure Mode Setup

You can set up your product to communicate with your computer using a wireless router or access point. The wireless router or access point can be connected to your computer over a wireless or wired network.

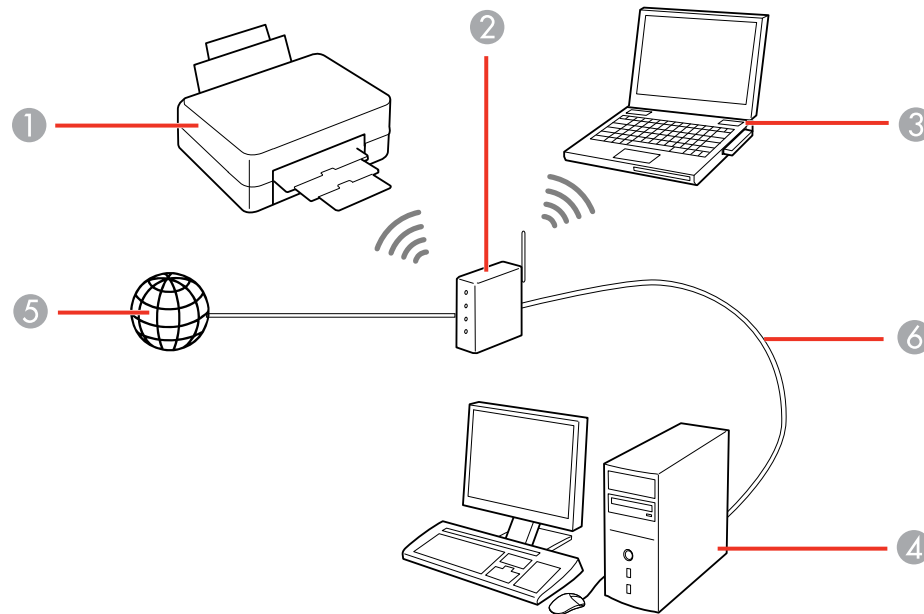

1 Epson product

- 2 Wireless router or access point
- 3 Computer with a wireless interface
- 4 Computer
- 5 Internet
- 6 Ethernet cable (used only for wired connection to the wireless router or access point)

Selecting Wireless Network Settings from the Control Panel



Parent topic: [Wi-Fi or Wired Networking](#)

Selecting Wireless Network Settings from the Control Panel

You can select or change wireless network settings using your product control panel.

To install your product on a wireless network, follow the instructions on the *Start Here* sheet and install the necessary software by downloading it from the Epson website. The installer program guides you through network setup.

Note: Breakdown or repair of this product may cause loss of fax and network data and settings. Epson is not responsible for backing up or recovering data and settings during or after the warranty period. We recommend that you make your own backup or print out your fax and network data and settings.

1. Press the  home button, if necessary.
2. Press the   icon.

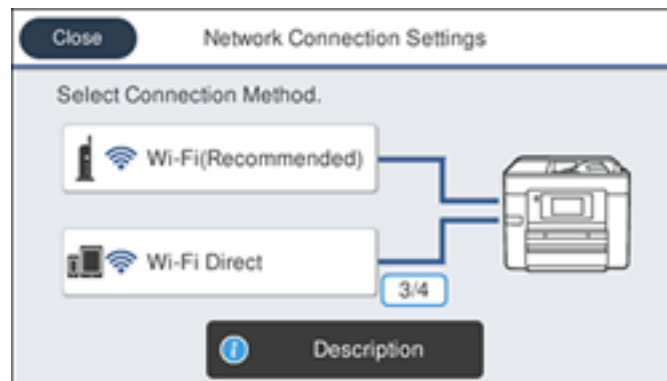

You see a screen like this:





3. Select **Wi-Fi (Recommended)**.
4. Select **Start Setup** or **Change Settings**.
5. Select **Wi-Fi Setup Wizard**.
6. Select the name of your wireless network or select **Enter Manually** to enter the name manually. Use the displayed keypad to enter your network name.
7. Select the **Password** field and enter your wireless password using the displayed keypad.



Note: The network name and password are case sensitive. Be sure to correctly enter uppercase and lowercase letters, and numeric or special characters.

- To move the cursor, press the left or right arrows.
 - To change the case of letters, press .
 - To delete the previous character, press .
 - To enter numbers and symbols, press .
 - To enter a space, press **Space**.
8. Press **OK** when you finish entering your password.
 9. Confirm the displayed network settings and select **Start Setup** to save them.
 10. If you want to print a network setup report, select **Print Check Report**. (Otherwise, select **OK**.)

11. Press the  home button to exit.

You see the  icon on the LCD screen and should be able to connect to your product directly from your computer or device, and then print. If you are printing from a computer, make sure you installed the network software as described on the *Start Here* sheet.

Note: If you don't see the  icon, you may have selected the wrong network name or entered the password incorrectly. Repeat these steps to try again.

Parent topic: [Wi-Fi Infrastructure Mode Setup](#)

Related references

[Status Icon Information](#)

Related tasks

[Entering Characters on the LCD Screen](#)

Wi-Fi Direct Mode Setup

You can set up your product to communicate directly with your computer or another device without requiring a wireless router or access point. In Wi-Fi Direct Mode, the product itself acts as a network access point for up to 4 devices.

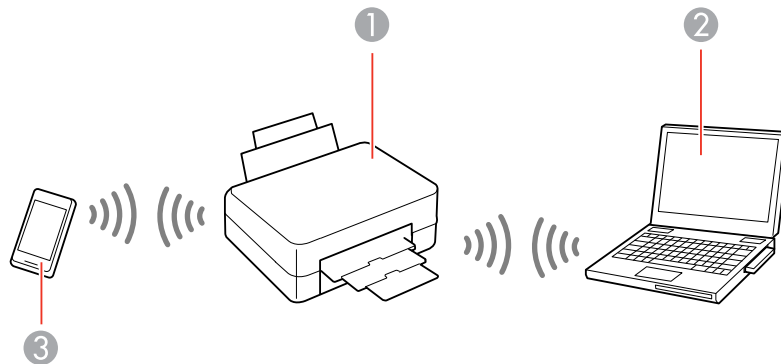

- 1 Epson product
- 2 Computer with a wireless interface
- 3 Other wireless device

[Enabling Wi-Fi Direct Mode](#)



Parent topic: [Wi-Fi or Wired Networking](#)

Related references

[Status Icon Information](#)

Enabling Wi-Fi Direct Mode

You can enable Wi-Fi Direct mode to allow direct communication between your product and computer or other devices without a wireless router or access point.

1. Press the  home button, if necessary.
2. Press the   icon.

You see a screen like this:

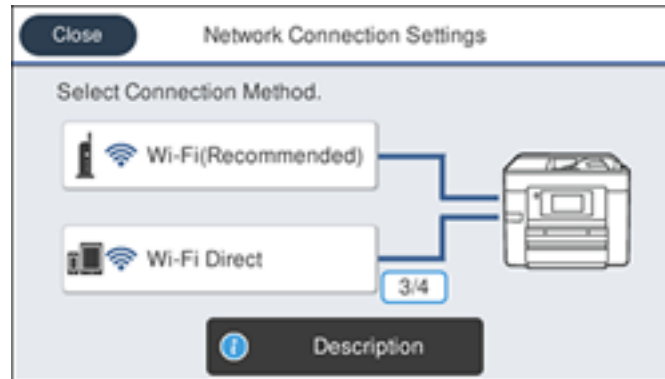



3. Select **Wi-Fi Direct**.
4. Scroll down and select **Start Setup**.
5. Select **Start Setup** again.

You see a screen like this:



6. Use your computer or wireless device to select the Wi-Fi network name (SSID) displayed on the LCD screen, then enter the password shown.
7. Press the  home button to exit.

You see the   icon on the LCD screen and should be able to connect to your product directly from your computer or device, and then print. If you are printing from a computer, make sure you installed the network software as described on the *Start Here* sheet.

Note: If you don't see the  icon on the LCD screen, you may have selected the wrong network name or entered the password incorrectly. Repeat these steps to try again.

Parent topic: [Wi-Fi Direct Mode Setup](#)

Related references

[Status Icon Information](#)

Related tasks

[Entering Characters on the LCD Screen](#)

Wi-Fi Protected Setup (WPS)

If your network uses a WPS-enabled wireless router or access point, you can quickly connect your product to the network using Wi-Fi Protected Setup (WPS).



Note: To check if your router is WPS-enabled, look for a button labeled **WPS** on your router or access point. If there is no hardware button, there may be a virtual WPS button in the software for the device. Check your network product documentation for details.

Using WPS to Connect to a Network

Parent topic: [Wi-Fi or Wired Networking](#)

Using WPS to Connect to a Network

If you have a WPS-enabled wireless router or access point, you can use Wi-Fi Protected Setup (WPS) to connect your product to the network.

1. Press the  home button, if necessary.
2. Press the   icon.

You see a screen like this:

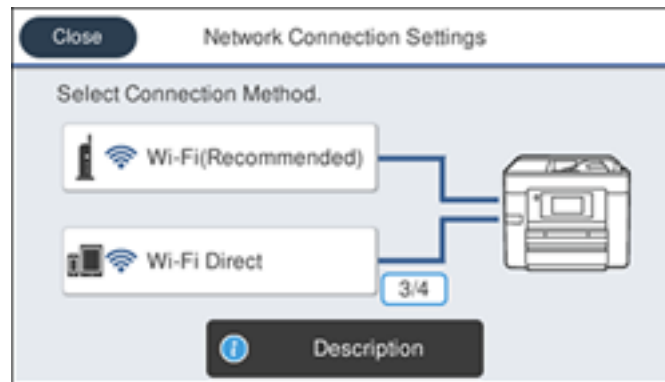

3. Select **Wi-Fi (Recommended)**.
4. Select **Push Button Setup (WPS)**.
5. Follow the instructions on the LCD screen to complete WPS setup.
6. Press the  home button to exit.

You see the  icon on the LCD screen and should be able to connect to your product directly from your computer or device, and then print. If you are printing from a computer, make sure you installed the network software as described on the *Start Here* sheet.

Note: If you don't see the  icon, repeat these steps to try again.

Parent topic: [Wi-Fi Protected Setup \(WPS\)](#)

Printing a Network Status Sheet

You can print a network status sheet to help you determine the causes of any problems you may have using your product on a network.

1. Press the  home button, if necessary.
2. Select **Settings**.
3. Select **General Settings**.

You see a screen like this:



4. Select **Network Settings**.
5. Select **Network Status**.
6. Select **Print Status Sheet**.
7. Select **Print**.

Examine the settings shown on the network status sheet to diagnose any problems you have.

Parent topic: [Wi-Fi or Wired Networking](#)

Configuring Email Server Settings

To use features such as scanning to email or forwarding faxes to email, you need to configure the email server. You can select settings for the email server using the control panel on the product.

1. Press the  home button, if necessary.
2. Select **Settings**.
3. Select **General Settings**.

You see a screen like this:



4. Select **Network Settings**.
5. Scroll down and select **Advanced**.
6. Select **Email Server**.
7. Select **Server Settings**.

You see a screen like this:



8. Select one of the options shown above, then select the settings you want to use. Contact your internet service provider if necessary to confirm the authentication method for the email server.
9. Select **Proceed** to save your settings.
10. Select **Close** to exit.
11. Select **Connection Check** to verify the connection to the email server.

Parent topic: [Wi-Fi or Wired Networking](#)

Related tasks

[Scanning to Email](#)

Changing or Updating Network Connections

See these sections to change or update how your product connects to a network.

[Accessing the Web Config Utility](#)

[Changing a USB Connection to a Wi-Fi Connection](#)

[Changing a Wi-Fi Connection to a Wired Network Connection](#)

[Connecting to a New Wi-Fi Router](#)

[Disabling Wi-Fi Features](#)

Parent topic: [Wi-Fi or Wired Networking](#)

Accessing the Web Config Utility

You can select your product's network settings and confirm its operating status using a web browser. You do this by accessing your product's built-in Web Config utility from a computer or other device that is connected to the same network as your product.

1. Print a network status sheet.
2. Locate the IP address for your product that is listed on the network status sheet.
3. On a computer or other device connected to the same network as your product, open a web browser.
4. Enter your product's IP address into the address bar.

You see the available Web Config utility options.

Parent topic: [Changing or Updating Network Connections](#)

Changing a USB Connection to a Wi-Fi Connection

If you have already connected your product to your computer using a USB connection, you can change to a Wi-Fi connection.

1. Disconnect the USB cable from your product.
2. Uninstall your product software.
3. Download and install your product software from the Epson website using the instructions on the *Start Here* sheet.

Parent topic: [Changing or Updating Network Connections](#)

Changing a Wi-Fi Connection to a Wired Network Connection

If you have already connected your product to your computer wirelessly, you can change to a wired network connection if necessary.

1. Disable your product's Wi-Fi features.
2. Connect one end of an Ethernet network cable to the product's **LAN** port.
3. Connect the other end to any available LAN port on your router or access point.
4. Uninstall your product software.
5. Download and install your product software from the Epson website.
6. Follow the on-screen instructions to install the software.
7. When you see the Select Your Connection screen, select **Wired network connection**.

8. If you see a Select Setup Option screen, select **Set up printer for the first time**.
9. Continue following the rest of the on-screen instructions.

Parent topic: [Changing or Updating Network Connections](#)

Related tasks

[Disabling Wi-Fi Features](#)

Connecting to a New Wi-Fi Router

If you change the wireless router you have been using on your network, you need to update your product's Wi-Fi connection to the new router.

Note: If you switch to a 5 GHz wireless router, set the router to operate in dual band (2.4 GHz and 5 GHz) mode. See your router documentation for instructions.

1. Do one of the following:
 - **Windows:** Uninstall your product software.
 - **Mac:** Go to the next step.
2. Download and install your product software from the Epson website using the instructions on the *Start Here* sheet.

Parent topic: [Changing or Updating Network Connections](#)



Related tasks

[Uninstalling Product Software - Windows](#)

Disabling Wi-Fi Features

You may need to disable your product's Wi-Fi features if you change your network connection type or need to solve a problem with your network connection.

Note: Before disabling Wi-Fi features, make a note of your product's SSID (network name) and password, and any network settings selected for the Epson Connect services you may use.

1. Press the  home button, if necessary.
2. Press the   icon.

You see a screen like this:

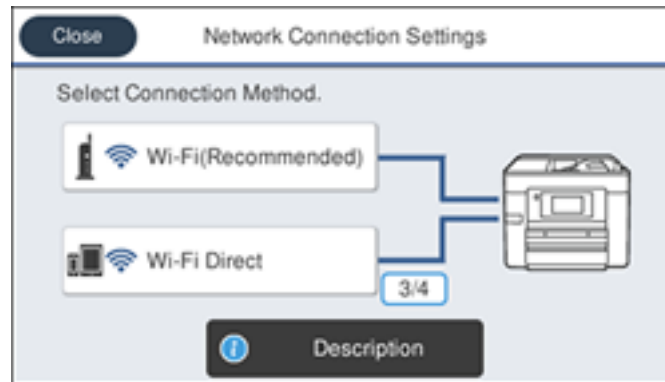

3. Select **Wi-Fi (Recommended)**.
4. Select **Change Settings**.
5. Select **Others**.
6. Select **Disable Wi-Fi**.
7. Select **Yes** to disable Wi-Fi.

Parent topic: [Changing or Updating Network Connections](#)

Loading Paper

Before you print, load paper for the type of printing you will do.

[Loading Paper in the Cassette](#)

[Available Epson Papers](#)

[Paper or Media Type Settings - Printing Software](#)

[Selecting the Paper Settings for Each Source - Control Panel](#)

[Selecting the Default Paper Source Settings](#)

[Selecting the Universal Print Settings](#)

Loading Paper in the Cassette

You can load paper up to this size in the paper cassette: Legal (8.5 × 14 inches [216 × 356 mm]).

Note: Before loading paper, make sure your product is not currently printing, scanning, or copying.

1. Pull out the paper cassette.

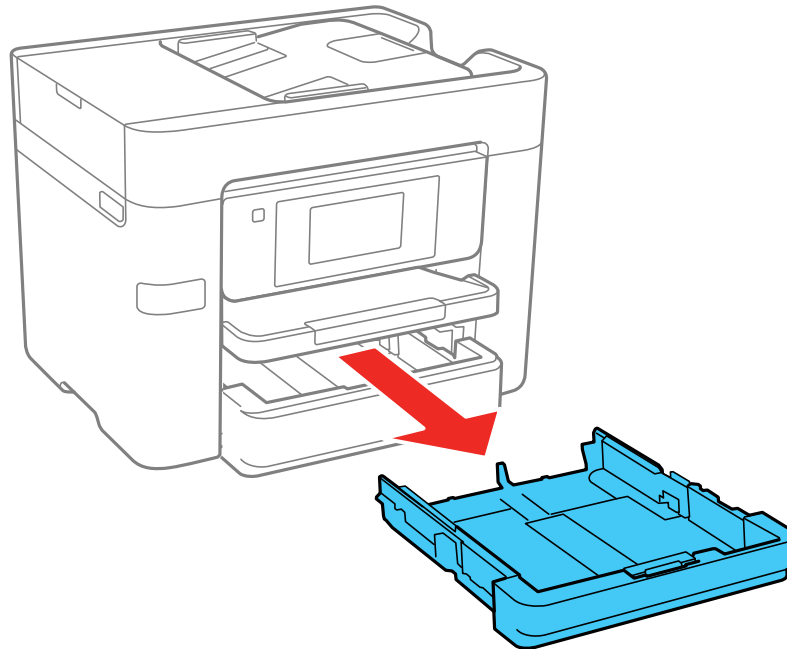

2. Slide the edge guides outward.

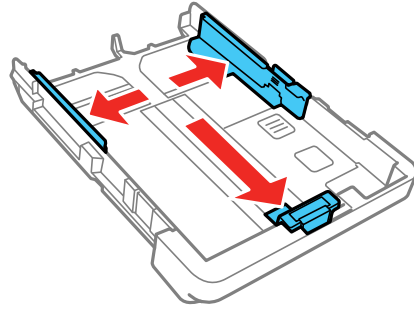

Note: If you are using legal-size paper or larger, press the button and extend the paper cassette.

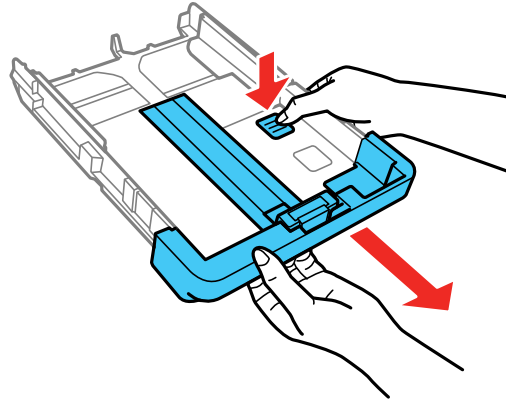

3. Slide the front edge guide to your paper size.

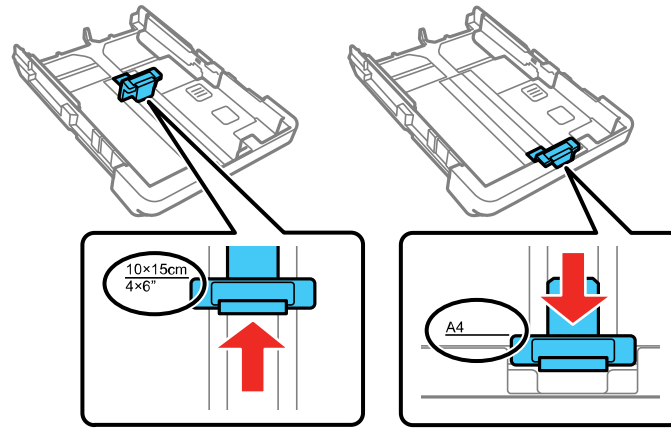

4. Do one of the following:

- Insert paper in the cassette with the glossy or printable side facedown and slide it against the front edge guide.

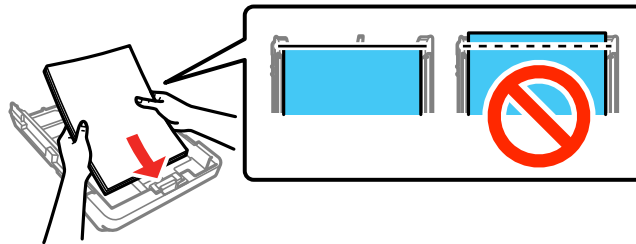

Note: Make sure the paper is loaded against the front edge guide and not sticking out from the rear of the cassette.

- Insert up to 10 envelopes with the printable side facedown and flap edge left, as shown.

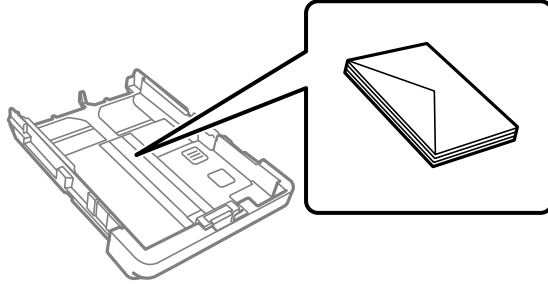

Note: Load envelopes only in paper cassette 1.

- Load a sheet of loose-leaf or other paper with holes as shown.

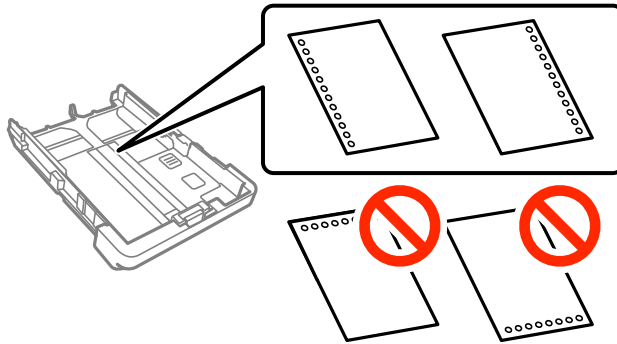

Note: Do not select automatic 2-sided printing for this type of paper and do not print over the holes.

5. Slide the edge guides against the paper, but not too tightly.

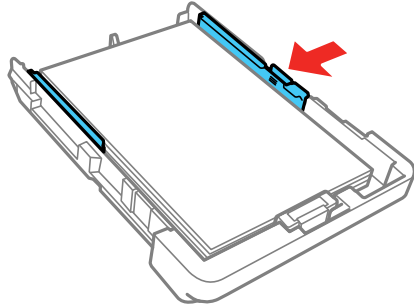

Note: Make sure the paper fits under the tabs on the edge guides.

6. Keep the cassette flat as you insert it.

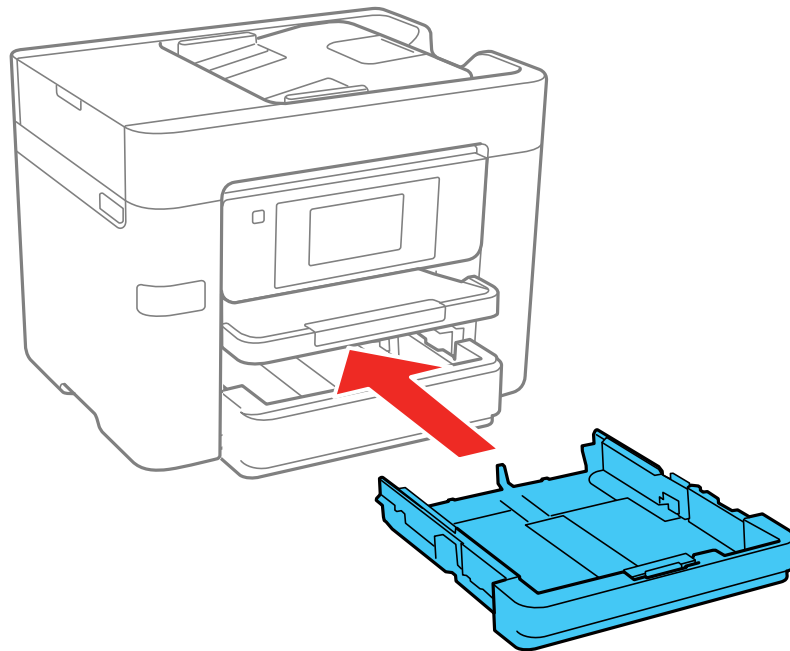

Note: The paper may slide forward slightly as you insert the cassette. This is normal.

7. If prompted by the product's LCD screen, select the size and type of the paper you loaded and select **Close**.
8. Extend the output tray and open its extension.

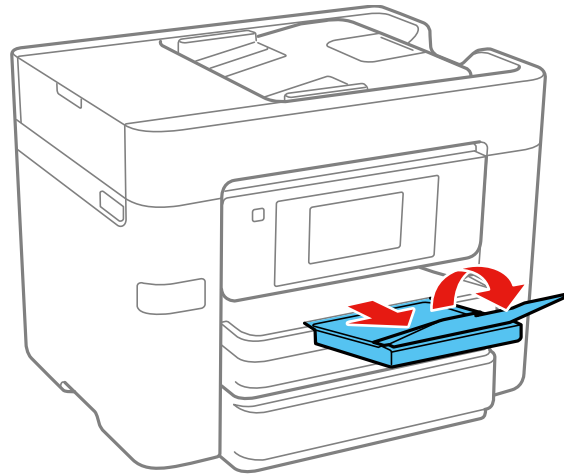

Note: Do not remove or insert the paper cassette during printing.

Always follow these paper loading guidelines:

- Load only the recommended number of sheets.
- Load paper short edge first and printable side facedown.
- Make sure the paper is under the tabs on the edge guides and not sticking out from the rear end of the cassette.
- If you have trouble loading a stack of envelopes, press each envelope flat before loading it or load one envelope at a time.
- If print quality declines when printing multiple envelopes, try loading one envelope at a time.
- Load letterhead or pre-printed paper top edge first.
- Check the paper package for any additional loading instructions.

[Paper Loading Capacity](#)

[Double-sided Printing Capacity](#)
[Borderless Paper Type Compatibility](#)

Parent topic: [Loading Paper](#)

Related references

[Paper Specifications](#)

Paper Loading Capacity

See the table here for the loading capacity of the paper cassettes.

Paper type	Loading capacity	
	Cassette 1 (upper cassette)	Cassette 2 (lower cassette)
Plain paper Copy paper High-quality plain paper	Letter (8.5 × 11 inches [216 × 279 mm]) or A4 (8.3 × 11.7 inches [210 × 297 mm]) size: Up to the line indicated by the triangle mark ¹	
Letterhead paper Recycled paper Colored paper Pre-printed paper	Half Letter (5.5 × 8.5 inches [140 × 216 mm]), A5 (5.8 × 8.2 inches [148 × 210 mm]), A6 (4.1 × 5.8 inches [105 × 148 mm]), B6 (5 × 7.2 inches [128 × 182 mm]) size: up to the line indicated by the triangle mark ²	—
	Legal (8.5 × 14 inches [216 × 356 mm]) size: 30 sheets ³	
Epson Bright White Paper	200 sheets	
Epson Presentation Paper Matte	80 sheets	—
Epson Premium Presentation Paper Matte Epson Photo Paper Glossy ⁴ Epson Premium Photo Paper Glossy ⁴ Epson Ultra Premium Photo Paper Glossy ⁴ Epson Premium Photo Paper Semi-gloss ⁴	20 sheets	—

Paper type	Loading capacity	
	Cassette 1 (upper cassette)	Cassette 2 (lower cassette)
Envelopes	10 envelopes	—

¹ Automatic and manual 2-sided printing supported; load up to 30 sheets for manual 2-sided printing

² Manual 2-sided printing supported; load up to 30 sheets

³ Manual 2-sided printing supported; load 1 sheet at a time

⁴ If paper feeds incorrectly, or printing is uneven or smeared, load 1 sheet at a time.

Parent topic: [Loading Paper in the Cassette](#)

Double-sided Printing Capacity

Paper type	Size	Double-sided Printing Capacity	
		Auto	Manual
Plain paper Copier paper Letterhead paper Recycled paper Colored paper Pre-printed paper High quality plain paper	Letter (8.5 × 11 inches [216 × 279 mm]) or A4 (8.3 × 11.7 inches [210 × 297 mm]) Half Letter (5.5 × 8.5 inches [140 × 216 mm]), A5 (5.8 × 8.2 inches [148 × 210 mm]), A6 (4.1 × 5.8 inches [105 × 148 mm]), B6 (5 × 7.2 inches [128 × 182 mm])	Up to the arrow mark —	30 sheets
Epson Bright White Paper	Letter (8.5 × 11 inches [216 × 279 mm])	200 sheets	

Paper type	Size	Double-sided Printing Capacity	
		Auto	Manual
Epson Presentation Paper Matte Epson Photo Paper Glossy Epson Premium Photo Paper Glossy Epson Premium Photo Paper Semi-gloss Epson Ultra Premium Photo Paper Glossy Epson Premium Presentation Paper Matte	Letter (8.5 × 11 inches [216 × 279 mm]) and smaller	—	—
Envelopes	No. 10 (4.1 × 9.5 inches [105 × 241 mm])	—	—

Parent topic: [Loading Paper in the Cassette](#)

Borderless Paper Type Compatibility

You can print borderless photos on compatible paper types in compatible sizes:

Borderless Paper Types

- Epson Photo Paper Glossy
- Epson Premium Photo Paper Glossy
- Epson Ultra Premium Photo Paper Glossy
- Epson Premium Photo Paper Semi-gloss
- Epson Presentation Paper Matte

- Epson Premium Presentation Paper Matte

Borderless Paper Sizes

- 4 × 6 inches (102 × 152 mm)
- 5 × 7 inches (127 × 178 mm)
- 16:9 wide (4 × 7.1 inches [102 × 181 mm])
- A4 (8.3 × 11.7 inches [210 × 297 mm])
- Letter (8.5 × 11 inches [216 × 279 mm])

Parent topic: [Loading Paper in the Cassette](#)

Available Epson Papers

You can purchase genuine Epson ink, maintenance boxes, and paper at epson.com (U.S. sales) or epson.ca (Canadian sales). You can also purchase supplies from an Epson authorized reseller. To find the nearest one, call 800-GO-EPSON (800-463-7766) in the U.S. or 800-807-7766 in Canada.

Paper Type	Size	Part number	Sheet count
Epson Bright White Paper	Letter (8.5 × 11 inches [216 × 279 mm])	S041586	500
Epson Presentation Paper Matte	Letter (8.5 × 11 inches [216 × 279 mm])	S041062	100
	Legal (8.5 × 14 inches [216 × 356 mm])	S041067	100
Epson Premium Presentation Paper Matte	8 × 10 inches (203 × 254 mm)	S041467	50
	Letter (8.5 × 11 inches [216 × 279 mm])	S041257 S042180	50 100
Epson Photo Paper Glossy	4 × 6 inches (102 × 152 mm)	S041809	50
		S042038	100
	Letter (8.5 × 11 inches [216 × 279 mm])	S041141 S041649 S041271	20 50 100

Paper Type	Size	Part number	Sheet count
Epson Premium Photo Paper Glossy	4 × 6 inches (102 × 152 mm)	S041808	40
		S041727	100
	16:9 wide (4 × 7.1 inches [102 × 181 mm])	S042109	20
	5 × 7 inches (127 × 178 mm)	S041464	20
	8 × 10 inches (203 × 254 mm)	S041465	20
Epson Ultra Premium Photo Paper Glossy	Letter (8.5 × 11 inches [216 × 279 mm])	S042183	25
		S041667	50
	4 × 6 inches (102 × 152 mm)	S042181	60
		S042174	100
Epson Premium Photo Paper Semi-gloss	5 × 7 inches (127 × 178 mm)	S041945	20
	8 × 10 inches (203 × 254 mm)	S041946	20
	Letter (8.5 × 11 inches [216 × 279 mm])	S042182	25
	S042175	50	
Epson Premium Photo Paper Semi-gloss	4 × 6 inches (102 × 152 mm)	S041982	40
	Letter (8.5 × 11 inches [216 × 279 mm])	S041331	20

Parent topic: [Loading Paper](#)

Paper or Media Type Settings - Printing Software

For this paper	Select this paper Type or Media Type setting
Plain paper Epson Bright White Paper	Plain Paper / Bright White Paper
Letterhead paper	Letterhead
Recycled paper	Recycled
Colored paper	Color

For this paper	Select this paper Type or Media Type setting
Pre-printed paper	Preprinted
High-quality plain paper	High-quality plain paper
Envelopes	Envelope
Epson Ultra Premium Photo Paper Glossy	Ultra Premium Photo Paper Glossy
Epson Premium Photo Paper Glossy	Premium Photo Paper Glossy
Epson Photo Paper Glossy	Photo Paper Glossy
Epson Premium Photo Paper Semi-gloss	Premium Photo Paper Semi-Gloss
Epson Presentation Paper Matte	Premium Presentation Paper Matte
Epson Premium Presentation Paper Matte	

Note: The settings listed here are available only when printing from your computer; they do not apply to your product's control panel settings.

Parent topic: [Loading Paper](#)

Selecting the Paper Settings for Each Source - Control Panel

You can change the default paper size and paper type for each source using the control panel on the product.

1. Press the  home button, if necessary.
2. Select **Settings** > **General Settings** > **Printer Settings** > **Paper Source Settings** > **Paper Settings**.

You see a screen like this:



3. Select **Paper Size**.
4. Select the paper size you loaded.
5. Select **Paper Type**.
6. Select the paper type you loaded.
7. Select **Favorite Paper Settings** to choose from a list of commonly used paper settings.
8. Select  to choose another paper source or exit.

[Paper Type Settings - Control Panel](#)

Parent topic: [Loading Paper](#)

Paper Type Settings - Control Panel

Select a **Paper Type** setting that matches the paper you loaded.

Paper type loaded	Paper Type setting
Plain paper	Plain Paper
Epson Bright White Paper	
Letterhead paper	Letterhead
Recycled paper	Recycled
Colored paper	Color

Paper type loaded	Paper Type setting
Pre-printed paper	Preprinted
High-quality plain paper	High Quality Plain Paper
Envelopes	Envelope
Epson Ultra Premium Photo Paper Glossy	Ultra Glossy
Epson Premium Photo Paper Glossy	Prem. Glossy
Epson Photo Paper Glossy	Glossy
Epson Premium Photo Paper Semi-gloss	Prem. Semi-Gloss
Epson Presentation Paper Matte	Prem. Matte
Epson Premium Presentation Paper Matte	

Parent topic: [Selecting the Paper Settings for Each Source - Control Panel](#)

Selecting the Default Paper Source Settings

You can change default paper source settings using the control panel on the product.

1. Press the  home button, if necessary.
2. Select **Settings** > **General Settings** > **Printer Settings**.

You see a screen like this:

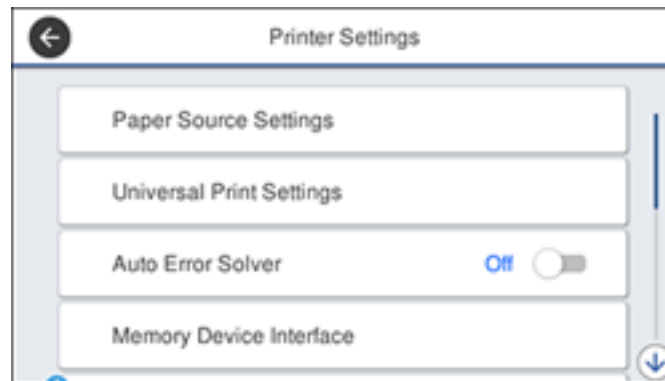

3. Select one of these **Auto Error Resolver** options:
 - Turn on this setting to display a warning and print single-sided when a 2-sided printing error occurs, or to print only what the printer could process when a memory full error occurs.
 - Turn off this setting to display an error message and stop printing if an error occurs.
4. Select the **Paper Source Settings** options you want to use.
5. When you are finished, press the  home button to exit.

[Paper Source Settings Options](#)

Parent topic: [Loading Paper](#)

Paper Source Settings Options

Select the paper source options you want to use for your print jobs.

Paper Source Settings option	Available settings	Description
Paper Setting	Various	Select the paper size and type for each paper source
A4/Letter Auto Switching	On	Select On to switch the selected paper size to match the loaded paper (Letter or A4) if the wrong size is selected
	Off	
Auto Select Settings	Copy	Select On for any of these settings to automatically print on paper from any source containing paper that matches your paper settings
	Fax	
	Other	
Error Notice	Paper Size Notice	Select On for either of these settings to display an error message when the selected paper type or size does not match the loaded paper
	Paper Type Notice	
Paper Setup Auto Display	On	Select On to automatically display a menu that lets you select the paper size and type when you load paper in the product
	Off	

Parent topic: [Selecting the Default Paper Source Settings](#)

Selecting the Universal Print Settings

You can change the default universal print settings using the control panel on the product.

1. Press the  home button, if necessary.

2. Select **Settings > General Settings > Printer Settings > Universal Print Settings**.

You see this screen:



3. Adjust the settings as necessary.
4. When you are finished, press the  home button to exit.

[Universal Print Settings Options](#)

Parent topic: [Loading Paper](#)

Universal Print Settings Options

Select the universal print setting options you want to use for your print jobs.

Universal Print Settings option	Available settings	Description
Top Offset	—	Adjust the top or left margin
Left Offset		
Top Offset in Back	—	Adjust the top or left margin of the back page when printing double-sided.
Left Offset in Back		

Universal Print Settings option	Available settings	Description
Check Paper Width	On	Select On to check the paper width before printing. This prevents printing beyond the edges of the paper when the paper size settings are incorrect, but may reduce the printing speed.
	Off	
Skip Blank Page	On	Select On to skip printing of blank pages automatically
	Off	

Parent topic: [Selecting the Universal Print Settings](#)

Placing Originals on the Product

Follow the instructions here to place your original documents or photos on the product.

Caution: Do not place anything on top of your product or use its cover as a writing surface to avoid damaging it.

[Placing Originals on the Scanner Glass](#)

[Placing Originals in the Automatic Document Feeder](#)

Placing Originals on the Scanner Glass

You can place originals up to this size on the scanner glass: Letter (8.5 × 11 inches [216 × 279 mm]) or A4 (8.3 × 11.7 inches [210 × 297 mm]).

1. Open the document cover.

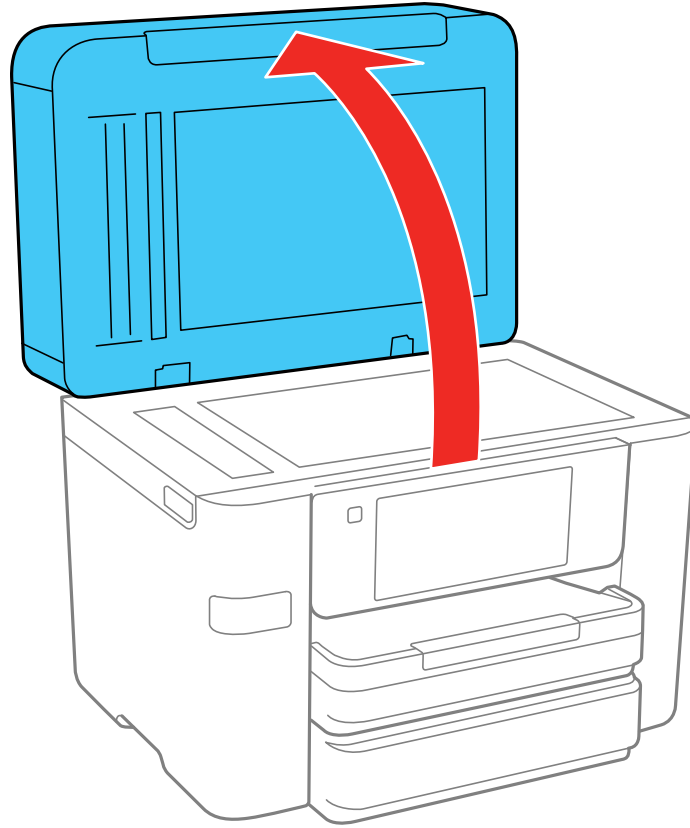

2. Place your original facedown on the scanner glass with the top facing into the corner. Slide the original to the edges of the indicated corner.

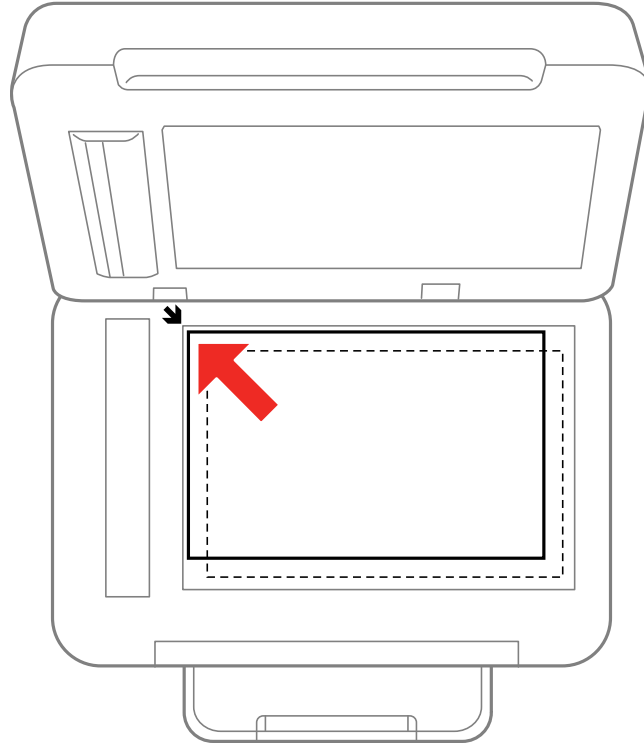

Note: The edges of your original may be cropped by 0.06 inch (1.5 mm) from the edge of the scanner glass. Manually position your original away from the edges to prevent cropping.

3. Close the document cover gently to keep your original in place.

Parent topic: [Placing Originals on the Product](#)

Related topics

[Copying](#)

[Scanning](#)

[Faxing](#)

Placing Originals in the Automatic Document Feeder

You can place single- or multi-page original documents in the Automatic Document Feeder (ADF). You can also use the ADF to scan both sides of a 2-sided document. Make sure the originals meet the Automatic Document Feeder specifications before loading them.

Caution: Make sure your originals are not creased or folded, and do not contain holes, staples, tape, or other materials that could obstruct the feeder.

Caution: Do not place photographs or valuable artwork in the ADF. Place fragile or valuable originals on the scanner glass to avoid wrinkling or damaging them.

1. Slide the ADF edge guide outward.

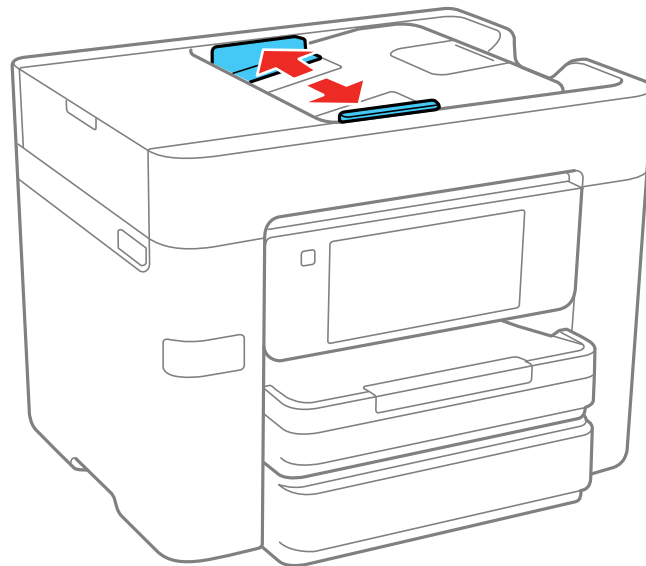

2. Fan your stack of originals and tap them gently on a flat surface to even the edges.

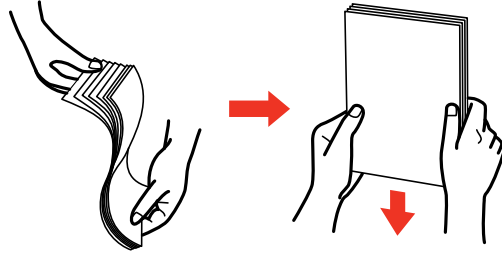

3. Insert the originals into the ADF faceup and top-edge first.

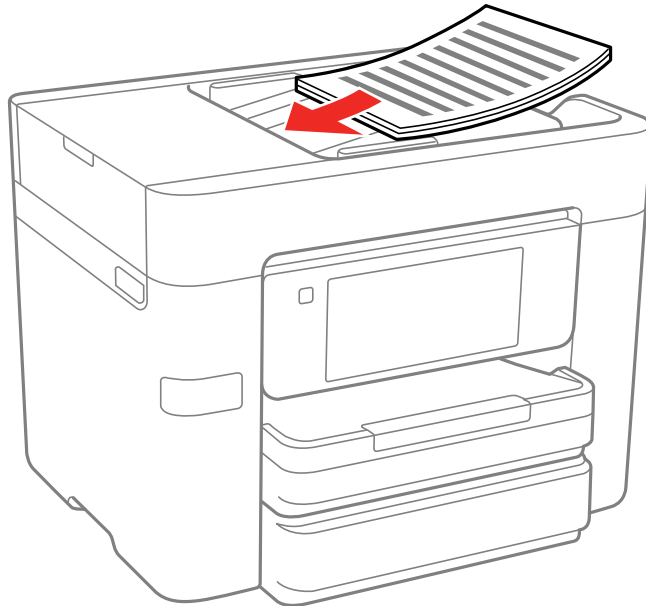

The **ADF** icon on the Copying, Scanning, and Faxing screens lights up.

4. Slide the ADF edge guide against the originals, but not too tightly.

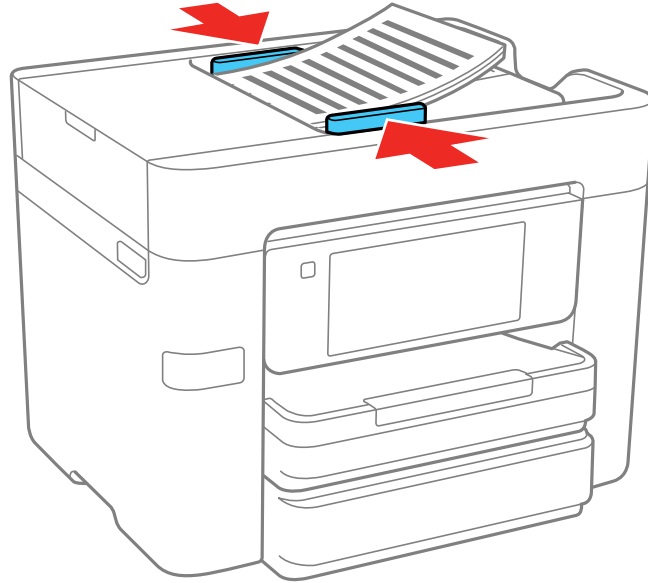

[ADF Original Document Specifications](#)

Parent topic: [Placing Originals on the Product](#)

Related topics

[Copying](#)

[Scanning](#)

[Faxing](#)

ADF Original Document Specifications

You can load original documents that meet these specifications in the ADF.

Paper type	Paper size	Paper weight	Loading capacity
Plain paper	Letter (8.5 × 11 inches [216 × 279 mm])	17 to 24 lb (64 to 95 g/m ²)	Approximately 50 sheets (Legal size: 10 sheets)
	Legal (8.5 × 14 inches [216 × 356 mm])		
	A4 (8.3 × 11.7 inches [210 × 297 mm])		
	A5 (5.8 × 8.2 inches [148 × 210 mm])		
	B5 (7.2 × 10.1 inches [182 × 257 mm])		

Caution: Do not load the following types of originals in the ADF, or they may be damaged or may damage the scanner. Use the scanner glass for these types:

- Photos
- Thermal paper
- Fabric or other non-paper originals
- Originals with uneven surfaces, such as embossed documents
- Originals containing staples or paper clips
- Originals with carbon paper backing
- Originals with wet ink
- Originals that are bound
- Originals with labels, stickers, or sticky notes
- Ripped, curled, folded, deteriorated, or wrinkled originals
- Originals with holes
- Transparencies
- Carbon-less paper

Parent topic: [Placing Originals in the Automatic Document Feeder](#)

Copying

See the information here to copy documents or photos using your product.

Note: Copies may not be exactly the same size as your originals.

[Copying Documents or Photos](#)

[Copying Options](#)

Copying Documents or Photos

You can copy documents or photos onto various sizes and types of paper, including Epson special papers.

1. Place your original document or photo on the scanner glass, or place multi-page documents in the ADF.
2. Load the paper you want to print on.
3. Press the  home button, if necessary.
4. Select **Copy**.

You see a screen like this:

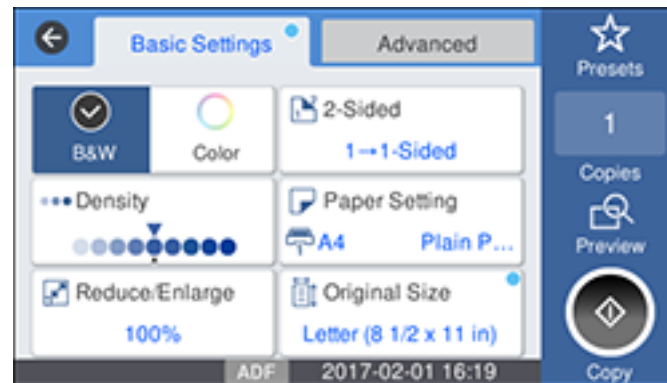

5. To print more than one copy, press a number key on the product's control panel, or select **Copies** and use the displayed keypad to enter the number of copies.

6. Change any of the displayed settings as necessary.
7. Select **Advanced** to view and change additional copy settings, if necessary.
8. Select **Preview** to preview your copy on the LCD screen.
9. Select **Preset** to save your copy settings.
10. When you are ready to copy, press the **Copy** icon.

Note: To cancel printing, select **Cancel**.

Parent topic: [Copying](#)

Related references

[Copying Options](#)

[Available Epson Papers](#)

Related tasks

[Using Presets](#)

[Loading Paper in the Cassette](#)

Related topics

[Placing Originals on the Product](#)

Copying Options

Select the copying options you want to use for your copies.

Note: Not all options or settings may be available, depending on other copying settings.

Basic Settings

Copying option	Available settings	Description
B&W	—	Copies the document in black and white
Color	—	Copies the document in color
Paper Setting	Various sources	Select the paper source that you want to use. If you select Auto , paper is fed automatically depending on the paper settings you selected for the paper sources.
Original Size	Various sizes	Select the document size of your original

Copying option	Available settings	Description
Density	Varying levels	Adjusts the lightness or darkness of copies
Reduce/Enlarge	100%	Copies the original at its full size
	Auto Fit Page	Automatically sizes the image to fit the paper size you selected
	45%->195% and other conversions	Automatically converts from one size to another
2-Sided	1>1-Sided	Select to make 2-sided copies. When you select 1>2-Sided or 2>1-Sided , also select the Advanced tab to select the orientation and binding edge for your originals or copies.
	2>2-Sided	
	1>2-Sided	
	2>1-Sided	

Advanced settings

Copying option	Available settings	Description
Multi-Page	Single Page	Copies each page of the original onto an individual sheet
	2-up	Copies multiple page documents onto one sheet. Scroll down and select the document orientation and layout order settings as necessary.
	4-up	
Original Type	Text	Specifies the document type of your originals and adjusts the quality of your copies
	Text & Image	
	Photo	
	Text & Image(Best)	
Finishing	Group (Same Pages)	Select to print multiple copies of a multi-page document in unordered groups
	Collate (Page Order)	Select to print multiple copies of a multi-page document in ordered sets
Orientation (Original)	Up Direction	Specifies the orientation of your originals
	Left Direction	
Image Quality	Various settings	Select advanced quality settings such as Saturation and Sharpness

Copying option	Available settings	Description
Remove Shadow	Off	Select On to erase the shadows that appear in the center of a document when copying a book or that appear around a document when copying thick paper
	On	
Remove Punch Holes	Off	Select On to erase the binding holes on a document
	On	
ID Card Copy	Off	Select On to copy both sides of an ID card onto one side of a sheet of paper
	On	
Borderless Copy	Off	Adjusts the amount to expand the original photo when printing borderless photos
	On	
	Standard	
	Medium	
	Minimum	

Parent topic: [Copying](#)

Printing from a Computer

Before printing from your computer, make sure you have set up your product and installed its software as described on the *Start Here* sheet.

Note: If you have an Internet connection, it is a good idea to check for updates to your product software on Epson's support website. If you see a Software Update screen, select **Enable automatic checking** and click **OK**. The update scans your system to see if you have the latest product software. Follow the on-screen instructions.

[Printing with Windows](#)

[Printing on a Mac](#)

[Printing From a Chromebook](#)

[Cancelling Printing Using the Product](#)

Printing with Windows

You can print with your product using any Windows application, as described in these sections.

[Selecting Basic Print Settings - Windows](#)

[Selecting Double-sided Printing Settings - Windows](#)

[Selecting Additional Layout and Print Options - Windows](#)

[Selecting a Printing Preset - Windows](#)

[Selecting Extended Settings - Windows](#)

[Printing Your Document or Photo - Windows](#)

[Locking Printer Settings - Windows](#)

[Selecting Default Print Settings - Windows](#)

[Changing Automatic Update Options](#)

Parent topic: [Printing from a Computer](#)

Selecting Basic Print Settings - Windows

Select the basic settings for the document or photo you want to print.

1. Open a photo or document for printing.

2. Select the print command in your application.

Note: You may need to select a print icon on your screen, the **Print** option in the **File** menu, or another command. See your application's help utility for details.

3. If necessary, select your product name as the printer you want to use.

Note: You may also need to select **Properties** or **Preferences** to view your print settings.

You see the Main tab of your printer settings window:

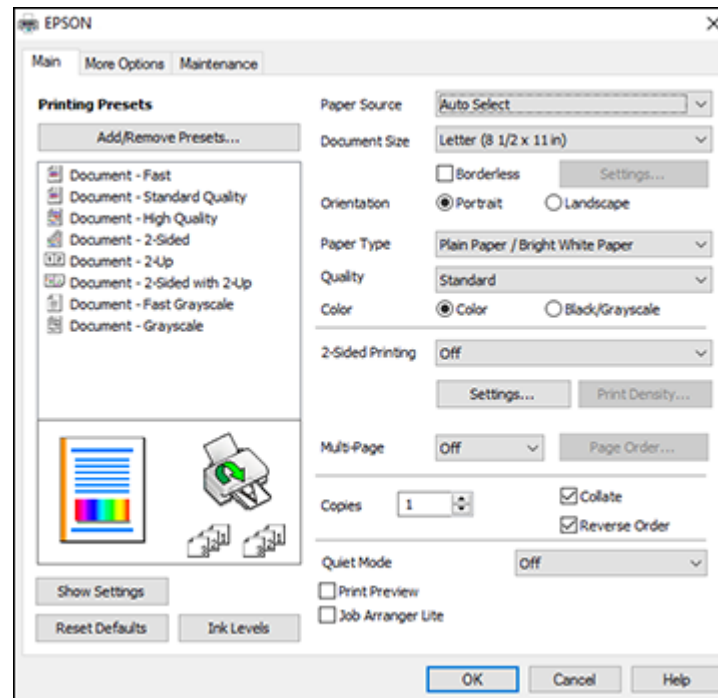

4. For the **Paper Source** setting, select where you loaded the paper you want to print on.
5. Select the size of the paper you loaded as the **Document Size** setting.

Note: You can also select the **User-Defined** setting to create a custom paper size.

6. If you are printing a borderless photo, select **Borderless**. You can click **Settings** to access additional options for borderless printing.

Note: You must select a compatible borderless paper type and size to print without borders. Check the borderless paper compatibility list for details.

7. Select the orientation of your document.

Note: If you are printing an envelope, select **Landscape**.

8. Select the type of paper you loaded as the **Paper Type** setting.

Note: The setting may not exactly match the name of your paper. Check the paper type settings list for details.

9. Select the **Quality** setting that matches the print quality you want to use.

10. Select a Color option:

- To print a color document or photo, select the **Color** setting.
- To print text and graphics in black or shades of gray, select the **Black/Grayscale** setting.

11. To print on both sides of the paper, select the **2-Sided Printing** setting and select the options you want.

12. To print multiple pages on one sheet of paper, or print one image on multiple sheets of paper, select one of the settings in the **Multi-Page** menu and select the printing options you want.

13. To print multiple copies and arrange their print order, select the **Copies** options.

14. To preview your job before printing, select **Print Preview**.

15. To save your print job as a project that can be modified and combined with other print jobs, select **Job Arranger Lite**.

16. To reduce noise during printing when you select **Plain Paper/Bright White Paper**, select **On** in the Quiet Mode menu.

Note: Enabling **Quiet Mode** may reduce printing speed.

[Paper Source Options - Windows](#)

[Print Quality Options - Windows](#)

[Multi-Page Printing Options - Windows](#)

Parent topic: [Printing with Windows](#)

Related references

[Borderless Paper Type Compatibility](#)

Related tasks

[Selecting Double-sided Printing Settings - Windows](#)

[Printing Your Document or Photo - Windows](#)

Paper Source Options - Windows

You can select any of the available options in the Paper Source menu to print on the paper loaded in that source.

Auto Select

Automatically selects the paper source based on the selected paper size.

Paper Cassette 1

Selects the paper in cassette 1 as the paper source.

Paper Cassette 2

Selects the paper in cassette 2 as the paper source.

Parent topic: [Selecting Basic Print Settings - Windows](#)

Print Quality Options - Windows

You can select any of the available Quality options to fine-tune the quality of your print. Some settings may be unavailable, depending on the paper type and border setting you have chosen.

Draft

For draft printing on plain paper.

Standard

For everyday text and image printing.

High

For photos and graphics with high print quality.

Parent topic: [Selecting Basic Print Settings - Windows](#)

Multi-Page Printing Options - Windows

You can select any of the available options in the Multi-Page menu to set up your multi-page print job.

2-Up and 4-Up

Prints 2 or 4 pages on one sheet of paper. Click the **Page Order** button to select page layout and border options.

2×1 Poster, 2×2 Poster, 3×3 Poster, 4×4 Poster

Prints one image on multiple sheets of paper to create a larger poster. Click the **Settings** button to select image layout and guideline options.

Parent topic: [Selecting Basic Print Settings - Windows](#)

Selecting Double-sided Printing Settings - Windows

You can print on both sides of the paper by selecting one of the **2-Sided Printing** options on the Main tab.

Note: Some options may be pre-selected or unavailable, depending on other settings you have chosen or if you are accessing the product over a network.

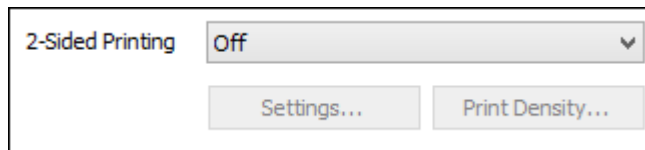

1. Select one of the following options for **2-Sided Printing**:
 - **Auto (Long-edge binding)** to print your double-sided print job by automatically flipping the paper on the long edge.
 - **Auto (Short-edge binding)** to print your double-sided print job by automatically flipping the paper on the short edge.
 - **Manual (Long-edge binding)** to print your double-sided print job by printing one side and prompting you to flip the paper over on the long edge to print the other side (recommended for paper types that do not support automatic duplexing).
 - **Manual (Short-edge binding)** to print your double-sided print job by printing one side and prompting you to flip the paper over on the short edge to print the other side (recommended for paper types that do not support automatic duplexing).
2. Click the **Settings** button.

You see this window:

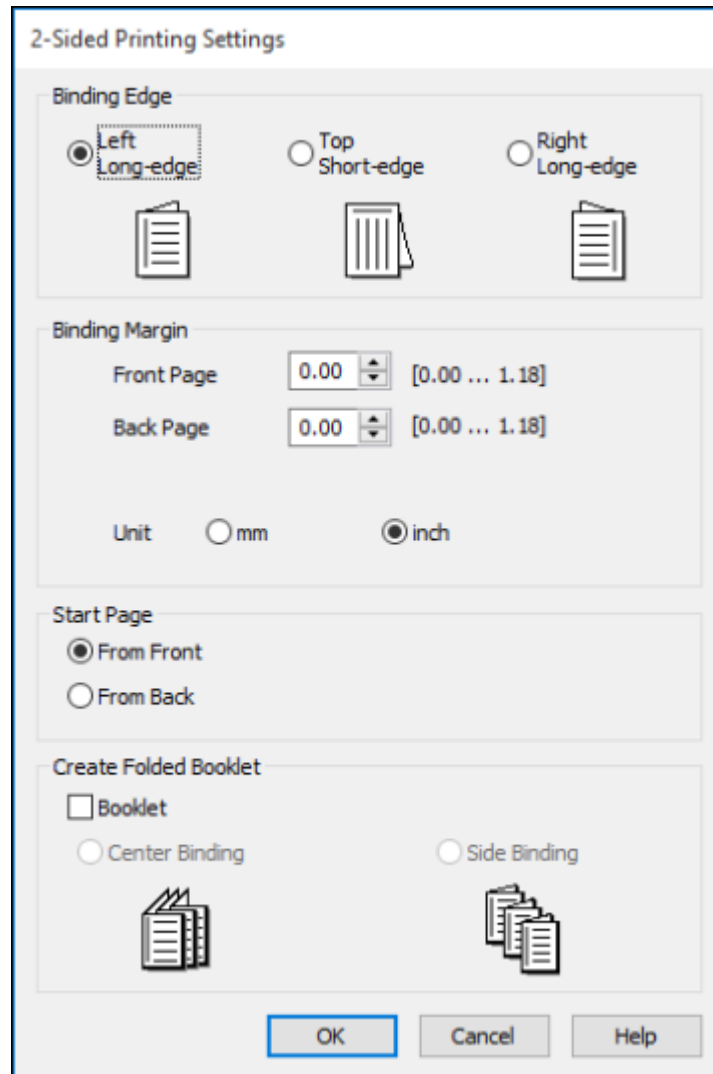

3. Select the double-sided printing options you want to use.
4. Click **OK** to return to the Main tab.

5. Click the **Print Density** button.

You see this window:

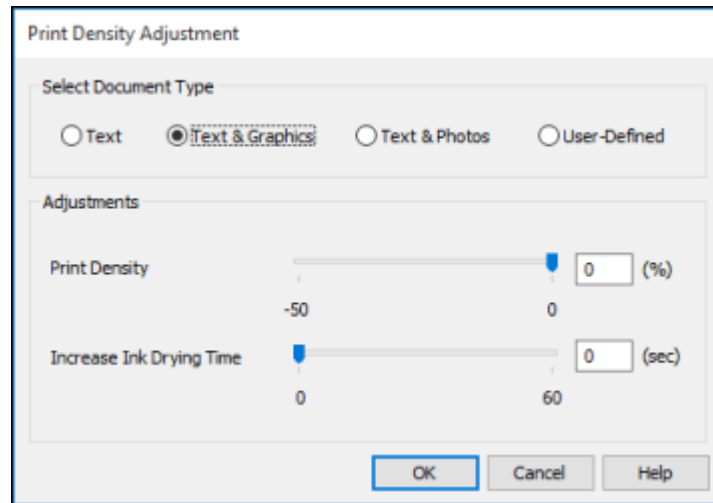

6. Select the type of document you are printing as the Document Type setting. The software automatically sets the **Adjustments** options for that document type.
7. If necessary, select the **Adjustments** options you want to use.
8. Click **OK** to return to the Main tab.
9. Print a test copy of your double-sided document to test the selected settings.
10. Follow any instructions displayed on the screen during printing.

[Double-sided Printing Options - Windows](#)

[Print Density Adjustments - Windows](#)

Parent topic: [Printing with Windows](#)

Double-sided Printing Options - Windows

You can select any of the available options on the 2-Sided Printing Settings window to set up your double-sided print job.

Binding Edge Options

Select a setting that orients double-sided print binding in the desired direction.

Binding Margin Options

Select options that define a wider margin to allow for binding.

Start Page

Selects whether printing starts on the front or back page.

Create Folded Booklet Options

Select the **Booklet** checkbox and a binding option to print double-sided pages as a booklet.

Parent topic: [Selecting Double-sided Printing Settings - Windows](#)

Related references

[Double-sided Printing Capacity](#)

Related tasks

[Selecting Basic Print Settings - Windows](#)

Print Density Adjustments - Windows

You can select any of the available options on the Print Density Adjustment window to adjust the print quality of your double-sided print job.

Print Density

Sets the level of ink coverage for double-sided printing.

Increase Ink Drying Time

Sets the amount of time required for drying ink after printing on one side of the paper before printing the other side in double-sided printing to prevent ink smearing.

Parent topic: [Selecting Double-sided Printing Settings - Windows](#)

Selecting Additional Layout and Print Options - Windows

You can select a variety of additional layout and printing options for your document or photo on the More Options tab.

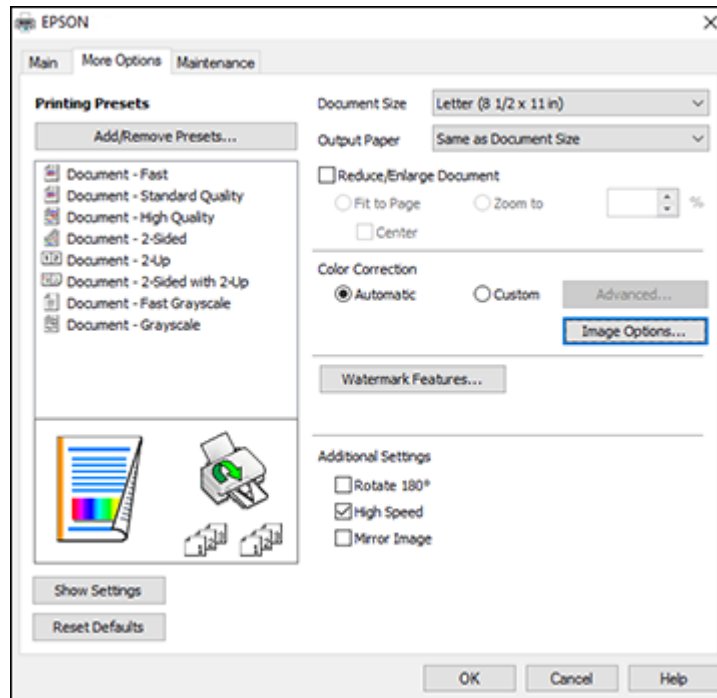

1. To change the size of your printed document or photo, select the **Reduce/Enlarge Document** checkbox and select one of these sizing options:
 - Select the **Fit to Page** option to size your image to fit the paper you loaded. Select the size of your document or photo as the **Document Size** setting, and the size of your paper as the **Output Paper** setting. If you want to center your image on the paper, select the **Center** option.
 - Select the **Zoom to** option to reduce or enlarge your document or photo by a specific percentage. Select the percentage in the % menu.
2. Select one of the following Color Correction options:
 - Select **Automatic** to automatically adjust the sharpness, brightness, contrast, and color saturation for your image.

- Select **Custom** and click the **Advanced** button to manually adjust the color correction settings or turn off color management in your printer software.
- Select **Image Options** to access additional settings for improving printed images.

Note: You can also select **Color Universal Print** settings.

3. To add the following features, click the **Watermark Features** button:

- **Anti-Copy Pattern:** adds a watermark that only appears when your printout is copied
- **Watermark:** adds a visible watermark to your printout

Note: Click the **Add/Delete** button to create your own watermark, and click the **Settings** button to customize the watermark.

- **Header/Footer:** adds information such as the date and time to the top or bottom of your printout

Note: Click the **Settings** button to customize the text and location of the header or footer.

4. Select any of the Additional Settings options to customize your print.

[Custom Color Correction Options - Windows](#)

[Image Options and Additional Settings - Windows](#)

[Header/Footer Settings - Windows](#)

Parent topic: [Printing with Windows](#)

Related tasks

[Printing Your Document or Photo - Windows](#)

Custom Color Correction Options - Windows

You can select any of the available options in the Color Correction window to customize the image colors for your print job.

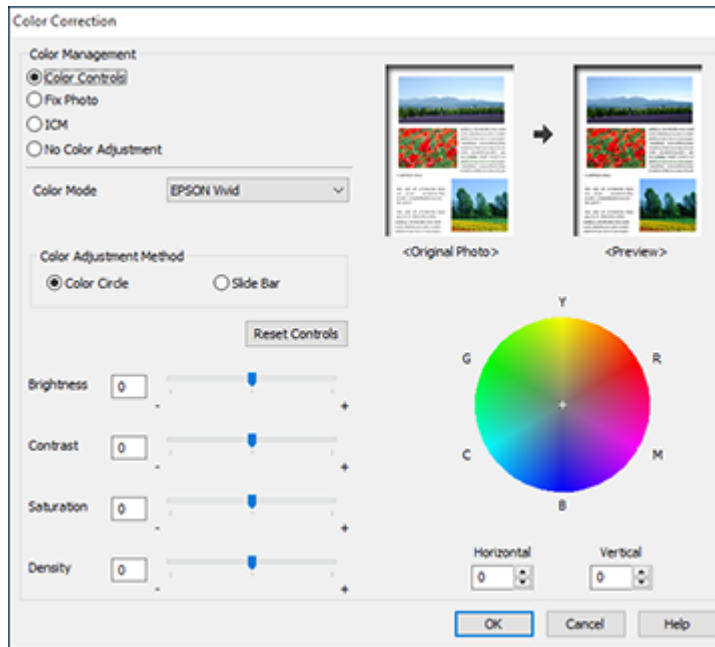

Color Controls

Lets you select a **Color Mode** setting, individual settings for **Brightness**, **Contrast**, **Saturation**, and **Density**, and individual color tones. Depending on the selected color mode, you can also adjust the midtone density using the **Gamma** setting.

Fix Photo

Improves the color, contrast, and sharpness of flawed photos.

Note: Fix Photo uses a sophisticated face recognition technology to optimize photos that include faces. For this to work, both eyes and the nose must be visible in the subject's face. If your photo includes a face with an intentional color cast, such as a statue, you may want to turn off **Fix Photo** to retain the special color effects.

ICM

Lets you manage color using installed color printing profiles.

No Color Adjustment

Turns off color management in your printer software so you can manage color using only your application software.

Parent topic: [Selecting Additional Layout and Print Options - Windows](#)

Image Options and Additional Settings - Windows

You can select any of the Image Options and Additional Settings to customize your print. Some options may be pre-selected or unavailable, depending on other settings you have chosen.

Image Options**Emphasize Text**

Adjusts the weight of printed text to increase readability.

Emphasize Thin Lines

Adjusts the weight of printed lines to increase visibility.

Edge Smoothing

Smooths jagged edges in low-resolution images such as screen captures or images from the Web.

Fix Red-Eye

Reduces or removes red-eye in photos.

Print Text in Black

Prints colored text in black.

For Color Text

Prints colored text on a background pattern or underlined.

For Color Graphs and Images

Prints colored graphics and images with overlay patterns.

For Color Text, Graphs, and Images

Prints colored text, graphics, and images with overlay patterns.

Enhancement Options

Specifies Color Universal Print enhancement settings for text, graphics, and images.

Additional Settings Options**Rotate 180°**

Prints the image rotated 180° from its original orientation.

High Speed

Speeds up printing but may reduce print quality.

Mirror Image

Flips the printed image left to right.

Parent topic: [Selecting Additional Layout and Print Options - Windows](#)

Header/Footer Settings - Windows

You can select any of the Header/Footer Settings options to add headers or footers when you print. The items are available to print at the top or bottom of your pages, in either the left, right, or center of the page.

Note: These settings are not saved with your document.

Top Left	Top Center	Top Right
User Name	None	Date/Time
Bottom Left	Bottom Center	Bottom Right
None	None	None

Reset Defaults OK Cancel Help

You can select to print the following information:

- User Name
- Computer Name
- Date
- Date/Time
- Document Name

Note: The user name, computer name, date, and time come from the Windows Control Panel on your computer.

Parent topic: [Selecting Additional Layout and Print Options - Windows](#)

Selecting a Printing Preset - Windows

For quick access to common groups of print settings, you can select a printing preset on the Main or More Options tab.

Note: You can create your own preset by clicking the **Add/Remove Presets** button.

1. Click the **Main** or **More Options** tab.

You see the available **Printing Presets** on the left:

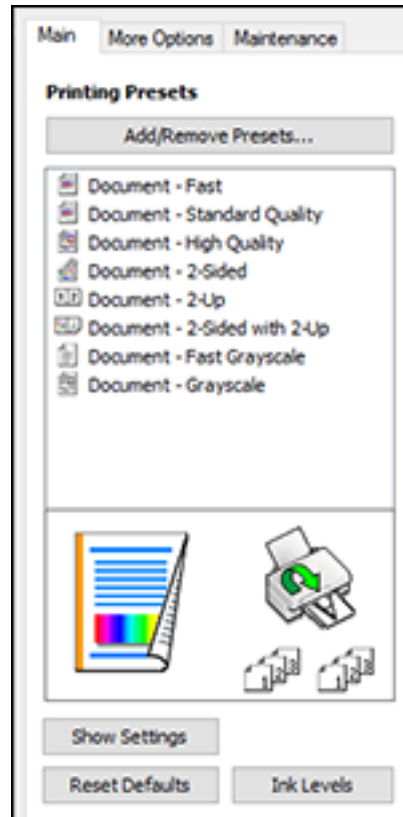

2. Place your cursor over one of the **Printing Presets** to view its list of settings.

3. Click on a preset to change its settings, or use any of the available options on the screen to control your printing presets.
4. To choose a preset for printing, select it.
5. Click **OK**.

Parent topic: [Printing with Windows](#)

Selecting Extended Settings - Windows

You can select additional settings that apply to all the print jobs you send to your product.

1. Access the Windows Desktop and right-click the product icon in the Windows taskbar.
2. Select **Printer Settings**.
3. Click the **Maintenance** tab.

You see the maintenance options:

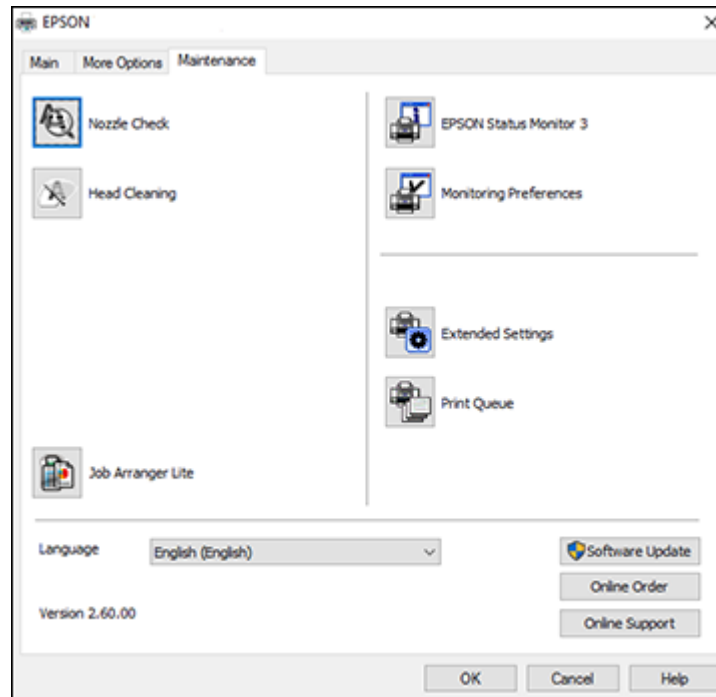

4. Click the **Extended Settings** button.

You see this window:

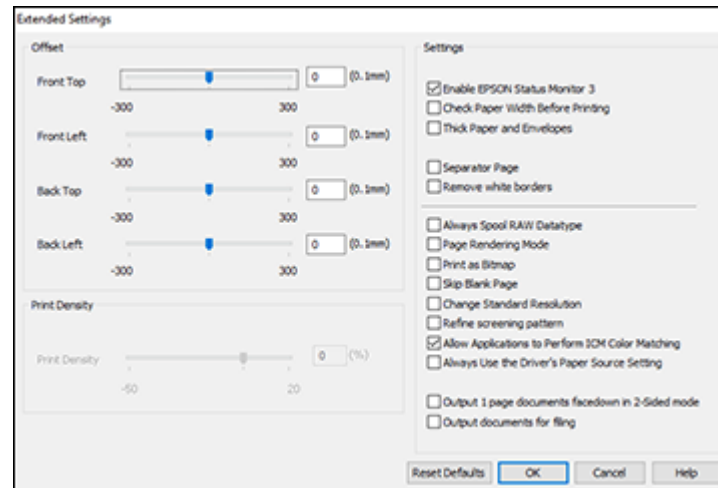

5. Select any of the extended settings to customize your print.
6. Click **OK** to close the Extended Settings window.
7. Click **OK** to close the printer software window.

[Extended Settings - Windows](#)

Parent topic: [Printing with Windows](#)

Extended Settings - Windows

You can select from these settings on the Extended Settings window.

Enable EPSON Status Monitor 3

Enables product monitoring for ink and paper supplies and other issues.

Check Paper Width Before Printing

Prevents printing beyond the edges of the paper if the paper size setting is incorrect; may reduce print speed.

Thick Paper and Envelopes

Prevents ink from smearing when you print on envelopes or other thick paper.

Separator Page

Before each document, prints a separator page containing the title, user, date, and time.

Remove white borders

Removes white margins that may appear when you print borderless photos.

Always Spool RAW Datatype

Increases print speed and may solve other printing problems.

Page Rendering Mode

Increases print speed when printing is extremely slow or the print head stops during printing.

Print as Bitmap

Increases print speed when printing is extremely slow or the print head stops during printing, and other settings do not help.

Skip Blank Page

Ensures that your product does not print pages that contain no text or images.

Change Standard Resolution

Reduces the resolution of print data to correct printing problems.

Refine screening pattern

Prints graphics with a finer screening pattern.

Allow Applications to Perform ICM Color Matching

Allows applications to perform ICM color matching.

Always Use the Driver's Paper Source Setting

Prints using the paper source setting in the printer driver, rather than the setting in your application.

Output 1 page documents facedown in 2-Sided mode

Outputs single-sided pages in a 2-sided print job facedown instead of faceup.

Output documents for filing

Outputs all landscape, portrait, 1-sided, and 2-sided documents in the same orientation for easier filing.

Parent topic: [Selecting Extended Settings - Windows](#)

Printing Your Document or Photo - Windows

Once you have selected your print settings, you are ready to save your settings and print.

1. Click **OK** to save your settings.

You see your application's Print window, such as this one:

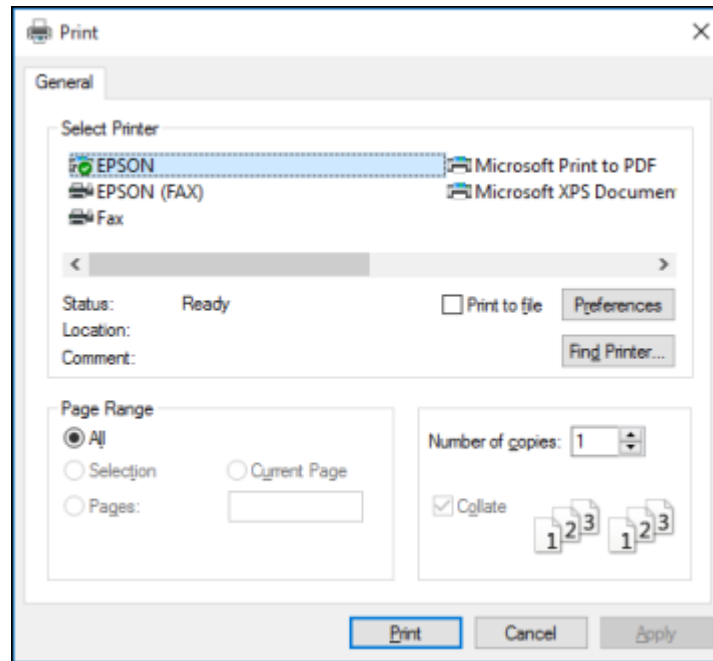

2. Click **OK** or **Print** to start printing.



Parent topic: [Printing with Windows](#)

Locking Printer Settings - Windows

Administrators can lock some printer settings to prevent unauthorized changes.

1. Do one of the following:

- **Windows 10:** Right-click  and select **Control Panel > Hardware and Sound > Devices and Printers**. Right-click your product name and select **Printer properties**.
- **Windows 8.x:** Navigate to the **Apps** screen and select **Control Panel > Hardware and Sound > Devices and Printers**. Right-click your product and select **Printer properties**.

- **Windows 7:** Click  and select **Devices and Printers**. Right-click your product and select **Printer properties**.
- **Windows Vista:** Click  and select **Control Panel**. Click **Printer** under **Hardware and Sound**, then right-click your product and select **Properties**.
- **Windows XP:** Click **Start** and select **Printers and Faxes**. Right-click your product and select **Properties**.

2. Click the **Optional Settings** tab.

Note: You can prevent access to the **Optional Settings** tab by changing the user or group permissions in the **Security** tab.

3. Click **Driver Settings**.

You see this window:

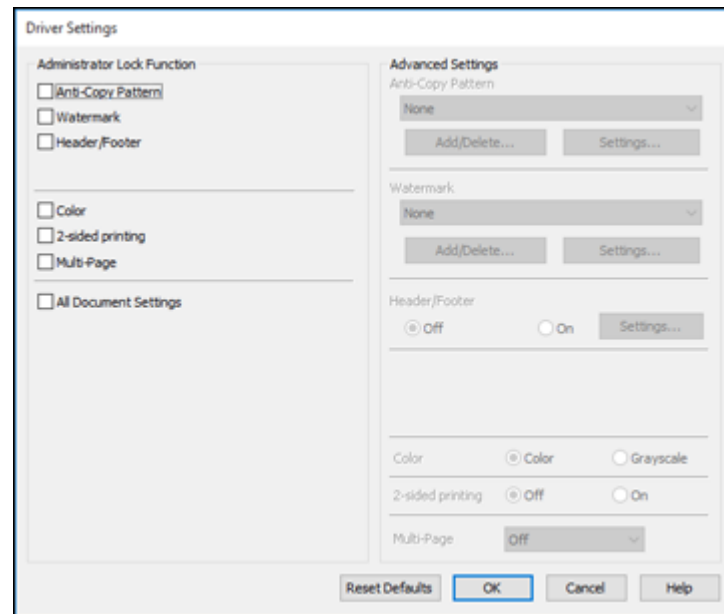

4. Select the checkbox for each setting you want to lock. To lock all print settings, select **All Document Settings**.

5. Under **Advanced Settings**, select the setting option you want to use for each locked setting.
6. Click **OK**.

[Locked Setting Options](#)

Parent topic: [Printing with Windows](#)

Locked Setting Options

Select the options you want to use for any locked print settings.

Setting	Options	Description
Anti-Copy Pattern	Various data items	Lets you select the data to use for the pattern or prohibit anti-copy patterns
	Add/Delete	Lets you add or delete a customized anti-copy pattern
	Settings	Lets you select the arrangement, size, and other settings for the custom anti-copy pattern
Watermark	Various text watermarks	Lets you select the text for the watermark or prohibit watermarks
	Add/Delete	Lets you add or delete a customized text or image-based watermark
	Settings	Lets you select the size, position, color and other watermark settings
Header/Footer	Off	Prohibits headers or footers
	On	Allows headers and footers
	Settings	Lets you select the text and position for printing headers and footers
Color	Color	Allows color printing
	Grayscale	Allows printing in black or shades of gray only
2-sided printing	Off	Allows printing on one side of the paper only
	On	Allows printing on both sides of the paper
Multi-Page	Off	Prohibits multi-page settings
	2-Up	Allows printing of 2 pages on one sheet of paper
	4-Up	Allows printing of 4 pages on one sheet of paper

Parent topic: [Locking Printer Settings - Windows](#)

Selecting Default Print Settings - Windows

When you change your print settings in a program, the changes apply only while you are printing in that program session. If you want to change the print settings you use in all your Windows programs, you can select new default print settings.

1. Access the Windows Desktop and right-click the product icon in the Windows taskbar.
2. Select **Printer Settings**.

You see the printer settings window:

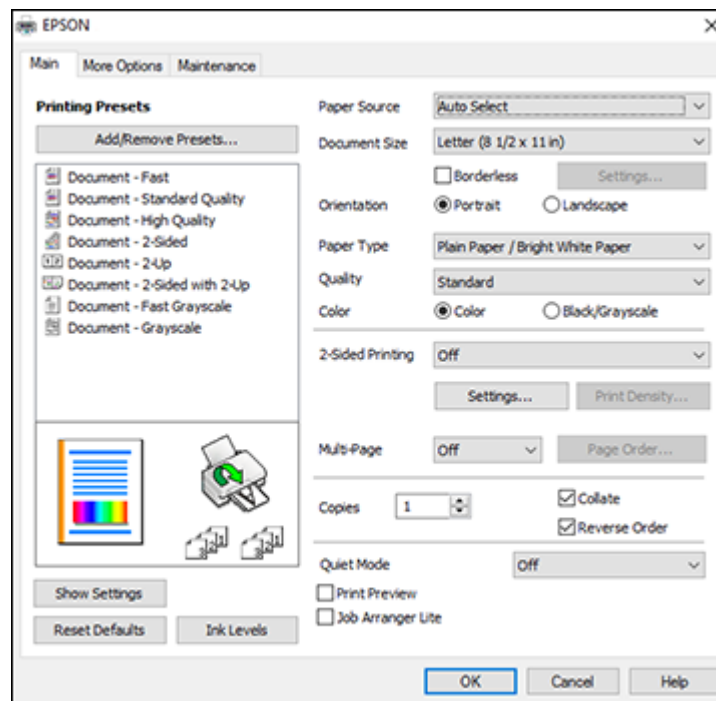

3. Select the print settings you want to use as defaults in all your Windows programs.
4. Click **OK**.

These settings are now the defaults selected for printing. You can still change them as needed for printing in any program session.

Changing the Language of the Printer Software Screens

Parent topic: [Printing with Windows](#)

Changing the Language of the Printer Software Screens

You can change the language used on the Windows printer software screens.

1. Access the Windows Desktop and right-click the product icon in the Windows taskbar.
2. Select **Printer Settings**.

You see the printer settings window.

3. Click the **Maintenance** tab.

You see the maintenance options:

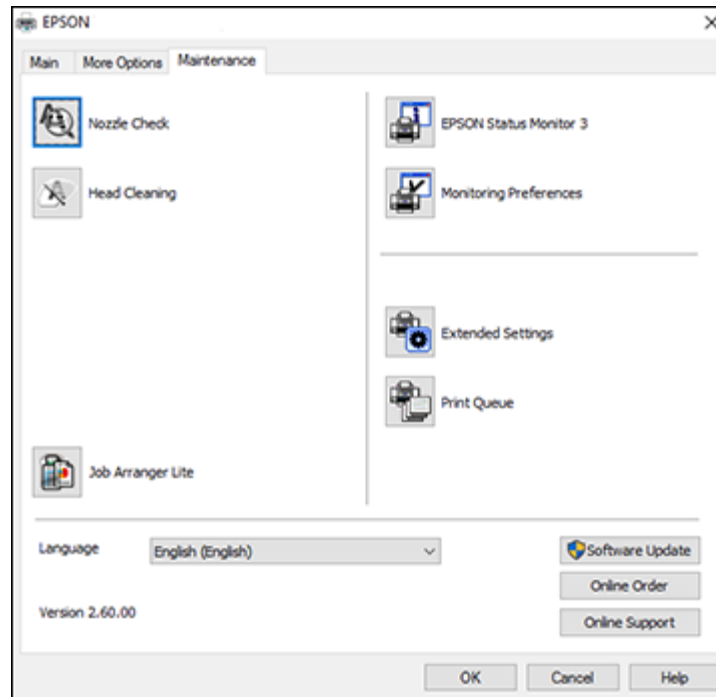

4. Select the language you want to use as the **Language** setting.
5. Click **OK** to close the printer software window.

The printer software screens appear in the language you selected the next time you access them.

Parent topic: [Selecting Default Print Settings - Windows](#)

Changing Automatic Update Options

Your printer software for Windows automatically checks for updates to the product software. You can change how often the software checks for updates or disable this feature.

1. Access the Windows Desktop and right-click the product icon in the Windows taskbar.
2. Select **Software Update Settings**.

You see this window:

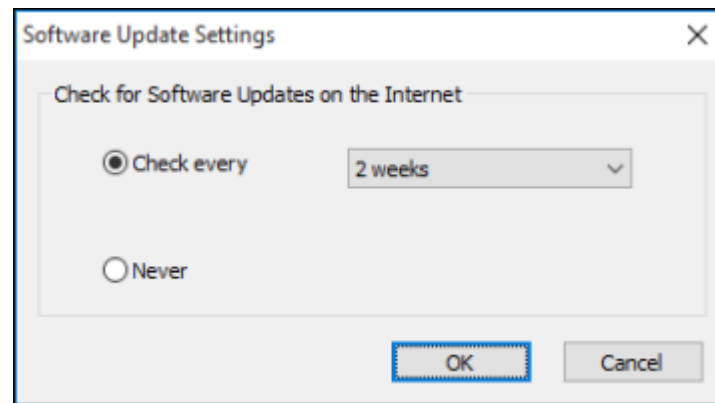

3. Do one of the following:
 - To change how often the software checks for updates, select a setting in the **Check every** menu.
 - To disable the automatic update feature, select the **Never** option.
4. Click **OK** to exit.

Note: If you choose to disable the automatic update feature, you can check for updates manually.

Parent topic: [Printing with Windows](#)

Printing on a Mac

You can print with your product using any Mac printing program, as described in these sections.

Note: If you have an Internet connection, it is a good idea to check for updates to your product software on Epson's support website.

[Selecting Basic Print Settings - Mac](#)

[Selecting Page Setup Settings - Mac](#)

[Selecting Print Layout Options - Mac](#)

[Selecting Double-sided Printing Settings - Mac](#)

[Managing Color - Mac](#)

[Selecting Printing Preferences - Mac](#)

[Printing Your Document or Photo - Mac](#)

Parent topic: [Printing from a Computer](#)

Selecting Basic Print Settings - Mac

Select the basic settings for the document or photo you want to print.

1. Open a photo or document for printing.
2. Select the print command in your application.

Note: You may need to select a print icon on your screen, the **Print** option in the File menu, or another command. See your application's help utility for details.

3. Select your product as the **Printer** setting.

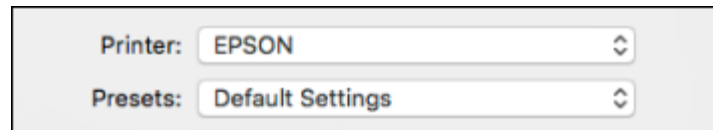

4. If necessary, click the arrow next to the Printer setting or the **Show Details** button to expand the print window.

You see the expanded printer settings window for your product:

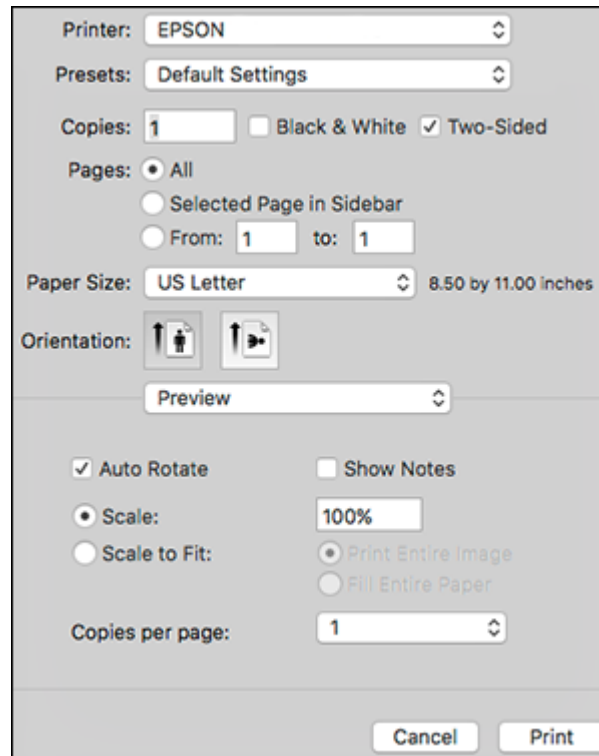

Note: The print window may look different, depending on the Mac OS version and the application you are using.

5. Select the **Copies** and **Pages** settings as necessary.

Note: If you do not see these settings in the print window, check for them in your application before printing.

6. Select the page setup options: **Paper Size** and **Orientation**.

Note: If you do not see these settings in the print window, check for them in your application before printing. They may be accessible by selecting **Page Setup** from the File menu.

7. Select any application-specific settings that appear on the screen, such as those shown in the image above for the Preview application.
8. Select **Print Settings** from the pop-up menu.

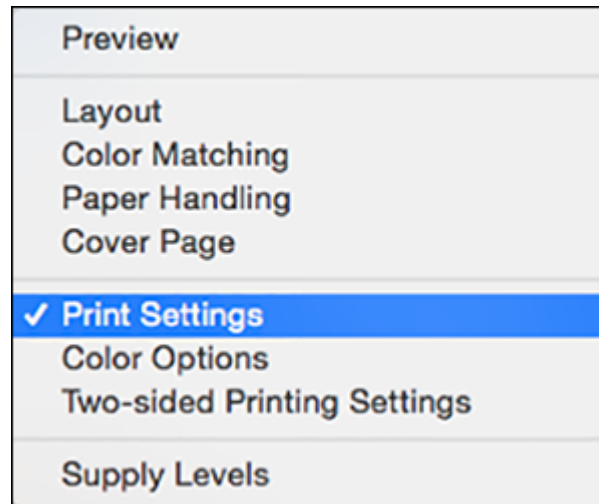

You see these settings:

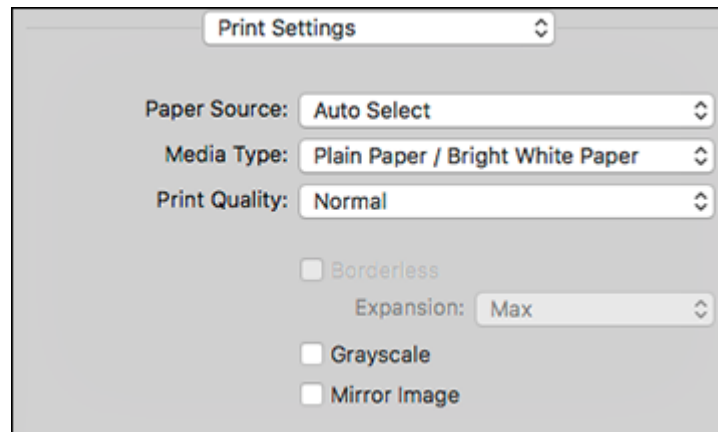

9. Select the **Paper Source** you wish to print from.

10. Select the type of paper you loaded as the **Media Type** setting.

Note: The setting may not exactly match the name of your paper. Check the paper type settings list for details.

11. Select the **Print Quality** setting you want to use.

12. Select any of the available print options.

[Paper Source Options - Mac](#)

[Print Quality Options - Mac](#)

[Print Options - Mac](#)

Parent topic: [Printing on a Mac](#)

Related references

[Paper or Media Type Settings - Printing Software](#)

Related tasks

[Selecting Page Setup Settings - Mac](#)

[Printing Your Document or Photo - Mac](#)

Paper Source Options - Mac

You can select any of the available options in the Paper Source menu to print on the paper loaded in that source.

Auto Select

Automatically selects the paper source based on the selected paper size.

Cassette 1

Selects the paper in cassette 1 as the paper source.

Cassette 2

Selects the paper in cassette 2 as the paper source.

Parent topic: [Selecting Basic Print Settings - Mac](#)

Print Quality Options - Mac

You can select any of the available Print Quality options to fine-tune the quality of your print. Some settings may be unavailable, depending on the paper type setting you have chosen.

Draft

For draft printing on plain paper.

Normal

For everyday text and image printing.

Fine

For text and graphics with good quality and print speed.

Best Quality

For the best print quality, but the slowest print speed.

Parent topic: [Selecting Basic Print Settings - Mac](#)

Print Options - Mac

You can select any of the print options to customize your print. Some options may be unavailable, depending on other settings you have chosen.

Expansion

If you selected a borderless paper size setting, this option adjusts the image expansion settings to control printing at the edges of borderless prints.

Grayscale

Prints text and graphics in black or shades of gray.

Mirror Image

Lets you flip the printed image horizontally.

Note: If you select the **Min** option for the Expansion setting, you may see white borders on your printed photo.

Parent topic: [Selecting Basic Print Settings - Mac](#)

Selecting Page Setup Settings - Mac

Depending on your application, you may be able to select the paper size and orientation settings from the print window.

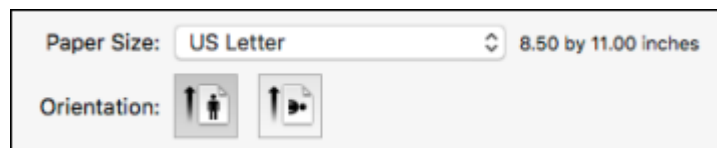

Note: If you do not see these settings in the print window, check for them in your application before printing. They may be accessible by selecting **Page Setup** from the File menu.

1. Select the size of the paper you loaded as the **Paper Size** setting. If you are printing a borderless photo, select the **Borderless** checkbox or a paper size with a **Borderless** option. You can also select a custom setting to create a custom paper size, but the Quality setting will be limited to **Normal**.

Note: You must select a compatible borderless paper type and size to print without borders. Check the borderless paper compatibility list for details.

2. Select the orientation of your document or photo as shown in the print window.

Note: If you are printing an envelope, select the  icon.

Note: You can reduce or enlarge the size of the printed image by selecting **Paper Handling** from the pop-up menu and selecting a scaling option.

Parent topic: [Printing on a Mac](#)

Related references

[Borderless Paper Type Compatibility](#)

Selecting Print Layout Options - Mac

You can select a variety of layout options for your document or photo by selecting **Layout** from the pop-up menu on the print window.

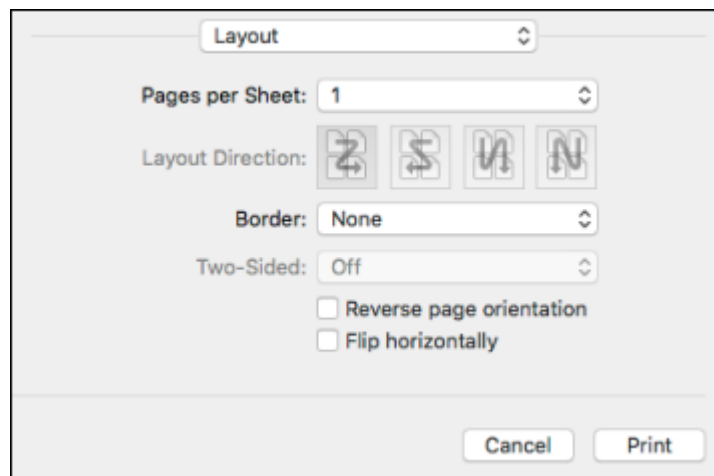

- To print multiple pages on one sheet of paper, select the number of pages in the **Pages per Sheet** pop-up menu. To arrange the print order of the pages, select a **Layout Direction** setting.
- To print borders around each page on the sheet, select a line setting from the **Border** pop-up menu.
- To invert or flip the printed image, select the **Reverse page orientation** or **Flip horizontally** settings.

Parent topic: [Printing on a Mac](#)

Selecting Double-sided Printing Settings - Mac

You can print on both sides of the paper by selecting **Two-sided Printing Settings** from the pop-up menu on the print window.

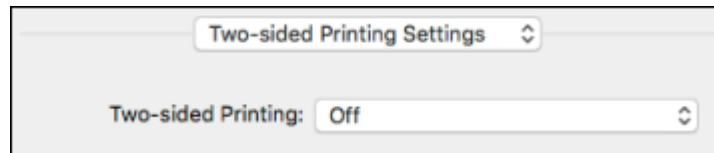

Note: Some options may be pre-selected or unavailable, depending on other settings you have chosen or if you are accessing the product over a network. This screen may be different, depending on the Mac OS version you are using.

1. Select one of the **Two-sided Printing** options.

2. Select the type of document you are printing as the **Document Type** setting. The software automatically sets the Adjustments options for that document type.

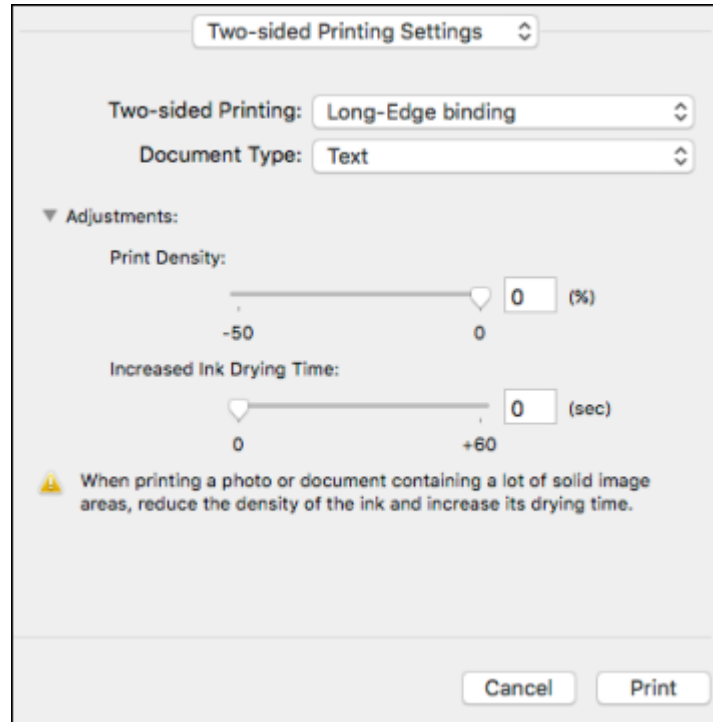

3. If necessary, customize the Adjustments settings as instructed on the screen.
4. Print a test copy of your double-sided document to test the selected settings.
5. Follow any instructions displayed on the screen during printing.

[Double-sided Printing Options and Adjustments - Mac](#)

Parent topic: [Printing on a Mac](#)

Double-sided Printing Options and Adjustments - Mac

You can select any of the available options in the **Two-sided Printing Settings** or **Output Settings** pop-up menu to set up your double-sided print job.

Two-sided Printing Options

Long-Edge binding

Orients double-sided printed pages to be bound on the long edge of the paper.

Short-Edge binding

Orients double-sided printed pages to be bound on the short edge of the paper.

Adjustments

Print Density

Sets the level of ink coverage for double-sided printing.

Increased Ink Drying Time

Sets the amount of time required for drying ink after printing on one side of the paper before printing the other side in double-sided printing.

Parent topic: [Selecting Double-sided Printing Settings - Mac](#)

Managing Color - Mac

You can adjust the Color Matching and Color Options settings to fine-tune the colors in your printout, or turn off color management in your printer software.

1. Select **Color Matching** from the pop-up menu in the print window.

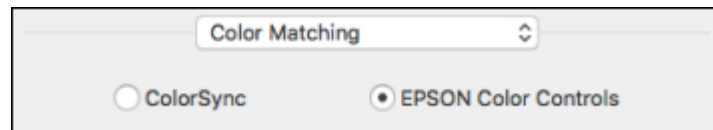

2. Select one of the available options.

3. Select **Color Options** from the pop-up menu in the print window.

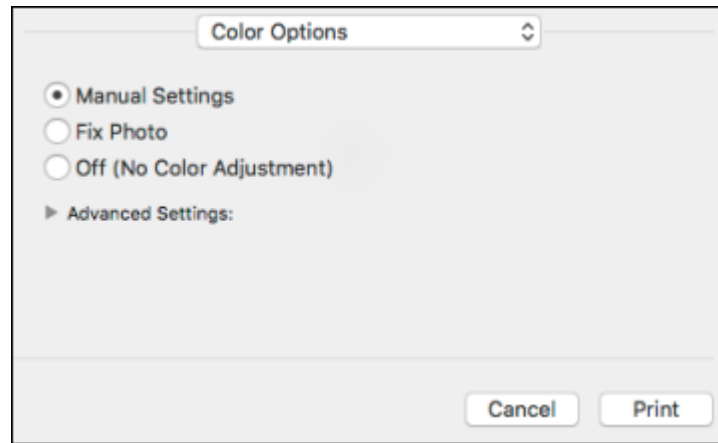

Note: The available settings on the Color Options menu depend on the option you selected on the Color Matching menu.

4. Select one of the available options.

[Color Matching and Color Options - Mac](#)

Parent topic: [Printing on a Mac](#)

Color Matching and Color Options - Mac

You can select from these settings on the **Color Matching** and **Color Options** menus.

Color Matching Settings

EPSON Color Controls

Lets you manage color using controls in your printer software or turn off color management.

ColorSync

Prints using standard color profiles for your product and paper to help match image colors. You can customize the conversion method and filter settings on the ColorSync pop-up menu in the print window.

Color Options Settings

Manual Settings

Lets you select manual color adjustments. Click the arrow next to **Advanced Settings** and select settings for **Brightness**, **Contrast**, **Saturation**, and individual color tones. You can also select a color **Mode** setting for printing photos and graphics and the **Fix Red-Eye** setting to reduce or remove red-eye in photos. Depending on the selected color mode, you can also adjust the midtone density using the **Gamma** setting.

Fix Photo

Improves the color, contrast, and sharpness of flawed photos. Click the arrow next to **Advanced Settings** and select the **Fix Red-Eye** setting to reduce or remove red-eye in photos.

Note: Fix Photo uses a sophisticated face recognition technology to optimize photos that include faces. For this to work, both eyes and the nose must be visible in the subject's face. If your photo includes a face with an intentional color cast, such as a statue, you may want to turn off **Fix Photo** to retain the special color effects.

Off (No Color Adjustment)

Turns off color management in your printer software so you can manage color using only your application software.

Note: An ICC profile is required if color management is turned off.

Parent topic: [Managing Color - Mac](#)

Selecting Printing Preferences - Mac

You can select printing preferences that apply to all the print jobs you send to your product.

1. In the Apple menu or the Dock, select **System Preferences**.
2. Select **Print & Fax**, **Print & Scan**, or **Printers & Scanners**, select your product, and select **Options & Supplies**.
3. Select **Driver** or **Options**.

You see a screen like this:

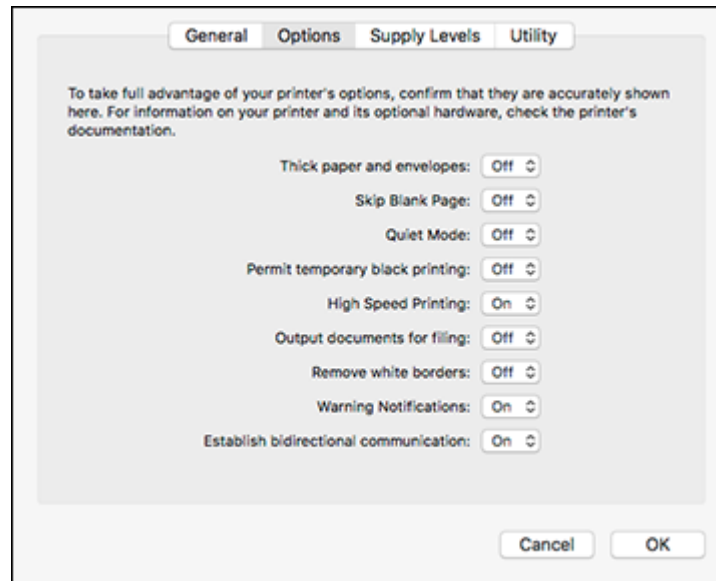

4. Select any of the available printing preferences.
5. Click **OK**.

[Printing Preferences - Mac](#)

Parent topic: [Printing on a Mac](#)

Printing Preferences - Mac

You can select from these settings on the **Options** or **Driver** tab.

Thick Paper and Envelopes

Prevents ink from smearing when you print on envelopes or other thick paper.

Skip Blank Page

Ensures that your product does not print pages that contain no text or images.

Quiet Mode

Lessens noise during printing when you select **Plain Paper/Bright White Paper** as the paper Type or Media Type setting.

Permit temporary black printing

Allows you to print using black ink when color ink is expended.

High Speed Printing

Speeds up printing but may reduce print quality.

Output documents for filing

Outputs all landscape, portrait, 1-sided, and 2-sided documents in the same orientation for easier filing.

Remove white borders

Removes white margins that may appear when you print borderless photos.

Warning Notifications

Lets you choose whether or not to receive warning notifications from the printer software for various operating conditions.

Establish bidirectional communication

Allows the product to communicate with the computer. Do not change the default setting unless you experience issues when using a shared printing pool.

Parent topic: [Selecting Printing Preferences - Mac](#)

Printing Your Document or Photo - Mac

Once you have selected your print settings, you are ready to print.

Click **Print** at the bottom of the print window.

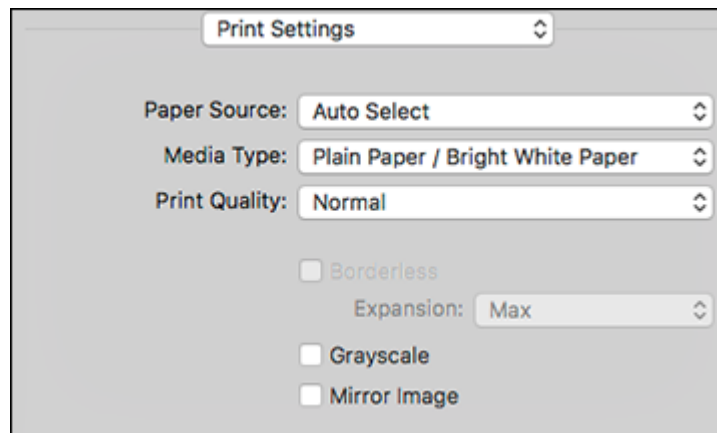

Checking Print Status - Mac

Parent topic: [Printing on a Mac](#)

Checking Print Status - Mac



During printing, you can view the progress of your print job, control printing, and check ink status.

1. Click the printer icon when it appears in the Dock.

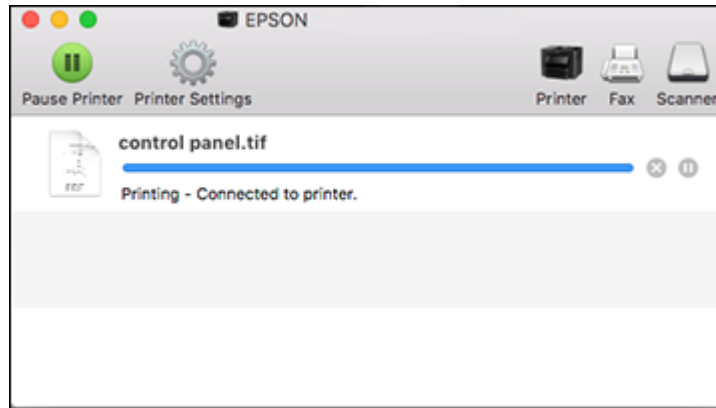
You see the print status window:



2. Select the following options as necessary for your Mac OS version:

- To cancel printing, click the print job and click  or **Delete**.
- To pause a print job, click the print job and click  or **Hold**. To resume a print job, click the paused print job and click  or **Resume**.
- To pause printing for all queued print jobs, click **Pause** or **Pause Printer**.
- To display other printer information, click **Settings** or **Supply Levels**.

Parent topic: [Printing Your Document or Photo - Mac](#)

Printing From a Chromebook

With a Google Account, you can print from a Chromebook without drivers or cables.

1. Connect your Epson product to your wireless network. See the link below.

2. Turn on your Chromebook and connect it to the same wireless network as your product.

Note: See your Chromebook's documentation for details on connecting to a network.

3. Do one of the following:

- Click **Add to Cloud Print** in the notification that appears in the corner of your Chromebook screen.

Note: If you do not see a notification, check to see if a number appears in the status area at the lower-right corner of the screen. Click this number to open the notifications menu, then click **Add to Cloud Print**.

- Open a web browser and enter **chrome://devices** in the address bar. Skip to step 4.
- If you see a registration confirmation screen instead, click **Register**.

4. Click **Add Device**.

5. Click the **Register** button that appears next to your product.

6. Click **Register** on the confirmation screen. Your product's LCD screen displays a confirmation message.

7. Select **OK** or press the **OK** button on your product to confirm the Google Cloud Print connection and print a test page.

8. To print to the connected product, select the print command in your Chrome app.

Your product is now linked to your Google Account and can be accessed from any Chromebook where you are logged in, as long as you have Internet access. Visit [Epson Support for Google Cloud Print \(U.S\)](#) or [Epson Support for Google Cloud Print \(Canada\)](#) for more information on using Google Cloud Print, or the [Google Cloud Print](#) website for a list of [supported apps](#).

Parent topic: [Printing from a Computer](#)

Related tasks

[Using Google Cloud Print](#)

Cancelling Printing Using the Product

If you need to cancel printing, select **Cancel**, then select **Cancel** again to confirm.

Parent topic: [Printing from a Computer](#)

Scanning

You can scan original documents or photos and save them as digital files.

[Starting a Scan](#)

[Scanning with Document Capture Pro or Document Capture](#)

[Scanning in Epson Scan 2](#)

[Scanning Special Projects](#)

[Creating Contacts for Scanning](#)

Starting a Scan

After placing your original documents or photos on your product for scanning, start scanning using one of these methods.

Note: You can also scan using Document Capture Pro (Windows) or Document Capture (Mac).

[Starting a Scan Using the Product Control Panel](#)

[Starting a Scan Using the Epson Scan 2 Icon](#)

[Starting a Scan from a Scanning Program](#)

[Starting a Scan from a Smart Device](#)

Parent topic: [Scanning](#)

Starting a Scan Using the Product Control Panel

You can scan an image to a variety of destinations using your product's control panel.

1. Make sure you installed the product software and connected the product to your computer or network.

Note: Restart your computer after installing the product software to enable scanning from the control panel.

2. Place your original on the product for scanning.

Note: To scan a double-sided or multi-page document, place your originals in the ADF.

3. Press the  home button, if necessary.

4. Select **Scan**.

You see a screen like this:

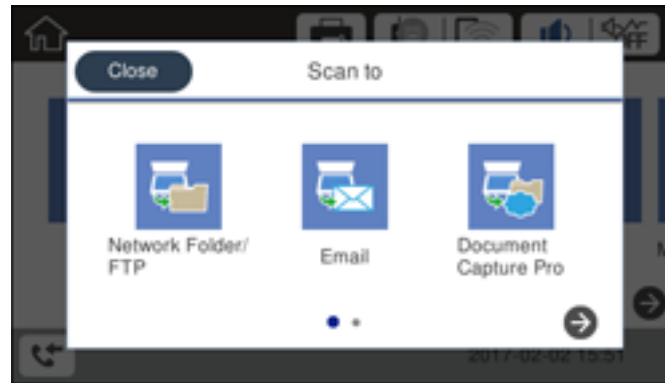

5. Select one of the following **Scan to** options:

- **Network Folder/FTP** saves your scan file to a specified folder on a network.
- **Email** lets you send scanned files through a pre-configured email server.
- **Document Capture Pro** lets you scan over a network using your saved job settings in Document Capture Pro or Document Capture.

Note: You cannot use this option to scan an image to Document Capture or Document Capture Pro when your product is connected to your computer's USB port.

- **Memory Device** saves your scan file on a USB device and lets you select the file format, quality, and other settings.
- **Cloud** sends your scanned files to a destination that you have registered with Epson Connect.
- **Computer (WSD)** lets you manage network scanning in Windows 10, Windows 8.x, Windows 7, or Windows Vista (English only). To use this feature, you must first set up WSD (Web Services for Devices) on the computer.

6. Follow the instructions in the next sections to complete your scan.

[Scanning to Email](#)

[Scanning to a Network Folder or FTP Server](#)

[Adding and Assigning Scan Jobs with Document Capture Pro or Document Capture](#)

[Control Panel Scanning Options](#)

Parent topic: [Starting a Scan](#)

Related tasks

[Using Presets](#)

[Entering Characters on the LCD Screen](#)

[Using Epson Scan to Cloud](#)

[Adding and Assigning Scan Jobs with Document Capture Pro or Document Capture](#)

Related topics

[Placing Originals on the Product](#)

Scanning to Email

You can scan an original and email the scanned file using your product's control panel. You need to have a preconfigured email server before you can scan to email. You can either enter the email address directly on the product's control panel or select an address from the **Contacts** list. Make sure the date and time are set correctly so the time stamps on your emails are accurate.

Note: You can also use the Scan to Document Capture Pro function to scan and email the scanned file.

1. Place your original on the product for scanning.

Note: To scan a double-sided or multi-page document, place all of the pages in the ADF.

2. Press the  home button, if necessary.
3. Select **Scan**.

You see a screen like this:

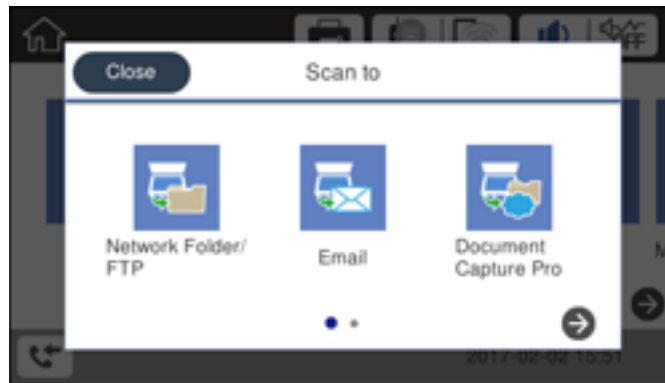

4. Select **Email**.

You see a screen like this:

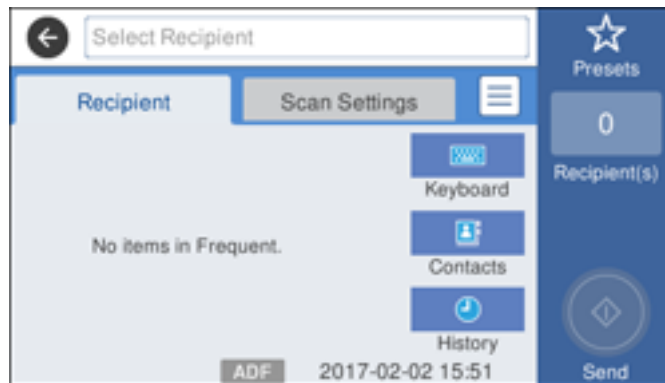

5. Do one of the following:
 - Select **Contacts** and choose an email address from the **Contacts** list.
 - Select **Keyboard** to use the displayed keyboard to enter the address for the recipient and press **OK**.
 - Select **History** to choose an email address from your recent scan history.

- Select an email address from any displayed frequent contacts.
6. Select **Scan Settings**.
 7. Select **File Format** to choose the file format for your scan.
 8. Scroll down and change the **Subject** and **File Name settings** if necessary.
 9. Select any additional scan settings as necessary.
 10. Select **Presets** to save your scan settings.
 11. Press the **Send** icon.

Your product scans your original and emails the scanned file.

Parent topic: [Starting a Scan Using the Product Control Panel](#)

Related tasks

[Entering Characters on the LCD Screen](#)

[Creating Contacts for Scanning](#)

[Selecting the Date and Time](#)

[Configuring Email Server Settings](#)

Related topics

[Placing Originals on the Product](#)

Scanning to a Network Folder or FTP Server

You can scan an image and save it to a network folder using your product's control panel. You can either enter the folder path directly on the product's control panel or select a folder from the **Contacts** list.

Note: Make sure the date and time are set correctly before using this feature.

1. Place your original on the product for scanning.

Note: To scan a double-sided or multi-page document, place your originals in the ADF.

2. Press the  home button, if necessary.
3. Select **Scan**.

You see a screen like this:

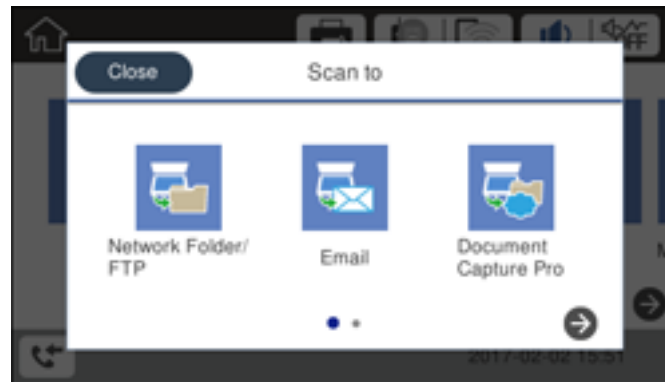

4. Select **Network Folder/FTP**.

You see a screen like this:

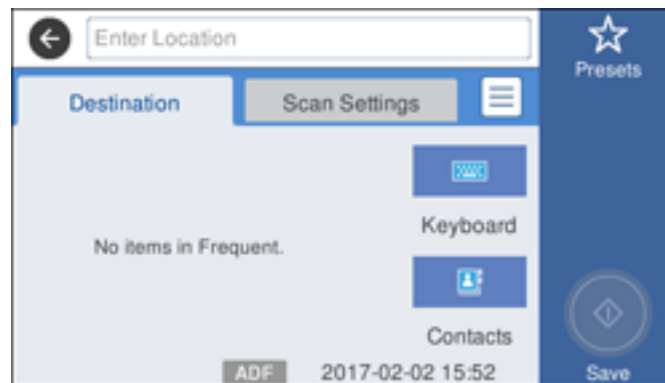

5. Do one of the following:
 - Select **Contacts** and choose a saved location from the **Contacts** list.
 - Select **Keyboard**, then select the **Communication Mode** field and select **Network Folder (SMB)** or **FTP**. Then select the **Location** field and enter the folder location, and press **OK**. Enter other information as necessary.

Enter the folder path name for the **Location** setting in one of the following formats depending on the **Communication Mode** setting you selected:

- **SMB:** \\host name\folder
- **FTP:** ftp://host name/folder name
- Select an email address from any displayed frequent contacts.

6. Select **Scan Settings**.
7. Select **File Format** to choose the file format for your scan.
8. Scroll down and select **File Settings**. Change the **File Name** if necessary.
9. Select any additional scan settings as necessary.
10. Select **Presets** to save your scan settings.
11. Select **Save**.

Your product scans your original and saves it in the selected location.

Parent topic: [Starting a Scan Using the Product Control Panel](#)

Related tasks

[Entering Characters on the LCD Screen](#)

[Creating Contacts for Scanning](#)

[Selecting the Date and Time](#)

Related topics

[Placing Originals on the Product](#)

Adding and Assigning Scan Jobs with Document Capture Pro or Document Capture

You can view, change, or add available default scan settings when you scan using the Document Capture Pro option on the product control panel. You do this by accessing the scan jobs in the Document Capture Pro (Windows) or Document Capture (Mac) program.

1. Start Document Capture Pro or Document Capture on a computer connected to the product.
2. Click the  Manage Job icon from the toolbar at the top of the window.
You see a window showing the current scan job list.
3. If you want to add a scan job, click **Add** or the **+** icon, enter a name for the new job, select settings as necessary, and click **OK**.

You can now use the new scan job when you scan with Document Capture Pro or Document Capture.

Note: See the Help information in Document Capture Pro or Document Capture for details.

4. If you want to assign scan jobs to the selection list on the product control panel, do one of the following:
 - **Windows:** Click **Event Settings**.
 - **Mac:** Click the  icon at the bottom of the window, then click **Event Settings**.
5. Select the jobs that you want to assign to any of the pull-down menus.

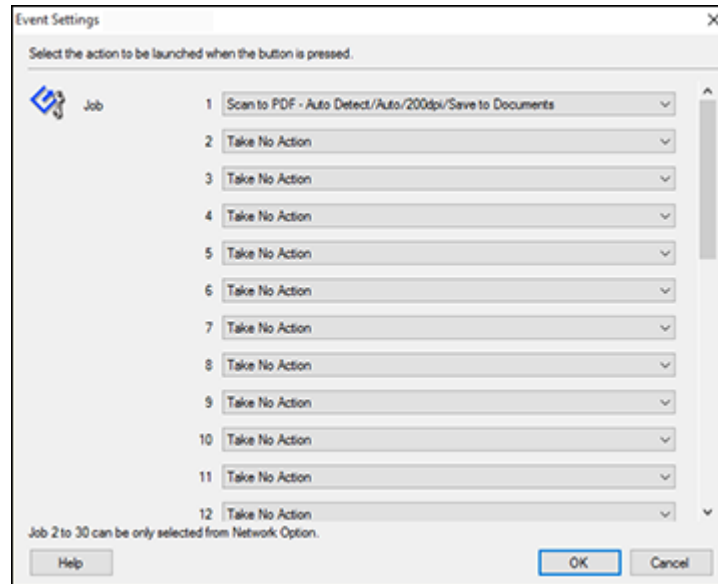

You can now use the added scan jobs when you scan from the product control panel.

6. Click **OK**, then click **OK** again.

Parent topic: [Starting a Scan Using the Product Control Panel](#)

Related tasks

[Scanning with Document Capture Pro or Document Capture](#)

Control Panel Scanning Options

Select the options you want to use for scanning.

Note: Not all options or settings may be available, depending on the **Scan to** option selected.

Scan to setting	Available options	Description
Edit Location	Communication Mode	Lets you select Network Folder (SMB) or FTP
	Location	Lets you enter a folder path in which to save scanned images
	User Name	Lets you enter a user name for the selected folder path
	Password	Lets you enter a password for the selected folder path
	Connection Mode	Lets you select the connection mode
	Port Number	Lets you enter a port number
Contacts	—	Select an email address or folder path to send or save scanned images
Color Mode	Color	Select whether to scan images in color or black and white
	B&W	
File Format	JPEG	Select for photos. You can also select the Compression Ratio .
	PDF	Select for documents. You can also select the Compression Ratio and PDF Settings .
	TIFF (Single Page)	Select for scanned files that you can print from a device. Multi Page TIFF documents are scanned in black and white.
	TIFF (Multi Page)	
Resolution	200dpi	Select for documents
	300dpi	Select for photos
	600dpi	Select for highest quality printing
2-Sided	Off	Lets you scan 2-sided originals placed in the ADF. If you select On , you can also select the Binding Direction .
	On	



Scan to setting	Available options	Description
Scan Area	Letter	Select the page size for documents, then select the orientation of the original
	A4	
	Legal	
	Half Letter	
	Envelope #10	
	5 × 7	
	4 × 6	
	8 × 10	
	Auto Cropping	
	Max Area	Select for most photos
Original Type	Text	Specifies the type of original you are scanning
	Text & Image	
	Photo	
Density	-4 to +4	Adjusts the lightness or darkness of scanned images.
Remove Shadow	On	Erases the shadows that appear in the center of a document when copying a book or the shadows that appear around a document when copying thick paper
	Off	
Remove Punch Holes	On	Erases the binding holes on a document
	Off	
Subject	—	Lets you enter a subject for your email
Attached File Max Size	Various sizes	Lets you select the maximum file size that can be attached to an email
File Name	—	Lets you enter a prefix, the date, and the time to the file name for your scanned file

Note: When you turn on password settings, you can use the LCD screen keyboard to set the password.

Parent topic: [Starting a Scan Using the Product Control Panel](#)

Starting a Scan Using the Epson Scan 2 Icon

You can start the Epson Scan 2 program to select scan settings, scan, and save the scanned image to a file.

- **Windows 10:** Click  and select **All apps > EPSON > Epson Scan 2**.
- **Windows 8.x:** Navigate to the **Apps** screen and select **Epson Scan 2**.
- **Windows (other versions):** Click  or **Start**, and select **All Programs** or **Programs**. Select **EPSON > Epson Scan 2 > Epson Scan 2**.
- **Mac:** Open the **Applications** folder, open the **Epson Software** folder, and select **Epson Scan 2**.

You see an Epson Scan 2 window like this:

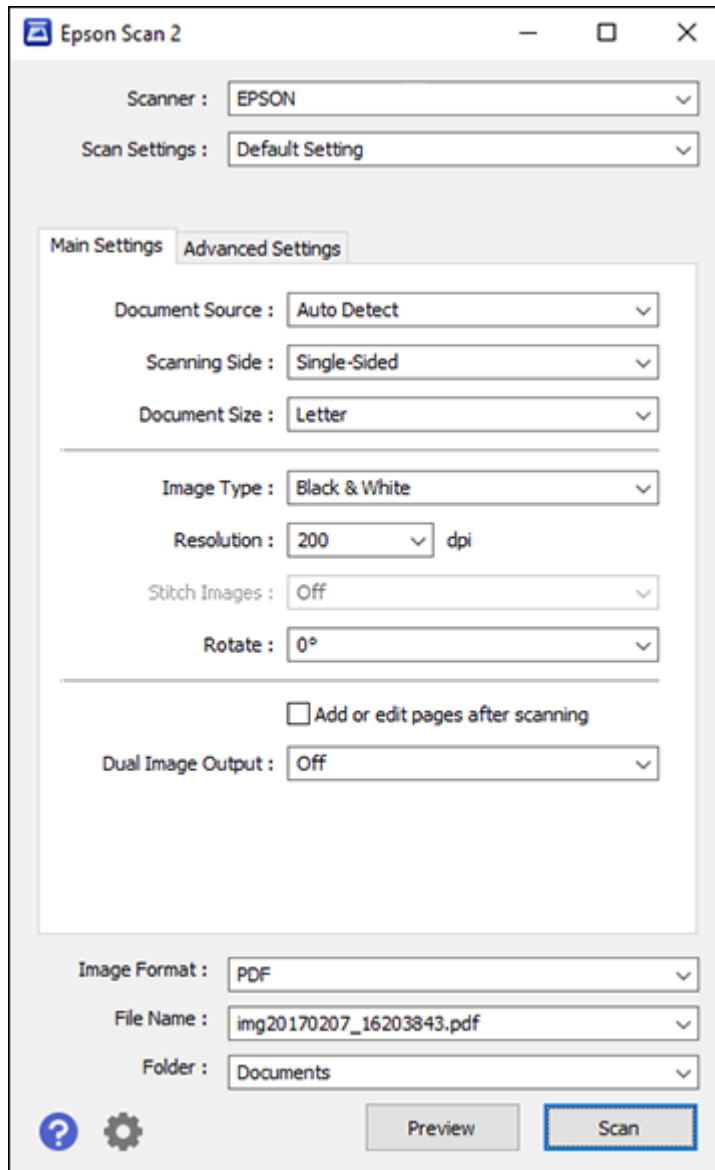

Parent topic: [Starting a Scan](#)

Starting a Scan from a Scanning Program

You can start Epson Scan 2 from a TWAIN-compliant scanning program to select scan settings, scan, and open the scanned image in the program.

1. Open your scanning program and select its scanning option. (See your scanning program help for instructions.)
2. Select your product.

Note: In certain programs, you may need to select your product as the "source" first. If you see a **Select Source** option, choose it and select your product. With Windows, do not select a **WIA** option for your product; it will not work correctly.

You see an Epson Scan 2 window like this:

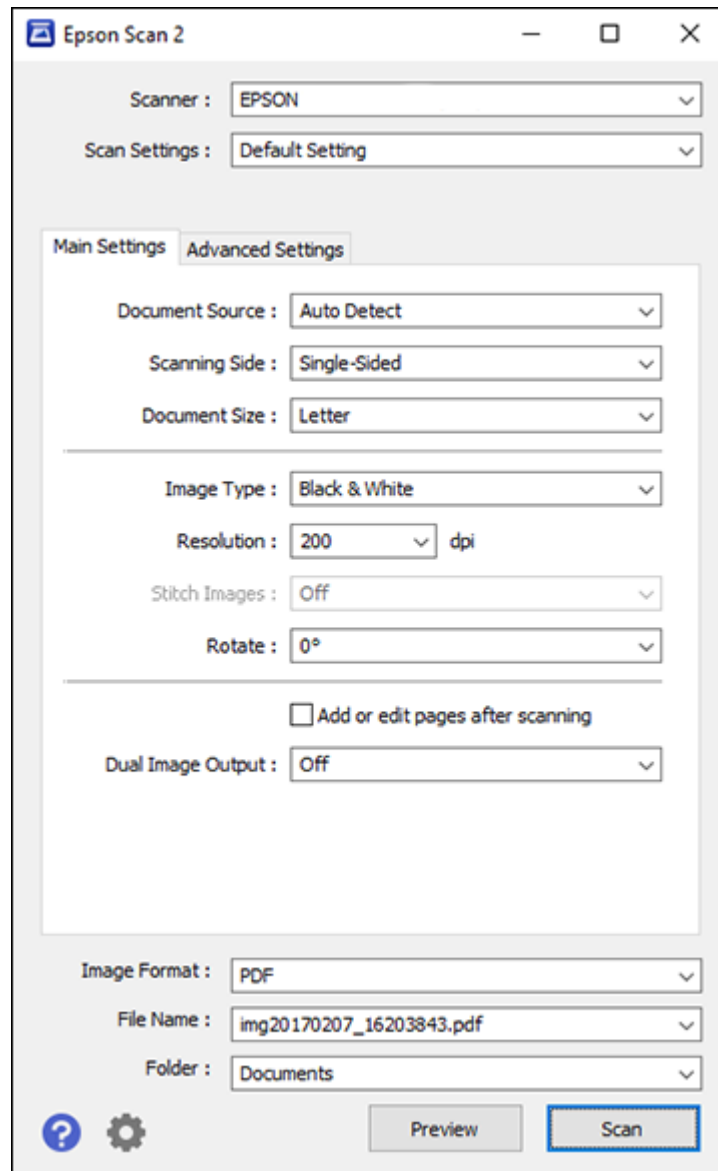

Parent topic: [Starting a Scan](#)

Starting a Scan from a Smart Device

You can start a scan from a smart device using the Epson iPrint app. You can save the scanned document to your device or a cloud service, e-mail it, or print it.



Note: Your device must be connected to the same wireless network as your Epson product. If you have an NFC-enabled device, you can also scan with the Epson iPrint app by placing the device against the NFC mark on the front of the product.

1. Download the Epson iPrint app from your device's app store or from Epson's website.
2. Place your original on the scanner.
3. Open the Epson iPrint app and select your product.
4. Select the scan settings and scan your original.
5. Save your scanned image to a file or cloud location.

Parent topic: [Starting a Scan](#)

Scanning with Document Capture Pro or Document Capture

When you scan with Document Capture Pro (Windows) or Document Capture (Mac), the program automatically saves your scanned file on your computer in the folder you specify. You can select settings, preview, and change the scanned file settings as necessary.

1. Do one of the following to start Document Capture Pro or Document Capture:
 - **Windows 10:** Click  and select **All apps**. Select **EPSON Software**, then select **Document Capture Pro**.
 - **Windows 8.x:** Navigate to the **Apps** screen and select **Document Capture Pro**.
 - **Windows (other versions):** Click  or **Start**, and select **All Programs** or **Programs**. Select **EPSON Software**, then select **Document Capture Pro**.
 - **Mac:** Open the **Applications** folder, select the **Epson Software** folder, and select **Document Capture**. Select your product and click **OK**, if necessary.

You see a window like this:

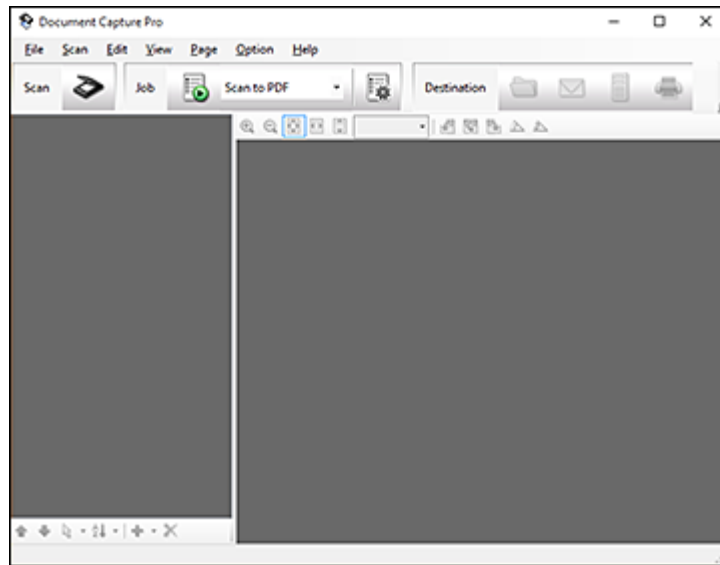

2. Click the  Scan icon.

You see a window like this:

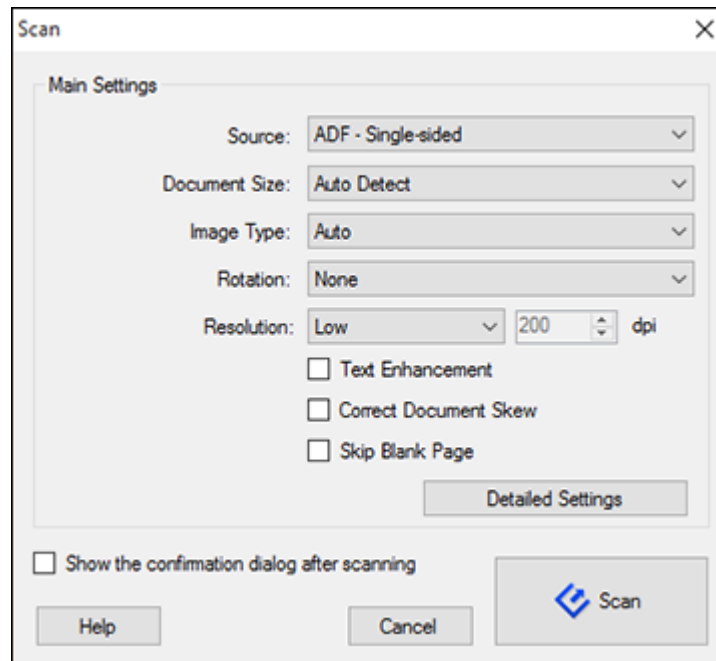

3. If you want to use a scan job that you created instead, select it from the Job list in the Document Capture Pro or Document Capture window, click the  Start Job button, and skip the rest of these steps.
4. Select any displayed scan settings you want to use.

Note: See the Help information in Document Capture Pro or Document Capture for details.

5. If you want to select detailed scan settings, do one of the following:
 - **Windows:** Click **Detailed Settings**. Select any displayed scan settings you want to use and click **OK**.
 - **Mac:** If you installed Epson Scan, close the Scan Settings window, open the **Scan** menu at the top of the screen and select **Displays the EPSON Scan Setup Screen**. Click the  Scan icon. Select any displayed scan settings you want to use and click **OK**.

6. Click **Scan**.

You see a preview of your scan in the Document Capture Pro or Document Capture window.

7. Check the scanned images and edit them as necessary.
8. Click one of the Destination icons to choose where to save your scanned file.



Note: You may need to click the arrow next to the icons in order to see all of them. The available icons may vary, depending on the software version you are using.

9. Select settings as necessary, then click **OK**, **Send**, or **Print** to save the scanned file.

Parent topic: [Scanning](#)

Scanning in Epson Scan 2

Epson Scan 2 automatically scans your document and saves the scanned file in PDF format in your operating system's Documents or My Documents folder, or opens it in your scanning program. You can select settings, preview, and change the scanned file settings as necessary.

1. Start Epson Scan 2.

You see this window:

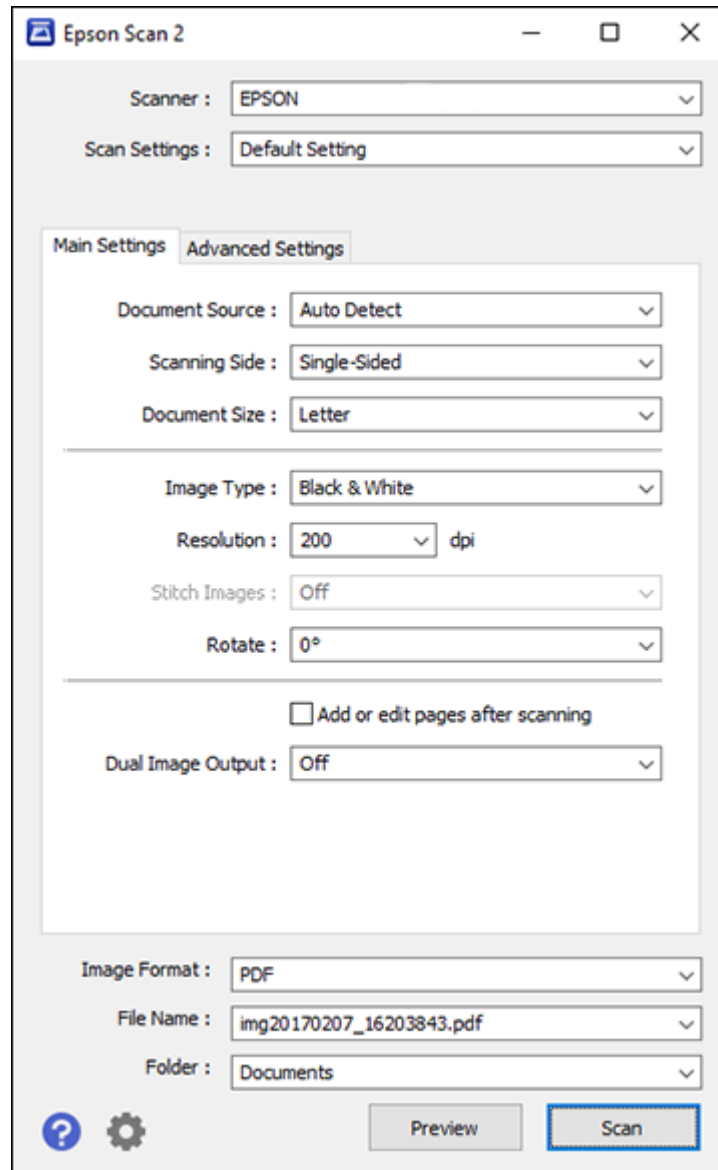

2. Select the **Document Source** setting that matches where you placed your original.
3. Select the **Scanning Side** setting if you are scanning from the ADF.
4. Select the **Document Size** setting that matches the size of your original, or select **Auto Detect** to have Epson Scan 2 automatically detect the size. You can select **Customize** to enter a custom size, if necessary.
5. Select your original image type and how you want it scanned as the **Image Type** setting.
6. Select the **Resolution** setting you want to use for your scan.
7. Click the **Preview** button.

Epson Scan 2 previews your original and displays the results in the Epson Scan 2 window.

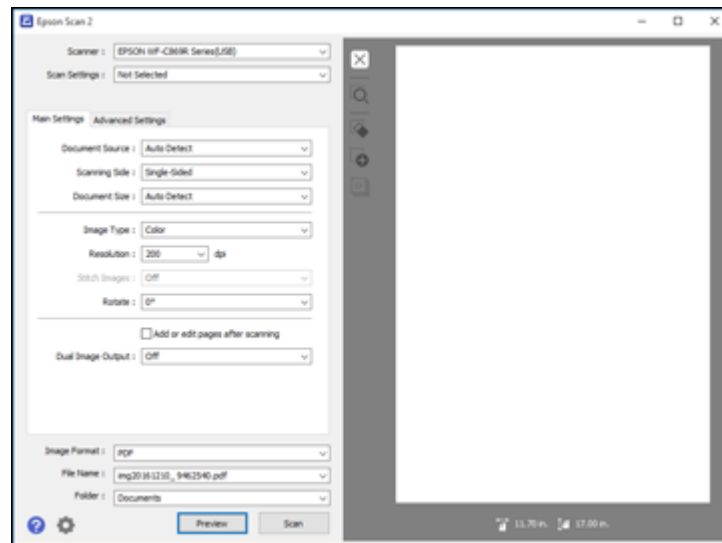

8. Reinsert your original into the ADF, if necessary.
9. Select any of the additional settings that you want to use on the Main Settings tab.
10. Click the **Advanced Settings** tab and select any settings that you want to use.
11. Select the format in which you want to save your scanned file as the **Image Format** setting. If necessary, select **Options** and select any desired format options.
12. Enter the file name for your scanned file in the **File Name** field. If necessary, select **Settings** to modify the file name settings.

13. Select the location in which you want to save your scanned file as the **Folder** setting. If necessary, select **Select** to create a new folder.
14. Click **Scan**.

The product scans your original and saves the scanned file in the location you specified.

[Additional Scanning Settings - Main Settings Tab](#)

[Additional Scanning Settings - Advanced Settings Tab](#)

[Saving Scanned Documents as a Searchable PDF](#)

[Image Format Options](#)

[Scan Resolution Guidelines](#)

Parent topic: [Scanning](#)

Additional Scanning Settings - Main Settings Tab

You can select these additional scanning settings on the Epson Scan 2 Main Settings tab. Not all adjustment settings may be available, depending on other settings you have chosen.

Dual Image Output

Scans the original image twice using different output settings (Windows only).

Add or edit pages after scanning

When scanning multi-page originals, select the checkbox to add additional pages or add and edit the pages in a job and save all of the scanned pages as one file.

Note: You must select a file format that supports multi-page such as **PDF** or **Multi-TIFF**.

Parent topic: [Scanning in Epson Scan 2](#)

Additional Scanning Settings - Advanced Settings Tab

You can select these additional scanning settings on the Epson Scan 2 Advanced Settings tab. Not all adjustment settings may be available, depending on other settings you have chosen.

Text Enhancement

Sharpens the appearance of letters in text documents.

Auto Area Segmentation

Makes black and white images clearer and text recognition more accurate by separating the text from the graphics.

Threshold

Adjusts the level at which black areas in text and line art are delineated, improving text recognition in OCR (Optical Character Recognition) programs.

Color Enhance

Enhances the shades of the color you select in the scanned image. This setting is available only if you select **Grayscale** or **Black & White** as the Image Type setting.

Brightness

Adjusts the overall lightness and darkness of the scanned image.

Contrast

Adjusts the difference between the light and dark areas of the overall scanned image.

Gamma

Adjusts the midtone density of the scanned image.

Unsharp Mask

Makes the edges of certain image areas clearer. Turn off this option to leave softer edges.

Descreening

Removes the ripple pattern that might appear in subtly shaded image areas, such as skin tones. This option improves results when scanning magazines or newspapers. (The results of descreening do not appear in the preview image, only in your scanned image.)

Skip Blank Pages

If the scanner detects marks from the other side of a blank page and adds the marks to the scanned image, adjust this setting to prevent this.

Edge Fill

Corrects shadowing around the edges of the image by filling the shadows with black or white.

Correct Document Skew

Corrects skewed originals, image contents, or both.

Parent topic: [Scanning in Epson Scan 2](#)

Saving Scanned Documents as a Searchable PDF

You can scan a document and save the text in a searchable PDF. In a searchable PDF, text is recognized using Optical Character Recognition (OCR) and then embedded in the scanned original.

Note: The required Epson Scan 2 OCR Component is installed automatically when you install your product software as instructed on the *Start Here* sheet. If you install your scanner software programs individually, be sure to also install this component if you want to perform OCR.

1. Load your original in the product.
2. Start Epson Scan 2.
3. Select your scan settings.
4. Click **Preview** and adjust the area you want to scan, if necessary.
5. If you are using the ADF, reload the ejected original.
6. Select **Searchable PDF** as the Image Format setting.
7. Select **Options** from the Image Format list.
You see the Image Format Options window.
8. Select the **Text** tab.
9. Make sure the language used in the document text is selected as the **Text Language** setting.
10. Click **OK**.
11. Confirm the File Name setting and select a **Folder** setting for your document.
12. Click **Scan**.

The scanned image is saved as a searchable PDF.

Parent topic: [Scanning in Epson Scan 2](#)

Image Format Options

You can select different image formats and related options. For details on available options, click the ? icon on the Epson Scan 2 Image Format Options window. Not all image formats have options.

Bitmap (*.bmp)

A standard image file format for most Windows programs.

JPEG (*.jpg)

An image format that lets you highly compress image data. However, the higher the compression, the lower the image quality. (The TIFF format is recommended when you need to modify or retouch your scanned image.)

PNG (*.png)

An image format that does not lose quality during editing.

TIFF (*.tif)

A file format created for exchanging data between many programs, such as graphic and DTP software.

Multi-TIFF (*.tif)

A TIFF file format when multiple pages are saved to the same file, allowing you to edit the images using a compatible program.

PDF (*.pdf)

A document format that is readable by Windows and Mac systems using Adobe Reader, Acrobat, or other programs. You can save multi-page documents in one PDF file.

Searchable PDF (*.pdf)

A document format that is readable by Windows and Mac systems using Adobe Reader, Acrobat, or other programs. You can save multi-page documents in one PDF file. Recognized text in the scanned document can be searched.

Parent topic: [Scanning in Epson Scan 2](#)

Scan Resolution Guidelines

The **Resolution** setting, measured in dpi (dots per inch), controls the amount of detail captured in your scans. Increasing the resolution raises the amount of detail captured but comes with the following disadvantages:

- Larger file sizes
- It takes longer to scan your originals, send/receive your scans by email or fax, and to print your scans
- The image may become too large to fit on your display or print on paper

If you plan to enlarge a scanned image so you can print it at a larger size, you may need to increase the resolution from the default resolution set by Epson Scan 2. Follow these guidelines to determine the resolution setting you need:

- You will scan the image at its original size but enlarge it later in an image-editing program.

Increase the Epson Scan 2 Resolution setting in your scan. Increase the resolution by the same amount you will increase the image size to retain a high image quality. For example, if the resolution is 300 dpi (dots per inch) and you will double the image size later, change the Resolution setting to 600 dpi.

- You will scan the image at 100% or smaller size.

Select the Epson Scan 2 Resolution setting based on how you will use the scanned image:

- Email/view on a computer screen/post on the web: 96 to 200 dpi
- Print/fax/convert to editable text (OCR)/create searchable PDF: 200 to 300 dpi

Parent topic: [Scanning in Epson Scan 2](#)

Scanning Special Projects

Your product's scanning software offers various options to help you quickly complete special scan projects.



[Scanning to a SharePoint Server or Cloud Service](#)

[Scanning Multi-Page Originals as Separate Files](#)

Parent topic: [Scanning](#)

Scanning to a SharePoint Server or Cloud Service

You can use Document Capture Pro to upload scanned images to a SharePoint server or a cloud service.



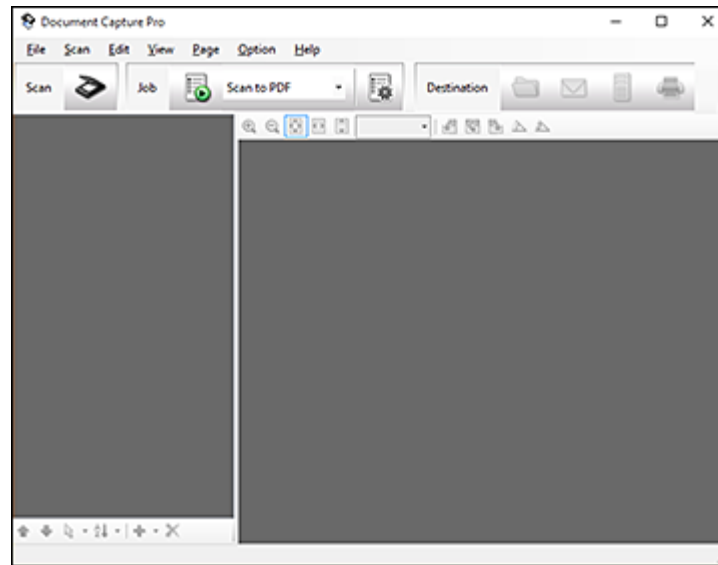

1. Do one of the following to start Document Capture Pro:
 - **Windows 10:** Click  and select **All apps**. Select **EPSON Software**, then select **Document Capture Pro**.
 - **Windows 8.x:** Navigate to the **Apps** screen and select **Document Capture Pro**.
 - **Windows (other versions):** Click  or **Start**, and select **All Programs** or **Programs**. Select **EPSON Software**, then select **Document Capture Pro**.
 - **Mac:** Open the **Applications** folder, select the **Epson Software** folder, and select **Document Capture**. Select your product and click **OK**, if necessary.

You see a window like this:



2. Click the  **Scan** icon.
3. Select any displayed scan settings you want to use.

Note: See the Help information in Document Capture Pro or Document Capture for details.

4. Click **Scan**.
You see a preview of your scan in the Document Capture Pro or Document Capture window.
5. Click one of the cloud service Destination icons to choose where to save your scanned file.
 -  Web Folder (WebDAV)
 -  Evernote (Windows only)
 -  Google Drive
 -  SugarSync



- Microsoft SharePoint server (Windows only)

Note: You may need to click the arrow next to the icons in order to see all of them. The available icons may vary, depending on the software version you are using.

6. Select your Destination settings.

Note: The settings may vary, depending on the software version you are using. See the Help information in Document Capture Pro or Document Capture for details.

7. Select any other scan settings as necessary, and click **Send**.

Your originals are scanned and uploaded to the indicated server.

Note: You can also create a scan job for uploading scanned images to a SharePoint server or a cloud service. You can use the scan job when you scan with Document Capture Pro or Document Capture or when you scan using the Document Capture Pro option on the product control panel.

Parent topic: [Scanning Special Projects](#)

Scanning Multi-Page Originals as Separate Files

You can use Document Capture Pro (Windows only) to scan multi-page originals as separate scanned files. You indicate where you want the new scanned files to start by inserting a blank page or barcode between the pages of your original.

Note: The settings may vary, depending on the software version you are using. See the Help information in Document Capture Pro for details.

1. Load a multi-page original with blank pages or barcodes inserted where you want to start a new scanned file.
2. Do one of the following to start Document Capture Pro:
 - **Windows 10:** Click  and select **All apps**. Select **EPSON Software**, then select **Document Capture Pro**.
 - **Windows 8.x:** Navigate to the **Apps** screen and select **Document Capture Pro**.

- **Windows (other versions):** Click  or **Start**, and select **All Programs** or **Programs**. Select **EPSON Software**, then select **Document Capture Pro**.

You see this window:

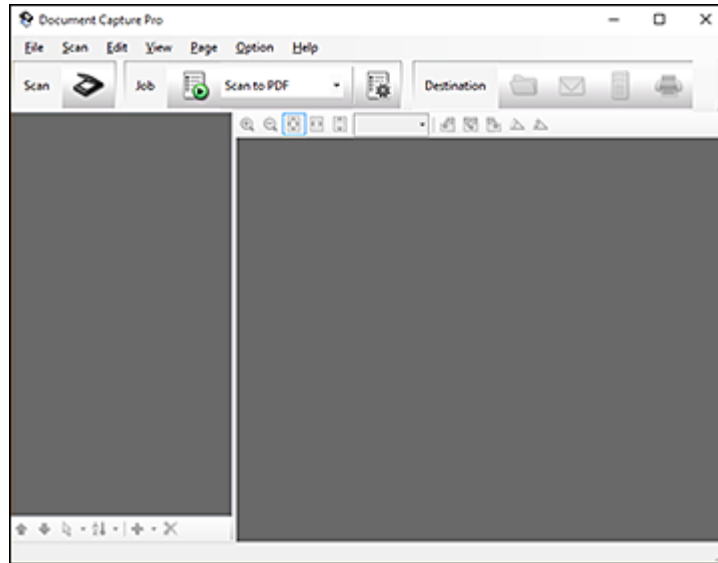

3. Click the  **Scan** icon.
4. Select any displayed scan settings you want to use.

Note: See the Help information in Document Capture Pro for details.

5. Click **Scan**.
You see a preview of your scan in the Document Capture Pro window.
6. Open the **File** menu and select **Batch Save**.
7. Click **File Name Settings**.
8. Select **Apply Job Separation** and click **Separation Settings**.
9. Select the method you used to separate the originals, select a folder name specification and click **OK**.

10. Select any other settings from the File Name settings window as necessary and click **OK**.
11. Select any other settings from the Batch Save window as necessary and click **OK**.

Your originals are saved into separate files as specified.

Note: You can also create a scan job for scanning multi-page originals as separate scanned files. You can use the scan job when you scan with Document Capture Pro or when you scan using the Document Capture Pro option on the product control panel.

Parent topic: [Scanning Special Projects](#)

Creating Contacts for Scanning

You can create a list of contacts for scanning to email or to a network folder or FTP.

1. Press the  home button, if necessary.
2. Select **Settings**.
3. Select **Contacts Manager**. Enter the administrator password, if necessary.
4. Select **Register/Delete**.

You see a screen like this:

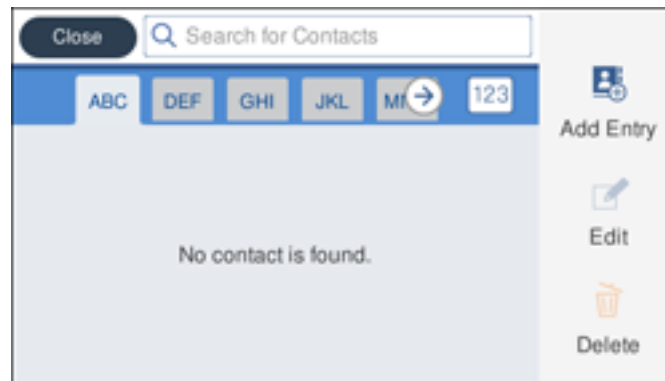

5. Select **Add Entry**.
6. Select **Add Contact**.

7. Do one of the following:
 - To create a contact for scanning to email, select **Email**.
 - To create a location for scanning to a network folder or FTP, select **Scan to Network Folder/FTP**.
8. Select the number you want to use for the contact you are adding.
9. Select the **Name** field, use the displayed keyboard to enter the contact name (up to 30 characters), and press **OK**.
10. Select the **Index Word** field, use the displayed keyboard to enter a word to use when searching for an entry (up to 30 characters), and press **OK**. (This field is optional.)
11. Do one of the following:
 - For an email contact, select the **Email Address** field, use the displayed keyboard to enter the address, and press **OK**.
 - For a network folder or FTP location, select the **Communication Mode** field and select **Network Folder (SMB)** or **FTP**. Then select the **Location** field, use the displayed keyboard to enter the location, and select **OK**. Enter other information if necessary.

Enter the folder path name for the **Location** setting in one of the following formats depending on the **Communication Mode** setting you selected:
 - **SMB**: \\host name\folder
 - **FTP**: ftp://host name/folder name
12. Select **OK**.

Note: If you need to edit or delete scanning contacts, the procedures are the same as for fax contacts.

Parent topic: [Scanning](#)

Related topics

[Setting Up Contacts Using the Product Control Panel](#)

Faxing

See these sections to fax using your product.

Note: This product allows you to store names, telephone numbers, and fax data in its memory even when the power is turned off. Make sure you restore all of the default settings if you give away or dispose of the product. This will erase all of your network settings and fax data.

[Connecting a Telephone or Answering Machine](#)

[Setting Up Fax Features](#)

[Setting Up Contacts and Contact Groups](#)

[Sending Faxes](#)

[Receiving Faxes](#)

[Checking Fax Status](#)

[Printing Fax Reports](#)

Connecting a Telephone or Answering Machine

You must connect your product to a telephone wall jack to send or receive faxes. If you want to use the same telephone line to receive calls, you can connect a telephone or answering machine to your product using an additional phone cable.

Note: If you do not connect a telephone to your product, make sure Receive Mode is set to **Auto**. Otherwise, you cannot receive faxes.

1. Connect a phone cable to your telephone wall jack and to the **LINE** port on your product.

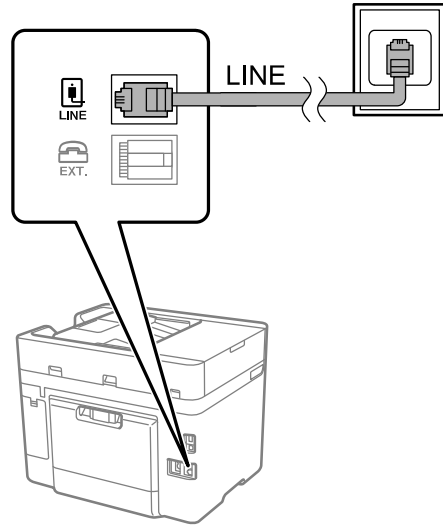

Note: If you have a DSL or ISDN connection, you must connect the appropriate DSL filter, or ISDN terminal adapter or router to the wall jack to be able to use the line for faxing or voice calls using your product. Contact your DSL or ISDN provider for the necessary equipment.

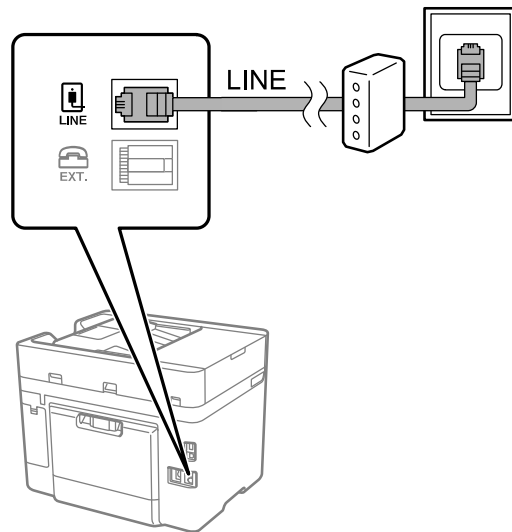

2. If you are connecting a telephone or answering machine to your product using a second phone cable, remove the cap from the **EXT** port on your product.

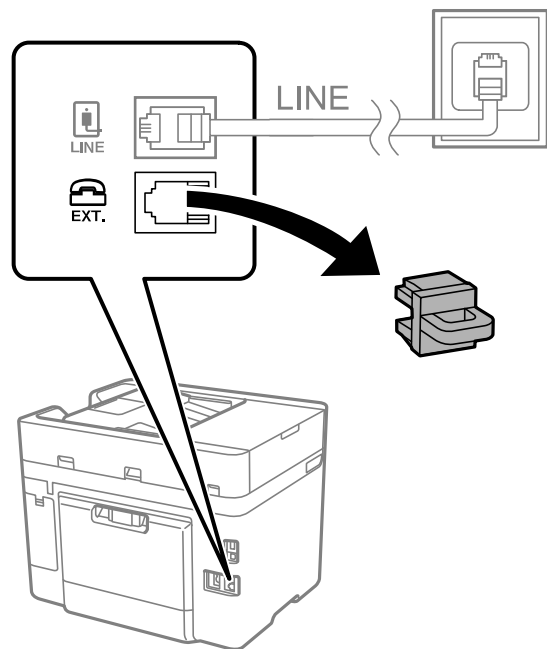

3. Connect a second phone cable to your telephone or answering machine and to the **EXT** port on your product.

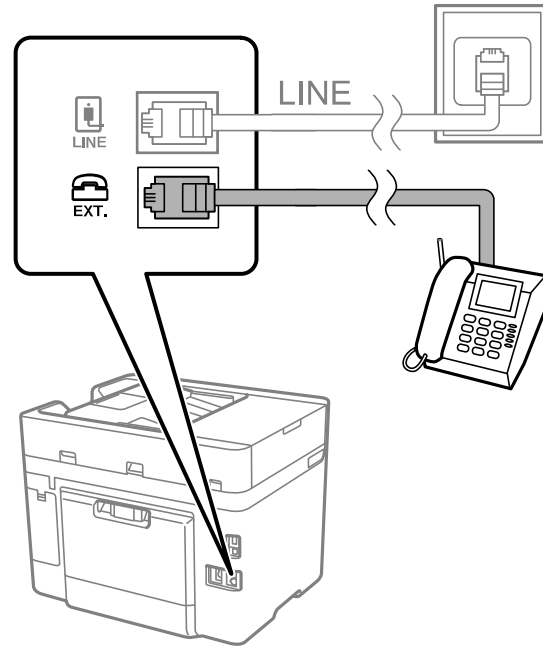

Note: If you connect an answering machine and Receive Mode is set to **Auto**, set the number of rings before your product answers a call to a number that is higher than your answering machine's setting for the number of rings.

Any phone or answering machine must be connected to the **EXT** port for your product to detect an incoming fax call when the phone is picked up. Epson cannot guarantee compatibility with VoIP, cable phone systems, or fiberoptic digital services such as FIOS.

Parent topic: [Faxing](#)

Related tasks

[Receiving Faxes Automatically](#)

Setting Up Fax Features

Before faxing with your product, set up your fax header and select the fax features you want to use.

Note: If you leave your product unplugged for a long period of time, you may need to reset the date and time settings for faxes.

[Setting Up Basic Fax Features](#)

[Selecting Advanced Fax Settings](#)

[Setting Up the Fax Utility - Windows](#)

[Setting Up Fax Features Using the Fax Utility - Mac](#)

Parent topic: [Faxing](#)

Setting Up Basic Fax Features

See these sections to select the basic settings you need to use the product's fax features.

[Using the Fax Setup Wizard](#)

[Selecting the Line Type](#)

[Setting the Number of Rings to Answer](#)

Parent topic: [Setting Up Fax Features](#)

Using the Fax Setup Wizard

You can setup the product's basic fax settings using the Fax Setting Wizard. This wizard is automatically displayed when the product is turned on for the first time. You can also change these settings individually from the Fax Settings menu.

1. Press the  home button, if necessary.
2. Select **Settings**.
3. Select **General Settings**.



4. Scroll down and select **Fax Settings**.
5. Scroll down and select **Fax Setting Wizard**.
The Fax Setting Wizard screen appears.
6. Select **OK**.
7. On the Fax Header screen, use the displayed keypad to enter the sender name for your fax source, such as your name or a business name. You can enter up to 40 characters.
8. On the Your Phone Number screen, use the displayed keypad to enter your fax number, up to 20 characters.

Note: The name and phone number in the fax header identifies the source of the faxes you send.

9. On the Distinctive Ring Setting screen, do one of the following:
 - If you have subscribed to a distinctive ring service from your telephone company, select **Proceed**. Select the ring pattern to be used for incoming faxes or select **On**. Go to step 12.
 - If you do not have a distinctive ring service, select **Skip** and go to the next step.

Note: Distinctive ring services allows you to have several phone numbers on one phone line. Each number is assigned a different ring pattern. You can use one number for voice calls and another for fax calls. Select the ring pattern assigned to fax calls in the Distinctive Ring Setting. If you select **On** or a ring pattern other than **All**, Receive Mode is automatically set to **Auto**.

10. On the Receive Mode Setting screen, do one of the following:
 - If you have connected an external telephone or answering machine to the product, select **Yes** and go to the next step.
 - If you did not connect an external telephone or answering machine, select **No** and go to step 12. (Receive Mode is automatically set to **Auto**; otherwise you cannot receive faxes.)
11. On the next Receive Mode Setting screen, select **Yes** to receive faxes automatically or select **No** to receive faxes manually.

Note: If you connect an external answering machine and select to receive faxes automatically, make sure the **Rings to Answer** setting is correct. If you select to receive faxes manually, you need to answer every call and operate the product's control panel or your phone to receive faxes.

12. On the Proceed screen, confirm the displayed settings and select **Proceed**, or press the back arrow to change the settings.

13. On the Run Check Fax Connection screen, select **Start Checking** and follow the on-screen instructions to check the fax connection and print a report of the check result. If there are any errors reported, try the solutions on the report and run the check again.

If the Select Line Type screen appears, select the correct line type.

If the Select Dial Tone Detection screen appears, select **Disable**. However, disabling the dial tone detection function may drop the first digit of a fax number and send the fax to the wrong number.

Parent topic: [Setting Up Basic Fax Features](#)

Related tasks

[Entering Characters on the LCD Screen](#)

Selecting the Line Type

If you connect the product to a PBX phone system or terminal adapter, you must change the product's line type. PBX (Private Branch Exchange) is used in office environments where an external access code such as "9" must be dialed to call an outside line. The default Line Type setting is PSTN (Public Switched Telephone Network), which is a standard home phone line.

1. Press the  home button, if necessary.
2. Select **Settings**.
3. Select **General Settings**.



4. Scroll down and select **Fax Settings**.
5. Select **Basic Settings**.
6. Select **Line Type**.

7. Select **PBX**.

You see a screen like this:

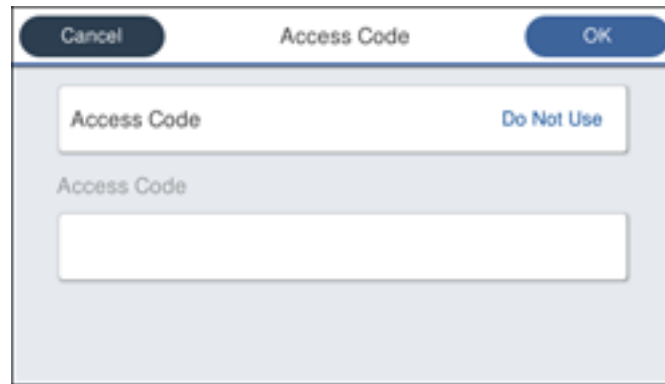

8. Select **Use**.
9. Select **Access Code**.
10. Use the displayed keypad to enter the access code, such as 9, and select **OK**.

Parent topic: [Setting Up Basic Fax Features](#)

Related tasks

[Entering Characters on the LCD Screen](#)

Setting the Number of Rings to Answer

If you connect an external answering machine and select to receive faxes automatically, make sure the Rings to Answer setting is correct. The number of rings should be higher than the number of rings your answering machine is set to for answering a call.

1. Press the  home button, if necessary.
2. Select **Settings**.

3. Select **General Settings**.



4. Scroll down and select **Fax Settings**.
5. Select **Basic Settings**.
6. Select **Rings to Answer**.

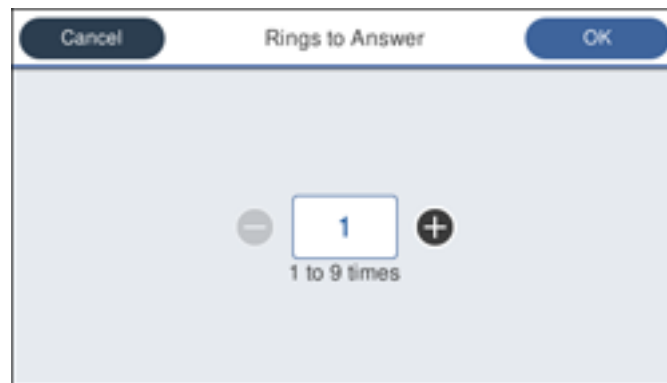

7. Select the number of rings and select **OK**. Make sure to select a number higher than the number of rings your answering machine is set to for answering a call.

Note: An answering machine picks up every call faster than the product, but the product can detect fax tones and start receiving faxes. If you answer the phone and hear a fax tone, check that the product has started receiving the fax, then hang up the phone.

Parent topic: [Setting Up Basic Fax Features](#)

Selecting Advanced Fax Settings

You can select a variety of advanced fax settings.

1. Press the  home button, if necessary.
2. Select **Settings**.
3. Select **General Settings**



4. Scroll down and select **Fax Settings**.

You see a screen like this:



5. Select the group of settings you want to change.

[Print Settings - Fax](#)

[Basic Settings - Fax](#)

[Security Settings - Fax](#)

Parent topic: [Setting Up Fax Features](#)

Print Settings - Fax

Set the print options you want to use for incoming faxes in the **Receive Settings > Print Settings** menu.

Setting	Options	Description
Auto Reduction	On	Select to reduce the size of large received faxes to fit on the paper size in the selected paper source.
	Off	Select to print large incoming faxes at their original size on multiple sheets, if necessary.
Split Page Settings	Delete Print Data After Split	Select how to split large incoming faxes across multiple sheets.
	Overlap When Split	
Auto Rotation	On	If you have loaded A5-size paper, select On to rotate landscape-oriented incoming faxes so that they print correctly on the paper.
	Off	
Add Reception Information	On	Select On to include the date, time, the sender's information, and a page number in the header of your incoming faxes.
	Off	
2-Sided	On	Select On to print incoming faxes double sided. You can also select the Binding Margin .
	Off	
Print Start Timing	All Pages Received	Select to print incoming faxes after the product receives all of the pages of the document.
	First Page Received	Select to print incoming faxes as soon as the product receives the first page of the document.
Collation Stack	On	Select On to print incoming faxes so that the pages are stacked in the correct page order. (When the product is low on memory, this option may not be available.)
	Off	

Setting	Options	Description
Print Suspend Time	Off	Select On to set a time period to stop automatic printing of faxes or reports and save received faxes in the product's memory. (Make sure there is enough free memory before using this function.)
	On	
	Time to Stop	
	Time to Restart	
Quiet Mode	On	Select On to reduce noise during printing. (Printing speed may be reduced.)
	Off	

Parent topic: [Selecting Advanced Fax Settings](#)

Basic Settings - Fax

Set the basic options you want to use for incoming and outgoing faxes.

Setting	Options	Description
Fax Speed	Fast(33,600bps)	Sets the speed at which you send and receive faxes.
	Medium(14,400bps)	
	Slow(9,600bps)	
ECM	On	Turns on Error Correction Mode (ECM) to automatically correct errors in sent or received fax data.
	Off	Turns off Error Correction Mode (ECM); color faxes cannot be sent or received.
Dial Tone Detection	On	Automatically dials the number you enter for faxing when the product detects a dial tone.
	Off	Turns off automatic dial tone detection, which may be necessary if the product is connected to a PBX (Private Branch Exchange) or a TA (Terminal Adapter). However, turning this setting off may cause the product to drop the first digit of a fax number.

Setting	Options	Description
Line Type	PSTN	Selects a standard phone line (Public Switched Telephone Network).
	PBX	Selects Private Branch Exchange, the type of phone line used in office environments where an access code such as 9 must be used to call an outside line.
Header	Fax Header	Select to enter the header information and your phone number for inclusion on outgoing faxes.
	Your Phone Number	
Receive Mode	Manual	Lets you confirm whether an incoming fax should be printed; a telephone must be connected to the product
	Auto	Automatically receives and prints faxes.
Distinctive Ring	All	If you are using a Distinctive Ring Service on your phone line, your telephone company can assign two or more phone numbers to the same line and assign different ring patterns to each. If you use this service, select the number of rings for your fax number so your product can receive faxes on the correct number of rings. Select All for phones lines that do not use this service.
	Single	
	Double	
	Triple	
	Double&Triple	
Rings to Answer	1 to 9	Sets the number of rings before your product receives a fax. If Receive Mode is set to Auto and an answering machine is connected to the product, make sure this setting is set higher than the number of rings your answering machine is set to answer a call.
Remote Receive	Off	Lets you start receiving faxes using your phone instead of operating the product (if the Receive Mode is set to Auto). When you select On , you must also set a Start Code . If you are using a cordless handset with its base connected to the product, you can start receiving the fax by entering the code using the handset.
	On	
	Start Code	

Setting	Options	Description
Rejection Fax	Various	Lets you automatically reject faxes from blocked numbers, with blank headers, or from unrecognized contacts.

Parent topic: [Selecting Advanced Fax Settings](#)

Security Settings - Fax

Set the security options you want to use for fax data.



Setting	Options	Description
Direct Dialing Restrictions	Off	Does not restrict dialed fax numbers.
	On	Allows faxing only to numbers stored in the contacts list or history.
	Enter Twice	Requires you to enter fax numbers twice to prevent errors.
Confirm Address List	Off	Selects whether or not to display a recipient confirmation screen before a fax is sent.
	On	
Backup Data Auto Clear	Off	Automatically erases sent or received fax data from your product's memory.
	On	
Clear Backup Data	—	Deletes all sent or received fax data remaining in your product's memory; run this function if you are giving away or disposing of your product.

Parent topic: [Selecting Advanced Fax Settings](#)

Setting Up the Fax Utility - Windows

You can set up the FAX Utility for Windows for use with your product.

Note: Before using the FAX Utility for Windows, make sure you have set up the fax features on your product using the product control panel. Also first confirm that you can send and receive faxes using the control panel.

1. Do one of the following:
 - **Windows 10:** Click  and select **All apps**, then select **EPSON Software**.
 - **Windows 8.x:** Navigate to the **Apps** screen.
 - **Windows (other versions):** Click  or **Start > Programs** or **All Programs > EPSON Software**.
2. Select **FAX Utility**.

The first time you use the FAX Utility, you see this introduction window:

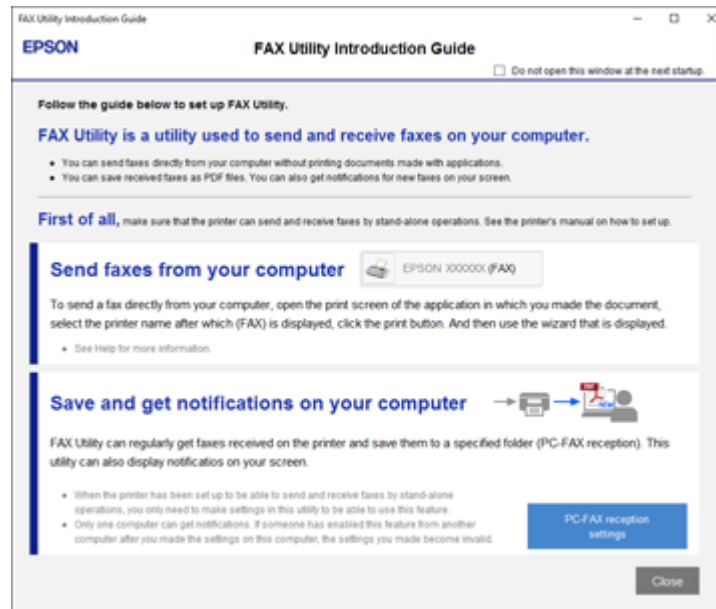

3. Read about the FAX Utility and click **Close** at the bottom of the window.

You see this window:

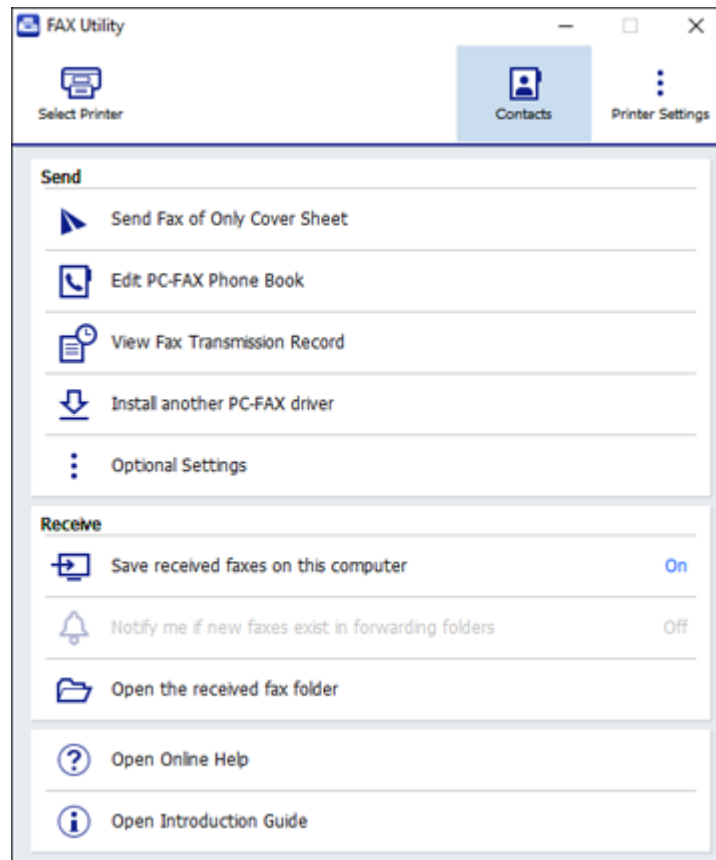

4. Click **Select Printer** and follow the on-screen instructions to transfer your product's fax settings to the FAX Utility.

Note: For detailed information, click **Help** or **Open Online Help**.

Parent topic: [Setting Up Fax Features](#)

Setting Up Fax Features Using the Fax Utility - Mac

You can set up your fax header and select your fax settings using the FAX Utility for Mac.

1. In the Apple menu or the Dock, select **System Preferences**. Select **Print & Fax**, **Print & Scan**, or **Printers & Scanners**, select the **FAX** option for your product, and select **Options & Supplies**. Select **Utility** and select **Open Printer Utility**.
2. Double-click **FAX Utility**, if necessary.

You see this window:

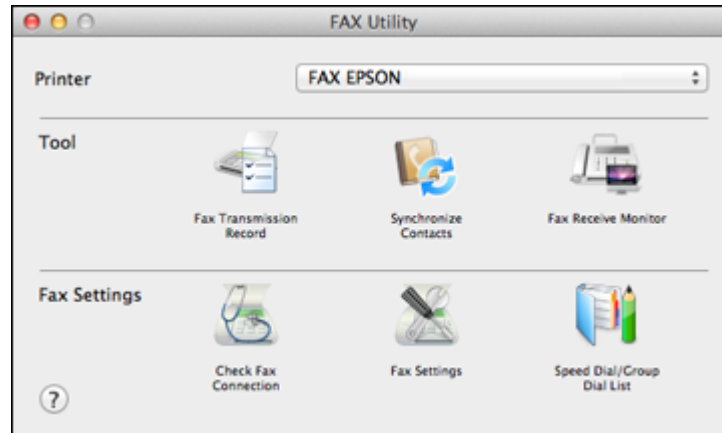

3. Select your **FAX** product in the Printer list.
4. Select **Fax Settings**.
5. Follow the prompts that appear on the screen to enter your fax header information and select your fax settings.

Note: For detailed information, select the FAX Utility ? icon.

Parent topic: [Setting Up Fax Features](#)

Setting Up Contacts and Contact Groups

You can set up a list of contacts and their fax numbers so you can quickly select them for faxing. You can also set up contact groups to send a fax message to multiple contacts.

[Setting Up Contacts Using the Product Control Panel](#)

[Importing Contacts Using the Fax Utility - Windows](#)

[Setting Up Speed/Group Dial Lists Using the Fax Utility - Mac](#)

Parent topic: [Faxing](#)

Setting Up Contacts Using the Product Control Panel

You can set up your contacts and contact groups using the control panel on your product.

[Creating a Contact](#)

[Editing or Deleting a Contact](#)

[Creating a Contact Group](#)

[Editing or Deleting a Contact Group](#)

Parent topic: [Setting Up Contacts and Contact Groups](#)

Related tasks

[Setting Up Speed/Group Dial Lists Using the Fax Utility - Mac](#)

[Receiving Faxes Manually](#)

Creating a Contact

You can create a list of contacts to save frequently used fax numbers.

Note: You can create up to 100 contacts and contact groups combined.

1. Press the  home button, if necessary.
2. Select **Fax**.

You see a screen like this:



3. Select **Contacts**.

You see a screen like this:

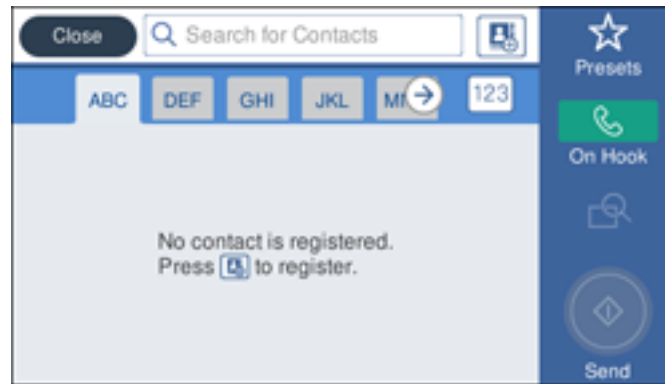

4. Press the  **Add Contact** icon.
5. Select **Add Contact**.
6. Select the number you want to use for the contact you are adding.

You see a screen like this:

A screenshot of a form titled 'Add Entry'. The form has three main sections: 'Registry Number' with a text input field containing '0001', 'Contact' with a text input field containing 'Enter Contact.', and 'Index Word' with a text input field. At the top of the form are three buttons: 'Cancel', 'Add Entry', and 'OK'. A scroll bar is visible on the right side of the form, and a downward arrow icon is at the bottom right corner.

7. Select the **Contact** field, use the displayed keyboard to enter the contact name (up to 30 characters), and press **OK**.

8. Select the **Index Word** field, use the displayed keyboard to enter a word to use when searching for an entry (up to 30 characters), and press **OK**. (This field is optional.)
9. Select the **Fax Number** field, and use the numeric keypad on the LCD screen or the buttons on the product to enter the fax number. You can enter up to 64 characters.

Note: If necessary, enter an outside line access code (such as **9**) at the beginning of the fax number. If the access code has been set up in the **Line Type** setting, enter the **#** pound sign instead of the code.

10. Set the **Fax Speed** setting, if necessary.
11. Select **Save**.

Parent topic: [Setting Up Contacts Using the Product Control Panel](#)

Editing or Deleting a Contact

You can edit or delete any of the contacts on your list.

1. Press the  home button, if necessary.
2. Select **Fax**.

You see a screen like this:



3. Select **Contacts**.
4. Select the  icon next to the contact you want to edit or delete.

You see a screen like this:

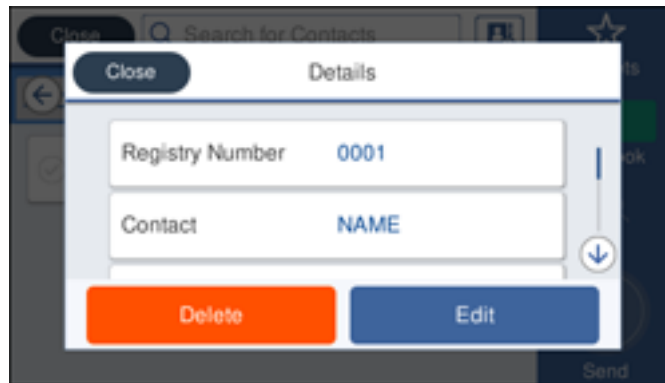

5. Do one of the following:
 - To delete the contact, select **Delete** and select **Yes** on the confirmation screen.
 - To edit the contact, select **Edit**, select the item you want to change, enter the correct information, and select **OK**. When you are finished editing, select **OK**.

Parent topic: [Setting Up Contacts Using the Product Control Panel](#)

Creating a Contact Group

You can create a group of contacts so that you can easily send faxes to multiple recipients.

Note: You can create up to 100 contacts and contact groups combined. You must create a contact before creating a contact group.

1. Press the  home button, if necessary.
2. Select **Fax**.

You see a screen like this:

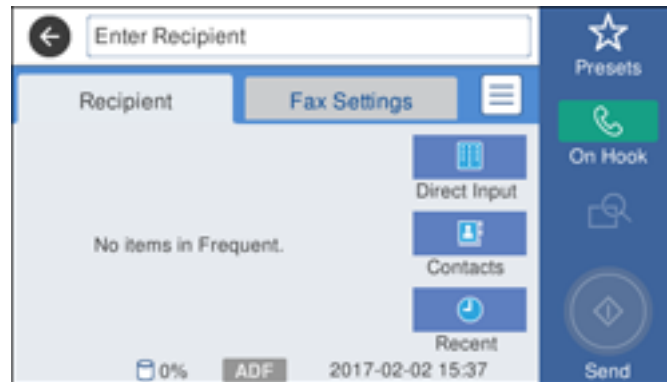

3. Select **Contacts**.
4. Press the  **Add Contact** icon.
5. Select **Add Group**.

You see a screen like this:

6. Select the number you want to use for the group you are adding.
7. Select the **Group Name** field, use the displayed keyboard to enter the group name (up to 30 characters), and press **OK**.

8. Select the **Index Word** field, use the displayed keyboard to enter a word to use when searching for a group (up to 30 characters), and press **OK**. (This field is optional.)
9. Select **Contact(s) Added to the Group**.
You see your contacts list.
10. Select the number next to each contact you want to include in your group.
A check mark appears next to each selected contact.
11. Select **OK**.

Parent topic: [Setting Up Contacts Using the Product Control Panel](#)

Editing or Deleting a Contact Group

You can edit an existing contact group to add or delete entries. You can also delete the entire contact group.

1. Press the  home button, if necessary.
2. Select **Fax**.

You see a screen like this:



3. Select **Contacts**.
4. Select the  icon next to the group you want to edit or delete.

You see a screen like this:

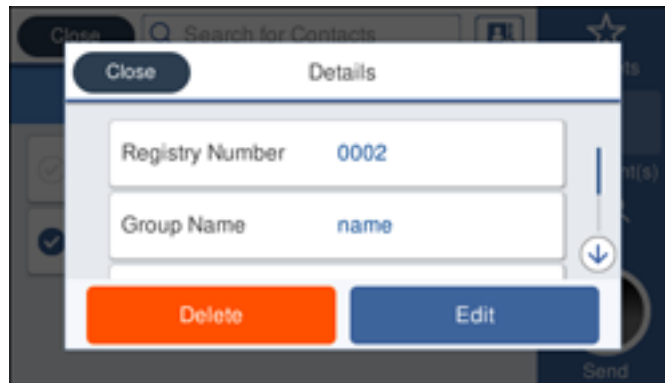



Note: If you want to delete the entire group, select **Delete**.

5. To edit the group, select **Edit**.
6. Select **Contact(s) Added to the Group**.
You see a list of the contacts in your group.
7. To add or delete a contact, select the number next to it.
8. Select **OK**.

Parent topic: [Setting Up Contacts Using the Product Control Panel](#)

Importing Contacts Using the Fax Utility - Windows

You can edit contacts stored in your product and import contacts from your Windows Address Book to the PC-FAX Phone Book in the FAX Utility for Windows.

1. Do one of the following:
 - **Windows 10:** Click  and select **All apps > EPSON Software**.
 - **Windows 8.x:** Navigate to the **Apps** screen.
 - **Windows (other versions):** Click  or **Start > Programs** or **All Programs > EPSON Software**.
2. Select **FAX Utility**.

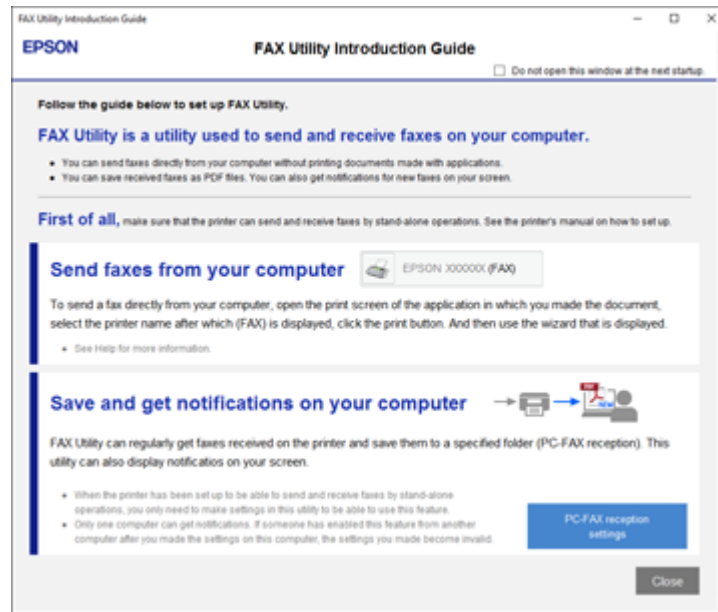

The first time you use the FAX Utility, you see this introduction window:

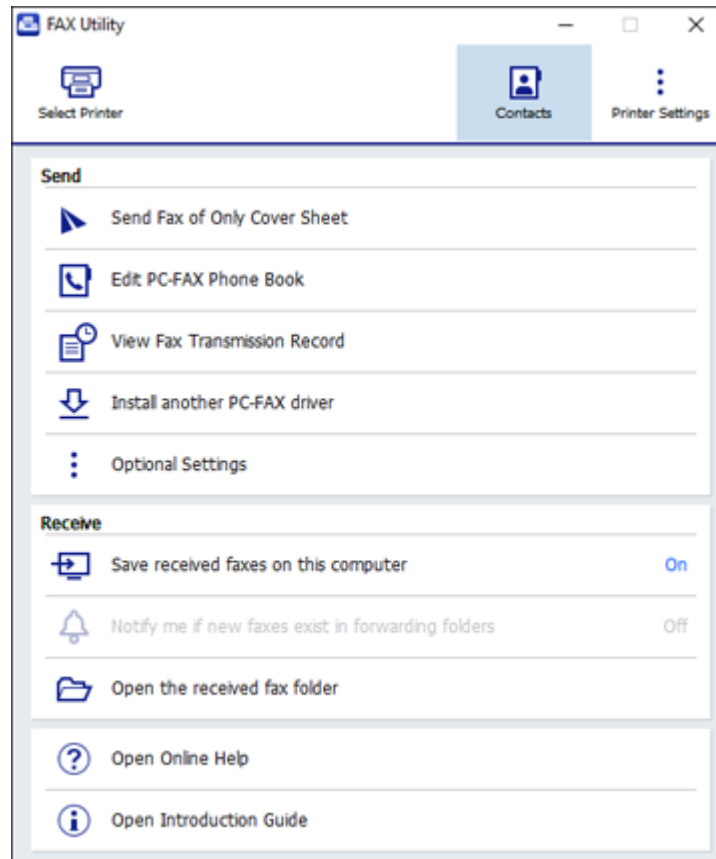

3. Read about the FAX Utility and click **Close** at the bottom of the window.

You see this window:



4. To edit the contacts list on your product, click **Contacts**.
5. Do one of the following:
 - To edit a contact, select it in the list and click the  icon.
 - To delete a contact, select it in the list and click the  icon.
6. To import fax numbers from your Windows Address Book into the FAX Utility PC-FAX Phone Book, select **Edit PC-FAX Phone Book**.

You see this window:

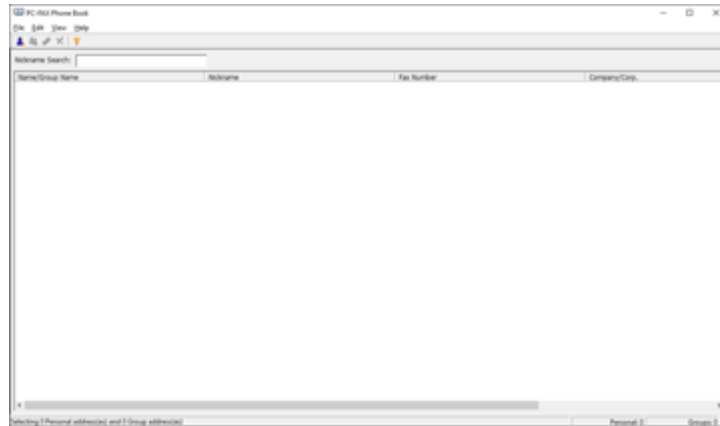

7. Select **File > Import From Windows Address Book**.
8. Select the contacts you want to import and click **OK**.

Note: For detailed information, select **Help** or **Open Online Help**.

Parent topic: [Setting Up Contacts and Contact Groups](#)

Setting Up Speed/Group Dial Lists Using the Fax Utility - Mac

You can set up your speed dial and group dial lists using the FAX Utility. The utility also lets you import fax numbers from the MacAddress Book and back up fax numbers to your product's memory.

Note: You can create up to 60 speed dial and group dial entries combined.

1. In the Apple menu or the Dock, select **System Preferences**. Select **Print & Fax**, **Print & Scan**, or **Printers & Scanners**, select the **FAX** option for your product, and select **Options & Supplies**. Select **Utility** and select **Open Printer Utility**.
2. Double-click **FAX Utility**, if necessary.

You see this window:

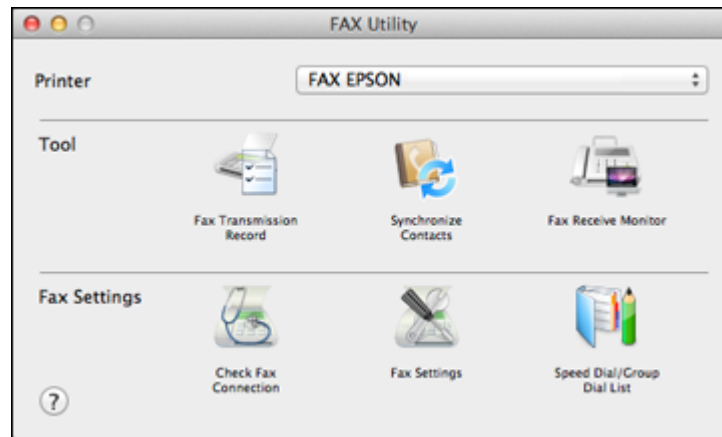

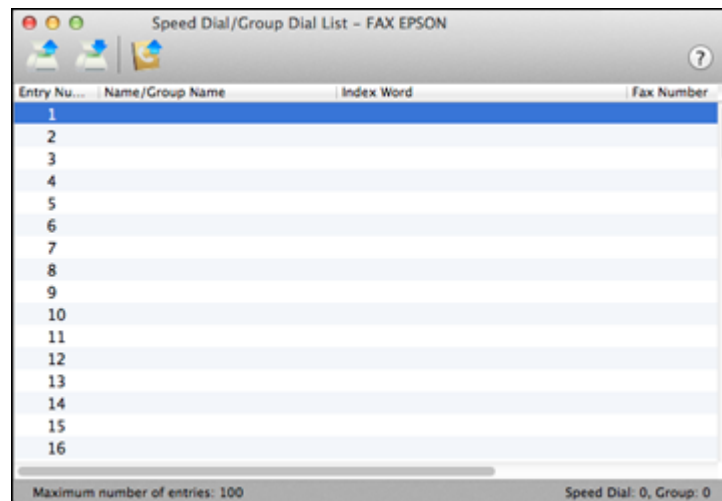

3. Select your **FAX** product in the Printer list.
4. Select **Speed Dial/Group Dial List**.

You see this window:



5. To add an entry, double-click an empty entry.

Note: To edit an entry, select it and change the information. To delete an entry, select it and press the **Delete** key on your keyboard.

6. Do one of the following:
 - To create a speed dial entry, select **Speed Dial**, enter a name and fax number, and click **OK**.
 - To create a group dial entry, select **Group Dial**, enter a name, select your desired fax numbers, and click **OK**.
7. Repeat the previous steps as necessary to add all your speed dial or group dial entries.
8. To import entries from your MacAddress book, click the  icon.
9. When you are finished, click the  icon to save the entries to your product's memory.

Parent topic: [Setting Up Contacts and Contact Groups](#)

Sending Faxes

See these sections to send faxes using your product.

[Sending Faxes from the Product Control Panel](#)

[Sending Faxes Using the Fax Utility - Windows](#)

[Sending Faxes Using the Fax Utility - Mac](#)

Parent topic: [Faxing](#)

Sending Faxes from the Product Control Panel

See these sections to send faxes using the product's control panel.

[Sending a Fax Using the Keypad, Contact List, or History](#)

[Fax Sending Options](#)

[Sending a Fax at a Specified Time](#)

Parent topic: [Sending Faxes](#)

Sending a Fax Using the Keypad, Contact List, or History

You can send a fax from your product control panel by entering the fax number, or selecting the number from either the contact list or fax history.

Note: You can send a black-and-white fax to up to 100 contacts or 99 groups at a time, or send a color fax to one recipient at a time. If your recipient's fax machine does not print in color, your fax is automatically sent in black-and-white.

1. Place your original on the product for faxing.
2. Press the  home button, if necessary.
3. Select **Fax**.

You see a screen like this:



Note: To fax a double-sided document, place your document in the ADF and turn on the **ADF 2-Sided** setting. (You cannot fax double-sided documents in color.)

4. Do one of the following to select fax recipients:
 - **Manually enter a fax number:** Select **Keypad** and enter a fax number. Press **OK** when done. To add another fax number, repeat the same steps. You can also use the numeric keypad on the control panel to enter a fax number.

Note: If direct dialing has been restricted, you can only select the number from the contact list or fax history. If necessary, enter an outside line access code (such as 9) at the beginning of the fax number. If the access code has been set up in the **Line Type** setting, enter the # pound sign instead of the code. If your fax number requires a brief pause, select the - icon to insert a pause symbol (–).

- **Select from the contact list:** Select **Contacts** to display the contact list. Select one or more contacts (select the contacts again to deselect it). You can also select the **Search for Contacts** field to search for recipients by name, index name, or entry number. Select **Close** when you are finished.
- **Select from the sent fax history:** Select **Recent** to display the sent fax history. Select a recipient from the list.

Note: To delete entered recipients, select the **Enter Recipient** field, select the recipient you want to delete, and select **Remove**.

5. If you need to change any fax settings, select **Fax Settings** and select your settings.
6. If you want to preview your fax in black-and-white on the LCD, press the  icon. (If the preview looks incorrect, select **Retry**, reposition the document or change the fax settings, and repeat this step.) You cannot send the fax in color after previewing it.

Note: If you do not touch the preview screen for 20 seconds, your product sends the fax automatically. You cannot preview images when the Direct Send setting is turned on.

7. If you want to save your fax settings for later use, select **Presets** and add a new entry.
8. Press the  **Send** icon.

Note: To cancel faxing, select **Cancel**.

Your product scans your original and prompts you to place additional pages, if necessary. After scanning your originals, your product dials the number and sends the fax.

Note: Your product does not save sent color faxes to its memory. If the **Save Failure Data** option is enabled, faxes that failed to be sent are stored to the product's memory and you can resend them from the Status Menu screen.

Parent topic: [Sending Faxes from the Product Control Panel](#)

Related references

[Fax Sending Options](#)

Related tasks

[Selecting the Line Type](#)

[Using Presets](#)

Related topics

[Placing Originals on the Product](#)

[Setting Up Contacts Using the Product Control Panel](#)

Fax Sending Options

While sending a fax, you can select **Fax Settings** and select these options.

Setting	Options	Description
Original Size (Glass)	Half Letter	Sets the size for a document placed on the scanner glass
	A5	
	Letter	
	A4	
Original Type	Text	Specifies the document type of your originals and adjusts the quality of your copies
	Text & Image	
	Photo	
	Text & Image(Best)	
Color Mode	Color	Select whether to scan images in color or black and white
	Black & White	
Resolution	Standard	Adjusts the scan resolution and print quality of outgoing faxes
	Fine	
	Super Fine	
	Ultra Fine	
Density	Varying levels available	Lets you select from various density levels
Remove Background	Auto	Automatically removes any background color on scanned images
	Varying levels available	Lets you select from various levels of background color adjustment
Sharpness	Varying levels available	Lets you adjust the sharpness level of outgoing faxes

Setting	Options	Description
ADF 2-Sided	Off	Select On to enable 2-sided faxing from the ADF. The Direct Send option and color faxing are disabled when you turn on this setting.
	On	
Continuous Scan (ADF)	Off	Select On to have the product to ask if you want to scan another page after a document in the ADF has finished scanning
	On	
Direct Send	Off	Select On to send black-and-white faxes to a single recipient as soon as the connection is made, without saving the scanned image to memory. You cannot use this setting when sending a color fax or sending a fax to multiple recipients.
	On	
Send Fax Later	Off	Select On to send the current fax at a selected time
	On	
Add Sender Information	Off	Lets you include a header, your phone number, or a destination list in the selected location on your outgoing faxes
	Outside of Image	
	Inside of Image	
Transmission Report	Print on Error	Lets you select when to print transmission reports
	Print	
	Do Not Print	

Parent topic: [Sending Faxes from the Product Control Panel](#)

Related tasks

[Entering Characters on the LCD Screen](#)

Sending a Fax at a Specified Time

You can send a fax at a time of your choice.

Note: Make sure the product's date and time settings are correct. You can only send faxes in black-and-white when you use this option.

1. Place your original on the product for faxing.
2. Press the  home button, if necessary.

3. Select **Fax**.

You see a screen like this:

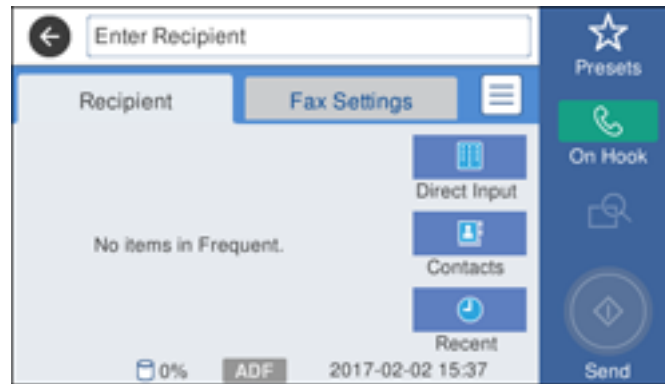

4. Enter a fax number or select a number from the Contacts or Recent lists.
5. Select **Fax Settings**.
6. Select **Send Fax Later**.
7. Select **On**.
8. Select **Time**, use the displayed keypad on the LCD screen to enter your desired time, and select **OK**.
9. Select **Send**.

Note: To cancel faxing, select **Cancel**.

After scanning your originals, your product dials the number and sends the fax at the specified time.

Note: If the product is turned off at the specified time, the fax is sent when it is powered on.

Parent topic: [Sending Faxes from the Product Control Panel](#)

Sending Faxes Using the Fax Utility - Windows

You can send a fax from a printing program in Windows. You can fax up to 100 pages at a time, including a cover sheet.

1. Open the file you want to fax and select the print command.
You see a window like this:

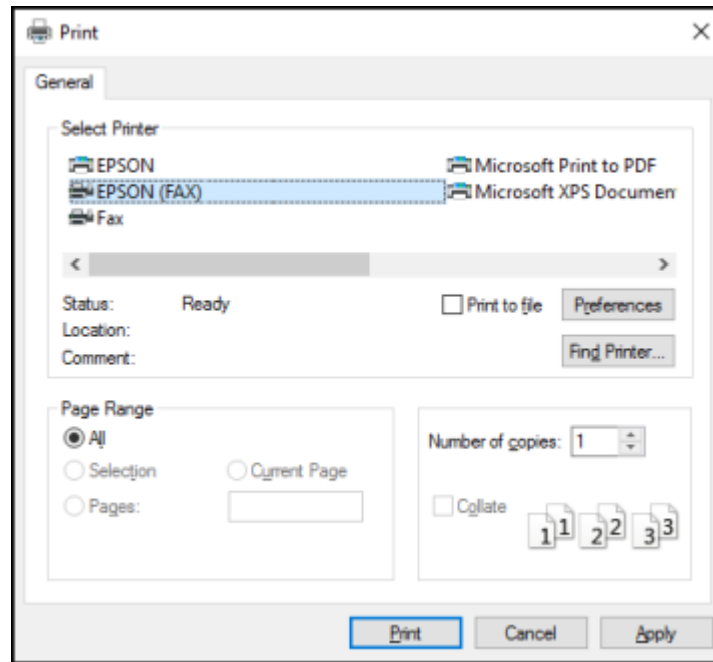

2. Select your product with the **FAX** option as the printer.
3. To change the Paper Size, Orientation, Color, Image Quality, or Character Density settings, click the **Preferences** or **Properties** button.

Note: If you see a **Setup**, **Printer**, or **Options** button, click it. Then click **Preferences** or **Properties** on the next screen. For more information about selecting fax print settings, click **Help**.

4. Select the Page Range as necessary. (Leave the Number of copies set to 1.)
5. Click **Print** or **OK**.

If you're faxing for the first time, you see a window like this one:

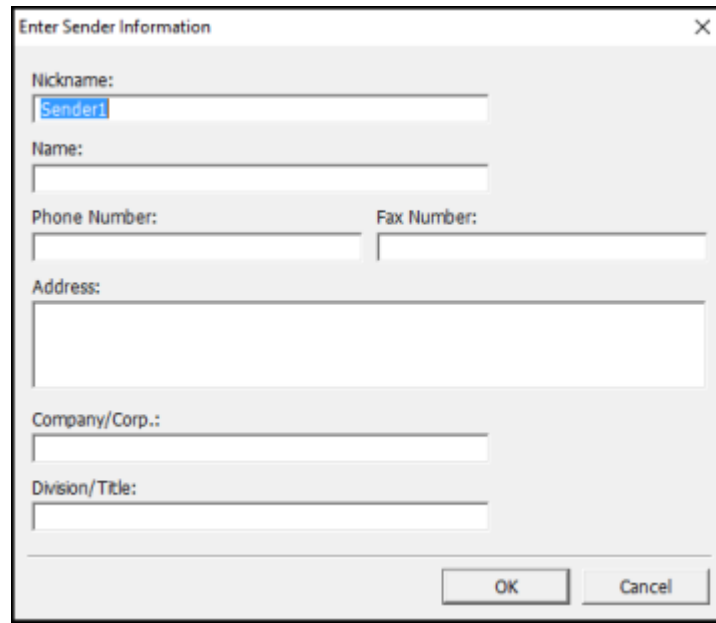

The image shows a dialog box titled "Enter Sender Information" with a close button (X) in the top right corner. The dialog contains several input fields: "Nickname:" with the text "Sender1" entered; "Name:" which is empty; "Phone Number:" and "Fax Number:" which are empty; "Address:" which is a large empty text area; "Company/Corp.:" which is empty; and "Division/Title:" which is empty. At the bottom right of the dialog are two buttons: "OK" and "Cancel".

6. Enter your sender information so that recipients can identify the origin of the fax. Then click **OK** to save the sender information.

You see a window like this:

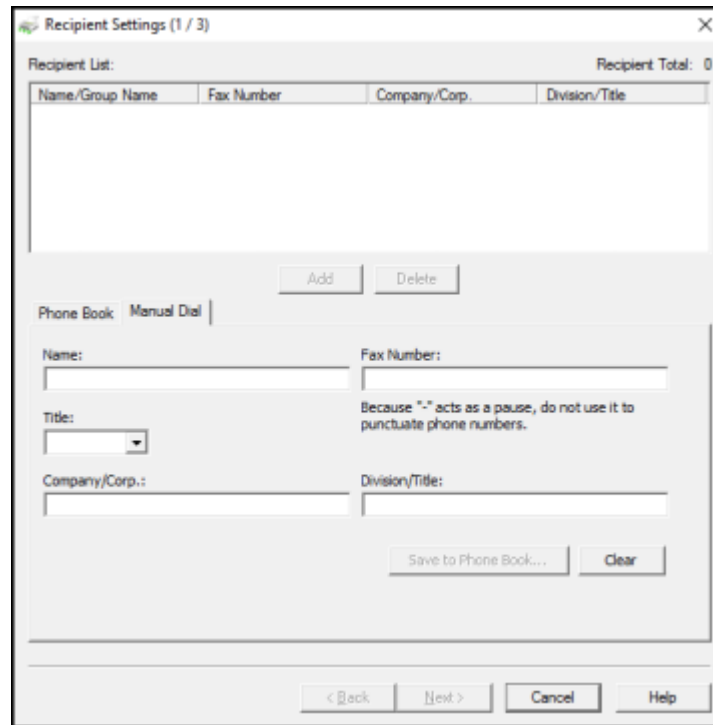

7. Enter the recipient's name and fax number or select a recipient from the phonebook, then click **Next**.

Note: For detailed instructions on using the Epson FAX Utility, click **Help**.

8. Select a cover sheet and enter a subject and message, then click **Next**.
9. Click **Send** to transmit your fax.

Parent topic: [Sending Faxes](#)

Sending Faxes Using the Fax Utility - Mac

You can send a fax from a Mac printing program using the FAX Utility. You can fax up to 100 pages at a time, including a cover sheet.

1. Open the file you want to fax.

2. Select the print command in your application.

Note: You may need to select a print icon on your screen, the **Print** option in the **File** menu, or another command. See your application's help utility for details.

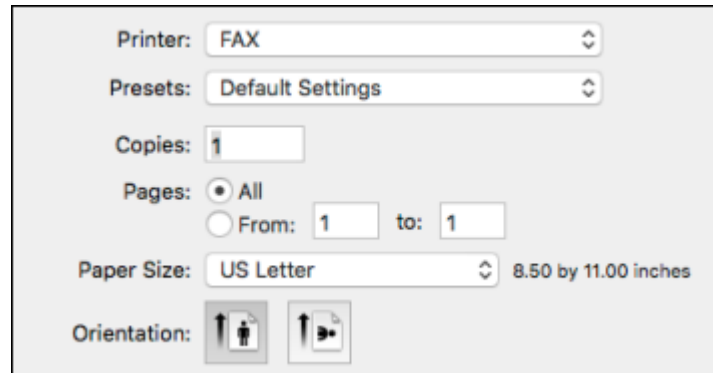

The image shows a print settings dialog box with the following controls:

- Printer:** A dropdown menu set to "FAX".
- Presets:** A dropdown menu set to "Default Settings".
- Copies:** A text input field containing the number "1".
- Pages:** Radio buttons for "All" (selected), "From: 1 to: 1".
- Paper Size:** A dropdown menu set to "US Letter" with the dimensions "8.50 by 11.00 inches" displayed to the right.
- Orientation:** Two icons: one for portrait orientation (vertical arrow) and one for landscape orientation (horizontal arrow).

3. Select your product **FAX** option as the **Printer** setting.
4. If necessary, click the arrow next to the Printer setting or the **Show Details** button to expand the print window.
5. Select the number of pages you are faxing as the **Pages** setting.

Note: Leave the **Copies** setting set to **1**.

6. Select **Recipient Settings** from the pop-up menu.

You see this window:

Recipient Settings

Recipient List:

Name	Company/Corp.	Fax Number
------	---------------	------------

Add:

Name:

Company/Corp.:

Fax Number:

A hyphen (-) is available only at the beginning of the phone number because it acts as a pause in dialing.

External Access Prefix:

Cancel Fax

7. Do one of the following to choose your recipient:
 - Select a name or group from the **Recipient List**.
 - Enter a name, company, and fax number and click the **+** button.
 - Click the  icon and select a recipient from your address book.
8. Select **Fax Settings** from the pop-up menu.

You see this window:

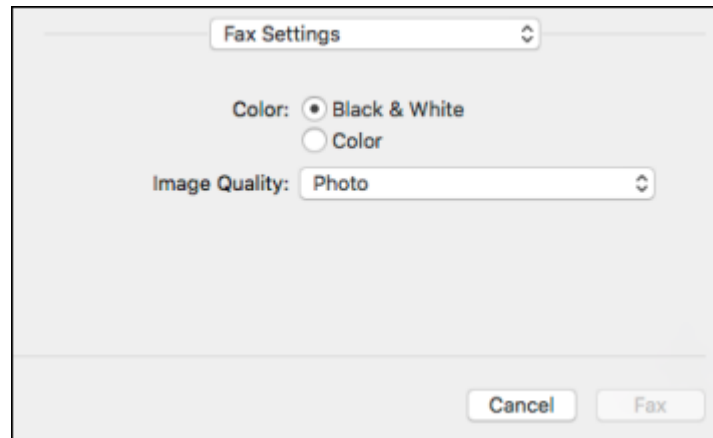

9. Select the **Color** and **Image Quality** settings you want to use for your fax.

10. Click **Fax**.

Parent topic: [Sending Faxes](#)

Receiving Faxes

See these sections to receive faxes with your product.

[Fax Reception](#)

[Receiving Faxes Automatically](#)

[Receiving Faxes Manually](#)

[Receiving a Fax by Polling](#)

[Viewing a Fax on the LCD Screen \(Using the Inbox\)](#)

[Saving Faxes to a USB Memory Device](#)

[Selecting Received Fax Options Using the Fax Utility - Windows](#)

Parent topic: [Faxing](#)

Fax Reception

Your product will automatically receive and print faxes when you set the Receive Mode to **Auto**.

If you connected a telephone to your product so you can use the same phone line for faxes and voice calls, you can also set your product to receive faxes manually. This allows you to check for a fax tone using the telephone and press a button on your product to receive the fax.

Make sure to load paper in your product and select your fax settings before receiving a fax.

Note: If you run out of paper during fax printing, load more paper and press the button indicated on your product's LCD screen to continue.

Parent topic: [Receiving Faxes](#)

Receiving Faxes Automatically

To receive faxes automatically, make sure Receive Mode is set to **Auto** (the default setting for the product).

To change the Receive Mode if necessary, select **Settings > General Settings > Fax Settings > Basic Settings > Receive Mode**.

If an answering machine is connected, make sure the product's **Rings to Answer** setting is set higher than the number of rings your answering machine is set to answer a call. For example, if the answering machine is set to pick up on the fourth ring, set the product to pick up on the fifth ring or later.

Parent topic: [Receiving Faxes](#)

Related references

[Basic Settings - Fax](#)

Related tasks

[Receiving Faxes Manually](#)

Receiving Faxes Manually

You can set up your product to receive faxes manually by setting the Receive Mode to **Manual**. This lets you check for a fax tone on the connected telephone before receiving a fax.

1. To change the Receive Mode, select **Settings > General Settings > Fax Settings > Basic Settings > Receive Mode** and select **Manual**.
2. When the connected telephone rings, answer the call.
3. If you hear a fax tone, select **Fax** on the LCD display.
4. Select **Send/Receive**.
5. Select **Receive**.

6. Select **Receive** to start receiving the fax.
7. Hang up the telephone.

Parent topic: [Receiving Faxes](#)

Related references

[Basic Settings - Fax](#)

Related tasks

[Receiving Faxes Automatically](#)

Receiving a Fax by Polling

You can use polling to receive a fax from another fax machine (such as a fax information service).

Note: You cannot use polling to receive a fax from a fax information service that uses audio guidance.

1. Press the  home button, if necessary.
2. Select **Fax**.

You see a screen like this:



3. Press the  icon.
4. Set **Polling Receive** to **On**.
5. Select **Close**.

6. Select **Close**.
7. Enter the fax number you expect to receive the fax from.
8. Select **Polling Rec** to start receiving the fax.

Parent topic: [Receiving Faxes](#)

Viewing a Fax on the LCD Screen (Using the Inbox)

You can save received faxes in your product's memory and view them on the LCD screen.

1. Press the  home button, if necessary.
2. Select **Settings**.
3. Select **General Settings**.





4. Scroll down and select **Fax Settings**.
5. Select **Receive Settings**.

6. Select **Fax Output Settings**.



7. Select **Save to Inbox**.
8. Set **Save to Inbox** to **On**.
9. Select **Option When Memory is Full** and choose an option.
10. Select **Inbox Password Settings** to set, change, or reset the password for the inbox.

Note: You cannot set an Inbox password if you chose to print faxes when the inbox is full.

11. Press the  home button.
12. Select . Enter the inbox password, if necessary.
13. Select the fax you want to view.

You see the fax displayed on the screen.

14. Press the  icon.
15. Select one of the printing or deleting options, and follow the on-screen instructions.

Note: Delete faxes after you print or view them to prevent the product's memory from filling up. When the memory is full, you can only print or refuse incoming faxes.

Parent topic: [Receiving Faxes](#)

Saving Faxes to a USB Memory Device

You can save incoming faxes to a connected USB memory device.

1. Insert a supported USB memory device into the product's USB slot.
2. Press the  home button, if necessary.
3. Select **Settings > General Settings > Fax Settings > Receive Settings > Fax Output Settings**.
You see a screen like this:





4. Select **Save to Memory Device**
5. Select **Yes** to save the fax or **Yes and Print** to save and print the fax.

Parent topic: [Receiving Faxes](#)

Selecting Received Fax Options Using the Fax Utility - Windows

You can select options for use with received faxes using the FAX Utility for Windows.

1. Do one of the following:
 - **Windows 10:** Click  and select **All apps**, then select **EPSON Software**.
 - **Windows 8.x:** Navigate to the **Apps** screen.
 - **Windows (other versions):** Click  or **Start > Programs** or **All Programs > EPSON Software**.
2. Select **FAX Utility**.

The first time you use the FAX Utility, you see this introduction window:

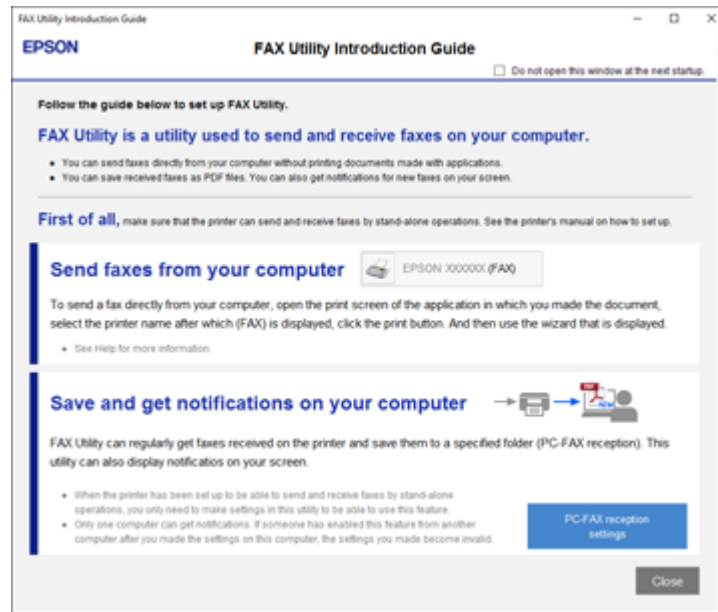

3. Read about the FAX Utility and click **Close** at the bottom of the window.

You see this window:

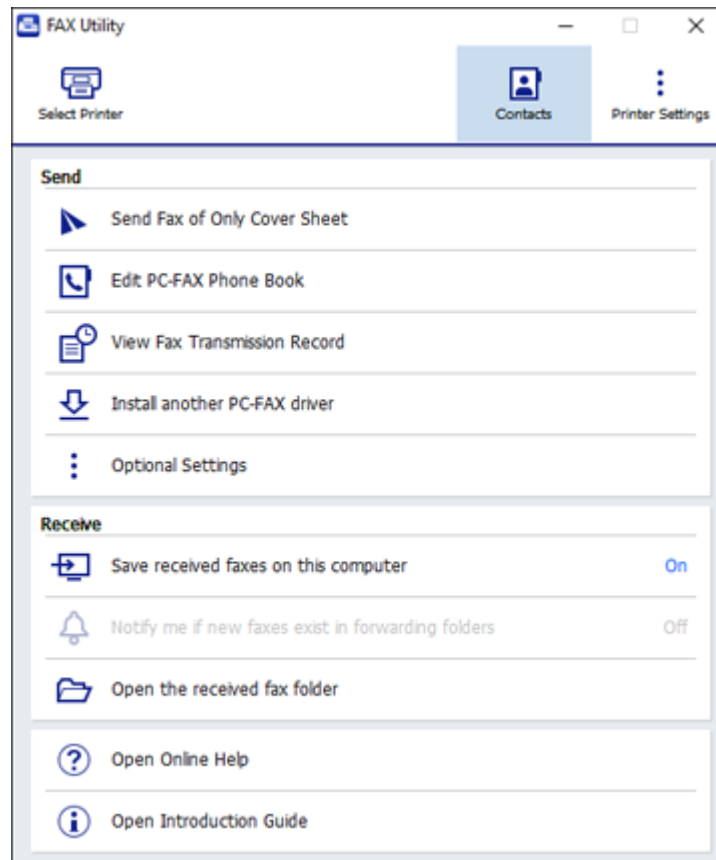

4. To save faxes received by your product on your computer, select **Save received faxes on this computer**.
5. Select the destination folder and other options, and click **OK**.
You return to the FAX Utility window.
6. To receive notifications when received faxes arrive in the selected destination folder on your computer, select **Notify me if new faxes exist in forwarding folders**.

7. Select how often you want to be notified of received faxes and click **OK**.

Note: For detailed information, click **Help** or **Open Online Help**.

Parent topic: [Receiving Faxes](#)

Checking Fax Status



You can check the status of current fax jobs, or faxes that have been received or sent on the product control panel.

1. Select **Fax**.

You see a screen like this:



2. Select the  icon.
3. To check the history of faxes that have been sent, received, or saved, select **Transmission Log** and select the job you want to check.

Note: If you see a numbered icon above the  icon on your product's LCD screen or the  received fax light is flashing, received faxes have been temporarily saved to the product's memory.

Parent topic: [Faxing](#)

Printing Fax Reports

You can print several types of fax reports whenever necessary. You can also print the fax log printed automatically by turning on **Fax Log Auto Print**.

1. Press the  home button, if necessary.
2. Select **Fax**.

You see a screen like this:

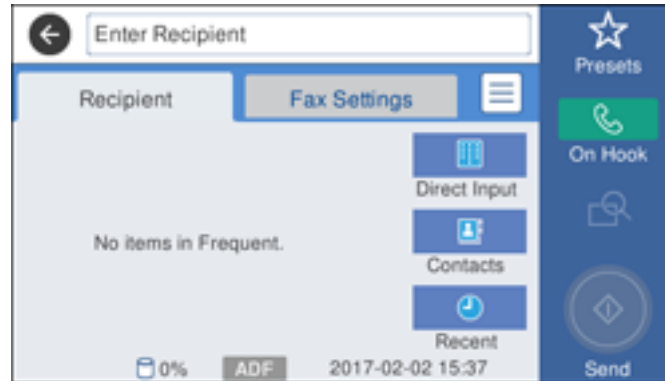

3. Press the  icon.
4. Select **Fax Report**.
5. Select the fax report you want to print.

[Fax Report Options](#)

Parent topic: [Faxing](#)

Fax Report Options

Select the fax report or list you want to print.

Fax Log

Prints the fax log automatically. Select **On (Every 30)** to print the fax log after every 30 faxes. Select **On (Time)** to print a report at a specific time. Prints automatically if more than 30 faxes arrive.

Attach Fax Image to Report

Prints transmission reports with an image of the first faxed page.

Report Format

Selects the amount of information on fax reports.

Parent topic: [Printing Fax Reports](#)

Using External USB Devices with Your Product

Follow the instructions here to work with an external USB device connected to your product.

[Connecting a USB Device](#)

[Disconnecting a USB Device](#)

[Viewing and Printing from the LCD Screen](#)

[Transferring Files on a USB Device](#)

Connecting a USB Device

Connect your USB device to the USB port on the front of the product.

Note: Epson cannot guarantee the compatibility of your device. Make sure the files on the device are compatible with the product.

[USB Device Photo File Specifications](#)

Parent topic: [Using External USB Devices with Your Product](#)

Related tasks

[Disconnecting a USB Device](#)

USB Device Photo File Specifications

You can use USB devices with your product containing files that meet these specifications.

File format	JPEG with the DCF (Design Rule for Camera File system) version 1.0 or 2.0 standard* TIFF 6.0-compliant uncompressed images: RGB full-color or binary (not CCITT-encoded)
Image size	80 × 80 pixels to 10200 × 10200 pixels
File size	Up to 2GB
Number of files	JPEG: Up to 9990 TIFF: Up to 999

* Files stored on digital cameras with built-in memory are not supported.

Parent topic: [Connecting a USB Device](#)

Disconnecting a USB Device

After you finish working with a USB device, follow these steps to remove it.

1. If your product is connected to your computer using a USB cable, do one of the following:
 - **Windows:** Open the **My Computer**, **Computer**, **This PC**, or **Windows Explorer** utility. Then right-click the name of your USB device (listed as a removable disk) and select **Eject**.
 - **Mac:** Drag the removable disk icon for your USB device from the desktop into the trash.

Caution: Do not remove a USB device before completing the procedure above or you may lose data from the flash drive.

2. Pull the USB device or cable out of the USB port on the front of the product.

Parent topic: [Using External USB Devices with Your Product](#)

Viewing and Printing from the LCD Screen

See these sections to view and print photos or other files displayed on your product's LCD screen.

[Printing JPEG Photos](#)

[Printing TIFF Files](#)

[Print Setting Options - Device Mode](#)

Parent topic: [Using External USB Devices with Your Product](#)

Printing JPEG Photos

You can select JPEG photos for printing as you view them on the LCD screen.

1. Press the  home button, if necessary.
2. Select **Memory Device**.
3. Select **JPEG**.

Note: If you have more than 999 JPEG images on your device, the images are divided into groups, and you must first select the group you want to display.

4. Do one of the following to select your photos:
 - In **Tile View**, select the thumbnail images of the photos you want to print.

- In **Single View**, select the thumbnail image of the photo you want to print, then press the left or right arrow buttons to scroll through and select additional photos, or select **Tile View** to return to the thumbnail image view and select additional photos.
 - To select all photos, select the  menu icon and select **Select All Images**.
5. Select **Proceed to Print**.
 6. To change the print settings, select **Basic Settings** and select the necessary settings.
 7. To adjust the photos (adjustments modify only your printed copies, not the original files), select **Advanced** and make the necessary adjustments.
 8. Select **Copies** on the LCD screen and use the numeric keypad on the screen to select the number of copies (up to 99).
 9. When you are ready to print, select the **Print** icon.

Note: To cancel printing, select **Cancel** on the LCD screen, then select **Cancel** again to confirm.

Parent topic: [Viewing and Printing from the LCD Screen](#)

Related references

[Print Setting Options - Device Mode](#)

[Print Setting Options - Device Mode](#)

Printing TIFF Files

You can select and print TIFF files from a USB flash drive.

1. Press the  home button, if necessary.
2. Select **Memory Device**.
3. Select **TIFF**.
You see a list of the available files.
4. Select the file you want to print.
You see information about the file.
5. Do the following as necessary:
 - To print more than one copy, select **Copies** on the LCD screen and use the numeric keypad on the screen to select the number of copies (up to 99).

- To change the print settings, select **Basic Settings** or **Advanced** and select the necessary settings.
6. When you are ready to print, select the **Print** icon.

Note: To cancel printing, select **Cancel**, then select **Cancel** again to confirm.

Parent topic: [Viewing and Printing from the LCD Screen](#)

Related references

[Print Setting Options - Device Mode](#)

[Print Setting Options - Device Mode](#)

Print Setting Options - Device Mode

Select the print settings you want to use when printing from a USB device.

Note: Not all options or settings may be available, depending on the file format.

Basic Settings

Print settings	Available options	Description
Paper Setting	Various paper size and type settings	Indicates the source that contains the paper size and type you want to print on
Color Mode	B&W	Prints the photo in black and white
	Color	Prints the photo in color

Advanced settings

Print settings	Available options	Description
Layout	Borderless	Expands the image to the edge of the paper (slight cropping may occur)
	With Border	Leaves a small margin around the image
	20-up	Prints 20 images on one page
	Index	Prints thumbnail images with file information

Print settings	Available options	Description
Fit Frame	On	Automatically crops the photo to fit into the selected photo layout
	Off	Turns off automatic cropping
Quality	Standard	Provides good quality for most prints
	Best	Provides the highest quality for special prints
Date	Various date formats	Prints the date the photo was taken on the photo in the format you select
Fix Photo	Auto	Automatically adjusts the brightness, contrast, and saturation of the photo based on the setting that is selected
	People	
	Landscape	
	Night Scene	
	Enhance Off	Turns off automatic adjustments; see Note below
Fix Red-Eye	On	Automatically fixes the red-eye effect in photos
	Off	
Print Order	Last Page on Top	Select the order for printing multi-page TIFF files
	First Page on Top	

Note: **Fix Photo** uses a sophisticated face recognition technology to optimize photos that include faces. For this to work, both eyes and the nose must be visible in the subject's face. If your photo includes a face with an intentional color cast, such as a statue, you may want to turn off **Fix Photo** to retain the special color effects.

Parent topic: [Viewing and Printing from the LCD Screen](#)

Transferring Files on a USB Device

You can transfer files to and from a USB device inserted into the USB port on the front of your product.

[Setting Up File Sharing for File Transfers from Your Computer](#)

[Transferring Files from a USB Device to Your Computer](#)

Parent topic: [Using External USB Devices with Your Product](#)

Setting Up File Sharing for File Transfers from Your Computer

Before you transfer files from a computer to a USB device inserted into the USB port on the front of your product, you may need to set up your product's file sharing settings.

Caution: Remove the USB device before you change this setting or you may lose data from the device.

1. Press the  home button, if necessary.
2. Select **Settings**.
3. Select **General Settings**.

You see a screen like this:



4. Select **Printer Settings**.
5. Select **Memory Device Interface**.

You see a screen like this:

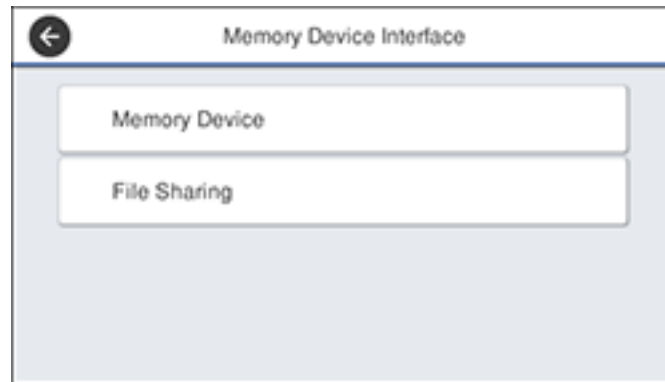

6. Make sure **Memory Device** is set to **Enable**.
7. Select **File Sharing**.
8. Select the way your computer is connected to the product: either **USB** or **Network**.

Parent topic: [Transferring Files on a USB Device](#)

Transferring Files from a USB Device to Your Computer

You can transfer files to and from a USB device inserted into the USB port on the front of your product and a computer connected to your product.

Note: Do not transfer files to and from a USB device while you are printing from the device.

1. Make sure your product is connected to a computer.
2. Insert a USB device into the USB port on the front of your product.
3. Do one of the following to access your USB device files from your computer:
 - **Windows:** Open the **My Computer**, **Computer**, **This PC**, or **Windows Explorer** utility, then select the removable disk icon.
 - **Mac with a USB connection:** Look for the removable disk icon on your desktop, then select it.
 - **Mac with a network connection:** Select the hard drive icon on your desktop or select **Computer** from the **Go** menu, select your product in the **SHARED** section of the sidebar (you may need to widen the sidebar to see the name), and select the **USBSTORAGE** icon.

4. Select the folder that contains your files.
5. Drag the files you want to transfer to the desired folder on your computer or on your USB device.

Note: Your product's LCD screen does not update to display new information about your USB device after you copy files to it or delete files from it. Remove and insert the USB device to update the information.

Parent topic: [Transferring Files on a USB Device](#)

Replacing Ink Cartridges and Maintenance Boxes

The maintenance box stores ink that gets flushed from the system during print head cleaning. When an ink cartridge is expended or the maintenance box is at the end of its service life, you need to replace it.

You may also need to replace a cartridge that is more than six months old if your printouts do not look their best, even after cleaning and aligning the print head.

Note: Please dispose of your used Epson branded ink cartridges and maintenance boxes responsibly and in accordance with local requirements. If you would like to return your used ink cartridges and maintenance boxes to Epson for proper disposal, please go to [epson.com/recycle](https://www.epson.com/recycle) for more information.

[Check Cartridge and Maintenance Box Status](#)

[Purchase Epson Ink Cartridges and Maintenance Box](#)

[Removing and Installing Ink Cartridges](#)

[Printing with Black Ink and Expended Color Cartridges](#)

[Conserving Low Black Ink with Windows](#)

[Replacing the Maintenance Box](#)

Check Cartridge and Maintenance Box Status

Your product and its software will let you know when an ink cartridge is low or expended, or when the maintenance box needs to be replaced.

[Checking Cartridge Status on the LCD Screen](#)

[Checking Cartridge and Maintenance Box Status with Windows](#)

[Checking Cartridge and Maintenance Box Status - Mac](#)

Parent topic: [Replacing Ink Cartridges and Maintenance Boxes](#)

Checking Cartridge Status on the LCD Screen

You can check the status of the cartridges and maintenance box using your product's LCD screen.

Press the Δ supply status button. You see a screen like this:

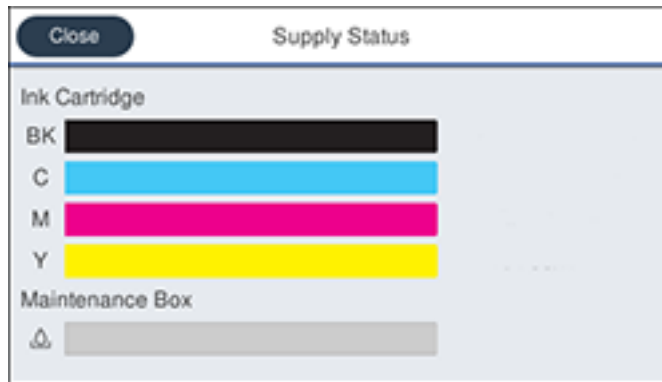

Note: The displayed ink and maintenance box levels are approximate.

Parent topic: [Check Cartridge and Maintenance Box Status](#)

Related tasks

[Removing and Installing Ink Cartridges](#)

[Replacing the Maintenance Box](#)

Checking Cartridge and Maintenance Box Status with Windows

A low ink reminder appears if you try to print when ink is low, and you can check your cartridge or maintenance box status at any time using a utility on your Windows computer.

1. To check your status, access the Windows Desktop, double-click the product icon in the Windows taskbar, and click **Details**.

You see this window:



2. Replace or reinstall the maintenance box or any ink cartridge as indicated on the screen.

Note: If any of the cartridges installed in the product is broken, incompatible with the product model, or improperly installed, Epson Status Monitor will not display an accurate cartridge status.

3. To disable the low ink reminder, right-click the product icon in the Windows taskbar and select **Monitoring Preferences**.

You see this window:

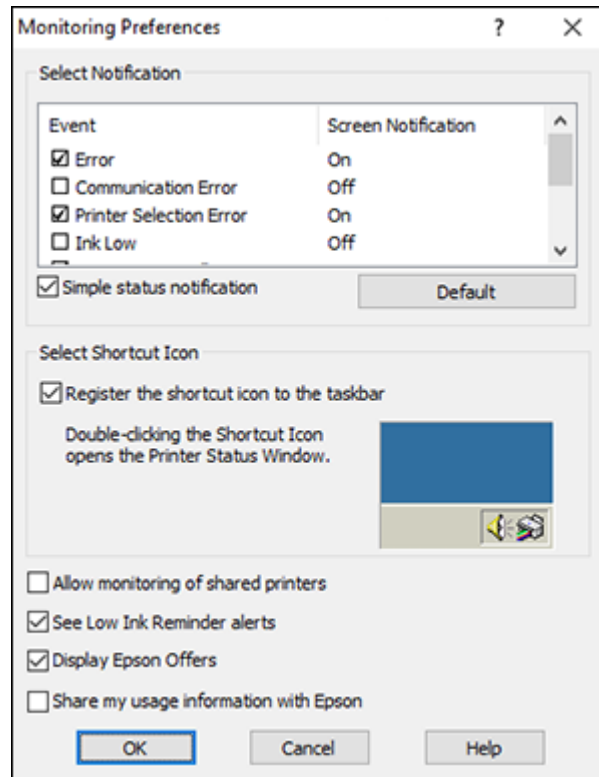

4. Deselect the **See Low Ink Reminder alerts** checkbox at the bottom of the screen.
5. To disable promotional offers, deselect the **Display Epson Offers** checkbox.
6. Click **OK**.

Parent topic: [Check Cartridge and Maintenance Box Status](#)

Related tasks

[Removing and Installing Ink Cartridges](#)

[Replacing the Maintenance Box](#)

Checking Cartridge and Maintenance Box Status - Mac

You can check the status of your ink cartridges and maintenance box using a utility on your Mac.

1. In the Apple menu or the Dock, select **System Preferences**. Select **Print & Fax**, **Print & Scan**, or **Printers & Scanners**, select your product, and select **Options & Supplies**. Select **Utility** and select **Open Printer Utility**.
2. Select **EPSON Status Monitor**.

You see this window:

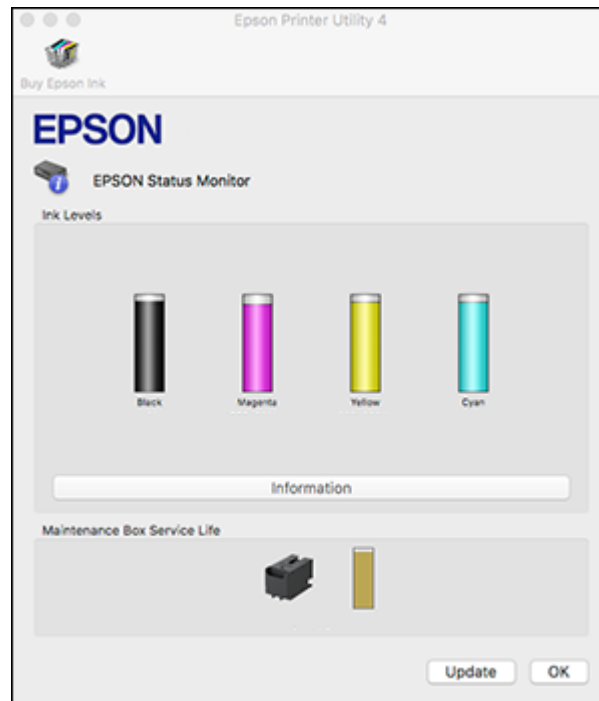

3. Do the following as necessary:
 - You can update the ink cartridge and maintenance box status by clicking **Update**.
 - Replace or reinstall the ink cartridge or maintenance box as indicated on the screen.

Note: If any of the cartridges installed in the product is broken, incompatible with the product model, or improperly installed, Epson Status Monitor will not display an accurate cartridge status.

Parent topic: [Check Cartridge and Maintenance Box Status](#)

Related tasks

[Removing and Installing Ink Cartridges](#)

[Replacing the Maintenance Box](#)

Purchase Epson Ink Cartridges and Maintenance Box

You can purchase genuine Epson ink, maintenance boxes, and paper at epson.com (U.S. sales) or epson.ca (Canadian sales). You can also purchase supplies from an Epson authorized reseller. To find the nearest one, call 800-GO-EPSON (800-463-7766) in the U.S. or 800-807-7766 in Canada.

[Ink Cartridge and Maintenance Box Part Numbers](#)

Parent topic: [Replacing Ink Cartridges and Maintenance Boxes](#)

Ink Cartridge and Maintenance Box Part Numbers

Use these part numbers when you order or purchase a new maintenance box or ink cartridges.

Maintenance box part number: T67150

Note: For best printing results, use up a cartridge within 6 months of opening the package.

Ink color	Part number	
	Standard-capacity	High-capacity
Black	802	802XL
Cyan	802	802XL
Magenta	802	802XL
Yellow	802	802XL

Parent topic: [Purchase Epson Ink Cartridges and Maintenance Box](#)

Removing and Installing Ink Cartridges

Make sure you have your replacement cartridges handy before you begin. You must install new cartridges immediately after removing the old ones.

Caution: Leave your old cartridges in the printer until you are ready to replace them to prevent the print head nozzles from drying out. Do not open ink cartridge packages until you are ready to install the ink. Cartridges are vacuum packed to maintain reliability.

1. Turn on your product.
 - If an ink cartridge is expended, you see a message on the LCD screen. Note which cartridges need to be replaced and select **How to**.
 - If you are replacing a cartridge before you see a message on the LCD screen, press the  home button if necessary, and select **Maintenance > Ink Cartridge(s) Replacement > Start**.
2. Lift up the scanner unit until it clicks.

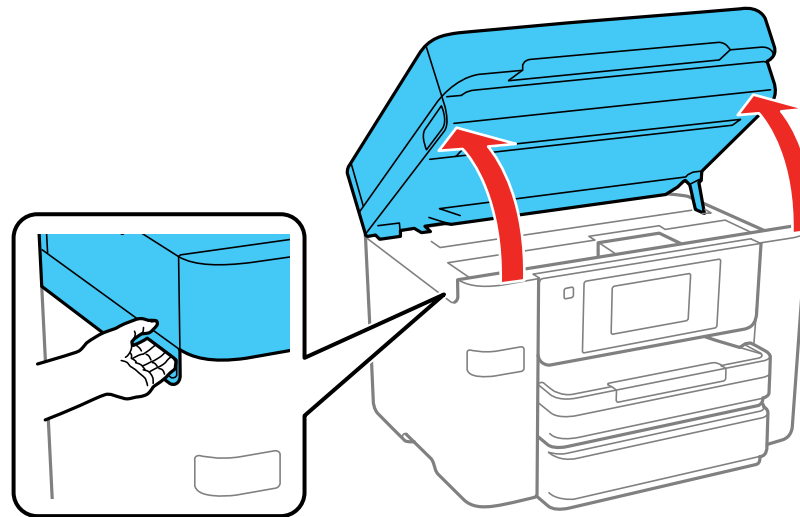

Caution: Do not move the print head by hand; otherwise, you may damage your product. Do not touch the flat white cable inside the printer.

3. Squeeze the tab on the cartridge and lift the cartridge straight up to remove it.

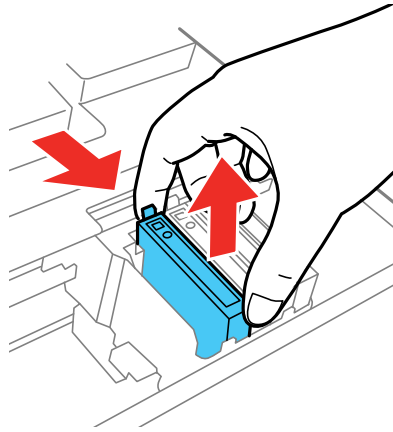

Note: Dispose of used cartridges carefully. Do not take the used cartridge apart or try to refill it.

Warning: If ink gets on your skin, wash it thoroughly with soap and water. If ink gets into your eyes, flush them immediately with water. If ink gets into your mouth, spit it out and see a doctor right away. Keep ink cartridges out of the reach of children.

4. Before opening the new cartridge package, shake it gently four or five times.

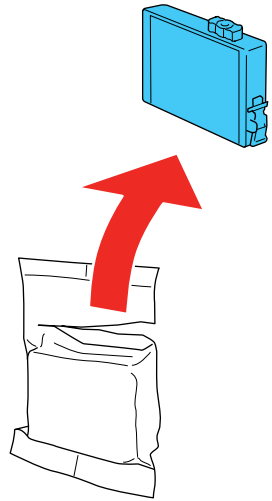

Caution: Do not shake the cartridges after opening the packages, or ink may leak.

5. Remove the cartridge from the package.

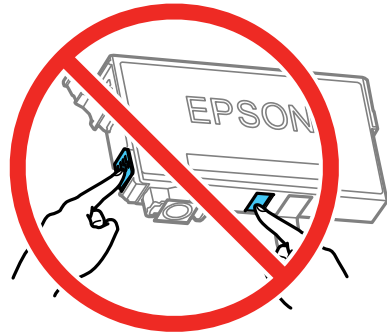

Caution: Do not touch the green chip on the cartridge. Install the new cartridge immediately after removing the old one; if you do not, the print head may dry out and be unable to print.

6. Remove the yellow tape from the base of the cartridge.

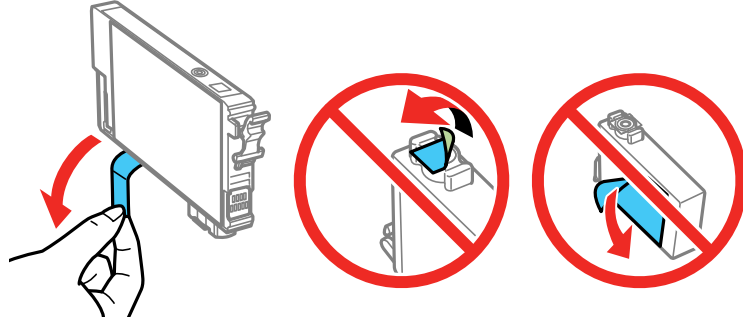

Caution: Do not remove any other labels or seals, or ink will leak.

7. Insert the new cartridge into the holder and push it down until it clicks into place.

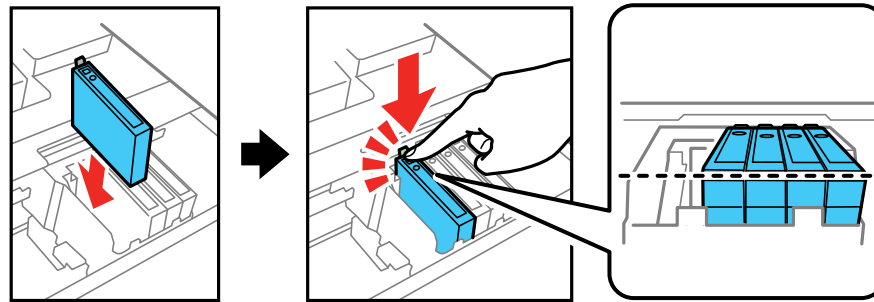

- Lower the scanner unit and select **Completed** on the LCD screen.

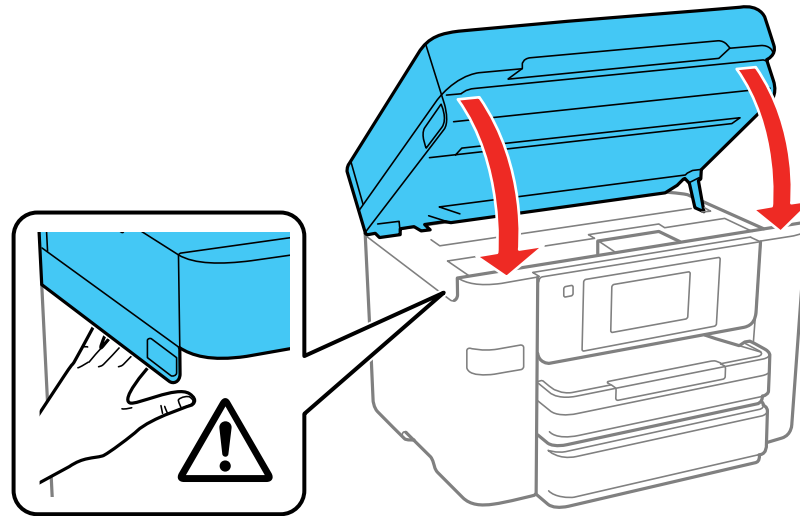

The print head moves to its home position and the printer starts charging the ink. This takes about 90 seconds. When you see a confirmation message on the screen, ink charging is finished.

Caution: Never turn off the product while the power light is flashing or you will waste ink.

If you see an error screen telling you an ink cartridge is installed incorrectly, lift up the scanner unit and press the ink cartridge down until it clicks into place. When you're finished, select **OK**.

If you remove a low or expended ink cartridge, you cannot re-install and use the cartridge.

Caution: If you remove an ink cartridge for later use, protect the ink supply area from dirt and dust and store it in the same environment as the printer. The valve in the ink supply port is designed to contain any excess ink, but do not touch the ink supply port or surrounding area. Always store ink cartridges with the label facing up; do not store cartridges upside-down.

Parent topic: [Replacing Ink Cartridges and Maintenance Boxes](#)

Related concepts

[Purchase Epson Ink Cartridges and Maintenance Box](#)

Printing with Black Ink and Expended Color Cartridges

When a color ink cartridge is expended, you can temporarily continue printing from your computer using black ink. Replace the expended color cartridge as soon as possible for future printing.

Note: You cannot print with expended color ink cartridges using your product's control panel.

[Printing with Expended Color Cartridges - Windows](#)

[Printing with Expended Color Cartridges - Mac](#)

Parent topic: [Replacing Ink Cartridges and Maintenance Boxes](#)

Printing with Expended Color Cartridges - Windows

If you see a message during printing telling you that you can temporarily print in black ink with an expended color cartridge, you can cancel your print job and select settings to print on plain paper or on an envelope.

Note: To use this feature, Epson Status Monitor must be enabled.

Note: While a color cartridge is expended, you cannot print faxes, make copies, or print from Epson Connect or a mobile device.

1. Click **Cancel** or **Cancel Print** to cancel your print job.

Note: If the message screen appears on another computer on a network, you may need to cancel the print job using the product control panel.

2. Load plain paper or an envelope in your product.
3. Access the print settings in your print application.
4. Click the **Main** tab.
5. Select **Plain Paper/Bright White Paper** or **Envelope** as the paper type setting.
6. Select the **Black/Grayscale** checkbox.
7. Click **OK**.
8. Print your document.
Epson Status Monitor 3 displays a print message.
9. Click **Print in Black** to print your document.

Parent topic: [Printing with Black Ink and Expended Color Cartridges](#)

Printing with Expended Color Cartridges - Mac

If printing stops, you can cancel your print job and select settings to temporarily print with only black ink on plain paper or on an envelope.

Note: While a color cartridge is expended, you cannot print faxes, make copies, or print from Epson Connect or a mobile device.

1. Click the printer icon in the Dock.
2. If you see a message telling you that you can temporarily print with only black ink, click the **Delete** or  button to cancel your print job. If you see an error message, click **OK**.

Note: If the message screen appears on another computer on a network, you may need to cancel the print job using the product control panel.

3. In the Apple menu or the Dock, select **System Preferences**.
4. Select **Print & Fax**, **Print & Scan**, or **Printers & Scanners**, select your product, and select **Options & Supplies**.
5. Select **Driver** or **Options**.

You see a screen like this:

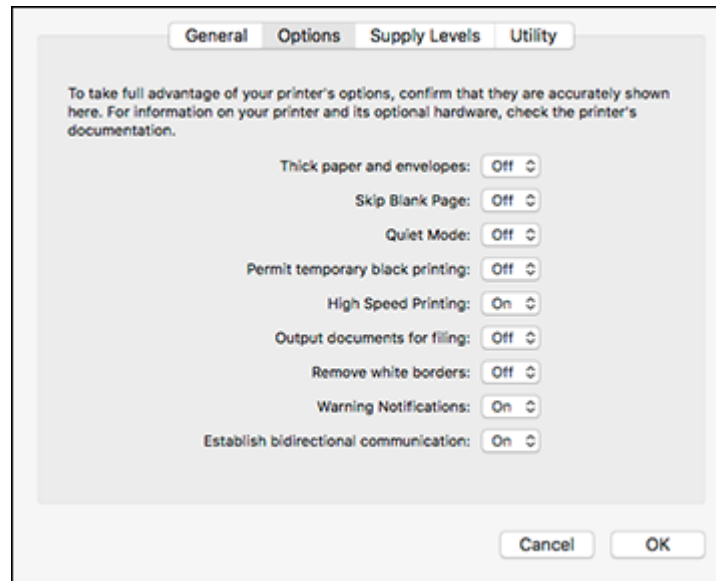

6. Select **On** as the **Permit temporary black printing** setting.
7. Click **OK**.
8. Close the utility window.
9. Load plain paper or an envelope in your product.
10. Access the print settings in your print application.
11. Select **Print Settings** from the pop-up menu.
12. Select **Plain Paper/Bright White Paper** or **Envelope** as the paper type setting.
13. Select the **Grayscale** option.
14. Click **Print** to print your document.

Parent topic: [Printing with Black Ink and Expended Color Cartridges](#)

Conserving Low Black Ink with Windows

The following window appears when black ink runs low and there is more color ink.

Note: The window appears only when you have selected **Plain Paper/Bright White Paper** as the paper type setting, and depends on other selected print settings. To use this feature, Epson Status Monitor must be enabled.

- Click **Yes** to use a mixture of color inks to create black, or **No** to continue using the remaining black ink for the document you are printing.
- Click **Disable this feature** to continue using the remaining black ink.

Note: If you disable this feature, it remains disabled until you install a new black ink cartridge.

Parent topic: [Replacing Ink Cartridges and Maintenance Boxes](#)

Replacing the Maintenance Box

Make sure you have a new maintenance box before you begin.

Caution: Do not reuse a maintenance box that has been removed and left uninstalled for more than a week. Keep the maintenance box away from direct sunlight.

1. Make sure the product is not printing.
2. Remove the new maintenance box from its package.

Caution: Do not touch the green chip on the maintenance box.

3. Press the tab on the maintenance box cover and remove it.

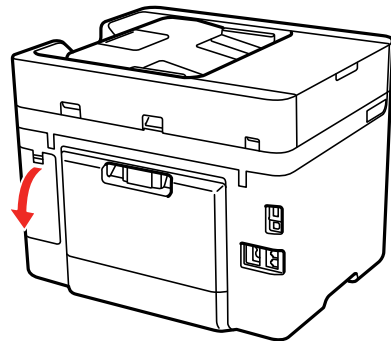

4. Grasp the maintenance box as shown and pull it out of its holder.

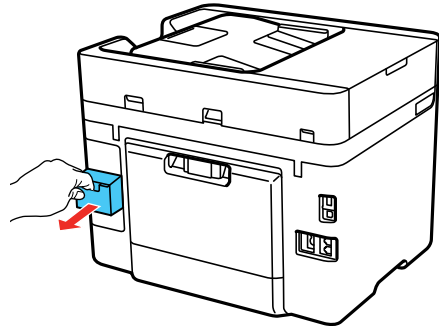

Note: Do not tilt the used maintenance box or take it apart.

Warning: If ink gets on your skin, wash it thoroughly with soap and water. If ink gets into your eyes, flush them immediately with water. If ink gets into your mouth, spit it out and see a doctor right away. Keep the maintenance box out of the reach of children and do not drink the ink.

5. Place the used maintenance box in the plastic bag that came with the new maintenance box. Seal the bag and dispose of it carefully.

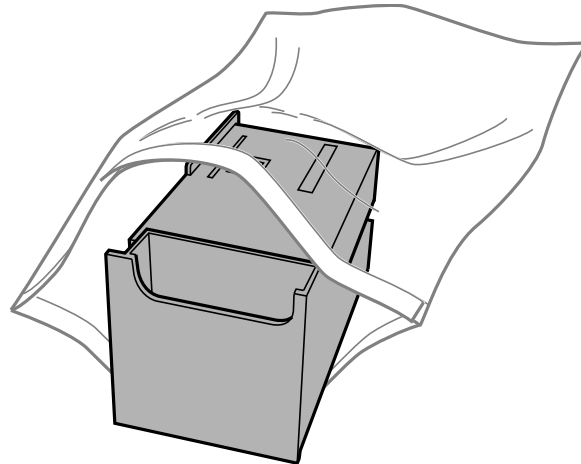

6. Insert the new maintenance box into the holder and push it all the way in.

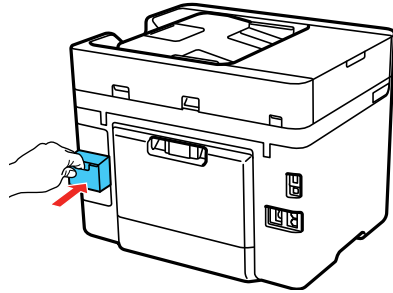

7. Press the tab on the maintenance box cover and reattach it.

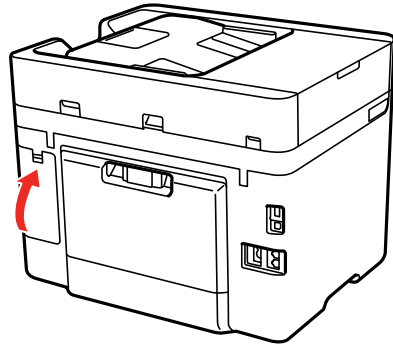

Parent topic: [Replacing Ink Cartridges and Maintenance Boxes](#)

Related concepts

[Purchase Epson Ink Cartridges and Maintenance Box](#)

Adjusting Print Quality

If your print quality declines, you may need to run a utility to clean or align the print head.

If running these utilities does not solve the problem, you may need to replace the ink cartridges.

[Print Head Maintenance](#)

[Aligning the Print Head Using the Product Control Panel](#)

[Cleaning the Paper Guide](#)

Print Head Maintenance

If your printouts become too light, or you see dark or light bands across them, you may need to clean the print head nozzles. Cleaning uses ink, so clean the nozzles only if print quality declines.

You can check for clogged nozzles before you clean them so you don't clean them unnecessarily.

Note: You cannot clean the print head if an ink cartridge is expended, and may not be able to clean it when a cartridge is low. You must replace the cartridge first.

[Print Head Nozzle Check](#)

[Print Head Cleaning](#)

Parent topic: [Adjusting Print Quality](#)

Related concepts

[Purchase Epson Ink Cartridges and Maintenance Box](#)

Print Head Nozzle Check

You can print a nozzle check pattern to check for clogged nozzles.

[Checking the Nozzles Using the Product Control Panel](#)

[Checking the Nozzles Using a Computer Utility](#)

Parent topic: [Print Head Maintenance](#)

Checking the Nozzles Using the Product Control Panel

You can check the print head nozzles using the control panel on your product.

1. Make sure there are no errors on the LCD screen.
2. Load a few sheets of plain paper in the product.

3. Press the  home button, if necessary.
4. Select **Maintenance**.

You see a screen like this:

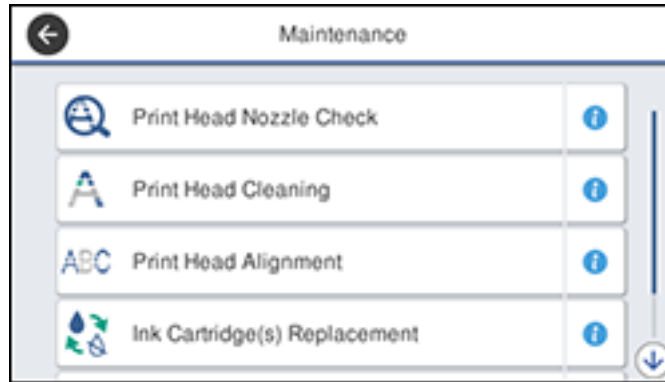

5. Select **Print Head Nozzle Check**.

You see a screen like this:

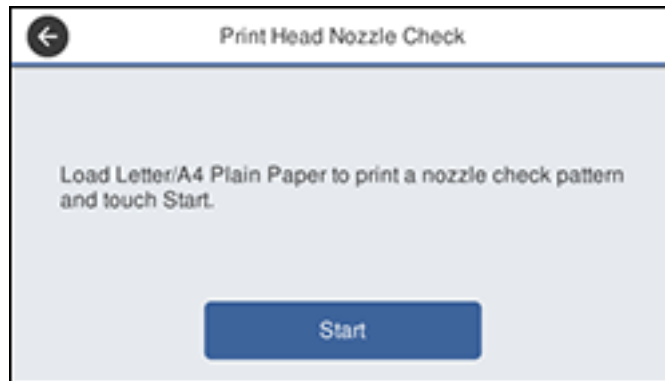

6. Select **Start**.

The nozzle pattern prints.

7. Check the printed pattern to see if there are gaps in the lines.

Print head is clean



Print head needs cleaning



8. Do one of the following:
 - If there are no gaps, select **O**.
 - If there are gaps or the pattern is faint, select **X** and continue.
9. Follow the instructions on the screen to clean the print head, check the nozzles, and repeat the process as necessary.

Caution: Never turn off the product or open the front cover during a cleaning cycle or you may not be able to print.

If you don't see any improvement after cleaning the print head up to 4 times, wait at least 6 hours without printing or longer if printing. Then try cleaning the print head again. If quality still does not improve, one of the ink cartridges may be old or damaged and needs to be replaced.

Parent topic: [Print Head Nozzle Check](#)

Related concepts

[Print Head Cleaning](#)

Checking the Nozzles Using a Computer Utility

You can check the print head nozzles using a utility on your Windows or Mac computer.

1. Load a few sheets of plain paper in the product.

2. Do one of the following:
 - **Windows:** Access the Windows Desktop and right-click the product icon in the Windows taskbar.
 - **Mac:** In the Apple menu or the Dock, select **System Preferences**. Select **Print & Fax**, **Print & Scan**, or **Printers & Scanners**, select your product, and select **Options & Supplies**. Select **Utility** and select **Open Printer Utility**.

3. Select **Nozzle Check**.

You see a window like this:

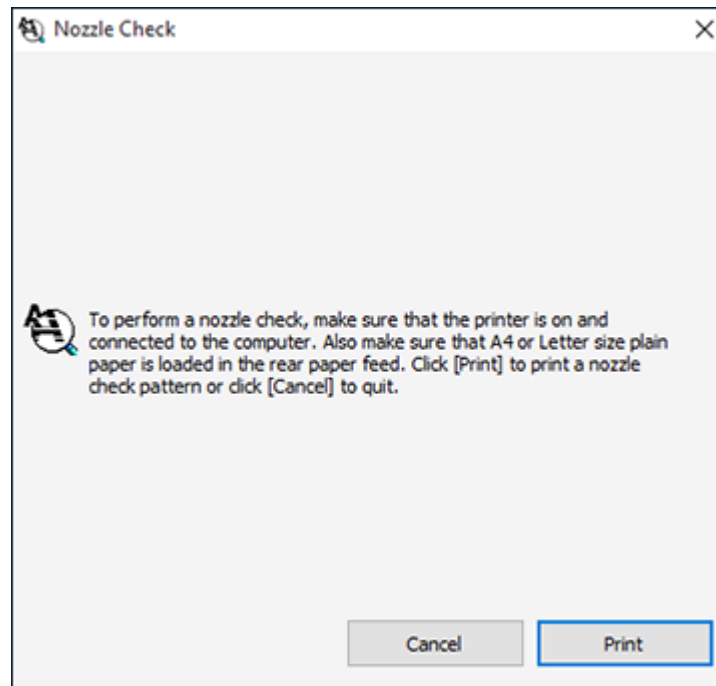

4. Click **Print**.

5. Check the printed pattern to see if there are gaps in the lines.

Print head is clean



Print head needs cleaning



6. If there are no gaps, click **Finish**.
If there are gaps or the pattern is faint, clean the print head.

Parent topic: [Print Head Nozzle Check](#)

Related concepts

[Print Head Cleaning](#)

Print Head Cleaning

If print quality has declined and the nozzle check pattern indicates clogged nozzles, you can clean the print head.

Note: You cannot clean the print head if an ink cartridge is expended, and may not be able to clean it when a cartridge is low. You must replace the cartridge first.

[Cleaning the Print Head Using the Product Control Panel](#)

[Cleaning the Print Head Using a Computer Utility](#)

Parent topic: [Print Head Maintenance](#)

Related concepts

[Purchase Epson Ink Cartridges and Maintenance Box](#)

Related tasks

[Removing and Installing Ink Cartridges](#)

Cleaning the Print Head Using the Product Control Panel

You can clean the print head using the control panel on your product.

1. Make sure there are no errors on the LCD screen.
2. Load a few sheets of plain paper in the product.
3. Press the  home button, if necessary.
4. Select **Maintenance**.

You see a screen like this:

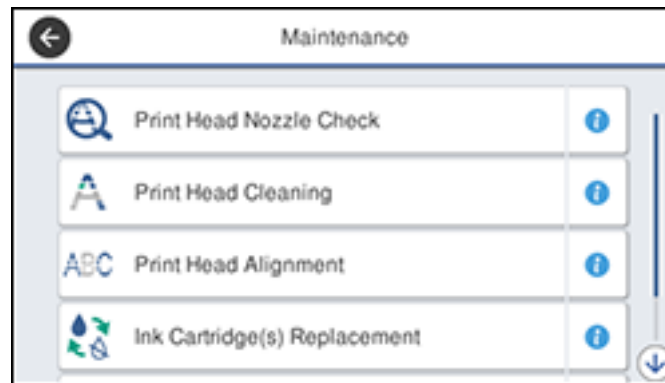

5. Select **Print Head Cleaning**.

You see a screen like this:

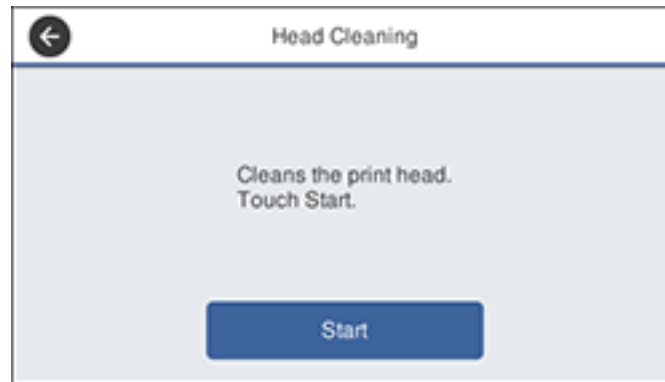

6. Select **Start** to clean the print head.

When the cleaning cycle is finished, you see a message on the screen.

Caution: Never turn off the product or open the front cover during a cleaning cycle or you may not be able to print.

7. Select **Yes**.
8. Select **Start** to confirm that the print head is clean.

If you don't see any improvement after cleaning the print head up to 4 times, wait at least 6 hours without printing or longer if printing. Then try cleaning the print head again. If quality still does not improve, contact Epson.

Parent topic: [Print Head Cleaning](#)

Related tasks

[Loading Paper in the Cassette](#)

Cleaning the Print Head Using a Computer Utility

You can clean the print head using a utility on your Windows or Mac computer.

1. Load a few sheets of plain paper in the product.
2. Do one of the following:
 - **Windows:** Access the Windows Desktop and right-click the product icon in the Windows taskbar.

- **Mac:** In the Apple menu or the Dock, select **System Preferences**. Select **Print & Fax**, **Print & Scan**, or **Printers & Scanners**, select your product, and select **Options & Supplies**. Select **Utility** and select **Open Printer Utility**.

3. Select **Head Cleaning**.

You see a window like this:

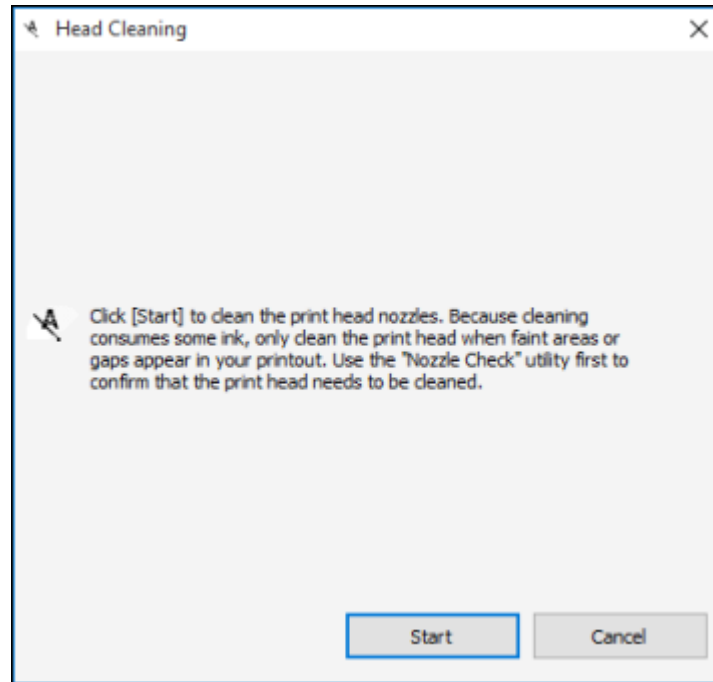

4. Click **Start** to begin the cleaning cycle.

The  power light flashes throughout the cleaning cycle and stays on when the cleaning cycle is finished.

Caution: Never turn off the product during a cleaning cycle or you may damage it.

5. When the cleaning cycle is finished, you can check to see if the nozzles are clean; click **Print Nozzle Check Pattern** and click **Print**.

6. Check the printed pattern to see if there are gaps in the lines.

Print head is clean



Print head needs cleaning



- If there are no gaps, click **Finish**.
- If there are gaps or the pattern is faint, click **Clean** to clean the print head again.

If you don't see any improvement after cleaning the print head up to 4 times, wait at least 6 hours without printing or longer if printing. Then try cleaning the print head again. If quality still does not improve, contact Epson.

Parent topic: [Print Head Cleaning](#)

Related tasks

[Loading Paper in the Cassette](#)

Aligning the Print Head Using the Product Control Panel

You can align the print head using the control panel on your product.

1. Make sure there are no errors on the LCD screen.
2. Load a few sheets of plain paper in the product.
3. Press the  home button, if necessary.
4. Select **Maintenance**.

You see a screen like this:

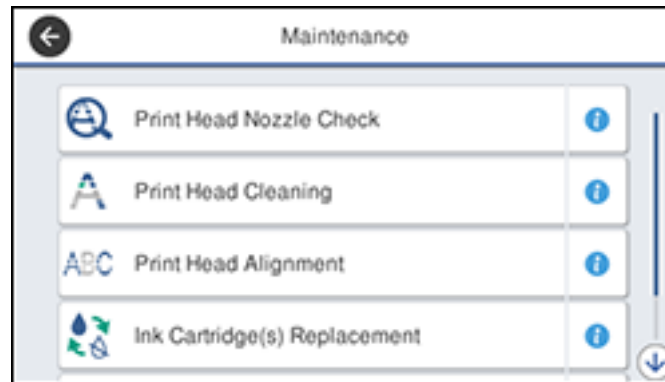

5. Select **Print Head Alignment** .
6. Select one of the following options:
 - **Ruled Line Alignment** if vertical lines in your printout are misaligned.
 - **Vertical Alignment** if your printout is blurry.
 - **Horizontal Alignment** if your printout contains horizontal banding.
7. Follow the on-screen instructions to print an alignment sheet.

Note: Do not cancel printing while you are printing head alignment patterns.

8. Check the printed patterns on the alignment sheet and select the following on the LCD screen, depending on the alignment pattern you printed:
 - **Ruled Line Alignment:** For patterns 1 and 2, select the number representing the pattern with the least misaligned vertical line.

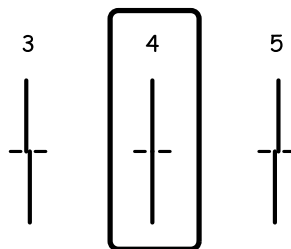

- **Vertical Alignment:** For patterns 1 through 4, select the number representing the pattern with the least amount of separation or overlap.

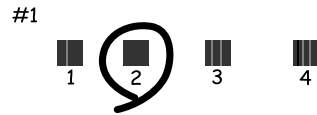

- **Horizontal Alignment:** Select the number representing the pattern with the least amount of separation or overlap.



9. Select **Done**.

Parent topic: [Adjusting Print Quality](#)

Related tasks

[Loading Paper in the Cassette](#)

Cleaning the Paper Guide

If you see ink on the back of a printout, you can clean the paper guide rollers to remove any excess ink. If paper does not feed correctly from the rear paper feed slot, you can use a cleaning sheet to clean the rollers.

1. If printouts are smeared or scuffed, load plain paper in the paper source that you want to clean in this size: Letter (8.5 × 11 inches [216 × 279 mm]) or A4 (8.3 × 11.7 inches [210 × 297 mm]).
2. Select **Settings**.
3. Select **Maintenance**.

You see a screen like this:

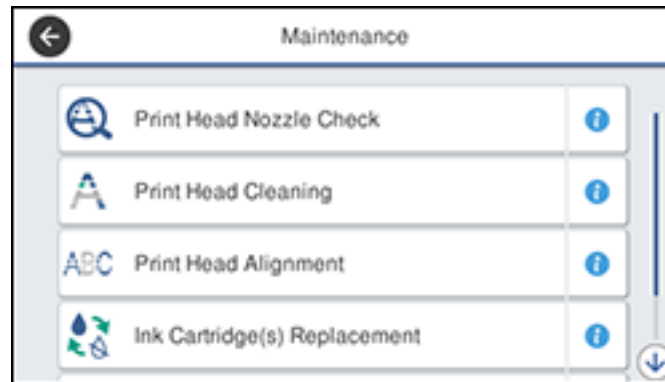

4. Scroll down and select **Paper Guide Cleaning**.
5. Select the paper source you want to clean.
6. Follow the on-screen instructions to clean the paper guide.
7. Repeat these steps as necessary until the paper comes out clean. If you are using a cleaning sheet, repeat these steps up to 3 times.

Note: If the paper is not clean after cleaning several times, try cleaning the other paper sources.

Parent topic: [Adjusting Print Quality](#)

Related tasks

[Loading Paper in the Cassette](#)

Cleaning and Transporting Your Product

See these sections if you need to clean or transport your product.

[Cleaning Your Product](#)

[Transporting Your Product](#)

Cleaning Your Product

To keep your product working at its best, you should clean it several times a year.

Caution: Do not use a hard brush, alcohol, or paint thinner to clean the product or you may damage it. Do not use oil or other lubricants inside the product or let water get inside it.

1. Turn off the product.
2. Unplug the power cord.
3. Disconnect any connected cables.
4. Remove all the paper from the product.

5. Open the document cover.

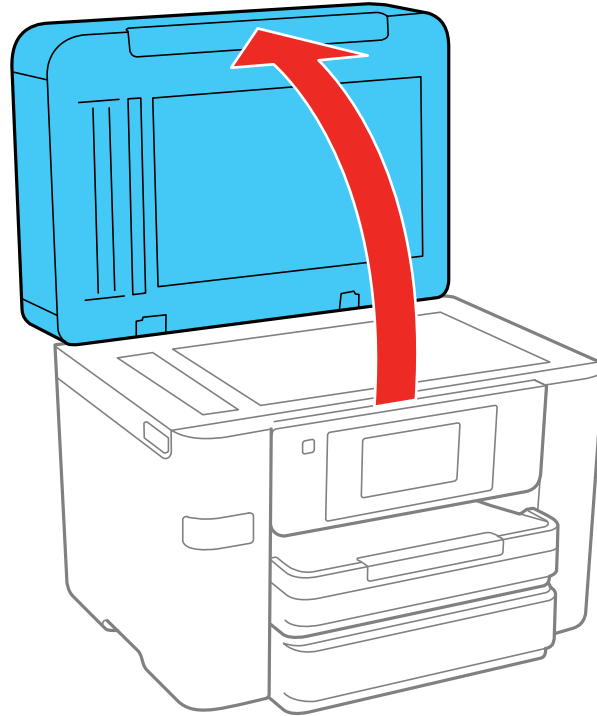

6. Clean the scanner glass and the glass area on the left with a soft, lint-free cloth (microfiber is recommended) moistened with a little glass cleaner.

Caution: Do not spray glass cleaner directly on the glass and do not press the glass surface with any force.

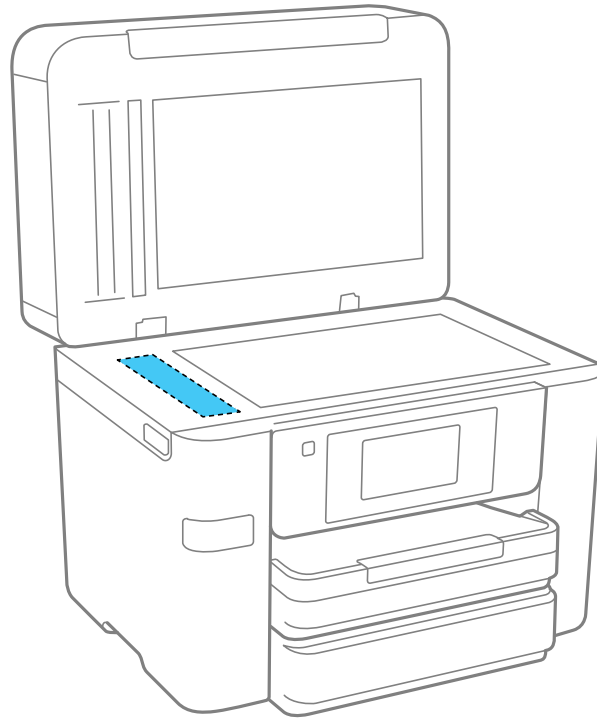

Note: If lines appear on the printout or in scanned images, carefully clean the scanner glass on the left.

7. Close the document cover.

8. Open the ADF cover.

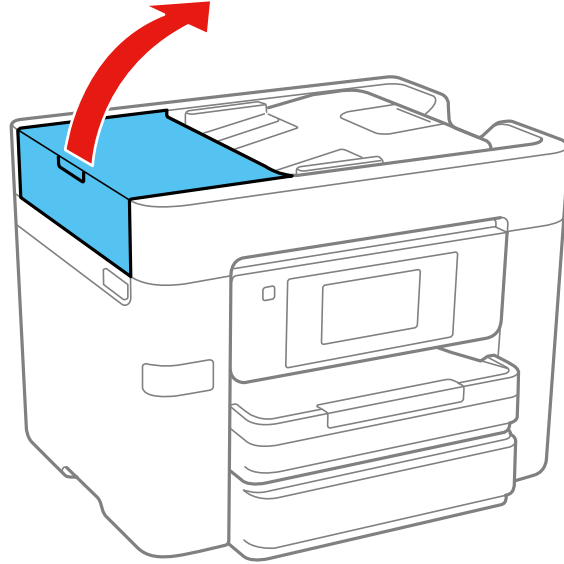

9. Use a soft, dry, lint-free cloth (microfiber is recommended) to clean the rollers and the interior of the ADF.

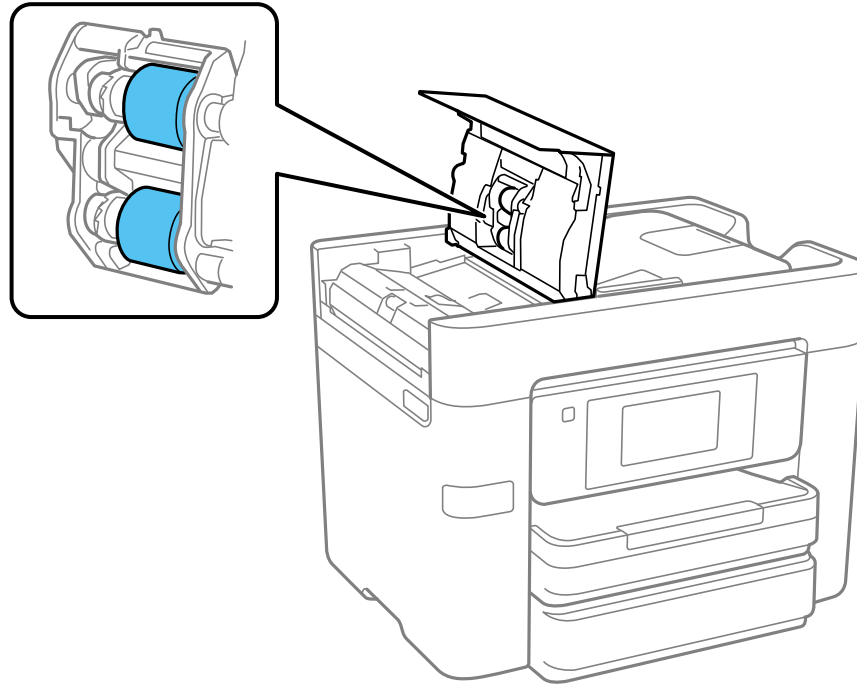

10. Clean the outer case and control panel with a soft, dry cloth. Do not use liquid or chemical cleansers.

Parent topic: [Cleaning and Transporting Your Product](#)

Transporting Your Product

If you need to store your product or transport it a long distance, prepare it for transportation as described here.

Caution: During transportation and storage, follow these guidelines:

- Avoid tilting the product, placing it vertically, or turning it upside down; otherwise ink may leak.
- Leave the ink cartridges installed. Removing the cartridges can dry out the print head and may prevent the product from printing.
- Do not carry the product by its control panel; this may damage the product.

Note: Before storing your product for a long period, replace low, expended, or expired ink to help prevent the print head from drying out. Store your product in a cool, dry place.

1. Turn off the product.
2. Wait for the  power light to go out, then unplug the power cable.
3. Disconnect any connected cables.
4. Remove all the paper from the product.
5. Close the output tray and paper support.

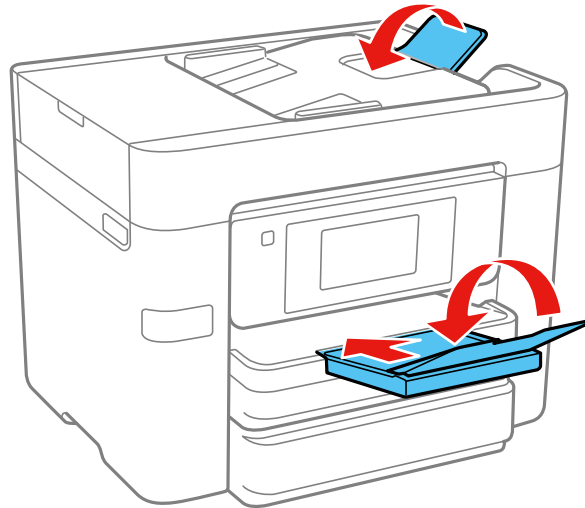

6. Remove any memory device inserted in the product.
7. Lift up the scanner unit and check to see if the print head is in the far right position (the home position). If not, turn on the product, wait for the print head to move, then turn the product off again.

- Secure the ink cartridge holder to the case with tape.

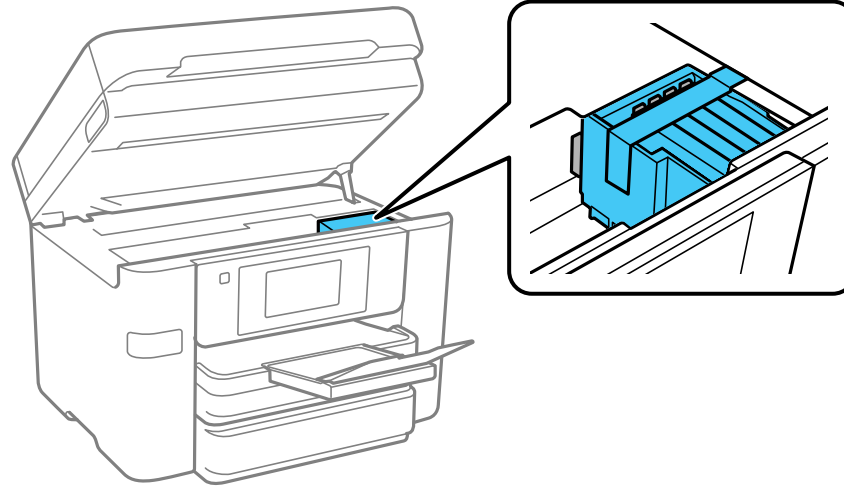

- Lower the scanner unit.
- Lower the control panel.
- Place the product in its original packing materials, if possible, or use equivalent materials with cushioning around the product.

Keep the product level during transportation. Be sure to remove the tape from the ink cartridge holder before turning on your product. If print quality has declined when you print again, clean and align the print head.

Parent topic: [Cleaning and Transporting Your Product](#)

Related concepts

[Print Head Nozzle Check](#)

[Print Head Cleaning](#)

Solving Problems

Check these sections for solutions to problems you may have using your product.

[Product Status Messages](#)

[Running a Product Check](#)

[Resetting Control Panel Defaults](#)

[Solving Setup Problems](#)

[Solving Network Problems](#)

[Solving Copying Problems](#)

[Solving Paper Problems](#)

[Solving Problems Printing from a Computer](#)

[Solving Page Layout and Content Problems](#)

[Solving Print Quality Problems](#)

[Solving Scanning Problems](#)

[Solving Scanned Image Quality Problems](#)

[Solving Faxing Problems](#)

[Solving USB Device Problems](#)

[Uninstall Your Product Software](#)

[Where to Get Help](#)

Product Status Messages

You can often diagnose problems with your product by checking the messages on its LCD screen.

Note: If the screen is dark, press the screen to wake the product from sleep mode.

LCD screen message	Condition/solution
Printer error. Turn the power off and on again. If the problem persists, contact Epson Support.	Turn the product off and then back on again. If the error persists, check for and remove any jammed paper or protective materials from the product. If the error still persists, contact Epson for support.
Paper out in XX. Load paper and touch OK. XX/XX	Load the size and type of paper in the paper source indicated.
You need to replace Ink Cartridges	Replace the indicated ink cartridges.

LCD screen message	Condition/solution
Paper Configuration is disabled. Some features may not be available. For details, see your documentation.	AirPrint is not available when the Paper Setup Auto Display setting is disabled. Change the Paper Setup Auto Display setting to On .
No dial tone is detected.	Make sure the phone cable is connected correctly and the phone line works. If you connected the product to a PBX (Private Branch Exchange) phone line or Terminal Adapter, change the Line Type setting to PBX . If you still cannot send a fax, turn off the Dial Tone Detection setting. (Turning off the Dial Tone Detection setting may cause the product to drop the first digit of a fax number.)
The combination of the IP address and the subnet mask is invalid. See your documentation for more details	There is a problem with the network connection to your product. Set up your product on the network again.
To use cloud services, update the root certificate from the Epson Web Config utility	Access the Web Config utility and update the cloud service root certificate.
Check that the printer driver is installed on the computer and that the port settings for the printer are correct.	Make sure the printer port is correctly configured. In Windows, make sure the port is set to a USBXXX setting for a USB connection or EpsonNet Print Port for a network connection.
Check that the printer driver is installed on the computer and that the USB port settings for the printer are correct.	
Recovery mode	An error has occurred during firmware updating. Connect your product using a USB cable and try downloading the Firmware Update from the Epson support site. If you still need help, contact Epson for support.

Parent topic: [Solving Problems](#)

Related tasks

[Checking for Software Updates](#)

[Connecting a Telephone or Answering Machine](#)

[Using AirPrint](#)

Related topics

[Solving Paper Problems](#)

[Wi-Fi or Wired Networking](#)

Running a Product Check

Running a product check helps you determine if your product is operating properly.

1. Disconnect any interface cables connected to your product.
2. Load plain paper in the product.
3. Press the  home button, if necessary.
4. Select **Maintenance**.

You see a screen like this:

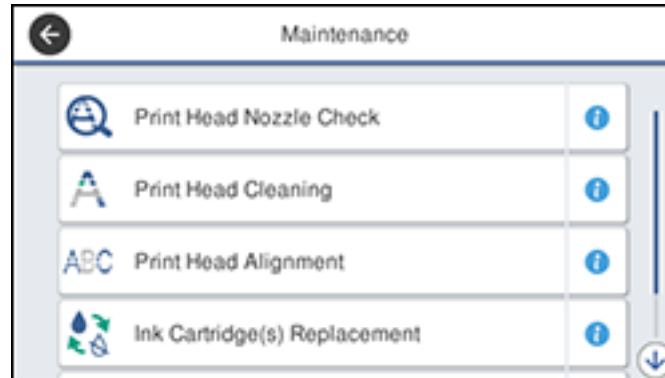

5. Select **Print Head Nozzle Check**.

You see a screen like this:

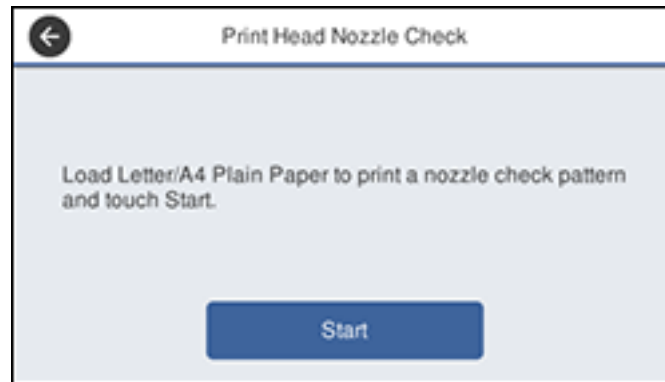

6. Select **Start**.
The nozzle pattern prints.
7. Do one of the following, depending on the results of the product check:
 - If the page prints and the nozzle check pattern is complete, the product is operating properly. Any operation problem you may have could be caused by your computer, cable, software, or selected settings. Check the other solutions in this book or try uninstalling and reinstalling your printer software.
 - If the page prints but the nozzle check pattern has gaps, clean the print head.
 - If the page does not print, the product may have a problem. Check the other solutions in this manual. If they do not work, contact Epson.

Parent topic: [Solving Problems](#)

Related concepts

[Uninstall Your Product Software](#)

[Print Head Cleaning](#)

Related tasks

[Aligning the Print Head Using the Product Control Panel](#)

Resetting Control Panel Defaults

If you have a problem with settings on the product control panel, you can reset them to their factory defaults. You can choose which settings to reset or reset them all.

Note: This setting can be locked by an administrator. If you cannot access or change this setting, contact your administrator for assistance.

1. Press the  home button, if necessary.
2. Select **Settings**.
3. Scroll down and select **Restore Default Settings**.

You see a screen like this:



4. Select one of these options:
 - **Network Settings:** Resets all network settings
 - **Copy Settings:** Resets all settings for copying
 - **Scan Settings:** Resets all settings for scanning
 - **Fax Settings:** Resets all settings for faxing
 - **Clear All Data and Settings:** Resets all control panel settings including the contacts list

You see a confirmation screen.

5. Select **Yes** to reset the selected settings. (Select **No** if you want to cancel the operation.)

Parent topic: [Solving Problems](#)

Solving Setup Problems

Check these sections if you have problems while setting up your product.

[Product Does Not Turn On or Off](#)

[Noise After Ink Installation](#)

[Software Installation Problems](#)

Parent topic: [Solving Problems](#)

Product Does Not Turn On or Off

If you cannot turn the product on or off, try these solutions:

- If you cannot turn on your product, make sure the power cord is securely connected and hold down the power button a little longer.
- If you cannot turn off your product, hold down the power button a little longer. If you still cannot turn off your product, unplug the power cord, plug the power cord back in, then turn your product on and off again using the power button.

Parent topic: [Solving Setup Problems](#)

Noise After Ink Installation

If you hear noises from your product after installing ink, check the following:

- If the product's print head stops moving or making noise, and the charging process has not finished after approximately 5 minutes, turn off your product. Turn it back on and check to see if charging is still in progress. If it is still in progress, contact Epson for help.

Parent topic: [Solving Setup Problems](#)

Software Installation Problems

If you have problems while installing your product software, try these solutions:

- Make sure your product is turned on and any necessary cables are securely connected at both ends. If you still have problems installing software, disconnect the cable and carefully follow the instructions on the *Start Here* sheet. Also make sure your system meets the requirements for your operating system.
- Close any other programs, including screen savers and virus protection software, and install your product software again.
- In Windows, make sure your product is selected as the default printer and the correct port is shown in the printer properties.
- If you see any error message or your software does not install correctly in Windows, you may not have software installation privileges. Contact your system administrator.

Parent topic: [Solving Setup Problems](#)

Related concepts

[Uninstall Your Product Software](#)

Related references

[Windows System Requirements](#)

[Mac System Requirements](#)

Solving Network Problems

Check these solutions if you have problems setting up or using your product on a network.

[Product Cannot Connect to a Wireless Router or Access Point](#)

[Network Software Cannot Find Product on a Network](#)

[Product Does Not Appear in Mac Printer Window](#)

[Cannot Print Over a Network](#)

[Cannot Scan Over a Network](#)

Parent topic: [Solving Problems](#)

Product Cannot Connect to a Wireless Router or Access Point

If your product has trouble finding or connecting to a wireless router or access point, try these solutions:

- If you are connecting the product via Wi-Fi Protected Setup (WPS) and the Wi-Fi icon on your product's LCD screen is not lit or does not appear, make sure you select one of the WPS options from the product control panel within 2 minutes of pressing the WPS button on your router.
- Make sure to place your product within contact range of your 2.4 GHz router or access point. Avoid placing your product near a microwave oven, 2.4 GHz cordless phone, or large metal object, such as a filing cabinet.

Note: If you are using a 5 GHz wireless router, set the router to operate in dual band (2.4 GHz and 5 GHz) mode. If your router uses a single network name (SSID) for both the 2.4 GHz and 5 GHz band, give each band its own network name (SSID) instead, such as Home Network 2.4 GHz and Home Network 5 GHz. See your router documentation or contact your internet service provider for instructions.

- Verify that your router or access point is operating correctly by connecting to it from your computer or another device.
- You may need to disable the firewall and any anti-virus software on your wireless router or access point.

- Check to see if access restrictions, such as MAC address filtering, are set on the router or access point. If access restrictions are set, add your product's MAC address to your router's address list. To obtain your product's MAC address, print a network status sheet. Then follow the instructions in your router or access point documentation to add the address to the list.
- If your router or access point does not broadcast its network name (SSID), follow the instructions that came with your product to enter your wireless network name manually.
- If your router or access point has security enabled, determine the kind of security it is using and any required password or passphrase for connection. Then make sure to enter the exact WEP key or WPA passphrase correctly.
- Check if your computer is restricting the available wireless channels. If so, verify that your wireless access point is using one of the usable channels and change to a usable channel, if necessary.
- If you connected your product to a Windows computer using Wi-Fi Direct and it automatically selected Access Point Mode, you may have trouble accessing a low-priority Internet connection. Check the network connection or adapter settings in the Windows Control Panel and set the **Internet metric** setting to **100** for your version of the Internet Protocol.

Parent topic: [Solving Network Problems](#)

Related tasks

[Enabling Wi-Fi Direct Mode](#)

[Printing a Network Status Sheet](#)

[Selecting Wireless Network Settings from the Control Panel](#)

Related topics

[Wi-Fi or Wired Networking](#)

Network Software Cannot Find Product on a Network

If EpsonNet Setup cannot find your product on a network, try these solutions:

- Make sure your product is turned on and connected to your network. Verify connection using your product control panel.
- Check if your network name (SSID) contains non-ASCII characters. Your product cannot display non-ASCII characters.
- Make sure your product is not connected to a guest network.
- If necessary, reinstall your product software and try running EpsonNet Setup again:
 1. Reset your product's network settings to their factory defaults.
 2. **Windows only:** uninstall your product software.

3. Initialize your router following the instructions in your router documentation.

Note: If you are reading these instructions online, you will lose your Internet connection when you initialize your router, so note the next step before initializing it.

4. Download your product software from the Epson website using the instructions on the *Start Here* sheet.

- If you have replaced your router, reinstall your product software to connect to the new router.

Note: If you are using a 5 GHz wireless router, set the router to operate in dual band (2.4 GHz and 5 GHz) mode. If your router uses a single network name (SSID) for both the 2.4 GHz and 5 GHz band, give each band its own network name (SSID) instead, such as Home Network 2.4 GHz and Home Network 5 GHz. See your router documentation or contact your internet service provider for instructions.

Parent topic: [Solving Network Problems](#)

Related concepts

[Uninstall Your Product Software](#)

Related topics

[Wi-Fi or Wired Networking](#)

Product Does Not Appear in Mac Printer Window

If your product does not appear in the Mac printer window, try these solutions:

- Turn your product off, wait 30 seconds, then turn it back on again.
- If you are connecting the product via Wi-Fi Protected Setup (WPS) and the Wi-Fi icon on your product's LCD screen is not lit, make sure you select one of the WPS options from the product control panel within 2 minutes of pressing the WPS button on your router.
- If you are connecting the product wirelessly via EpsonNet Setup and you do not see the Wi-Fi antenna icon with connection bars on your LCD screen, make sure your product software was installed correctly. If necessary, reinstall your software.

Note: If you are using a 5 GHz wireless router, set the router to operate in dual band (2.4 GHz and 5 GHz) mode. If your router uses a single network name (SSID) for both the 2.4 GHz and 5 GHz band, give each band its own network name (SSID) instead, such as Home Network 2.4 GHz and Home Network 5 GHz. See your router documentation or contact your internet service provider for instructions.

Parent topic: [Solving Network Problems](#)

Related concepts

[Uninstall Your Product Software](#)

Cannot Print Over a Network

If you cannot print over a network, try these solutions:

- Make sure that your product is turned on.
- Make sure you install your product's network software as described in your product documentation.
- Print a network status sheet and verify that the network settings are correct. If the network status is **Disconnected**, check any cable connections and turn your product off and then on again.
- If you are using TCP/IP, make sure the product's IP address is set correctly for your network. If your network does not assign IP addresses using DHCP, set the IP address manually.
- Make sure your computer and product are both using the same wireless network.
- If network printing is slow, print a network status sheet and check the signal strength. If it is poor, place your product closer to your router or access point. Avoid placing your product near a microwave oven, 2.4 GHz cordless phone, or large metal object, such as a filing cabinet.

Note: If you are using a 5 GHz wireless router, set the router to operate in dual band (2.4 GHz and 5 GHz) mode. See your router documentation for instructions.

- Check if there are any paused print jobs.
- Make sure your printer is selected as the default printer.
- Check if the selected printer port is correct.
- Check to see if your wireless router or access point has an enabled Privacy Separator function that is preventing printing from a device over the network. See your router or access point documentation for instructions on disabling the Privacy Separator function.
- If you are connecting the product via Wi-Fi Protected Setup (WPS) and the Wi-Fi icon on your product's LCD screen is not lit, make sure you select one of the WPS options from the product control panel within 2 minutes of pressing the WPS button on your router.
- Check your wired LAN router or access point to see if the LED for the port to which your product is connected is on or flashing. If the link LED is off, try the following:
 - Make sure the Ethernet cable is securely connected to your product and to your router, access point, switch, or hub.

- Try connecting your product to a different port or a different router, access point, switch, or hub.
- Try connecting with a different Ethernet cable.
- Try printing to your product from another computer on the network.

Note: If you are using a 5 GHz wireless router, set the router to operate in dual band (2.4 GHz and 5 GHz) mode. See your router documentation for instructions.

- If you are connecting the product via EpsonNet Setup and the Wi-Fi icon does not appear lit on the LCD screen, make sure your product software was installed correctly. If necessary, reinstall your software.

Parent topic: [Solving Network Problems](#)

Related concepts

[Uninstall Your Product Software](#)

Related tasks

[Printing a Network Status Sheet](#)

Related topics

[Wi-Fi or Wired Networking](#)



Cannot Scan Over a Network

If you cannot start Epson Scan 2 for scanning over a network, try these solutions:

- If you cannot scan from your product control panel, make sure you restarted your computer after installing the product software. Make sure the Event Manager program is not being blocked by your firewall or security software.

Note: If you are using a 5 GHz wireless router, set the router to operate in dual band (2.4 GHz and 5 GHz) mode. If your router uses a single network name (SSID) for both the 2.4 GHz and 5 GHz band, give each band its own network name (SSID) instead, such as Home Network 2.4 GHz and Home Network 5 GHz. See your router documentation or contact your internet service provider for instructions.

- If you are scanning a large original at a high resolution, a network communication error may occur. Try scanning again at a lower resolution.
- If network communication was interrupted while starting Epson Scan 2, exit Epson Scan 2, wait a few seconds, and restart it. If Epson Scan 2 cannot restart, turn off your product, turn it back on, and try restarting Epson Scan 2 again.

- Check the scanner setting and reset the connection if necessary using Epson Scan 2 Utility:
Windows 10: Click , select **All apps**, select **EPSON**, and select **Epson Scan 2 Utility**. Make sure your product is selected. If necessary, select the **Other** tab and click **Reset**.
Windows 8.x: Navigate to the **Apps** screen, select **EPSON**, and select **Epson Scan 2 Utility**. Make sure your product is selected. If necessary, select the **Other** tab and click **Reset**.
Windows (other versions): Click  or **Start > All Programs** or **Programs > EPSON > Epson Scan 2 > Epson Scan 2 Utility**. Make sure your product is selected. If necessary, select the **Other** tab and click **Reset**.
Mac: Open the **Applications** folder, click **Epson Software**, and click **Epson Scan 2 Utility**. Make sure your product is selected. If necessary, select the **Other** tab and click **Reset**.
- You may need to disable the firewall and any anti-virus software on your wireless router or access point.

Parent topic: [Solving Network Problems](#)

Related tasks

[Starting a Scan Using the Product Control Panel](#)

[Starting a Scan Using the Epson Scan 2 Icon](#)

[Starting a Scan from a Scanning Program](#)

[Starting a Scan from a Smart Device](#)

Solving Copying Problems

Check these solutions if you have problems copying with your product.

[Product Makes Noise, But Nothing Copies](#)

[Product Makes Noise When It Sits for a While](#)

[Originals Do Not Feed From the Automatic Document Feeder](#)

Parent topic: [Solving Problems](#)

Product Makes Noise, But Nothing Copies

If your product makes a noise, but nothing copies, try these solutions:

- Run a nozzle check to see if any of the print head nozzles are clogged. Then clean the print head, if necessary.
- If the nozzle check page does not print, but the product's power is on, make sure your product software is installed correctly.

- Make sure your product is level (not tilted).

Parent topic: [Solving Copying Problems](#)

Related concepts

[Print Head Nozzle Check](#)

[Print Head Cleaning](#)

Product Makes Noise When It Sits for a While

Your product is performing routine maintenance. This is normal.

Parent topic: [Solving Copying Problems](#)

Originals Do Not Feed From the Automatic Document Feeder

If your originals do not feed when placed in the ADF, try these solutions:

- Make sure the ADF icon appears on the LCD screen. If not, reload the originals.
- Make sure the ADF icon appears on the Copy, Fax, or Scan screens on the LCD screen. If not, reload the originals.
- Make sure the size, weight, and number of your originals are supported by the ADF.
- Make sure the originals are loaded correctly.
- Try cleaning the inside of the ADF.

- Do not load originals above the arrow mark on the ADF edge guide.

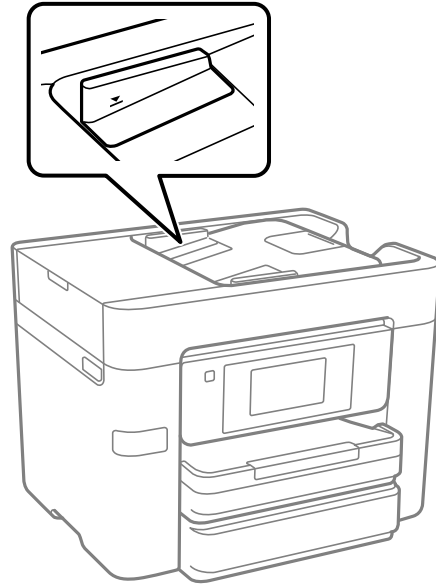

Parent topic: [Solving Copying Problems](#)

Related references

[Document Jams in the Automatic Document Feeder](#)

[ADF Original Document Specifications](#)

Related tasks

[Placing Originals in the Automatic Document Feeder](#)

[Cleaning Your Product](#)

Solving Paper Problems

Check these sections if you have problems using paper with your product.

[Paper Feeding Problems](#)

[Paper Jam Problems in the Cassette](#)

[Paper Jam Problems in the Rear Cover](#)

[Document Jams in the Automatic Document Feeder](#)

[Paper Ejection Problems](#)

Parent topic: [Solving Problems](#)

Paper Feeding Problems

If you have problems feeding paper, try these solutions:

- Make sure the paper cassette is inserted all the way in the printer.
- If paper does not feed correctly, remove and reload it in the cassette and adjust the edge guides. Make sure the paper stack is not above the tab on the edge guides inside the cassette.
- If multiple pages feed at once, remove the paper, fan the edges to separate the sheets, and reload it.
- Do not load more than the recommended number of sheets.
- Make sure your paper meets the specifications for your product.
- If paper jams when you print on both sides of the paper, try loading fewer sheets.
- For best results, follow these guidelines:
 - Use new, smooth, high-quality paper that is not curled, creased, old, too thin, or too thick.
 - Load paper in the cassette printable side down.
 - Follow any special loading instructions that came with the paper.

Parent topic: [Solving Paper Problems](#)

Related references

[Paper Jam Problems in the Cassette](#)

[Paper Jam Problems in the Rear Cover](#)

[Document Jams in the Automatic Document Feeder](#)

Paper Jam Problems in the Cassette

If paper has jammed in the cassette, follow the steps here to clear the jam.

1. Cancel the print job, if necessary.

2. Pull out the paper cassette.

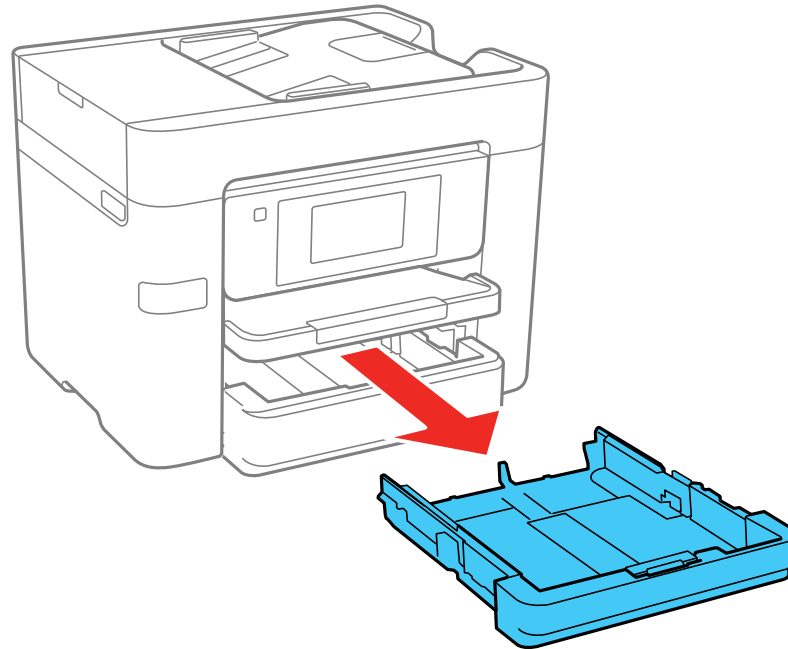

3. Carefully remove any paper jammed inside the product.

4. Carefully follow all paper loading instructions and reload the paper.

5. Keep the cassette flat as you gently insert it.

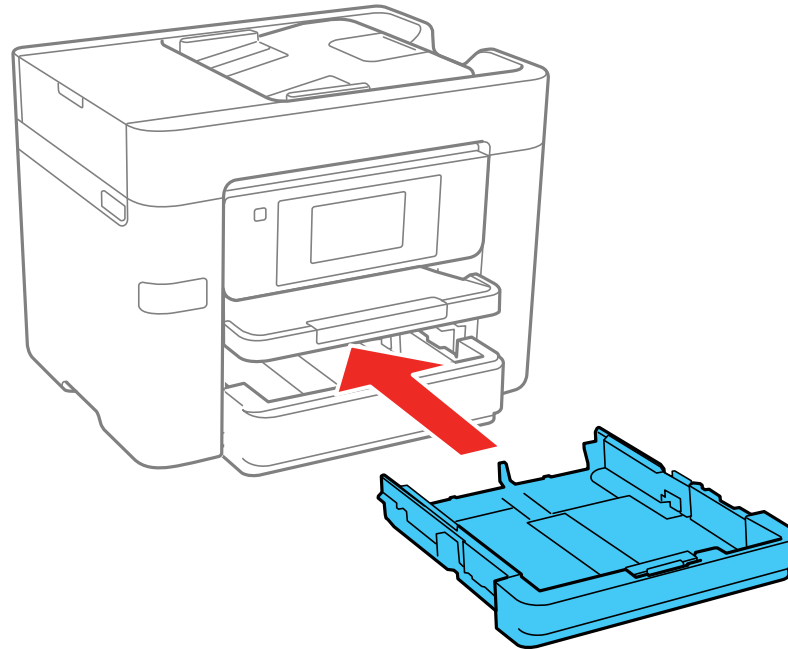

6. Follow the prompts on the LCD screen to clear any error messages. If you still see a paper jam message, check the other paper jam solutions.

Parent topic: [Solving Paper Problems](#)

Related references

[Paper Jam Problems in the Rear Cover](#)

[Document Jams in the Automatic Document Feeder](#)

Related tasks

[Loading Paper in the Cassette](#)

Paper Jam Problems in the Rear Cover

If paper has jammed in the rear cover, follow the steps here to clear the jam.

1. Cancel the print job, if necessary.
2. Squeeze the tabs and open the rear cover.

3. Carefully remove any jammed paper from inside the product.
4. Carefully remove any jammed paper from the duplexer.
5. Close the rear cover.
6. Follow the prompts on the LCD screen to clear any error messages. If you still see a paper jam message, check the other paper jam solutions.

Parent topic: [Solving Paper Problems](#)

Related references

[Paper Jam Problems in the Cassette](#)

[Document Jams in the Automatic Document Feeder](#)

Related tasks

[Loading Paper in the Cassette](#)

Document Jams in the Automatic Document Feeder

If you have problems with document jams in the automatic document feeder (ADF), follow the steps here to clear the jam.

1. Cancel the print job, if necessary.
2. Remove your originals from the ADF.

3. Open the ADF cover.

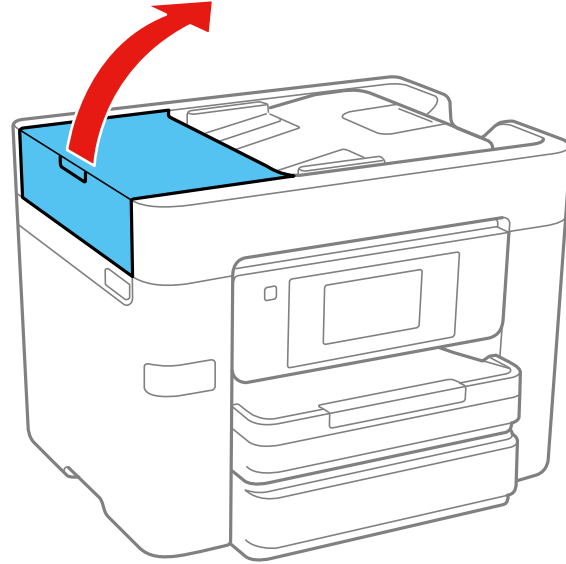

4. Carefully remove any jammed pages.

5. Close the ADF cover, then raise the document cover.

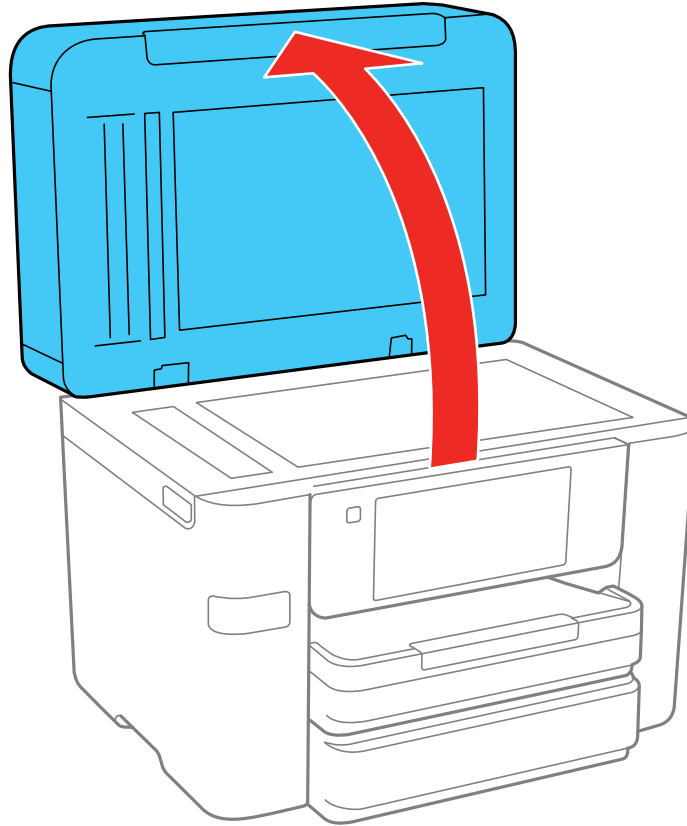

6. Carefully remove any jammed pages.

7. Lower the document cover.

8. Raise the ADF input tray and carefully remove any jammed pages.

9. Lower the ADF input tray.

10. Reload your originals.

Caution: Make sure you do not load the ADF beyond its capacity for your paper size. Also make sure your originals are not bent, folded, or curled and do not have tape, staples, or other materials that could obstruct the feeder.

11. Follow the prompts on the LCD screen to clear any error messages. If you still see a paper jam message, check the other paper jam solutions.

Parent topic: [Solving Paper Problems](#)

Related references

[Paper Jam Problems in the Rear Cover](#)

[Paper Jam Problems in the Cassette](#)

[ADF Original Document Specifications](#)

Related tasks

[Placing Originals in the Automatic Document Feeder](#)

Paper Ejection Problems

If you have problems with paper ejecting properly, try these solutions:

- If paper does not eject fully, you may have set the wrong paper size. Cancel printing to eject the paper. Select the correct paper size when you reprint.
- If paper is wrinkled when it ejects, it may be damp or too thin. Load new paper and be sure to select the correct paper type setting when you reprint.

Parent topic: [Solving Paper Problems](#)

Related references

[Paper or Media Type Settings - Printing Software](#)

Related tasks

[Loading Paper in the Cassette](#)

[Cancelling Printing Using the Product](#)

Solving Problems Printing from a Computer

Check these sections if you have problems while printing from your computer.

Note: When printing using AirPrint, the available print settings are different from those covered in this manual. See the Apple website for details.

[Nothing Prints](#)

[Product Icon Does Not Appear in Windows Taskbar](#)

[Printing is Slow](#)

Parent topic: [Solving Problems](#)

Nothing Prints

If you have sent a print job and nothing prints, try these solutions:

- Make sure your product is turned on.
- Make sure any interface cables are connected securely at both ends.
- If you connected your product to a USB hub, make sure it is a first-tier hub. If it still does not print, connect your product directly to your computer instead of the hub.
- Make sure the printer status is not offline or pending.
- Run a product check to see if a test page prints. If the test page prints, check to see if your product software is installed correctly.
- In Windows, make sure your product is selected as the default printer.
- In Windows, make sure the printer port setting matches the printer connection port.
- In Windows, delete all jobs from the Windows Spooler. Click **Print Queue** on the Maintenance tab in the printer settings window, and cancel any stalled print jobs.
- On a Mac, make sure the printer is not paused.

Parent topic: [Solving Problems Printing from a Computer](#)

Related tasks



[Running a Product Check](#)

[Using AirPrint](#)

Product Icon Does Not Appear in Windows Taskbar

If you do not see your product icon in the Windows taskbar, first try restarting your computer. If that does not work, try this solution:

1. Do one of the following:

- **Windows 10:** Right-click  and select **Control Panel > Hardware and Sound > Devices and Printers**.
- **Windows 8.x:** Navigate to the **Apps** screen and select **Control Panel > Hardware and Sound > Devices and Printers**.
- **Windows 7:** Click  and select **Devices and Printers**.
- **Windows Vista:** Click , select **Control Panel**, and click **Printer** under **Hardware and Sound**.

- **Windows XP:** Click **Start** and select **Printers and Faxes**. (Or open the **Control Panel**, select **Printers and Other Hardware**, if necessary, and **Printers and Faxes**.)
2. Right-click your product name, select **Printing Preferences**, and select your product name again if necessary.
 3. Click the **Maintenance** tab.
 4. Click the **Extended Settings** button.
 5. Select **Enable EPSON Status Monitor 3** and click **OK**.
 6. Click the **Monitoring Preferences** button.
 7. Click the checkbox for the option that adds the shortcut icon to the taskbar.
 8. Click **OK** to close the open program windows.

Parent topic: [Solving Problems Printing from a Computer](#)

Printing is Slow

If printing becomes slow, try these solutions:

- Make sure your system meets the requirements for your operating system. If you are printing a high-resolution image, you may need more than the minimum requirements. If necessary, increase your system's memory.
- If you are using Windows 7, close the **Devices and Printers** window before you print.
- Make sure **Quiet Mode** is turned off.
- Clear space on your hard drive or run a defragmentation utility to free up existing space.
- Close any programs you are not using when you print.
- If your product is connected to a USB hub, connect it directly to your computer instead.
- If printing becomes slower after printing continuously for a long time, the product may have automatically slowed down to protect the print mechanism from overheating or becoming damaged. Let the product rest with the power on for 30 minutes, then try printing again.
- If you are printing over a wireless network, factors such as interference, network traffic, or weak signal strength may affect your printing speed.

For the fastest printing, select the following settings in your product software:

- Make sure the paper type setting matches the type of paper you loaded.
- Turn on any high speed settings in your product software.
- Select a lower print quality setting.

- Make sure the ink drying time has not been increased for double-sided printing.
- **Windows:** Click the **Maintenance** or **Utility** tab, select **Extended Settings** or **Speed and Progress**, and select the following settings:
 - **Always Spool RAW Datatype**
 - **Page Rendering Mode**
 - **Print as Bitmap**

Parent topic: [Solving Problems Printing from a Computer](#)

Related references

[Paper or Media Type Settings - Printing Software](#)

[Windows System Requirements](#)

[Mac System Requirements](#)

Related tasks

[Selecting Basic Print Settings - Windows](#)

[Selecting Basic Print Settings - Mac](#)

[Selecting Extended Settings - Windows](#)

Solving Page Layout and Content Problems

Check these sections if you have problems with the layout or content of your printed pages.

Note: When printing using AirPrint, the available print settings are different from those covered in this manual. See the Apple website for details.

[Inverted Image](#)

[Too Many Copies Print](#)

[Blank Pages Print](#)

[Incorrect Margins on Printout](#)

[Incorrect Characters Print](#)

[Incorrect Image Size or Position](#)

[Slanted Printout](#)

Parent topic: [Solving Problems](#)

Inverted Image

If your printed image is inverted unexpectedly, try these solutions:

- Turn off any mirror or inversion settings in your printing application.
- Turn off the **Mirror Image**, **Flip horizontally**, or **Reverse page orientation** settings in your printer software. (This option has different names, depending on your operating system version.)

Parent topic: [Solving Page Layout and Content Problems](#)

Related tasks

[Selecting Additional Layout and Print Options - Windows](#)

[Selecting Basic Print Settings - Mac](#)

Too Many Copies Print

Make sure that the **Copies** setting in your printing program or printer software is not set for multiple copies.

Parent topic: [Solving Page Layout and Content Problems](#)

Related tasks

[Selecting Basic Print Settings - Windows](#)

[Selecting Basic Print Settings - Mac](#)

Blank Pages Print

If blank pages print unexpectedly, try these solutions:

- Make sure you selected the correct paper size settings in your printing program and printer software.
- If a blank page exists in a document you are printing and you want to skip printing it, select the **Skip Blank Page** setting in your printer software, if available.
- Run a print head nozzle check to see if any of the nozzles are clogged. Then clean the print head, if necessary.
- Make sure your product is selected as the printer in your printing program.

Parent topic: [Solving Page Layout and Content Problems](#)

Related tasks

[Selecting Basic Print Settings - Windows](#)

[Selecting Extended Settings - Windows](#)

[Selecting Basic Print Settings - Mac](#)

[Selecting Page Setup Settings - Mac](#)
[Cleaning Your Product](#)

Incorrect Margins on Printout

If your printed page has incorrect margins, try these solutions:

- Make sure you selected the correct paper size settings in your printing program and printer software.
- Make sure you selected the correct margins for your paper size in your printing program.
- Make sure your paper is positioned correctly for feeding into the printer.

You can use the preview option in your printer software to check your margins before you print.

Parent topic: [Solving Page Layout and Content Problems](#)

Related tasks

[Selecting Basic Print Settings - Windows](#)
[Selecting Basic Print Settings - Mac](#)

Incorrect Characters Print

If incorrect characters appear in your prints, try these solutions before reprinting:

- Make sure any cables are securely connected at both ends.
- In Windows, delete all jobs from the Windows Spooler. Click **Print Queue** on the Maintenance tab in the printer settings window, and cancel any stalled print jobs.
- If your product is connected to a USB hub, connect it directly to your computer instead.
- If your computer entered sleep mode the last time you printed, the next print job after your computer exits sleep mode may contain garbled characters. Print your document again.

Parent topic: [Solving Page Layout and Content Problems](#)

Related tasks

[Selecting Basic Print Settings - Windows](#)
[Selecting Basic Print Settings - Mac](#)

Incorrect Image Size or Position

If your printed image is the wrong size or in the wrong position, try these solutions:

- Make sure you selected the correct paper size and layout settings in your printing program and printer software.

- Make sure you selected the correct paper size on the control panel.
- Make sure your paper is positioned correctly for feeding into the printer.
- Clean the scanner glass and document cover.
- If the edges of a copy are cropped, slightly move the original away from the edges of the scanner glass.

You can use the preview option in your printer software to check your margins before you print.

Parent topic: [Solving Page Layout and Content Problems](#)

Related tasks

[Selecting Additional Layout and Print Options - Windows](#)

[Selecting Basic Print Settings - Windows](#)

[Selecting Basic Print Settings - Mac](#)

[Selecting Page Setup Settings - Mac](#)

[Cleaning Your Product](#)

Slanted Printout

If your printouts are slanted, try these solutions:

- Slide the edge guides against the edges of the paper.
- Select a higher print quality setting in your printer software.
- Turn off any high speed settings in your product software.
- Align the print head.
- Make sure the product is not printing while tilted or at an angle.

Parent topic: [Solving Page Layout and Content Problems](#)

Related tasks

[Loading Paper in the Cassette](#)

Solving Print Quality Problems

Check these sections if your printouts have problems with print quality, but your image looks fine on your computer screen.

Note: When printing using AirPrint, the available print settings are different from those covered in this manual. See the Apple website for details.

[White or Dark Lines in Printout](#)
[Blurry or Smearred Printout](#)
[Faint Printout or Printout Has Gaps](#)
[Grainy Printout](#)
[Incorrect Colors](#)

Parent topic: [Solving Problems](#)

White or Dark Lines in Printout

If you notice white or dark lines in your prints (also called banding), try these solutions before you reprint:

- Run a nozzle check to see if any of the print head nozzles are clogged. Then clean the print head, if necessary.
- Make sure the paper type setting matches the type of paper you loaded.
- Make sure you loaded the printable side of the paper correctly for your product.
- Turn off any high speed settings in your product software.
- Align the print head.

Parent topic: [Solving Print Quality Problems](#)

Related concepts

[Print Head Nozzle Check](#)

[Print Head Cleaning](#)

Related references

[Paper or Media Type Settings - Printing Software](#)

Related tasks

[Aligning the Print Head Using the Product Control Panel](#)

[Selecting Additional Layout and Print Options - Windows](#)

[Selecting Printing Preferences - Mac](#)

[Loading Paper in the Cassette](#)

Related topics

[Replacing Ink Cartridges and Maintenance Boxes](#)

Blurry or Smearred Printout

If your printouts are blurry or smearred, try these solutions:

- Make sure your paper is not damp, curled, old, or loaded incorrectly in your product.
- Use a support sheet with special paper, or load special paper one sheet at a time.
- Make sure your paper meets the specifications for your product.
- Use Epson papers to ensure proper saturation and absorption of genuine Epson inks.
- Make sure the paper type setting in your product software matches the type of paper you loaded.
- Make sure you loaded the printable side of the paper correctly for your product.
- If you are printing on thick paper or envelopes, turn on the **Thick Paper** setting from the control panel or select **Thick Paper and Envelopes** in the Extended Settings of the printer software. (Turning this setting on will decrease print speed.)
- Remove each sheet from the output tray as it is printed.
- Avoid handling printouts on glossy paper right after printing to allow the ink to set.
- Turn off any high speed settings in your product software.
- If you print on both sides of a sheet of paper, smudges may appear on the reverse side of heavily saturated or dark images. If one side of a sheet will contain a lighter image or text, print that side first. Make sure the ink has dried before reloading the paper to print on the other side.
- If printed copies are smearred, lower the copy density setting on the product control panel.
- Run a nozzle check to see if any of the print head nozzles are clogged. Then clean the print head, if necessary.
- Align the print head.
- Clean the paper path.

Note: Your product will not operate properly while tilted at an angle. Place it on a flat, stable surface that extends beyond the base of the product in all directions.

Parent topic: [Solving Print Quality Problems](#)

Related concepts

[Print Head Cleaning](#)

Related references

[Paper Specifications](#)

[Available Epson Papers](#)

Related tasks

[Aligning the Print Head Using the Product Control Panel](#)

[Selecting Double-sided Printing Settings - Windows](#)

[Selecting Basic Print Settings - Windows](#)

[Selecting Additional Layout and Print Options - Windows](#)

Faint Printout or Printout Has Gaps

If your printouts are faint or have gaps, try these solutions:

- Run a nozzle check to see if any of the print head nozzles are clogged. Then clean the print head, if necessary.
- The ink cartridges may be old or low on ink, and you may need to replace them.
- Make sure the paper type setting matches the type of paper you loaded.
- Make sure your paper is not damp, curled, old, or loaded incorrectly in your product.
- Align the print head.
- Clean the paper path.

Parent topic: [Solving Print Quality Problems](#)

Related concepts

[Print Head Nozzle Check](#)

[Print Head Cleaning](#)

Related references

[Paper or Media Type Settings - Printing Software](#)

Related tasks

[Aligning the Print Head Using the Product Control Panel](#)

[Selecting Basic Print Settings - Windows](#)

[Selecting Basic Print Settings - Mac](#)

[Loading Paper in the Cassette](#)

[Cleaning the Paper Guide](#)

Related topics

[Replacing Ink Cartridges and Maintenance Boxes](#)

Grainy Printout

If your printouts are grainy, try these solutions:

- Make sure you loaded the printable side of the paper correctly for your product.
- Select a higher print quality setting and turn off any high speed settings in your product software.
- Run a nozzle check to see if any of the print head nozzles are clogged. Then clean the print head, if necessary.
- Align the print head.
- You may need to increase the image resolution or print a smaller size; see your software documentation.

Note: Images from the Internet may be low resolution and not result in a high quality printout.

- If you enlarged the image size in an image-editing program, you need to increase the image resolution setting to retain a high image quality. Increase the image resolution by the same amount you increase the image size. For example, if the image resolution is 300 dpi (dots per inch) and you will double the image size for printing, change the resolution setting to 600 dpi.

Note: Higher resolution settings result in larger file sizes, which take longer to process and print. Consider the limitations of your computer system when selecting a resolution, and select the lowest possible resolution that produces acceptable quality to keep file sizes manageable.

Parent topic: [Solving Print Quality Problems](#)

Related concepts

[Print Head Nozzle Check](#)

[Print Head Cleaning](#)

Related tasks

[Aligning the Print Head Using the Product Control Panel](#)

[Selecting Basic Print Settings - Windows](#)

[Selecting Additional Layout and Print Options - Windows](#)

[Selecting Basic Print Settings - Mac](#)

[Selecting Printing Preferences - Mac](#)

[Loading Paper in the Cassette](#)

Incorrect Colors

If your printouts have incorrect colors, try these solutions:

- Make sure the paper type setting matches the paper you loaded.
- Make sure the **Black/Grayscale** or **Grayscale** setting is not selected in your printer software.
- Run a nozzle check to see if any of the print head nozzles are clogged. Then clean the print head, if necessary.
- The ink cartridges may be old or low on ink, and you may need to replace them.
- After you print, the colors in your printout need time to set as the ink dries. During this time, the colors may look different than you expect. To speed up drying time, do not stack your printouts on top of each other.
- Your printed colors can never exactly match your on-screen colors. However, you can use a color management system to get as close as possible. Try using the color management options in your printer software.
- For best results, use genuine Epson ink and paper.

Parent topic: [Solving Print Quality Problems](#)

Related concepts

[Print Head Nozzle Check](#)

[Print Head Cleaning](#)

Related references

[Available Epson Papers](#)

Related tasks

[Selecting Basic Print Settings - Mac](#)

[Managing Color - Mac](#)

[Selecting Basic Print Settings - Windows](#)

[Selecting Additional Layout and Print Options - Windows](#)

Related topics

[Replacing Ink Cartridges and Maintenance Boxes](#)

Solving Scanning Problems

Check these solutions if you have problems scanning with your product.

[Scanning Software Does Not Operate Correctly](#)

Cannot Start Epson Scan 2

Scanning is Slow

Parent topic: [Solving Problems](#)

Scanning Software Does Not Operate Correctly

If your scanning software does not operate correctly, try these solutions:

- Make sure your computer has adequate memory and meets the system requirements for your operating system.
- Make sure your computer is not running in a power-saving mode, such as sleep or standby. If so, wake your system and restart your scanning software.
- If you upgraded your operating system but did not reinstall your scanning software, try reinstalling it.
- In Windows, make sure your product is listed as a valid device.

Parent topic: [Solving Scanning Problems](#)

Related concepts

[Uninstall Your Product Software](#)

Cannot Start Epson Scan 2

If you cannot start Epson Scan 2, try these solutions:

- Make sure your product is turned on and any interface cables are securely connected at both ends.
- Make sure Epson Scan 2 is selected as your scanning program.
- Make sure your computer is not running in a power-saving mode, such as sleep or standby. If so, wake your system and restart Epson Scan 2.
- Check the connection setting and test the connection using Epson Scan 2 Utility:

Windows 10: Click  and select **All apps**. Select **EPSON**, then select **Epson Scan 2 Utility**. Make sure the correct product is selected. If necessary, select the **Other** tab and click **Reset**.

Windows 8.x: Navigate to the **Apps** screen and select **Epson Scan 2 Utility**. Make sure the correct product is selected. If necessary, select the **Other** tab and click **Reset**.

Windows (other versions): Click  or **Start > All Programs** or **Programs > EPSON > Epson Scan 2 > Epson Scan 2 Utility**. Make sure the correct product is selected. If necessary, select the **Other** tab and click **Reset**.

Mac: Open the **Applications** folder, click **Epson Software**, and click **Epson Scan 2 Utility**. Make sure the correct product is selected. If necessary, select the **Other** tab and click **Reset**.

- Make sure you do not have multiple versions of Epson Scan installed. If you do, uninstall both versions and install one version.
- If you upgraded your operating system but did not reinstall Epson Scan 2, try reinstalling it.

Parent topic: [Solving Scanning Problems](#)

Related concepts

[Uninstall Your Product Software](#)

Scanning is Slow

If scanning becomes slow, try these solutions:

- Scan your original at a lower resolution, if possible.
- Make sure your system meets the requirements for your operating system. If you are scanning a high-resolution image, you may need more than the minimum requirements. If necessary, increase your system's memory.
- In Epson Scan 2, turn off **Quiet Mode** on the Scan tab.
- If you are scanning over a wireless network, factors such as interference, network traffic, or weak signal strength may affect your scanning speed.

Parent topic: [Solving Scanning Problems](#)

Related topics

[Wi-Fi or Wired Networking](#)

Solving Scanned Image Quality Problems

Check these sections if a scanned image on your computer screen has a quality problem.

[Image Consists of a Few Dots Only](#)

[Line of Dots Appears in All Scanned Images](#)

[Straight Lines in an Image Appear Crooked](#)

[Image is Distorted or Blurry](#)

[Image Colors are Patchy at the Edges](#)

[Image is Too Dark](#)

[Back of Original Image Appears in Scanned Image](#)

[Ripple Patterns Appear in an Image](#)

[Scanned Image Colors Do Not Match Original Colors](#)

[Scanned Image Edges are Cropped](#)

Parent topic: [Solving Problems](#)

Image Consists of a Few Dots Only

If your scanned image consists only of a few dots, try these solutions:

- Make sure you placed your original for scanning facing the correct way.
- If you are scanning using the Epson Scan 2 **Black & White** setting, adjust the **Threshold** setting and scan again.

Parent topic: [Solving Scanned Image Quality Problems](#)

Related references

[Additional Scanning Settings - Advanced Settings Tab](#)

Line of Dots Appears in All Scanned Images

If a line of dots appears in all your scanned images, clean the scanner glass with a soft, dry, lint-free cloth or use a small amount of glass cleaner on the cloth, if necessary. Paper towels are not recommended.

Caution: Do not spray glass cleaner directly on the scanner glass.

Parent topic: [Solving Scanned Image Quality Problems](#)

Related tasks

[Cleaning Your Product](#)

Straight Lines in an Image Appear Crooked

If straight lines in an original appear crooked in a scanned image, make sure to place your original straight when you scan it.

If you are scanning from the ADF, try cleaning the ADF and scan again.

Parent topic: [Solving Scanned Image Quality Problems](#)

Related topics

[Placing Originals on the Product](#)

Image is Distorted or Blurry

If a scanned image appears distorted or blurry, try these solutions:

- Make sure your original is not wrinkled or warped. This may prevent the original from laying flat on the scanner glass.
- Do not move your original or your product during scanning.
- Your product will not operate properly while tilted at an angle. Place your product on a flat, stable surface that extends beyond its base in all directions.
- Adjust these Epson Scan 2 settings (if available) and try scanning again:
 - Increase the **Resolution** setting.
 - If the **Image Type** setting is **Black & White**, adjust the **Threshold** setting.
 - Select the **Unsharp Mask** setting.
 - If the **Image Type** setting is **Black & White**, select **Text Enhancement**. If the **Image Type** setting is **Color** or **Grayscale**, change the **Text Enhancement** setting to **High**.

Parent topic: [Solving Scanned Image Quality Problems](#)

Related references

[Additional Scanning Settings - Main Settings Tab](#)

[Additional Scanning Settings - Advanced Settings Tab](#)

Image Colors are Patchy at the Edges

If you are scanning a thick or warped original, cover its edges with paper to block external light as you scan it.

Parent topic: [Solving Scanned Image Quality Problems](#)

Image is Too Dark

If your scanned image is too dark, try these solutions:

- Select the **Advanced Settings** tab in Epson Scan 2 and adjust the **Brightness** setting.
- Check the brightness and contrast settings of your computer monitor.

Parent topic: [Solving Scanned Image Quality Problems](#)

Related references

[Additional Scanning Settings - Main Settings Tab](#)

[Additional Scanning Settings - Advanced Settings Tab](#)

Back of Original Image Appears in Scanned Image

If an image from the back of a thin original appears in your scanned image, try these solutions:

- Place a piece of black paper on the back of the original and scan it again.
- Adjust these Epson Scan 2 settings (if available) and try scanning again:
 - Select the **Advanced Settings** tab and adjust the **Brightness** setting.
 - Select **Text Enhancement**.

Parent topic: [Solving Scanned Image Quality Problems](#)

Ripple Patterns Appear in an Image

You may see a ripple pattern (called a moiré) in scanned images of printed documents. This is caused by interference from differing pitches in the scanner's screen and your original's halftone screen. To reduce this effect, adjust these Epson Scan 2 settings (if available) and try scanning again:

- Select the **Descreening** setting.
- Select a lower **Resolution** setting.

Parent topic: [Solving Scanned Image Quality Problems](#)

Related references

[Additional Scanning Settings - Main Settings Tab](#)

[Additional Scanning Settings - Advanced Settings Tab](#)

Scanned Image Colors Do Not Match Original Colors

Printed colors can never exactly match the colors on your computer monitor because printers and monitors use different color systems: monitors use RGB (red, green, and blue) and printers typically use CMYK (cyan, magenta, yellow, and black).

Check the color matching and color management capabilities of your computer, display adapter, and the software you are using to see if they are affecting the palette of colors you see on your screen.

To adjust the colors in your scanned image, adjust these Epson Scan 2 settings (if available) and try scanning again:

- If the **Image Type** setting is **Color** or **Grayscale**, adjust the **Contrast** setting.
- If the **Image Type** setting is **Black & White** or **Grayscale**, adjust the **Color Enhance** setting.

Parent topic: [Solving Scanned Image Quality Problems](#)

Related references

[Additional Scanning Settings - Main Settings Tab](#)

[Additional Scanning Settings - Advanced Settings Tab](#)

Scanned Image Edges are Cropped

If the edges of a scanned image are cropped, make sure your original is placed correctly for scanning. If necessary, move your original away from the edges of the scanner glass slightly.

Parent topic: [Solving Scanned Image Quality Problems](#)

Related topics

[Placing Originals on the Product](#)

Solving Faxing Problems

Check these solutions if you have problems faxing with your product.

[Cannot Send or Receive Faxes](#)

[Cannot Receive Faxes with a Telephone Connected to Your Product](#)

[Fax Memory Full Error Appears](#)

[Sent Fax Quality is Poor](#)

[Sent Fax is Received in an Incorrect Size](#)

[Received Fax Quality is Poor](#)

[Received Fax is Not Printed](#)

Parent topic: [Solving Problems](#)

Cannot Send or Receive Faxes

If you cannot send or receive faxes, try these solutions:

- If you are faxing from a computer, use the Epson FAX Utility to send your fax.
- Make sure the recipient's fax machine is turned on and working.
- Make sure paper is loaded correctly in your product.
- Make sure you have set up your header information and have not blocked your caller ID. Otherwise, your faxes might be rejected by the recipient's fax machine.
- Make sure Receive Mode is set to **Auto** so you can receive faxes automatically.
- Check that the cable connecting your telephone wall jack to your product's **LINE** port is secure.

- Print a fax connection report using your product control panel or fax software to help diagnose the problem.
- Verify that the telephone wall jack works by connecting a phone to it and testing it.
- If there is no dial tone and you connected the product to a PBX (Private Branch Exchange) phone line or Terminal Adapter, change the **Line Type** setting to **PBX**. If you still cannot send a fax, turn off the turn off the product's dial tone detection setting. (Turning off the dial tone setting may cause the product to drop the first digit of a fax number.)
- If you connected your product to a DSL phone line, you must connect a DSL filter to the phone jack to enable faxing over the line. Contact your DSL provider for the necessary filter.
- Make sure you installed the FAX driver for your product and that it is not paused.
- Try lowering your product's fax speed setting.
- Make sure the error correction mode (ECM) setting is turned on if you are trying to send or receive a color fax.
- If your telephone line uses call waiting and you have trouble receiving faxes, turn off call waiting to prevent disruption of incoming faxes.
- If you have subscribed to a call forwarding service, the product may not be able to receive faxes. Contact your service provider for assistance.

Note: If your product is connected to a VoIP (Voice over Internet Protocol) phone line, keep in mind that fax machines are designed to work over analog phone lines. Epson cannot guarantee that fax transmission will work when using VoIP.

If your phone line includes voice mail answering services, calls or faxes may be inadvertently received by your voice mail service.

Parent topic: [Solving Faxing Problems](#)

Related tasks

[Connecting a Telephone or Answering Machine](#)

[Using the Fax Setup Wizard](#)

[Selecting the Line Type](#)

[Selecting Advanced Fax Settings](#)

[Receiving Faxes Automatically](#)

[Printing Fax Reports](#)

[Viewing a Fax on the LCD Screen \(Using the Inbox\)](#)

Cannot Receive Faxes with a Telephone Connected to Your Product

If you cannot receive faxes when a telephone is connected to your product, try these solutions:

- Make sure your telephone is connected to your product's **EXT** port.
- Make sure the Receive Mode is set to **Manual**.

Note: When answering a call that is a fax, wait until the product's LCD screen displays a message that a connection has been made before you hang up.

Parent topic: [Solving Faxing Problems](#)

Related tasks

[Connecting a Telephone or Answering Machine](#)

[Using the Fax Setup Wizard](#)

Fax Memory Full Error Appears

If you see an error message telling you that the product's fax memory is full, try these solutions:

- If you set the product to save received faxes in the product's memory or inbox, delete any faxes you have already read.

Note: Your product can store up to 100 faxes before its inbox is full.

- If you set the product to save received faxes on a computer, turn on the selected computer. Once the faxes are saved on the computer, they are deleted from the product's memory.
- If you set the product to save received faxes on a USB device, connect the selected USB device containing the save fax folder to the product. Once the faxes are saved on the USB device, they are deleted from the product's memory.

Note: Make sure the USB device has enough available memory and is not write protected.

- If the memory is full, try sending a monochrome fax using the **Direct Send** feature or sending your faxes in smaller batches.
- If the product cannot print a received fax due to a product error, such as a paper jam, the memory full error may appear. Clear any product errors, then ask the sender to resend the fax.

Parent topic: [Solving Faxing Problems](#)

Related references

[Fax Sending Options](#)

Related tasks

[Viewing a Fax on the LCD Screen \(Using the Inbox\)](#)

[Saving Faxes to a USB Memory Device](#)

[Selecting Received Fax Options Using the Fax Utility - Windows](#)

Sent Fax Quality is Poor

If the sent fax quality is poor, try these solutions:

- Clean the scanner glass.
- Clean the ADF.
- Try changing the resolution setting on the control panel.
- Try adjusting the density setting on the control panel.
- Try changing the original type setting on the control panel.
- If you are sending a monochrome fax to a single recipient, try sending the fax using the **Direct Send** feature.

Note: If you send a high-resolution monochrome fax without using the **Direct Send** feature, the product may automatically lower the resolution.

- Try enabling the error correction mode (ECM) setting.

Parent topic: [Solving Faxing Problems](#)

Related references

[Fax Sending Options](#)

[Basic Settings - Fax](#)

Related tasks

[Cleaning Your Product](#)

Sent Fax is Received in an Incorrect Size

If your recipient receives a fax in an incorrect size, try these solutions:

- If you are sending a fax using the scanner glass, make sure your original is placed correctly on the scanner glass and that the correct paper size is selected on the control panel.

- Clean the scanner glass and document cover.

Parent topic: [Solving Faxing Problems](#)

Related tasks

[Cleaning Your Product](#)

Related topics

[Placing Originals on the Product](#)

Received Fax Quality is Poor

If you receive a poor quality fax, try these solutions:

- Try enabling the error correction mode (ECM) setting.
- Contact the fax sender and ask them to send the fax in a higher resolution.
- Try reprinting the received fax.

Parent topic: [Solving Faxing Problems](#)

Related references

[Basic Settings - Fax](#)

Received Fax is Not Printed

If a received fax is not printed, try these solutions:

- Make sure the product is free of errors. The product cannot print received faxes if an error has occurred with the product, such as a paper jam.
- If the product has been set to save received faxes in the product's memory or inbox, received faxes are not automatically printed. Check the **Receive Settings** options on the product control panel and change them, if necessary.

Parent topic: [Solving Faxing Problems](#)

Related tasks

[Viewing a Fax on the LCD Screen \(Using the Inbox\)](#)

[Saving Faxes to a USB Memory Device](#)

[Selecting Received Fax Options Using the Fax Utility - Windows](#)

Solving USB Device Problems

Check these solutions if you have problems using USB devices with your product.

[Cannot View or Print from a USB Device](#)
[Cannot Save Files on a USB Device](#)
[Cannot Transfer Files To or From a USB Device](#)

Parent topic: [Solving Problems](#)

Cannot View or Print from a USB Device

If you cannot view or print photos or documents from a USB device connected to your product, try these solutions:

- Make sure memory devices are enabled on the product.
- Make sure your device is compatible with the product.
- Make sure the files on your device are in the correct format.
- If you see an exclamation point on the photo selection screen, the image file format is not supported.

Parent topic: [Solving USB Device Problems](#)

Related references

[External USB Device Specifications](#)
[USB Device Photo File Specifications](#)

Related tasks

[Setting Up File Sharing for File Transfers from Your Computer](#)

Related topics

[Viewing and Printing from the LCD Screen](#)

Cannot Save Files on a USB Device

If you cannot save files on a USB device connected to your product, try these solutions:

- To save faxes on a USB device, create a folder in the **Fax Output** settings on the product control panel.
- Make sure the device is not write-protected.
- Make sure the device has enough available space.
- Make sure memory devices are enabled on your product.
- Make sure the device is compatible with the product.

Parent topic: [Solving USB Device Problems](#)

Related references

[External USB Device Specifications](#)

Related tasks

[Saving Faxes to a USB Memory Device](#)

[Selecting Received Fax Options Using the Fax Utility - Windows](#)

[Setting Up File Sharing for File Transfers from Your Computer](#)

Cannot Transfer Files To or From a USB Device

If you have problems transferring files to or from a USB device connected to your product, try these solutions:

- Make sure your device is compatible with the product.
- Make sure your product is securely connected to your computer.
- Make sure that the file sharing setting for your product is set correctly.

Parent topic: [Solving USB Device Problems](#)

Related references

[External USB Device Specifications](#)

Related tasks

[Transferring Files from a USB Device to Your Computer](#)

Uninstall Your Product Software

If you have a problem that requires you to uninstall and re-install your software, follow the instructions for your operating system.

[Uninstalling Product Software - Windows](#)

[Uninstalling Product Software - Mac](#)

Parent topic: [Solving Problems](#)

Uninstalling Product Software - Windows

You can uninstall and then re-install your product software to solve certain problems.

1. Turn off the product.
2. Disconnect any interface cables.

3. Do one of the following:

- **Windows 10:** Right click  and select **Control Panel > Programs > Programs and Features**. Select the uninstall option for your Epson product, then select **Uninstall/Change**.

Note: If you see a **User Account Control** window, click **Yes** or **Continue**.

Select your product again, if necessary, then select **OK**, and click **Yes** to confirm the uninstallation.

- **Windows 8.x:** Navigate to the **Apps** screen and select **Control Panel > Programs > Programs and Features**. Select the uninstall option for your Epson product, then select **Uninstall/Change**.

Note: If you see a **User Account Control** window, click **Yes** or **Continue**.

Select your product again, if necessary, then select **OK**, and click **Yes** to confirm the uninstallation.

- **Windows (other versions):** Click  or **Start**, and select **All Programs** or **Programs**. Select **EPSON**, select your product, then click **EPSON Printer Software Uninstall**.

Note: If you see a **User Account Control** window, click **Yes** or **Continue**.

In the next window, select your product and click **OK**. Then follow any on-screen instructions.

4. Do one of the following to uninstall Epson Event Manager, then follow any on-screen instructions:

- **Windows 10:** Select **Epson Event Manager** and click **Uninstall**.
- **Windows 8.x:** Select **Epson Event Manager** and click **Uninstall**.
- **Windows 7/Windows Vista:** Open the Windows **Control Panel** utility. Select **Programs and Features**. (In Classic view, select **Programs** and click **Uninstall a program**.) Select **Epson Event Manager** and click **Uninstall/Change**.
- **Windows XP:** Open the Windows **Control Panel** utility. Double-click **Add or Remove Programs**. Select **Epson Event Manager** and click **Change/Remove**.

5. Do one of the following to uninstall Epson Scan 2, then follow any on-screen instructions:

- **Windows 10:** Select **Epson Scan** and click **Uninstall**.
- **Windows 8.x/Windows 7/Windows Vista:** Select **Epson Scan** and click **Uninstall/Change**.
- **Windows XP:** Select **Epson Scan** and click **Change/Remove**.

6. Restart your computer, then see the *Start Here* sheet to re-install your software.

Note: If you find that re-installing your product software does not solve a problem, contact Epson.

Parent topic: [Uninstall Your Product Software](#)

Uninstalling Product Software - Mac

In most cases, you do not need to uninstall your product software before re-installing it. However, you can download the Uninstaller utility from the Epson support website to uninstall your product software as described here.

Note: If you find that re-installing your product software does not solve a problem, contact Epson.

1. To download the Uninstaller utility, visit epson.com/support (U.S.), epson.ca/support (Canada), or epson.com.jm/support (Caribbean) and select your product.
2. Click **Downloads**.
3. Select your operating system, click **Utilities**, locate the Uninstaller utility, and click **Download**.
4. Run the file you downloaded.
5. Double-click the **Uninstaller** icon.
6. In the Epson Uninstaller screen, select the checkbox for each software program you want to uninstall.
7. Click **Uninstall**.
8. Follow the on-screen instructions to uninstall the software.
9. Reinstall your product software.

Note: If you uninstall the printer driver and your product name remains in the **Print & Fax**, **Print & Scan**, or **Printers & Scanners** window, select your product name and click the – (remove) icon to remove it.

Parent topic: [Uninstall Your Product Software](#)

Where to Get Help

If you need to contact Epson for technical support services, use the following support options.

Internet Support

Visit Epson's support website at epson.com/support (U.S.), epson.ca/support (Canada), or epson.com.jm/support (Caribbean) and select your product for solutions to common problems. You can download drivers and documentation, get FAQs and troubleshooting advice, or e-mail Epson with your questions.

Speak to a Support Representative

Before you call Epson for support, please have the following information ready:

- Product name
- Product serial number (located on a label on the product)
- Proof of purchase (such as a store receipt) and date of purchase
- Computer configuration
- Description of the problem

Then call:

- U.S.: (562) 276-4382, 6 AM to 8 PM, Pacific Time, Monday through Friday, and 7 AM to 4 PM, Pacific Time, Saturday
- Canada: (905) 709-3839, 6 AM to 8 PM, Pacific Time, Monday through Friday, and 7 AM to 4 PM, Pacific Time, Saturday

Days and hours of support are subject to change without notice. Toll or long distance charges may apply.

Purchase Supplies and Accessories

You can purchase genuine Epson ink and paper at epson.com (U.S. sales) or epson.ca (Canadian sales). You can also purchase supplies from an Epson authorized reseller. To find the nearest one, call 800-GO-EPSON (800-463-7766) in the U.S. or 800-807-7766 in Canada.

Parent topic: [Solving Problems](#)

Technical Specifications

These sections list the technical specifications for your product.

Note: Epson offers a recycling program for end of life Epson products. Please go to [this site](#) (U.S) or [this site](#) (Canada) for information on how to return your Epson products for proper disposal.

[Windows System Requirements](#)

[Mac System Requirements](#)

[Paper Specifications](#)

[Printable Area Specifications](#)

[Scanning Specifications](#)

[Fax Specifications](#)

[Ink Cartridge Specifications](#)

[Dimension Specifications](#)

[Electrical Specifications](#)

[Environmental Specifications](#)

[Interface Specifications](#)

[External USB Device Specifications](#)

[Network Interface Specifications](#)

[Safety and Approvals Specifications](#)

Windows System Requirements

To use your product and its software, your computer should use one of these Microsoft operating systems:

- Windows 10
- Windows 8.x
- Windows 7
- Windows Vista
- Windows XP Professional x64 Edition
- Windows XP SP3
- Windows Server 2012R2

- Windows Server 2012
- Windows Server 2008R2
- Windows Server 2008
- Windows Server 2003R2
- Windows Server 2003

Note: For the latest product software available for your operating system, visit the Epson support site at epson.com/support (U.S.), epson.ca/support (Canada), or epson.com.jm/support (Caribbean), select your product, and select **Downloads**.

Parent topic: [Technical Specifications](#)

Mac System Requirements

To use your product and its software, your Mac should use one of these operating systems:

- macOS 10.12.x
- OS X 10.11.x
- OS X 10.10.x
- OS X 10.9.x
- OS X 10.8.x
- OS X 10.7.x
- OS X 10.6.8

Note: For the latest product software available for your operating system, visit the Epson support site at epson.com/support (U.S.), epson.ca/support (Canada), or epson.com.jm/support (Caribbean), select your product, and select **Downloads**.

Parent topic: [Technical Specifications](#)

Paper Specifications

Note: Since the quality of any particular brand or type of paper may be changed by the manufacturer at any time, Epson cannot guarantee the quality of any non-Epson brand or type of paper. Always test a sample of paper stock before purchasing large quantities or printing large jobs.

Single-sheets

Size	A4 (8.3 × 11.7 inches [210 × 297 mm]) A6 (4.1 × 5.8 inches [105 × 148 mm]) Letter (8.5 × 11 inches [216 × 279 mm]) Legal (8.5 × 14 inches [216 × 356 mm]) 4 × 6 inches (102 × 152 mm) 5 × 7 inches (127 × 178 mm) 8 × 10 inches (203 × 254 mm) 3.5 × 5 inches (89 × 127 mm) 16:9 wide (4 × 7.1 inches [102 × 181 mm]) Half Letter (5.5 × 8.5 inches [140 × 216 mm])
Paper types	Plain paper and paper distributed by Epson
Weight	17 lb (64 g/m ²) to 24 lb (90 g/m ²)

Envelopes

Size	No. 10 (4.1 × 9.5 inches [105 × 241 mm])
Weight	20 lb (75 g/m ²) to 24 lb (90 g/m ²)

Parent topic: [Technical Specifications](#)

Printable Area Specifications

Note: When printing borderless, quality may decline in the expanded printable area.

Single sheets

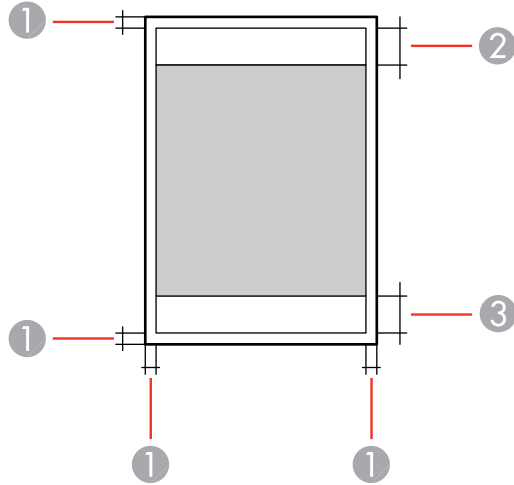

- 1 Top and sides: 0.12 inch (3 mm)
- 2 Reduced print quality area/top: 1.85 inch (47 mm)
- 3 Reduced print quality area/bottom: 1.77 inch (45 mm)

Borderless

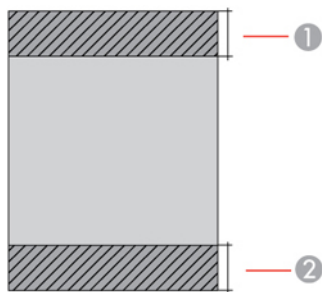

- 1 Reduced print quality area/top: 1.97 inch (50 mm)
- 2 Reduced print quality area/bottom: 1.89 inch (48 mm)

Envelopes

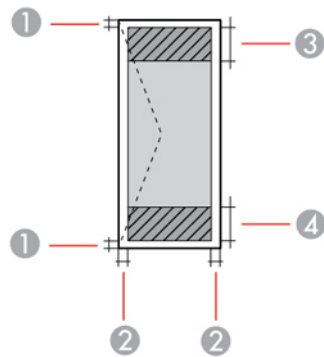

- 1 Sides: 0.12 inch (3 mm)
- 2 Top/bottom: 0.20 inch (5 mm)
- 3 Reduced print quality area/right: 0.71 inch (18 mm)
- 4 Reduced print quality area/left: 1.85 inch (47 mm)

Parent topic: [Technical Specifications](#)

Scanning Specifications

Scanner type	Flatbed, color
Photoelectric device	CIS
Effective pixels	10200 × 14040 pixels at 1200 dpi
Document size	Maximum: 8.5 × 11.7 inches (216 × 297 mm) Scanner glass: US letter or A4
Scanning resolution	1200 dpi (main scan) 2400 dpi (sub scan)
Output resolution	50 to 9600 dpi in 1 dpi increments

Color depth**Color:**

48 bits per pixel internal (16 bits per pixel per color internal)

24 bits per pixel external (8 bits per pixel per color external)

Grayscale:

16 bits per pixel internal

8 bits per pixel external

Black and white:

16 bits per pixel internal

1 bit per pixel external

Light source

LED

Parent topic: [Technical Specifications](#)

Fax Specifications

Fax type

Black-and-white and color fax capability (ITU-T Super Group 3)

Supported lines

Standard analog (household) telephone lines

PBX (Private Branch Exchange) telephone systems

Speed

Up to 33.6 kbps

Resolution**Monochrome:**

Standard: 203 pixels per inch × 98 lines per inch

Fine: 203 pixels per inch × 196 lines per inch

Super Fine: 203 pixels per inch × 392 lines per inch

Ultra Fine: 406 pixels per inch × 392 lines per inch

Color:

200 × 200 dpi

Page memory

Up to 180 pages (ITU-T No. 1 chart in monochrome draft mode)

Redial

2 times (with 1 minute intervals); specifications may differ by country or region

Interface	RJ-11 Phone Line RJ-11 Telephone set connection
------------------	--

Parent topic: [Technical Specifications](#)

Ink Cartridge Specifications

Note: This product uses only genuine Epson-brand cartridges. Other brands of ink cartridges and ink supplies are not compatible and, even if described as compatible, may not function properly.

The cartridges included with the printer are designed for printer setup and not for resale. After some ink is used for charging, the rest is available for printing. Yields vary considerably based on images printed, print settings, paper type, frequency of use, and temperature. For print quality, a variable amount of ink remains in the cartridge after the "replace cartridge" indicator comes on.

Color	Cyan, Magenta, Yellow, Black
Cartridge life	Opened package: 6 months Unopened package: do not use if the date on the package has expired
Temperature	Storage: -22 to 104 °F (-30 to 40 °C) 1 month at 104 °F (40 °C) Ink freezes at 3.2 °F (-16 °C) Ink thaws and is usable after 3 hours at 77 °F (25 °C)

Note: For best printing results, use up a cartridge within 6 months of opening the package.

Parent topic: [Technical Specifications](#)

Related references

[Ink Cartridge and Maintenance Box Part Numbers](#)

Dimension Specifications

Height	Stored: 13.0 inches (330 mm) Printing: 13.0 inches (330 mm)
---------------	--

Width	Stored: 16.7 inches (425 mm) Printing: 16.7 inches (425 mm)
Depth	Stored: 15.3 inches (388 mm) Printing: 19.8 inches (503 mm)
Weight (without ink cartridges and power cord)	26.7 lb (12.1 kg)

Parent topic: [Technical Specifications](#)

Electrical Specifications

Power supply voltage	100 to 240 V
Rated frequency range	50 to 60 Hz
Rated current	0.6 to 0.4 A
Power consumption	Standalone copying: Approximately 20 W (ISO/IEC24712) Ready mode: Approximately 8.9 W Sleep mode: Approximately 1.2 W Power off mode: Approximately 0.2 W

Parent topic: [Technical Specifications](#)

Environmental Specifications

Temperature	Operating: 50 to 95 °F (10 to 35 °C) Storage: -4 to 104 °F (-20 to 40 °C) 1 month at 104 °F (40 °C)
Humidity (without condensation)	Operating: 20 to 80% RH Storage: 5 to 85% RH

Parent topic: [Technical Specifications](#)

Interface Specifications

Interface type	Hi-Speed USB for computer Hi-Speed USB (for external USB device)
-----------------------	---

Note: Epson cannot guarantee the operation of externally connected devices.

Parent topic: [Technical Specifications](#)

Related references

[USB Device Photo File Specifications](#)

External USB Device Specifications

Do not use devices with the following requirements:

- Dedicated driver
- Security settings (such as passwords, encryption, etc.)
- Built-in USB hub

Note: Use only external storage devices with independent AC power sources. External storage devices that are powered via USB are not recommended. Epson cannot guarantee the operation of externally connected devices.

Magneto-optical drive	1.3GB
Hard disk drives and USB flash drives	2TB Formatted in FAT, FAT32, or exFAT.

Parent topic: [Technical Specifications](#)

Network Interface Specifications

Wi-Fi

Standards	IEEE 802.11 b/g/n; complies with either IEEE 802.11 b/g or IEEE 802.11 b/g/n, depending on purchase location
------------------	--

Security	WPA-PSK (AES); complies with WPA2 with support for WPA/WPA2 Personal WEP (64/128 bit)
Frequency range	2.4 GHz
Maximum Radio-Frequency Power Transmitted	19.8 dBm (EIRP)
Coordination modes	Infrastructure mode Wi-Fi Direct (Simple AP); not supported for IEEE 802.11b
Ethernet	
Standard	IEEE802.3i/u (10BASE-T); use a category 5e or higher STP (Shielded twisted pair) cable to prevent risk of radio interference IEEE802.3u (100BASE-TX) IEEE802.3az (Energy Efficient Ethernet); the connected device should be IEEE802.3az compliant
Communication mode	Auto, 10Mbps Full duplex, 10Mbps Half duplex, 100Mbps Full duplex, 100Mbps Half duplex
Connector	RJ-45
Security Protocol	
	SSL/TLS HTTPS Server/Client, IPPS SMTPS (STARTTLS, SSL/TLS)
Parent topic: Technical Specifications	

Safety and Approvals Specifications

United States	Safety: UL60950-1 EMC: FCC part 15 Subpart B class B
Canada	Safety: CAN/CSA C22.2 No. 60950-1 EMC: CAN/CSA-CEI/IEC CISPR 22 Class B

This equipment contains the following wireless module:

- Manufacturer: Askey Computer Corporation.
- Type: WLU6320-D69 (RoHS)

This product conforms to Part 15 of FCC Rules and RSS-210 of the IC Rules. Epson cannot accept responsibility for any failure to satisfy the protection requirements resulting from a non-recommended modification of the product. Operation is subject to the following two conditions: (1) this device may not cause harmful interference, and (2) this device must accept any interference received, including interference that may cause undesired operation of the device.

To prevent radio interference to the licensed service, this device is intended to be operated indoors and away from windows to provide maximum shielding. Equipment (or its transmit antenna) that is installed outdoors is subject to licensing.

This equipment complies with FCC/IC radiation exposure limits set forth for an uncontrolled environment and meets the FCC radio frequency (RF) Exposure Guidelines in Supplement C to OET65 and RSS-102 of the IC radio frequency (RF) Exposure rules. This equipment should be installed and operated so that the radiator is kept at least 7.9 inches (20 cm) or more away from a person's body (excluding extremities: hands, wrists, feet and ankles).

Parent topic: [Technical Specifications](#)

Notices

Check these sections for important notices about your product.

Note: Epson offers a recycling program for end of life Epson products. Please go to [this site](#) (U.S) or [this site](#) (Canada) for information on how to return your Epson products for proper disposal.

[Important Safety Instructions](#)

[FCC Compliance Statement](#)

[Binding Arbitration and Class Waiver](#)

[Trademarks](#)

[Copyright Notice](#)

Important Safety Instructions

Before using your Epson product, read and follow these safety instructions.

[General Product Safety Instructions](#)

[Ink Cartridge Safety Instructions](#)

[LCD Screen Safety Instructions](#)

[Wireless Connection Safety Instructions](#)

[Telephone Equipment Safety Instructions](#)

Parent topic: [Notices](#)

General Product Safety Instructions

- Be sure to follow all warnings and instructions marked on the product.
- Use only the type of power source indicated on the product's label.
- Use only the power cord that comes with the product. Use of another cord may cause fires or shock. Do not use the cord with any other equipment.
- Place the product near a wall outlet where the plug can be easily unplugged.
- Avoid plugging the product into an outlet on the same circuit as a photo copier or air control system that regularly switches on and off, or on an outlet controlled by a wall switch or timer.
- Do not let the power cord become damaged or frayed. Place it to avoid abrasions, cuts, fraying, crimping, and kinking. Do not place objects on top of it and do not allow it to be stepped on or run over. Be careful to keep the cord straight at each end.

- If you use an extension cord with the product, make sure the total ampere rating of the devices plugged into the extension cord does not exceed the cord's ampere rating. Also, make sure the total ampere rating of all devices plugged into the wall outlet does not exceed the wall outlet's ampere rating.
- Always turn off the product using the power button, and wait until the power light stops flashing before unplugging the product or cutting off power to the electrical outlet.
- If you will not be using the product for a long period, unplug the power cord from the electrical outlet.
- Place the product on a flat, stable surface that extends beyond its base in all directions. It will not operate properly if it is tilted or at an angle.
- Allow space behind the product for the cables, and space above the product so that you can fully raise the document cover.
- Leave enough space in front of the product for the paper to be fully ejected.
- Avoid locations that are subject to rapid changes in heat or humidity, shocks or vibrations, or dust.
- Do not place or store the product outdoors.
- Do not place the product near excessive heat sources or in direct sunlight.
- Leave enough room around the product for sufficient ventilation. Do not block or cover openings in the case or insert objects through the slots.
- Keep the product away from potential sources of electromagnetic interference, such as loudspeakers or the base units of cordless telephones.
- When connecting the product to a computer or other device with a cable, ensure the correct orientation of the connectors. Each connector has only one correct orientation. Inserting a connector in the wrong orientation may damage both devices connected by the cable.
- Do not touch the flat white cable inside the product.
- Do not move the print head by hand; this may damage the product.
- Do not spill liquid on the product or use the product with wet hands.
- Do not use aerosol products that contain flammable gases inside or around the product. Doing so may cause fire.
- Do not press too hard on the document table when placing originals.
- Do not open the scanner section while the product is copying, printing, scanning, or performing any other functions.
- Be careful not to trap your fingers when closing the document cover or scanner.
- Except as specifically explained in your documentation, do not attempt to service the product yourself.

- Unplug the product and refer servicing to qualified service personnel under the following conditions: if the power cord or plug is damaged; if liquid has entered the product; if the product has been dropped or the case damaged; if the product does not operate normally or exhibits a distinct change in performance. Adjust only those controls that are covered by the operating instructions.
- Leave the ink cartridges installed. Removing the cartridges can dehydrate the print head and may prevent the product from printing.
- Before transporting the product, make sure that the print head is in the home (far right) position and the ink cartridges are in place.
- Before transporting the product, make sure that the print head is in the home (far right) position.
- When storing or transporting the product, do not tilt it, stand it on its side, or turn it upside down; otherwise ink may leak.

Note: The lithium batteries in this product contain Perchlorate Material - special handling may apply. [Click here](#) for details.

Parent topic: [Important Safety Instructions](#)

Ink Cartridge Safety Instructions

- Keep ink cartridges out of the reach of children and do not drink the ink.
- Be careful when you handle used ink cartridges; there may be ink remaining around the ink supply port. If ink gets on your skin, wash it off with soap and water. If it gets in your eyes, flush them immediately with water.
- Do not put your hand inside the product or touch any cartridges during printing.
- Install a new ink cartridge immediately after removing an expended one. Leaving cartridges uninstalled can dry out the print head and may prevent the product from printing.
- Do not remove or tear the label on the cartridge; this can cause leakage.
- Do not remove the transparent seal from the bottom of the cartridge. This may cause the cartridge to become unusable.
- Do not break the hooks on the side of the cartridge when removing it from the packaging.
- Do not touch the green IC chip on the side of the cartridge. This may prevent normal operation.
- Do not shake cartridges after opening their packages; this can cause them to leak.
- If you remove an ink cartridge for later use, protect the ink supply area from dirt and dust and store it in the same environment as the product. Note that there is a valve in the ink supply port, making covers

or plugs unnecessary, but care is needed to prevent the ink from staining items that the cartridge touches. Do not touch the ink cartridge ink supply port or surrounding area.

- Use an ink cartridge before the date printed on its package.
- Do not dismantle an ink cartridge. This could damage the print head.
- Store ink cartridges in a cool, dark place.
- After bringing an ink cartridge inside from a cold storage site, allow it to warm up at room temperature for at least three hours before using it.
- Store ink cartridges with their labels facing upward. Do not store cartridges upside down.

Parent topic: [Important Safety Instructions](#)

LCD Screen Safety Instructions

- Use only a dry, soft cloth to clean the LCD screen. Do not use liquid or chemical cleansers.
- If the LCD screen is damaged, contact Epson. If the liquid crystal solution gets on your hands, wash them thoroughly with soap and water. If the liquid crystal solution gets into your eyes, flush them immediately with water. If discomfort or vision problems remain after a thorough flushing, see a doctor immediately.
- Do not press too hard on the LCD screen or subject it to heavy impacts.
- Do not use a pointy or sharp object, such as a pen or your fingernail, to operate the LCD screen.
- If the LCD screen chips or cracks, do not touch or attempt to remove the broken pieces; contact Epson for support.
- Do not subject your product to sudden changes in temperature or humidity; this may cause condensation to develop inside the LCD screen and degrade its performance.

Parent topic: [Important Safety Instructions](#)

Wireless Connection Safety Instructions

Radio waves from this product may adversely affect the operation of medical equipment or automatically controlled devices, such as pacemakers, automatic doors or fire alarms. When using this product near such devices or inside a medical facility, follow the directions from authorized staff members at the facility, and follow all posted warnings and directions on the device to avoid causing an accident.

Parent topic: [Important Safety Instructions](#)

Telephone Equipment Safety Instructions

When using telephone equipment, you should always follow basic safety precautions to reduce the risk of fire, electric shock, and personal injury, including the following:

- Do not use the Epson product near water.
- Avoid using a telephone during an electrical storm. There may be a remote risk of electric shock from lightning.
- Do not use a telephone to report a gas leak in the vicinity of the leak.

Caution: To reduce the risk of fire, use only a No. 26 AWG or larger telecommunication line cord.

Parent topic: [Important Safety Instructions](#)

FCC Compliance Statement

For United States Users

This equipment complies with Part 68 of the FCC rules and the requirements adopted by the Administrative Council for Terminal Attachments ("ACTA") . On the surface of this equipment is a label that contains, among other information, a product identifier in the format US:AAAEQ##TXXXX. If requested, this number must be provided to the telephone company.

Applicable certification jack Universal Service Order Codes ("USOC") for the equipment: RJ11C.

A plug and jack used to connect this equipment to the premises wiring and telephone network must comply with the applicable FCC Part 68 rules and requirements adopted by the ACTA. A compliant telephone cord and modular plug is provided with this product. It is designed to be connected to a compatible modular jack that is also compliant. See installation instructions for details.

The REN is used to determine the number of devices that may be connected to a telephone line. Excessive RENs on a telephone line may result in the devices not ringing in response to an incoming call. In most but not all areas, the sum of RENs should not exceed five (5.0). To be certain of the number of devices that may be connected to a line, as determined by the total RENs, contact the local telephone company. For products approved after July 23, 2001 , the REN for this product is part of the product identifier that has the format US:AAAEQ##TXXXX. The digits represented by ## are the REN without a decimal point (e.g., 03 is a REN of 0.3). For earlier products, the REN is separately shown on the label.

If this equipment causes harm to the telephone network, the telephone company will notify you in advance that temporary discontinuance of service may be required. But if advance notice isn't practical, the telephone company will notify the customer as soon as possible. Also, you will be advised of your right to file a complaint with the FCC if you believe it is necessary.

The telephone company may make changes in its facilities, equipment, operations or procedures that could affect the operation of the equipment. If this happens the telephone company will provide advance notice in order for you to make necessary modifications to maintain uninterrupted service.

If you have problems with this product and require technical or customer support, please visit www.epson.com for more information.

This product is not intended to be repaired by the customer. If you experience trouble connecting this equipment to a telephone line, please contact:

Name: Epson America, Inc.

Address: 3840 Kilroy Airport Way, Long Beach, CA 90806 U.S.A.

Telephone: (562) 981-3840

If the equipment is causing harm to the telephone network, the telephone company may request that you disconnect the equipment until the problem is resolved.

This equipment may not be used on coin service provided by the telephone company. Connection to party line service is subject to state tariffs. Contact the state public utility commission, public service commission or corporation commission for information.

If your home has specially wired alarm equipment connected to the telephone line, ensure the installation of this equipment does not disable your alarm equipment. If you have questions about what will disable alarm equipment, consult your telephone company or a qualified installer.

The Telephone Consumer Protection Act of 1991 makes it unlawful for any person to use a computer or other electronic device, including fax machines, to send any message unless such message clearly contains in a margin at the top or bottom of each transmitted page or on the first page of the transmission, the date and time it is sent and an identification of the business or other entity, or other individual sending the message and the telephone number of the sending machine or such business, other entity, or individual. (The telephone number provided may not be a 900 number or any other number for which charges exceed local or long-distance transmission charges.)

In order to program this information into your fax machine, click the link below for instructions on entering fax header information.

According to the FCC's electrical safety advisory, we recommend that you may install an AC surge arrester in the AC outlet to which this equipment is connected. Telephone companies report that electrical surges, typically lightning transients, are very destructive to customer terminal equipment connected to AC power sources and that this is a major nationwide problem.

This equipment has been tested and found to comply with the limits for a Class B digital device, pursuant to Part 15 of the FCC Rules. These limits are designed to provide reasonable protection against harmful interference in a residential installation. This equipment generates, uses, and can radiate radio frequency energy and, if not installed and used in accordance with the instructions, may cause harmful

interference to radio or television reception. However, there is no guarantee that interference will not occur in a particular installation. If this equipment does cause interference to radio and television reception, which can be determined by turning the equipment off and on, the user is encouraged to try to correct the interference by one or more of the following measures:

- Reorient or relocate the receiving antenna.
- Increase the separation between the equipment and receiver.
- Connect the equipment into an outlet on a circuit different from that to which the receiver is connected.
- Consult the dealer or an experienced radio/TV technician for help.

WARNING

The connection of a non-shielded equipment interface cable to this equipment will invalidate the FCC Certification or Declaration of this device and may cause interference levels which exceed the limits established by the FCC for this equipment. It is the responsibility of the user to obtain and use a shielded equipment interface cable with this device. If this equipment has more than one interface connector, do not leave cables connected to unused interfaces. Changes or modifications not expressly approved by the manufacturer could void the user's authority to operate the equipment.

For Canadian Users

1. This product meets the applicable Innovation, Science and Economic Development Canada technical specifications.
2. The Ringer Equivalence Number indicates the maximum number of devices allowed to be connected to a telephone interface. The termination of an interface may consist of any combination of devices subject only to the requirement that the sum of the RENs of all the devices does not exceed five.

CAN ICES-3(B)/NMB-3(B)

Le présent produit est conforme aux spécifications techniques applicables d'Innovation, Sciences et Développement économique Canada.

L'indice d'équivalence de la sonnerie (IES) sert à indiquer le nombre maximal de dispositifs qui peuvent être raccordés à une interface téléphonique. La terminaison d'une interface peut consister en une combinaison quelconque de dispositifs, à la seule condition que la somme des IES de tous les dispositifs n'excède pas cinq.

CAN ICES-3(B)/NMB-3(B)

Parent topic: [Notices](#)

Related tasks

[Using the Fax Setup Wizard](#)

Binding Arbitration and Class Waiver

1. DISPUTES, BINDING INDIVIDUAL ARBITRATION, AND WAIVER OF CLASS ACTIONS AND CLASS ARBITRATIONS

1.1 **Disputes.** The terms of this Section 1 shall apply to all Disputes between you and Epson. The term "Dispute" is meant to have the broadest meaning permissible under law and includes any dispute, claim, controversy or action between you and Epson arising out of or relating to this Agreement, Epson branded products (hardware and including any related software), or other transaction involving you and Epson, whether in contract, warranty, misrepresentation, fraud, tort, intentional tort, statute, regulation, ordinance, or any other legal or equitable basis. "DISPUTE" DOES NOT INCLUDE IP CLAIMS, or more specifically, a claim or cause of action for (a) trademark infringement or dilution, (b) patent infringement, (c) copyright infringement or misuse, or (d) trade secret misappropriation (an "IP Claim"). You and Epson also agree, notwithstanding Section 1.6, that a court, not an arbitrator, may decide if a claim or cause of action is for an IP Claim.

1.2 **Binding Arbitration.** You and Epson agree that all Disputes shall be resolved by binding arbitration according to this Agreement. **ARBITRATION MEANS THAT YOU WAIVE YOUR RIGHT TO A JUDGE OR JURY IN A COURT PROCEEDING AND YOUR GROUNDS FOR APPEAL ARE LIMITED.**

Pursuant to this Agreement, binding arbitration shall be administered by JAMS, a nationally recognized arbitration authority, pursuant to its code of procedures then in effect for consumer related disputes, but excluding any rules that permit joinder or class actions in arbitration (for more detail on procedure, see Section 1.6 below). You and Epson understand and agree that (a) the Federal Arbitration Act (9 U.S.C. §1, et seq.) governs the interpretation and enforcement of this Section 1, (b) this Agreement memorializes a transaction in interstate commerce, and (c) this Section 1 shall survive termination of this Agreement.

1.3 **Pre-Arbitration Steps and Notice.** Before submitting a claim for arbitration, you and Epson agree to try, for sixty (60) days, to resolve any Dispute informally. If Epson and you do not reach an agreement to resolve the Dispute within the sixty (60) days, you or Epson may commence an arbitration. Notice to Epson must be addressed to: Epson America, Inc., ATTN: Legal Department, 3840 Kilroy Airport Way, Long Beach, CA 90806 (the "Epson Address"). The Dispute Notice to you will be sent to the most recent address Epson has in its records for you. For this reason, it is important to notify us if your address changes by emailing us at EAILEgal@ea.epson.com or writing us at the Epson Address above. Notice of the Dispute shall include the sender's name, address and contact information, the facts giving rise to the Dispute, and the relief requested (the "Dispute Notice"). Following receipt of the Dispute Notice, Epson and you agree to act in good faith to resolve the Dispute before commencing arbitration.

1.4 **Small Claims Court.** Notwithstanding the foregoing, you may bring an individual action in the small claims court of your state or municipality if the action is within that court's jurisdiction and is pending only in that court.

1.5 WAIVER OF CLASS ACTIONS AND CLASS ARBITRATIONS. YOU AND EPSON AGREE THAT EACH PARTY MAY BRING DISPUTES AGAINST THE OTHER PARTY ONLY IN AN INDIVIDUAL CAPACITY, AND NOT AS A PLAINTIFF OR CLASS MEMBER IN ANY CLASS OR REPRESENTATIVE PROCEEDING, INCLUDING WITHOUT LIMITATION FEDERAL OR STATE CLASS ACTIONS, OR CLASS ARBITRATIONS. CLASS ACTION LAWSUITS, CLASS-WIDE ARBITRATIONS, PRIVATE ATTORNEY-GENERAL ACTIONS, AND ANY OTHER PROCEEDING WHERE SOMEONE ACTS IN A REPRESENTATIVE CAPACITY ARE NOT ALLOWED. ACCORDINGLY, UNDER THE ARBITRATION PROCEDURES OUTLINED IN THIS SECTION, AN ARBITRATOR SHALL NOT COMBINE OR CONSOLIDATE MORE THAN ONE PARTY'S CLAIMS WITHOUT THE WRITTEN CONSENT OF ALL AFFECTED PARTIES TO AN ARBITRATION PROCEEDING.

1.6 Arbitration Procedure. If you or Epson commences arbitration, the arbitration shall be governed by the rules of JAMS that are in effect when the arbitration is filed, excluding any rules that permit arbitration on a class or representative basis (the "JAMS Rules"), available at <http://www.jamsadr.com> or by calling 1-800-352-5267, and under the rules set forth in this Agreement. All Disputes shall be resolved by a single neutral arbitrator, and both parties shall have a reasonable opportunity to participate in the selection of the arbitrator. The arbitrator is bound by the terms of this Agreement. The arbitrator, and not any federal, state or local court or agency, shall have exclusive authority to resolve all disputes arising out of or relating to the interpretation, applicability, enforceability or formation of this Agreement, including any claim that all or any part of this Agreement is void or voidable. Notwithstanding this broad delegation of authority to the arbitrator, a court may determine the limited question of whether a claim or cause of action is for an IP Claim, which is excluded from the definition of "Disputes" in Section 1.1 above. The arbitrator shall be empowered to grant whatever relief would be available in a court under law or in equity. The arbitrator may award you the same damages as a court could, and may award declaratory or injunctive relief only in favor of the individual party seeking relief and only to the extent necessary to provide relief warranted by that party's individual claim. In some instances, the costs of arbitration can exceed the costs of litigation and the right to discovery may be more limited in arbitration than in court. The arbitrator's award is binding and may be entered as a judgment in any court of competent jurisdiction.

You may choose to engage in arbitration hearings by telephone. Arbitration hearings not conducted by telephone shall take place in a location reasonably accessible from your primary residence, or in Orange County, California, at your option.

a) Initiation of Arbitration Proceeding. If either you or Epson decides to arbitrate a Dispute, both parties agree to the following procedure:

(i) Write a Demand for Arbitration. The demand must include a description of the Dispute and the amount of damages sought to be recovered. You can find a copy of a Demand for Arbitration at <http://www.jamsadr.com> ("Demand for Arbitration").

(ii) Send three copies of the Demand for Arbitration, plus the appropriate filing fee, to: JAMS, 500 North State College Blvd., Suite 600 Orange, CA 92868, U.S.A.

(iii) Send one copy of the Demand for Arbitration to the other party (same address as the Dispute Notice), or as otherwise agreed by the parties.

b) Hearing Format. During the arbitration, the amount of any settlement offer made shall not be disclosed to the arbitrator until after the arbitrator determines the amount, if any, to which you or Epson is entitled. The discovery or exchange of non-privileged information relevant to the Dispute may be allowed during the arbitration.

c) Arbitration Fees. Epson shall pay, or (if applicable) reimburse you for, all JAMS filings and arbitrator fees for any arbitration commenced (by you or Epson) pursuant to provisions of this Agreement.

d) Award in Your Favor. For Disputes in which you or Epson seeks \$75,000 or less in damages exclusive of attorney's fees and costs, if the arbitrator's decision results in an award to you in an amount greater than Epson's last written offer, if any, to settle the Dispute, Epson will: (i) pay you \$1,000 or the amount of the award, whichever is greater; (ii) pay you twice the amount of your reasonable attorney's fees, if any; and (iii) reimburse you for any expenses (including expert witness fees and costs) that your attorney reasonably accrues for investigating, preparing, and pursuing the Dispute in arbitration. Except as agreed upon by you and Epson in writing, the arbitrator shall determine the amount of fees, costs, and expenses to be paid by Epson pursuant to this Section 1.6d).

e) Attorney's Fees. Epson will not seek its attorney's fees and expenses for any arbitration commenced involving a Dispute under this Agreement. Your right to attorney's fees and expenses under Section 1.6d) above does not limit your rights to attorney's fees and expenses under applicable law; notwithstanding the foregoing, the arbitrator may not award duplicative awards of attorney's fees and expenses.

1.7 Opt-out. You may elect to opt-out (exclude yourself) from the final, binding, individual arbitration procedure and waiver of class and representative proceedings specified in this Agreement by sending a written letter to the Epson Address within thirty (30) days of your assent to this Agreement (including without limitation the purchase, download, installation of the Software or other applicable use of Epson Hardware, products and services) that specifies (i) your name, (ii) your mailing address, and (iii) your request to be excluded from the final, binding individual arbitration procedure and waiver of class and representative proceedings specified in this Section 1. In the event that you opt-out consistent with the procedure set forth above, all other terms shall continue to apply, including the requirement to provide notice prior to litigation.

1.8 Amendments to Section 1. Notwithstanding any provision in this Agreement to the contrary, you and Epson agree that if Epson makes any future amendments to the dispute resolution procedure and class action waiver provisions (other than a change to Epson's address) in this Agreement, Epson will obtain your affirmative assent to the applicable amendment. If you do not affirmatively assent to the applicable amendment, you are agreeing that you will arbitrate any Dispute between the parties in accordance with the language of this Section 1 (or resolve disputes as provided for in Section 1.7, if you timely elected to opt-out when you first assented to this Agreement).

1.9 Severability. If any provision in this Section 1 is found to be unenforceable, that provision shall be severed with the remainder of this Agreement remaining in full force and effect. **The foregoing shall not apply to the prohibition against class or representative actions as provided in Section 1.5. This means that if Section 1.5 is found to be unenforceable, the entire Section 1 (but only Section 1) shall be null and void.**

Parent topic: [Notices](#)

Trademarks

EPSON® is a registered trademark, EPSON Exceed Your Vision is a registered logomark, and Epson Connect™ is a trademark of Seiko Epson Corporation.

Epson iPrint™ and Remote Print™ are trademarks of Seiko Epson Corporation.

Apple, App Store, AirPrint, AirPrint logo, iPad, iPhone, iPod touch, Mac, and OS X are trademarks of Apple Inc., registered in the U.S. and other countries. macOS is a trademark of Apple Inc.

Google® is a registered trademark and Android™, Chromebook™, Gmail™, Google Chrome™, Google Cloud Print™, Google Drive™, and Google Play™ are trademarks of Google Inc.

Wi-Fi Direct® is a registered trademark of Wi-Fi Alliance®.

General Notice: Other product names used herein are for identification purposes only and may be trademarks of their respective owners. Epson disclaims any and all rights in those marks.



Parent topic: [Notices](#)

Copyright Notice

All rights reserved. No part of this publication may be reproduced, stored in a retrieval system, or transmitted in any form or by any means, electronic, mechanical, photocopying, recording, or otherwise, without the prior written permission of Seiko Epson Corporation. The information contained herein is designed only for use with this Epson product. Epson is not responsible for any use of this information as applied to other products.

Neither Seiko Epson Corporation nor its affiliates shall be liable to the purchaser of this product or third parties for damages, losses, costs, or expenses incurred by purchaser or third parties as a result of: accident, misuse, or abuse of this product or unauthorized modifications, repairs, or alterations to this

product, or (excluding the U.S.) failure to strictly comply with Seiko Epson Corporation's operating and maintenance instructions.

Seiko Epson Corporation shall not be liable for any damages or problems arising from the use of any options or any consumable products other than those designated as Original Epson Products or Epson Approved Products by Seiko Epson Corporation.

Seiko Epson Corporation shall not be held liable for any damage resulting from electromagnetic interference that occurs from the use of any interface cables other than those designated as Epson approved Products by Seiko Epson Corporation.

This information is subject to change without notice.

[libTIFF Software Acknowledgment](#)

[A Note Concerning Responsible Use of Copyrighted Materials](#)

[Default Delay Times for Power Management for Epson Products](#)

[Copyright Attribution](#)

Parent topic: [Notices](#)

libTIFF Software Acknowledgment

Copyright © 1988-1997 Sam Leffler

Copyright © 1991-1997 Silicon Graphics, Inc.

Permission to use, copy, modify, distribute, and sell this software and its documentation for any purpose is hereby granted without fee, provided that (i) the above copyright notices and this permission notice appear in all copies of the software and related documentation, and (ii) the names of Sam Leffler and Silicon Graphics may not be used in any advertising or publicity relating to the software without the specific, prior written permission of Sam Leffler and Silicon Graphics.

THE SOFTWARE IS PROVIDED "AS-IS" AND WITHOUT WARRANTY OF ANY KIND, EXPRESS, IMPLIED OR OTHERWISE, INCLUDING WITHOUT LIMITATION, ANY WARRANTY OF MERCHANTABILITY OR FITNESS FOR A PARTICULAR PURPOSE.

IN NO EVENT SHALL SAM LEFFLER OR SILICON GRAPHICS BE LIABLE FOR ANY SPECIAL, INCIDENTAL, INDIRECT OR CONSEQUENTIAL DAMAGES OF ANY KIND, OR ANY DAMAGES WHATSOEVER RESULTING FROM LOSS OF USE, DATA OR PROFITS, WHETHER OR NOT ADVISED OF THE POSSIBILITY OF DAMAGE, AND ON ANY THEORY OF LIABILITY, ARISING OUT OF OR IN CONNECTION WITH THE USE OR PERFORMANCE OF THIS SOFTWARE.

Parent topic: [Copyright Notice](#)

A Note Concerning Responsible Use of Copyrighted Materials

Epson encourages each user to be responsible and respectful of the copyright laws when using any Epson product. While some countries' laws permit limited copying or reuse of copyrighted material in certain circumstances, those circumstances may not be as broad as some people assume. Contact your legal advisor for any questions regarding copyright law.

Parent topic: [Copyright Notice](#)

Default Delay Times for Power Management for Epson Products

This product will enter sleep mode after a period of nonuse. This is to ensure that the product meets Energy Star standards of energy efficiency. More energy savings can be achieved by setting the time to sleep to a shorter interval.

Parent topic: [Copyright Notice](#)

Copyright Attribution

© 2017 Epson America, Inc.

4/17

CPD-53015

Parent topic: [Copyright Notice](#)