

Quick Setup

Before using the projector, make sure you read the safety instructions in the online *User's Guide*.

Connect the projector

Choose from the following connections. See the sections below or the online *User's Guide* for details.

Computer

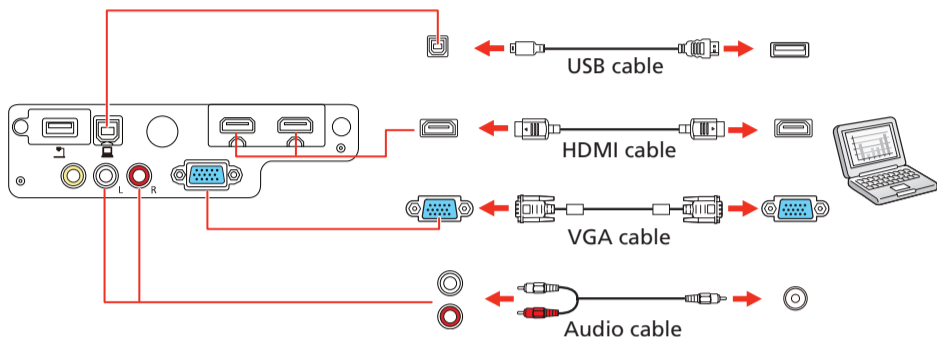

Computer port

Connect one end of a VGA cable to the projector's **Computer** port, and the other end to your laptop or computer's monitor port. Make sure to switch your laptop to external display (see "Troubleshooting"). You can also connect an audio cable.

HDMI port

Connect one end of an HDMI cable to the projector's **HDMI1** or **HDMI2** ports and the other end to an HDMI port on your computer.

USB port

Connect the square end of a USB cable to the projector's **USB-B** (square) port. Connect the flat end of the cable to any USB port on your computer.

Windows® XP or later: After turning on the projector, follow the on-screen instructions to install the Epson® USB Display software (**EMP_UDSE.EXE**; only on first connection). If the software screen does not display automatically, open **My Computer** or **Computer**, then double-click **EPSON_PJ_UD**.

OS X 10.5.8 or higher: After turning on the projector, the setup folder for USB Display appears in the Finder. Double-click **USB Display Installer** and follow the on-screen instructions to install the Epson USB Display software (only on first connection).

Note: If you have problems installing the USB Display software, make sure the **USB Type B** setting in the projector's **Extended** menu is set to **USB Display**. See the online *User's Guide* for instructions.

Video device

Connect multiple video devices and use the **Source Search** button on the projector or the remote control to switch between them.

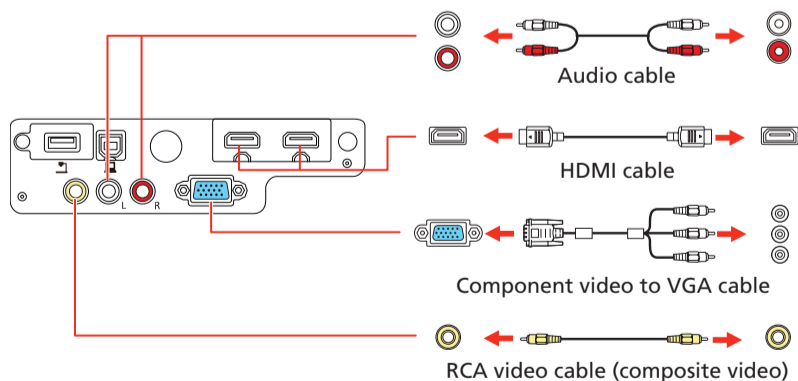

Mobile media device

Connect tablets, smartphones, and other devices that support the MHL™ standard to the **HDMI2/MHL** port.

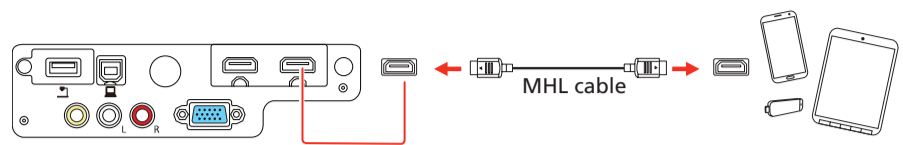

Some devices may require an adapter or may not require an MHL cable. Not all features or functions may be supported. Check your device's documentation for more information.

USB device

Connect a digital camera, USB flash drive, or USB storage device to the projector's **USB-A** (flat) port.

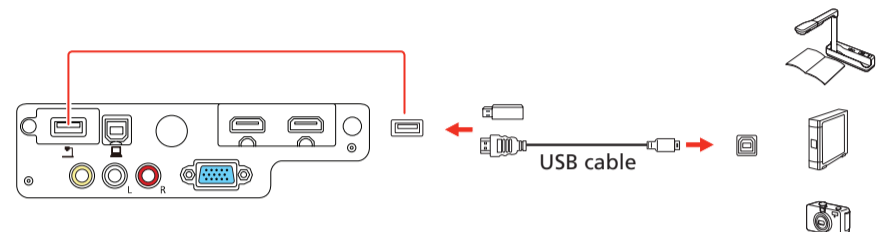

If you connect a digital camera, USB flash drive, or USB storage device, you can use the projector's PC Free feature. You can also connect other Epson document cameras to the projector. See the online *User's Guide* for details.

Turn on your equipment

- 1 Turn on your computer or video source.
- 2 Plug in the projector. The power light on the projector turns blue.

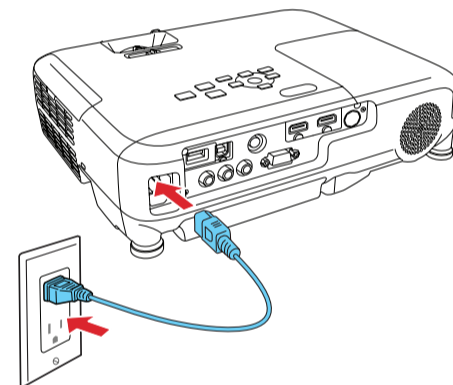

- 3 Open the **AV Mute** slide all the way.

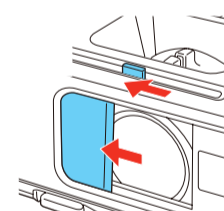

- 4 Press the power button on the projector or remote control. The projector beeps, the Status light flashes blue, and then stays on.

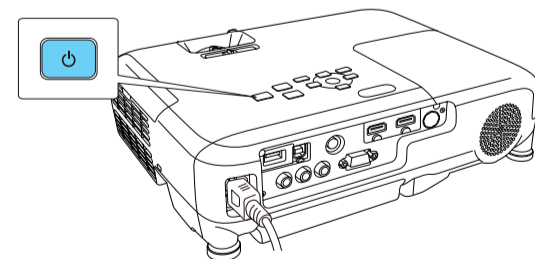

Note: To shut down the projector, press the power button twice, then unplug it. You don't have to wait for the projector to cool down.

- Use the arrow buttons on the remote control to highlight any of the options on the Home screen that appears, then press to select it. You can display a QR code, switch between projection sources, and quickly access various adjustment options from this screen.



- The default language of the menu system is English. To select another language, press the **Menu** button on the projector or remote control. Select **Extended** and press . Select **Language** and press . Select your language and press . Press the **Menu** button to exit the menu system.

Adjust the image

- If you don't see an image, press the **Source Search** button on the projector or the remote control to select the image source.

Note: If you still see a blank screen or have other display problems, see the troubleshooting tips on the back of this sheet.

- To raise the image, press the foot release button and lift the front of the projector. Release the button to lock the foot in position.

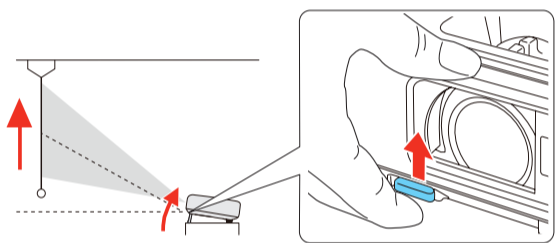

- To reduce or enlarge the image, turn the zoom ring.

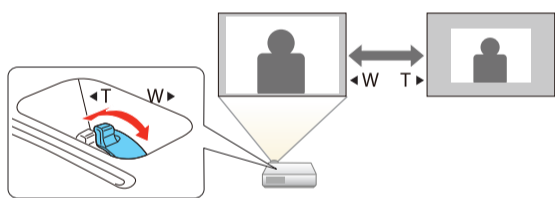

- Turn the focus ring to sharpen the image.

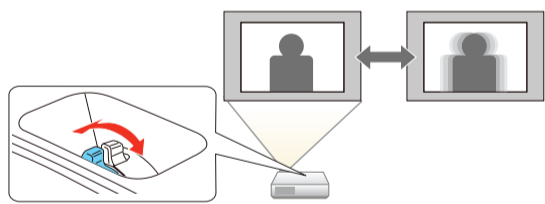

- If your image looks like or , you may have placed the projector off to one side of the screen at an angle. Place the projector directly in front of the center of the screen, facing the screen squarely. If you can't move the projector, use the horizontal keystone slider on the projector to correct the image shape.

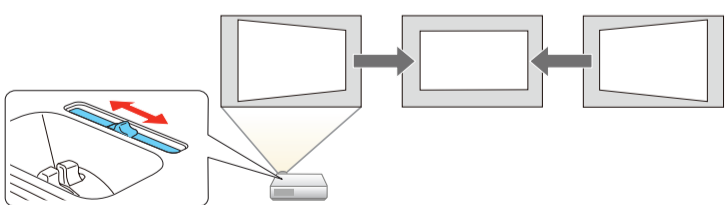

- Your projector automatically adjusts images that look like or , but if necessary you can press the or button on the projector to correct it.

Using the remote control

Make sure the batteries are installed as shown (two AA batteries).

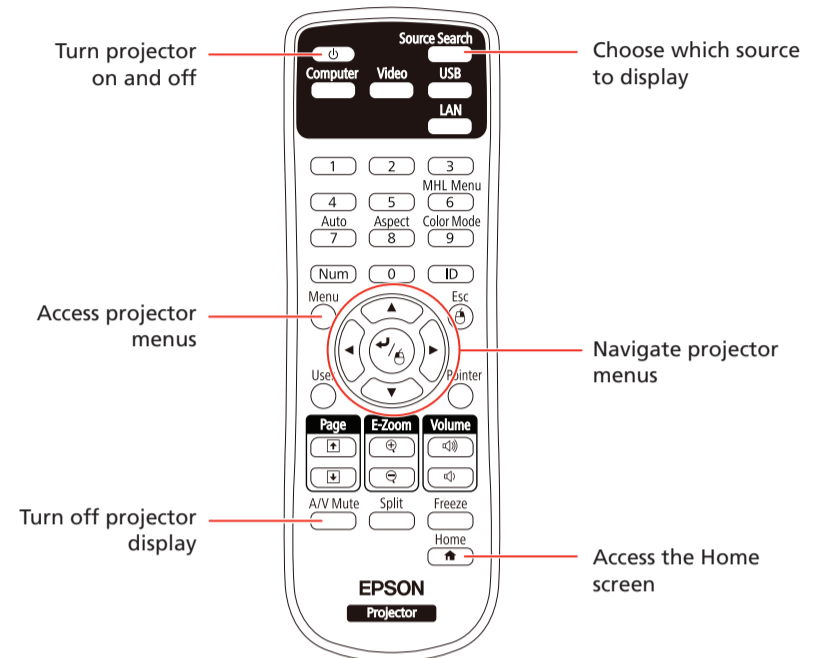
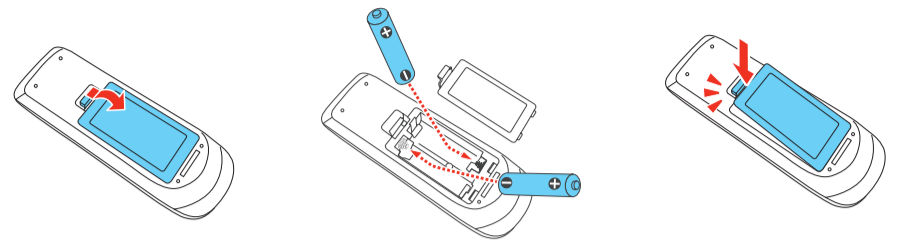

For more information on using the remote control, see the online *User's Guide*.

Project wirelessly

Follow the steps here to connect the projector over a wireless network.

If you're projecting from a computer, it must have a wireless card or built-in wireless interface, and be running Windows 10, Windows 8, Windows 7, Windows Vista®, Windows XP Professional x64, or Windows XP, or OS X 10.5.8 to 10.10.x.

- Press the **Menu** button on the remote control, select the **Network** menu, and press .

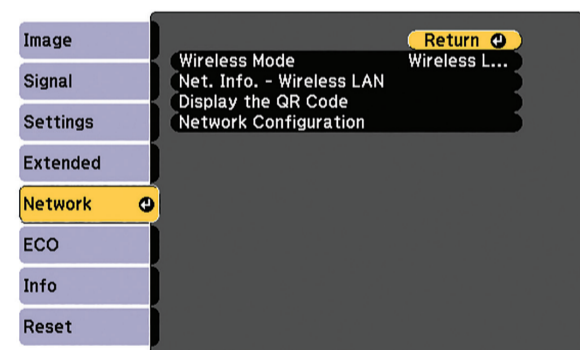

- Choose **Network Configuration** and press .

- Select the **Wireless LAN** menu and press .

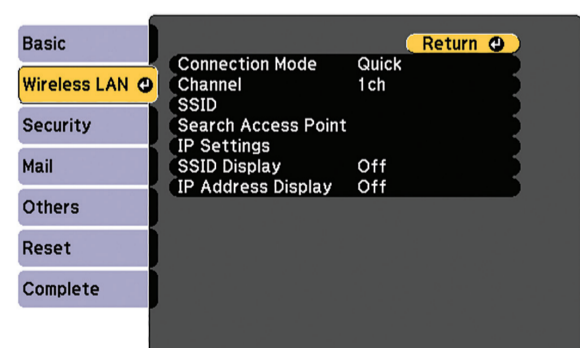

- Choose **Connection Mode**, press , select **Quick** for a direct connection to a computer, tablet, or smartphone, then press again. When you're finished, press **Esc** to return to the Wireless LAN menu.

Note: For instructions on setting up an Advanced connection for a connection to a router or access point, see the online *User's Guide*.



- To prevent the SSID and IP address from appearing on the network standby screen, set the **SSID Display** and **IP Address Display** settings to **Off**.
- When you're finished selecting settings in the Wireless LAN menu, press **Esc**.
- Select **Complete** and press \swarrow/\swarrow , then select **Yes** and press \swarrow/\swarrow again to save your settings.

Install network software

Install links to download the network software and manuals from the projector CD. Downloads require an Internet connection. You can also install the software and manuals from the Epson website, as described in "Where to get help."

To project over the network, install the EasyMP® Network Projection software on each computer you will project from. To monitor and control your projector over the network, install the EasyMP Monitor software (Windows only). To project from multiple PCs over the network, install the EasyMP Multi PC Projection software.

Click the icons on your desktop to download and install the software and their manuals. See the manuals for instructions on installing and using the software.

Project wirelessly from a mobile device

You can connect your mobile device and projector using Epson iProjection™ and a QR code. Make sure the latest version of Epson iProjection is installed on your device.

Install the Epson iProjection app

To project from an iOS or Android™ device, download and install the Epson iProjection app. Visit epson.com/projectorapp (U.S.) or epson.ca/projectorapp (Canada) for more information.



Direct wireless connection

Make sure your device and Epson projector are not connected to a network and your Epson projector's **Connection Mode** is set to **Quick**.

- Tap  **iProjection** on your device's Home screen.
- Tap **Projector** to open the Search Projector menu.

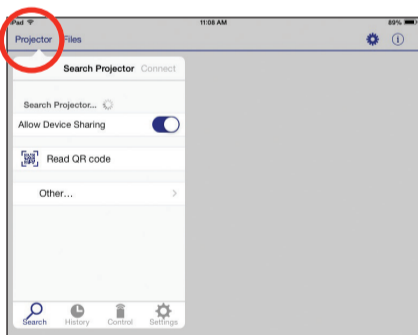

- Tap **Read QR code**.
- Point your device's camera at the QR code your projector displays; the QR code is read automatically.
- Tap **OK** to register your projector's Wi-Fi profile.
- Tap **Install** to install your projector's Wi-Fi profile.
- Tap **Install Now** at the Unsigned Profile notification.
- Tap **Done** to exit the Profile Installed screen.
- Tap **OK** to confirm the connection to the projector.
- Note the projector network name (SSID) shown on your device's screen. Then go to the Wi-Fi settings on your device to select that network.

Your device and Epson projector are now connected.

Network connection

Make sure your projector and mobile device are connected to the same network.

- Tap  **iProjection** on your device's Home screen.
- Tap **Projector** to open the Search Projector menu.

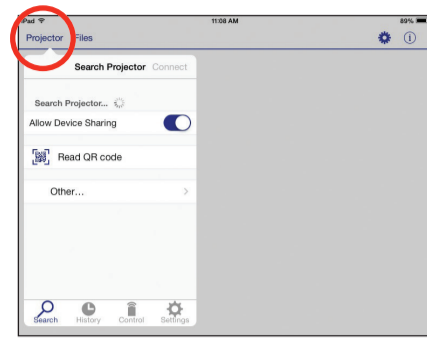

- Tap **Read QR code**.
- Point your device's camera at the QR code your projector displays; the QR code is read automatically.

Your device and Epson projector are now connected.

Troubleshooting

If you see a blank screen or the **No signal** message after turning on your computer or video device, check the following:

- Make sure the Status light on the projector is blue and not flashing, and the A/V Mute slide is open.
- Press the **Source Search** button on the projector or the remote control to switch to the correct image source, if necessary.
- Press the **Home** button on the projector or remote control to verify the source input and settings.
- If you're using a Windows laptop, press the function key on your keyboard that lets you display on an external monitor. It may be labeled **CRT/LCD** or have an icon such as . You may have to hold down the **Fn** key while pressing it (such as **Fn + F7**). Wait a moment for the display to appear.
- If you're using a Mac laptop, open **System Preferences** and select **Displays**. Click the **Arrangement** tab and select the **Mirror Displays** checkbox.

Where to get help

Manuals

For more information about using the projector, click the icons on your desktop to access the online manuals (requires an Internet connection). If you don't see icons to the manuals, you can install them from the projector CD or go to the Epson website, as described below.

Telephone support services

To use the Epson® PrivateLine® Support service, call (800) 637-7661. This service is available for the duration of your warranty period. You may also speak with a support specialist by calling (562) 276-4394 (U.S.) or (905) 709-3839 (Canada).

Support hours are 6 AM to 8 PM, Pacific Time, Monday through Friday, and 7 AM to 4 PM, Pacific Time, Saturday. Days and hours of support are subject to change without notice. Toll or long distance charges may apply.

Internet support

Visit epson.com/support (U.S.) or epson.ca/support (Canada) for solutions to common problems. You can download utilities and documentation, get FAQs and troubleshooting advice, or e-mail Epson.

For more information on wireless projection, visit epson.com/wirelessprojectors.

Registration

Register today to get product updates and exclusive offers. You can use the CD included with your projector or register online at epson.com/webreg.

Optional accessories

For a list of optional accessories, see the online *User's Guide*.

You can purchase screens or other accessories from an Epson authorized reseller. To find the nearest reseller, call 800-GO-EPSON (800-463-7766). Or you can purchase online at epsonstore.com (U.S. sales) or epson.ca (Canadian sales).

Wireless notice

Contains wireless LAN 802.11b/g/n module

Model: WN7122BEP

This document provides safety instructions and describes the specifications. Read this document carefully before use to ensure your safety and product performance.

The grantee is not responsible for any changes or modifications not expressly approved by the party responsible for compliance. Such modifications could void the user's authority to operate the equipment. This equipment should be installed and operated keeping the radiator at least 7.9 inches (20 cm) or more away from person's body. This device is restricted to indoor operations only.



EPSON, PowerLite, and EasyMP are registered trademarks, Epson iProjection is a trademark, and EPSON Exceed Your Vision is a registered logomark of Seiko Epson Corporation. PrivateLine is a registered trademark and Epson Connection is a service mark of Epson America, Inc.

Mac and OS X are trademarks of Apple Inc., registered in the U.S. and other countries.

Android is a trademark of Google Inc.

General Notice: Other product names used herein are for identification purposes only and may be trademarks of their respective owners. Epson disclaims any and all rights in those marks.

This information is subject to change without notice.

© 2015 Epson America, Inc., 9/15

Printed in XXXXXX

CPD-42655R1