



Owner's Manual

# LG CineBeam

DLP Projector

Please read the safety information carefully before using this product.

PH510P

[www.lg.com](http://www.lg.com)

P/NO : SAC37813581 (2010-REV00)

Copyright © 2020 LG Electronics Inc. All Rights Reserved.

# LICENSE

Supported licenses may differ by model. For more information about licenses, visit [www.lg.com](http://www.lg.com).



Manufactured under license from Dolby Laboratories. Dolby and the double-D symbol are trademarks of Dolby Laboratories.



The terms HDMI, HDMI High-Definition Multimedia Interface, and the HDMI Logo are trademarks or registered trademarks of HDMI Licensing Administrator, Inc.

## NOTE

- Image shown may differ from your projector.
- Your projector's OSD (On Screen Display) may differ slightly from that shown in this manual.

# SAFETY INSTRUCTIONS

Please take note of the safety instructions to prevent any potential accident or misuse of the projector.

- Safety precautions are given in two forms, i.e. **WARNING** and **CAUTION** as detailed below.

 **WARNING** Failure to follow the instructions may cause serious injury and even death.

 **CAUTION** Failure to follow the instructions may cause injury to persons or damage to the product.

- Read the owner's manual carefully and keep it on hand.



**WARNING/CAUTION**  
RISK OF ELECTRIC SHOCK  
DO NOT OPEN



The lightning flash with arrowhead symbol, within an equilateral triangle, is intended to alert the user to the presence of uninsulated dangerous voltage within the product's enclosure that may be of sufficient magnitude to constitute a risk of electric shock to persons.



The exclamation point within an equilateral triangle is intended to alert the user to the presence of important operating and maintenance (servicing) instructions in the literature accompanying the device.

## **WARNING/CAUTION**

- TO REDUCE THE RISK OF FIRE AND ELECTRIC SHOCK, DO NOT EXPOSE THIS PRODUCT TO RAIN OR MOISTURE.

**Read these instructions.**  
**Keep these instructions.**  
**Heed all warnings.**  
**Follow all instructions.**

## Indoor Installation

### **WARNING**

- Do not use the projector outside and do not expose the product to any humidity or water.
  - Since the product is not waterproof, this may result in a fire or electric shock.
- Do not place the projector in direct sunlight or near heat sources such as radiators, fires, stoves, etc.
  - This may result in fire.
- Do not place flammable materials such as aerosols near the projector.
  - This may result in fire.

- Do not allow children to cling to or climb up to the projector.
  - This may cause the projector to fall, causing injury or death.
- Do not install the product in a place with no ventilation (e.g., on a bookshelf or in a closet) or on a carpet or cushion.
  - This may result in fire due to the increase in internal temperature.
- Do not place the product close to sources of steam, oil or oil mist, such as humidifiers and kitchen counters.
  - Failure to do so may result in fire, electric shock, or corrosion.
- Do not install the product onto a wall or ceiling that is close to sources of oil or oil mist.
  - The product may be damaged and fall, resulting in serious injury.
- Do not place the projector where it might be exposed to dust.
  - This may result in fire.
- Do not use the projector in a damp place such as a bathroom where it is likely to get wet.
  - This may result in fire or electric shock.
- Do not allow a tablecloth or curtain to block the air vent.
  - This may result in fire due to the increase in the internal temperature.

- Ensure good ventilation around the projector. The distance between the projector and the wall should be at least 30 cm (11.8 inches).
  - This will prevent fire due to the increase in the internal temperature.

#### **CAUTION**

- When placing the projector on a table or shelf, be careful not to put it near the edge.
  - The projector could fall due to balance problems, which may cause personal injury or damage to the product. Make sure to use the projector cabinet or stand that fits the projector.
- When moving the projector, make sure to switch it off and remove the power plug and cords.
  - The power cord may be damaged, resulting in fire or electric shock.
- Do not place the projector on an unstable or vibrating surface such as a wobbly shelf or a slope.
  - It may fall and cause injury.
- Be careful not to tip the projector over when connecting external devices to the projector.
  - This may cause personal injury or damage to the projector.

## Power

### **WARNING**

- **DISCONNECTING THE DEVICE FROM THE MAIN POWER**
  - The Power plug is the disconnecting device. In case of an emergency, the Power Plug must remain readily accessible.
- The grounding wire should be connected. (Except for devices which are not grounded.)
  - Ensure that you connect the grounding cable to avoid electric shock.  
If it is not possible to ground the unit, have a qualified electrician install a separate circuit breaker.  
Do not try to ground the projector by connecting it to telephone wires, lightning rods, or gas pipes.
- The power plug should be inserted fully into the power outlet.
  - An unstable connection may cause a fire.
- Do not place heavy objects on the power cord.
  - This may result in fire or electric shock.
- Never touch the power plug with wet hands.
  - This may result in electric shock.
- Do not plug too many devices into one multi-power outlet.
  - This may result in fire due to the power outlet overheating.
- Keep the AC adapter, power plug, and the used power outlet clean from dust or foreign materials building up.
  - This may result in fire.
- If there is any smoke or a burning smell from the projector or AC adapter, stop using the product immediately. Disconnect the power cord from the power outlet, and then contact the customer service center.
  - This may result in fire.
- To turn off the main power, remove the power plug, which should be positioned so it is easy to access for operation.

 **CAUTION**

- Always grab the plug to remove the AC adapter or power cord.
  - Otherwise, this may result in a fire or may damage the product.
- Refrain from constantly bending the power cord of the AC adapter.
  - If the power cord is bent excessively for a long period of time, the cord may break inside. This may result in a fire or electric shock.
- Ensure the power cord and plug are not damaged, modified, severely bent, twisted, pulled, sandwiched or hot. Do not use the product if the power outlet is loose.
  - This may result in fire or electric shock.
- Keep the power cord away from heating devices.
  - The wire's sheath may melt, which may result in fire or electric shock.
- Place the projector where people will not trip over or step on the power cord to protect the power cord and plug from any damage.
  - This may result in fire or electric shock.
- Do not turn the projector on or off by plugging in the power plug or unplugging it from the power outlet.  
(Do not use the power plug as a switch.)
  - This may result in electric shock or damage to the product.
- Do not insert a conductor into the other side of the wall outlet while the power plug is inserted into the wall outlet.  
In addition, do not touch the power plug immediately after it is disconnected from the wall outlet.
  - This may result in electric shock.
- Only use the official power cord provided by LG Electronics. Do not use other power cords.
  - This may result in fire or electric shock.
- If any water or foreign materials have gone into the AC adapter, power cord, or the interior of the projector, turn off the projector by pressing the power button. Remove all the cables, and then contact the customer service center.
  - This may result in fire or electric shock.
- The surface of the AC adapter is hot. Keep the AC adapter out of the reach of children and avoid touching it during use.

- Never disassemble the power supply devices (AC adapter/ power cord, etc.).
  - This may damage the power cord and result in a fire or electric shock.
- Connect the AC adapter and the power cord firmly.
  - Not doing so may result in a product failure or fire.
- Do not place heavy objects or put pressure on the power cord and AC adapter and avoid damage.
  - This may result in a fire or may damage the product.
- Always use the AC adapter provided or any AC adapters approved and certified by LG Electronics.
  - Any other AC adapter connected may result in the screen flickering.

## When in Use

### **WARNING**

- Do not place anything containing liquid on top of the projector such as a vase, flower pot, cup, cosmetics, medicine, or ornaments, candles, etc.
  - This may result in fire or electric shock, or cause injury due to falling.
- In the event that there is a heavy impact or the cabinet is damaged, switch it off, unplug it from the power outlet and contact an authorized service center.
  - This may result in electric shock.
- Do not insert pieces of metal such as coins, hairpins, or metal debris, nor flammable materials such as paper or matches into the projector.
  - This is to prevent electric shock or fire.
- Make sure that a child does not swallow the batteries when you replace the old remote control batteries with new ones. Keep batteries out of reach of children.
  - If a child swallows a battery, consult a doctor immediately.
- Never open any cover on the projector.
  - There is a high risk of electric shock.

- Do not look directly into the lens when the projector is in use.
  - The bright light may damage your eyes.
- When the lamp is on or has just been turned off, avoid touching the air vent or lamp, because these will be very hot.
- If there is a gas leak in the room with the projector, do not touch the projector or power outlet. Open the windows for ventilation.
  - Sparks may cause fire or burns.
- Unplug the power cord from the outlet during a lightning storm.
  - This will prevent shock or damage to the projector.
- Do not use the projector near electronic devices that generate a strong magnetic field.
- Keep the plastic film used for packaging the projector out of the reach of children.
  - If not handled safely, it can cause suffocation.
- Do not keep your hand on the projector for a long time when it is running.
- When you play a game by connecting a game console to a projector, it is recommended that you maintain a distance of more than four times the diagonal length of the screen.
  - Make sure that the connecting cable is long enough. Otherwise, the product may fall causing personal injury or damage to the product.

- Do not place the projector or its remote control with battery in an extremely high temperature environment.
  - This may result in fire.
- Do not use 3D glasses if you do not watch 3D.

 **CAUTION**

- Do not place heavy objects on the projector.
  - It may fall down and cause personal injury.
- Be careful not to allow any impact to the lens during transport.
- Do not touch the lens of the projector.
  - The lens may be damaged.
- Do not use any sharp tools on the projector such as a knife or hammer, because this may damage the casing.
- In the event that no image appears on the screen or no sound is heard, stop using the projector. Switch off the projector, unplug it from the power outlet, and contact our service center.
  - This may result in fire or electric shock.
- Do not drop anything onto the projector or allow anything to bang into the projector.
  - This may cause damage to the projector or personal injury.



- It is recommended that you maintain a distance of more than 5 to 7 times the diagonal length of the screen.
  - If you watch the screen at a close distance for a long time, your eye sight may become worse.
- Do not block the light beam emitted from the projector using a book or other object.
  - Lengthy exposure to the projector beam may result in fire. In addition, the lens may be overheated and damaged by the reflected heat.
- Do not start the projector with the volume turned up high.
  - High volume may damage hearing.
- Do not use high voltage electrical equipment near the projector, (e.g., a bug zapper). This may result in product malfunction.
- Do not carelessly throw away old batteries.
  - It can cause an explosion or fire. The disposal method may vary by country and region. Dispose of it in an appropriate manner.
- Risk of fire or explosion if the battery is replaced by an incorrect type.

## Cleaning

### WARNING

- Do not spray the projector with water when cleaning. Make sure water does not flow into the projector.
  - This may result in fire or electric shock.
- When there is smoke or a strange smell coming out from the projector or a foreign object falls into the projector, switch it off and unplug it from the power outlet and contact our service center.
  - Otherwise, this may result in fire or electric shock.
- Use air spray, a soft cloth, or a cotton swab moistened with a lens cleaning chemical or alcohol to remove dust or stains on the front projection lens.

**⚠ CAUTION**

- Contact your seller or our service center once a year to clean the internal parts of the projector.
  - If you do not clean the projector for a long period of time, dust will accumulate, which may result in fire or damage to the projector.
- When cleaning plastic parts such as the projector case, unplug the power first and wipe with a soft cloth. Do not spray with water or wipe with a wet cloth. Never use glass cleaner, automobile or industrial polish, abrasives, wax, benzene, or alcohol as these can damage the projector.
  - This can result in fire, electric shock, or cause damage to the product (deformation and corrosion).
- Remove the plug from the outlet before cleaning the product.
  - Otherwise, this may result in electric shock.

**Others****⚠ WARNING**

- Some users may experience a seizure or other abnormal symptoms when they are exposed to a flashing light or particular patterns from a video game.
- When you go out, place the projector out of reach of animals, and remove the power plug from the wall outlet.
  - Using a damaged power cord may result in short circuit or fire.
- Do not use the projector near high-precision electronic devices or those that transmit weak radio signal.
  - This may affect the operation of the product, causing an accident.
- Only a qualified technician can disassemble or modify the projector. For diagnosis, adjustment, or repair, contact your seller or our service center.
  - This may result in fire or electric shock.
- Proper ventilation required, do not block airflow around unit. Doing so can cause injury and internal overheating.

- Do not touch the lens; doing so can result in burns or damage to lens. Lens and unit may be HOT during and immediately after use. Use caution when handling unit, allowing for proper cool down.
- Only use a grounded electrical outlet. (Except for devices which are not grounded.)
- Do not insert anything into or cover up the exhaust vents.
  - This may result in fire or electric shock.
- Follow all maintenance guidelines for optimal use; service only at an authorized service center.
- Keep the batteries and remote out of reach of children.
  - This will prevent personal injury or damage to the product.

 **CAUTION**

- Do not use or store the projector outdoors for long periods of time.
- Do not mix new batteries with old ones.
  - Burst or leaking batteries may result in damage or injury.
- Be sure to unplug if the projector is not to be used for a long period.
  - Accumulated dust may result in fire or electric shock due to overheating, ignition, or poor insulation.
- Only use the specified type of battery.
  - Burst or leaking batteries may result in damage or injury.
- Make sure you use the same type of battery when replacing.
  - In the case of a battery contact failure, the battery may drain quickly or the remote control may not work properly.
- Dispose of used batteries properly.
  - This may result in explosion or fire. The correct method of disposal may vary depending on your country or region. Dispose of the battery pack as instructed.

- Do not throw or disassemble the battery.
  - This may result in fire or explosion due to damage to the battery.
- Store batteries away from metallic objects, such as keys and paper clips.
  - Excess current may cause a rapid increase in temperature, resulting in fire or burns.
- Do not store the batteries near any heat source, such as a heater.
  - This may result in fire or damage to the product.
- Do not store batteries at temperatures higher than 60 °C (140 °F) or in high humidity.
  - This may result in explosion or fire.
- Make sure that the battery is installed correctly.
  - This prevent explosion or fire.
- Incorrect battery replacement may cause fire.
- Batteries: Store the accessories (battery, etc.) in a safe location out of the reach of children.

### Risk Group 2

**CAUTION** Possibly hazardous optical radiation emitted from this product. Do not stare at operating lamp. May be harmful to the eye.

## ANTENNA

### Outdoor Antenna Grounding

- If an outdoor antenna is installed, follow the precautions below. An outdoor antenna system should not be located in the vicinity of overhead power lines or other electric light or power circuits, or where it can come in contact with such power lines or circuits as death or serious injury can occur. Be sure the antenna system is grounded to provide some protection against voltage surges and built-up static charges. Section 810 of the National Electrical Code (NEC) in the U.S.A. provides information with respect to proper grounding of the mast and supporting structure, grounding of the lead-in wire to an antenna discharge unit, size of grounding conductors, location of antenna discharge unit, connection to grounding electrodes and requirements for the grounding electrode.

## Antenna grounding according to the National Electrical Code, ANSI/NFPA 70

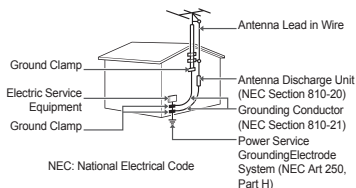

## For USA

### NOTE TO CABLE/TV

### INSTALLER

This reminder is provided to call the CATV system installer's attention to Article 820 - 40 of the National Electrical Code (U.S.A.). The code provides guidelines for proper grounding and, in particular, specifies that the cable ground shall be connected to the grounding system of the building, as close to the point of the cable entry as practical.

# CONTENTS

<b>LICENSE</b>	<b>2</b>
<b>SAFETY INSTRUCTIONS</b>	<b>3</b>
<b>PREPARATION</b>	<b>15</b>
<b>REMOTE CONTROL</b>	<b>28</b>
<b>USING THE PROJECTOR</b>	<b>31</b>
<b>ENTERTAINMENT</b>	<b>48</b>
<b>MY MEDIA</b>	<b>54</b>
<b>3D FUNCTION</b>	<b>77</b>
<b>CUSTOMIZING SETTINGS</b>	<b>84</b>
<b>CONNECTING DEVICES</b>	<b>108</b>
<b>MAINTENANCE</b>	<b>116</b>
<b>TROUBLESHOOTING</b>	<b>117</b>
<b>SPECIFICATIONS</b>	<b>119</b>
<b>SYMBOLS</b>	<b>124</b>

# PREPARATION

## Accessories

Accessories included with the projector are show below.

The pictures may differ slightly from the actual product.

Accessories are subject to change without prior notice.

New accessories may be added or old ones removed.

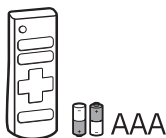

Remote Control  
Two AAA Batteries



Owner's Manual



Pouch



AC-DC Adaptor

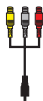

Composite Gender



Power Cord

- When connecting an HDMI or USB cable, or connecting a USB flash drive to the HDMI or USB port, use a product that has a width of 18 mm (0.7 inches) or less and a height of 10 mm (0.3 inches) or less. If the USB cable or USB flash drive does not fit the USB ports of the projector, use an extension cable that supports USB 2.0.
- Use a certified cable with the HDMI logo attached.
- If you do not use a certified HDMI cable, the screen may not display or a connection error may occur. (Recommended HDMI cable types)
  - High-Speed HDMI<sup>®</sup>/™ Cable
  - High-Speed HDMI<sup>®</sup>/™ Cable with Ethernet

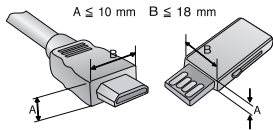



## Optional Extras

To purchase optional accessories, visit an electronics store or online shopping site or contact the retail store where you purchased the product. Optional accessories are subject to change without prior notice.



Projection Screen



Tripod



HDMI Cable



Video Cable



Audio Cable



3D glasses  
(DLP-LINK or DLP-Ready Type)



RGB to Component  
cable



Component Cable



MHL or Slimport cable



Computer Cable



RF Cable

## Parts and Components

The projector is manufactured using high-precision technology. You may, however, see tiny black dots and/or bright colored dots (red, blue, or green) that continuously appear on the projector screen. This is a normal result of the manufacturing process and does not indicate a malfunction.

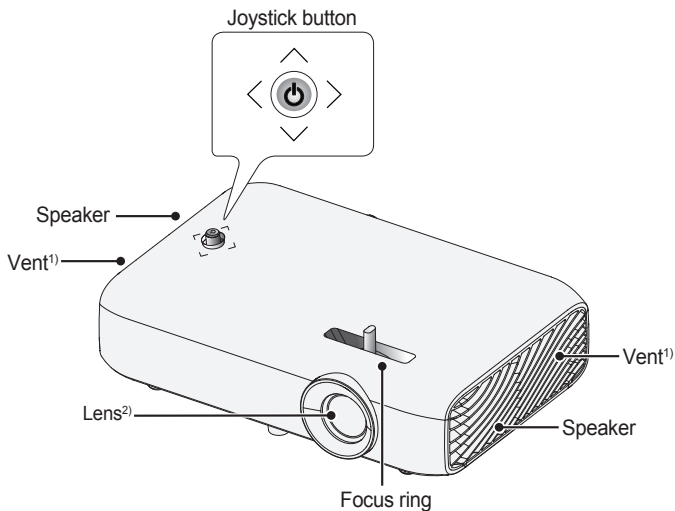

- 1) Due to the high temperature of the vent area, do not get close to the vent area.
- 2) Do not touch the lens when using the projector. The lens may be damaged.

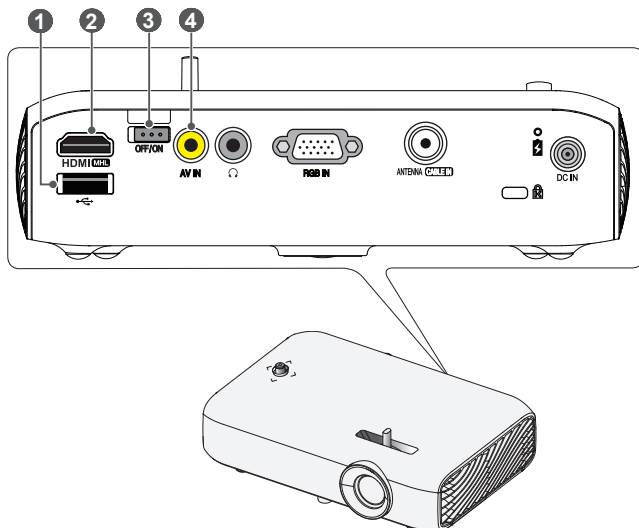

1  (USB Port)

2 **HDMI MHL** Port

3 **OFF/ON** Switch

- **OFF**: Turns the projector off completely.
- **ON**: Turns the projector on and the projector goes into Standby mode.

Place the switch to **OFF** when you move the projector or when you intend not to use the projector for long periods of time.

4 **AV IN** Port

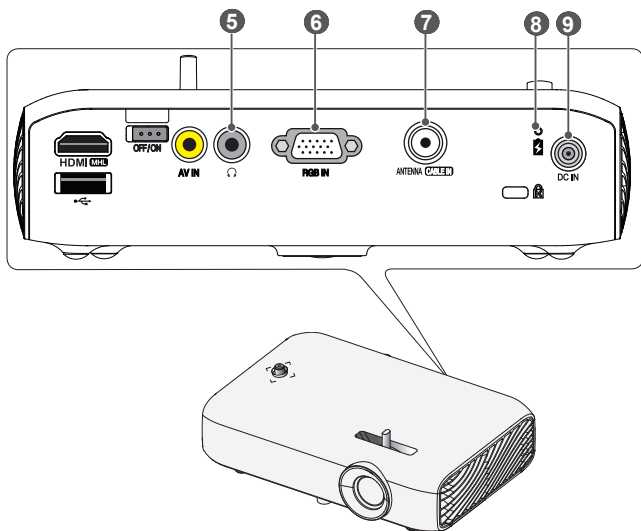





- 5** 🎧 (Headphone Port)
- 6** RGB IN Port
- 7** ANTENNA **CABLE IN** Port
- 8** Battery Charge Indicator
  - Red: Charging
  - Green: Charging complete
- 9** DC IN Port

## Using the Joystick Button

You can operate the projector by pressing the button or moving the joystick left, right, up, or down.

### Basic Functions

	<b>Power On</b>	When the projector is turned off, place your finger on the joystick button, press it once, and release it.
	<b>Power Off</b>	When the projector is turned on, place your finger on the joystick button, press it once for a few seconds, and release it. (However, if the Menu button is on the screen, pressing and holding the joystick button will let you exit the Menu.)
	<b>Volume Control</b>	If you place your finger over the joystick button and move it left or right, you can adjust the volume level.
	<b>Channels Control</b>	If you place your finger over the joystick button and move it up or down, you can scroll through the saved channels.







#### NOTE

- When your finger is on the joystick button and you move it up, down, left, or right, be careful not to press the joystick button. If you press the joystick button first, you may not be able to adjust the volume level and/or scroll through saved channels.

## Adjusting the Menu

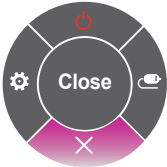
When the projector is turned on, press the joystick button one time.

You can adjust the menu items (⏻, 📺, ✕, ⚙️) moving the joystick button left, right, up, or down. Move to the desired menu item, and then press the joystick button once to select it.

		<b>Projector off</b>	Turns the power off.
		<b>Input List</b>	Changes the input source.
		<b>Close</b>	Clears on-screen displays and returns to projector viewing.
		<b>Settings</b>	Displays the Settings menu.

## Projector Status Indicators

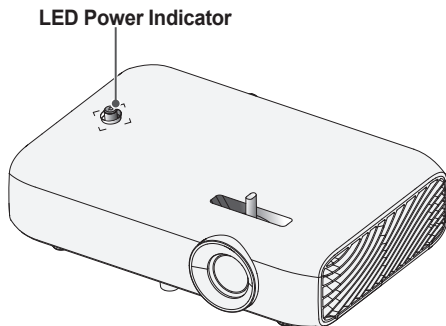

LED Power Indicator	
<b>Red</b>	Power standby state
<b>Off</b>	The projector is operating with the power on.

## Installation

### Installation Precautions

- Place the projector in a well-ventilated environment.
  - To prevent internal heat build-up, install the projector in a well-ventilated place. Do not place anything near the projector as this may block its air vents. If the air vents are blocked, the internal temperature will increase.

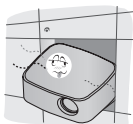

- Do not place the projector on a carpet or rug. If the vent is on the bottom, use the projector on a solid level surface and ensure the vent is not blocked.



- Be sure to prevent foreign objects such as paper debris from entering the projector.



- Leave enough distance (30 cm (11.8 inches) or more) around the projector.



- Do not place the projector in a hot or humid environment.
  - Do not place the projector in a hot, cold, or humid environment.
- Do not place the projector in a place where it will easily attract dust.
  - This may result in fire.
- Never open any cover on the projector. There is a high risk of electric shock.
- The projector is manufactured using high-precision technology. You may, however, see tiny black dots and/or bright colored dots (red, blue, or green) that continuously appear on the projector screen. This is a normal result of the manufacturing process and does not indicate a malfunction.
- The remote control may not work in an environment where a lamp equipped with electronic ballasts or a three-wavelength fluorescent lamp is installed. Replace the lamp with an international standard lamp for the remote control to work normally.

## Projection Distance per Screen Size

- 1 Place the projector on a sturdy, level surface, together with the PC or audio/video source.
- 2 Place the projector an appropriate distance away from the screen. The distance between the projector and the screen determines the actual size of the image.
- 3 Position the projector so that the lens is at a right angle to the screen. If the projector is not at a right angle, the projected image will look distorted. To correct the distortion, use the keystone function. (See page 43.)
- 4 Connect the power cord of the projector and the connected device to the wall outlet.

**Ratio of upward projection: 100 %**

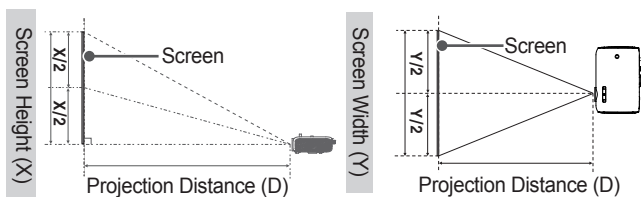



16:9 Ratio							
Screen Size		Screen Width (Y)		Screen Height (X)		Projection Distance (D)	
mm	inches	mm	inches	mm	inches	mm	inches
635	25	553	21.7	311	12.2	769	30.2
762	30	664	26.1	374	14.7	923	36.3
889	35	775	30.5	436	17.1	1077	42.4
1016	40	886	34.8	498	19.6	1236	48.6
1143	45	996	39.2	560	22	1385	54.5
1270	50	1107	43.5	623	24.5	1539	60.5
1397	55	1218	47.9	685	26.9	1692	66.6
1524	60	1328	52.2	747	29.4	1846	72.6
1651	65	1439	56.6	809	31.8	2000	78.7
1778	70	1550	61	872	34.3	2154	84.8
1905	75	1660	65.3	934	36.7	2308	90.8
2032	80	1771	69.7	996	39.2	2462	96.9
2159	85	1882	74	1058	41.6	2616	102.9
2286	90	1992	78.4	1121	44.1	2769	109
2413	95	2103	82.7	1183	46.5	2923	115
2540	100	2214	87.1	1245	49	3077	121.1

## How to Install the Projector On a Tripod

- You can install this projector using a camera tripod.  
As shown below, you can mount the projector instead of a camera on the tripod.
- When stabilizing the tripod, we recommend using a locking bolt of standard size 4.5 mm (0.1 inch) or less. The maximum size allowed for the locking bolt is 5.5 mm (0.2 inches).  
(If it is longer than the maximum allowed size, it may damage the projector.)

Bottom side of the projector

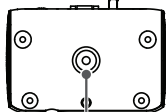

The projector is connected to this part.

+



**Tripod**

Bolt used to attach the projector

⇒

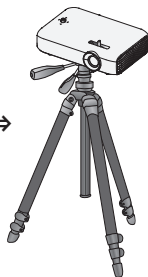

### **CAUTION**

- If you are using a tripod, be careful not to apply external force to the tripod. Doing so may damage the projector.
- Do not place the tripod on an unstable surface.
- Be sure to use a tripod with a maximum load capacity of 3 kg (6.6 lbs) or more.
- To use the projector safely, position the tripod legs so that they are as wide and stable as possible and be sure to securely attach the projector to the tripod.

## **Kensington Security System**

- This projector has a Kensington Security Standard connector. Connect a Kensington Security System cable as shown below.
- For more information on installation and use of the Kensington Security System, refer to the user's guide provided with the Kensington Security System.
- The Kensington Security System is an optional accessory.
- What is Kensington? Kensington is a company that provides security systems for laptops and other electronic devices.  
Website: <http://www.kensington.com>

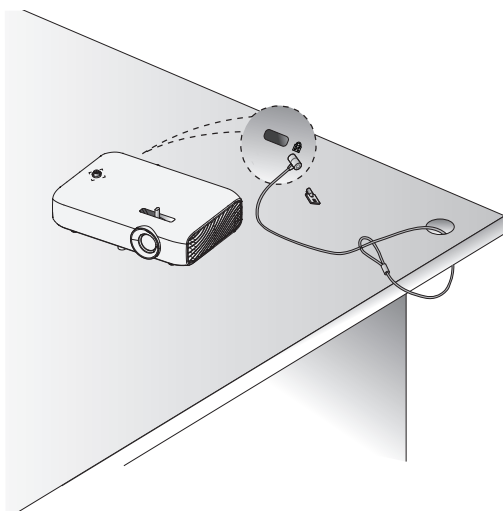

# REMOTE CONTROL

Open the lid at the back of the remote control and insert the batteries as described in the  $\oplus$   $\ominus$  instructions.

Use new batteries and do not mix regular or rechargeable batteries. (1.5 V AAA)

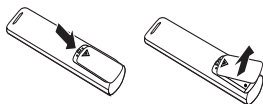

## CAUTION

- Do not mix new batteries with old ones.

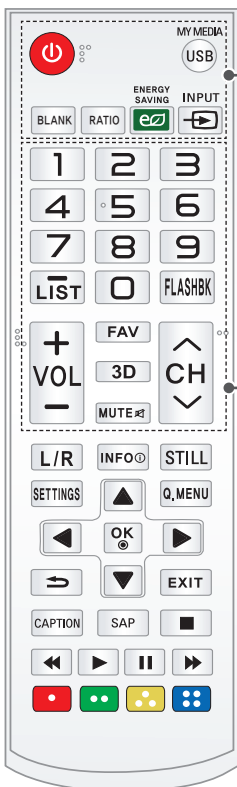

### (POWER)

Turns the projector on or off.

### USB/MY MEDIA

Accesses USB mode.

### BLANK

Blanks the screen.

### RATIO

Changes the aspect ratio of the screen per pressing of the button.

### ENERGY SAVING

Reduces power consumption by adjusting peak screen brightness.

### INPUT

Changes the input source.

### Number buttons

Enters a number.

### - (dash)

Enters a channel number, such as 2-1 or 2-2.

### LIST

Displays the channel list.

### FLASHBK

Displays the channel you were watching previously.

### VOL +, -

Adjusts the volume level.

### FAV

Shows favorite channels.

### 3D

Shows 3D images.

### MUTE

Mutes the sound of the projector.

### CH ,

Changes the TV channel.

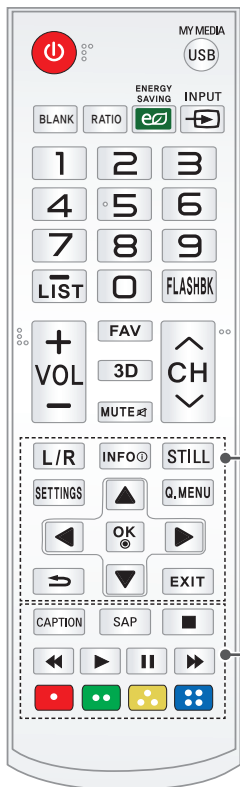
**L/R**

Switches left and right in 3D mode.

**INFO ⓘ**

Displays the information of a program or screen.

**STILL**

Freezes the moving image.

(Available in any mode other than USB mode.)

**SETTINGS**

Displays or closes the Settings menu.

**Q.MENU**

Allows you to change the settings easily.

**Up/Down/Left/Right buttons**

Sets the function or moves the cursor.

**OK Ⓞ**

Shows the current mode and saves changes to the settings.



Returns to the previous screen.

**EXIT**

Exits the menu.

**CAPTION**

Activates or deactivates the subtitles.

**SAP**

Digital signal: Changes the audio language.

Analog signal: Changes the MTS sound.

**Playback control buttons**

Controls playback of **MY MEDIA**.

**Color buttons**

Sets detailed settings or gesture for each menu.

**NOTE**

- When using the remote control, the optimal operation range is 6 meters (19.6 feet) or less (left/right) and within a 30 degree arc of the remote control IR receiver.
- If a cable is connected to the back port, the optimal operating range is 3 meters (9.8 feet) or less (left/right) and within a 30 degree arc of the remote control IR receiver.
- For seamless operation, do not block the IR receiver.
- When you carry the remote control in the portable bag, make sure that the buttons on the remote control are not pressed by the projector, cables, documents or any other accessories in the bag. Otherwise, it may significantly reduce the battery life.

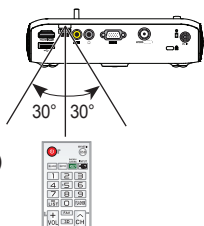

# USING THE PROJECTOR

## Connecting to an Antenna or Cable

To watch TV using an indoor/outdoor antenna, connect a wall terminal and the **ANTENNA CABLE IN** port of the Projector using an RF cable (75  $\Omega$ ).

You can watch terrestrial or cable (analog or digital) TV.

(The RF cable is sold separately.)

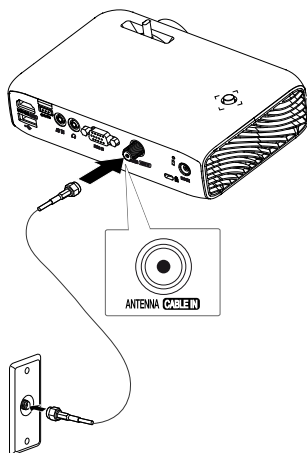

### ! NOTE

- Make sure not to bend the copper wire of the RF cable (75  $\Omega$ ). Turn the input jack to the right to fasten it.

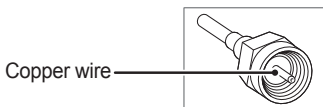

- Ensure you use a standard coaxial cable (75  $\Omega$ , sold separately) when connecting to the projector input.
- For better image quality in locations where signal strength is low, purchase and install a signal amplifier (booster).
- A signal splitter is required if you want to use two or more projectors through one antenna.
- If you have any problems when installing the antenna, please consult a suitable retailer or the store where you purchased the antenna.

## Using The Battery

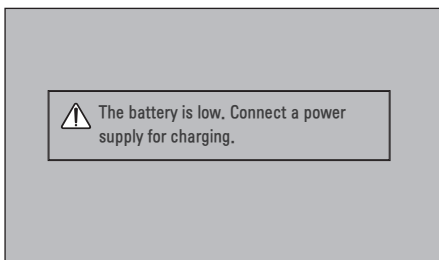

- It is displayed when the battery is low (Energy Saving will be changed Maximum mode and will be disabled).
- If the screen shows a low battery message, be sure to charge the battery.

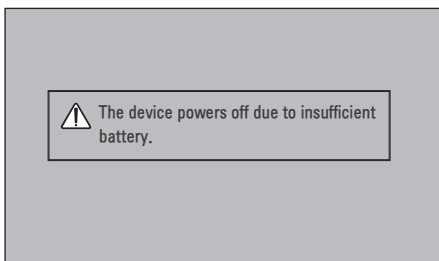

- It is displayed when the battery is running out.
- As your battery is running out, the projector will turn off immediately.



## Battery using time information

<b>Status</b>	Time and Display
<b>Charging</b>	About 3 hours
<b>Usage Hours</b>	Up to 2.5 hours (Available battery using time up to 2.5 hours when Energy Saving mode set to Max.)
<b>Battery Level Indicator</b>	

- If you do not intend to use the projector for a long time, leave the battery charged at 40 % to 50 %.
- The battery is automatically recharged when the projector is connected to a power supply.
- Charge the battery fully when you first use the projector.
- The battery standard usage time given in the manual is based on measurements taken by LG; the actual time may vary depending upon usage.
- Battery usage time may vary depending on broadcast type, operating temperature, period of use, and user preferences.
- As the battery is consumable, its lifetime gradually decreases. When the battery's life is reduced by half, replace it with a new battery from an LG Electronics Customer Support Center.
- Do not charge the battery using any equipment other than that supplied with the product. This may damage the battery or cause a fire.
- Always use a battery that is approved and certified by LG Electronics, Inc. Failure to do so may result in an explosion or fire.
- If the battery is leaking or giving off an odor, discontinue its use immediately and contact LG Electronics Customer Support Center.
- The battery contains lithium-ion, so please handle with care. Failure to do so may result in an explosion or fire.

- Do not store or transport at pressures lower than 11.6 kPa (1.68 psi) and at above 15 000 m (49212.5 feet) altitude.
- Replacement of a battery with an incorrect type that can defeat a safeguard (for example, in the case of some lithium battery types).
- Disposal of a battery into fire or a hot oven, or mechanically crushing or cutting of a battery, that can result in an explosion.
- Leaving a battery in an extremely high temperature surrounding environment that can result in an explosion or the leakage of flammable liquid or gas.
- A battery subjected to extremely low air pressure that may result in an explosion or the leakage of flammable liquid or gas.

# Watching Projector

## Turning on the Projector

The menu screen display in this owner's manual is an example to help users understand how to operate the product and may look different from the actual screen.

- 1 Connect the power cord correctly.
- 2 Place the **OFF/ON** switch on the rear port area to **ON** and press the **POWER** button on the joystick button or on the remote control. (If the switch is placed to **OFF**, the projector will not turn on.)
- 3 In the Language Selection screen, select a language.

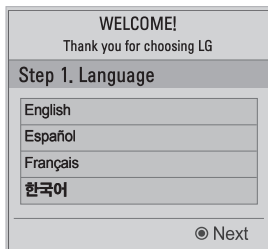

- 4 In the **Mode Setting** screen, select the setting mode you want.

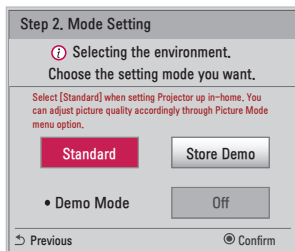

\* **Store Demo** is used when displaying the product in-store. The picture mode is automatically reset after a certain period of time. You can select **Standard** to use the product at home.

- 5 In the **Time Zone** screen, select **Time Zone** region and **Daylight Saving** option.

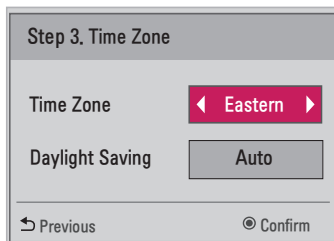

- 6 Select an input signal by using the **INPUT** button on the remote control.

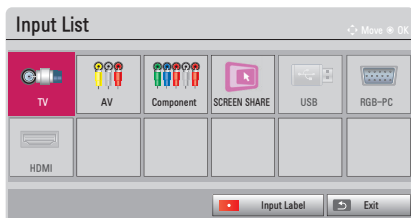

## Focus of the Screen Image

When an image appears on the screen, check if it is in focus and fits the screen properly.

Adjust the focus of the image by rotating the Focus Ring to the left or right.

Make sure the product does not move when adjusting the focus.

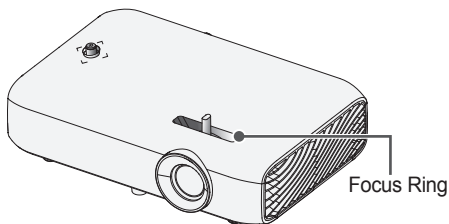

## Watching Projector

- 1** In standby mode, press the **POWER** button to turn the projector on.
- 2** Press the **INPUT** button and select the input signal you want.
- 3** Control the projector using the following buttons while watching projector.

Button	Description
CH ^ , v	Changes the TV channel.
LIST	Displays the channel list.
Number buttons	Enters a number.
VOL +, -	Adjusts the volume level.
MUTE 	Mutes all sounds.
Q.MENU	Accesses the quick menu. (See page 47.)
FLASHBK	Displays the channel you were watching previously.

- 4** To turn the projector off, press the **POWER** button.

## To Set Channel

Image shown may differ from your projector.

### Memorizing the Available Channels

#### Using the Auto Tuning function

Saves a channel which is currently broadcasting. Be sure to activate Auto Tuning when you move to a new home or change the position of your projector. When you activate this function, make sure that the antenna is connected and there are channels broadcasting signals.

- 1** Press the **SETTINGS** button.
- 2** Press the **^**, **v**, **<** or **>** button to select **CHANNEL** and press the **OK** button.
- 3** Press the **^** or **v** button to select **Auto Tuning** and press the **OK** button.
- 4** Select **Start** to start automatic tuning. The projector scans and saves available channels automatically.
- 5** When you are finished, press the **EXIT** button.

## Memorizing or Deleting Channels Manually

- 1 Press the **SETTINGS** button.
- 2 Press the **^**, **v**, **<** or **>** button to select **CHANNEL** and press the **OK** button.
- 3 Press the **^** or **v** button to select **Manual Tuning** and press the **OK** button.
- 4 Scroll through the channel types, and then add or delete channels.
- 5 When you are finished, press the **EXIT** button.



### NOTE

- If **Lock System** is turned on, a pop-up window will appear asking for password.
- You can store up to 1000 Channels. The number of channels that you can store differs depending on the broadcasting signal environment.
- **Auto Tuning** memorizes the Channels that are currently being broadcast.
- The channels are stored in the order of DTV, TV, Cable DTV, and Cable TV.

## Editing Your Channel List

- 1 Press the **SETTINGS** button.
- 2 Press the **^**, **v**, **<** or **>** button to select **CHANNEL** and press the **OK** button.
- 3 Press the **^** or **v** button to select **Channel Edit** and press the **OK** button.
- 4 Edit channels using the following buttons.

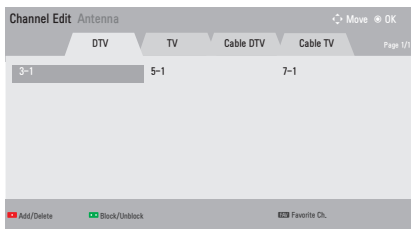

Button	Description
Red	Adds or deletes a channel.
Green	Block or unblock a channel.
FAV	Adds a favorite channel.

- 5 When you are finished, press the **EXIT** button.



**Favorite Channel Setup**

- 1 Press the **SETTINGS** button.
- 2 Press the **^**, **v**, **<** or **>** button to select **CHANNEL** and press the **OK** button.
- 3 Press the **^** or **v** button to select **Channel Edit** and press the **OK** button.
- 4 Move to your desired channel.
- 5 Press the **FAV** button to access the **Set as Favorite**.
- 6 Press the **^** or **v** buttons to scrolls through channel group.
- 7 Press the **OK** button.

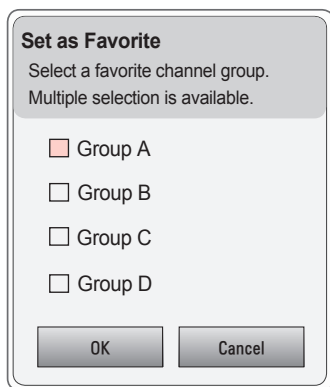

## Additional Options

### Adjusting Aspect Ratio

- Resize an image to view at its optimal size by pressing **RATIO** while you are using the projector.

#### **NOTE**

- Available picture size may differ depending on the input signal.
- You can also use the **Q.MENU** or **SETTINGS** button.

Menu	Description
<b>16:9</b>	Resizes images to the 16:9 ratio.
<b>Just Scan</b>	Displays video images in the original size without removing parts of the edge of the image. <ul style="list-style-type: none"> <li>• If you select <b>Just Scan</b>, you may see image noises at the edge or edges of the screen.</li> </ul>
<b>Set By Program</b>	Displays images in the same aspect ratio as the original image.
<b>4:3</b>	Resizes images to the previous standard 4:3.
<b>Zoom</b>	Resizes the image to fit the screen width. The top and bottom parts of the image may be cut off. Press the < or > button to zoom in or out of the image. Press the ^ or v button to move the image.
<b>Cinema Zoom 1</b>	Formats an image to the cinemascope ratio, 2.35:1. It ranges from 1 to 16. Press the < or > button to zoom in or out of the image. Press the ^ or v button to move the image. <ul style="list-style-type: none"> <li>• If you enlarge or reduce an image, the image may be distorted.</li> </ul>

## Using the Keystone Function

To prevent the screen image from becoming trapezoidal, **Keystone** adjusts the top and bottom width of the image if the projector is not set up at a right angle to the screen.

Because the **Keystone** function may cause inferior screen image quality, use this function only when it is not possible to set up the projector at an optimal angle.

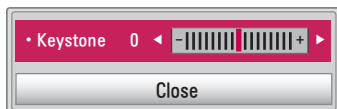

- 1 Select **SETTINGS** → **OPTION 2** → **Keystone** to adjust the picture.
  - **Keystone** can be adjusted from **-40** to **40**.
- 2 Press the **OK** button when done.

## Changing Input Device

### To select an external input

Selects external input.

- Press the **INPUT** button on the remote control to display the input selection screen.
  - Connected inputs are displayed first. However, **TV / AV / Component / SCREEN SHARE** input is always activated.
- Select an input signal using the remote control's **INPUT** button to connect the projector to the desired input. You can use the **^**, **v**, **<** or **>** button to switch between all the input modes.

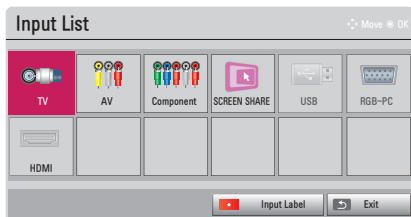

## Selecting an Input Label

Displays which devices are connected to which input ports.

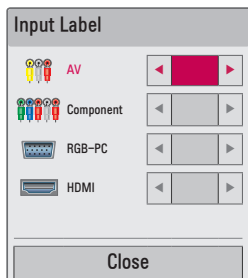

- 1 Press the **INPUT** button on the remote control to display the input selection screen.
- 2 Press the **red** button.
- 3 Use the  $\wedge$  or  $\vee$  button to scroll to one of the input sources.
- 4 Use the  $\langle$  or  $\rangle$  button to select one of the input labels.

## Blank Function

### Using the Blank Function

This function may be effective when you need to draw attention during a meeting or training.

- 1** Press the **BLANK** button, and the screen is covered by the background color. You can change the background color by referring to *Selecting a Blank Image*.
- 2** Press any button to clear the blank function. To cover the screen temporarily, press the **BLANK** button on the remote control. Do not block the lens with any object while the projector is running. It may become overheated and deformed or even cause a fire.

### Selecting a Blank Image

- 1** Press the **SETTINGS** button.
- 2** Press the  $\wedge$ ,  $\vee$ ,  $\lt$  or  $\gt$  button to select **OPTION 2** and press the **OK** button.
- 3** Press the  $\wedge$  or  $\vee$  button to select **Blank Image** and press the **OK** button.
- 4** Use the  $\wedge$  or  $\vee$  button to move to the setting or option you want and press the **OK** button.

## Using the Quick Menu

You can customize frequently used menus.

- 1 Press the **Q.MENU** button.
- 2 Press the **<** or **>** button to select a menu and press **OK**.

Menu	Description
<b>Aspect Ratio</b>	Resizes the picture.
<b>Caption</b>	View subtitles when the TV station provides subtitled programming. Program subtitles work only on digital/analog broadcasts.
<b>Picture Mode</b>	Changes the picture mode.
<b>Multi Audio</b>	Sets <b>MONO</b> or <b>STEREO</b> , or a language for a bilingual broadcast (Digital signal).
<b>SAP</b>	Changes the MTS sound (Analog signal).
<b>Sleep Timer</b>	Sets the projector to be turned off at the specified time.
<b>Clear Voice II</b>	Makes the voice from the projector crisp and clear.
<b>Del/Add</b>	Can delete or add channels.
<b>USB Device</b>	Allows you to remove a connected USB device in a safe manner. (The menu is displayed only when the USB device is connected.)

- 3 Press the **^** or **v** button to scroll through the following menus.

# ENTERTAINMENT

## Using SCREEN SHARE

- 1** Set the external input of the projector to **SCREEN SHARE**.
- 2** Enable related SCREEN SHARE function on the device you wish to connect.
- 3** Connect the Projector from the search list on the device you wish to connect. (When you connect the projector to your laptop, input the PIN code shown on your display. The request for a PIN will be shown only at the initial connection.)
- 4** If the desired device accepts the request, SCREEN SHARE will be started.



### CAUTION

- Windows 7 / 8 / 8.1 are compatible with SCREEN SHARE. However, other versions of Windows, and some other operating systems, may not be compatible with SCREEN SHARE.
- Ice Cream Sandwich, Jellybean, Kitkat, and Lollypop versions of LG's Android devices are guaranteed to be compatible.
- When connecting via SCREEN SHARE, place the device close to the projector.
- The response rate and image quality may vary depending upon the user's environment.
- For more information on the device you want to connect to, refer to its owner's manual.
- Certain Windows 8.1 laptops may have difficulty in reconnecting when initializing the device information during a wireless connection. In this case, it is recommended that you remove the registered device and reconnect.



## Setting Up Bluetooth on the Projector

This option is used to output sound from the projector through Bluetooth audio devices.

- Press the **SETTINGS** button on the remote control, and then set **Bluetooth** to **On** in the **WIRELESS** menu.

### ! NOTE

- The devices that can be connected are as follows: LG BTS1, LG HBS-700, LG HBS-730, LG HBS-800 (Models available for purchase may vary by region.)
- Products from other manufacturers may not be compatible.
- You can use the remote control to adjust the volume of the connected device.
- When connecting devices wirelessly, if the device connection fails, check that the device is connected to a power supply and also check that the Bluetooth audio device is operating properly.
- If **Bluetooth** is turned on, the projector will automatically connect to the last connected Bluetooth device when the projector powers on. (Be sure to check that the last connected Bluetooth device is powered on as well.)
- This projector does not support the LG TV Sound Sync feature. To use products that support the LG TV Sound Sync feature, use the general Bluetooth mode instead of the LG TV mode.
- The Bluetooth function is to connect the product to Bluetooth speakers or Bluetooth headset. You cannot connect the product to a mobile phone through the Bluetooth function.

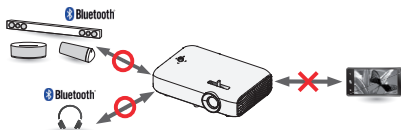

## Searching for Bluetooth Devices and Connecting

Go to **SETTINGS** → **WIRELESS** → **Search Device** to search for nearby Bluetooth audio devices and then connect any detected devices to the projector.

(If the device name is longer than 20 characters, no more than 20 will be displayed.)

- 1 Set the Bluetooth device to pairing mode and then select **Search Device**.
  - Select **Stop searching** to view the devices detected so far.
  - If the device has not been detected, check that the device is powered on and in pairing mode.
  - The time it takes to search for devices may vary according to the signal strength and the number of devices.



- 2 When the search is complete, you can select a Bluetooth device and connect to it.
- You can stop the connection process immediately by selecting **Stop searching**.
  - The time it takes to connect to a device may vary according to the signal strength and the number of devices.

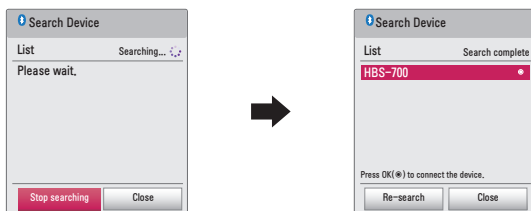

- 3 When a Bluetooth device is connected, you will hear sound from the projector through the connected device.
- The connected Bluetooth device will be added automatically to the **List of registered devices**. Once registered, Bluetooth devices can be connected simply by selecting them from the **List of registered devices** without having to search for them.
  - Connected devices can only be disconnected from **SETTINGS** → **WIRELESS** → **List of registered devices**.

## Connecting, Disconnecting, or Deleting Bluetooth Devices in the List of registered devices

In **SETTINGS** → **WIRELESS** → **List of registered devices**, Bluetooth devices are shown in the order that they were connected, and the same devices can be reconnected simply by selecting them without having to search for them again.

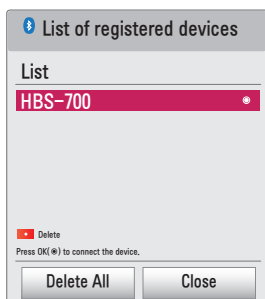

### Connecting

Select a Bluetooth device from the **List of registered devices** to connect to it.

- The registered Bluetooth device will attempt to connect automatically depending on the characteristics of the device. (Refer to the manual for the Bluetooth device.)
- You can stop the connection process immediately by selecting **Stop**.
- The time it takes to connect to a device may vary according to the signal strength and the number of devices.

### Disconnecting

Select **Disconnect** to disconnect the device.

- You can only disconnect a device from the **List of registered devices**.

## Deleting

Select **Delete Marked** or **Delete All** to delete any registered devices.

- **Delete Marked:** Press the **red** button in **List of registered devices** to delete the selected device.
- **Delete All:** Select **Delete All** in **List of registered devices** to delete all of the registered devices.

## Adjusting AV Sync. Adjust

When a Bluetooth device is connected, go to **SETTINGS** → **WIRELESS** → **AV Sync. Adjust** to adjust the synchronization between the video and the Bluetooth headset sound.

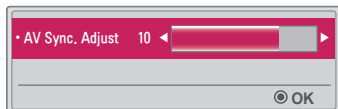

- This feature is only available when a Bluetooth device is connected.
- Audio sync may vary by manufacturer.
- When playing video from a connected USB drive, **AV Sync. Adjust** can also be adjusted using the **Set Audio.** menu.

# MY MEDIA

## Before Using

### Connecting a USB Device

Connect a USB device (external HDD, USB memory) to the USB port of projector to enjoy the content files stored in the USB device with your projector. You cannot write or delete data in the USB device. Connect a USB flash drive as shown below.

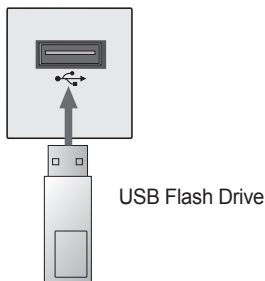

### Removing a USB Device

- 1** Click the **Q.MENU** button.
- 2** Use the **<** or **>** button to move to **USB Device** and press the **OK** button.
- 3** Select a USB to remove. Wait for confirmation that the USB device has stopped before removing the USB.

#### **!** **NOTE**

- If detached early, an error may occur on the projector or the USB storage device.
- Once a USB device has been selected for removal, it can no longer be read. Remove the USB storage device and then re-connect it.

### Tips for Using a USB Device

- If the USB storage device has a built-in auto recognition program or uses its own driver, it may not work.
- Some USB storage devices may not work or may work incorrectly.
- If you use a USB extension cable, the USB device may not be recognized or may not work properly.
- Use only USB storage devices formatted with the Windows FAT32 or NTFS file system.
- For external USB HDDs, it is recommended that you use devices with a rated voltage of less than 5V and a rated current of less than 500 mA.
- It is recommended to use a Hard Disk Drive with its own power supply. (If the power being supplied is not sufficient, the USB storage device may not be detected correctly). Note, a USB Hub is not supported.
- It is recommended that you use USB flash drives of 32 GB or less and USB HDDs of 1 TB or less.
- If a USB HDD with power-saving function does not work properly, turn the power off and on. For more information, refer to the user manual of the USB HDD.
- Data in USB storage device can be damaged so be sure to back up important files to other devices. Data maintenance is the user's responsibility and the manufacturer is not responsible for data loss.

## To Use My Media

**1** Press the **SETTINGS** button on the remote control.

**2** Select **MY MEDIA**.

Select desired file from the list. Watch the chosen file.

Sets play related settings by checking option during disk playback.

### My Media supporting file

- Maximum data transfer rate: 20 Mbps (Mega bit per second)
- External supported subtitle formats: \*.smi, \*.srt, \*.sub (MicroDVD, SubViewer 1.0/2.0), \*.ass, \*.ssa, \*.txt (TMPlayer), \*.psb (PowerDivX)
- Internal supported subtitle formats: SRT/ASS/SSA



## Video Supported Codec

Maximum: 1920 x 1080 @ 30p (only Motion JPEG 640 x 480 @ 30p)

Extension	Codec	
.asf, .wmv	Video	VC-1 Advanced Profile, VC-1 Simple and Main Profiles
	Audio	WMA Standard, WMA 9 Professional
.avi	Video	XVID, H.264/AVC
	Audio	MPEG-1 Layer I, II, MPEG-1 Layer III (MP3), Dolby Digital
.mp4, .m4v, .mov	Video	H.264/AVC, MPEG-4 Part 2
	Audio	AAC
.mkv	Video	H.264/AVC
	Audio	HE-AAC, Dolby Digital
.ts, .trp, .tp, .mts, .m2ts	Video	H.264/AVC, MPEG-2, VC-1
	Audio	MPEG-1 Layer I, II, MPEG-1 Layer III (MP3), Dolby Digital, Dolby Digital Plus, AAC
.vob	Video	MPEG-1, MPEG-2
	Audio	Dolby Digital, MPEG-1 Layer I, II, DVD-LPCM
.mpg, .mpeg	Video	MPEG-1
	Audio	MPEG-1 Layer I, II

## Audio File

File type	Item	Info
MP3	Bit rate	32 kbps to 320 kbps
	Sampling rate	32 kHz to 48 kHz
AC3	Bit rate	32 kbps to 640 kbps
	Sampling rate	32 kHz, 44.1 kHz, 48 kHz
MPEG	Bit rate	32 kbps to 448 kbps
	Sampling rate	32 kHz to 48 kHz
AAC, HEAAC	Bit rate	24 kbps to 3844 kbps
	Sampling rate	8 kHz to 96 kHz
CDDA	Bit rate	1.44 kbps
	Sampling rate	44.1 kHz
LPCM	Bit rate	1.41 Mbps to 9.6 Mbps
	Sampling rate	Multi-channel: 44.1 kHz, 88.2 kHz / 48 kHz, 96 kHz Stereo: 176.4 kHz, 192 kHz

## Available photo file

File type	Item	Info
2D (jpeg, jpg, jpe), 3D (jps)	Support File type	SOF0: Baseline, SOF1: Extend Sequential, SOF2: Progressive
	Picture Size	Minimum: 64 x 64 Maximum: Normal Type: 15360 (W) x 8640 (H) Progressive Type: 1920 (W) x 1440 (H)
3D (mpo)	Support File type	MPO
	Picture Size	4:3 size: 3648 x 2736, 2592 x 1944, 2048 x 1536 3:2 size: 3648 x 2432
BMP	Picture Size	Minimum: 64 x 64 Maximum: 9600 (W) x 6400 (H)
PNG	Support File type	Interlace, Non-Interlace
	Picture Size	Minimum: 64 x 64 Maximum: Interlace: 1200 (W) x 800 (H) Non-Interlace: 9600 (W) x 6400 (H)

\* BMP and PNG format files may be slower to display than JPEG.

## **Watching the Videos**

In the **Movie List**, you can watch movies stored on the connected USB device.

Controls playback and sets options while viewing videos.

### **Tips for Playing Video Files**

- Some subtitles created by users may not work properly.
- The video and subtitle files should be placed in the same folder. For subtitles to display correctly, the video and subtitle files must have the same name.
- We do not support any stream that contains GMC (Global Motion Compensation) or Qpel (Quarterpel Motion Estimation).
- Only H.264/AVC profile level 4.1 and lower is supported.
- Video files that exceed 50 GB (gigabyte) are not supported for playback. The file size limit is dependent on the encoding environment.
- DTS audio codec is not supported.

## Browsing Movie List

Play a video file stored in the connected device.

- 1 Connect a USB storage device.
- 2 Press the **USB** button.
- 3 Use the **<** or **>** button to select **Movie List** and press the **OK** button.
- 4 Use the **^**, **v**, **<** or **>** button to select the file you want and press the **OK** button.

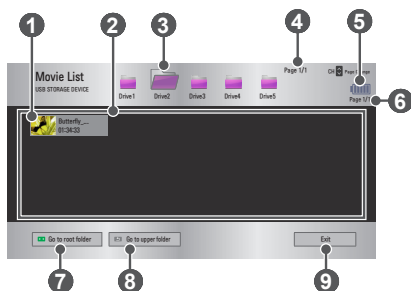

	Description	
1	Thumbnails	
	Abnormal file	
	File not supported	
2	File List	
3	Moves to the upper level folder.	
4	Current page/Total no. of folder pages	
5	Displays the remaining battery life.	
6	Current page/Total no. of file pages	

	Description
7	Moves to the top level folder.
8	Moves to the upper level folder.
9	Exit Movie List.

5 Control playback by using the following buttons.



Setting	Description
◀▶	Shows the current playing position. Use < or > buttons to move forward or backward.
■	Stops playing and returns to Movie List.
▶	Returns to normal playback.
	Pauses the media player. If no button is pressed on the remote control for 10 minutes after pausing, the playback is restarted.
▶▶	Displays in slow motion.
◀◀▶▶	Whenever this button is pressed, the playback speed is changed. x2, x4, x8, x16, x32
⏻	Reduces power consumption by adjusting peak screen brightness. (If the screen shows a low battery message, Energy Saving will be changed Maximum mode and will be disabled)
3D	Switches to the 3D screen.
Option	A pop-up window will appear.
Hide	Hides the playback bar. Press the <b>OK</b> button to make it appear.
Exit	Returns to the Movie List screen.

## Options for Movie List

- 1 Press the **Q.MENU** button.
- 2 Use the  $\wedge$  or  $\vee$  button to move to a desired option and press the **OK** button.
- 3 Use the  $\wedge$ ,  $\vee$ ,  $<$  or  $>$  button to set up each item.

### Set Video Play.

Setting	Description
<b>Picture Size</b>	<p>Selects the size of a playback screen.</p> <ul style="list-style-type: none"> <li>• <b>Full:</b> Files are played in full screen mode according to the aspect ratio of video.</li> <li>• <b>Original:</b> Displays the video in the original size.</li> </ul>
<b>Audio Language</b>	<p>Allows you to select the language you want for the file with multiple audio tracks. This option is not available if the file has only one audio track.</p>
<b>Subtitle Language</b>	<p>The subtitle can be turned on or off.</p> <ul style="list-style-type: none"> <li>• <b>Language:</b> One of any of the available languages can be selected.</li> <li>• <b>Code Page:</b> A character set used for a subtitle can be selected.</li> </ul> <p>By default, the subtitle is displayed in a language configured in <b>OPTION 1</b> → <b>Language</b>.</p> <ul style="list-style-type: none"> <li>– <b>Sync:</b> If a subtitle is not synchronized with its video, you can adjust its speed at 0.5 seconds unit.</li> <li>– <b>Position:</b> Moves the location of a subtitle.</li> <li>– <b>Size:</b> Changes the subtitle font size.</li> </ul>
<b>Repeat</b>	<p>Turns the repeat function <b>On</b> or <b>Off</b>.</p> <p>When it is set to off, the next file can be played sequentially if the file name is similar.</p>

### Set Video.

You can change video settings.

(Refer to *PICTURE Settings* on page 85.)

### Set Audio.

You can change audio settings.

(Refer to *AUDIO Settings* on page 92.)

## BLUETOOTH

You can change Bluetooth settings.

(Refer to *Setting Up Bluetooth on the Projector* on page 49.)

### **Set 3D Video**

You can set 3D video or 2D video.

### **3D setting**

You can set 3D settings. (Refer to *OPTION 1 Settings* on page 103.)



## Viewing the Photos

You can view photos stored on a connected device.

### Supported Photo Files

PHOTO (\*.JPEG)

Baseline: 64-pixel (width) x 64-pixel (height) - 15360-pixel (width) x 8640-pixel (height)

Progressive: 64-pixel (width) x 64-pixel (height) - 1920-pixel (width) x 1440-pixel (height)

- Non-supported files are displayed in the form of an icon.
- An error message is displayed for corrupted files or file formats that cannot be played.
- Corrupted files may not be displayed properly.
- It may take some time to view high-resolution images in full screen.

## Browsing Photo List

- 1 Connect a USB storage device.
- 2 Press the **USB** button.
- 3 Use the **<** or **>** button to select **Photo List** and press the **OK** button.
- 4 Use the **^**, **v**, **<** or **>** button to select the file you want and press the **OK** button.

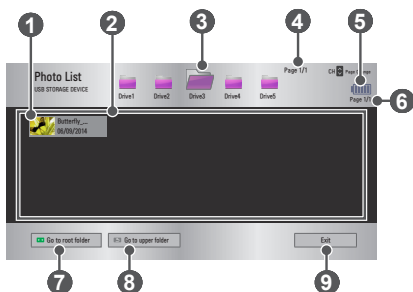

	Description	
1	Thumbnails	
	Abnormal file	
	File not supported	
2	File List	
3	Moves to the upper level folder.	
4	Current page/Total no. of folder pages	
5	Displays the remaining battery life.	
6	Current page/Total no. of file pages	
7	Moves to the top level folder.	
8	Moves to the upper level folder.	
9	Exit	

## 5 Control playback by using the following buttons.



Setting	Description
	Selects the previous or next photo.
<b>Slideshow</b>	All photos are displayed during slide show. <ul style="list-style-type: none"> <li>Set <b>Slide Speed</b> in the <b>Option</b> → <b>Set Photo View</b>. menu.</li> </ul>
<b>BGM</b>	You can listen to music while viewing photos in full size. <ul style="list-style-type: none"> <li>Set <b>BGM</b> in the <b>Option</b> → <b>Set Photo View</b>. menu.</li> </ul>
	Rotates photos. <ul style="list-style-type: none"> <li>Rotates a photo 90°, 180°, 270° or 360° clockwise.</li> <li>Photos cannot be rotated if their width is greater than the height of the max. supported resolution.</li> </ul>
	Views the photo in full mode or original mode. Press the <b>blue</b> button to enlarge the image.
	Reduces power consumption by adjusting peak screen brightness. (If the screen shows a low battery message, Energy Saving will be changed Maximum mode and will be disabled)
	Switches to the 3D screen.
<b>Option</b>	A pop-up window will appear.
<b>Hide</b>	Hides the menu on the full size screen. <ul style="list-style-type: none"> <li>To see the menu, press the <b>OK</b> button on the remote control.</li> </ul>
<b>Exit</b>	Exit from full screen photo view.

### Options for Photo List

- 1 Press the **Q.MENU** button.
- 2 Use the  $\wedge$  or  $\vee$  button to move to a desired option and press the **OK** button.
- 3 Use  $\wedge$ ,  $\vee$ ,  $<$  or  $>$  button to set up each item.

#### Set Photo View.

Setting	Description
<b>Slide Speed</b>	Selects a slideshow speed.
<b>BGM</b>	<p>Selects a music folder for the background music.</p> <ul style="list-style-type: none"> <li>• You cannot change the music folder while the background music is playing.</li> <li>• For background music, only the folder from the same device can be selected.               <ul style="list-style-type: none"> <li>– <b>Repeat</b>: Selects repeat play.</li> <li>– <b>Random</b>: Selects random play.</li> </ul> </li> </ul>

#### Set Video.

You can change video settings.

(Refer to *PICTURE Settings* on page 85.)

#### Set Audio.

You can change audio settings.

(Refer to *AUDIO Settings* on page 92.)

#### BLUETOOTH

You can change Bluetooth settings.

(Refer to *Setting Up Bluetooth on the Projector* on page 49.)

#### Set 3D Video

You can set 3D image or 2D image.

#### 3D setting

You can set 3D settings. (Refer to *OPTION 1 Settings* on page 103.)

## **Listening to Music**

You can play audio files stored on the connected device.

### **Supported Music Files**

\*.MP3

Bit rate range 32 Kbps to 320 Kbps

- Sampling rate MPEG1 Layer3: 32 kHz, 44.1 kHz, 48 kHz
- Sampling rate MPEG2 Layer3: 16 kHz, 22.05 kHz, 24 kHz

## Browsing Music List

- 1 Connect a USB storage device.
- 2 Press the **USB** button.
- 3 Use the **<** or **>** button to select **Music List** and press the **OK** button.
- 4 Use the **^**, **v**, **<** or **>** button to select the file you want and press the **OK** button.

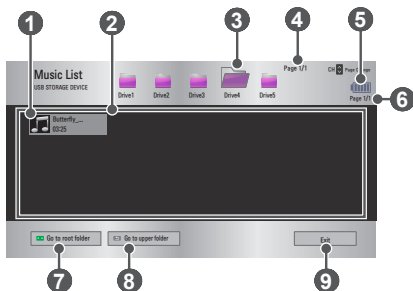

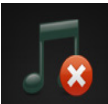
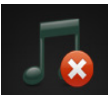
	Description	
1	Thumbnails	
	Abnormal file	
	File not supported	
2	File List	
3	Moves to the upper level folder.	
4	Current page/Total no. of folder pages	
5	Displays the remaining battery life.	
6	Current page/Total no. of file pages	
7	Moves to the top level folder.	
8	Moves to the upper level folder.	
9	Exit	

## 5 Control playback by using the following buttons.

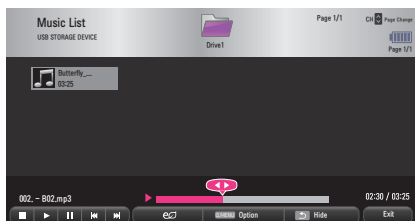

Setting	Description
	Changes the playing position.
	Stops playing.
	Returns to normal playback.
	Pauses the media player.
	Plays the previous/next file.
	Reduces power consumption by adjusting peak screen brightness. (If the screen shows a low battery message, Energy Saving will be changed Maximum mode and will be disabled)
<b>Option</b>	Sets up the options of Music List.
<b>Hide</b>	Hides the playback bar. <ul style="list-style-type: none"> <li>• Press the <b>OK</b> button to make the playback bar appear.</li> </ul>
<b>Exit</b>	Returns to the Music List screen.

### Options for Music List

- 1 Press the **Q.MENU** button.
- 2 Use the **^** or **v** button to move to a desired option and press the **OK** button.
- 3 Use **^**, **v**, **<** or **>** button to set up each item.

### Set Audio Play.

Setting	Description
<b>Repeat</b>	Selects repeat play.
<b>Random</b>	Selects random play.

### Set Audio.

You can change audio settings.

(Refer to *AUDIO Settings* on page 92.)

### BLUETOOTH

You can change Bluetooth settings.

(Refer to *Setting Up Bluetooth on the Projector* on page 49.)



## Viewing Files

You can see document files stored on a connected device.

### Supported File Formats

XLS, XLSX, DOC, DOCX, PPT, PPTX, TXT, PDF, HWP

Microsoft Office 97/2000/2002/2003/2007 version

Adobe PDF 1.0/1.1/1.2/1.3/1.4 version

Hangul: 97/2000/2002/2005/2007 version

- File Viewer realigns a document, so it may look different from what is displayed on a PC.
- For documents that include images, the resolution may look lower during the realigning process.
- If the document is large or has many pages, it may take longer to load.
- Unsupported fonts may be replaced by other fonts.
- The file viewer may not open for Office documents that contain many high resolution images. In that case, reduce the image file size, save it on a USB storage device and run the file viewer again or connect your PC to the projector and open the file on your PC.

## Browsing File List

- 1 Connect a USB storage device.
- 2 Press the **USB** button.
- 3 Use the **<** or **>** button to select **File List** and press the **OK** button.
- 4 Use the **^**, **v**, **<** or **>** button to select the file you want and press the **OK** button.

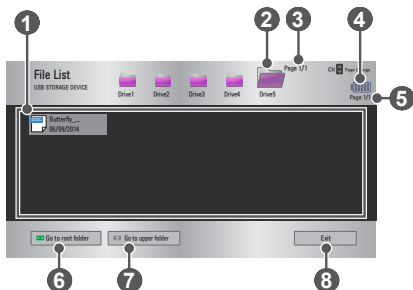

	Description
1	File List
2	Moves to the upper level folder.
3	Current page/Total no. of folder pages
4	Displays the remaining battery life.
5	Current page/Total no. of file pages
6	Moves to the top level folder.
7	Moves to the upper level folder.
8	Exit

**5** Control playback by using the following buttons.

- Click **Go Page** then the pop-up window for selecting the number of page appears. Input the page to move to the page you want.
- Press the **VOL +, -** button to zoom in or zoom out.

Press the **OK** button and then use the **Up/Down/Left/Right** buttons to move to **Go Page** or **Zoom**.

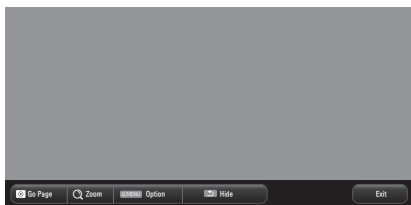

Setting	Description
<b>Go Page</b>	Moves to the page you want. Use the Up/Down/Left/Right buttons to select a page and press the <b>OK</b> button.
<b>Zoom</b>	Enlarges or reduces the document.
<b>Option</b>	Sets up the options of File Viewer.
<b>Hide</b>	Hides the menu. • Press the <b>OK</b> button to make it appear.
<b>Exit</b>	Returns to the File Viewer screen.

### Options for File List

- 1** Press the **Q.MENU** button.
- 2** Use **^**, **v**, **<** or **>** button to set up each item.

#### Set FileViewer Option

Setting	Description	
<b>Single Page Loading</b>	<b>On</b>	Loads and displays pages one by one. The initial loading time is short but a content heavy page may be displayed slowly.
	<b>Off</b>	Loads all pages of a file to memory before it starts to display them. The initial loading time is long but you can navigate pages quickly after loading is complete. If a file is too large, it may fail to load all the pages.
<b>Image Quality</b>	You can set the quality of the image included in the document. The following three options are available for the image quality: High, Medium, Low. Higher the image quality, lower the display time.	
<b>Document Align</b>	Selects initial document align method.	

File View settings are default, so close the currently opened document to apply changes to the new document, if any.

# 3D FUNCTION

3D technology uses different video frames for each eye to add depth to the video.

## While Watching 3D

### WARNING

- If you view 3D video or images too closely for a long period of time, your eyesight may become worse.
- If you watch the projector or game screen for a long time with 3D glasses on, you may experience dizziness or eye fatigue.
- People with chronic diseases (epilepsy, cardiovascular disease, blood pressure-related diseases, etc.), pregnant women, and people with serious motion sickness should avoid watching 3D video.
- People with stereo blindness, or with stereopsis problems, should also avoid watching 3D video content. It may cause double vision or visual discomfort.
- People with strabismus, amblyopia, or astigmatism may have difficulty perceiving video depth and may be fatigued easily due to double vision or other ailments. It is recommended to rest more frequently than other viewers.
- Because 3D can be recognized as real, some viewers may get surprised or overexcited.
- Do not watch 3D images near fragile objects or any objects that can be knocked over easily.
- Take care not to injure yourself as you may subconsciously try to move away from the life-like 3D images.

- **Warning about photosensitivity seizures**

- Some users may experience a seizure or other abnormal symptoms when they are exposed to a flashing light or particular patterns from a video game. If anyone in your family has a history of epilepsy or has ever experienced any kind of seizure, please consult your doctor before viewing 3D images.

If you experience one of the following symptoms while watching a 3D video, stop watching the 3D video immediately and take a rest.

- Dizziness, switched eyesight, twitching of the eye or facial muscles, involuntary movements, cramp, loss of consciousness, confusion, loss of sense of direction, or nausea. If the symptom does not disappear, please consult your doctor.
- You can reduce the risk of photosensitive seizures by taking the following preventive measures.
    - Take a rest of 5 to 15 mins. for every 1 hour of viewing.
    - If vision varies between each eye, correct the variation before beginning to watch a 3D video.
    - Ensure that the 3D video is directly in front of you, at eye level.
    - You should stop watching if you experience a headache, fatigue or dizziness.
    - Do not view 3D images for a long period of time when you are tired or ill.

**⚠ CAUTION**

- Extra special care is required for children watching a 3D video.

**When Watching 3D Video**

- Prevent children of 5 years or younger from watching a 3D video. It may impair the development of their eyes.
- Children 10 years old or younger are still developing their eyesight and may have an excessive tendency to touch or jump at the screen. Adult guidance and supervision is recommended.
- Since the distance between the eyes is narrower for children than in adults, children tend to notice a greater difference in the images seen by each eye. Therefore, even while watching the same 3D video, children may have a greater depth perception than adults.
- Young people of 19 years old or younger may respond with sensitivity to the light stimuli of 3D content. Excessive viewing when fatigued is not recommended.
- Elderly viewers may have a reduced depth perception than younger viewers. Avoid watching video nearer than the recommended distance.
- Watch 3D images within the optimum viewing angle and distance.
- If you are outside the viewing angle or distance, you may not be able to see 3D images. You cannot view 3D images when you are lying down.
- You may see left and right images overlapped during projector initialization after it is powered on. It may take some time for optimization.
- It may take some time for the 3D image to look normal after you turn your eyes away from the screen and look back at the 3D image.
- It may flicker slightly while watching 3D images under a 3 wavelength lamp fluorescent light (50 Hz to 60 Hz) or near windows. If so, it is recommended to block the sun light with a curtain and to dim the lights.
- The 3D glasses must be DLP-LINK (DLP Ready) type.
- You may not be able to watch 3D properly if there is an obstacle between the projector and 3D glasses.
- Install the 3D projector as far as possible from other devices.
- If a future 3D broadcasting format that is not supported by this projector becomes the standard, an additional device such as a set-top box may be required.

**Please check the following when using 3D glasses.**

- Do not use 3D glasses as ordinary glasses, sunglasses or protective goggles.
  - If you do so, this may cause injury.
- Do not store 3D glasses in very hot or very cold conditions. If you do, this may cause them to become distorted. Do not use distorted glasses.
- Do not drop 3D glasses or allow them to come into contact with other objects.
  - This may cause product malfunction.
- The lenses of 3D glasses are easily scratched. Use a soft clean cloth when cleaning them.
- Foreign particles on the cloth may cause scratches.
- Do not scratch the surface of the 3D glasses' lenses with sharp objects or wipe them with chemicals. If the lenses get scratched, images may not look normal when viewing 3D.



## Requirements for Watching 3D Images

\* Optimum viewing angle: Top/Bottom/Left/Right 9°

Recommended viewing distance: 3 m (9.8 feet) to 5 m

(16.4 feet) (with Adaptor)

1 m (3.2 feet) to 2 m

(6.5 feet) (without Adaptor)

Recommended screen size: 101 cm (39.7 inches)

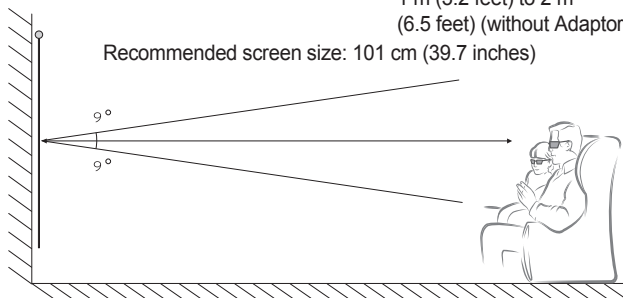

\* Watching 3D videos should be done in dark room environments only.

### ! NOTE

- The pairing with the DLP-LINK glasses is affected by the intensity of light reflected from the screen. Therefore, the pairing with DLP-LINK glasses may not work properly if the light reflected from the screen is not bright enough, such as when the surrounding area is bright, the screen is big, or the maximum energy saving mode is enabled.
- Some menus may not work while playing a 3D video.
- You can only watch a 3D video properly when the 3D video format option has been selected on the projector.

## Using the DLP-LINK (DLP-Ready) Type Glasses

- 1** While watching 3D images from the projector, press buttons on the glasses.
- 2** When you press the button, the glasses flicker while synchronizing with the 3D images. (The flickering is a unique operation method of DLP-LINK type glasses. It may be different depending on the glasses type.)
- 3** If the glasses flicker or problems occur while watching 3D, first turn the lights off to make the room darker. Contact your projector seller for queries about the glasses.

## To view 3D images

3D imaging is a technology that utilizes the slight difference in left/right eyes to make the images on the projector appear just like real-life 3-dimensional space.

- 1** Play a 3D-image title or tune to a 3D channel.
- 2** Press the **3D** button to activate 3D.
- 3** Turn on the 3D glasses and put them on.
- 4** While viewing 3D images, press the **3D** button on the remote control to end 3D image viewing.
- 5** Press the **L/R** button to switch the playing direction of an image. Select a screen with better 3D display quality.
  - If you press the 3D button during viewing, it returns to 2D.

\* Depending on the input signal, the available 3D type may differ.

## Supported 3D Mode

	Signal	Resolution	Horizontal Frequency (kHz)	Vertical Frequency (Hz)	Supported 3D Formats
<b>HDMI</b>	720p	1280 x 720	89.9 / 90	59.94 / 60	Frame Packing
			45	60	Side by side (half), Top and Bottom
	1080i	1920 x 1080	33.7	60	Side by side (half), Top and Bottom
	1080p	1920 x 1080	53.95 / 54	23.98 / 24	Frame Packing
			67.5	60	Side by side (half), Top and Bottom, Single Frame Sequential
			27	24	Side by side (half), Top and Bottom
			33.7	30	Side by side (half), Top and Bottom
	<b>USB</b>	1080p	1920 x 1080	33.75	30
<b>RGB</b>	1080p	1920 x 1080	67.5	60	Side by side(half), Top and Bottom
<b>DTV</b>	720p	1280 x 720	45	60	Side by side(half), Top and Bottom
	1080i	1920 x 1080	33.7	60	Side by side(half), Top and Bottom

# CUSTOMIZING SETTINGS

## SETTINGS

- 1** Press the **SETTINGS** button.
- 2** Use the **^**, **v**, **<** or **>** button to select the desired item and press the **OK** button.
- 3** Use the **^**, **v**, **<** or **>** button to set up the desired item and press the **OK** button.
- 4** Press the **EXIT** button when completed.

Menu	Description
<b>PICTURE</b>	Adjusts the image quality for optimal viewing.
<b>AUDIO</b>	Adjusts the sound quality and volume level.
<b>CHANNEL</b>	Sets up and edits a channel.
<b>TIME</b>	Sets the time and time-related features.
<b>WIRELESS</b>	Wireless-related features.
<b>LOCK</b>	Locks or unlocks a channels or a programs.
<b>OPTION 1</b>	Customizes the general settings.
<b>OPTION 2</b>	Customizes the settings related the projector.
<b>INPUT</b>	Selects the desired input source.
<b>MY MEDIA</b>	Accesses photo, music, movie, and document files.

## PICTURE Settings

- 1** Press the **SETTINGS** button.
- 2** Use the  $\wedge$ ,  $\vee$ ,  $\lt$  or  $\gt$  button to select **PICTURE** and press the **OK** button.
- 3** Use the  $\wedge$ ,  $\vee$ ,  $\lt$  or  $\gt$  button to set up the desired item and press the **OK** button.
  - To return to the previous menu, press the  $\curvearrowright$  button.
- 4** Press the **EXIT** button when completed.

The available picture settings are described as follows.

Item	Description	
<b>Energy Saving</b>	Reduces power consumption by adjusting peak screen brightness. (If the screen shows a low battery message, Energy Saving will be changed Maximum mode and will be disabled)	
	<b>Mode</b>	
	<table border="1" style="width: 100%;"> <tr> <td data-bbox="277 778 422 869"><b>Minimum/ Medium/ Maximum</b></td> <td data-bbox="422 778 893 869">Applies the pre-set <b>Energy Saving</b> mode.</td> </tr> </table>	<b>Minimum/ Medium/ Maximum</b>
<b>Minimum/ Medium/ Maximum</b>	Applies the pre-set <b>Energy Saving</b> mode.	

Item	Description	
<b>Picture Mode</b>	Selects the picture mode optimized for the viewing environment or the program. You can also customize advanced options for each mode.	
	<b>Mode</b>	
	<b>Vivid</b>	Maximizes the visual effect of video. Heightens contrast, brightness and sharpness to display vivid images.
	<b>Standard</b>	Displays images in standard levels of contrast, brightness and sharpness.
	<b>Cinema</b>	Optimizes the image for a movie.
	<b>Sport</b>	Optimizes the image for sports by emphasizing primary colors and dynamic actions.
	<b>Game</b>	Optimizes the image for playing games on fast-moving screens.
<b>Contrast</b>	Adjusts the difference between bright and dark regions of the screen.	
<b>Brightness</b>	Adjusts the overall screen brightness.	
<b>Sharpness</b>	Adjusts the sharpness of the borders between bright and dark. Horizontal and Vertical Sharpness are available only in <b>Expert1/2</b> .	
<b>Color</b>	Adjusts the intensity of all colors.	
<b>Tint</b>	Adjusts the balance between red and green levels.	
<b>Advanced Control</b>	Customizes the advanced settings.	

Item	Description	
<b>Picture Option</b>	Sets optional settings.	
<b>Picture Reset</b>	Resets values customized by the user. Each picture mode is reset. Select the picture mode you wish to reset.	
<b>Aspect Ratio</b>	Resizes the picture.	
<b>Screen (RGB-PC)</b>	Adjusts the picture quality of RGB-PC input.	
	<b>Option</b>	
	<b>Resolution</b>	Available resolutions are 768 resolution (1024 x 768/ 1280 x 768/ 1360 x 768, 60 Hz) and 1050 resolution (1400 x 1050/ 1680 x 1050, 60 Hz).
	<b>Auto Config.</b>	Provides optimized picture quality by automatically calibrating the mismatch of horizontal width and picture shake caused by clashes between the internal settings of the projector and various PC graphic signals.
	<b>Position</b>	Moves the image up/down/left/right.
	<b>Size</b>	Changes the screen size.
	<b>Phase</b>	Makes the picture look clear by removing horizontal noise.
<b>Reset</b>	Restores all the settings to the factory default.	

## Advanced Control

Item	Description
<b>Dynamic Contrast</b>	Adjusts contrast and color to the optimal level according to the screen's brightness.
<b>Dynamic Color</b>	Adjusts colors for more natural-looking colors.
<b>Color Gamut</b>	Selects the range of colors that can be expressed. <ul style="list-style-type: none"> <li>• <b>Standard:</b> Displays the original colors of an input signal regardless of the display features.</li> <li>• <b>Wide:</b> Makes use of the display's rich colors.</li> </ul>
<b>Skin Color</b>	Skin color spectrum can be separately set to implement the skin color as defined by the user.
<b>Sky Color</b>	Sky color is set separately.
<b>Grass Color</b>	Natural color spectrum (meadows, hills, etc.) can be separately set.
<b>Gamma</b>	Sets the gradation curve according to the output of the picture signal in relation to the input signal.

\* Depending on input signal or other picture settings, the range of detailed items for adjustment may differ.



## Expert Control

Item	Description
<b>Dynamic Contrast</b>	Adjusts contrast and color to the optimal level according to the screen's brightness.
<b>Color Gamut</b>	Selects the range of colors that can be expressed. <ul style="list-style-type: none"> <li>• <b>Standard:</b> Displays the original colors of an input signal regardless of the display features.</li> <li>• <b>Wide:</b> Makes use of the display's rich colors.</li> </ul>
<b>Edge Enhancer</b>	Shows clearer and distinctive yet natural edges of the video.
<b>Expert Pattern</b>	Patterns used for expert adjustment.
<b>Color Filter</b>	Filters a specific color spectrum in RGB colors to fine-tune color saturation and hue accurately.
<b>Color Temperature</b>	In <b>Expert</b> mode, you can customize the options of each mode. <p><b>Gamma:</b> Select <b>1.9</b>, <b>2.2</b>, or <b>2.4</b>.</p> <p><b>a. Method: 2 Points</b></p> <ul style="list-style-type: none"> <li>– <b>Pattern:</b> Inner, Outer</li> <li>– <b>Points:</b> Low, High</li> <li>– <b>Red/Green/Blue:</b> Adjustable range <b>-50</b> to <b>+50</b>.</li> <li>– <b>Apply to all inputs:</b> The values of the <b>Color Temperature</b> is applied to all the input modes.</li> </ul> <p><b>b. Method: 20 Point IRE</b></p> <ul style="list-style-type: none"> <li>– <b>Pattern:</b> Inner, Outer</li> <li>– <b>IRE</b> (Institute of Radio Engineers) is the unit indicating the size of a video signal and can be set to <b>0</b>, <b>5</b>, <b>10</b>, <b>15</b>, ... <b>100</b>. You can fine-tune for each setting as shown below.</li> <li>– <b>Luminance:</b> The adjustment range is <b>50</b> to <b>500</b>.</li> <li>– <b>Red/Green/Blue:</b> The adjustment range is <b>-50</b> to <b>+50</b>.</li> <li>– <b>Apply to all inputs:</b> The values of the <b>Color Temperature</b> is applied to all the input modes.</li> </ul>

Item	Description
<b>Color Management System</b>	<p>Adjusts Red/Green/Blue/Cyan/Magenta/Yellow colors. Allows an expert to adjust the tint using a test pattern. Six colors (Red/Green/Blue/Cyan/Magenta/Yellow) can be selectively adjusted without affecting other colors. You may not see colors change on a normal picture even after adjustment.</p> <ul style="list-style-type: none"> <li>– <b>Saturation Red/Green/Blue/Yellow/Cyan/Magenta,</b></li> <li><b>Tint Red/Green/Blue/Yellow/Cyan/Magenta,</b></li> <li><b>Luminance Red/Green/Blue/Yellow/Cyan/Magenta:</b> The adjustment range is <b>-30 to +30</b> each.</li> </ul>

\* Depending on input signal or other picture settings, the range of detailed items for adjustment may differ.

**Picture Option**

<b>Item</b>	<b>Description</b>
<b>Noise Reduction</b>	Reduces screen noise in the video.
<b>MPEG Noise Reduction</b>	Eliminates noise generated while creating digital picture signals.
<b>Black Level</b>	Adjusts the brightness or darkness of the screen to suit the black level of the picture input using the degree of darkness (black level) of the screen.
<b>Real Cinema</b>	Optimizes the screen for movie viewing.
<b>Color Temperature</b>	Adjusts the overall color of the screen to suit your preference. Select <b>Warm, Cool, Medium, or Natural.</b>

## AUDIO Settings

- 1** Press the **SETTINGS** button.
- 2** Use the **^**, **v**, **<** or **>** button to select **AUDIO** and press the **OK** button.
- 3** Use the **^**, **v**, **<** or **>** button to set up the desired item and press the **OK** button.
  - To return to the previous menu, press the **↶** button.
- 4** Press the **EXIT** button when completed.

The available sound settings are described as follows.

Item	Description
Sound Mode	Sets the sound mode.
	<b>Mode</b>
	<b>Standard</b>
<b>News/Music/ Cinema/ Sport/Game</b>	Sets audio optimized for a specific genre.

Item	Description	
<b>Sound Effect</b>	The user can select various sound effects.	
	<b>Mode</b>	
	<b>Clear Voice II</b>	Makes the voice from the projector crisp and clear.
	<b>Virtual Surround</b>	LG's proprietary audio processing technology allows 5 channel-like surround sound from two speakers. <ul style="list-style-type: none"> <li>• When <b>Clear Voice II</b> is set to on, <b>Virtual Surround</b> cannot be selected.</li> </ul>
	<b>Equalizer</b>	Adjusts the volume to a level of your choice using the <b>Equalizer</b> . <ul style="list-style-type: none"> <li>• Audio-band (<b>100 Hz/ 300 Hz/ 1 kHz/ 3 kHz/ 10 kHz</b>) can be adjusted from <b>-10 to 10</b>.</li> <li>• <b>Reset</b>: Resets voice options that the user has changed.</li> </ul>
	<b>Balance</b>	Adjusts the balance of the left and right speakers.
<b>Reset</b>	Initialize the applied effect under the <b>Sound Effect</b> menu.	
<b>Auto Volume</b>	Automatically adjusts the volume level.	

## CHANNEL Settings

- 1 Press the **SETTINGS** button.
- 2 Use the **^**, **v**, **<** or **>** button to select **CHANNEL** and press the **OK** button.
- 3 Use the **^**, **v**, **<** or **>** button to set up the desired item and press the **OK** button.
  - To return to the previous menu, press the **↶** button.
- 4 Press the **EXIT** button when completed.

The available channel settings are described as follows.

Item	Description
<b>Auto Tuning</b>	Remembers a channel which is currently broadcasting. You should use this function when you move to another house or move the Projector to other place. It must be used while the antenna is connected and there are channel broadcasting signals. <ul style="list-style-type: none"> <li>• Channels are not registered properly unless the antenna/cable is connected correctly.</li> <li>• <b>Auto Tuning</b> only finds programs that are currently broadcasting.</li> <li>• If <b>Lock System</b> is turned <b>On</b>, a pop-up window will appear asking for password.</li> </ul>
<b>Manual Tuning</b>	Adjusts channels manually and saves the results. For digital broadcasting, signal strength, etc. can be checked.
<b>Channel Edit</b>	Edits the saved channels. Set as favorite channel, block/unblock channel, delete channel etc. of the selected channel.

## TIME Settings

- 1 Press the **SETTINGS** button.
- 2 Use the  $\wedge$ ,  $\vee$ ,  $<$  or  $>$  button to select **TIME** and press the **OK** button.
- 3 Use the  $\wedge$ ,  $\vee$ ,  $<$  or  $>$  button to set up the desired item and press the **OK** button.
  - To return to the previous menu, press the  $\curvearrowright$  button.
- 4 Press the **EXIT** button when completed.

The available time settings are described as follows.

Item	Description			
<b>Clock</b>	Checks or changes the time while watching projector.			
	<b>Mode</b>			
	<table border="1" style="width: 100%; border-collapse: collapse;"> <tr> <td style="width: 20%;"><b>Auto</b></td> <td>Synchronizes the projector clock to the digital time information sent by the TV station.</td> </tr> <tr> <td><b>Manual</b></td> <td>Sets the time and date manually if the auto setup does not correspond to the current time.</td> </tr> </table>	<b>Auto</b>	Synchronizes the projector clock to the digital time information sent by the TV station.	<b>Manual</b>
<b>Auto</b>	Synchronizes the projector clock to the digital time information sent by the TV station.			
<b>Manual</b>	Sets the time and date manually if the auto setup does not correspond to the current time.			
<b>Off Time/On Time</b>	<p>Sets the time to turn on or off the projector automatically. To use this feature, you should set the current time and date in advance.</p> <p>To use this feature, set the time correctly.</p> <p>If you do not want to set <b>Off Time/On Time</b>, select <b>Off</b> in <b>Repeat</b>.</p> <div style="border: 1px solid black; padding: 10px; margin-top: 10px;"> <p> <b>NOTE</b></p> <ul style="list-style-type: none"> <li>If you set both <b>Off Time</b> and <b>On Time</b> features to the same time, the Off time feature overrides the On time feature.</li> <li>If you do not press any button within two hours after the projector is turned on by the <b>On Time</b> feature, the projector enters standby mode automatically.</li> </ul> </div>			

Item	Description
<b>Sleep Timer</b>	Turns off the Projector after a preset number of minutes. To cancel the <b>Sleep Timer</b> , select <b>Off</b> .
<b>Auto Off</b>	If there is no input signal or button press, the projector automatically turns off after the preset time has elapsed.
<b>Automatic Standby</b>	Turns off the projector automatically after a set period of time if there is no button input on the projector.



## WIRELESS Settings

- 1 Press the **SETTINGS** button.
- 2 Use the  $\wedge$ ,  $\vee$ ,  $\lt$  or  $\gt$  button to select **WIRELESS** and press the **OK** button.
- 3 Use the  $\wedge$ ,  $\vee$ ,  $\lt$  or  $\gt$  button to set up the desired item and press the **OK** button.
  - To return to the previous menu, press the  $\curvearrowright$  button.
- 4 Press the **EXIT** button when completed.

The available wireless settings are described as follows.

Item	Description			
<b>SCREEN SHARE</b>	The SCREEN SHARE displays the screen of the connected device. <ul style="list-style-type: none"> <li>• You can check the SCREEN SHARE's ID.</li> </ul>			
	<b>Mode</b>			
	<table border="1" style="width: 100%; border-collapse: collapse;"> <tr> <td data-bbox="253 730 412 903" style="width: 20%;"><b>Group</b></td> <td data-bbox="412 730 898 903">           This is the Group setting for each device supporting the SCREEN SHARE feature. When the wireless connection is weak or unstable, adjust the Group setting to correct the problem.         </td> </tr> <tr> <td data-bbox="253 903 412 1310"><b>Channel</b></td> <td data-bbox="412 903 898 1310">           You can change the channel used for wireless connections.           <ul style="list-style-type: none"> <li>• <b>Search Channels:</b> Select channel searching methods.               <ul style="list-style-type: none"> <li>– <b>Auto:</b> The projector searches for available channels and automatically selects the least used channel.</li> <li>– <b>Manual:</b> You can select a channel manually.</li> </ul> </li> <li>• <b>Channel:</b> This is shown when <b>Search Channels</b> is set to <b>Manual</b>. It allows you to specify a channel number to use.</li> </ul> </td> </tr> </table>	<b>Group</b>	This is the Group setting for each device supporting the SCREEN SHARE feature. When the wireless connection is weak or unstable, adjust the Group setting to correct the problem.	<b>Channel</b>
<b>Group</b>	This is the Group setting for each device supporting the SCREEN SHARE feature. When the wireless connection is weak or unstable, adjust the Group setting to correct the problem.			
<b>Channel</b>	You can change the channel used for wireless connections. <ul style="list-style-type: none"> <li>• <b>Search Channels:</b> Select channel searching methods.               <ul style="list-style-type: none"> <li>– <b>Auto:</b> The projector searches for available channels and automatically selects the least used channel.</li> <li>– <b>Manual:</b> You can select a channel manually.</li> </ul> </li> <li>• <b>Channel:</b> This is shown when <b>Search Channels</b> is set to <b>Manual</b>. It allows you to specify a channel number to use.</li> </ul>			

Item	Description	
<b>Bluetooth</b>	Sound is output through the Bluetooth headset. First, set <b>Bluetooth to On</b> .	
	<b>Item</b>	
	<b>Search Device</b>	Search for the device to connect to.
	<b>List of registered devices</b>	Connected devices are saved in the <b>List of registered devices</b> . The saved list of registered devices can be displayed.
	<b>AV Sync. Adjust</b>	When the video and the sound are not synchronized correctly, you can manually adjust the synchronization.

## LOCK Settings

- 1 Press the **SETTINGS** button.
- 2 Use the **^**, **v**, **<** or **>** button to select **LOCK** and press the **OK** button.
  - To enter the **LOCK** menu, enter the preset 4-digit password. The initial password is set as **0000**.
- 3 Use the **^**, **v**, **<** or **>** button to set up the desired item and press the **OK** button.
  - To return to the previous menu, press the **↶** button.
- 4 Press the **EXIT** button when completed.

The available lock settings are described as follows.

Item	Description
<b>Set Password</b>	Sets or changes projector password. <ul style="list-style-type: none"> <li>• The initial password is set as <b>0000</b>.</li> </ul>

Item	Description	
<b>Lock System</b>	Locks the selected channel or external input. First set <b>Lock System</b> to <b>On</b> .	
	<b>Item</b>	
	<table border="1"> <tr> <td data-bbox="270 323 414 491"><b>Block Channel</b></td> <td data-bbox="414 323 940 491">Blocks the programs that contain inappropriate contents for children. The programs can be selected but the screen is blank and the audio is muted. To watch a locked program, enter the password.</td> </tr> </table>	<b>Block Channel</b>
<b>Block Channel</b>	Blocks the programs that contain inappropriate contents for children. The programs can be selected but the screen is blank and the audio is muted. To watch a locked program, enter the password.	
<table border="1"> <tr> <td data-bbox="270 491 414 1086"><b>Movie Rating</b></td> <td data-bbox="414 491 940 1086">           Blocks the movies that are only broadcasted on the TV and contain inappropriate contents, based on the Motion Picture Association of America (MPAA) rating.           <ul style="list-style-type: none"> <li>• <b>G: General audiences</b> All ages admitted</li> <li>• <b>PG: Parental guidance suggested</b> Some material may not be suitable for children</li> <li>• <b>PG-13: Parents strongly cautioned</b> Some material may be inappropriate for children under 13</li> <li>• <b>R: Restricted</b> Under 17 requires accompanying parent or adult guardian</li> <li>• <b>NC-17: No one 17 and under admitted</b></li> <li>• <b>X: Adult only</b></li> </ul> </td> </tr> </table>	<b>Movie Rating</b>	Blocks the movies that are only broadcasted on the TV and contain inappropriate contents, based on the Motion Picture Association of America (MPAA) rating. <ul style="list-style-type: none"> <li>• <b>G: General audiences</b> All ages admitted</li> <li>• <b>PG: Parental guidance suggested</b> Some material may not be suitable for children</li> <li>• <b>PG-13: Parents strongly cautioned</b> Some material may be inappropriate for children under 13</li> <li>• <b>R: Restricted</b> Under 17 requires accompanying parent or adult guardian</li> <li>• <b>NC-17: No one 17 and under admitted</b></li> <li>• <b>X: Adult only</b></li> </ul>
<b>Movie Rating</b>	Blocks the movies that are only broadcasted on the TV and contain inappropriate contents, based on the Motion Picture Association of America (MPAA) rating. <ul style="list-style-type: none"> <li>• <b>G: General audiences</b> All ages admitted</li> <li>• <b>PG: Parental guidance suggested</b> Some material may not be suitable for children</li> <li>• <b>PG-13: Parents strongly cautioned</b> Some material may be inappropriate for children under 13</li> <li>• <b>R: Restricted</b> Under 17 requires accompanying parent or adult guardian</li> <li>• <b>NC-17: No one 17 and under admitted</b></li> <li>• <b>X: Adult only</b></li> </ul>	

Item	Description	
<b>Lock System</b>	<b>Item</b>	
	<b>TV Rating-Children</b>	<p>Blocks the children's TV programs that parents do not want their children to watch. To block other TV programs, you should set the TV Rating-General feature.</p> <ul style="list-style-type: none"> <li>• <b>Age TV-Y</b> (All children, including children from ages 2-6), <b>TV-Y7</b> (Directed to older children, suitable for children age 6 and above)</li> <li>• <b>Fantasy Violence TY-Y7</b> (Directed to older children - Fantasy violence, suitable for children age 6 and above, containing more intense or combative fantasy violence)</li> </ul>
	<b>TV Rating-General</b>	<p>Blocks the TV programs that you want based on the ratings by using the Parental Control Function (V-Chip). The V-Chip electronically reads TV program ratings and allows parents to block program that are unsuitable for children.</p> <ul style="list-style-type: none"> <li>• <b>Age TV-G</b> (General audience, suitable for all ages) <b>TV-PG</b> (Parental guidance suggested, containing material that are unsuitable for younger children) <b>TV-14</b> (Parents strongly cautioned, containing material that are unsuitable for children age 14 and under) <b>TV-MA</b> (Mature audience only, unsuitable for children age)</li> <li>• <b>Dialogue</b> (suggestive dialogue) <b>TV-PG</b> or <b>TV-14</b></li> <li>• <b>Language</b> (coarse language) <b>TV-PG</b>, <b>TV-14</b>, or <b>TV-MA</b></li> <li>• <b>Sex</b> (sexual situation) <b>TV-PG</b>, <b>TV-14</b>, or <b>TV-MA</b></li> <li>• <b>Violence</b> <b>TV-PG</b>, <b>TV-14</b>, or <b>TV-MA</b></li> </ul>
	<b>Down-loadable Rating</b>	<p>This function operates only when TV has received Region5 Rating data. The name of the rating option may differ.</p>
<b>Input Block</b>	<p>Block the input sources.</p>	

Item	Description
<b>Key Lock</b>	<p>Locks control buttons on projector.</p> <ul style="list-style-type: none"><li>• <b>Key Lock</b> function remains intact even in case of power outage or when the power cord is removed from the wall socket.</li><li>• <b>Key Lock</b> function can only be set by remote control, and not by the button on the projector.</li><li>• If you select <b>On</b>: You can turn the projector on only with the Power button if you have turned the projector off using the remote control. If you press a button on the joystick button while watching video, the message <b>Key Lock</b> is displayed.</li></ul>

## OPTION 1 Settings

- 1** Press the **SETTINGS** button.
- 2** Use the **^**, **v**, **<** or **>** button to select **OPTION 1** and press the **OK** button.
- 3** Use the **^**, **v**, **<** or **>** button to set up the desired item and press the **OK** button.
  - To return to the previous menu, press the **↶** button.
- 4** Press the **EXIT** button when completed.

The available option 1 settings are described as follows.

Item	Description	
<b>Language</b>	Selects a desired Menu Language.	
<b>Caption</b>	View subtitles when the TV station provides subtitled programming. Program subtitles work only on digital/analog broadcasts. Change Caption to <b>On</b> and select caption setting.	
	<table border="1"> <tr> <td data-bbox="239 783 384 1171"><b>Mode</b></td> <td data-bbox="384 783 900 1171"> <p><b>CC 1-4 (Closed Captioning) / Text 1-4</b> Displays the audio portion of a TV program as text on the TV screen. <b>CC 1</b> is the most common mode in use.</p> <p>Field 1 data channels: two Captions (<b>CC 1, CC 2</b>), two Text (<b>Text 1, Text 2</b>).</p> <p>Field 2 data channels: two Captions (<b>CC 3, CC 4</b>), two Text (<b>Text 3, Text 4</b>).</p> <p><b>Service1-6</b> This is only available for the digital broadcasting system.</p> </td> </tr> </table>	<b>Mode</b>
<b>Mode</b>	<p><b>CC 1-4 (Closed Captioning) / Text 1-4</b> Displays the audio portion of a TV program as text on the TV screen. <b>CC 1</b> is the most common mode in use.</p> <p>Field 1 data channels: two Captions (<b>CC 1, CC 2</b>), two Text (<b>Text 1, Text 2</b>).</p> <p>Field 2 data channels: two Captions (<b>CC 3, CC 4</b>), two Text (<b>Text 3, Text 4</b>).</p> <p><b>Service1-6</b> This is only available for the digital broadcasting system.</p>	

Item	Description		
<b>Caption</b>	<b>Digital Option</b>	Set up the size and color of the subtitles on <b>Digital Option</b> . Please select <b>Set by Program</b> or <b>Custom</b> . Select <b>Custom</b> to adjust minute options such as the subtitles' size and color.	
		<b>Item</b>	
		<b>Size</b>	Selects the wordsize.
		<b>Font</b>	Selects a typeface for the text.
		<b>Text Color</b>	Selects a color for the text.
		<b>Text Opacity</b>	Adjusts the opacity for the text color.
		<b>Bg Color</b>	Selects a color for the background color.
		<b>Bg Opacity</b>	Adjusts the opacity for the background color.
		<b>Edge Type</b>	Selects an edge type.
<b>Edge Color</b>	Selects a color for the edges.		
<b>Audio Guidance</b>	When this feature is turned on, the projector will read out loud the OSD contents to help you set up the projector menu. <ul style="list-style-type: none"> <li>• This is available only when the language is set to English.</li> </ul>		
	<b>Item</b>		
	<b>Speed</b>	Set the reading speed.	
	<b>Volume</b>	Set the reading volume.	
	<b>Pitch</b>	Set the pitch of the reading voice.	



Item	Description	
<b>3D Mode</b>	Adjusts various aspects of 3D imaging.	
	<b>Mode</b>	
	<table border="1" style="width: 100%;"> <tr> <td data-bbox="239 284 384 363"><b>3D Picture Correction</b></td> <td data-bbox="384 284 898 363">Switches left/right images of 3D video.</td> </tr> </table>	<b>3D Picture Correction</b>
<b>3D Picture Correction</b>	Switches left/right images of 3D video.	
<b>Auto Input Search</b>	Automatically searches for and displays the input signal type when it is received. It is available only with external inputs (RGB-PC, HDMI, AV, and Component).	
<b>Initial Setting</b>	<p>Deletes all optional settings and returns to initial default mode. Once initialization is complete, the projector will turn off and on by itself.</p> <ul style="list-style-type: none"> <li>• When <b>Lock System</b> is in place, a pop-up window appears and asks for password.</li> <li>• Do not turn off the power during initialization.</li> </ul>	
<b>Mode Setting</b>	<p>Selects <b>Standard</b> or <b>Store Demo</b>.</p> <p>When in use in home, please select <b>Standard</b>.</p> <p><b>Store Demo</b> mode is for store display.</p>	

## OPTION 2 Settings

- 1 Press the **SETTINGS** button.
- 2 Use the **^**, **v**, **<** or **>** button to select **OPTION 2** and press the **OK** button.
- 3 Use the **^**, **v**, **<** or **>** button to set up the desired item and press the **OK** button.
  - To return to the previous menu, press the **↶** button.
- 4 Press the **EXIT** button when completed.

The available option 2 settings are described as follows.

Item	Description
<b>Keystone</b>	To prevent the screen image from becoming trapezoidal, Keystone adjusts the top and bottom width of the image if the projector is not set at a right angle to the screen.
<b>Auto Keystone</b>	Auto Keystone provides a rectangular screen image by automatically adjusting the Keystone number when there is a trapezoidal screen image caused by tilting of the projector.
	Item
	<b>On</b> Automatically adjusts the Keystone number.
<b>Off</b> Manually adjusts the Keystone number.	
<b>PJT Mode</b>	<p>This function turns the projected image upside down or flips horizontal.</p> <ul style="list-style-type: none"> <li>• Select <b>Rear</b> when projecting from the back of the transparent screen purchased separately.</li> <li>• Select <b>Front Ceiling</b> when installing the product on the ceiling.</li> <li>• When <b>PJT Mode</b> is <b>Rear/ Front Ceiling</b>, the left/right of the speaker changes automatically.</li> </ul>

Item	Description	
<b>High Altitude</b>	<p>If the projector is used at an altitude higher than 1200 meters (3937 feet), turn this on.</p> <p>Otherwise, the projector may overheat or its protection function may be activated. If this happens, turn the projector off and then on again after waiting for several minutes.</p>	
<b>Blank Image</b>	Selects a background for blank Image.	
<b>Auto Power</b>	<p>Makes the projector turn on automatically when the power cord is connected to the projector. However, battery-equipped models will immediately turn on once the power switch is put to <b>ON</b>.</p>	
	<b>Item</b>	
	<table border="1"> <tr> <td data-bbox="260 644 414 716"><b>On</b></td> <td data-bbox="414 644 899 716">When the projector's power switch is put to <b>ON</b>, the projector turns on.</td> </tr> </table>	<b>On</b>
<b>On</b>	When the projector's power switch is put to <b>ON</b> , the projector turns on.	
<table border="1"> <tr> <td data-bbox="260 716 414 788"><b>Off</b></td> <td data-bbox="414 716 899 788">When the projector's power switch is put to <b>ON</b>, the projector goes into standby mode.</td> </tr> </table>	<b>Off</b>	When the projector's power switch is put to <b>ON</b> , the projector goes into standby mode.
<b>Off</b>	When the projector's power switch is put to <b>ON</b> , the projector goes into standby mode.	
<b>Self Diagnosis</b>	Troubleshoots functional problems that can arise while using the product.	

# CONNECTING DEVICES

You can connect various external devices to the projector.

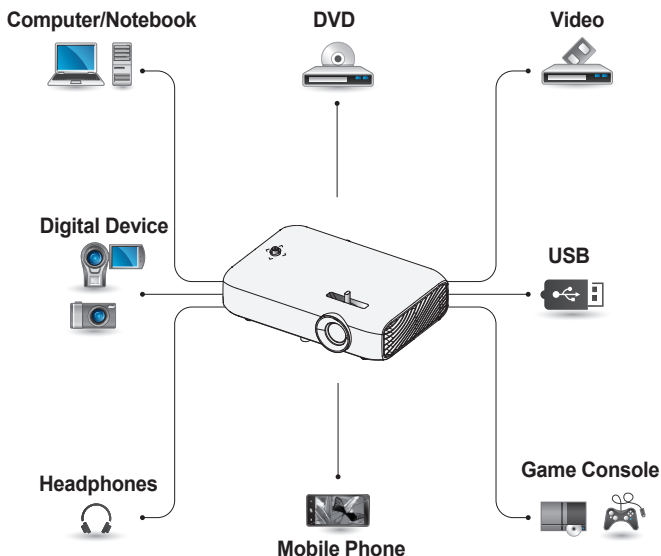

HDMI - page 109

Component - page 110

Composite (AV) - page 110

RGB - page 112

USB Device - page 54

Headphone - page 114

Mobile Phone (MHL/Slimport) - page 115

## Connecting to HD Receiver, DVD, VCR Player, or External Devices

Connect an HD receiver, DVD, VCR player, or External Devices to the projector and select an appropriate input mode.

### HDMI Connection

With an HDMI cable, you can enjoy high quality picture and sound.

Using a HDMI cable, connect the **HDMI (MHL)** port of the projector to the HDMI output port of the device to connect. Both video and audio are output at the same time.

Press the **INPUT** button on the remote control to select **HDMI**.

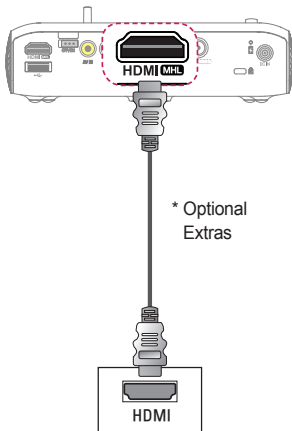

### HDMI to DVI Connection

Using an HDMI to DVI cable, connect the projector's **HDMI (MHL)** port to the DVI OUT port.

To output audio, use an audio cable for connection.

Press the **INPUT** button on the remote control to select **HDMI**.

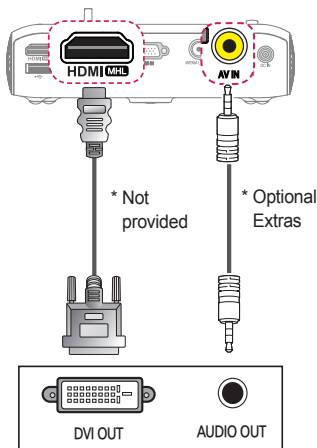

## Composite (AV) Connection

Connect the output ports of an external device and the **AV IN** ports of the projector using an AV cable. Press the **INPUT** button on the remote control to select **AV**. Check whether cables of the same color are connected properly.

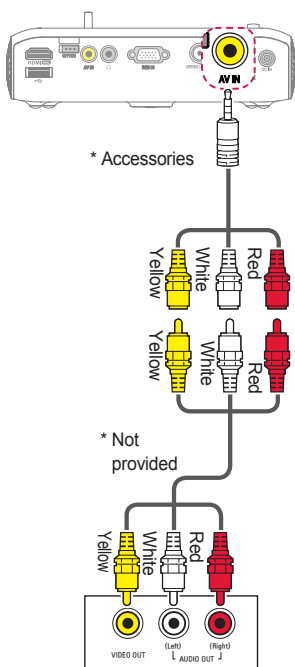

## Component Connection

You can enjoy a video by connecting the Component port of an external device to the **RGB IN** port of the projector. Press the **INPUT** button on the remote control to select **Component**. Check whether cables of the same color are connected properly.

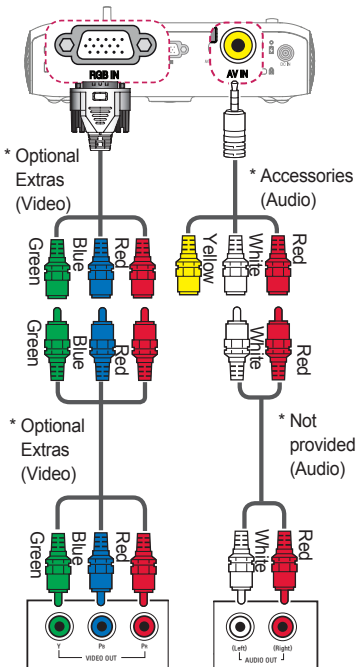

## Connecting a PC

The projector supports Plug and Play. Your PC will automatically detect the projector and requires no driver installation.

### HDMI Connection

Using an HDMI cable, connect the **HDMI (MHL)** port of the projector to the HDMI output port of your PC. Both video and audio are output at the same time.

Press the **INPUT** button on the remote control to select **HDMI**.

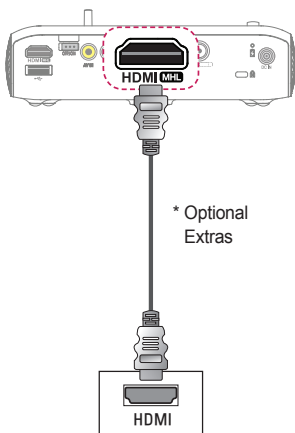

### HDMI to DVI Connection

Using an HDMI to DVI cable, connect the projector's **HDMI (MHL)** port to the DVI OUT port.

To output audio, use an audio cable for connection.

Press the **INPUT** button on the remote control to select **HDMI**.

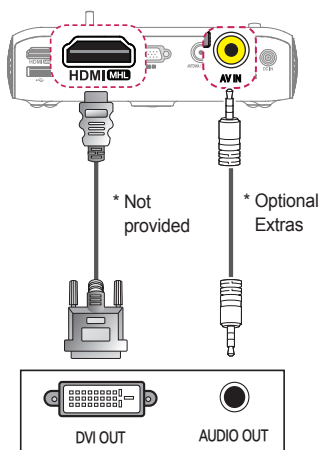

## RGB Connection

Connect the PC output and the PC video input port of the projector with the RGB cable.

For audio signal, connect the PC and the projector with an optional audio cable.

Press the **INPUT** button on the remote control to select **RGB-PC**.

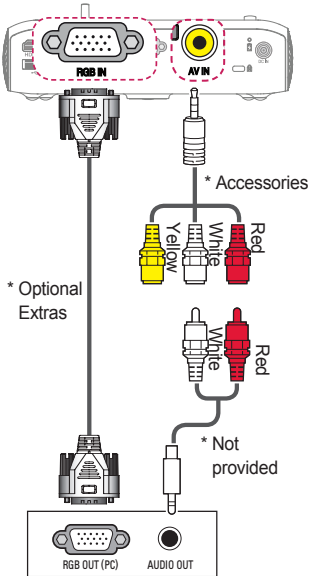

You can connect the audio cable without using a gender as shown in the illustration above.

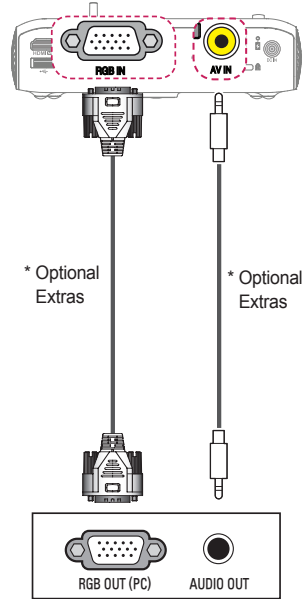



## Connecting a Laptop

You can connect the projector to a laptop to use various functions.

### HDMI Connection

Using an HDMI cable, connect the **HDMI (MHL)** port of the projector to the HDMI output port of your laptop. Both video and audio are output at the same time.

Press the **INPUT** button on the remote control to select **HDMI**.

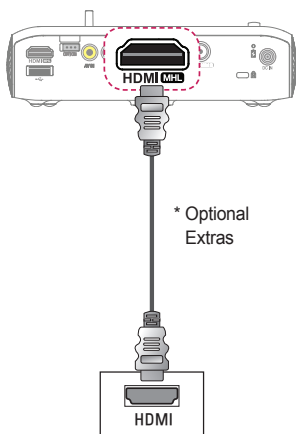

The table below shows examples of switching the output. For more information, refer to the **External Output, Connecting to an External Monitor**, or similar sections of the owner's manual of your computer.

Brand	Switching Output
NEC	Fn + F3
Panasonic	Fn + F3
Toshiba	Fn + F5
IBM	Fn + F7
Sony	Fn + F7
Fujitsu	Fn + F10
LG	Fn + F7
Samsung	Fn + F4
Macintosh	Adjust the control panel to enable mirroring after start-up.

## Connecting to Headphones

You can listen to the audio through a headphone.

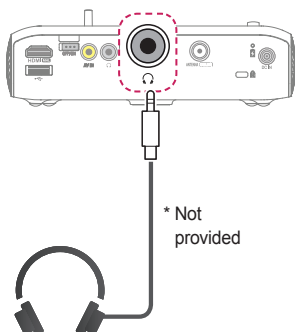

## Using the Mirroring Function of a Mobile Phone

### MHL/Slimport Connection

You must use a HDMI adapter to connect your cell phone to the projector and to output images and sound from your cell phone to the projector. The compatible HDMI adapters are different, depending upon your cell phone type.

Therefore, purchase an appropriate MHL or Slimport adapter.

(To find out whether your device is MHL/Slimport-certified, please contact your device manufacturer.)

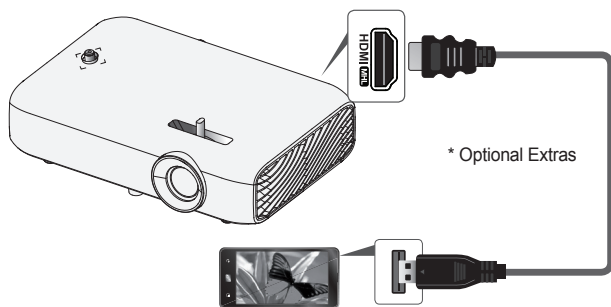

### ! NOTE

- When you connect a mobile phone to the **HDMI (MHL)** port, you can see the mobile phone screen through a projector.
  - This only applies to mobile phones that support MHL/Slimport.
  - You can use the remote control for some applications.
- Disconnect the MHL/Slimport cable from the projector when:
  - The MHL/Slimport function is disabled.
  - Your mobile device is fully charged in standby mode.

# MAINTENANCE

Clean your projector to keep it in optimal condition.

## Cleaning

### Cleaning the Lens

If there is any dust or staining on the lens surface, you must clean the lens. Use an air spray or a cleaning cloth to clean the lens.

To remove dust or stains, use an air spray or apply a small amount of cleaning agent onto a swab or soft cloth to lightly rub the lens.

Please be aware that liquid may flow into the lens if the product is sprayed directly onto the lens.

### Cleaning the Projector Case

To clean the projector case, first unplug the power cord.

To remove dust or stains, use only a dry, lint-free, nonabrasive cloth to polish the lens.

Do not use alcohol, benzene, thinners, or other chemicals, which may damage the case.

# TROUBLESHOOTING

Please check the list below when you experience the following symptoms during use of the product. It may not be a failure.

 <b>Checklist for Safety (please check a long-used projector for safety issues.)</b>
Does your device have any of the following issues?
<ul style="list-style-type: none"><li>• The projector does not display anything on the screen or output sound when it is turned on.</li><li>• The product emits smoke or a burning smell.</li><li>• Water or foreign substances are present inside the product.</li><li>• Part of the projected image is cut out.</li><li>• A strange noise (crackling or sparking sound) regularly occurs from inside the projector.</li><li>• The projector still displays the screen or outputs sound when it is turned off.</li><li>• There are other errors or failures.</li></ul>
In this case, stop using the product.
<ul style="list-style-type: none"><li>• For safety, turn off the power switch and remove the plug from the socket.</li><li>• Contact the place of purchase or authorized service center for product inspection.</li><li>• Do not attempt to repair the product yourself.</li></ul>

**Abnormal behavior**

- There is a colored dot (bright dots, dark dots, stationary dots, and/or flickering dots) on the screen.
  - This projector was produced with high precision technology. However, a tiny dark or bright dot may appear on the screen. This is a common occurrence due to the production process, and it does not indicate a functional failure.
- The remote control may not work properly where a lamp with electronic stabilizer or a three-wavelength lamp is installed.
  - In this case, replace the lamp with electronic stabilizer or the three-wavelength lamp with international standard products to ensure the remote control works properly.

# SPECIFICATIONS

MODEL	PH510P (PH510P-NA)
<b>Resolution (Pixel)</b>	1280 (Horizontal) × 720 (Vertical)
<b>Aspect ratio</b>	16:9 (Horizontal:Vertical)
<b>Projection distance</b> – Video size	0.77 m to 3.08 m (2.5 feet to 10.1 feet) – 63.5 cm to 254.0 cm (25 inches to 100 inches)
<b>Ratio of upward projection</b>	100 %
<b>Working range of the remote control</b>	6 m (19.6 feet)
<b>Video input</b>	NTSC M
<b>Power consumption</b>	55 W
<b>AC-DC Adaptor</b>	Manufacturer: APD Model: DA-65G19
	19.0 V  3.42 A (Adaptor Input 100-240 V @ 50/60 Hz)
<b>Audio Output</b>	1 W + 1 W
<b>Reception type</b>	ATSC / NTSC-M
<b>Reception channels</b>	VHF 2-13, UHF 14-69, CATV 1-135, DTV 2-69, CADTV 1-135
<b>External Antenna Impedance</b>	75 Ω (VHF/ UHF)
<b>Height</b>	44 mm (1.7 inches) (without foot) / 48 mm (1.8 inches) (with foot)
<b>Width</b>	174 mm (6.8 inches)
<b>Depth</b>	116 mm (4.5 inches) (without tuner) / 126 mm (4.9 inches) (with tuner)
<b>Weight</b>	650 g (1.4 lbs)
<b>USB Device</b>	5 V, 0.5 A (Max.)

MODEL	PH510P (PH510P-NA)	
<b>Environment condition</b>	<b>Temperature</b>	
	<b>Operation</b>	0 °C to 40 °C (32 °F to 104 °F)
	<b>Storage</b>	-20 °C to 60 °C (-4 °F to 140 °F)
	<b>Relative Humidity</b>	
	<b>Operation</b>	0 % to 80 %
	<b>Storage</b>	0 % to 85 %

\* Use only power supplies listed in the user instructions.

\* Contents in this manual may be changed without prior notice due to upgrade of product functions.



## Supported RGB-PC/HDMI(PC) Mode

Resolution	Horizontal Frequency (kHz)	Vertical Frequency (Hz)
640 x 350	31.468	70.09
720 x 400	31.469	70.08
640 x 480	31.469	59.94
800 x 600	37.879	60.31
1024 x 768	48.363	60.00
1152 x 864	54.348	60.053
1280 x 720	45	60
1280 x 1024	63.981	60.020
1440 x 900	55.935	59.888
1400 x 1050	65.317	59.979
1600 x 900	60	60
1680 x 1050	65.29	59.954
1920 x 1080	67.5	60

- If an invalid signal is input into the projector, it will not be displayed properly on the screen or a message such as **No Signal** or **Invalid Format** will be displayed.
- The projector supports the DDC1/2B type as the Plug and Play function (Auto-recognition of PC monitor).
- PC synchronization signal types supported: Separate type synchronization.
- In PC mode, 1280 x 720 is recommended for the best picture quality.

## Supported HDMI/DVI-DTV Mode

Resolution	Horizontal Frequency (kHz)	Vertical Frequency (Hz)
480p	31.47	60
	31.47	59.94
	31.50	60
720p	45.00	60.00
	44.96	59.94
1080i	33.75	60.00
	33.72	59.94
1080p	67.500	60
	67.432	59.939
	27.000	24.000
	26.97	23.976
	33.75	30.000
	33.71	29.97

- To provide the best picture quality, a 1280 x 720 (720p) resolution is recommended.

## Component port connecting information

Signal	Component
480i	o
480p	o
720p / 1080i	o
1080p	o (60 Hz only)

### Open Source Software Notice Information







To obtain the source code under GPL, LGPL, MPL, and other open source licenses, that is contained in this product, please visit <http://opensource.lge.com>.

In addition to the source code, all referred license terms, warranty disclaimers and copyright notices are available for download.

LG Electronics will also provide open source code to you on CD-ROM for a charge covering the cost of performing such distribution (such as the cost of media, shipping, and handling) upon email request to [opensource@lge.com](mailto:opensource@lge.com).

This offer is valid for a period of three years after our last shipment of this product. This offer is valid to anyone in receipt of this information.

## SYMBOLS

	Refers to alternating current (AC).
	Refers to direct current (DC).
	Refers to class II equipment.
	Refers to stand-by.
	Refers to "ON" (power).
	Refers to dangerous voltage.

