

# OLYMPUS®

DIGITAL CAMERA

# E-PL6

## Instruction Manual

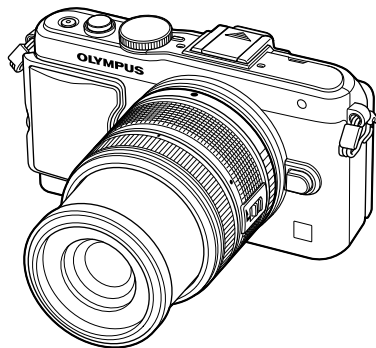

### Table of Contents

#### Quick task index

1. Preparing the camera and flow of operations
2. Basic operations
3. Frequently-used options and customization
4. Printing pictures
5. Connecting the camera to a computer
6. Other
7. Battery and charger
8. Card basics
9. Interchangeable lenses
10. Information/  
Separately sold accessories
11. SAFETY PRECAUTIONS

#### Index

- Thank you for purchasing an Olympus digital camera. Before you start to use your new camera, please read these instructions carefully to enjoy optimum performance and a longer service life. Keep this manual in a safe place for future reference.
- We recommend that you take test shots to get accustomed to your camera before taking important photographs.
- The screen and camera illustrations shown in this manual were produced during the development stages and may differ from the actual product.
- The contents in this manual are based on firmware version 1.0 for this camera. If there are additions and/or modifications of functions due to firmware update for the camera, the contents will differ. For the latest information, please visit the Olympus website.

- This notice concerns the supplied flash unit and is chiefly directed to users in North America.

## Information for Your Safety

# IMPORTANT SAFETY INSTRUCTIONS





When using your photographic equipment, basic safety precautions should always be followed, including the following:

- Read and understand all instructions before using.
- Close supervision is necessary when any flash is used by or near children. Do not leave flash unattended while in use.
- Care must be taken as burns can occur from touching hot parts.
- Do not operate if the flash has been dropped or damaged - until it has been examined by qualified service personnel.
- Let flash cool completely before putting away.
- To reduce the risk of electric shock, do not immerse this flash in water or other liquids.
- To reduce the risk of electric shock, do not disassemble this flash, but take it to qualified service personnel when service or repair work is required. Incorrect reassembly can cause electric shock when the flash is used subsequently.
- The use of an accessory attachment not recommended by the manufacturer may cause a risk of fire, electric shock, or injury to persons.

# SAVE THESE INSTRUCTIONS

### Indications used in this manual

The following symbols are used throughout this manual.

 <b>Cautions</b>	Important information on factors which may lead to a malfunction or operational problems. Also warns of operations that should be absolutely avoided.
 <b>Notes</b>	Points to note when using the camera.
 <b>Tips</b>	Useful information and hints that will help you get the most out of your camera.
	Reference pages describing details or related information.







# Table of Contents

<b>Quick task index</b> .....	<b>6</b>
<b>Preparing the camera and flow of operations</b> .....	<b>8</b>
■ <b>Names of parts</b> .....	<b>8</b>
■ <b>Unpack the box contents</b> .....	<b>10</b>
■ <b>Charging and inserting the battery</b> .....	<b>11</b>
■ <b>Inserting and removing cards</b> ...	<b>12</b>
■ <b>Attaching a lens to the camera</b> .....	<b>13</b>
■ <b>Attaching the flash unit</b> .....	<b>14</b>
■ <b>Power on</b> .....	<b>15</b>
■ <b>Setting the date/time</b> .....	<b>16</b>
■ <b>Shooting</b> .....	<b>17</b>
Setting the Shooting mode .....	17
Taking photographs .....	17
Recording movies.....	19
■ <b>Viewing photographs and movies</b> .....	<b>20</b>
Index display/ Calendar display .....	20
Viewing still images .....	20
Watching movies .....	21
Volume.....	21
Erasing images.....	21
Selecting images .....	21
<b>Basic operations</b> .....	<b>22</b>
■ <b>Basic shooting operations</b> .....	<b>22</b>
Monitor display during shooting .....	22
Switching the information display .....	23
Focus lock .....	23
■ <b>Using the shooting modes</b> .....	<b>24</b>
“Point-and-shoot” photography (P program mode).....	24
Choosing aperture (A aperture-priority mode) .....	25
Choosing shutter speed (S shutter-priority mode) .....	26
Choosing aperture and shutter speed (M manual mode).....	26
Using movie mode (MOV).....	27
Using art filters.....	28
Shooting in scene mode .....	29
■ <b>Using shooting options</b> .....	<b>31</b>
Using live guides .....	31
Controlling exposure (exposure compensation).....	32
Changing the brightness of highlights and shadows .....	32
Using a flash (flash photography).....	33
Choosing a focus target (AF Area) .....	35
Sequential shooting/using the self timer .....	35
Zoom frame AF/zoom AF.....	36
■ <b>Basic playback operations</b> .....	<b>38</b>
Monitor display during playback .....	38
Switching the information display .....	38
Single-frame playback.....	39
Using playback options.....	40
■ <b>Using the touch screen</b> .....	<b>43</b>
Live guides .....	43
Shooting mode .....	43
Playback mode .....	44
Adjusting Settings.....	45

## Frequently-used options and customization

46

- **Using live control** .....46
  - Reducing camera shake (image stabilizer) .....47
  - Processing options (picture mode) .....48
  - Adding effects to a movie .....49
  - Adjusting color (white balance) .....50
  - Setting the image aspect .....51
  - Image quality (record mode).....52
  - Adjusting flash output (flash intensity control).....53
  - Choosing how the camera measures brightness (metering) .....54
  - Choosing a focus mode (AF mode).....55
  - ISO sensitivity .....56
  - Face priority AF/pupil detection AF .....56
  - Movie sound options (recording sound with movies).....57
- **Using the menus** .....58
  - Shooting Menu 1/ Shooting Menu 2 .....59
  - Formatting the card (Card Setup) .....59
  - Restoring default settings (Reset/Myset) .....59
  - Processing options (Picture Mode) .....60
  - Image quality (◀⊞) .....62
  - Setting the self timer (⏏/⌚).....62
  - Varying settings over a series of photographs (bracketing).....62
  - Recording multiple exposures in a single image (multiple exposure) .....64
  - Shooting automatically with a fixed interval (time lapse shooting).....65
- Wireless remote control flash photography.....66
- Digital Zoom (Digital Tele-converter) .....66
- **Playback Menu** .....67
  - Displaying images rotated (⏪).....67
  - Editing still images.....67
  - Canceling all protections .....69
  - Using the Smartphone connection option (Connection to Smartphone) ....70
- **Setup Menu** .....71
  - ⌚ (Date/time setting) .....71
  - ⚙️ (Changing the display language).....71
  - 🔊 (Monitor brightness adjustment).....71
  - Rec View .....71
  - ⚙️/🗨️ Menu Display .....71
  - Firmware.....71
- **Using the custom menus**.....72
  - Before Using the Custom/Accessory Port Menus.....72
  - Custom Menu .....73
    - 📷 AF/MF .....73
    - 📷 Button/Dial .....73
    - 📷 Release/⏏ .....74
    - 📷 Disp/⏏)/PC .....74
    - 📷 Exp/📷/ISO.....76
    - 📷 ⚡ Custom .....77
    - 📷 ⏪-/Color/WB.....77
    - 📷 Record/Erase .....78
    - 📷 Movie .....79
    - 📷 📷 Utility .....79
  - AEL/AFL .....80
  - Button Function .....81
  - Viewing camera images on TV .....82



Choosing the control panel displays (  Control Settings) .....	84	Pixel Mapping - Checking the image processing functions ....	104
Adding information displays (  /Info Settings) .....	86	<b>Battery and charger</b> .....	<b>105</b>
Shutter speeds when the flash fires automatically [  X-Sync.] [  Slow Limit] .....	87	■ <b>Battery and charger</b> .....	<b>105</b>
Adding effects to a movie [Movie Effect] .....	87	■ <b>Using your charger abroad</b> .....	<b>105</b>
■ <b>Accessory Port Menu</b> .....	<b>89</b>	<b>Card basics</b> .....	<b>106</b>
Using OLYMPUS PENPAL .....	89	■ <b>Usable cards</b> .....	<b>106</b>
 OLYMPUS PENPAL Share .....	90	<b>Interchangeable lenses</b> .....	<b>107</b>
 OLYMPUS PENPAL Album .....	91	M.ZUIKO DIGITAL lens specifications .....	107
 Electronic Viewfinder .....	91	<b>Information/Separately sold accessories</b> .....	<b>110</b>
<b>Printing pictures</b> .....	<b>92</b>	■ <b>Record mode and file size/number of storable still pictures</b> .....	<b>110</b>
■ <b>Print reservation (DPOF)</b> .....	<b>92</b>	■ <b>Using separately sold accessories</b> .....	<b>111</b>
Creating a print order .....	92	Electronic Viewfinder (VF-4) ...	111
Removing all or selected pictures from the print order .....	93	Using external flash units designated for use with this camera .....	113
■ <b>Direct printing (PictBridge)</b> .....	<b>93</b>	Wireless remote control flash photography .....	113
Easy printing .....	94	Other external flash units .....	114
Custom printing .....	94	■ <b>Menu directory</b> .....	<b>115</b>
<b>Connecting the camera to a computer</b> .....	<b>96</b>	■ <b>Specifications</b> .....	<b>120</b>
■ <b>Installing the PC software</b> .....	<b>96</b>	■ <b>System chart</b> .....	<b>122</b>
■ <b>Copying pictures to a computer without OLYMPUS Viewer 3</b> .....	<b>98</b>	■ <b>Principal Accessories</b> .....	<b>124</b>
<b>Other</b> .....	<b>99</b>	<b>SAFETY PRECAUTIONS</b> .....	<b>125</b>
■ <b>Shooting tips and information</b> .....	<b>99</b>	■ <b>SAFETY PRECAUTIONS</b> .....	<b>125</b>
■ <b>Error codes</b> .....	<b>101</b>	<b>Index</b> .....	<b>133</b>
■ <b>Cleaning and storing the camera</b> .....	<b>103</b>		
Cleaning the camera .....	103		
Storage .....	103		
Cleaning and checking the image pickup device .....	103		

# Quick task index

## Shooting



Taking pictures with automatic settings	▶ iAUTO ( <b>iAUTO</b> )	17
Easy photography with special effects	▶ Art filter ( <b>ART</b> )	28
Choosing an aspect ratio	▶ Aspect ratio	51
Quickly matching settings to the scene	▶ Scene mode ( <b>SCN</b> )	29
Pro-level photography made simple	▶ Live Guide	31
Adjusting the brightness of a photograph	▶ Exposure compensation	32
Taking pictures with a blurred background	▶ Live Guide	31
	▶ Aperture priority shooting	25
Taking pictures that stop the subject in motion or convey a sense of motion	▶ Live Guide	31
	▶ Shutter priority shooting	26
Taking pictures with the correct color	▶ White balance	50
	▶ One-touch white balance	51
Processing pictures to match the subject/ Taking monotone pictures	▶ Picture Mode	48
	▶ Art filter ( <b>ART</b> )	28
When the camera will not focus on your subject/ Focusing on one area	▶ AF Area	35
	▶ Zoom frame AF/zoom AF	36
Focusing on a small spot in the frame/ confirming focus before shooting	▶ Zoom frame AF/zoom AF	36
	▶ Focus lock	23
Recomposing photographs after focusing	▶ C-AF+TR (AF tracking)	55
	▶  (Beep sound)	75
Taking photos without the flash	▶ ISO/DIS Mode	56/29
Reducing camera shake	▶ Image Stabilizer	47
	▶ Anti-Shock	76
	▶ Self-timer	35
	▶ Remote cable	124
	▶ Flash shooting	33
Taking pictures of a subject against backlight	▶ Gradation (Picture Mode)	61
Photographing fireworks	▶ Bulb/time photography	27
	▶ Scene mode ( <b>SCN</b> )	29
Reducing image noise (mottling)	▶ Noise Reduct.	76
	▶ Gradation (Picture Mode)	61
Taking pictures without white subjects appearing too white or black subjects appearing too dark	▶ Histogram/ Exposure compensation	23/32
	▶ Highlight&Shadow Control	32
	▶ Monitor brightness adjustment	71
Optimizing the monitor/ adjusting monitor hue	▶ Live View Boost	75

Checking set effect before taking a picture	▶ Preview function Test Picture	81 81
Checking horizontal or vertical orientation before shooting	▶ Level gauge	23
Shooting with deliberate composition	▶ Displayed Grid	75
Zooming in on photos to check focus	▶ Auto  (Rec View)	71
	mode2 (  Close Up Mode)	75
Self-portraits	▶ Self-timer	35
Sequential shooting	▶ Sequential shooting	35
Extending the useful life of the battery	▶ Sleep	75
Increasing the number of pictures that can be taken	▶ Record mode	52

## Playback/Retouch



Viewing images on a TV	▶ Playback on TV	82
Viewing slideshows with background music	▶ Slideshow	42
Brightening shadows	▶ Shadow Adj (JPEG Edit)	68
Dealing with red-eye	▶ Redeye Fix (JPEG Edit)	68
Printing made easy	▶ Direct printing	93
Commercial prints	▶ Creating a print order	92
Simple photo sharing	▶ OLYMPUS PENPAL	89
	▶ Connection to Smartphone	70

## Camera Settings



Restoring default settings	▶ Reset	59
Saving the settings	▶ Myset	59
Changing the menu display language	▶ 	71

## Names of parts

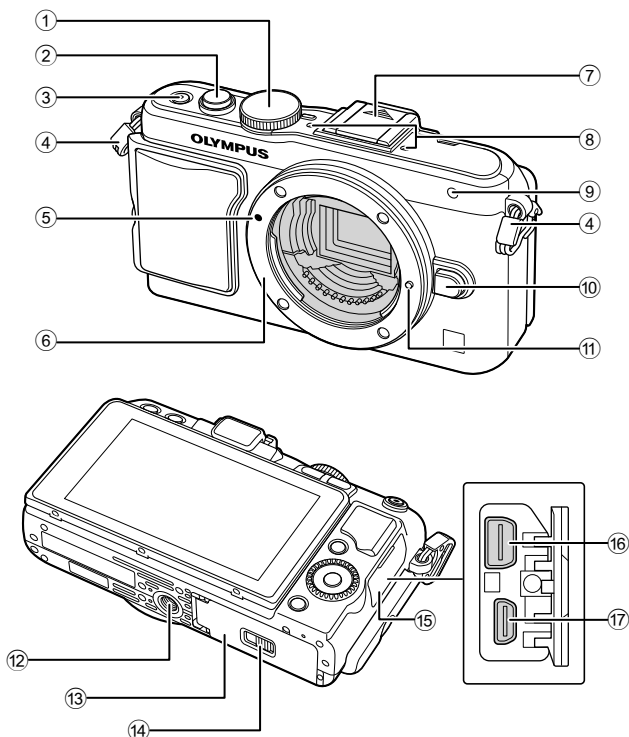

- |  |   |
|--|---|
| ① Mode dial .....P. 17                                   | ⑩ Lens release button .....P. 13            |
| ② Shutter button .....P. 18, 23                          | ⑪ Lens lock pin                             |
| ③ <b>ON/OFF</b> button .....P. 15                        | ⑫ Tripod socket                             |
| ④ Strap eyelet .....P. 10                                | ⑬ Battery/card compartment cover .....P. 11 |
| ⑤ Lens attachment mark .....P. 13                        | ⑭ Battery/card compartment lock .....P. 11  |
| ⑥ Mount (Remove the body cap before attaching the lens.) | ⑮ Connector cover                           |
| ⑦ Hot shoe cover   | ⑯ Multi-connector .....P. 82, 93, 96        |
| ⑧ Stereo microphone .....P. 57, 69                       | ⑰ HDMI micro connector (type D) .....P. 82  |
| ⑨ Self-timer lamp/AF illuminator<br>.....P. 35/P. 73     |   |



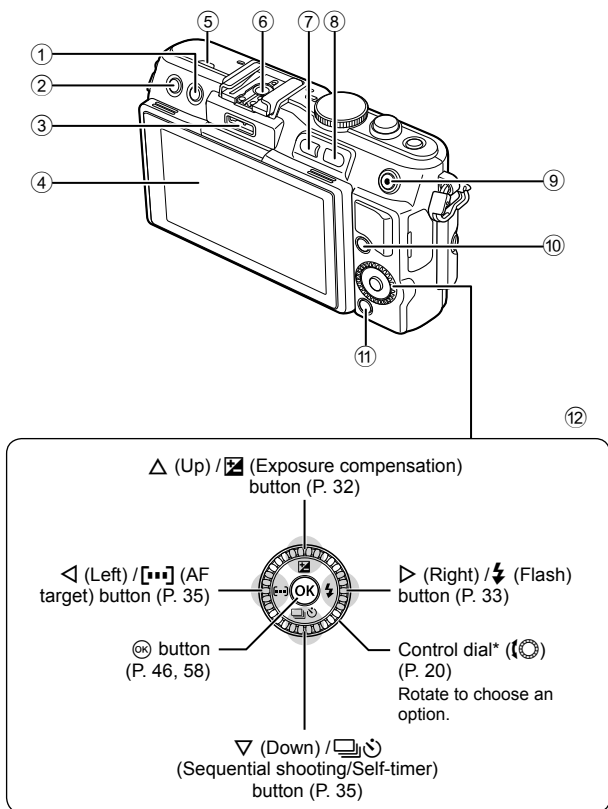

- |  |  |
|--|--|
| ①  (Erase) button .....P. 21               | ⑧  button.....P. 20, 36, 39, 86                                  |
| ②  (Playback) button.....P. 20, 39         | ⑨  /  (Movie) button ..P. 21/P. 19, 21, 81                       |
| ③ Accessory port.....P. 72, 89             | ⑩ <b>INFO</b> (Information display) button<br>.....P. 23, 32, 38 |
| ④ Monitor.....P. 22, 38                    | ⑪ <b>MENU</b> button.....P. 58                                   |
| ⑤ Speaker                                  | ⑫ Arrow pad<br>Control dial* ().....P. 20                        |
| ⑥ Hot shoe .....P. 113                     |  |
| ⑦ <b>Fn</b> /  button .....P. 81/P. 20, 39 |  |

\* In this manual, the icon represents operations performed using the control dial.

## Unpack the box contents

The following items are included with the camera.  
If anything is missing or damaged, contact the dealer from whom you purchased the camera.

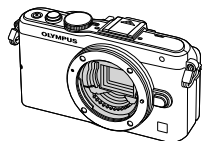

Camera



Body cap



Strap

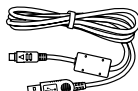

USB cable  
CB-USB6



AV cable  
(Monaural)  
CB-AVC3

- Flash case
- Computer software CD-ROM
- Instruction manual
- Warranty card



Camera  
grip  
MCG-4



Flash  
FL-LM1



Lithium ion  
battery BLS-5

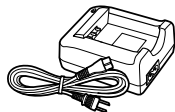

Lithium ion charger  
BCS-5

### Attaching the strap

- 1 Thread the strap in the direction of the arrows.
- 2 Lastly, pull the strap tight making sure that it is fastened securely.

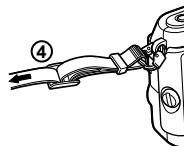
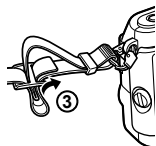
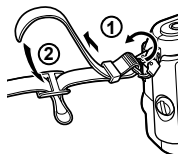

- Attach the other end of the strap to the other eyelet in the same way.

### Attaching the grip

Use a coin or similar object to tighten the screw.

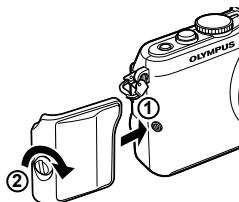

## Charging and inserting the battery

### 1 Charging the battery.

Charging indicator	
	BCS-5
Charging in progress	Lights orange
Charging complete	Off
Charging error	Blinks orange

(Charging time: Up to approximately 3 hours 30 minutes)

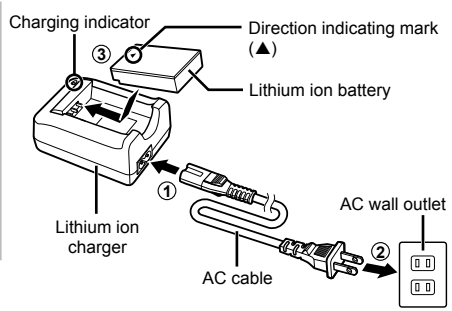

#### ⚠ Cautions

- Unplug the charger when charging is complete.

### 2 Loading the battery.

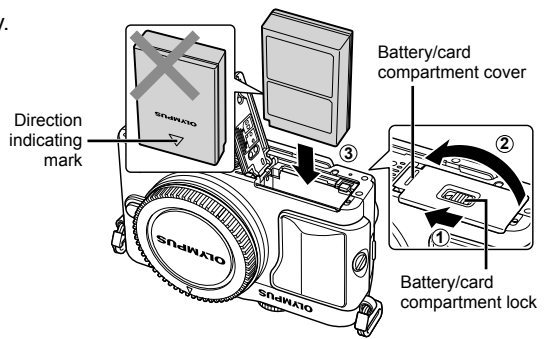

#### Removing the battery

Turn off the camera before opening or closing the battery/card compartment cover. To remove the battery, first push the battery lock knob in the direction of the arrow and then remove.

#### ⚠ Cautions

- Contact an authorized distributor or service center if you are unable to remove the battery. Do not use force.

#### 🔧 Notes

- It is recommended to set aside a backup battery for prolonged shooting in case the battery in use drains.
- Also read "Battery and charger" (P. 105).

## Inserting and removing cards

### 1 Loading the card.

- Slide the card in until it is locked into place.  
 "Card basics" (P. 106)

#### **Cautions**

- Turn off the camera before loading or removing the card.

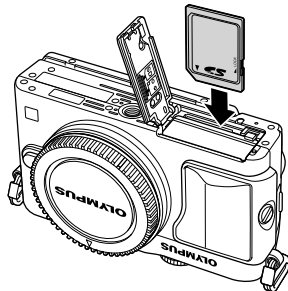

### 2 Closing the battery/card compartment cover.

- Close the cover and slide the battery/card compartment lock in the direction shown by the arrow.

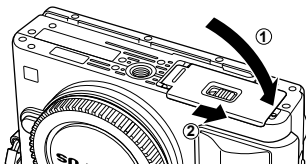

#### **Cautions**

- Be sure the battery/card compartment cover is closed before using the camera.

#### **Removing the card**

Press the inserted card lightly and it will be ejected.  
Pull out the card.

#### **Cautions**

- Do not remove the battery or card while the card write indicator (P. 22) is displayed.

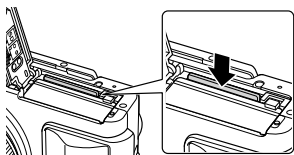

#### **FlashAir and Eye-Fi Cards**

Read "Card basics" (P. 106) before use.

## Attaching a lens to the camera

### 1 Attach a lens to the camera.

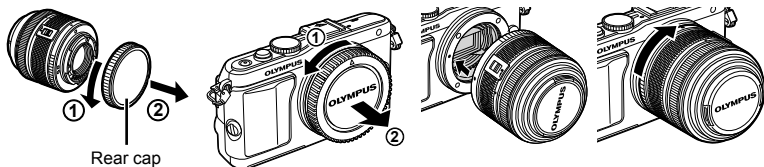

- Align the lens attachment mark (red) on the camera with the alignment mark (red) on the lens, then insert the lens into the camera's body.
- Rotate the lens in the direction indicated by the arrow until you hear it clicks.

### ! Cautions

- Make sure the camera is turned off.
- Do not press the lens release button.
- Do not touch internal portions of the camera.

### 2 Remove the lens cap.

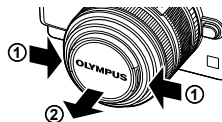

#### Using lenses with an UNLOCK switch

Retractable lenses with an UNLOCK switch cannot be used while retracted. Turn the zoom ring in the direction of arrow (1) to extend the lens (2). To store, turn the zoom ring in the direction of arrow (4) while sliding the UNLOCK switch (3).

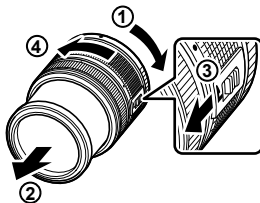

#### Removing the lens from the camera

While pressing the lens release button, rotate the lens in the direction of the arrow.

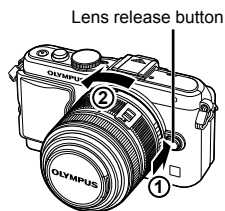

#### Interchangeable lenses

Read "Interchangeable lenses" (P. 107).

## Attaching the flash unit

- 1 Remove the terminal cover from the flash unit and attach the flash to the camera.

- Slide the flash unit all the way in, stopping when it contacts the back of the shoe and is securely in place.

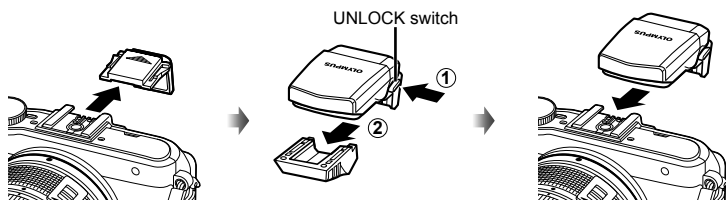

- 2 To use the flash, raise the flash head.

- Lower the flash head when the flash is not in use.

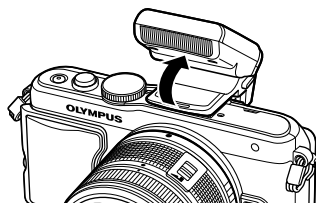

### Removing the flash unit

Press the UNLOCK switch while removing the flash unit.

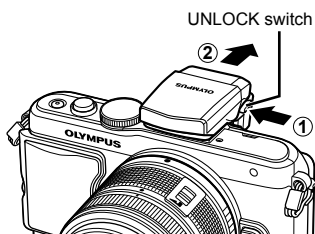

## Power on

### 1 Press the **ON/OFF** button to turn on the camera.

- When the camera is turned on, the (blue) power lamp will light and the monitor will turn on.
- To turn off the power, press the **ON/OFF** button again.

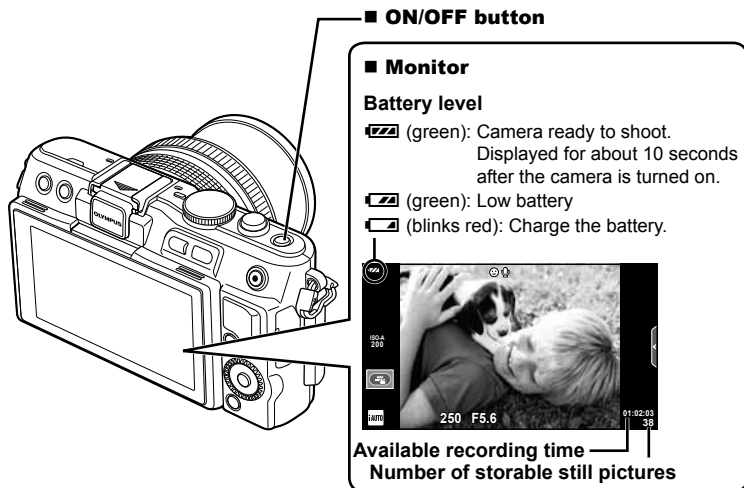

### Using the monitor



You can adjust the angle of the monitor.

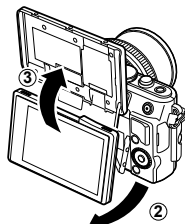
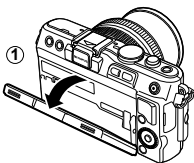

When set to the angle to take your own picture, the monitor display up/down direction inverts.

### Camera sleep operation

If no operations are performed for a minute, the camera enters "sleep" (stand-by) mode to turn off the monitor and to cancel all actions. The camera activates again when you touch any button (the shutter button,  button, etc.). The camera will turn off automatically if left in sleep mode for 5 minutes. Turn the camera on again before use.

## Setting the date/time

Date and time information is recorded on the card together with the images. The file name is also included with the date and time information. Be sure to set the correct date and time before using the camera. Some functions cannot be used if the date has not been set.

### 1 Display the menus.

- Press the **MENU** button to display the menus.

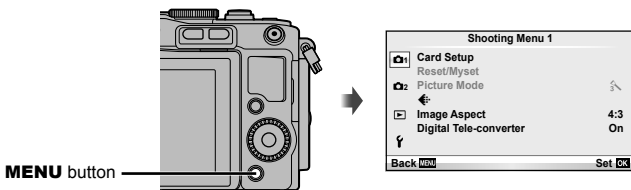

### 2 Select [P] in the [f] (setup) tab.

- Use  $\Delta$   $\nabla$  on the arrow pad to select [f] and press  $\blacktriangleright$ .
- Select [P] and press  $\blacktriangleright$ .

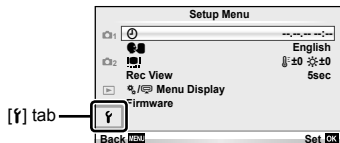

### 3 Set the date and time.

- Use  $\triangleleft$   $\triangleright$  to select items.
- Use  $\Delta$   $\nabla$  to change the selected item.
- Use  $\Delta$   $\nabla$  to select the date format.

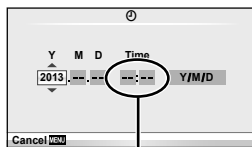

The time is displayed using a 24-hour clock.

### 4 Save settings and exit.

- Press  $\odot$  to set the camera clock and exit to the main menu.
- Press the **MENU** button to exit the menus.



## Shooting

### Setting the Shooting mode

Use the mode dial to select the shooting mode.

Indicator      Mode icon

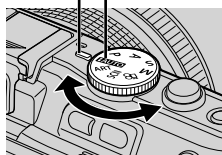

<b>TAUTO</b>	A full auto mode in which the camera automatically optimizes settings for the current scene. The camera does all the work, which is convenient for beginners.
<b>P</b>	Aperture and shutter speed are automatically adjusted for optimal results.
<b>A</b>	You control aperture. You can sharpen or soften background details.
<b>S</b>	You control shutter speed. You can express the motion of moving subjects, or freeze motion without any blur.
<b>M</b>	You control aperture and shutter speed. You can shoot with long exposures for fireworks or other dark scenes.
<b>ART</b>	Select an art filter.
<b>SCN</b>	Select a scene according to the subject.
	Shoot movies using shutter speed and aperture effects and movie special effects.

### Taking photographs

First, try taking photographs in full auto mode.

- 1 Set the mode dial to **TAUTO**.

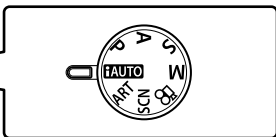
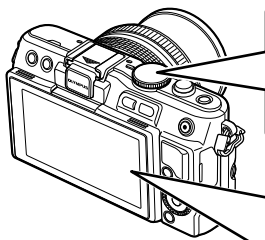

#### ■ Monitor

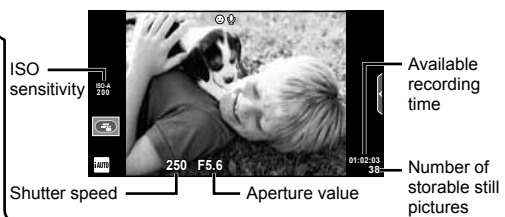

## 2 Frame the shot.

- Be careful that your fingers or the camera strap do not obstruct the lens.

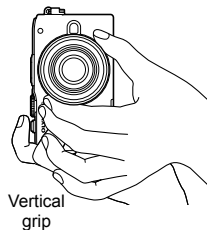
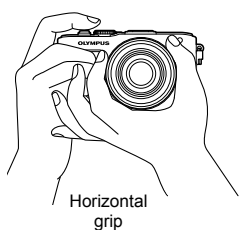

## 3 Adjust the focus.

- Display the subject in the center of the monitor, and lightly press the shutter button down to the first position (press the shutter button halfway).  
The AF confirmation mark (● or ○) will be displayed, and a green frame (AF target) will be displayed in the focus location.

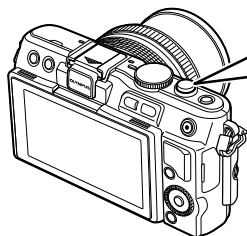

Press the shutter button halfway.

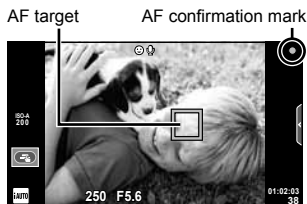

- The ISO sensitivity, shutter speed and aperture value that have been set automatically by the camera are displayed.
- If the AF confirmation mark blinks, the subject is not in focus. (P. 99)

### Pressing the shutter button halfway and all the way down

The shutter button has two positions. The act of lightly pressing the shutter button to the first position and holding it there is called "pressing the shutter button halfway," that of pressing it all the way down to the second position "pressing the shutter button all (or the rest of) the way down."



## 4 Release the shutter.

- Press the shutter button all the way (fully).
- The shutter sounds and the picture is taken.
- The shot image will be displayed on the monitor.

### Notes

- You can also take photographs using the touch screen.  "Using the touch screen" (P. 43)

## Recording movies

You can shoot movies in any shooting mode. First, try shooting in full auto mode.

- 1 Set the mode dial to **FAUTO**.
- 2 Press the **⊙** button to begin recording.

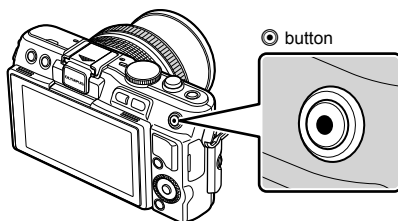

- 3 Press the **⊙** button again to end recording.



Displayed during recording

Recording time

### ! Cautions

- When using a camera with a CMOS image sensor, moving objects may appear distorted due to the rolling shutter phenomenon. This is a physical phenomenon whereby distortion occurs in the filmed image when shooting a fast-moving subject or due to camera shaking. In particular, this phenomenon becomes more noticeable when using a long focal length.
- If the camera is used for extended periods, the temperature of the image pickup device will rise and noise and colored fog may appear in images. Turn off the camera for a short time. Noise and colored fog may also appear in images recorded at high ISO sensitivity settings. If the temperature rises further, the camera will turn off automatically.

### ■ Taking photographs during movie recording

- Press the shutter button during movie recording to pause movie recording and take a photograph. Movie recording restarts after the photograph is taken. Press the **⊙** button to end recording. Three files will be recorded to the memory card: the movie footage preceding the photograph, the photograph itself, and the movie footage following the photograph.
- Only one photograph can be taken at a time during movie recording; the self-timer and flash cannot be used.

### ! Cautions

- Image size and quality for photographs are independent of movie frame size.
- The autofocus and metering used in movie mode may differ from that used to take photographs.
- The **⊙** button cannot be used to record movies in the following instances:  
Multiple exposure (still photography also ends.)/shutter button pressed halfway/during bulb or time photography/sequential shooting/Panorama/3D/time lapse shooting

## Viewing photographs and movies

### 1 Press the button.

- Your most recent photograph or movie will be displayed.
- Rotate the control dial to select the desired photograph or movie.

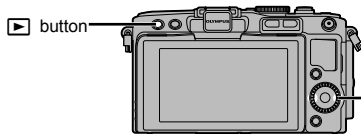

Arrow pad/Control dial

Displays the  
previous  
frame



Displays the  
next frame





Still image



Movie

## Index display/Calendar display

- To view multiple frames, press  during single-frame playback. To start calendar playback, press the  button repeatedly.
- Press the  button to view the currently selected picture full frame.





Index display



Calendar display

## Viewing still images

### Close-up playback

- In single-frame playback, press  to zoom in up to 14x; press  to return to single-frame playback.

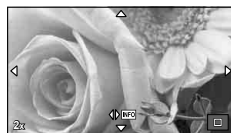

## Watching movies

- Select a movie and press the **OK** button to display the playback menu. Select [Movie Play] and press the **OK** button to begin playback. To interrupt movie playback, press **MENU**.



## Volume

Volume can be adjusted by pressing  $\Delta$  or  $\nabla$  during single-frame and movie playback.



## Erasing images

Display an image you want to delete and press the **Trash** button. Select [Yes] and press the **OK** button.

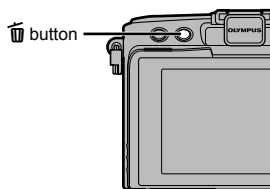

## Selecting images

Select the image. You can also select multiple images for protection or deletion. Press the **Checkmark** button to select an image; a **checkmark** icon will appear on the image. Press the **Checkmark** button again to cancel the selection. Press **OK** to display the delete or protect selection menu.



# 2 Basic operations

## Basic shooting operations

### Monitor display during shooting

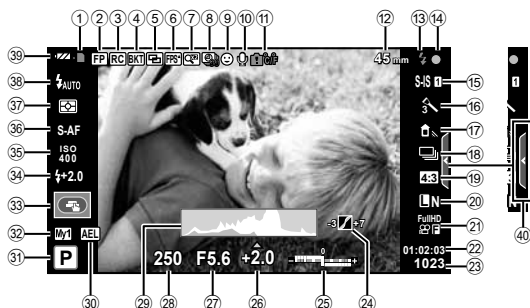

- |   |   |
|---|---|
| ① Card write indicator.....P. 12              | ②④ Highlight&Shadow Control.....P. 32   |
| ② Super FP flash.....P. 113                   | ②⑤ Top: Flash intensity control .....P. 53  |
| ③ RC mode.....P. 113                          | Bottom: Exposure compensation indicator.....P. 32   |
| ④ Auto bracket.....P. 62                      | ②⑥ Exposure compensation value.....P. 32  |
| ⑤ Multiple exposure.....P. 64                 | ②⑦ Aperture value .....P. 24–26   |
| ⑥ High frame rate.....P. 75                   | ②⑧ Shutter speed .....P. 24–26  |
| ⑦ Digital Tele-converter.....P. 66            | ②⑨ Histogram .....P. 23   |
| ⑧ Time lapse shooting.....P. 65               | ③⑩ AE Lock .....P. 73, 81   |
| ⑨ Face priority.....P. 56                     | ③① Shooting mode.....P. 17, 24–30   |
| ⑩ Movie sound .....P. 57                      | ③② Myset.....P. 59  |
| ⑪ Internal temperature warning.....P. 102     | ③③ Shooting using touch screen operations.....P. 43   |
| ⊙Lock ⊙.....P. 74                             | ③④ Flash intensity control.....P. 53  |
| ⑫ Focal length.....P. 109                     | ③⑤ ISO sensitivity.....P. 56  |
| ⑬ Flash.....P. 33                             | (blinks: charging in progress, lights up: charging completed)                                     |
| ⑭ AF confirmation mark.....P. 18              | ③⑥ AF mode.....P. 55  |
| ⑮ Image stabilizer.....P. 47                  | ③⑦ Metering mode.....P. 54  |
| ⑯ Art filter.....P. 28                        | ③⑧ Flash mode.....P. 33   |
| Scene mode.....P. 29                          | ③⑨ Battery check  |
| Picture mode.....P. 48                        | ⏻ Lit up (green) : Ready for use (displayed for about ten seconds after the camera is turned on.) |
| ⑰ White balance.....P. 50                     | ⏻ Lit up (green) : Battery is running low.  |
| ⑱ Sequential shooting/self-timer .....P. 35   | ⏻ Blinks (red) : Charging required  |
| ⑲ Aspect ratio.....P. 51                      | ④⑩ Live guide recall.....P. 31, 43  |
| ⑳ Record mode (still images).....P. 52        |   |
| ㉑ Record mode (movies).....P. 53              |   |
| ㉒ Available recording time                    |   |
| ㉓ Number of storable still pictures ...P. 110 |   |

## Switching the information display

You can switch the information displayed in the monitor during shooting using the **INFO** button.

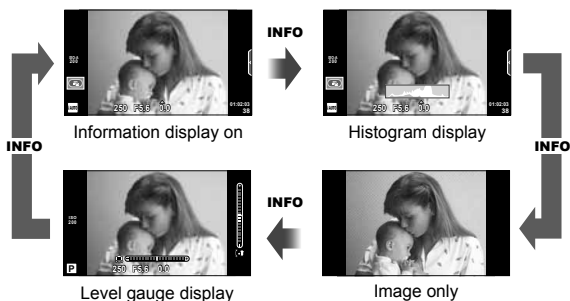

### Histogram display

Display a histogram showing the distribution of brightness in the image. The horizontal axis gives the brightness, the vertical axis the number of pixels of each brightness in the image. Areas above the upper limit at shooting are displayed in red, those below the lower limit in blue, and the area metered using spot metering in green.

### Level gauge display

Indicate the orientation of the camera. The "tilt" direction is indicated on the vertical bar and the "horizon" direction on the horizontal bar. Use the indicators on the level gauge as a guide.

## Focus lock

If the camera is unable to focus on the subject with the desired composition, use focus lock to focus on the subject and then recompose the photograph.

- 1 Position the subject to be focused on in the center of the monitor and press the shutter button halfway.
  - Make sure that the AF confirmation mark is lighting up.
  - Focus locks while the shutter button is pressed halfway.
- 2 Keeping the shutter button pressed halfway, recompose the photograph and then press the shutter button the rest of the way down.
  - Do not change the distance between the camera and the subject while pressing the shutter button halfway.



### Tips

- If the camera is unable to focus on the subject even when using focus lock, use **[AF-ON]** (AF Area). "Choosing a focus target (AF Area)" (P. 35)

## Using the shooting modes

### “Point-and-shoot” photography (P program mode)

In mode **P**, the camera automatically adjusts shutter speed and aperture in response to subject brightness. Set the mode dial to **P**.

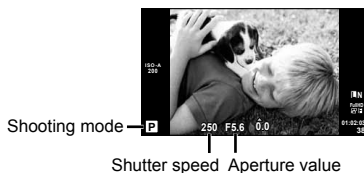

- The shutter speed and aperture selected by the camera are displayed.
- The shutter speed and aperture displays flash if the camera is unable to achieve optimal exposure.

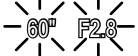
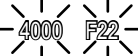
Warning display example (blinking)	Status	Action
	The subject is too dark.	<ul style="list-style-type: none"><li>• Use the flash.</li></ul>
	The subject is too bright.	<ul style="list-style-type: none"><li>• The metered range of the camera is exceeded. A commercially available ND filter (for adjusting the amount of light) is required.</li></ul>

- The aperture value at the moment when its indication blinks varies with the lens type and focal length of the lens.
- When using a fixed [ISO] setting, change the setting.  [ISO] (P. 56)

#### Program shift (Ps)

In **P** and **ART** modes, you can press the  button ( $\Delta$ ) and then use  $\Delta$   $\nabla$  to choose different combinations of aperture and shutter speed without altering exposure. This is known as “program shift.” “s” appears next to the shooting mode during program shift. To cancel program shift, press and hold  $\Delta$   $\nabla$  until “s” is no longer displayed or turn the camera off.



#### ⚠ Cautions

- Program shift is not available when you are using a flash.



## Choosing aperture (A aperture-priority mode)

In mode **A**, you choose the aperture and let the camera automatically adjust shutter speed for optimal exposure. Rotate the mode dial to **A**.

- After pressing the  button ( $\Delta$ ), use  $\Delta$   $\nabla$  to choose the aperture.
- Larger apertures (lower F-numbers) decrease depth of field (the area in front of or behind the focus point that appears to be in focus), softening background details. Smaller apertures (higher F-numbers) increase depth of field.



Aperture value

### Setting the aperture value

Reducing aperture value ← → Increasing aperture value

F2 ← F3.5 ← **F5.6** → F8.0 → F16

- The shutter speed display will blink if the camera is unable to achieve optimal exposure.

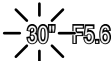
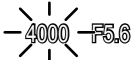
Warning display example (blinking)	Status	Action
 F5.6	The subject is underexposed.	<ul style="list-style-type: none"> <li>• Decrease the aperture value.</li> </ul>
 F5.6	The subject is overexposed.	<ul style="list-style-type: none"> <li>• Increase the aperture value.</li> <li>• If the warning display does not disappear, the metered range of the camera is exceeded. A commercially available ND filter (for adjusting the amount of light) is required.</li> </ul>

- The aperture value at the moment when its indication blinks varies with the lens type and focal length of the lens.
- When using a fixed [ISO] setting, change the setting.  [ISO] (P. 56)

## Choosing shutter speed (S shutter-priority mode)

In mode **S**, you choose the shutter speed and let the camera automatically adjust aperture for optimal exposure. Rotate the mode dial to **S**.

- After pressing the  button ( $\Delta$ ), use  $\Delta$   $\nabla$  to choose the shutter speed.
- A fast shutter speed can freeze a fast action scene without any blur. A slow shutter speed will blur a fast action scene. This blurring will give the impression of dynamic motion.



Shutter speed

### Setting the shutter speed

Slower shutter speed ←

→ Faster shutter speed

2" ← 1" ← 15 ← **60** → 100 → 400 → 1000

- The aperture value display will blink if the camera is unable to achieve optimal exposure.

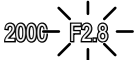
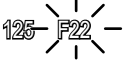
Warning display example (blinking)	Status	Action
	The subject is underexposed.	<ul style="list-style-type: none"> <li>• Set the shutter speed slower.</li> </ul>
	The subject is overexposed.	<ul style="list-style-type: none"> <li>• Set the shutter speed faster.</li> <li>• If the warning display does not disappear, the metered range of the camera is exceeded. A commercially available ND filter (for adjusting the amount of light) is required.</li> </ul>

- The aperture value at the moment when its indication blinks varies with the lens type and focal length of the lens.
- When using a fixed [ISO] setting, change the setting.  [ISO] (P. 56)

## Choosing aperture and shutter speed (M manual mode)

In mode **M**, you choose both the aperture and the shutter speed. At a speed of BULB, the shutter remains open while the shutter button is pressed. Set the mode dial to **M**, press the  button ( $\Delta$ ), and use  $\Delta$   $\nabla$  to adjust the shutter speed and  $\langle \rangle$  to adjust the aperture value.

- Shutter speed can be set to values between 1/4000 and 60 seconds or to [BULB] or [LIVE TIME].

### Cautions

- Exposure compensation is not available in **M** mode.

### Choosing when the exposure ends (bulb/time photography)

Use for night landscapes and fireworks. Shutter speeds of [BULB] and [LIVE TIME] are available in mode **M**.

**Bulb photography (BULB):** The shutter remains open while the shutter button is pressed. The exposure ends when the shutter button is released.

**Time photography (TIME):** The exposure begins when the shutter button is pressed all the way down. To end the exposure, press the shutter button all the way down again.

When using [LIVE TIME], the progress of the exposure will be displayed in the monitor during shooting. The display can also be refreshed by pressing the shutter button halfway. In addition, [Live BULB] can be used to display the image exposure during bulb photography.  "Using the custom menus" (P. 72)

### **Cautions**

- ISO sensitivity can be set to a value up to ISO 1600 for live bulb and live time photography.
- To reduce camera blur during long exposures, mount the camera on a tripod and use a remote cable (P. 124).
- The following features are not available during long exposures:  
Sequential shooting/self-timer shooting/AE bracket shooting/image stabilizer/  
flash bracketing/multiple exposure\*  
\* An option other than [Off] is selected for [Live BULB] or [Live TIME].



### **Noise in images**

While shooting at slow shutter speeds, noise may appear on screen. These phenomena occur when the temperature rises in the image pickup device or image pickup device internal drive circuit, causing current to be generated in those sections of the image pickup device that are not normally exposed to light. This can also occur when shooting with a high ISO setting in a high-temperature environment. To reduce this noise, the camera activates the noise reduction function.  [Noise Reduct.] (P. 76)

### Using movie mode ()

Movie mode () can be used to film movies with special effects.

You can create movies that take advantage of the effects available in still photography mode. Use live control to select the settings.  "Adding effects to a movie [Movie Effect]" (P. 87)

You can also apply an after-image effect or zoom in on an area of the image during movie recording. [Movie Effect] in the custom menu must be set to [On] before making these settings.   Movie] (P. 79)

## Using art filters

### 1 Rotate the mode dial to **ART**.

- A menu of art filters will be displayed. Select a filter using  $\Delta$   $\nabla$ .
- Press  $\text{OK}$  or press the shutter button halfway to select the highlighted item and exit the art filter menu.



### ■ Types of art filters

Pop Art	Cross Process
Soft Focus	Gentle Sepia
Pale&Light Color	Dramatic Tone
Light Tone	Key Line
Grainy Film	Watercolor
Pin Hole	ART BKT (ART bracketing)
Diorama	

### 2 Shoot.

- To choose a different setting, press  $\text{OK}$  to display the art filter menu.

#### **ART bracketing**

Each time the shutter is released, the camera creates copies for all art filters. Use the  $[\text{MENU} \rightarrow]$  option to choose filters.

#### **Art effects**

Art filters can be modified and effects can be added. Pressing  $\triangleright$  in the art filter menu displays additional options.

#### **Modifying filters**

Option I is the original filter, while options II and on add effects that modify the original filter.

#### **Adding effects\***

Soft focus, pin-hole, frames, white edges, starlight, filter, tone

\* The effects available vary with the selected filter.

### **!** Cautions

- If [RAW] is currently selected for image quality, image quality will automatically be set to [I/N+RAW]. The art filter will be applied to the JPEG copy only.
- Depending on the subject, tone transitions may be ragged, the effect may be less noticeable, or the image may become more "grainy."
- Some effects may not be visible in live view or during movie recording.
- Playback may differ according to the filters, effects, or movie quality settings applied.

## Shooting in scene mode

### 1 Rotate the mode dial to **SCN**.

- A menu of scene menu will be displayed. Select a scene using  $\Delta$   $\nabla$ .
- Press  $\odot$  or press the shutter button halfway to select the highlighted item and exit the scene menu.



### ■ Types of scene modes

- |                    |                  |
|--------------------|------------------|
| Portrait           | Nature Macro     |
| e-Portrait         | Candle           |
| Landscape          | Sunset           |
| Landscape+Portrait | Documents        |
| Sport              | Panorama (P. 30) |
| Night Scene        | Fireworks        |
| Night+Portrait     | Beach & Snow     |
| Children           | Fisheye Effect   |
| HT High Key        | Wide-Angle       |
| LOW Low Key        | Macro            |
| DIS Mode           | 3D Photo         |
| Macro              |                  |

### 2 Shoot.

- To choose a different setting, press  $\odot$  to display the scene menu.

### ! Cautions

- In [e-Portrait] mode, two images are recorded: an unmodified image and a second image to which [e-Portrait] effects have been applied.  
Recording may take some time.
- [ Fisheye Effect], [ Wide-Angle], and [ Macro] are for use with optional converter lenses.
- Movies cannot be recorded in [e-Portrait], [Panorama], or [3D Photo] mode.
- [3D Photo] is subject to the following limitations.  
[3D Photo] can be used only with a 3D lens.  
The camera monitor cannot be used to playback images in 3D. Use a device that supports 3D display.  
Focus is locked. In addition, flash and self-timer also cannot be used.  
Image size is fixed at 1920 × 1080.  
RAW photography is not available.  
Frame coverage is not 100%.

## Taking panoramas

If you have installed the supplied computer software, you can use it to join pictures together to form a panorama. For more information, see "Connecting the camera to a computer" (P. 96).

- 1 Rotate the mode dial to **SCN**.

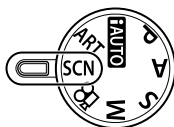

- 2 Select [Panorama] and press  $\odot$ .
- 3 Use  $\Delta$   $\nabla$   $\triangleleft$   $\triangleright$  to choose a pan direction.
- 4 Take a picture, using the guides to frame the shot.
  - Focus, exposure, and other settings are fixed at the values for the first shot.



- 5 Take the remaining images, framing each shot so that the guides overlap with the previous picture.

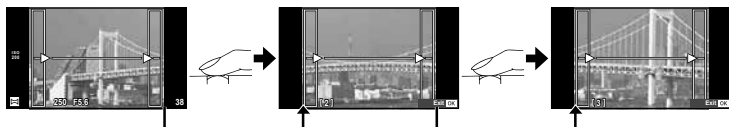

- A panorama may include up to 10 images. A warning indicator ( $\square$ ) is displayed after the tenth shot.

- 6 After taking the last shot, press  $\odot$  to end the series.

### ! Cautions

- During panorama shooting, the image previously taken for position alignment will not be displayed. With the frames or other markers for display in the images as a guide, set the composition such that the edges of the overlapping images overlap within the frames.

### 📝 Notes

- Pressing  $\odot$  before shooting the first frame returns to the scene mode selection menu.
- Pressing  $\odot$  in the midst of shooting ends the sequence of panorama shooting, and allows you to continue with the next one.

## Using shooting options

### Using live guides

Live guides are available in iAUTO (iAUTO) mode. While iAUTO is a full auto mode, live guides make it easy to access a variety of advanced photographic techniques.

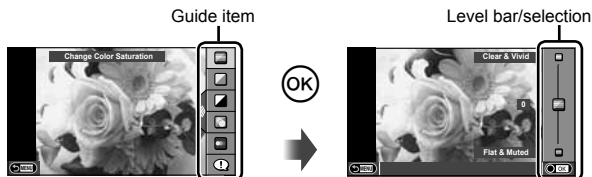

- 1 Set the mode dial to **iAUTO**.
- 2 After pressing the **Fn** button or **OK** to display the live guide, use the  $\Delta$   $\nabla$  buttons on the arrow pad to highlight an item and press **OK** to select.
- 3 Use  $\Delta$   $\nabla$  to choose the level.
  - If [Shooting Tips] is selected, highlight an item and press **OK** to view a description.
  - Press the shutter button halfway to select.
  - The effect of the selected level is visible in the display. If [Blur Background] or [Express Motions] is selected, the display will return to normal, but the selected effect will be visible in the final photograph.
- 4 Shoot.
  - Press the shutter button to shoot.
  - To clear the live guide from the display, press the **MENU** button.

#### **!** Cautions

- Live guides are not available when [Panorama] or [3D Photo] is selected in **SCN** mode.
- If [RAW] is currently selected for image quality, image quality will automatically be set to [L+RAW].
- Live guide settings are not applied to the RAW copy.
- Pictures may appear grainy at some live guide setting levels.
- Changes to live guide setting levels may not be visible in the monitor.
- Frame rates drop when [Blurred Motion] is selected.
- The flash cannot be used with the live guide.
- Changes to live guide options cancel previous changes.
- Choosing live guide settings that exceed the limits of the camera exposure meters may result in pictures that are over or underexposed.

#### **💡** Tips

- In modes other than **iAUTO**, you can use live control to make more detailed settings.  
**👉** "Using live control" (P. 46)

## Controlling exposure (exposure compensation)

Press the  button ( $\Delta$ ) and use  $\triangleleft$ / $\triangleright$  to adjust exposure compensation. Choose positive (“+”) values to make pictures brighter, negative (“-”) values to make pictures darker. Exposure can be adjusted by  $\pm 3.0$ EV.



### ! Cautions

- Exposure compensation is not available in **FAUTO**, **M**, or **SCN** mode.

## Changing the brightness of highlights and shadows

To display the tone control dialog, press the  button ( $\Delta$ ) and press the **INFO** button. Use  $\triangleleft$ / $\triangleright$  to choose a tone level. Choose “low” to darken shadows or “high” to brighten highlights.

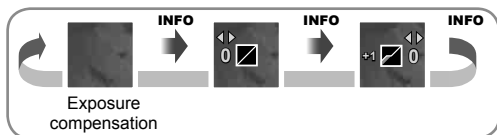





## Using a flash (flash photography)

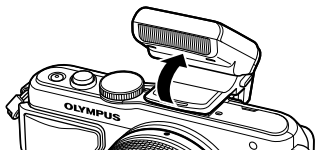

The flash can be set manually as required. The flash can be used for flash photography in a variety of shooting conditions.

- 1 Attach the flash unit and raise the flash head.









-  "Attaching the flash unit" (P. 14)



- 2 Press the  button () to display options.



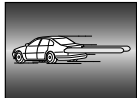



- 3 Use   to choose a flash mode and press .

- The options available and the order in which they are displayed vary depending on the shooting mode.  "Flash modes that can be set by shooting mode" (P. 34)











 <b>AUTO</b>	<b>Auto flash</b>	The flash fires automatically in low light or backlight conditions.
	<b>Fill-in flash</b>	The flash fires regardless of the light conditions.
	<b>Flash off</b>	The flash does not fire.
	<b>Red-eye reduction flash</b>	This function allows you to reduce the red-eye phenomenon. In <b>S</b> and <b>M</b> modes, the flash always fires.
 <b>SLOW</b>	<b>Slow synchronization (1st curtain)</b>	Slow shutter speeds are used to brighten dimly-lit backgrounds.
 <b>SLOW</b>	<b>Slow synchronization (1st curtain)/Red-eye reduction flash</b>	Combines slow synchronization with red-eye reduction.
 <b>SLOW2/2nd Curtain</b>	<b>Slow synchronization (2nd curtain)</b>	The flash fires just before the shutter closes to create trails of light behind moving light sources. 
 <b>FULL,</b>  <b>1/4 etc.</b>	<b>Manual</b>	For users who prefer manual operation. If you press the <b>INFO</b> button, you can use the dial to adjust the flash level.



- 4 Press the shutter button all the way.

### Cautions

- In [   (Red-eye reduction flash)], after the pre-flashes, it takes about 1 second before the shutter is released. Do not move the camera until shooting is complete.
- [   (Red-eye reduction flash)] may not work effectively under some shooting conditions.
- When the flash fires, the shutter speed is set to 1/250 sec. or slower. When shooting a subject against a bright background with the fill-in flash, the background may be overexposed.

## Flash modes that can be set by shooting mode

Shooting mode	LV super control panel	Flash mode	Flash timing	Conditions for firing the flash	Shutter speed limit
P/A	 <b>AUTO</b>	Auto flash	1st curtain	Fires automatically in dark/backlit conditions	1/30 sec. – 1/250 sec.*
		Auto flash (red-eye reduction)			
		Fill-in flash			
		Flash off	—	—	—
	 <b>SLOW</b>	Slow synchronization (red-eye reduction)	1st curtain	Fires automatically in dark/backlit conditions	60 sec. – 1/250 sec.*
	 <b>SLOW</b>	Slow synchronization (1st curtain)			
	 <b>SLOW2</b>	Slow synchronization (2nd curtain)	2nd curtain		
S/M		Fill-in flash	1st curtain		
		Fill-in flash (red-eye reduction)			
		Flash off	—	—	—
	 <b>2nd-C</b>	Fill-in flash/Slow synchronization (2nd curtain)	2nd curtain	Always fires	60 sec. – 1/250 sec.*

-  **AUTO**,  can be set in **AUTO** mode.
- \* 1/200 sec. when using an separately sold external flash unit

**Minimum range**

The lens may cast shadows over objects close to the camera, causing vignetting, or be too bright even at minimum output.

Lens	Approximate distance at which vignetting occurs
14–42 mm	1.0 m
17 mm	0.25 m
40–150 mm	1.0 m
14–150 mm	Flash cannot be used
12–50 mm	Flash cannot be used

- External flash units can be used to prevent vignetting. To prevent photographs from being overexposed, select mode **A** or **M** and choose a high f-number, or reduce ISO sensitivity.

## Choosing a focus target (AF Area)

Choose which of the 35 autofocus targets will be used for autofocus.

- 1 Press the  button ( $\triangleleft$ ) to display the AF target.
- 2 Use  $\triangle \nabla \triangleleft \triangleright$  to select the single target display and position the AF target.
  - "All targets" mode is restored if you move the cursor off the screen.
  - You can choose from the following 4 target types. Press the **INFO** button and use  $\triangle \nabla$ .

All Targets

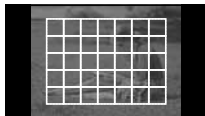

The camera automatically chooses from the full set of focus targets.

Single Target  
(Standard size,  
small size)

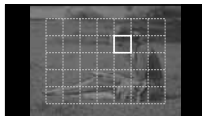

Select the focus target manually. Set the target size to [·]s (small) to further limit the focus position.



Group Target









The camera automatically chooses from the targets in the selected group.

## Sequential shooting/using the self timer

Keep the shutter button pressed all the way down to take a series of photos. Alternatively, you can take pictures using the self timer.

- 1 Press the  button ( $\nabla$ ) to display the direct menu.
- 2 Select an option using  $\triangleleft \triangleright$  and press .

	<b>Single-frame shooting</b>	Shoots 1 frame at a time when the shutter button is pressed (normal shooting mode).
	<b>Sequential H</b>	Photographs are taken at about 8 frames per second (fps) while the shutter button is pressed all the way down.
	<b>Sequential L</b>	Photographs are taken at about 3.5 frames per second (fps) while the shutter button is pressed all the way down.
	<b>Self-timer 12 SEC</b>	Press the shutter button halfway to focus, the rest of the way down to start the timer. First, the self-timer lamp lights up for approximately 10 seconds, then it blinks for approximately 2 seconds and the picture is taken.
	<b>Self-timer 2 SEC</b>	Press the shutter button halfway to focus, the rest of the way down to start the timer. The self-timer lamp blinks for approximately 2 seconds, and then the picture is taken.
	<b>Self-timer Custom</b>	Set the number of frames to be shot. Select  , press the <b>INFO</b> button, and rotate the dial.

### Notes

- To cancel the activated self-timer, press the  (∇) button.
- In [S-AF] and [MF] focus modes, focus and exposure will be fixed at the values for the first frame in each sequence.

### Cautions

- During sequential shooting, if the battery check blinks due to low battery, the camera stops shooting and starts saving the pictures you have taken on the card. The camera may not save all of the pictures depending on how much battery power remains.
- Fix the camera securely on a tripod for self-timer shooting.
- If you stand in front of the camera to press the shutter button halfway when using the self-timer, the photograph may be out of focus.

## Zoom frame AF/zoom AF

You can zoom in on a portion of the frame when adjusting focus. Choosing a high zoom ratio allows you to use autofocus to focus on a smaller area than is normally covered by the AF target. You can also position the focus target more precisely.

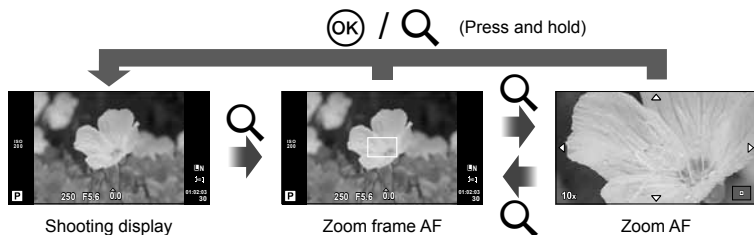

- 1 Press the **Q** button to display the zoom frame.
  - If the camera was focused using autofocus just before the button was pressed, the zoom frame will be displayed at the current focus position.
  - Use  $\Delta \nabla \triangleleft \triangleright$  to position the zoom frame.
  - Press the **INFO** button and use  $\Delta \nabla$  to choose the zoom ratio.

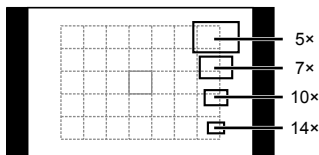

Comparison of AF and zoom frames

- 2 Press the **Q** button again to zoom in on the zoom frame.
  - Use  $\Delta \nabla \triangleleft \triangleright$  to position the zoom frame.
  - Rotate the control dial to choose the zoom ratio.
- 3 Press the shutter button halfway to initiate autofocus.

#### **Notes**

- Autofocus is available and pictures can be taken both when the zoom frame is displayed and when the view through the lens is zoomed in. You can also perform AF operation with the view through the lens zoomed in.  "LV Close Up Mode" (P. 75)
- You can also display and move the zoom frame using touch screen operations.

#### **Cautions**

- Zoom is visible only in the monitor and has no effect on the resulting photographs.

## Basic playback operations

### Monitor display during playback

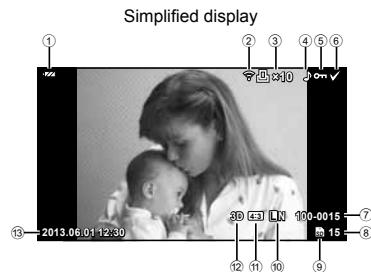

- ① Battery check ..... P. 15
- ② Eye-Fi upload complete ..... P. 80
- ③ Print reservation  
Number of prints ..... P. 92
- ④ Sound record ..... P. 41
- ⑤ Protect ..... P. 41
- ⑥ Image selected ..... P. 21
- ⑦ File number ..... P. 78
- ⑧ Frame number
- ⑨ Storage device ..... P. 106
- ⑩ Record mode ..... P. 52
- ⑪ Aspect ratio ..... P. 51, 68
- ⑫ 3D image ..... P. 29
- ⑬ Date and time ..... P. 16
- ⑭ Aspect border ..... P. 51
- ⑮ AF target ..... P. 35

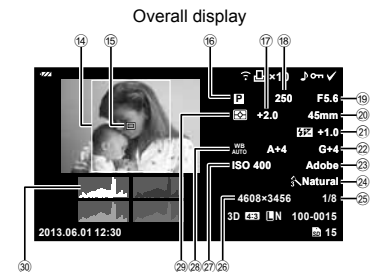

- ⑯ Shooting mode ..... P. 17, 24–30
- ⑰ Exposure compensation ..... P. 32
- ⑱ Shutter speed ..... P. 24–26
- ⑲ Aperture value ..... P. 24–26
- ⑳ Focal length ..... P. 109
- ㉑ Flash intensity control ..... P. 53
- ㉒ White balance compensation ..... P. 50
- ㉓ Color space ..... P. 78
- ㉔ Picture mode ..... P. 48
- ㉕ Compression rate ..... P. 52
- ㉖ Pixel count ..... P. 52
- ㉗ ISO sensitivity ..... P. 56
- ㉘ White balance ..... P. 50
- ㉙ Metering mode ..... P. 54
- ㉚ Histogram ..... P. 23

### Switching the information display

You can switch the information displayed in the monitor during playback using the **INFO** button.

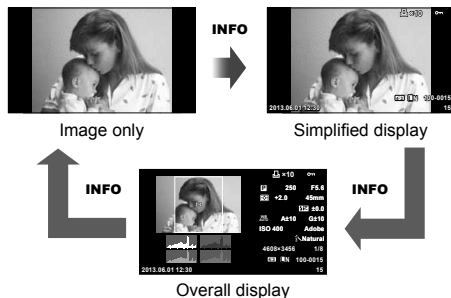

## Single-frame playback



Press the  button to view pictures full frame. Press the shutter button halfway to return to shooting mode.

### Index display/calendar display

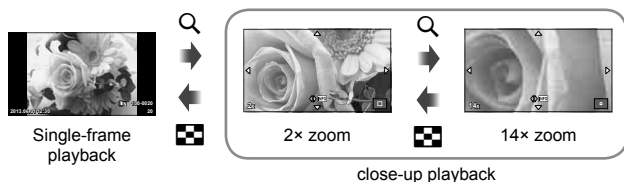

### Playback zoom (close-up playback)



<b>Control dial</b> (t/next)	Previous (t/next)
<b>Arrow pad</b> (Δ ∇ ◀ ▶)	Single-frame playback: Next (▶)/previous (◀)/playback volume (Δ ∇) Close-up playback: Scroll image You can display the next frame (▶) or the previous frame (◀) during close-up playback by pressing the <b>INFO</b> button. Index/calendar playback: Highlight image
<b>INFO</b>	View image info
	Select picture (P. 21)
	Delete picture (P. 21)
	View menus (in calendar playback, press this button to exit to single-frame playback)

## Using playback options

Press **OK** during playback to display a menu of simple options that can be used in playback mode.

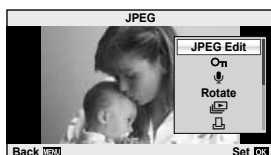

	Still image frame	Movie frame
JPEG Edit, RAW Data Edit  P. 67, 68	✓	—
Image Overlay  P. 69	✓	—
Movie Play	—	✓
(Protect)	✓	✓
(Audio recording)	✓	—
Rotate	✓	—
(Slideshow)	✓	✓
Erase	✓	✓

### Performing operations on a movie frame (Movie Play)

<b>OK</b>	Pause or resume playback.	
	• You can perform the following operations while playback is paused.	
	<b>&lt;D&gt; or Control dial</b>	Previous/Next Press and hold <D> to continue the operation.
	▲	Display the first frame.
	▼	Display the last frame.
<b>&lt;/&gt;</b>	Advance or rewind a movie.	
<b>▲/▼</b>	Adjust volume.	

### **Cautions**

- We recommend using the supplied PC software to play movies on a computer. Before launching the software for the first time, connect the camera to the computer.



## Protecting images

Protect images from accidental deletion. Display an image you wish to protect and press **OK** to display the playback menu. Select [**Protect**] and press **OK**, and then press **△** to protect the image. Protected images are shown by a **Protect** icon. Press **▽** to remove protection.

You can also protect multiple selected images. **☞** “Selecting images” (P. 21)



## ! Cautions

- Formatting the card erases all images even if they have been protected.

## Audio recording

Add an audio recording (up to 30sec. long) to the current photograph.

- 1 Display the image to which you want to add an audio recording and press **OK**.
  - Audio recording is not available with protected images.
  - Audio recording is also available in the playback menu.
- 2 Select [**Microphone**] and press **OK**.
  - To exit without adding a recording, select [No].
- 3 Select [**Microphone Start**] and press **OK** to begin recording.
  - To stop recording part-way through, press **OK**.
- 4 Press **OK** to end recording.
  - Images with audio recordings are indicated by a **Microphone** icon.
  - To delete a recording, select [Erase] in Step 2.



## Rotate

Choose whether to rotate photographs.

- 1 Play the photograph back and press **OK**.
- 2 Select [Rotate] and press **OK**.
- 3 Press **△** to rotate the image counterclockwise, **▽** to rotate it clockwise; the image rotates each time the button is pressed.
  - Press **OK** to save settings and exit.
  - The rotated image is saved in its current orientation.
  - Movies, 3D photos, and protected images cannot be rotated.

## Slideshow

This function displays images stored on the card one after another.

- 1 Press **OK** during playback and select **[▶]**.



- 2 Adjust settings.

<b>Start</b>	Start the slideshow. Images are displayed in order, starting with the current picture.
<b>BGM</b>	Set BGM (4 types) or turn BGM [Off].
<b>Effect*</b>	Choose the transition effect between frames.
<b>Slide</b>	Set type of slideshow to execute.
<b>Slide Interval</b>	Choose the length of time each slide is displayed from 2 to 10 seconds.
<b>Movie Interval</b>	Select [Full] to include full-length movie clips in the slideshow, [Short] to include only the opening portion of each clip.

\* Movies are not displayed when an effect other than [Fade] is selected.

- 3 Select [Start] and press **OK**.
  - The slideshow will start.
  - Press **OK** to stop the slideshow.

### Volume

Press **Δ**/**▽** during the slideshow to adjust the overall volume of the camera speaker.  
Press **<**/**>** to adjust the balance between the background music and the sound recorded with photographs or movies.

### Notes

- You can change [Beat] to different BGM. Record the data downloaded from the Olympus website onto the card, select [Beat] from [BGM] in step 2, and press **▶**. Visit the following website for the download.  
<http://support.olympus-imaging.com/bgmdownload/>

## Using the touch screen

You can use the touch screen during playback or when framing pictures in the monitor. You can also use the touch screen to adjust settings in the live guides and LV super control panel.

### Live guides



The touch screen can be used with live guides.

 "Using live guides" (P. 31)

**1** Touch the tab and swipe your finger to the left to display live guides.

- Tap to select items.

**2** Use your finger to position the sliders.

- Tap  to enter the setting.
- To cancel the live guide setting, tap  on the screen.



### Shooting mode

You can focus and shoot by tapping the monitor.

Tap  to cycle through touch screen settings.

This function is not available when [Movie Effect] is [On] in  mode.



Touch screen operations disabled.



Tap a subject to focus and automatically release the shutter. This function is not available in  mode.



Tap to display an AF target and focus on the subject in the selected area. You can use the touch screen to choose the position and size of the focus frame. Photographs can be taken by pressing the shutter button.



### ■ Previewing Your Subject ()

**1** Tap the subject in the display.

- An AF target will be displayed.
- Use the slider to choose the size of the frame.



- 2 Use the slider to choose the size of the target frame, and then tap  to zoom in on the subject of the target frame.

- Use your finger to scroll the display when the picture is zoomed in.
- Tap [1x] to cancel the zoom display.

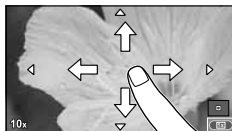

## Playback mode

Use the touch screen to page through images or zoom in and out.



### ■ Full-frame playback

#### Viewing additional images

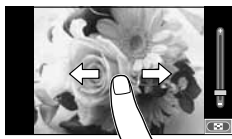
- Slide your finger to the left to view later frames, right to scroll view earlier frames.





#### Playback zoom

- Slide the bar up or down to zoom in or out.
- Use your finger to scroll the display when the picture is zoomed in.
- Tap  to display Index playback.  
For calendar playback, tap  until the calendar is displayed.



### ■ Index/Calendar Playback

#### Page ahead/Page back

- Slide your finger up to view the next page, down to view the previous page.
- Use  or  to choose the number of images displayed.
- For single-frame playback, tap  until the current image is displayed full frame.



#### Viewing images

- Tap an image to view it full frame.

## Adjusting Settings

Settings can be adjusted in the LV super control panel. You can set what to display on the LV super control panel using [Control Settings] in the [Disp./[ ]/PC] in the Custom Menu.

### 1 Display the LV super control panel.

- Press **OK** to display the cursor.



### 2 Tap the desired item.

- The item will be highlighted.



### 3 Rotate the dial to choose an option.

#### ! Cautions

- The situations in which touch screen operations are not available include the following.
  - Panorama/3D/e-portrait/multiple exposure/during bulb or time photography/one-touch white balance dialog/when buttons or dials are in use
- In self-timer mode, the timer can be started by tapping the display. Tap again to stop the timer.
- Do not touch the display with your fingernails or other sharp objects.
- Gloves or monitor covers may interfere with touch screen operation.
- You can also use the touch screen with the **ART** and **SCN** menus. Tap an icon to select it.

## Using live control

The live control can be used to adjust settings in **P**, **A**, **S**, **M**, and **☞** modes. Using live control allows you to preview the effects of different settings in the monitor.



## Available settings

Image stabilizer .....	P. 47	Record mode .....	P. 52
Picture mode .....	P. 48	Flash mode .....	P. 33
Scene mode .....	P. 29	Flash intensity control.....	P. 53
Art filter mode .....	P. 28	Metering mode.....	P. 54
☞ mode .....	P. 49	AF mode .....	P. 55
White balance.....	P. 50	ISO sensitivity.....	P. 56
Sequential shooting/self-timer .....	P. 35	Face priority.....	P. 56
Aspect ratio.....	P. 51	Movie sound record.....	P. 57

1 Press **OK** to display the live control.

- To hide the live control, press **OK** again.

2 Use **Δ**/**▽** to select the settings, use **◀**/**▶** to change the selected setting, and press **OK**.

- The selected settings take effect automatically if no operations are performed for about 8 seconds.

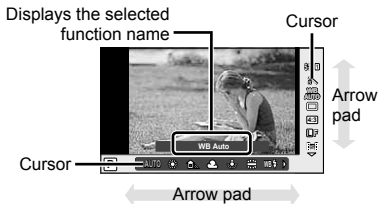
! **Cautions**

- Some items are not available in some shooting modes.

**Tips**

- For more advanced options or to customize your camera, use the menus to make settings. "Using the menus" (P. 58)

## Reducing camera shake (image stabilizer)

You can reduce the amount of camera shake that can occur when shooting in low light situations or shooting with high magnification.

- 1 Display the live control and select the image stabilizer item using  $\Delta \nabla$ .

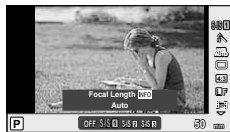

- 2 Select an option with  $\triangleleft \triangleright$  and press  $\odot$ .

<b>Still picture</b>	OFF	IS Off	Image stabilizer is off.
	S-IS1	Auto	Image stabilizer is on.
	S-IS2	Vertical IS	Image stabilization applies only to vertical (📷) camera shake. Use when panning the camera horizontally.
	S-IS3	Horizontal IS	Image stabilization applies only to horizontal (📷) camera shake. Use when panning the camera horizontally with the camera held in portrait orientation.
<b>Movie</b>	OFF	IS Off	Image stabilizer is off.
	M-IS1	Movie-I.S.	In addition to Auto image stabilization, camera shake that occurs when shooting while walking is also reduced.
	M-IS2	Auto	Image stabilization applies to camera shake in all directions.

### Choosing a focal length (Micro Four Thirds/Four Thirds System lenses excluded)

Use focal length information to reduce camera shake when shooting with lenses that are not Micro Four Thirds or Four Thirds system lenses.

- Select [Image Stabilizer], press the **INFO** button, use  $\triangleleft \triangleright$  to select a focal length, and press  $\odot$ .
- Choose a focal length between 8mm and 1000mm.
- Choose the value that most closely matches to the one that is printed on the lens.

### ⚠ Cautions

- The image stabilizer cannot correct excessive camera shake or camera shake that occurs when the shutter speed is set to the slowest speed. In these cases, it is recommended that you use a tripod.
- When using a tripod, set [Image Stabilizer] to [OFF].
- When using a lens with an image stabilization function switch, priority is given to the lens side setting.
- You may notice an operating sound or vibration when the image stabilizer is activated.
- The image stabilizer will not activate at shutter speeds of over 2 seconds.

## Processing options (picture mode)

Select a picture mode and make individual adjustments to contrast, sharpness, and other parameters. Changes to each picture mode are stored separately.

1 Display the live control and select [Picture Mode].





2 Select an option with  $\Delta$   $\nabla$  and press  $\odot$ .

<b>i-Enhance</b>	Produces more impressive-looking results suited to the scene.
<b>Vivid</b>	Produces vivid colors.
<b>Natural</b>	Produces natural colors.
<b>Muted</b>	Produces flat tones.
<b>Portrait</b>	Produces beautiful skin tones.
<b>Monotone</b>	Produces black and white tone.
<b>Custom</b>	Select one picture mode, set the parameters, and register the setting.
<b>Pop Art</b>	Choose an art filter and select the desired effect.
<b>Soft Focus</b>	
<b>Pale&amp;Light Color</b>	
<b>Light Tone</b>	
<b>Grainy Film</b>	
<b>Pin Hole</b>	
<b>Diorama</b>	
<b>Cross Process</b>	
<b>Gentle Sepia</b>	
<b>Dramatic Tone</b>	
<b>Key Line</b>	
<b>Watercolor</b>	



## Adding effects to a movie

You can create movies that take advantage of the effects available in still photography mode. Set the dial to  to enable the settings.

- 1 After selecting  mode, display the live control (P. 46) and use  $\Delta$   $\nabla$  to highlight the shooting mode.



- 2 Use  $\triangleleft$   $\triangleright$  to choose a mode and press .

<b>P</b>	Optimal aperture is set automatically according to the brightness of the subject.
<b>A</b>	Depiction of background is changed by setting the aperture. Use $\Delta$ $\nabla$ to adjust the aperture.
<b>S</b>	Shutter speed affects how the subject appears. Use $\Delta$ $\nabla$ to adjust the shutter speed. Shutter speed can be set to values between 1/30 s and 1/4000 s.
<b>M</b>	You control both aperture and shutter speed. Use $\triangleleft$ $\triangleright$ to choose the aperture, $\Delta$ $\nabla$ to select the shutter speed from values between 1/30 s and 1/4000 s. Sensitivity can be set manually to values between ISO 200 and 3200; auto ISO sensitivity control is not available.

### Cautions

- When recording a movie, you cannot change the settings for exposure compensation, aperture value, and shutter speed.
- If [Image Stabilizer] is activated while recording a movie, the recorded image is enlarged slightly.
- Stabilization is not possible when the camera shake is excessive.
- When the inside of the camera becomes hot, shooting is automatically stopped to protect the camera.
- With some art filters, [C-AF] operation is limited.
- Cards with an SD speed class of 6 or above are recommended for movie recording.

## Adjusting color (white balance)

White balance (WB) ensures that white objects in images recorded by the camera appear white. [AUTO] is suitable in most circumstances, but other values can be selected according to the light source when [AUTO] fails to produce the desired results or you wish to introduce a deliberate color cast into your images.

- 1 Display the live control and select the white balance item using  $\Delta \nabla$ .
- 2 Select an option using  $\triangleleft \triangleright$  and press  $\odot$ .



WB mode		Color temperature	Light conditions
<b>Auto white balance</b>	<b>AUTO</b>	—	Used for most light conditions (when there is a white portion framed on the monitor). Use this mode for general use.
<b>Preset white balance</b>		5300K	For shooting outdoors on a clear day, or to capture the reds in a sunset or the colors in a fireworks display
		7500K	For shooting outdoors in the shadows on a clear day
		6000K	For shooting outdoors on a cloudy day
		3000K	For shooting under a tungsten light
		4000K	For subjects lit by fluorescent lights
		5500K	For flash shooting
<b>One-touch white balance</b> (P. 51)		Color temperature set by one-touch WB.	Choose when a white or gray subject can be used to measure white balance and the subject is under mixed lighting or lit by an unknown type of flash or other light source.
<b>Custom white balance</b>	<b>CWB</b>	2000K – 14000K	After pressing the <b>INFO</b> button, use $\triangleleft \triangleright$ buttons to select a color temperature and then press $\odot$ .

### One-touch white balance

Measure white balance by framing a piece of paper or other white object under the lighting that will be used in the final photograph. This is useful when shooting a subject under natural light, as well as under various light sources with different color temperatures.

- 1 Select [] or [] (one-touch white balance 1 or 2) and press the **INFO** button.
- 2 Photograph a piece of colorless (white or gray) paper.
  - Frame the object so that it fills the display and no shadows fall it.
  - The one-touch white balance screen appears.
- 3 Select [Yes] and press .
  - The new value is saved as a preset white balance option.
  - The new value is stored until one-touch white balance is measured again. Turning the power off does not erase the data.



#### **Tips**

- If the subject is too bright or too dark or visibly tinted, the message [WB NG Retry] will be displayed and no value will be recorded. Correct the problem and repeat the process from Step 1.

### Setting the image aspect

You can change the aspect ratio (horizontal-to-vertical ratio) when taking pictures. Depending on your preference, you can set the aspect ratio to [4:3] (standard), [16:9], [3:2], [1:1], or [3:4].

- 1 Display the live control and select the aspect ratio item using .
- 2 Use to select an aspect ratio and press .



#### **Cautions**

- JPEG images are cropped to the selected aspect ratio; RAW images, however, are not cropped but are instead saved with information on the selected aspect ratio.
- When RAW images are played back, the selected aspect ratio is shown by a frame.

## Image quality (record mode)

Select an image quality for photographs and movies according to their intended use, for example retouching on a computer or display on the web.

- 1 Display the live control and use  $\Delta$   $\nabla$  to choose a record mode for photographs or movies.
- 2 Select an option using  $\triangleleft$   $\triangleright$  and press  $\text{OK}$ .



Record mode

### Record modes (still images)

Choose from RAW and JPEG (L, M, and S) modes. Choose a RAW+JPEG option to record both a RAW and a JPEG image with each shot. JPEG modes combine image size (L, M, and S) and compression ratio (SF, F, N, and B).

Image size		Compression rate				Application
Name	Pixel count	SF (Super Fine)	F (Fine)	N (Normal)	B (Basic)	
L (Large)	4608×3456*	L SF	L F*	L N*	L B	Select for the print size
	3200×2400					
	2560×1920*					
	1920×1440					
M (Middle)	1600×1200	M SF	M F	M N*	M B	For small prints and use on a website
	1280×960*					
	1024×768					
S (Small)	640×480	S SF	S F	S N*	S B	

\* Default

### RAW image data

This format (extension “.ORF”) stores unprocessed image data for later processing. RAW image data cannot be viewed using other cameras or software, and RAW images cannot be selected for printing. JPEG copies of RAW images can be created using this camera.

“Editing still images” (P. 67)

## ■ Record modes (movies)

Record mode	Pixel count	File format	Application
Full HD Fine	1920×1080	MPEG-4 AVC/ H.264*1	Display on TVs and other devices
Full HD Normal	1920×1080		
HD Fine	1280×720		
HD Normal	1280×720		
HD	1280×720	Motion JPEG*2	For computer playback or editing
SD	640×480		

- Depending on the type of card used, recording may end before the maximum length is reached.

\*1 Individual movies can be up to 29 minutes long.

\*2 Files may be up to 2GB in size.

## Adjusting flash output (flash intensity control)

Flash output can be adjusted if you find that your subject appears overexposed, or is underexposed even though the exposure in the rest of the frame is just right.

- 1 Display the live control and select the Flash intensity control item using  $\Delta$   $\nabla$ .
- 2 Choose the compensation value with  $\triangleleft$   $\triangleright$  and press  $\text{OK}$ .



### ! Cautions







- This setting has no effect when the flash control mode for the external flash unit is set to MANUAL.
- Changes to flash intensity made with the external flash unit are added to those made with the camera.

## Choosing how the camera measures brightness (metering)

Choose how the camera meters subject brightness.

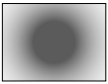
- 1 Display the live control and select the metering item using  $\Delta$   $\nabla$ .
- 2 Select an option with  $\triangleleft$   $\triangleright$  and press  $\text{OK}$ .

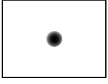

 <b>Digital ESP metering</b>	The camera meters exposure in 324 areas of the frame and optimizes exposure for the current scene or (if an option other than [OFF] is selected for [Face Priority]) portrait subject. This mode is recommended for general use.	
 <b>Center weighted averaging metering</b>	This metering mode provides the average metering between the subject and the background lighting, placing more weight on the subject at the center.	
 <b>Spot metering</b>	Choose this option to meter a small area (about 2% of the frame) with the camera pointed at the object you wish to meter. Exposure will be adjusted according to the brightness at the metered point.	
 HI <b>Spot metering - highlight</b>	Increases spot metering exposure. Ensures bright subjects appear bright.	
 SH <b>Spot metering - shadow</b>	Lowers spot metering exposure. Ensures dark subjects appear dark.	

- 3 Press the shutter button halfway.
  - Normally, the camera will start metering when the shutter button is pressed halfway and lock exposure while the shutter button is held in this position.

## Choosing a focus mode (AF mode)

Select a focusing method (focus mode).

You can choose separate focusing methods for still photography mode and  mode.

**1** Display the live control and select the AF mode item using  $\Delta$   $\nabla$ .



**2** Select an option with  $\triangleleft$   $\triangleright$  and press  $\text{OK}$ .

- The selected AF mode is displayed on the monitor.

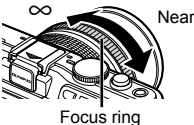
<b>S-AF</b> (single AF)	The camera focuses once when the shutter button is pressed halfway. When the focus is locked, a beep sounds, and the AF confirmation mark and the AF target mark light up. This mode is suitable for taking pictures of still subjects or subjects with limited movement.
<b>C-AF</b> (continuous AF)	The camera repeats focusing while the shutter button remains pressed halfway. When the subject is in focus, the AF confirmation mark lights up on the monitor and the beep sounds when the focus is locked at the first and second time. Even if the subject moves or you change the composition of the picture, the camera continues trying to focus. • Four Thirds system lenses focus using [S-AF].
<b>MF</b> (manual focus)	This function allows you to manually focus on any subject. 
<b>S-AF+MF</b> (simultaneous use of S-AF mode and MF mode)	After pressing the shutter button halfway to focus in [S-AF] mode, you can turn the focus ring to fine-adjust focus manually.
<b>C-AF+TR</b> (AF tracking)	Press the shutter button halfway to focus; the camera then tracks and maintains focus on the current subject while the shutter button is held in this position. • The AF target is displayed in red if the camera can no longer track the subject. Release the shutter button and then frame the subject again and press the shutter button halfway. • Four Thirds system lenses focus using [S-AF].

### **Cautions**

- The camera may be unable to focus if the subject is poorly lit, obscured by mist or smoke, or lacks contrast.

## ISO sensitivity

Increasing ISO sensitivity increases noise (graininess) but allows photographs to be taken when lighting is poor. The setting recommended in most situations is [AUTO], which starts at ISO 200 — a value that balances noise and dynamic range — and then adjusts ISO sensitivity according to shooting conditions.

- 1 Display the live control and select the ISO sensitivity item using  $\Delta \nabla$ .
- 2 Select an option using  $\triangleleft \triangleright$  and press  $\odot$ .

<b>AUTO</b>	The sensitivity is set automatically according to the shooting conditions.
<b>LOW, 200–25600</b>	Sensitivity is set to the selected value.

## Face priority AF/pupil detection AF

The camera detects faces and adjusts focus and digital ESP.

- 1 Display the live control and select the face priority item using  $\Delta \nabla$ .
- 2 Use  $\triangleleft \triangleright$  to select an option and press  $\odot$ .



<b>OFF</b> Face Priority Off	Face priority off.
$\odot$ Face Priority On	Face priority on.
$\odot$ Face & Eye Priority On	The autofocus system selects the pupil of the eye closest to the camera for face-priority AF.
$\odot$ Face & R. Eye Priority On	The autofocus system selects the pupil of the eye on the right for face-priority AF.
$\odot$ Face & L. Eye Priority On	The autofocus system selects the pupil of the eye on the left for face-priority AF.

- 3 Point the camera at your subject.
  - If a face is detected, it will be indicated by a white border.
- 4 Press the shutter button halfway to focus.
  - When the camera focuses on the face in the white border, the border will turn green.
  - If the camera is able to detect the subject's eyes, it will display a green frame over the selected eye. (pupil detection AF)





**5** Press the shutter button the rest of the way down to shoot.

**!** **Cautions**

- Face priority applies only to the first shot in each sequence taken during sequential shooting.
- Depending on the subject and the art filter setting, the camera may not be able to correctly detect the face.
- When set to [ESP] (Digital ESP metering), metering is performed with priority given to faces.

**✍** **Notes**

- Face priority is also available in [MF]. Faces detected by the camera are indicated by white frames.

## Movie sound options (recording sound with movies)

**1** Display the live control and select the Movie  item using  $\Delta \nabla$ .

**2** Switch ON/OFF using  $\triangleleft \triangleright$  and press .

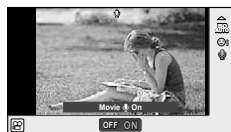

**!** **Cautions**

- When recording sound in a movie, the sound made by the lens and camera operating may be recorded. If desired, you can reduce these sounds by shooting with [AF Mode] set to [S-AF], or by limiting the amount of times you press the buttons.
- No sound is recorded in [ART7] (Diorama) mode.

## Using the menus

The menus contain shooting and playback options that are not displayed by the live control, and let you customize the camera settings for easier use.

	Preliminary and basic shooting options
	Advanced shooting options
	Playback and retouch options
	Customizing camera settings (P. 72)*
	Accessory port menu options for accessory port devices such as EVF and OLYMPUS PENPAL (P. 72)*
	Camera setup (e.g., date and language)

\* Not displayed at default settings.

**1** Press the **MENU** button to display the menus.

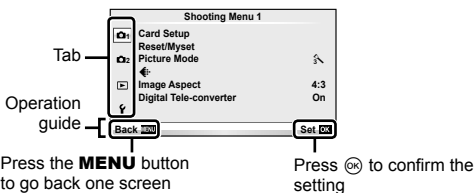

**2** Use  $\Delta$   $\nabla$  to select a tab and press  $\text{OK}$ .

**3** Select an item using  $\Delta$   $\nabla$  and press  $\text{OK}$  to display options for the selected item.

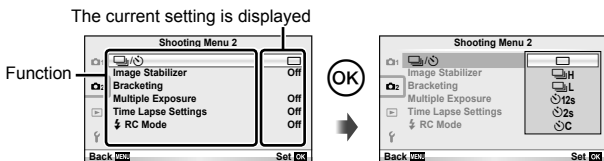

**4** Use  $\Delta$   $\nabla$  to highlight an option and press  $\text{OK}$  to select.

- Press the **MENU** button repeatedly to exit the menu.

### Notes

- For the default settings of each option, refer to "Menu directory" (P. 115).
- A guide is displayed for about 2 seconds after you select an option. Press the **INFO** button to view or hide guides.

## ■ Shooting Menu 1/Shooting Menu 2

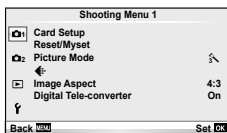

- Card Setup (P. 59)  
 Reset/Myset (P. 59)  
 Picture Mode (P. 60)  
⏪ (P. 62)  
 Image Aspect (P. 51)  
 Digital Tele-converter (P. 66)
- (Drive/Self-timer) (P. 62)  
 Image Stabilizer (P. 47)  
 Bracketing (P. 62)  
 Multiple Exposure (P. 64)  
 Time Lapse Settings (P. 65)  
⚡ RC Mode (P. 66)

### Formatting the card (Card Setup)

Cards must be formatted with this camera before first use or after being used with other cameras or computers.

All data stored on the card, including protected images, is erased when the card is formatted.

When formatting a used card, confirm there are no images that you still want to keep on the card. ⏪ “Card basics” (P. 106)

- 1 Select [Card Setup] in ⏪ Shooting Menu 1.
- 2 Select [Format].

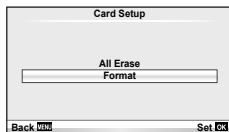

- 3 Select [Yes] and press ⏹.
  - Formatting is performed.

### Restoring default settings (Reset/Myset)

Camera settings can be easily restored to registered settings.

#### Using reset settings

Restore default settings.

- 1 Select [Reset/Myset] in ⏪ Shooting Menu 1.
- 2 Select [Reset] and press ⏹.
  - Highlight [Reset] and press ▶ to choose the reset type. To reset all settings except the time, date, and a few others, highlight [Full] and press ⏹.  
⏪ “Menu directory” (P. 115)
- 3 Select [Yes] and press ⏹.

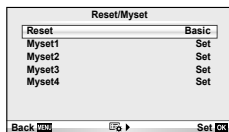

### Saving Myset

You can save the current camera settings for modes other than shooting mode. Saved settings can be called up in **P**, **A**, **S**, and **M** modes.

- 1 Adjust settings in order to save.
- 2 Select [Reset/Myset] in Shooting Menu 1.
- 3 Select the desired destination ([Myset1]–[Myset4]) and press .
  - [Set] appears next to destinations ([Myset1]–[Myset4]) to which settings have already been saved. Selecting [Set] again overwrites the registered setting.
  - To cancel the registration, select [Reset].
- 4 Select [Set] and press .
  - Settings that can be saved to Myset “Menu directory” (P. 115)

### Using Myset

Sets the camera to the settings selected for Myset.

- 1 Select [Reset/Myset] in Shooting Menu 1.
- 2 Select the desired settings ([Myset1]–[Myset4]) and press .
- 3 Select [Set] and press .

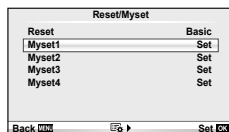



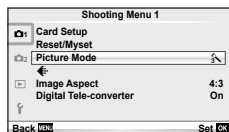

### Processing options (Picture Mode)

Make individual adjustments to contrast, sharpness, and other parameters using the [Picture Mode] item in [Live Control]. Changes to each picture mode are stored separately.

- 1 Select [Picture Mode] in Shooting Menu 1.
- 2 Select an option with and press .
- 3 Press to display settings for the selected option.



					
<b>Contrast</b>	Distinction between light and dark	✓	✓	✓	✓
<b>Sharpness</b>	Sharpness of the image	✓	✓	✓	✓
<b>Saturation</b>	Vividness of the color	✓	✓	—	✓
<b>Gradation</b>	Adjust tone (gradation).				
<b>Auto</b>	Divides the image into detailed regions and adjusts the brightness separately for each region. This is effective for images with areas of large contrast in which the whites appear too bright or the blacks appear too dark.	✓	✓	✓	✓
<b>Normal</b>	Use [Normal] mode for general uses.				
<b>High Key</b>	Gradation for a bright subject.				
<b>Low Key</b>	Gradation for a dark subject.				
<b>Effect</b> (i-Enhance)	Sets the extent that the effect will be applied.	✓	—	—	✓
<b>B&amp;W Filter</b> (Monotone)	Creates a black and white image. The filter color is brightened and the complementary color is darkened.				
<b>N:Neutral</b>	Creates a normal black and white image.				
<b>Ye:Yellow</b>	Reproduces clearly defined white cloud with natural blue sky.			✓	✓
<b>Or:Orange</b>	Slightly emphasizes colors in blue skies and sunsets.	—	—		
<b>R:Red</b>	Strongly emphasizes colors in blue skies and brightness of crimson foliage.				
<b>G:Green</b>	Strongly emphasizes colors in red lips and green leaves.				
<b>Pict. Tone</b> (Monotone)	Colors the black and white image.				
<b>N:Neutral</b>	Creates a normal black and white image.				
<b>S:Sepia</b>	Sepia	—	—	✓	✓
<b>B:Blue</b>	Bluish				
<b>P:Purple</b>	Purplish				
<b>G:Green</b>	Greenish				

### **Cautions**

- Changes to contrast have no effect at settings other than [Normal].

## Image quality (📷)

Select an image quality. You can select a separate image quality for photographs and movies. This is the same as the [📷] item in [Live Control].

- You can change the JPEG image size and compression ratio combination, and [M] and [S] pixel counts. [📷] Set], [Pixel Count] 📷 “Using the custom menus” (P. 72)

## Setting the self timer (📷/⌚)

You can customize the self timer operation.

- 1 Select [📷/⌚] in 📷 Shooting Menu 2.

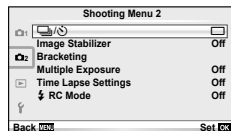

- 2 Select [⌚C] (custom) and press [OK].
- 3 Use Δ ▽ to select the item and press ▷.
  - Use Δ ▽ to select the setting and press [OK].

<b>Frame</b>	Sets the number of frames to be shot.
<b>⌚ Timer</b>	Sets the time after the shutter button is pressed until the picture is taken.
<b>Interval Time</b>	Sets the shooting interval for the second and subsequent frames.

## Varying settings over a series of photographs (bracketing)

“Bracketing” refers to the act of varying settings automatically over a series of shots or a series of images to “bracket” the current value.

- 1 Select [Bracketing] in 📷 Shooting Menu 2.

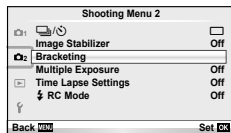

- 2 Choose a bracketing type.
  - [BKT] or [HDR] is displayed in the monitor.

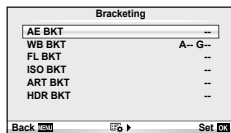

### AE BKT (AE bracketing)

The camera varies the exposure of each shot. The modification amount can be selected from 0.3 EV, 0.7 EV, or 1.0 EV. In single-frame shooting mode, one photograph is taken each time the shutter button is pressed all the way down, while in sequential shooting mode the camera continues to take shots in the following order while the shutter button is pressed all the way down: no modification, negative, positive. Number of shots: 2, 3, 5, or 7

- The **[BKT]** indicator turns green during bracketing.
- The camera modifies exposure by varying aperture and shutter speed (mode **P**), shutter speed (modes **A** and **M**), or aperture (mode **S**).
- The camera brackets the value currently selected for exposure compensation.
- The size of the bracketing increment changes with the value selected for [EV Step].  "Using the custom menus" (P. 72)

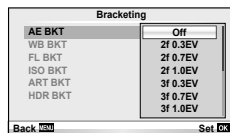

### WB BKT (WB bracketing)

Three images with different white balances (adjusted in specified color directions) are automatically created from one shot, starting with the value currently selected for white balance. WB bracketing is available in **P**, **A**, **S** and **M** modes.

- White balance can be varied by 2, 4, or 6 steps on each of the A–B (Amber–Blue) and G–M (Green–Magenta) axes.
- The camera brackets the value currently selected for white balance compensation.
- No pictures will be taken during WB bracketing if there is not enough memory on the card for the selected number of frames.

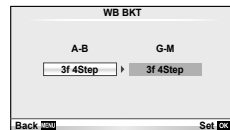

### FL BKT (FL bracketing)

The camera varies flash level over three shots (no modification on the first shot, negative on the second, and positive on the third). In single-frame shooting, one shot is taken each time the shutter button is pressed; in sequential shooting, all shots are taken while the shutter button is pressed.

- The **[BKT]** indicator turns green during bracketing.
- The size of the bracketing increment changes with the value selected for [EV Step].  "Using the custom menus" (P. 72)

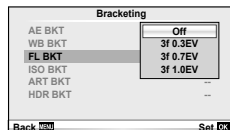

### ISO BKT (ISO bracketing)

The camera varies the sensitivity over three shots while keeping the shutter speed and aperture fixed. The modification amount can be selected from 0.3 EV, 0.7 EV, or 1.0 EV. Each time the shutter button is pressed, the camera shoots three frames with the set sensitivity (or if auto sensitivity is selected, the optimal sensitivity setting) on the first shot, negative modification on the second shot, and positive modification on the third shot.

- The size of the bracketing increment does not change with the value selected for [ISO Step]. "Using the custom menus" (P. 72)
- Bracketing is performed regardless of the upper limit set with [ISO-Auto Set]. "Using the custom menus" (P. 72)

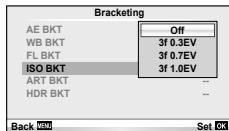

### ART BKT (ART bracketing)

Each time the shutter is released, the camera records multiple images, each with a different art filter setting. You can turn art filter bracketing on or off separately for each picture mode.

- Recording may take some time.
- ART BKT cannot be combined with WB BKT or ISO BKT.

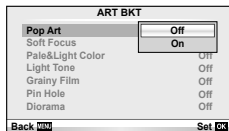

### HDR BKT (HDR bracketing)

The camera records multiple images, each with a different exposure suitable for HDR imaging.

- The images are recorded in sequential shooting mode. The camera continues to take the selected number of frames even if you release the shutter button.
- HDR bracketing cannot be combined with other bracketing.

## Recording multiple exposures in a single image (multiple exposure)

Record multiple exposures in a single image, using the option currently selected for image quality.

**1** Select [Multiple Exposure] in Shooting Menu 2.

**2** Adjust settings.

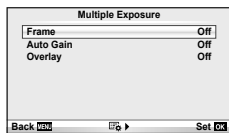

Frame	Select [2f].
<b>Auto Gain</b>	When set to [On], the brightness of each frame is set to 1/2 and the images are overlaid. When set to [Off], the images are overlaid with the original brightness of each frame.
<b>Overlay</b>	When set to [On], a RAW image recorded on a card can be overlaid with multiple exposures and stored as a separate image. The number of pictures taken is one.





- is displayed in the monitor while multiple exposure is in effect.



### 3 Take pictures.

-  is displayed in green when shooting starts.
- Press  to delete the last shot.
- The previous shot is superimposed on the view through the lens as a guide to framing the next shot.

#### Tips

- To overlay 3 or more frames: Select RAW for  and use the [Overlay] option to make repeated multiple exposures.
- For more information on overlaying RAW images:  [Edit] (P. 67)

#### Cautions

- The camera will not go to sleep while multiple exposure is in effect.
- Photographs taken with other cameras cannot be included in a multiple exposure.
- When [Overlay] is set to [On], the images displayed when a RAW image is selected are developed with the settings at the time of shooting.
- To set the shooting functions, cancel multiple exposure shooting first. Some functions cannot be set.
- Multiple exposure is cancelled automatically from the first picture in the following situations.  
The camera is turned off/The  button is pressed/The **MENU** button is pressed/The shooting mode is set to a mode other than **P, A, S, M**/The battery power runs out/  
Any cable is connected to the camera/You switch between the monitor and electronic viewfinder
- When a RAW image is selected using [Overlay], the JPEG image for the image recorded in JPEG+RAW is displayed.
- When shooting multiple exposures using bracketing, priority is given to multiple exposure shooting. While the overlay image is being saved, bracketing is reset to the factory default setting.

### Shooting automatically with a fixed interval (time lapse shooting)

You can set the camera to shoot automatically with a set time lapse. The shot frames can also be recorded as into a single movie. This setting is only available in **P/A/S/M** modes.

- 1 Perform the following settings under [Time Lapse Settings] in  Shooting Menu 2.

<b>Frame</b>	Sets the number of frames to be shot.
<b>Start Waiting Time</b>	Sets waiting time before starting to shot.
<b>Interval Time</b>	Sets interval between shots after shooting starts.
<b>Time Lapse Movie</b>	Sets recording format of frame sequence. [Off]: Records each frame as a still picture. [On]: Records each frame as a still picture and generates and records a single movie from the frame sequence.

- The image quality of the movie is [M-JPEG HD] and the frame rate 10fps.

## 2 Shoot.

- Frames are shot even if the image is not in focus after AF. If you wish to fix the focus position, shoot in MF.
- [Rec View] operates for 0.5 seconds.
- If either of the time before shooting, or shooting interval is set to 1 minute 30 seconds or longer, the monitor and camera power will turn off after 1 minute. 10 seconds before shooting, the power will automatically turn on again. When the monitor is off, press the **ON/OFF** button to turn it on again.

### ! Cautions

- This function cannot be used if the time and date have not been set.
- If the AF mode is set to [C-AF] or [C-AF+TR], it is automatically changed to [S-AF].
- Touch operations are disabled during time lapse shooting.
- Bracketing and multiple exposure cannot be used together.
- The flash will not work if the flash charging time is longer than the interval between shots.
- For [BULB] and [TIME] shooting, the shutter speed is fixed to 60 seconds.
- If the camera automatically turns off in interval between shots, it will turn on in time for the next shot.
- If the any of the still pictures are not recorded correctly, the time lapse movie will not be generated.
- If there is insufficient space on the card, the time lapse movie will not be recorded.
- Time lapse shooting will cancelled if any of the following is operated: Mode dial, **MENU** button,  button, lens release button, or connecting the USB cable.
- If you press the ON/OFF button during the time before shooting while the monitor is on, time lapse shooting will be cancelled and the camera power will turn off.
- If there is not enough charge left on the battery, the shooting may end partway through. Make sure the battery is suitably charged before starting.

## Wireless remote control flash photography

The supplied flash unit and external flash units that offer a remote control mode and are designated for use with this camera can be used for wireless flash photography.

 "Wireless remote control flash photography" (P. 113)

## Digital Zoom (Digital Tele-converter)







Digital Tele-converter is used to zoom in beyond the current zoom ratio. The camera saves the center crop. Zoom is increased by about 2 $\times$ .

**1** Select [On] for [Digital Tele-converter] in  Shooting Menu 1.

**2** The view in the monitor will be enlarged by a factor of two.

- The subject will be recorded as it appears in the monitor.

### ! Cautions

- Digital zoom is not available with multiple exposures or when , , , , or  is selected in **SCN** mode.
- This function is not available when [Movie Effect] is [On] in  mode.
- When a RAW image is displayed, the area visible in the monitor is indicated by a frame.

## ■ Playback Menu

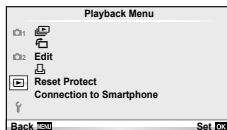

(P. 42)  
 (P. 67)  
 Edit (P. 67)

(P. 92)  
 Reset Protect (P. 69)  
 Connection to Smartphone (P. 70)

## Displaying images rotated ()

When set to [On], photographs taken with the camera rotated in portrait orientation are automatically rotated and displayed in portrait orientation.

## Editing still images

Recorded images can be edited and saved as new images.

- 1 Select [Edit] in the Playback Menu and press .
- 2 Use  $\Delta$   $\nabla$  to select [Sel. Image] and press .
- 3 Use  $\triangleleft$   $\triangleright$  to select the image to be edited and press .
  - [RAW Data Edit] is displayed if the picture is a RAW image, [JPEG Edit] if it is a JPEG image. If the image was recorded in RAW+JPEG format, both [RAW Data Edit] and [JPEG Edit] will be displayed. Select the menu for the image to be edited.
- 4 Select [RAW Data Edit] or [JPEG Edit] and press .

<b>RAW Data Edit</b>	Create a JPEG copy of a RAW image edited according to the settings.	
	<b>[Current]</b>	The JPEG copy is processed using the current camera settings. Adjust the camera settings before choosing this option.
	<b>[Custom1]</b>	Editing can be performed while changing the settings on the monitor. You can save the settings used.
<b>[Custom2]</b>		

## JPEG Edit

Choose from the following options:

[Shadow Adj]: Brightens a dark backlit subject.

[Redeye Fix]: Reduces the red-eye phenomenon during flash shooting.

[]: Use the control dial to choose the size of the crop and  $\Delta \nabla \triangleleft \triangleright$  to position the crop.



[Aspect]: Changes the aspect ratio of images from 4:3 (standard) to [3:2], [16:9], [1:1], or [3:4].

After changing the aspect ratio, use  $\Delta \nabla \triangleleft \triangleright$  to specify the trimming position.

[Black & White]: Creates black and white images.

[Sepia]: Creates sepia-toned images.

[Saturation]: Sets the color depth. Adjust the color saturation checking the picture on the screen.

[]: Converts the image file size to 1280 × 960, 640 × 480, or 320 × 240. Images with an aspect ratio other than 4:3 (standard) are converted to the closest image file size.

[e-Portrait]: Makes skin look smooth and translucent.

You may not be able to compensate depending on the image if face detection fails.



### 5 When the settings are complete, press .

- The settings will be applied to the image.

### 6 Select [Yes] and press .

- The edited image is stored in the card.

### **Cautions**

- Movies and 3D photos cannot be edited.
- Red-eye correction may not work depending on the image.
- Editing of a JPEG image is not possible in the following cases:
  - When an image is processed on a PC, when there is not enough space in the card memory, when an image is recorded on another camera
- When resizing () an image, you cannot select a larger number of pixels than was originally recorded.
- [] and [Aspect] can only be used to edit images with an aspect ratio of 4:3 (standard).
- When [Picture Mode] is set to [ART], [Color Space] is locked to [sRGB].

### Image overlay

Up to 3 frames of RAW images taken with the camera can be overlaid and saved as a separate image.

The image is saved with the record mode set at the time the image is saved. (If [RAW] is selected, the copy will be saved in [L/N+RAW] format.)

- 1 Select [Edit] in the Playback Menu and press .
- 2 Use  $\Delta \nabla$  to select [Image Overlay] and press .
- 3 Select the number of images in the overlay and press .
- 4 Use  $\Delta \nabla \langle \rangle$  to select the RAW images that will be used in the overlay.
  - When you have selected the number of images specified in Step 3, the overlay will be displayed.
- 5 Adjust gain.
  - Use  $\langle \rangle$  to select an image and use  $\Delta \nabla$  to adjust gain.
  - Gain can be adjusted in the range 0.1–2.0. Check the results in the monitor.

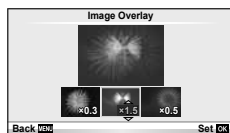

- 6 Press . A confirmation dialog will be displayed; select [Yes] and press .

#### Tips

- To overlay 4 or more frames, save the overlay image as a RAW file and use [Image Overlay] repeatedly.

### Audio recording

Add an audio recording (up to 30sec. long) to the current photograph.

This is the same function as during playback. (P. 41)

### Canceling all protections





This function lets you cancel the protection of several images at one time.

- 1 Select [Reset Protect] in the Playback Menu.
- 2 Select [Yes] and press .





## Using the Smartphone connection option (Connection to Smartphone)

Use a commercially available FlashAir card to view images directly on a smartphone or PC that has Wi-Fi connectivity or to transfer images between the camera and a smartphone or PC that has Wi-Fi connectivity. FlashAir cards that have been set by another camera or device should be formatted before use.  “Card basics” (P. 106) Software for smartphones is available. Check the Olympus website.



### Making the connection settings

- 1 Select [Connection to Smartphone] in the  Playback Menu and press .
- 2 Select [Connection Settings] and press .
- 3 Enter the [SSID Setting] and press .
  - This becomes the FlashAir card ID name used to identify this card from the device to be connected.
- 4 Enter the password, and press .
  - This is the password used when connecting from another device. Set a password between 8 and 63 characters long.
  - The message [Initial setting completed] will be displayed and the settings are complete.

### Connecting

- 1 Select [Connection to Smartphone] in the  Playback Menu and press .
- 2 Select the connection method and press .
  - [Private Connection]: Connect using the same preset password each time.
  - [One-Time Connection]: Connect using a password that is valid for only one connection. Set the 8-digit number and press .
- 3 Select the camera's FlashAir as the access point using the device to be connected, and establish the connection.
  - Refer to the Instruction Manual of the device for the method of connecting to the access point.
  - When prompted to provide a password, enter the password set using the camera.
- 4 Open an internet browser on the device to be connected, and enter <http://FlashAir/> in the address bar.
  - The camera does not automatically turn off while the connection is established.

### Ending the connection

- 1 Select [Break connection] from [Connection to Smartphone] in the  Playback Menu and press .

### Changing the settings

Select [Connection Settings] from [Connection to Smartphone], and set the [SSID Setting] and [Password Setting] items.



## ■ Setup Menu

Use the Setup Menu to set the basic camera functions.











Option	Description	Icon
(Date/time setting)	Set the camera clock.	16
(Changing the display language)	You can change the language used for the on-screen display and error messages from English to another language.	—
(Monitor brightness adjustment)	You can adjust the brightness and color temperature of the monitor. Color temperature adjustment will affect only the monitor display during playback. Use <math>\triangleleft/\triangleright</math> to highlight $\text{C}$ (color temperature) or $\text{B}$ (brightness) and $\triangle/\nabla$ to adjust the value. Press the <b>INFO</b> button to switch between [Vivid] and [Natural] monitor color display.	
<b>Rec View</b>	Choose whether pictures are displayed immediately after shooting and for how long. This is useful for making a brief check of the picture you have just taken. Pressing the shutter button halfway while checking the picture lets you resume shooting immediately. [0.3sec]–[20sec]: Selects the number of seconds to display each picture. [Off]: The picture being recorded to the card is not displayed. [Auto▶]: Displays the image being recorded, and then switches to playback mode. This is useful for erasing a picture after checking it.	—
<b>Menu Display</b>	Choose whether to display the custom menus or accessory port menu.	72
<b>Firmware</b>	Your product's firmware version will be displayed. When you make inquiries about your camera or accessories or when you want to download software, you will need to state which version of each of the products you are using.	—

## Using the custom menu

















Camera settings can be customized using the custom and accessory menus. The  Custom menu is used to fine-tune camera settings. The  Accessory Port menu is used to adjust settings for accessory port devices.

### Before Using the Custom/Accessory Port Menus

The Custom and Accessory Port menus are only available when the appropriate option is selected for the /[] Menu Display] item in the setup menu.



- 1 Press the **MENU** button to display the menus, and display the  (Setup Menu) tab.
- 2 Select [/[] Menu Display] and set [ Menu Display] or [ Menu Display] to [On].
  - The  (Custom Menu) or  (Accessory Port Menu) tab will be displayed in the menu.

#### Custom Menu

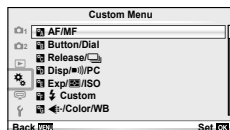
-  AF/MF (P. 73)
-  Button/Dial (P. 73)
-  Release/ (P. 74)
-  Disp//PC (P. 74)
-  Exp//ISO (P. 76)
-   Custom (P. 77)
-  /Color/WB (P. 77)
-  Record/Erase (P. 78)
-  Movie (P. 79)
-   Utility (P. 79)



#### Accessory Port Menu

-  OLYMPUS PENPAL Share (P. 89)
-  OLYMPUS PENPAL Album (P. 91)
-  Electronic Viewfinder (P. 91)

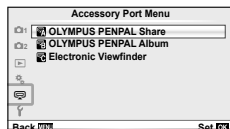







## ■ Custom Menu

















### AF/MF

 MENU →  → 

Option	Description	
<b>AF Mode</b>	Choose the AF mode. This is the same as the live control setting. You can set separate focusing methods for still photography mode and  mode.	55
<b>Full-time AF</b>	If [On] is selected, the camera will continue to focus even when the shutter button is not pressed halfway.	—
<b>AEL/AFL</b>	Customize AF and AE lock.	80
<b>Reset Lens</b>	When set to [On], this resets the focus of the lens (infinity) each time the power is turned off. The focus of power zoom lenses is also reset.	—
<b>BULB/TIME Focusing</b>	Normally focus locks during the exposure when manual focus (MF) is selected. Select [On] to allow focusing using the focus ring.	—
<b>Focus Ring</b>	You can customize how the lens adjusts to the focal point by selecting the rotational direction of the focus ring.	—
<b>MF Assist</b>	Select [On] to automatically magnify the image for precise focus when the focus ring is rotated in manual focus mode.	—
<b>[] Set Home</b>	Choose the AF target position that will be saved as the home position.  appears in the AF target selection display while you choose a home position.	—
<b>AF Illuminat.</b>	Select [Off] to disable the AF illuminator.	—
<b> Face Priority</b>	Select the face priority AF mode. This is the same as the live control setting.	56

### Button/Dial

 MENU →  → 

Option	Description									
<b>Button Function</b>	Choose the function assigned to the selected button. <div style="border: 1px solid black; padding: 5px; width: fit-content; margin: 5px 0;"> Function], [Function], [Function], [Function], [Function], [Function]         </div>	81								
<b>Dial Function</b>	Choose the role played by the control dial. <table border="1" style="width: 100%; border-collapse: collapse;"> <tbody> <tr> <td style="text-align: center;"><b>P</b></td> <td> / <b>Ps</b></td> </tr> <tr> <td style="text-align: center;"><b>A</b></td> <td>Aperture value / </td> </tr> <tr> <td style="text-align: center;"><b>S</b></td> <td>Shutter speed / </td> </tr> <tr> <td style="text-align: center;"><b>M</b></td> <td>Shutter speed / Aperture value</td> </tr> </tbody> </table> <p>In <b>P</b>, <b>A</b>, <b>S</b>, and <b>M</b> modes, the roles played before and after  button is pressed are reversed.</p>	<b>P</b>	 / <b>Ps</b>	<b>A</b>	Aperture value / 	<b>S</b>	Shutter speed / 	<b>M</b>	Shutter speed / Aperture value	—
<b>P</b>	 / <b>Ps</b>									
<b>A</b>	Aperture value / 									
<b>S</b>	Shutter speed / 									
<b>M</b>	Shutter speed / Aperture value									

### Button/Dial

MENU → →

Option	Description	
<b>Dial Direction</b>	Choose the direction in which the dial is rotated to adjust shutter speed or aperture or to move the cursor.	—
<b>Lock</b>	If [Off] is selected, exposure compensation and other settings can be adjusted by rotating the control dial without pressing the  button.	—
<b>Mode Dial Function</b>	Customize the shooting mode set by the mode dial. You can apply saved Myset settings.	—

### Release/

MENU → →

Option	Description	
<b>RIs Priority S</b>	If [On] is selected, the shutter can be released even when the camera is not in focus. This option can be set separately for S-AF (P. 55) and C-AF (P. 55) modes.	—
<b>RIs Priority C</b>		
<b>L fps</b>	Choose the frame advance rates for [] and []. Figures are the approximate maximums.	35
<b>H fps</b>		
<b>+ IS Off</b>	If [Off] is selected, image stabilization will turn [On] during sequential shooting.	—
<b>Lens I.S. Priority</b>	If [On] is selected, priority is given to the lens function operation when using a lens with an image stabilization function.	—
<b>Release Lag-Time</b>	If [Short] is selected, the time lag between fully pressing the shutter button and the shot being taken can be shortened.*	—

\* This will shorten the battery life. Also make sure that the camera is not subject to sharp impacts while in use. Such impacts may cause the monitor to stop displaying subjects. If this happens, turn the power off and on again.

### Disp//PC

MENU → →

Option	Description					
<b>HDMI</b>	[HDMI Out]: Selecting the digital video signal format for connecting to a TV via an HDMI cable. [HDMI Control]: Select [On] to allow the camera to be operated using remotes for TVs that support HDMI control.	82				
<b>Video Out</b>	Choose the video standard ([NTSC] or [PAL]) used in your country or region.	82				
<b>Control Settings</b>	Choose the controls displayed in each shooting mode.	84				
			<b>Shooting mode</b>			
	<b>Controls</b>		<b>P/A/S/M</b>	<b>iAUTO</b>	<b>ART</b>	<b>SCN</b>
	<b>Live Control (P. 46)</b>		On/Off	On/Off	On/Off	On/Off
	<b>Live SCP (P. 85)</b>		On/Off	On/Off	On/Off	On/Off
	<b>Live Guide (P. 43)</b>		—	On/Off	—	—
<b>Art Menu</b>	—	—	On/Off	—		
<b>Scene Menu</b>	—	—	—	On/Off		

Option	Description	
/Info Settings	Choose the information displayed when the <b>INFO</b> button is pressed. [▶ Info]: Choose the information displayed in full frame playback. [LV-Info]: Choose the information displayed when the camera is in shooting mode. [⊞ Settings]: Choose the information displayed in index and calendar playback.	86, 87
Displayed Grid	Select [⊞], [⊞], [⊞], [⊞] or [⊞] to display a grid on the monitor.	—
Picture Mode Settings	Display only the selected picture mode when a picture mode is selected.	—
Histogram Settings	[Highlight]: Choose the lower bound for the highlight display. [Shadow]: Choose the upper bound for the shadow display.	86
Mode Guide	Choose [Off] to not display help for the selected mode when the mode dial is rotated to a new setting.	17
Live View Boost	If [On] is selected, priority will be given to making images clearly visible; the effects exposure compensation and other settings will not be visible in the monitor.	—
Frame Rate	Select [High] to reduce frame lag. However, the image quality may drop.	—
Art LV Mode	[mode1]: The filter effect is always displayed. [mode2]: Filter effects are not visible in the monitor while the shutter button is pressed halfway. Choose for a smooth display.	—
Flicker reduction	Reduce the effects of flicker under some kinds of lighting, including fluorescent lamps. When flicker is not reduced by the [Auto] setting, set to [50Hz] or [60Hz] in accordance with the commercial power frequency of the region where the camera is used.	—
LV Close Up Mode	[mode1]: Pressing the shutter button halfway cancels zoom. [mode2]: Zoom is not cancelled when the shutter button is pressed halfway.	36
Close Up Mode	[mode1]: Press <b>Q</b> to zoom in (to a maximum of 14×) and press  to zoom out. [mode2]: Press <b>Q</b> to display the zoom frame for the specified zoom ratio. Press <b>Q</b> again to zoom in.	—
Backlit LCD	If no operations are performed for the selected period, the backlight will dim to save battery power. The backlight will not dim if [Hold] is selected.	—
Sleep	The camera will enter sleep (energy saving) mode if no operations are performed for the selected period. The camera can be reactivated by pressing the shutter button halfway.	—
(Beep sound)	When set to [Off], you can turn off the beep sound that is emitted when the focus locks by pressing the shutter button.	—
USB Mode	Choose a mode for connecting the camera to a computer or printer. Choose [Auto] to display USB mode options every time the camera is connected.	—

Option	Description	
<b>EV Step</b>	Choose the size of the increments used when selecting shutter speed, aperture, exposure compensation, and other exposure parameters.	—
<b>Noise Reduct.</b>	This function reduces the noise that is generated during long exposures. [Auto]: Noise reduction is only performed at slow shutter speeds. [On]: Noise reduction is performed with every shot. [Off]: Noise reduction off. • Noise reduction requires about twice the time needed to record the image. • Noise reduction turns off automatically during sequential shooting. • This function may not work effectively with some shooting conditions or subjects.	27
<b>Noise Filter</b>	Choose the amount of noise reduction performed at high ISO sensitivities.	—
<b>ISO</b>	Set ISO sensitivity. This is the same as the live control setting.	56
<b>ISO Step</b>	Select the increments available for choosing ISO sensitivity.	—
<b>ISO-Auto Set</b>	Choose the upper limit and default value used for ISO sensitivity when [Auto] is selected for ISO. [High Limit]: Choose the upper limit for auto ISO sensitivity selection. [Default]: Choose the default value for auto ISO sensitivity selection.	—
<b>ISO-Auto</b>	Choose the shooting modes in which [Auto] ISO sensitivity is available. [P/A/S]: Auto ISO sensitivity selection is available in all modes except <b>M</b> . ISO sensitivity is fixed at ISO200 in mode <b>M</b> . [All]: Auto ISO sensitivity selection is available in all modes.	—
<b>Metering</b>	Choose a metering mode according to the scene.	54
<b>AEL Metering</b>	Choose the metering method used for AE lock (P. 80). [Auto]: Use the currently selected metering method.	—
<b>BULB/TIME Timer</b>	Choose the maximum exposure for bulb and time photography.	—
<b>Live BULB</b>	Choose the display interval during shooting. Some restrictions apply. The frequency drops at high ISO sensitivities. Choose [Off] to disable the display. Tap the monitor or press the shutter button halfway to refresh the display.	—
<b>Live TIME</b>		—
<b>Anti-Shock [⬆]</b>	Choose the delay between the shutter button being pressed and the shutter being released. This diminishes camera shake caused by vibrations. This feature is useful in situations such as microscope photography and astrophotography. It is also useful for sequential shooting (P. 35) and self timer photography (P. 35).	—

Option	Description	
X-Sync.	Choose the shutter speed used when the flash fires.	87
Slow Limit	Choose the slowest shutter speed available when a flash is used.	87
+	When set to [On], it will be added to the exposure compensation value and flash intensity control will be performed.	32, 53

Option	Description	
Set	<p>You can select the JPEG image quality mode from combinations of three image sizes and four compression rates.</p> <p>1) Use <math>\triangleleft</math> <math>\triangleright</math> to select a combination ([<math>\triangleleft</math>:1] – [<math>\triangleleft</math>:4]) and use <math>\triangle</math> <math>\nabla</math> to change.</p> <p>2) Press <math>\odot</math>.</p>	52
Pixel Count	<p>Choose the pixel count for [<math>\mathbb{M}</math>]- and [<math>\mathbb{S}</math>]-size images.</p> <p>1) Select [Pixel Count] in the  Custom Menu tab .</p> <p>2) Select [<math>\mathbb{M}</math>iddle] or [<math>\mathbb{S}</math>mall] and press <math>\triangleright</math>.</p> <p>3) Choose a pixel count and press <math>\odot</math>.</p>	52
Shading Comp.	<p>Choose [On] to correct peripheral illumination according to the type of lens.</p> <ul style="list-style-type: none"> <li>• Compensation is not available for teleconverters or extension tubes.</li> <li>• Noise may be visible at the edges of photographs taken at high ISO sensitivities.</li> </ul>	—
WB	Set the white balance. This is the same as the live control setting. You can also fine-tune the white balance for each mode.	50

Option	Description	
All <b>[WB%]</b>	[All Set]: Use the same white balance compensation in all modes except [CWB]. [All Reset]: Set white balance compensation for all modes except [CWB] to 0.	—
<b>WB</b> Auto <b>Keep Warm Color</b>	Select [Off] to eliminate “warm” colors from pictures taken under incandescent lighting.	—
<b>+</b> WB	Adjust white balance for use with a flash.	—
<b>Color Space</b>	You can select how colors are reproduced on the monitor or printer.	—

**Record/Erase**

Option	Description	
<b>Quick Erase</b>	If [On] is selected, pressing the  button in the playback display will immediately delete the current image.	—
<b>RAW+JPEG Erase</b>	Choose the action performed when a photograph recorded at a setting of RAW+JPEG is erased in single-frame playback (P. 21). [JPEG]: Only the JPEG copy is erased. [RAW]: Only the RAW copy is erased. [RAW+JPEG]: Both copies are erased. • Both the RAW and JPEG copies are deleted when selected images are deleted or when [All Erase] (P. 59) is selected.	52
<b>File Name</b>	[Auto]: Even when a new card is inserted, the file numbers are retained from the previous card. File numbering continues from the last number used or from the highest number available on the card. [Reset]: When you insert a new card, the folder numbers starts at 100 and the file name starts at 0001. If a card containing images is inserted, the file numbers start at the number following the highest file number on the card.	—
<b>Edit Filename</b>	Choose how image files are named by editing the portion of the filename highlighted below in gray. sRGB: Pmdd0000.jpg _____ Pmdd AdobeRGB: _mdd0000.jpg _____ mdd	—
<b>Priority Set</b>	Choose the default selection ([Yes] or [No]) for confirmation dialogs.	—
<b>dpi Settings</b>	Choose the print resolution.	—

## Record/Erase

MENU → ⚙ → 📷

Option	Description	👉
<b>Copyright Settings*</b>	<p>Add the names of the photographer and copyright holder to new photographs. Names can be up to 63 characters long.            [Copyright Info.]: Select [On] to include the names of the photographer and copyright holder in the Exif data for new photographs.            [Artist Name]: Enter the name of the photographer.            [Copyright Name]: Enter the name of the copyright holder.</p> <ol style="list-style-type: none"> <li>Highlight a character ① and press <b>OK</b> to add the highlighted character to the name ②.</li> <li>Repeat Step 1 to complete the name, then highlight [END] and press <b>OK</b>.               <ul style="list-style-type: none"> <li>To delete a character, press the <b>INFO</b> button to place the cursor in the name area ②, highlight the character, and press <b>DEL</b>.</li> </ul> </li> </ol>	—

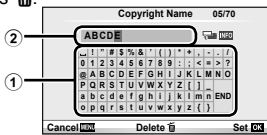

\* OLYMPUS does not accept liability for damages arising from disputes involving the use of [Copyright Settings]. Use at your own risk.

## Movie

MENU → ⚙ → 📷

Option	Description	👉
<b>Mode</b>	Choose a movie record mode. This option can also be selected using the live control.	49
<b>Movie</b>	Choose [Off] to record silent movies. This option can also be selected using the live control.	57
<b>Movie Effect</b>	Choose [On] to enable movie effects in <b>Mode</b> .	87
<b>Wind Noise Reduction</b>	Reduce wind noise during recording.	—
<b>Recording Volume</b>	Adjust microphone sensitivity according to the distance to your subject.	—

## Utility

MENU → ⚙ → 📷

Option	Description	👉
<b>Pixel Mapping</b>	The pixel mapping feature allows the camera to check and adjust the image pickup device and image processing functions.	104
<b>Exposure Shift</b>	<p>Adjust optimal exposure separately for each metering mode.</p> <ul style="list-style-type: none"> <li>This reduces the number of exposure compensation options available in the selected direction.</li> <li>The effects are not visible in the monitor. To make normal adjustments to the exposure, perform exposure compensation (P. 32).</li> </ul>	—

Option	Description	
<b>Warning Level</b>	Choose the battery level at which the  warning is displayed.	15
<b>Level Adjust</b>	You can calibrate the angle of the level gauge. [Reset]: Resets adjusted values to the default settings. [Adjust]: Sets the current camera orientation as the 0 position.	—
<b>Touch Screen Settings</b>	Activate the touch screen. Choose [Off] to disable the touch screen.	—
<b>Eye-Fi*</b>	Enable or disable upload when using an Eye-Fi card.	—

\* Use in accordance with local regulations. Onboard airplanes and in other locations in which the use of wireless devices is prohibited, remove the Eye-Fi card from the camera or select [Off] for [Eye-Fi]. The camera does not support the “endless” Eye-Fi mode.

## AEL/AFL

MENU → ⚙ → ⏪ → [AEL/AFL]

Autofocus and metering can be performed by pressing the button to which AEL/AFL has been assigned. Choose a mode for each focus mode.

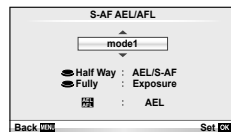

## AEL/AFL

Mode		Shutter button function				Button function	
		Half-press		Full press		When holding down AEL/AFL	
		Focus	Exposure	Focus	Exposure	Focus	Exposure
S-AF	mode1	S-AF	Locked	—	—	—	Locked
	mode2	S-AF	—	—	Locked	—	Locked
	mode3	—	Locked	—	—	S-AF	—
C-AF	mode1	C-AF start	Locked	Locked	—	—	Locked
	mode2	C-AF start	—	Locked	Locked	—	Locked
	mode3	—	Locked	Locked	—	C-AF start	—
	mode4	—	—	Locked	Locked	C-AF start	—
MF	mode1	—	Locked	—	—	—	Locked
	mode2	—	—	—	Locked	—	Locked
	mode3	—	Locked	—	—	S-AF	—



## Button Function

MENU → → → [Button Function]

See the table below for the functions that can be assigned. The options available vary from button to button.

### Button function items

[Fn]Function / [⊙]Function\*<sup>1</sup> / [▷]Function\*<sup>1</sup> / [▽]Function / [⊞]Function (Direct Function)\*<sup>2</sup> / [⋮]Function\*<sup>3</sup> / [L.Fn]Function\*<sup>4</sup>











\*<sup>1</sup> Not available in mode.

\*<sup>2</sup> Assign the function to each of .

\*<sup>3</sup> Choose the AF target.

\*<sup>4</sup> Choose the function assigned to the button on some lenses.

	Adjust exposure compensation.
<b>ISO</b>	Adjust ISO sensitivity.
<b>WB</b>	Adjust white balance.
<b>AEL/AFL</b>	AE lock or AF lock. The function changes according to the [AEL/AFL] setting. When AEL is selected, press the button once to lock the exposure and display [AEL] on the monitor. Press the button again to cancel the lock.
	Press the button to record a movie.
<b>Preview</b>	Aperture is stopped down to the selected value while the button is pressed.
	The camera measures white balance when the button is pressed (P. 51).
[⋮]	Choose the AF target.
[⋮] Home	Pressing the button selects the AF target position saved with [⋮] Set Home] (P. 73). The home AF target position is indicated by a  icon. Press the button again to return to AF target mode. If the camera is turned off when the home position is selected, the home position will be reset.
<b>MF</b>	Press the button to select manual focus mode. Press the button again to restore the previously selected AF mode.
<b>RAW</b>	Press the button to toggle between JPEG and RAW+JPEG record modes.
<b>Test Picture</b>	Pictures taken while the button is pressed are displayed in the monitor but are not recorded to the memory card.
<b>Myset1 – Myset4</b>	The settings switch to the registered Mysets while the button is pressed.
	Turn the monitor backlight on and off.

	The button can be used to choose between  and  while the underwater case is attached. Press and hold the button to return to the previous mode. If this option is selected, the FL-LM1 will fire even when not raised. This enables  (Underwater) to be set in WB mode. When using an ED12-50mmEZ lens with power zoom (E-ZOOM), the lens is automatically zoomed to the WIDE end or TELE end in accordance with  and  switching.
<b>Live Guide</b>	Press the button to display live guides.
 (Digital Tele-converter)	Press the button to turn digital zoom on or off.
<b>AF Stop</b>	Stop autofocus.
 	Choose a sequential shooting or self timer option.
	Choose a flash mode.
<b>HDR BKT</b>	Switch to HDR bracketing with the saved settings.
 <b>Lock</b>	When set to [Off], the aperture, shutter speed, exposure compensation, and other items can be set directly using the dial. Press and hold the button to set to [On].
<b>Off</b>	No function is assigned to the button.

## Viewing camera images on TV

Use the AV cable provided with the camera to playback recorded images on your TV. Connect the camera to an HD TV using an HDMI cable (available from third-party suppliers) to view high-quality images on a TV screen.

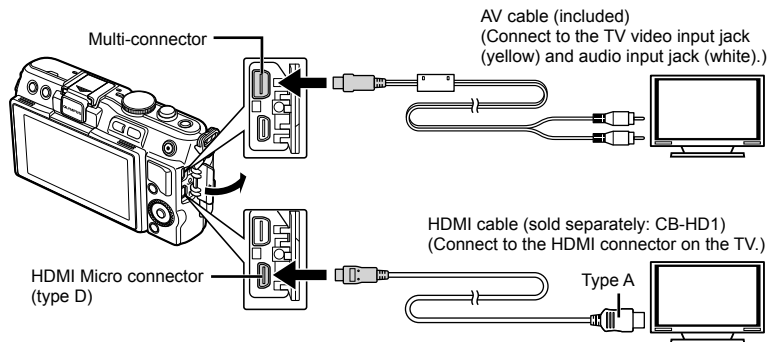

- Use the cable to connect the camera to the TV.
  - Adjust settings on the TV before connecting the camera.
  - Choose the camera video mode before connecting the camera via an AV cable.
- Choose the TV input channel.
  - The camera monitor turns off when the cable is connected.
  - Press the  button when connecting via an AV cable.

## ! Cautions



- For details on changing the input source of the TV, refer to the TV's instruction manual.
- Depending on the TV's settings, the displayed images and information may become cropped.
- If the camera is connected using both an AV and HDMI cables, it will assign priority to HDMI.
- If the camera is connected via an HDMI cable, you will be able to choose the digital video signal type. Choose a format that matches the input format selected with the TV.

<b>1080i</b>	Priority is given to 1080i HDMI output.
<b>720p</b>	Priority is given to 720p HDMI output.
<b>480p/576p</b>	480p/576p HDMI output. 576p is used when [PAL] is selected for [Video Out] (P. 74).

- You cannot shoot pictures or movies when the HDMI cable is connected.
- Do not connect the camera to other HDMI output devices. Doing so may damage the camera.
- HDMI output is not performed while connected via USB to a computer or printer.

## ■ Using the TV remote control

The camera can be operated by a TV remote control when connected to a TV that supports HDMI control.

- 1 Select [HDMI] in  Custom Menu tab .
- 2 Select [HDMI Control] and choose [On].
- 3 Operate the camera by using the TV remote control.
  - You can operate the camera by following the operation guide displayed on the TV.
  - During single-frame playback, you can display or hide the information display by pressing the "Red" button, and display or hide the index display by pressing the "Green" button.
  - Some televisions may not support all features.

## Choosing the control panel displays (📷 Control Settings)

Sets whether or not to display control panels for option selection in each shooting mode.

### Control panels available in each shooting mode

- Pressing the **INFO** button switches to the next panel.

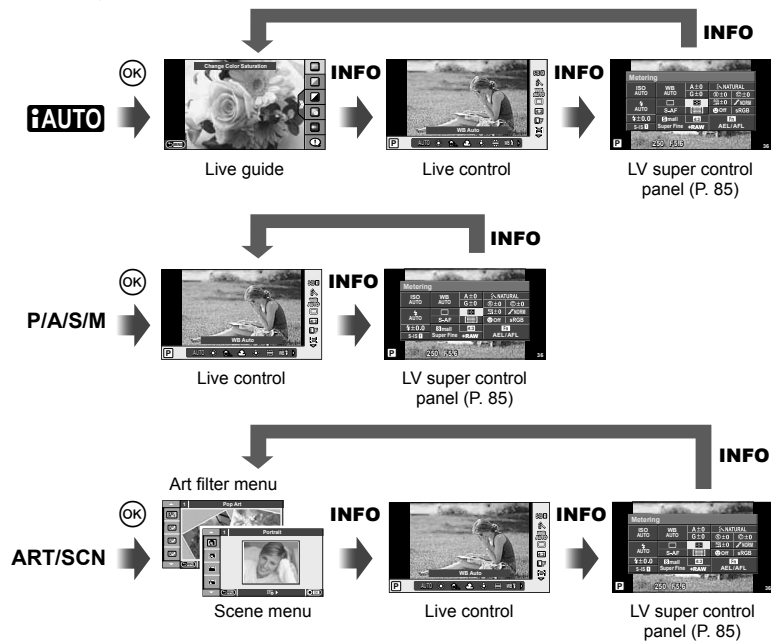

## ■ Using the LV super control panel

The LV super control panel displays the current status of the shooting settings. You can use it to set different options. Select options using the arrow pad or touch operations to change the settings.

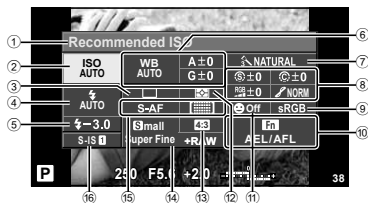

### Settings that can be modified using super control panel

① Currently selected option	B&W Filter (F)..... P. 61
② ISO sensitivity..... P. 56	Picture tone (T)..... P. 61
③ Sequential shooting/self-timer..... P. 35	⑨ Color space..... P. 78
④ Flash mode..... P. 33	⑩ Button function assignment..... P. 81
⑤ Flash intensity control..... P. 53	⑪ Face priority..... P. 56
⑥ White balance..... P. 50	⑫ Metering mode..... P. 54
White balance compensation..... P. 50	⑬ Aspect ratio..... P. 51
⑦ Picture mode..... P. 48	⑭ Record mode..... P. 52
⑧ Sharpness (S)..... P. 61	⑮ AF mode..... P. 55
Contrast (C)..... P. 61	AF target..... P. 35
Saturation (RGB)..... P. 61	⑯ Image stabilizer..... P. 47
Gradation..... P. 61	

### ! Cautions

- Not displayed in movie record mode.

- After displaying the LV super control panel, select the desired setting using  $\Delta$   $\nabla$   $\triangleleft$   $\triangleright$  and press  $\odot$ .
  - You can also select settings using the control dial.
- Select an option using  $\triangleleft$   $\triangleright$  and press  $\odot$ .
  - Repeat steps 1 and 2 as necessary.
  - The selected settings take effect automatically if no operations are performed for a few seconds.
- Press the shutter button halfway to return to shooting mode.



## Adding information displays (Info/Info Settings)

### LV-Info (Shooting information displays)

Use [LV-Info] to add the following shooting information displays. The added displays are displayed by repeatedly pressing the **INFO** button during shooting. You can also choose to not show displays that appear at the default setting.



Histogram display



Highlight & Shadow display

### Highlight & Shadow display

Areas above the upper limit of brightness for the image are shown in red, those below the lower limit in blue. [Histogram Settings] [Info] "Disp/Info"/PC" (P. 75)

### Info (Playback information displays)

Use [Info] to add the following playback information displays. The added displays are displayed by repeatedly pressing the **INFO** button during playback. You can also choose to not show displays that appear at the default setting.



Histogram display



Highlight & Shadow display



Light box display

### Light box display

[Close Up Mode] in the custom menu must be set to [mode2] to show this display.

Compare two images side-by-side. Press **OK** to select the image on the opposite side of the display.

- The base image is displayed on the right. Use **<>** to select an image and press **OK** to move the image to the left. The image to be compared to the image on the left can be selected on the right. To choose a different base image, highlight the right frame and press **OK**.
- Press **Q** to zoom in on the current image. To change the zoom ratio, press the **INFO** button and use **Δ**/**∇** or the control dial.
- Use **Δ**/**∇**/**<>** to view other areas of the picture. The image displayed changes each time **Q** is pressed.



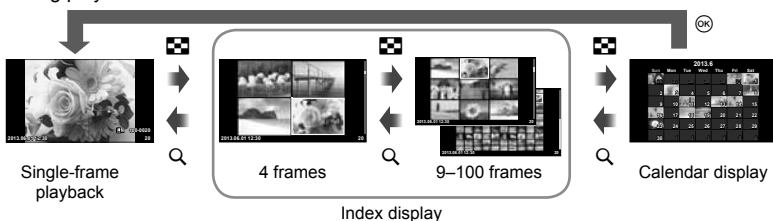

## Settings (Index/calendar display)

You can add an index display with a different number of frames and calendar display using [Settings]. The additional screens are displayed by pressing the  button during playback.



## Shutter speeds when the flash fires automatically [ X-Sync.] [ Slow Limit]



You can set shutter speed conditions for when the flash fires.

Shooting mode	Flash timing (synchronous)	Upper limit	Lower limit
<b>P</b>	The slower of 1/(lens focal length×2) and the [  X-Sync.] settings	[  X-Sync.] setting*	[  Slow Limit] setting
<b>A</b>			
<b>S</b>	The set shutter speed		No lower limit
<b>M</b>			



\* 1/200 seconds when using a separately sold external flash.

## Adding effects to a movie [Movie Effect]

You can add effects to a movie using [Movie Effect]. Set [Movie Effect] to [On] in the menu before selecting the effects.

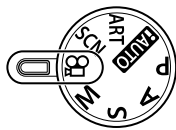
- 1 Rotate the mode dial to .
- 2 Press the  button to begin recording.
  - Press the  button again to end recording.
- 3 Press the following buttons to use effects.



	<b>Multi Echo</b>	Apply an after-image effect. After-images will appear behind moving objects.
	<b>One Shot Echo</b>	An after-image will appear for a short time after you press the button. The after-image will disappear automatically after a while.
<b>Fn</b>	<b>Art Fade</b>	Film with the selected picture mode effect. The fade effect is applied to the transition between scenes.
	<b>Movie Tele-converter</b>	Zoom in on an area of the image without using the lens zoom. Zoom in on the selected position of the image even while the camera is kept fixed.

### **Multi Echo**

Press  $\nabla$  to apply movie effects. Press  $\nabla$  again to cancel the movie effects.

### **One Shot Echo**

The effect is added each time  $\triangleright$  is pressed.

### **Art Fade**

Press the **Fn** button and then rotate the control dial to select the picture mode. Press  $\odot$  or wait about 4 seconds for the effect to be applied.

### **Movie Tele-converter**

- 1 Press the **Q** button to display the zoom frame.
  - Use  $\Delta \nabla \triangleleft \triangleright$  or touch screen operations to change the position of the zoom frame.
  - Press and hold  $\odot$  to return the zoom frame to the center of the monitor.
- 2 Press the **Q** button again.
  - The display zooms in on the area inside the zoom frame.
  - Press the **Q** button again to return to the original display.
  - Press  $\odot$  to exit the movie tele-converter mode.

### **! Cautions**

- The frame rate will drop slightly during recording.
- The 2 effects cannot be applied simultaneously.
- Use a memory card with an SD speed class of 6 or better. Movie recording may end unexpectedly if a slower card is used.
- Taking a photograph during movie recording cancels the effect; the effect does not appear in the photograph.
- [Diorama] and Art Fade-in cannot be used simultaneously.
- Movie Tele-converter cannot be used when [Picture Mode] is set to [ART].
- Button operation sounds may be recorded.



## Accessory Port Menu

### Using OLYMPUS PENPAL

The optional OLYMPUS PENPAL can be used to upload pictures to, and receive pictures from, Bluetooth devices or other cameras connected to an OLYMPUS PENPAL. Visit the OLYMPUS website for more information on Bluetooth devices.

#### ■ Sending images

Resize and upload JPEG images to another device. Before sending images, make sure that the receiving device is set to the mode for receiving data.

- 1 Display the picture you wish to send full frame and press **OK**.
- 2 Select [Send A Picture] and press **OK**.
  - Select [Search] and press **OK** in the next dialog. The camera searches for and displays Bluetooth devices in range or in [Address Book].
- 3 Select the destination and press **OK**.
  - The image will be uploaded to the receiving device.
  - If prompted to provide a PIN code, enter 0000 and press **OK**.

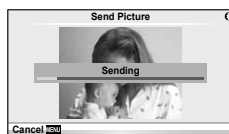

#### ■ Receiving images/adding a host

Connect to the transmitting device and download JPEG images.

- 1 Select [OLYMPUS PENPAL Share] in **Accessory Port Menu** (P. 72).
- 2 Select [Please Wait] and press **OK**.
  - Perform operations for sending images on the sending device.
  - Transmission will start and a [Receive Picture Request] dialog will be displayed.
- 3 Select [Accept] and press **OK**.
  - The image will be downloaded to the camera.
  - If prompted to provide a PIN code, enter 0000 and press **OK**.

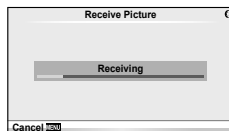
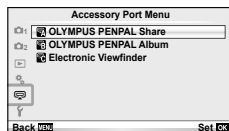

## ■ Editing the address book

The OLYMPUS PENPAL can store host information. You can assign names to hosts or delete host information.

- 1 Select [OLYMPUS PENPAL Share] in the Accessory Port Menu (P. 72).
- 2 Select [Address Book] and press **OK**.
- 3 Select [Address List] and press **OK**.
  - The names of existing hosts are listed.
- 4 Select the host you wish to edit and press **OK**.

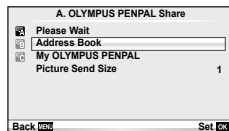

### Deleting hosts

Select [Yes] and press **OK**.

### Editing host information

Press **OK** to display host information. To change the host name, press **OK** again and edit the current name in the rename dialog.

## ■ Creating albums

Your favorite JPEG pictures can be resized and copied to an OLYMPUS PENPAL.

- 1 Display the picture you wish to copy full frame and press **OK**.
- 2 Select [**Sd** → **PENPAL**] and press **OK**.
  - To copy images from an OLYMPUS PENPAL to the memory card, select [**PENPAL** → **Sd**] and press **OK**.



## ⚠ Cautions

- The OLYMPUS PENPAL can be used only in the region in which it was purchased. Depending on the areas, the usage may infringe the wave regulations and may be subject to its penalty.

## OLYMPUS PENPAL Share

MENU → →

Option	Description	
<b>Please Wait</b>	Receive images and add hosts to the address book.	89
<b>Address Book</b>	[Address List]: View the hosts that have been saved to the address book. [New Pairing]: Add a host to the address book. [Search Timer]: Choose how long the camera searches for a host.	90

## OLYMPUS PENPAL Share

MENU → → →

Option	Description	
<b>My OLYMPUS PENPAL</b>	Display information for your OLYMPUS PENPAL, including the name, address, and supported services. Press <b>OK</b> to edit the device name.	90
<b>Picture Send Size</b>	Choose the size at which images are transmitted. [Size 1: Small]: Images are sent at a size equivalent to 640 × 480. [Size 2: Large]: Images are sent at a size equivalent to 1920 × 1440. [Size 3: Medium]: Images are sent at a size equivalent to 1280 × 960.	89

## OLYMPUS PENPAL Album

MENU → → →

Option	Description	
<b>Copy All</b>	All images and sound files are copied between the SD card and OLYMPUS PENPAL. Copied images are resized according to the option selected for picture copy size.	90
<b>Reset Protect</b>	Remove protection from all pictures in the OLYMPUS PENPAL album.	90
<b>Album Mem. Usage</b>	Show the number of pictures currently in the album and the number of additional pictures that can be stored at [Size 2: Medium].	90
<b>Album Mem. Setup</b>	[All Erase]: Delete all pictures in the album. [Format Album]: Format the album.	90
<b>Picture Copy Size</b>	Choose the size at which images are copied. [Size 1: Large]: Copied images are not resized. [Size 2: Medium]: Images are copied at a size equivalent to 1920 × 1440.	90

## Electronic Viewfinder

MENU → → →

Option	Description		
<b>EVF Adjust</b>	Adjust the brightness and the color temperature of optional external viewfinders. The selected color temperature is also used in the monitor during playback. Use <b>&lt;D&gt;</b> to select color temperature (☼) or brightness (☼) and use <b>Δ</b> <b>▽</b> to choose from values between [+7] and [-7].		—
<b>EVF Auto Switch</b>	Sets whether to automatically switch the display away from the monitor when using the VF-4 external electronic viewfinder. When set to [Off], pressing the <b>□</b> button on the external viewfinder switches the display between the viewfinder and the monitor. When set to [On], the display automatically switches to VF-4 when you look through it.	113	

# 4 Printing pictures

## Print reservation (DPOF)

You can save digital “print orders” to the memory card listing the pictures to be printed and the number of copies of each print. You can then have the pictures printed at a print shop that supports DPOF or print the pictures yourself by connecting the camera directly to a DPOF printer. A memory card is required when creating a print order.

### Creating a print order

- 1 Press **[OK]** during playback and select **[P]**.
- 2 Select **[P]** or **[P]** and press **[OK]**.

#### Individual picture

Press **[<|>]** to select the frame that you want to set as print reservation, then press **[Δ]** **[▽]** to set the number of prints.

- To set print reservation for several pictures, repeat this step. Press **[OK]** when all the desired pictures have been selected.

#### All pictures

Select **[P]** and press **[OK]**.

- 3 Select the date and time format and press **[OK]**.

<b>No</b>	The pictures are printed without the date and time.
<b>Date</b>	The pictures are printed with the shooting date.
<b>Time</b>	The pictures are printed with the shooting time.

- 4 Select **[Set]** and press **[OK]**.

#### ! Cautions

- The camera cannot be used to modify print orders created with other devices. Creating a new print order deletes any existing print orders created with other devices.
- Print orders cannot include 3D photos, RAW images, or movies.

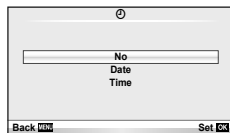
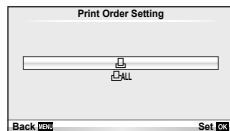

## Removing all or selected pictures from the print order

You can reset all print reservation data or just the data for selected pictures.

- 1 Press **[OK]** during playback and select **[F4]**.
- 2 Select **[F4]** and press **[OK]**.
  - To remove all pictures from the print order, select **[Reset]** and press **[OK]**.  
To exit without removing all pictures, select **[Keep]** and press **[OK]**.
- 3 Press **[Left/Right]** to select images you wish to remove from the print order.
  - Use **[Down]** to set the number of prints to 0. Press **[OK]** once you have removed all the desired pictures from the print order.
- 4 Select the date and time format and press **[OK]**.
  - This setting is applied to all frames with print reservation data.
- 5 Select **[Set]** and press **[OK]**.

## Direct printing (PictBridge)

By connecting the camera to a PictBridge-compatible printer with the USB cable, you can print out recorded pictures directly.

- 1 Connect the camera to the printer using the supplied USB cable and turn the camera on.

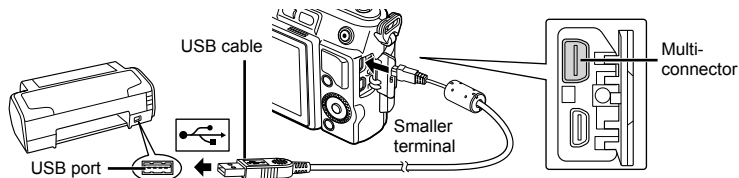

- Use a fully charged battery for printing.
- When the camera is turned on, a dialog should be displayed in the monitor prompting you to choose a host. If it is not, select **[Auto]** for **[USB Mode]** (P. 75) in the camera custom menus.

- 2 Use **[Up/Down]** to select **[Print]**.
  - **[One Moment]** will be displayed, followed by a print-mode selection dialog.
  - If the screen is not displayed after a few minutes, disconnect the USB cable and start again from Step 1.

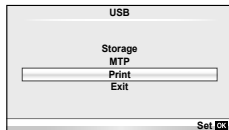

### Proceed to “Custom printing” (P. 94).

#### ⚠ Cautions

- 3D photos, RAW images, and movies cannot be printed.

## Easy printing

Use the camera to display the picture you wish to print before connecting the printer via the USB cable.

- 1 Use ◀▶ to display the pictures you want to print on the camera.
- 2 Press ▷.
  - The picture selection screen appears when printing is completed. To print another picture, use ◀▶ to select the image and press Ⓞ.
  - To exit, unplug the USB cable from the camera while the picture selection screen is displayed.



## Custom printing

- 1 Follow the operation guide to set a print option.

### Selecting the print mode

Select the type of printing (print mode). The available print modes are as shown below.

<b>Print</b>	Prints selected pictures.
<b>All Print</b>	Prints all the pictures stored in the card and makes one print for each picture.
<b>Multi Print</b>	Prints multiple copies of one image in separate frames on a single sheet.
<b>All Index</b>	Prints an index of all the pictures stored in the card.
<b>Print Order</b>	Prints according to the print reservation you made. If there is no picture with print reservation, this is not available.

### Setting the print paper items

This setting varies with the type of printer. If only the printer's STANDARD setting is available, you cannot change the setting.

<b>Size</b>	Sets the paper size that the printer supports.
<b>Borderless</b>	Selects whether the picture is printed on the entire page or inside a blank frame.
<b>Pics/Sheet</b>	Selects the number of pictures per sheet. Displayed when you have selected [Multi Print].

### Selecting pictures you want to print



Select pictures you want to print. The selected pictures can be printed later (single-frame reservation) or the picture you are displaying can be printed right away.



<b>Print (OK)</b>	Prints the currently displayed picture. If there is a picture that [Single Print] reservation has already been applied to, only that reserved picture will be printed.
<b>Single Print (▲)</b>	Applies print reservation to the currently displayed picture. If you want to apply reservation to other pictures after applying [Single Print], use < > to select them.
<b>More (v)</b>	Sets the number of prints and other items for the currently displayed picture, and whether or not to print it. For operation, refer to "Setting printing data" in the next section.

### Setting printing data

Select whether to print printing data such as the date and time or file name on the picture when printing. When the print mode is set to [All Print] and [Option Set] is selected, the following options appears.

 x	Sets the number of prints.
<b>Date</b>	Prints the date and time recorded on the picture.
<b>File Name</b>	Prints the file name recorded on the picture.
	Trims the picture for printing. Use the dial to choose the crop size and ▲ ▼ < > to position the crop.

**2** Once you have set the pictures for printing and printing data, select [Print], then press **OK**.

- To stop and cancel printing, press **OK**. To resume printing, select [Continue].

### ■ Cancelling printing

To cancel printing, highlight [Cancel] and press **OK**. Note that any changes to the print order will be lost; to cancel printing and return to the previous step, where you can make changes to the current print order, press **MENU**.

# 5 Connecting the camera to a computer

## Installing the PC software

### ■ Windows

1 Insert the supplied CD in a CD-ROM drive.

#### Windows XP

- A "Setup" dialog will be displayed.

#### Windows Vista/Windows 7/Windows 8

- An Autorun dialog will be displayed. Click "OLYMPUS Setup" to display the "Setup" dialog.



#### ⚠ **Cautions**

- If the "Setup" dialog is not displayed, select "My Computer" (Windows XP) or "Computer" (Windows Vista/Windows 7) from the start menu. Double-click the CD-ROM (OLYMPUS Setup) icon to open the "OLYMPUS Setup" window and then double-click "LAUNCHER.EXE".
- If a "User Account Control" dialog is displayed, click "Yes" or "Continue".

2 Follow the on-screen instructions on your computer.

#### ⚠ **Cautions**

- If nothing is displayed on the camera screen even after connecting the camera to the computer, the battery may be exhausted. Use a full-charged battery.

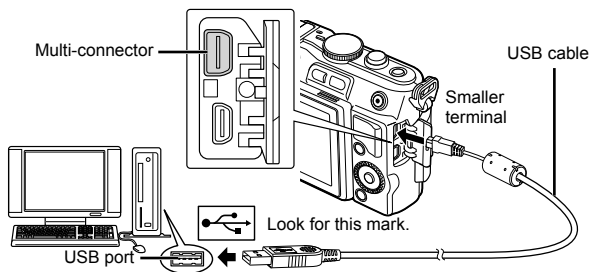

#### ⚠ **Cautions**

- When the camera is connected to another device via USB, a message will be displayed prompting you to choose a connection type. Select [Storage].



### 3 Register your Olympus product.

- Click the “Registration” button and follow the on-screen instructions.

### 4 Install OLYMPUS Viewer 3.

- Check the system requirements before beginning installation.
- Click the “OLYMPUS Viewer 3” button and follow the on-screen instructions to install the software.

<b>Operating System</b>	Windows XP (Service Pack 2 or later)/Windows Vista/Windows 7/Windows 8
<b>Processor</b>	Pentium 4 1.3 GHz or better (Core2Duo 2.13 GHz or better required for movies)
<b>RAM</b>	1 GB or more (2 GB or more recommended)
<b>Free Hard Drive Space</b>	3 GB or more
<b>Monitor Settings</b>	1024 × 768 pixels or more Minimum 65,536 colors (16,770,000 colors recommended)

- See online help for information on using the software.

## ■ Macintosh

### 1 Insert the supplied CD in a CD-ROM drive.

- The disk contents should automatically be displayed in the Finder. If they are not, double-click the CD icon on the desktop.
- Double-click the “Setup” icon to display the “Setup” dialog.



### 2 Install OLYMPUS Viewer 3.

- Check the system requirements before beginning installation.
- Click the “OLYMPUS Viewer 3” button and follow the on-screen instructions to install the software.



<b>Operating System</b>	Mac OS X v10.5–v10.8
<b>Processor</b>	Intel Core Solo/Duo 1.5 GHz or better (Core2Duo 2 GHz or better required for movies)
<b>RAM</b>	1 GB or more (2 GB or more recommended)
<b>Free Hard Drive Space</b>	3 GB or more
<b>Monitor Settings</b>	1024 × 768 pixels or more Minimum 32,000 colors (16,770,000 colors recommended)

- Other languages can be selected from the language combo box. For information on using the software, see online help.

## Copying pictures to a computer without OLYMPUS Viewer 3

Your camera supports the USB Mass Storage Class. You can transfer images to a computer by connecting the camera to the computer with the provided USB cable. The following operating systems are compatible with the USB connection:

**Windows:** Windows XP Home Edition/  
Windows XP Professional/  
Windows Vista/Windows 7/Windows 8

**Macintosh:** Mac OS X v.10.3 or later

- 1 Turn the camera off and connect it to the computer.
  - The location of the USB port varies with the computer. For details, refer to your computer's manual.
- 2 Turn on the camera.
  - The selection screen for the USB connection is displayed.
- 3 Press  $\Delta$   $\nabla$  to select [Storage]. Press  $\text{OK}$ .
- 4 The computer recognizes the camera as a new device.

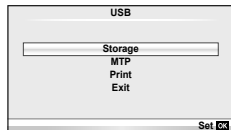

### **!** Cautions

- If you are using Windows Photo Gallery for Windows Vista, Windows 7 or Windows 8, choose [MTP] in Step 3.
- Data transfer is not guaranteed in the following environments, even if your computer is equipped with a USB port.
  - Computers with a USB port added by means of an extension card, etc.
  - Computers without a factory-installed OS
  - Home-built computers
- Camera controls cannot be used while the camera is connected to a computer.
- If the dialog shown in Step 2 is not displayed when the camera is connected to a computer, select [Auto] for [USB Mode] (P. 75) in the camera custom menus.

## Shooting tips and information

### The camera does not turn on even when a battery is loaded

#### The battery is not fully charged

- Charge the battery with the charger.

#### The battery is temporarily unable to function because of the cold

- Battery performance drops at low temperatures. Remove the battery and warm it by putting it in your pocket for a while.

### No picture is taken when the shutter button is pressed

#### The camera has turned off automatically

- The camera automatically enters sleep mode to reduce the drain on the battery if no operations are performed for a set period of time.  [Sleep] (P. 75)  
If no operations are performed for a set time (5 minutes) after the camera has entered sleep mode, the camera will turn off automatically.

#### The flash is charging

- On the monitor, the  mark blinks when charging is in progress. Wait for the blinking to stop, then press the shutter button.

#### Unable to focus

- The camera cannot focus on subjects that are too close to the camera or that are not suited to autofocus (the AF confirmation mark will blink in the monitor). Increase the distance to the subject or focus on a high contrast object at the same distance from the camera as your main subject, compose the shot, and shoot.

#### Subjects that are difficult to focus on

It may be difficult to focus with auto focus in the following situations.

AF confirmation mark is blinking. These subjects are not focused.

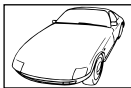

Subject with low contrast

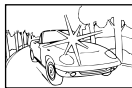

Excessively bright light in center of frame

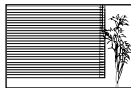

Subject containing no vertical lines

AF confirmation mark lights up but the subject is not focused.



Subjects at different distances

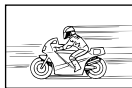

Fast-moving subject



Subject not inside AF area

### Noise reduction is activated

- When shooting night scenes, shutter speeds are slower and noise tends to appear in images. The camera activates the noise-reduction process after shooting at slow shutter speeds. During which, shooting is not allowed. You can set [Noise Reduct.] to [Off].  
 [Noise Reduct.] (P. 76)

### The number of AF targets is reduced

The number and size of AF targets varies with aspect ratio, group target settings, and the option selected for [Digital Tele-converter].

### The date and time has not been set

#### The camera is used with the settings at the time of purchase

- The date and time of the camera is not set when purchased. Set the date and time before using the camera.  "Setting the date/time" (P. 16)

#### The battery has been removed from the camera

- The date and time settings will be returned to the factory default settings if the camera is left without the battery for approximately 1 day. The settings will be cancelled more quickly if the battery was only loaded in the camera for a short time before being removed. Before taking important pictures, check that the date and time settings are correct.

### Set functions are restored to their factory default settings

When you rotate the mode dial or turn off the power in a shooting mode other than **P**, **A**, **S**, or **M**, functions with changes made to their settings are restored to the factory default settings.

### Image taken appears whitish

This may occur when the picture is taken in backlight or semi-backlight conditions. This is due to a phenomenon called flare or ghosting. As far as possible, consider a composition where strong light source is not taken in the picture. Flare may occur even when a light source is not present in the picture. Use a lens hood to shade the lens from the light source. If a lens hood does not have effect, use your hand to shade the lens from the light.

 "Interchangeable lenses" (P. 107)

### Unknown bright dot(s) appear on the subject in the picture taken









This may be due to stuck pixel(s) on the image pickup device. Perform [Pixel Mapping]. If the problem persists, repeat pixel mapping a few times.  "Pixel Mapping - Checking the image processing functions" (P. 104)





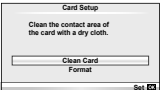



### Functions that cannot be selected from menus

Some items may not be selectable from the menus when using the arrow pad.

- Items that cannot be set with the current shooting mode.
- Items that cannot be set because of an item that has already been set:  
Combination of [] and [Noise Reduct.], etc.

## Error codes

Monitor indication	Possible cause	Corrective action
 No Card	The card is not inserted, or it cannot be recognized.	Insert a card or insert a different card.
 Card Error	There is a problem with the card.	Insert the card again. If the problem persists, format the card. If the card cannot be formatted, it cannot be used.
 Write Protect	Writing to the card is prohibited.	The card write-protect switch is set to the "LOCK" side. Release the switch. (P. 106)
 Card Full	<ul style="list-style-type: none"> <li>The card is full. No more pictures can be taken or no more information such as print reservation can be recorded.</li> <li>There is no space in the card and print reservation or new images cannot be recorded.</li> </ul>	Replace the card or erase unwanted pictures. Before erasing, download important images to a PC.
	Card cannot be read. Card may not have been formatted.	<ul style="list-style-type: none"> <li>Select [Clean Card], press <math>\odot</math> and turn off the camera. Remove the card and wipe dry the metallic surface with a soft, dry cloth.</li> <li>Select [Format] <math>\blacktriangleright</math> [Yes], and then press <math>\odot</math> to format the card. Formatting the card erases all data on the card.</li> </ul>
 No Picture	There are no pictures on the card.	The card contains no pictures. Record pictures and play back.
 Picture Error	The selected picture cannot be displayed for playback due to a problem with this picture. Or the picture cannot be used for playback on this camera.	Use image processing software to view the picture on a PC. If that cannot be done, the image file is damaged.
 The Image Cannot Be Edited	Pictures taken with another camera cannot be edited on this camera.	Use image processing software to edit the picture.
 Picture Error	Images cannot be transferred between devices that are currently receiving or transmitting data.	Increase the amount of memory available on the card, for example by deleting unwanted images, or choose a smaller size for the images being transmitted.

Monitor indication	Possible cause	Corrective action
 °C/°F		Turn off the camera and wait for the internal temperature to cool.
 Internal camera temperature is too high. Please wait for cooling before camera use.	The internal temperature of the camera has risen due to sequential shooting.	Wait a moment for the camera to turn off automatically. Allow the internal temperature of the camera to cool before resuming operations.
 Battery Empty	The battery is drained.	Charge the battery.
 No Connection	The camera is not correctly connected to a computer, printer, HDMI display, or other device.	Reconnect the camera.
 No Paper	There is no paper in the printer.	Load some paper in the printer.
 No Ink	The printer has run out of ink.	Replace the ink cartridge in the printer.
 Jammed	The paper is jammed.	Remove the jammed paper.
Settings Changed	The printer's paper cassette has been removed or the printer has been manipulated while making settings on the camera.	Do not manipulate the printer while making settings on the camera.
 Print Error	There is a problem with the printer and/or camera.	Turn off camera and printer. Check the printer and remedy any problems before turning the power on again.
 Cannot Print	Pictures recorded on other cameras may not be printed on this camera.	Use a personal computer to print.
The lens is locked. Please extend the lens.	The lens of the retractable lens stays retracted.	Extend the lens. (P. 13)
Please check the status of a lens.	An abnormality has occurred between the camera and the lens.	Turn off the camera, check the connection with the lens, and turn the power on again.

## Cleaning and storing the camera

### Cleaning the camera

Turn off the camera and remove the battery before cleaning the camera.

#### Exterior:

- Wipe gently with a soft cloth. If the camera is very dirty, soak the cloth in mild soapy water and wring well. Wipe the camera with the damp cloth and then dry it with a dry cloth. If you have used the camera at the beach, use a cloth soaked in clean water and well wrung.
- If blotches appear on the surface of the grip, wipe them off with a cloth.

#### Monitor:

- Wipe gently with a soft cloth.

#### Lens:

- Blow dust off the lens with a commercially available blower. For the lens, wipe gently with a lens cleaning paper.

### Storage

- When not using the camera for a prolonged period, remove the battery and card. Store the camera in a cool, dry place that is well ventilated.
- Insert the battery periodically and test the camera's functions.
- Remove dust and other foreign matter from the body and rear caps before attaching them.
- Attach the body cap to the camera to prevent dust from getting inside when no lens is attached. Be sure to replace the front and rear lens caps before putting the lens away.
- Clean the camera after use.
- Do not store with insect repellent.

### Cleaning and checking the image pickup device

This camera incorporates a dust reduction function to keep dust from getting on the image pickup device and to remove any dust or dirt from the image pickup device surface with ultrasonic vibrations. The dust reduction function operates when the camera is turned on.





The dust reduction function operates at the same time as the pixel mapping, which checks the image pickup device and image processing circuitry. Since dust reduction is activated every time the camera's power is turned on, the camera should be held upright for the dust reduction function to be effective.

#### **Cautions**

- Do not use strong solvents such as benzene or alcohol, or a chemically treated cloth.
- Avoid storing the camera in places where chemicals are treated, in order to protect the camera from corrosion.
- Mold may form on the lens surface if the lens is left dirty.
- Check each part of the camera before use if it has not been used for a long time. Before taking important pictures, be sure to take a test shot and check that the camera works properly.

## Pixel Mapping - Checking the image processing functions

The pixel mapping feature allows the camera to check and adjust the image pickup device and image processing functions. After using the monitor or taking continuous shots, wait for at least one minute before using the pixel mapping function to ensure that it operates correctly.

- 1 Select [Pixel Mapping] in , Custom Menu (P. 79) tab .
  - 2 Press , then press .
- The [Busy] bar is displayed when pixel mapping is in progress. When pixel mapping is finished, the menu is restored.

### **Cautions**

- If you accidentally turn the camera off during pixel mapping, start again from Step 1.



# 7 Battery and charger

## Battery and charger

- Use the single Olympus lithium-ion battery. Use only genuine OLYMPUS rechargeable batteries.
- The camera's power consumption varies widely with usage and other conditions.
- As the following consume a lot of power even without shooting, the battery will be drained quickly.
  - Performing auto focus repeatedly by pressing the shutter button halfway in shooting mode.
  - Displaying images on the monitor for a prolonged period.
  - When connected to a computer or printer.
- When using a drained battery, the camera may turn off without the low battery warning being displayed.
- The battery will not be fully charged at the time of purchase. Charge the battery using the provided charger before use.
- The normal charging time using the provided charger is approximately 3 hours 30 minutes (estimated).
- Do not attempt to use chargers not specifically designated for use with the supplied battery, or to use batteries not specifically designated for use with the supplied charger.

### **Cautions**

- There is a risk of explosion if the battery is replaced with the incorrect battery type. Dispose of the used battery following the instructions "Battery Handling Precautions" (P. 126).

## Using your charger abroad

- The charger can be used in most home electrical sources within the range of 100V to 240V AC (50/60Hz) around the world. However, depending on the country or area you are in, the AC wall outlet may be shaped differently and the charger may require a plug adapter to match the wall outlet. For details, ask at your local electrical shop or travel agent.
- Do not use commercially available travel adapters as the charger may malfunction.

## Usable cards

In this manual, all storage devices are referred to as “cards.” The following types of SD memory card (commercially available) can be used with this camera: SD, SDHC, SDXC, Eye-Fi, and FlashAir (with wireless LAN function). For the latest information, please visit the Olympus website.



### SD card write protect switch

The SD card body has a write protect switch. If you set the switch to the “LOCK” side, you will not be able to write to the card, delete data or format. Return the switch to the unlock position enable writing.

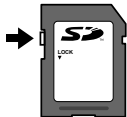

### ! Cautions

- The data in the card will not be erased completely even after formatting the card or deleting the data. When discarding, destroy the card to prevent leakage of personal information.
- “FlashAir” cards cannot be formatted. Use the software supplied with the FlashAir card to format the card.
- Use the FlashAir or Eye-Fi card in compliance with the laws and regulations of the country where the camera is used. Remove the FlashAir or Eye-Fi card from the camera or disable the card functions in airplanes and other locations where use is prohibited.
  - ☞ “Using the Smartphone connection option” (P. 70), [Eye-Fi] (P. 80)
- The FlashAir or Eye-Fi card may become hot during use.
- When using a FlashAir or Eye-Fi card, the battery may run out faster.
- When using a FlashAir or Eye-Fi card, the camera may function more slowly.
- If you set the write protect switch of a FlashAir card to the “LOCK” side, you will not be able to use the wireless LAN function.

## 9

## Interchangeable lenses

Choose a lens according to the scene and your creative intent. Use lenses designed exclusively for the Micro Four Thirds system and bearing the M.ZUIKO DIGITAL label or the symbol shown at right. With an adapter, you can also use Four Thirds System and OM System lenses.



### ! Cautions

- When you attach or remove the body cap and lens from the camera, keep the lens mount on the camera pointed downward. This helps prevent dust and other foreign matter from getting inside the camera.
- Do not remove the body cap or attach the lens in dusty places.
- Do not point the lens attached to the camera toward the sun. This may cause the camera to malfunction or even ignite due to the magnifying effect of sunlight focusing through the lens.
- Be careful not to lose the body cap and rear cap.
- Attach the body cap to the camera to prevent dust from getting inside when no lens is attached.

## M.ZUIKO DIGITAL lens specifications

### ■ Names of parts

- ① Front cap
- ② Filter mount thread
- ③ Focus ring
- ④ Zoom ring (zoom lenses only)
- ⑤ Mount index
- ⑥ Rear cap
- ⑦ Electrical contacts
- ⑧ UNLOCK switch (only retractable lenses)
- ⑨ Decoration ring (only some lenses, remove when attaching a lens hood)

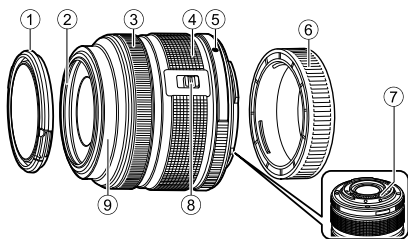

### ■ Using power zoom lenses with macro functions (ED12-50mm f3.5-6.3EZ)

Lens operation is determined by the position of the zoom ring.

#### MACRO button

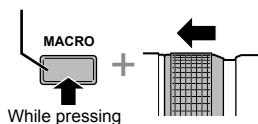

#### Zoom ring

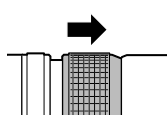
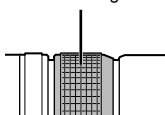

<b>E-ZOOM (Power Zoom)</b>	Rotate the zoom ring for power zoom. Zoom speed is determined by the amount of rotation.
<b>M-ZOOM (Manual Zoom)</b>	Rotate the zoom ring to zoom in and out.
<b>MACRO (Macro Photography)</b>	To photograph subjects at a range of 0.2 to 0.5 m, press the MACRO button and slide the zoom ring forward. Zoom is not available.

- The role of the L-Fn button can be selected in the camera custom menu.

### ■ Snapshot focus control (17mm f1.8, ED12mm f2.0)

Slide the focus ring in the direction of the arrow to change the focus method.

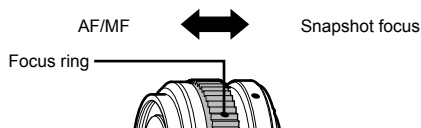

With snapshot focus, a distance is set using the focus ring based on the shooting distance. The camera focuses over a depth of field corresponding to the set aperture value.

- We recommend setting the aperture to at least F5.6.
- You can shoot at the selected distance irrespective of the AF mode on the camera.

### ■ Cap lens control (BCL-1580)

Use the MF lever to open and close the lens barrier, and adjust the focus between infinity and close-up.

- There is no data communication between camera and lens.
- Some functions of the camera cannot be used.
- Set the focal distance to 15 mm for the image stabilization function.

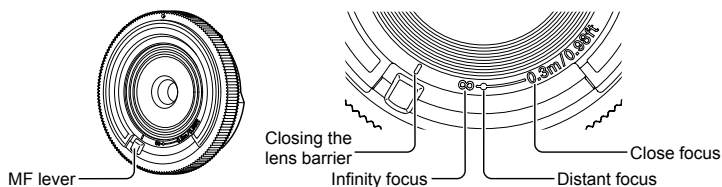

### ■ Lens and camera combinations

Lens	Camera	Attachment	AF	Metering
Micro Four Thirds system lens	Micro Four Thirds system camera	Yes	Yes	Yes
Four Thirds system lens		Attachment possible with mount adapter	Yes*1	Yes
OM System lenses			No	Yes*2
Micro Four Thirds system lens	Four Thirds System Camera	No	No	No

\*1 [C-AF] and [C-AF+TR] of [AF Mode] cannot be used.

\*2 Accurate metering is not possible.

## ■ Main lens specifications

Items	14-42mm f3.5-5.6 II R	ED40-150mm f4.0-5.6R	ED14-150mm f4.0-5.6
Mount	Micro Four Thirds mount		
Focal length	14–42 mm	40–150 mm	14–150 mm
Max. aperture	f/3.5–5.6	f/4.0–5.6	f/4.0–5.6
Image angle	75°–29°	30.3°–8.2°	75°–8.2°
Lens configuration	7 groups, 8 lenses	10 groups, 13 lenses	11 groups, 15 lenses
Iris control	f/3.5–22	f/4.0–22	f/4.0–22
Shooting range (Focal length)	0.25 m–∞ (14–19mm) 0.3 m–∞ (20–42mm)	0.9 m–∞	0.5 m–∞
Focus adjustment	AF/MF switching		
Weight (excluding hood and cap)	113 g	190 g	260 g
Dimensions (Max. diameter × length)	ø56.5×50 mm	ø63.5×83 mm	ø63.5×83 mm
Filter mount thread diameter	37 mm	58 mm	58 mm
Lens hood	LH-40	LH-61D	LH-61C

Items	ED12-50mm f3.5-6.3EZ	17mm f1.8	BCL-1580 (15mm f8)
Mount	Micro Four Thirds mount		
Focal length	12–50 mm	17 mm	15 mm
Max. aperture	f/3.5–6.3	f/1.8	f/8
Image angle	84°–24°	64°	72°
Lens configuration	9 groups, 10 lenses	6 groups, 9 lenses	3 groups, 3 lenses
Iris control	f/3.5–22	f/1.8 - 22	Fixed to f/8
Shooting range (Focal length)	0.35 m–∞ 0.2 m–0.5 m (macro mode)	0.25 m – ∞	0.30 m – ∞
Focus adjustment	AF/MF switching	AF/MF, snapshot focus	MF
Weight (excluding hood and cap)	212 g	120 g	22 g
Dimensions (Max. diameter × length)	ø57×83 mm	ø57.5×35.5 mm	ø56×9 mm
Filter mount thread diameter	52 mm	46 mm	–
Lens hood	LH-55B	LH-48B	–

### ⚠ Cautions

- Edges of pictures may be cut off if more than one filter is used or if a thick filter is used.

## Record mode and file size/number of storable still pictures

The file size in the table is approximate for files with a 4:3 aspect ratio.

Record mode	Number of pixels (Pixel Count)	Compression	File format	File size (MB)	Number of storable still pictures*
RAW	4608×3456	Loss-less compression	ORF	Approx. 17	41
L <sup>SF</sup>		1/2.7	JPEG	Approx. 11	79
L <sup>F</sup>		1/4		Approx. 7.5	114
L <sup>N</sup>		1/8		Approx. 3.5	248
L <sup>B</sup>		1/12		Approx. 2.4	369
M <sup>SF</sup>	3200×2400	1/2.7		Approx. 5.6	155
M <sup>F</sup>		1/4		Approx. 3.4	257
M <sup>N</sup>		1/8		Approx. 1.7	508
M <sup>B</sup>		1/12		Approx. 1.2	753
M <sup>SF</sup>	2560×1920	1/2.7		Approx. 3.2	271
M <sup>F</sup>		1/4		Approx. 2.2	398
M <sup>N</sup>		1/8		Approx. 1.1	782
M <sup>B</sup>		1/12		Approx. 0.8	1151
M <sup>SF</sup>	1920×1440	1/2.7		Approx. 1.8	476
M <sup>F</sup>		1/4		Approx. 1.3	701
M <sup>N</sup>		1/8		Approx. 0.7	1356
M <sup>B</sup>		1/12	Approx. 0.5	1968	
M <sup>SF</sup>	1600×1200	1/2.7	Approx. 1.3	678	
M <sup>F</sup>		1/4	Approx. 0.9	984	
M <sup>N</sup>		1/8	Approx. 0.5	1906	
M <sup>B</sup>		1/12	Approx. 0.4	2653	
S <sup>SF</sup>	1280×960	1/2.7	Approx. 0.9	1034	
S <sup>F</sup>		1/4	Approx. 0.6	1488	
S <sup>N</sup>		1/8	Approx. 0.4	2773	
S <sup>B</sup>		1/12	Approx. 0.3	3813	
S <sup>SF</sup>	1024×768	1/2.7	Approx. 0.6	1564	
S <sup>F</sup>		1/4	Approx. 0.4	2260	
S <sup>N</sup>		1/8	Approx. 0.3	4068	
S <sup>B</sup>		1/12	Approx. 0.2	5547	
S <sup>SF</sup>	640×480	1/2.7	Approx. 0.3	3589	
S <sup>F</sup>		1/4	Approx. 0.2	5085	
S <sup>N</sup>		1/8	Approx. 0.2	7627	
S <sup>B</sup>		1/12	Approx. 0.1	10170	

\*Assumes a 1GB SD card.

### ⚠ Cautions

- The number of storable still pictures may change according to the subject, whether or not print reservations have been made, and other factors. In certain instances, the number of storable still pictures displayed on the monitor will not change even when you take pictures or erase stored images.
- The actual file size varies according to the subject.
- The maximum number of storable still pictures displayed on the monitor is 9999.
- For the available recording time for movies, see the Olympus website.

## Using separately sold accessories

### Electronic Viewfinder (VF-4)

The VF-4 electronic viewfinder switches on automatically when you look through it. While the viewfinder is on, the camera monitor display is switched off. You can select whether to automatically switch the display between the viewfinder and monitor using the menu settings. Note that menus and other settings information are still displayed on the camera monitor when the viewfinder is switched on.

#### ⓘ Cautions

- In the following situations, the viewfinder may not switch off automatically.  
When in sleep mode/when shooting using movie, 3D, multiple exposure, live bulb, live time etc./when the shutter button is pressed halfway/when the monitor is pulled out
- The viewfinder may also fail to turn on automatically when viewed in certain situations, such as when wearing glasses, or under strong sunlight. Change to manual settings.

#### ■ Attaching and removing an electronic viewfinder

Remove the connector cover while pressing down on the lock release button, and then keep pressing into the camera hot shoe until it will go no further.

- To remove, turn off the camera, and remove while pressing down on the lock release button.

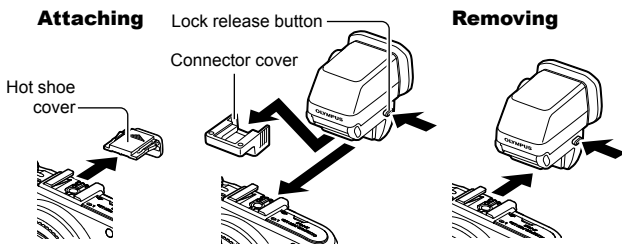

## ■ Using a diopter adjustment dial

Turn on the camera power, and then set the diopter adjustment dial to a position at which an image is visible in the view finder.

- The angle can be changed up to a maximum 90°.

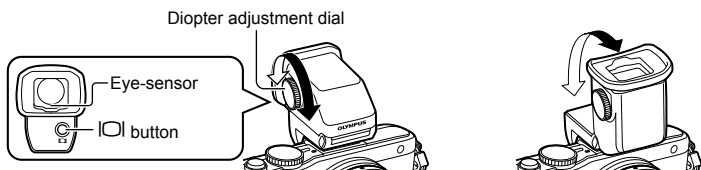

## ■ Manually switching between the viewfinder and monitor

Set the automatic switch to off, and control the switching using the I/O button on the external viewfinder.

- 1 In the Accessory Port Menu, select [EVF] and press the button.
- 2 Select [EVF Auto Switch] and press the button.
  - The same menu can also be displayed by pressing and holding the I/O button on the VF-4.
- 3 Select [Off] and press the button.
  - Press the I/O button on the external viewfinder to switch between the display between the viewfinder and monitor.

## ■ Main Specifications (VF-4)

Display pixels	Approx. 2,360,000 dots
Field of view	100 %
Viewfinder magnification	Approx 1.48 (-1 m <sup>-1</sup> 50 mm lens/infinity)
Eye point	Approx. 21 mm (-1 m <sup>-1</sup> ) (from the back of eyepiece lens)
Diopter adjustment range	-4.0 to +2.0 m <sup>-1</sup>
Weight	42 g (0.09 lb) (without connector cover)
Dimensions	30.4 mm (W) × 48.2 mm (H) × 47.8 mm (D) (1.2" × 1.9" × 1.9")

## ! Cautions

- When carrying the camera, do not hold it by the viewfinder.
- Do not allow direct sunlight to pass into the viewfinder through the eyepiece lens.



## Using external flash units designated for use with this camera

With this camera, you can use one of the separately sold external flash units to achieve a flash suited to your needs. The external flashes communicate with the camera, allowing you to control the camera's flash modes with various available flash control modes, such as TTL-AUTO and Super FP flash. An external flash unit specified for use with this camera can be mounted on the camera by attaching it to the camera's hot shoe. You can also attach the flash to the flash bracket on the camera using the bracket cable (optional). Refer to the documentation provided with the external flash units as well.

The upper limit of the shutter speed is 1/200 sec. when using a flash.

### Functions available with external flash units

Optional flash	Flash control mode	GN (Guide number) (ISO100)	RC mode
FL-600R	TTL-AUTO, AUTO, MANUAL, FP TTL AUTO, FP MANUAL	GN36 (85 mm*) GN20 (24 mm*)	✓
FL-300R	TTL-AUTO, MANUAL	GN20 (28 mm*)	✓
FL-14	TTL-AUTO, AUTO, MANUAL	GN14 (28 mm*)	—
RF-11	TTL-AUTO, MANUAL	GN11	—
TF-22		GN22	—

\* The focal length of the lens that can be used (Calculated based on 35 mm film camera).

## Wireless remote control flash photography

External flash units that are designated for use with this camera and have a remote control mode can be used for wireless flash photography. The camera can control the supplied flash unit and remote flash units in up to three separate groups. See the instruction manuals provided with the external flash units for details.

- 1 Set the remote flash units to RC mode and place them as desired.
  - Turn the external flash units on, press the MODE button, and select RC mode.
  - Select a channel and group for each external flash unit.
- 2 Select [On] for [ RC Mode] in Shooting Menu 2 (P. 115).
  - The LV super control panel switches to RC mode.
  - You can choose an LV super control panel display by repeatedly pressing the **INFO** button.
  - Select a flash mode (note that red-eye reduction is not available in RC mode).

### 3 Adjust the settings for each group in the LV super control panel.

Group

- Select the flash control mode and adjust the flash intensity separately for each group. For MANUAL, select the flash intensity.

Adjust settings for the camera flash unit.

Flash intensity value

Normal flash/Super FP flash

- Switch between normal flash and Super FP flash.

Communication light level

- Set the communication light level to [HI], [MID], or [LO].

Channel

- Set the communication channel to the same channel used on the flash.

Flash control mode

Flash intensity

### 4 Attach the supplied flash unit and raise the flash head.

- After confirming that the built-in and remote flash units have charged, take a test shot.

#### ■ Wireless flash control range

Position the wireless flash units with their remote sensors facing the camera. The following illustration shows the approximate ranges at which the flash units can be positioned. The actual control range varies with local conditions.

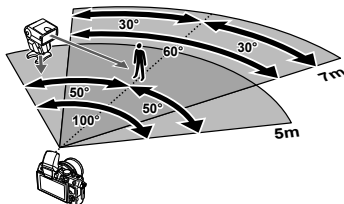

#### ⓘ Cautions

- We recommend using a single group of up to three remote flash units.
- Remote flash units cannot be used for second curtain slow synchronization or anti-shock exposures longer than 4 seconds.
- If the subject is too close to the camera, the control flashes emitted by the supplied flash may affect exposure (this effect can be reduced by reducing the output of the supplied flash by, for example, using a diffuser).
- The upper limit of flash synchronization timing is 1/160 sec. when using the flash in remote control mode.

#### Other external flash units

Note the following when using a third-party flash unit mounted on the camera hot shoe:

- Using obsolete flash units that apply currents of more than about 24 V to the camera hot shoe X-contact will damage the camera.
- Connecting flash units with signal contacts that do not conform to Olympus specifications may damage the camera.
- Use only with the camera in shooting mode **M** at shutter speeds slower than 1/160s and at ISO settings other than [Auto].
- Flash control can only be performed by manually setting the flash to the ISO sensitivity and aperture values selected with the camera. Flash brightness can be adjusted by adjusting either ISO sensitivity or aperture.
- Use a flash with an angle of illumination suited to the lens. Angle of illumination is usually expressed using 35-mm format equivalent focal lengths.











## Menu directory

\*1: Can be added to [Myset].

\*2: Default can be restored by selecting [Full] for [Reset].

\*3: Default can be restored by selecting [Basic] for [Reset].

### Shooting Menu

Tab	Function	Default	*1	*2	*3			
	Card Setup	—				59		
	Reset/Myset	—		✓		59		
	Picture Mode	 Natural	✓	✓	✓	48		
		Still Picture	 N	✓	✓	✓	52	
		Movie	MOV FullHD 					
		Image Aspect	4:3	✓	✓	✓	51	
		Digital Tele-converter	Off	✓	✓	✓	66	
			✓	✓	✓	35		
	Image Stabilizer		S-IS1	✓	✓	✓	47	
			M-IS2	✓	✓	✓		
	Bracketing	AE BKT	Off	✓	✓	✓	63	
		WB BKT	A-B				Off	63
			G-M					
		FL BKT	Off				63	
		ISO BKT	Off				64	
		ART BKT	Off				64	
	HDR BKT	Off	64					
	Multiple Exposure	Frame	Off		✓	✓	64	
		Auto Gain	Off					
		Overlay	Off					
	Time Lapse Settings		Off				65	
		Frame	99					
		Start Waiting Time	00:00:01					
		Interval Time	00:00:01					
Time Lapse Movie		Off						
 RC Mode		Off	✓	✓	✓	113		

10

Information/Separately sold accessories

## ▶ Playback Menu

Tab	Function		Default	*1	*2	*3	👉	
▶	📷	Start	—		✓	✓	42	
		BGM	Melancholy					
		Effect	Fade					
		Slide	All					
		Slide Interval	3 sec					
		Movie Interval	Short					
	📁		On	✓	✓	67		
	Edit	Sel. Image	RAW Data Edit	—				67
			JPEG Edit	—				68
		🎤		—				69
	Image Overlay		—			69		
📄			—			92		
	Reset Protect		—			69		
	Connection to Smartphone		—			70		

## ƒ Setup Menu

Tab	Function		Default	*1	*2	*3	👉	
ƒ	🕒		—				16	
	🗣️*		—				71	
	📷		📷 ±0, 📷 ±0, Vivid		✓	✓	71	
	Rec View		0.5 sec	✓	✓	✓	71	
	🗣️ Menu Display	⚙️ Menu Display	Off		✓			71
		🗣️ Menu Display	Off					
		Firmware		—				71

\* Settings differ depending on the region where the camera is purchased.

## ⚙️ Custom Menu

Tab	Function		Default	*1	*2	*3	👉				
⚙️	📷	AF/MF			✓	✓	73				
		AF Mode	Still Picture					S-AF			
		Movie	C-AF								
		Full-time AF	Off					✓	✓	✓	
	AEL/AFL		S-AF					mode1	✓	✓	✓
			C-AF					mode2			
			MF					mode1			
		Reset Lens	On						✓	✓	
		BULB/TIME Focusing	On						✓	✓	
		Focus Ring	🕒						✓	✓	
		MF Assist	Off						✓	✓	
		📄 Set Home	📄							✓	
		AF Illuminat.	On						✓	✓	
	☺ Face Priority	☺		✓	✓						

Tab	Function	Default	*1	*2	*3		
	Button/Dial						
	Button Function	Function					73
		Function	REC				
		Function		✓	✓		
		Function					
		Function	Direct Function				
		Function	AF Stop				
	Dial Function	P					74
		A	FNo.	✓	✓		
		S	Shutter				
		M	Shutter				
	Dial Direction	Exposure	Dial1	✓	✓		74
		Menu	Dial1				
	Lock		On	✓	✓		
	Mode Dial Function		Off		✓		
	Release/						
	RIs Priority S		Off	✓	✓	✓	74
	RIs Priority C		On	✓	✓	✓	
	L fps		3 fps	✓	✓	✓	
	H fps		8 fps	✓	✓	✓	
	+ IS Off		On		✓		
	Lens I.S. Priority		Off	✓	✓	✓	
Release Lag-Time		Normal		✓			
	Disp/						
	HDMI	HDMI Out	1080i		✓		74
		HDMI Control		Off		✓	
	Video Out		—				
	Control Settings	iAUTO	Live Guide		✓		75
		P/A/S/M	Live Control		✓		
		ART	Art Menu		✓		
		SCN	Scene Menu		✓		
	Info Settings	Info	Image Only, Overall	✓	✓	✓	75
		LV-Info	Image Only,	✓	✓		
	Settings		25, Calendar	✓	✓		
	Displayed Grid		Off	✓	✓		
	Picture Mode Settings		On	✓	✓		
	Histogram Settings	Highlight	255				75
		Shadow	0		✓		
	Mode Guide		On		✓		
	Live View Boost		Off	✓	✓	✓	
	Frame Rate		Normal	✓	✓	✓	
	Art LV Mode		mode1		✓		
	Flicker reduction		Auto		✓		
	LV Close Up Mode		mode1		✓		
	Close Up Mode		mode1		✓		
	Backlit LCD		Hold	✓	✓	✓	
Sleep		1 min	✓	✓	✓		
		On	✓	✓	✓		
USB Mode		Auto		✓	✓		

Tab	Function	Default	*1	*2	*3	
	Exp//ISO					
	EV Step	1/3EV	✓	✓	✓	76
	Noise Reduct.	Auto	✓	✓	✓	
	Noise Filter	Standard	✓	✓	✓	
	ISO	Auto	✓	✓	✓	
	ISO Step	1/3EV	✓	✓	✓	
	ISO-Auto Set	High Limit: 1600 Default: 200	✓	✓	✓	
	ISO-Auto	P/A/S	✓	✓		
	Metering		✓	✓	✓	
	AEL Metering	Auto	✓	✓	✓	
	BULB/TIME Timer	8 min	✓	✓	✓	
	Live BULB	Off	✓	✓		
Live TIME	1 sec	✓	✓			
Anti-Shock	Off	✓	✓	✓		
	Custom					
	X-Sync.	1/250	✓	✓	✓	77
	Slow Limit	1/60	✓	✓	✓	
	+	Off	✓	✓	✓	
	-Color/WB					
	-Set	—	✓	✓	✓	77
	Pixel	Middle 2560×1920	✓	✓	✓	
	Count	Small 1280×960				
	Shading Comp.	Off	✓	✓	✓	
	WB	Auto	A:0, G:0	✓	✓	✓
	All	All Set	—	✓	✓	78
	All Reset	—		✓		
	Keep Warm Color	On	✓	✓	✓	
	+WB	WB Auto	✓	✓	✓	
	Color Space	sRGB	✓	✓	✓	
	Record/Erase					
	Quick Erase	Off	✓	✓	✓	78
	RAW+JPEG Erase	RAW+JPEG	✓	✓	✓	
	File Name	Reset		✓		
	Edit Filename	Off		✓		
	Priority Set	No		✓	✓	
	dpi Settings	350dpi		✓		
		Copyright Settings	Copyright Info. Off		✓	
		Artist Name	—			
		Copyright Name	—			
	Movie					
	Mode	P		✓		79
	Movie	On	✓	✓	✓	
	Movie Effect	Off		✓		
	Wind Noise Reduction	Off		✓		
	Recording Volume	Standard		✓		

Tab	Function	Default	*1	*2	*3		
	Utility						
	Pixel Mapping		—				79
	Exposure Shift		±0	✓	✓		
	Warning Level		±0		✓		80
	Level Adjust		—		✓		
	Touch Screen Settings		On	✓	✓		
Eye-Fi		On		✓			

## Accessory Port Menu

Tab	Function	Default	*1	*2	*3		
	OLYMPUS PENPAL Share						
	Please Wait		—				89, 90
	Address Book	Address List	—				90
		Search Timer	30sec		✓		
	New Pairing		—				91
	My OLYMPUS PENPAL		—				
	Picture Send Size		Size 1: Small		✓		
	OLYMPUS PENPAL Album						
	Copy All		—				91
	Reset Protect		—				
	Album Mem. Usage		—				
	Album Mem. Setup		—				
	Picture Copy Size		Size 2: Medium		✓		
	Electronic Viewfinder						
	EVF Adjust		±0,  ±0		✓	✓	91
EVF Auto Switch		On		✓		91	

10

Information/Separately sold accessories

## Specifications

### ■ Camera

<b>Product type</b>	
Product type	Digital camera with interchangeable Micro Four Thirds Standard lens system
Lens	M.Zuiko Digital, Micro Four Thirds System Lens
Lens mount	Micro Four Thirds mount
Equivalent focal length on a 35 mm film camera	Approx. twice the focal length of the lens
<b>Image pickup device</b>	
Product type	4/3" Live MOS sensor
No. of total pixels	Approx. 17,200,000 pixels
No. of effective pixels	Approx. 16,050,000 pixels
Screen size	17.3 mm(H) × 13.0 mm(V)
Aspect ratio	1.33 (4:3)
<b>Live view</b>	
Sensor	Uses Live MOS sensor
Field of view	100%
<b>Monitor</b>	
Product type	3.0" TFT color LCD, Vari-angle (Up: Approx. 170°, Down: Approx. 65°), touch screen
Total no. of pixels	Approx. 460,000 dots (aspect ratio 16:9)
<b>Shutter</b>	
Product type	Computerized focal-plane shutter
Shutter	1/4000–60 sec., bulb photography, time photography
<b>Auto focus</b>	
Product type	Imager contrast detection system
Focusing points	35 points
Selection of focusing point	Auto, Optional
<b>Exposure control</b>	
Metering system	TTL metering system (imager metering) Digital ESP metering/Center weighted averaging metering/Spot metering
Metered range	EV 0 - 20 (Digital ESP metering/Center weighted averaging metering/Spot metering)
Shooting modes	<b>IAUTO</b> : iAUTO/ <b>P</b> : Program AE (Program shift can be performed)/ <b>A</b> : Aperture priority AE/ <b>S</b> : Shutter priority AE/ <b>M</b> : Manual/ <b>ART</b> : Art filter/ <b>SCN</b> : Scene/ <b>MOV</b> : Movie
ISO sensitivity	LOW, 200 - 25600 (1/3, 1 EV step)
Exposure compensation	±3EV (1/3, 1/2, 1 EV step)
<b>White balance</b>	
Product type	Image pickup device
Mode setting	Auto/Preset WB (7 settings)/Customized WB/One-touch WB
<b>Recording</b>	
Memory	SD, SDHC, SDXC, Eye-Fi and FlashAir (with wireless LAN function) UHS-I compatible
Recording system	Digital recording, JPEG (in accordance with Design rule for Camera File system (DCF)), RAW Data, MP format
Applicable standards	Exif 2.3, Digital Print Order Format (DPOF), PRINT Image Matching III, PictBridge
Sound with still pictures	Wave format
Movie	MPEG-4 AVC/H.264 / Motion JPEG
Audio	Stereo, PCM 48kHz
<b>Playback</b>	
Display format	Single-frame playback/Close-up playback/Index display/Calendar display
<b>Drive</b>	
Drive mode	Single-frame shooting/Sequential shooting/Self-timer
Sequential shooting	Up to 8 fps (  )



Self-timer	Operation time: 12 sec./2 sec./Customized
Energy saving function	Switch to sleep mode: 1 minute (can be customized), Power OFF: 5 minutes
<b>Flash</b>	
Flash control mode	TTL-AUTO (TTL pre-flash mode)/MANUAL
Sync speed	1/250 s or slower
<b>External connector</b>	
Multi-connector (USB connector, AV connector)/HDMI micro connector (type D)/Accessory port	
<b>Power supply</b>	
Battery	Li-ion Battery ×1
<b>Dimensions/weight</b>	
Dimensions	110.5 mm (W) × 63.7 mm (H) × 38.2 mm (D) (4.4" × 2.5" × 1.8") (excluding protrusions)
Weight	Approx. 325 g (0.7 lb.) (including battery and memory card)
<b>Operating environment</b>	
Temperature	0 °C - 40 °C (32 °F - 104 °F) (operation)/-20 °C - 60 °C (-4 °F - 140 °F) (storage)
Humidity	30% - 90% (operation)/10% - 90% (storage)

HDMI, the HDMI logo and High-Definition Multimedia Interface are trademarks or registered trademarks of HDMI Licensing LLC.



### ■ FL-LM1 Flash

Guide number	7 (ISO100·m) (10 (ISO200·m))
Firing angle	Covers the picture angle of a 14 mm lens (equivalent to 28 mm in 35 mm format)
Dimensions	Approx. 39.2 mm (W) × 32.2 mm (H) × 43.4 mm (D) (1.5" × 1.3" × 1.7")
Weight	Approx. 25 g (0.06 lb.)

### ■ Lithium ion battery

MODEL NO.	BLS-5
Product type	Rechargeable Lithium ion battery
Nominal voltage	DC 7.2 V
Nominal capacity	1150 mAh
No. of charge and discharge times	Approx. 500 times (varies with usage conditions)
Ambient temperature	0 °C - 40 °C (32 °F - 104 °F) (charging)
Dimensions	Approx. 35.5 mm (W) × 12.8 mm (H) × 55 mm (D) (1.4" × 0.5" × 2.2")
Weight	Approx. 44 g (0.1 lb.)

### ■ Lithium ion charger

MODEL NO.	BCS-5
Rated input	AC 100V - 240V (50/60 Hz)
Rated output	DC 8.35V, 400 mA
Charging time	Approx. 3 hours 30 minutes (room temperature)
Ambient temperature	0 °C - 40 °C (32 °F - 104 °F) (operation)/ -20 °C - 60 °C (-4 °F - 140 °F) (storage)
Dimensions	Approx. 62 mm (W) × 38 mm (H) × 83 mm (D) (2.4" × 1.5" × 3.3")
Weight (without AC cable)	Approx. 70 g (0.2 lb.)

- The AC cable supplied with this device is for use only with this device and should not be used with other devices. Do not use cables for other devices with this device.

SPECIFICATIONS ARE SUBJECT TO CHANGE WITHOUT ANY NOTICE OR OBLIGATION ON THE PART OF THE MANUFACTURER.

## System chart

### Power Supply



**BLS-5**  
Li-ion Battery

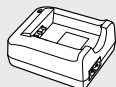

**BCS-5**  
Li-ion Battery Charger

### Remote Operation

**RM-UC1**  
Remote Cable

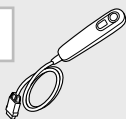

### Connection Cable

USB Cable/  
AV Cable/  
HDMI Cable

### Camera Grip

MCG-1/MCG-2/  
MCG-3PR

### Case / Strap

Shoulder Strap  
Camera Case

### Underwater System

Underwater case

### Memory Card\*4

SD/SDHC/  
SDXC/Eye-Fi/  
FlashAir

### Software

**OLYMPUS Viewer**  
Digital Photo Managing Software

### Viewfinder



**VF-1**  
Optical View Finder



**VF-4**  
Electronic View Finder

# E-PL6

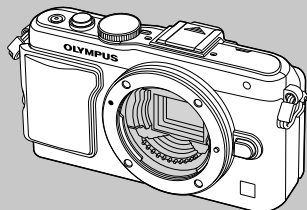

### Accessory port devices



**OLYMPUS PENPAL PP-1<sup>3</sup>**  
Communication Unit

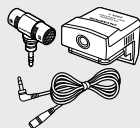

**SEMA-1**  
Microphone Set 1

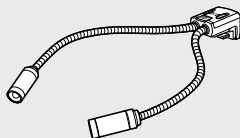

**MAL-1**  
MACRO ARM LIGHT

\*1 Not all lenses can be used with adapter. For details, refer to the Olympus Official Web Site. Also, please note that manufacture of OM System Lenses has been discontinued.

\*2 For compatible lens, refer to the Olympus Official Web Site.

□ : E-PL6 compatible products

■ : Commercially available products

For the latest information, please visit the Olympus website.

### Lens



M.ZUIKO DIGITAL ED 12-50mm f3.5-6.3 EZ  
M.ZUIKO DIGITAL ED 12mm f2.0  
M.ZUIKO DIGITAL 17mm f1.8  
M.ZUIKO DIGITAL 17mm f2.8  
M.ZUIKO DIGITAL 45mm f1.8  
M.ZUIKO DIGITAL ED 75mm f1.8  
M.ZUIKO DIGITAL ED 60mm f2.8 Macro  
M.ZUIKO DIGITAL 14-42mm f3.5-5.6 II R  
M.ZUIKO DIGITAL ED 9-18mm f4.0-5.6  
M.ZUIKO DIGITAL ED 14-150mm f4.0-5.6  
M.ZUIKO DIGITAL ED 40-150mm f4.0-5.6 R  
M.ZUIKO DIGITAL 75-300mm f4.8-6.7 II



**MMF-2/MMF-3\*1**  
Four Thirds Adapter



### Four Thirds System Lenses



**MF-2\*1**  
OM Adapter 2

### OM System Lenses

### Converter Lens\*2



**FCON-P01**  
Fisheye



**WCON-P01**  
Wide



**MCON-P01**  
Macro

### Flash

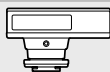

**FL-14**  
Electronic Flash



**FL-600R**  
Electronic Flash



**FL-300R**  
Electronic Flash

### SRF-11 Ring Flash Set



**RF-11\*2**  
Ring Flash

### STF-22 Twin Flash Set



**TF-22\*2**  
Twin Flash

### FC-1 Macro Flash Controller

\*3 The OLYMPUS PENPAL can be used only in the region in which it was purchased. Depending on the areas, the usage may infringe the wave regulations and may be subject to its penalty.

\*4 Use the SD card with wireless LAN function or Eye-Fi card in compliance with the laws and regulations of the country where the camera is used.

## Principal Accessories

### Four Thirds lens adapter (MMF-2/MMF-3)

The camera requires a Four Thirds lens adapter to attach Four Thirds lenses. Some features, such as autofocus, may not be available.

### Remote cable (RM-UC1)

Use when the slightest camera movement can result in blurred pictures, for example for macro or bulb photography. The remote cable attaches via the camera multi-connector.

### Converter lenses

Converter lenses attach to the camera lens for quick and easy fish-eye or macro photography. See the OLYMPUS website for information on the lenses that can be used.

- Use the appropriate lens attachment for **SCN** mode (, , or ).

### Macro arm light (MAL-1)

Use to illuminate subjects for macro photography, even at ranges at which vignetting would occur with the flash.

### Microphone set (SEMA-1)

The microphone can be placed at a distance from the camera to avoid recording ambient sounds or wind noise. Third-party commercial microphones can also be used depending on your creative intent. We recommend that you use the supplied extension cord. (power supplied via ø3.5 mm stereo mini-plug)

### Camera grip

You can replace the camera grip. To remove the grip, unfasten the grip screw.

## SAFETY PRECAUTIONS



## CAUTION

RISK OF ELECTRICAL SHOCK  
DO NOT OPEN



CAUTION: TO REDUCE THE RISK OF ELECTRICAL SHOCK, DO NOT REMOVE COVER (OR BACK). NO USER-SERVICEABLE PARTS INSIDE. REFER SERVICING TO QUALIFIED OLYMPUS SERVICE PERSONNEL.



An exclamation mark enclosed in a triangle alerts you to important operating and maintenance instructions in the documentation provided with the product.



## DANGER

If the product is used without observing the information given under this symbol, serious injury or death may result.



## WARNING

If the product is used without observing the information given under this symbol, injury or death may result.



## CAUTION

If the product is used without observing the information given under this symbol, minor personal injury, damage to the equipment, or loss of valuable data may result.

## WARNING!

TO AVOID THE RISK OF FIRE OR ELECTRICAL SHOCK, NEVER DISASSEMBLE, EXPOSE THIS PRODUCT TO WATER OR OPERATE IN A HIGH HUMIDITY ENVIRONMENT.

## General Precautions

**Read All Instructions** — Before you use the product, read all operating instructions. Save all manuals and documentation for future reference.

**Cleaning** — Always unplug this product from the wall outlet before cleaning. Use only a damp cloth for cleaning. Never use any type of liquid or aerosol cleaner, or any type of organic solvent to clean this product.

**Attachments** — For your safety, and to avoid damaging the product, use only accessories recommended by Olympus.

**Water and Moisture** — For precautions on products with weatherproof designs, read the weatherproofing sections.

**Location** — To avoid damage to the product, mount the product securely on a stable tripod, stand, or bracket.

**Power Source** — Connect this product only to the power source described on the product label.

**Foreign Objects** — To avoid personal injury, never insert a metal object into the product.

**Heat** — Never use or store this product near any heat source such as a radiator, heat register,

stove, or any type of equipment or appliance that generates heat, including stereo amplifiers.

## Product Handling Precautions

## WARNING

- Do not use the camera near flammable or explosive gases.
- Do not use the flash and LED on people (infants, small children, etc.) at close range.

You must be at least 1 m (3 ft.) away from the faces of your subjects. Firing the flash too close to the subject's eyes could cause a momentary loss of vision.

- Keep young children, infants, and animals such as pets away from the camera.

Always use and store the camera out of the reach of young children and infants to prevent the following dangerous situations which could cause serious injury:

- Becoming entangled in the camera strap, causing strangulation.
- Accidentally swallowing the battery, cards or other small parts.

- Accidentally firing the flash into their own eyes or those of another child.
- Accidentally being injured by the moving parts of the camera.
- **Do not look at the sun or strong lights with the camera.**
- **Do not use or store the camera in dusty or humid places.**
- **Do not cover the flash with a hand while firing.**

### CAUTION

- **Stop using the camera immediately if you notice any unusual odors, noise, or smoke around it.**  
Never remove the batteries with bare hands, which may cause a fire or burn your hands.
- **Never hold or operate the camera with wet hands.**
- **Do not leave the camera in places where it may be subject to extremely high temperatures.**  
Doing so may cause parts to deteriorate and, in some circumstances, cause the camera to catch fire.  
Do not use the charger if it is covered (such as a blanket). This could cause overheating, resulting in fire.

- **Handle the camera with care to avoid getting a low-temperature burn.**

When the camera contains metal parts, overheating can result in a low-temperature burn. Pay attention to the following:

- When used for a long period, the camera will get hot. If you hold on to the camera in this state, a low temperature burn may be caused.
- In places subject to extremely cold temperatures, the temperature of the camera's body may be lower than the environmental temperature. If possible, wear gloves when handling the camera in cold temperatures.
- **Be careful with the strap.**  
Be careful with the strap when you carry the camera. It could easily catch on stray objects - and cause serious damage.

### Battery Handling Precautions

Follow these important guidelines to prevent batteries from leaking, overheating, burning, exploding, or causing electrical shocks or burns.

### DANGER

- The camera uses a lithium ion battery specified by Olympus. Charge the battery with the specified charger. Do not use any other chargers.

- Never heat or incinerate batteries.
- Take precautions when carrying or storing batteries to prevent them from coming into contact with any metal objects such as jewelry, pins, fasteners, etc.
- Never store batteries where they will be exposed to direct sunlight, or subjected to high temperatures in a hot vehicle, near a heat source, etc.
- To prevent causing battery leaks or damaging their terminals, carefully follow all instructions regarding the use of batteries. Never attempt to disassemble a battery or modify it in any way, by soldering, etc.
- If battery fluid gets into your eyes, flush your eyes immediately with clear, cold running water and seek medical attention immediately.
- Always store batteries out of the reach of small children. If a child accidentally swallows a battery, seek medical attention immediately.
- Should you notice that the charger is emitting smoke, heat, or an unusual noise or smell, immediately cease use and unplug the charger from the power outlet, and then contact an authorized distributor or service center.

### WARNING

- Keep batteries dry at all times.
- To prevent batteries from leaking, overheating, or causing a fire or explosion, use only batteries recommended for use with this product.
- Insert the battery carefully as described in the operating instructions.
- If rechargeable batteries have not been recharged within the specified time, stop charging them and do not use them.
- Do not use a battery if it is cracked or broken.
- If a battery leaks, becomes discolored or deformed, or becomes abnormal in any other way during operation, stop using the camera.
- If a battery leaks fluid onto your clothing or skin, remove the clothing and flush the affected area with clean, running cold water immediately. If the fluid burns your skin, seek medical attention immediately.
- Never subject batteries to strong shocks or continuous vibration.

### CAUTION

- Before loading, always inspect the battery carefully for leaks, discoloration, warping, or any other abnormality.
- The battery may become hot during prolonged use. To avoid minor burns, do not remove it immediately after using the camera.

- Always unload the battery from the camera before storing the camera for a long period.
- This camera uses a lithium ion battery specified by Olympus. Do not use any other type of battery. For safe and proper use, read the battery's instruction manual carefully before using it.
- If the battery's terminals get wet or greasy, camera contact failure may result. Wipe the battery well with a dry cloth before use.
- Always charge a battery when using it for the first time, or if it has not been used for a long period.
- When operating the camera with battery power at low temperatures, try to keep the camera and spare battery as warm as possible. A battery that has run down at low temperatures may be restored after it is warmed at room temperature.
- The number of pictures you can take may vary depending on the shooting conditions or battery.
- Before going on a long trip, and especially before traveling abroad, purchase extra batteries. A recommended battery may be difficult to obtain while traveling.
- When the camera will not be used for an extended period, store it in a cool place.
- Please recycle batteries to help save our planet's resources. When you throw away dead batteries, be sure to cover their terminals and always observe local laws and regulations.

## Caution for Usage Environment

- To protect the high-precision technology contained in this product, never leave the camera in the places listed below, no matter if in use or storage:
  - Places where temperatures and/or humidity are high or go through extreme changes. Direct sunlight, beaches, locked cars, or near other heat sources (stove, radiator, etc.) or humidifiers.
  - In sandy or dusty environments.
  - Near flammable items or explosives.
  - In wet places, such as bathrooms or in the rain. When using products with weatherproof designs, read their manuals as well.
  - In places prone to strong vibrations.
- Never drop the camera or subject it to severe shocks or vibrations.
- When mounted on a tripod, adjust the position of the camera with the tripod head. Do not twist the camera.

- Do not leave the camera pointed directly at the sun. This may cause lens or shutter curtain damage, color failure, ghosting on the image pickup device, or may possibly cause fires.
- Do not touch electric contacts on cameras and interchangeable lenses. Remember to attach the body cap when removing the lens.
- Before storing the camera for a long period, remove the battery. Select a cool, dry location for storage to prevent condensation or mold from forming inside the camera. After storage, test the camera by turning it on and pressing the shutter release button to make sure that it is operating normally.
- The camera may malfunction if it is used in a location where it is subject to a magnetic/ electromagnetic field, radio waves, or high voltage, such as near a TV set, microwave, video game, loud speakers, large monitor unit, TV/radio tower, or transmission towers. In such cases, turn the camera off and on again before further operation.
- Always observe the operating environment restrictions described in the camera's manual.
- Do not directly touch or wipe the image pickup device of the camera.

## Monitor

The display on the rear of the camera is an LCD monitor.

- In the unlikely event that the monitor breaks, do not put the liquid crystal in your mouth. Any of the material adhering to your hands, feet, or clothing should be rinsed off immediately.
- A strip of light may appear on the top/bottom of the monitor, but this is not a malfunction.
- When a subject is viewed diagonally in the camera, the edges may appear zigzagged on the monitor. This is not a malfunction; it will be less noticeable in playback mode.
- In places subject to low temperatures, the monitor may take a long time to turn on or its color may change temporarily. When using the camera in extremely cold places, it is a good idea to occasionally place it in a warm place. An monitor exhibiting poor performance due to low temperatures will recover in normal temperatures.
- The monitor is made with high-precision technology. However, black spots or bright spots of light may appear constantly on the monitor. Due to its characteristics or the angle at which you are viewing the monitor, the spot may not be uniform in color and brightness. This is not a malfunction.

## Lens

- Do not immerse in water or splash with water.
- Do not drop or exert strong force on the lens.
- Do not hold at the moving part of the lens.
- Do not touch the lens surface directly.
- Do not touch the contact points directly.
- Do not subject to abrupt temperature changes.

## Legal and Other Notices

- Olympus makes no representations or warranties regarding any damages, or benefit expected by using this unit lawfully, or any request from a third person, which are caused by the inappropriate use of this product.
- Olympus makes no representations or warranties regarding any damages or any benefit expected by using this unit lawfully which are caused by erasing picture data.

## Disclaimer of Warranty

- Olympus makes no representations or warranties, either expressed or implied, by or concerning any content of these written materials or software, and in no event shall be liable for any implied warranty of merchantability or fitness for any particular purpose or for any consequential, incidental or indirect damages (including but not limited to damages for loss of business profits, business interruption and loss of business information) arising from the use or inability to use these written materials or software or equipment. Some countries do not allow the exclusion or limitation of liability for consequential or incidental damages, so the above limitations may not apply to you.
- Olympus reserves all rights to this manual.

## Warning

Unauthorized photographing or use of copyrighted material may violate applicable copyright laws. Olympus assumes no responsibility for unauthorized photographing, use or other acts that infringe upon the rights of copyright owners.

## Copyright Notice

All rights reserved. No part of these written materials or this software may be reproduced or used in any form or by any means, electronic or mechanical, including photocopying and recording or the use of any type of information storage and retrieval system, without the prior written permission of Olympus. No liability is assumed with respect to the use of the information contained in these written materials or software, or for damages resulting from

the use of the information contained therein. Olympus reserves the right to alter the features and contents of this publication or software without obligation or advance notice.

## FCC Notice

- **Radio and Television Interference**  
Changes or modifications not expressly approved by the manufacturer may void the user's authority to operate this equipment. This equipment has been tested and found to comply with the limits for a Class B FCC device, pursuant to Part 15 of the FCC Rules. These limits are designed to provide reasonable protection against harmful interference in a residential installation. This equipment generates, uses, and can radiate radio frequency energy and, if not installed and used in accordance with the instructions, may cause harmful interference to radio communications.  
However, there is no guarantee that interference will not occur in a particular installation. If this equipment does cause harmful interference to radio or television reception, which can be determined by turning the equipment off and on, the user is encouraged to try to correct the interference by one or more of the following measures:
  - Adjust or relocate the receiving antenna.
  - Increase the distance between the camera and receiver.
  - Connect the equipment to an outlet on a circuit different from that to which the receiver is connected.
  - Consult your dealer or an experienced radio/TV technician for help. Only the OLYMPUS-supplied USB cable should be used to connect the camera to USB enabled personal computers (PC).

Any unauthorized changes or modifications to this equipment would void the user's authority to operate it.

## Use Only Dedicated Rechargeable Battery and Battery Charger

We strongly recommend that you use only the genuine Olympus dedicated rechargeable battery and battery charger with this camera. Using a non-genuine rechargeable battery and/or battery charger may result in fire or personal injury due to leakage, heating, ignition or damage to the battery. Olympus does not assume any liability for accidents or damage that may result from the use of a battery and/or battery charger that are not genuine Olympus accessories.



## For customers in North and South America

### For customers in USA

Declaration of Conformity

Model Number : E-PL6

Trade Name : OLYMPUS

Responsible Party : **OLYMPUS IMAGING AMERICA INC.**

Address : 3500 Corporate Parkway, P. O. Box 610, Center Valley, PA 18034-0610, USA

Telephone Number : 484-896-5000

Tested To Comply With FCC Standards

FOR HOME OR OFFICE USE

This device complies with Part 15 of the FCC rules. Operation is subject to the following two conditions:

- (1) This device may not cause harmful interference.
- (2) This device must accept any interference received, including interference that may cause undesired operation.

### For customers in Canada

This Class B digital apparatus complies with Canadian ICES-003.

### OLYMPUS WORLDWIDE LIMITED WARRANTY - IMAGING PRODUCTS

Olympus warrants that the enclosed Olympus® imaging product(s) and related Olympus® accessories (individually a "Product" and collectively the "Products") will be free from defects in materials and workmanship under normal use and service for a period of one (1) year from the date of purchase.

If any Product proves to be defective within the one-year warranty period, the customer must return the defective Product to any of Olympus Service Centers, following the procedure set forth below (See "WHAT TO DO WHEN SERVICE IS NEEDED").

Olympus, at its sole discretion, will repair, replace, or adjust the defective Product, provided that Olympus investigation and factory inspection disclose that (a) such defect developed under normal and proper use and (b) the Product is covered under this limited warranty.

Repair, replacement, or adjustment of defective Products shall be Olympus's sole obligation and the customer's sole remedy hereunder.

The customer is liable and shall pay for shipment of the Products to the Olympus Service Center.

Olympus shall not be obligated to perform preventive maintenance, installation, deinstallation, or maintenance.

Olympus reserves the right to (i) use reconditioned, refurbished, and/or serviceable used parts (that meet Olympus's quality assurance standards) for warranty or any other repairs and (ii) make any internal or external design and/or feature changes on or to its products without any liability to incorporate such changes on or to the Products.

### WHAT IS NOT COVERED BY THIS LIMITED WARRANTY

Excluded from this limited warranty and not warranted by Olympus in any fashion, either express, implied, or by statute, are:

- (a) products and accessories not manufactured by Olympus and/or not bearing the "OLYMPUS" brand label (the warranty coverage for products and accessories of other manufacturers, which may be distributed by Olympus, is the responsibility of the manufacturers of such products and accessories in accordance with the terms and duration of such manufacturers' warranties);
- (b) any Product which has been disassembled, repaired, tampered with, altered, changed, or modified by persons other than Olympus's own authorized service personnel unless repair by others is made with the written consent of Olympus;
- (c) defects or damage to the Products resulting from wear, tear, misuse, abuse, negligence, sand, liquids, impact, improper storage, nonperformance of scheduled operator and maintenance items, battery leakage, use of non-"OLYMPUS" brand accessories, consumables, or supplies, or use of the Products in combination with non-compatible devices;
- (d) software programs;
- (e) supplies and consumables (including but not limited to lamps, ink, paper, film, prints, negatives, cables and batteries); and/or
- (f) Products which do not contain a validly placed and recorded Olympus serial number, unless they are a model on which Olympus does not place and record serial numbers.

EXCEPT FOR THE LIMITED WARRANTY SET FORTH ABOVE, OLYMPUS MAKES NO AND DISCLAIMS ALL OTHER REPRESENTATIONS, GUARANTIES, CONDITIONS, AND WARRANTIES CONCERNING THE PRODUCTS, WHETHER DIRECT OR INDIRECT, EXPRESS OR IMPLIED, OR ARISING UNDER ANY STATUTE, ORDINANCE, COMMERCIAL USAGE OR OTHERWISE, INCLUDING BUT NOT LIMITED TO ANY WARRANTY OR REPRESENTATION AS TO THE SUITABILITY, DURABILITY, DESIGN, OPERATION, OR CONDITION OF THE PRODUCTS (OR ANY PART THEREOF) OR THE MERCHANTABILITY OF THE PRODUCTS OR THEIR FITNESS FOR A PARTICULAR PURPOSE, OR RELATING TO THE INFRINGEMENT OF ANY PATENT, COPYRIGHT, OR OTHER PROPRIETARY RIGHT USED OR INCLUDED THEREIN.

IF ANY IMPLIED WARRANTIES APPLY AS A MATTER OF LAW, THEY ARE LIMITED IN DURATION TO THE LENGTH OF THIS LIMITED WARRANTY.

SOME STATES MAY NOT RECOGNIZE A DISCLAIMER OR LIMITATION OF WARRANTIES AND/OR LIMITATION OF LIABILITY SO THE ABOVE DISCLAIMERS AND EXCLUSIONS MAY NOT APPLY.

THE CUSTOMER MAY ALSO HAVE DIFFERENT AND/OR ADDITIONAL RIGHTS AND REMEDIES THAT VARY FROM STATE TO STATE.

THE CUSTOMER ACKNOWLEDGES AND AGREES THAT OLYMPUS SHALL NOT BE RESPONSIBLE FOR ANY DAMAGES THAT THE CUSTOMER MAY INCUR FROM DELAYED SHIPMENT, PRODUCT FAILURE, PRODUCT DESIGN, SELECTION, OR PRODUCTION, IMAGE OR DATA LOSS OR IMPAIRMENT OR FROM ANY OTHER CAUSE, WHETHER LIABILITY IS ASSERTED IN CONTRACT, TORT (INCLUDING NEGLIGENCE AND STRICT PRODUCT LIABILITY) OR OTHERWISE. IN NO EVENT SHALL OLYMPUS BE LIABLE FOR ANY INDIRECT, INCIDENTAL, CONSEQUENTIAL OR SPECIAL DAMAGES OF ANY KIND (INCLUDING WITHOUT LIMITATION LOSS OF PROFITS OR LOSS OF USE), WHETHER OR NOT OLYMPUS SHALL BE OR SHOULD BE AWARE OF THE POSSIBILITY OF SUCH POTENTIAL LOSS OR DAMAGE.

Representations and warranties made by any person, including but not limited to dealers, representatives, salespersons, or agents of Olympus, which are inconsistent or in conflict with or in addition to the terms of this limited warranty, shall not be binding upon Olympus unless reduced to writing and approved by an

expressly authorized officer of Olympus.

This limited warranty is the complete and exclusive statement of warranty which Olympus agrees to provide with respect to the Products and it shall supersede all prior and contemporaneous oral or written agreements, understandings, proposals, and communications pertaining to the subject matter hereof.

This limited warranty is exclusively for the benefit of the original customer and cannot be transferred or assigned.

#### WHAT TO DO WHEN SERVICE IS NEEDED

The customer must transfer any image or other data saved on a Product to another image or data storage medium and/or remove any film from the Product prior to sending the Product to Olympus for service.

IN NO EVENT SHALL OLYMPUS BE RESPONSIBLE FOR SAVING, KEEPING OR MAINTAINING ANY IMAGE OR DATA SAVED ON A PRODUCT RECEIVED BY IT FOR SERVICE, OR ON ANY FILM CONTAINED WITHIN A PRODUCT RECEIVED BY IT FOR SERVICE, NOR SHALL OLYMPUS BE RESPONSIBLE FOR ANY DAMAGES IN THE EVENT ANY IMAGE OR DATA IS LOST OR IMPAIRED WHILE SERVICE IS BEING PERFORMED (INCLUDING, WITHOUT LIMITATION, DIRECT, INDIRECT, INCIDENTAL, CONSEQUENTIAL OR SPECIAL DAMAGES, LOSS OF PROFITS OR LOSS OF USE), WHETHER OR NOT OLYMPUS SHALL BE OR SHOULD BE AWARE OF THE POSSIBILITY OF SUCH POTENTIAL LOSS OR IMPAIRMENT.

Package the Product carefully using ample padding material to prevent damage in transit and either deliver it to the Authorized Olympus Dealer that sold you the Product or ship it postage prepaid and insured to any of our Olympus Service Centers.

When returning Products for service, your package should include the following:

- 1 Sales receipt showing date and place of purchase.
- 2 Copy of this limited warranty **bearing the Product serial number corresponding to the serial number on the Product** (unless it is a model on which Olympus does not place and record serial numbers).
- 3 A detailed description of the problem.
- 4 Sample prints, negatives, digital prints (or files on disk) if available and related to the problem.

When service is completed, the Product will be returned to you postage prepaid.

## WHERE TO SEND PRODUCT FOR SERVICE

See "WORLDWIDE WARRANTY" for the nearest service center.

## INTERNATIONAL WARRANTY SERVICE

International warranty service is available under this warranty.

## For customers in Europe



"CE" mark indicates that this product complies with the European requirements for safety, health, environment and customer protection. "CE" mark cameras are intended for sales in Europe.



This symbol [crossed-out wheeled bin WEEE Annex IV] indicates separate collection of waste electrical and electronic equipment in the EU countries.

Please do not throw the equipment into the domestic refuse.

Please use the return and collection systems available in your country for the disposal of this product.



This symbol [crossed-out wheeled bin Directive 2006/66/EC Annex II] indicates separate collection of waste batteries in the EU countries.

Please do not throw the batteries into the domestic refuse.

Please use the return and collection systems available in your country for the disposal of the waste batteries.

## Provisions of warranty

- 1 If this product proves to be defective, although it has been used properly (in accordance with the written Handling Care and Operating instructions supplied with it), during the applicable national warranty period and has been purchased from an authorized Olympus distributor within the business area of Olympus Europa Holding GmbH as stipulated on the website: <http://www.olympus.com> this product will be repaired, or at Olympus's option replaced, free of charge. To claim under this warranty the customer must take the product before the end of the applicable national warranty period to the dealer where the product was purchased or any other Olympus service station within the business area of Olympus Europa Holding GmbH as stipulated on the website: <http://www.olympus.com>. During the one year period of the World

Wide Guarantee the customer may turn the product in at any Olympus service station. Please notice that not in all countries such Olympus service station exists.

- 2 The customer shall transport the product to the dealer or Olympus authorized service station at his own risk and shall be responsible for any costs incurred in transporting the product.

## Provisions of Guarantee

- 1 "OLYMPUS IMAGING CORP.", 2951 Ishikawa-machi, Hachioji-shi, Tokyo 192-8507, Japan grants a one year World Wide Guarantee. This worldwide Guarantee must be presented at an Olympus authorized repair service station before any repair can be made under conditions of this Guarantee. This Guarantee is valid only if the Guarantee Certificate and proof of purchase are presented at the Olympus repair service station. Please note that this Guarantee is in addition to and does not affect the customer's legal warranty rights under the applicable national legislation governing the sale of consumer goods mentioned above.
- 2 This Guarantee does not cover the following and the customer will be required to pay repair charge, even for defects occurring within the Guarantee period referred to above.
  - (a) Any defect that occurs due to mishandling (such as an operation performed that is not mentioned in the Handling Care or other sections of the instructions, etc.)
  - (b) Any defect that occurs due to repair, modification, cleaning, etc. performed by anyone other than Olympus or an Olympus authorized service station.
  - (c) Any defect or damage that occurs due to transport, a fall, shock, etc. after purchase of the product.
  - (d) Any defect or damage that occurs due to fire, earthquake, flood damage, thunderbolt, other natural disasters, environmental pollution and irregular voltage sources.
  - (e) Any defect that occurs due to careless or improper storage (such as keeping the product under conditions of high temperature and humidity, near insect repellents such as naphthalene or harmful drugs, etc.), improper maintenance, etc.
  - (f) Any defect that occurs due to exhausted batteries, etc.
  - (g) Any defect that occurs due to sand, mud, etc. entering the inside of the product casing.
  - (h) When the Guarantee Certificate is not returned with the product.

- (i) When any alterations whatsoever are made to the Guarantee Certificate regarding the year, month and date of purchase, the customer's name, the dealer's name, and the serial number.
  - (j) When proof of purchase is not presented with this Guarantee Certificate.
- 3 This Guarantee applies to the product only; the Guarantee does not apply to any other accessory equipment, such as the case, strap, lens cap and batteries.
  - 4 Olympus's sole liability under this Guarantee shall be limited to repairing or replacing the product. Any liability under the Guarantee for indirect or consequential loss or damage of any kind incurred or suffered by the customer due to a defect of the product, and in particular any loss or damage caused to any lenses, films, other equipment or accessories used with the product or for any loss resulting from a delay in repair or loss of data, is excluded. Compelling regulations by law remain unaffected by this.

## Notes regarding Guarantee maintenance

- 1 This Guarantee will only be valid if the Guarantee Certificate is duly completed by Olympus or an authorized dealer or other documents contain sufficient proof. Therefore, please make sure that your name, the name of the dealer, the serial number and the year, month and date of purchase are all completed or the original invoice or the sales receipt (indicating the dealer's name, the date of purchase and product type) is attached to this Guarantee Certificate. Olympus reserves the right to refuse free-of-charge service if neither Guarantee Certificate is completed nor the above document is attached or if the information contained in it is incomplete or illegible.
- 2 Since this Guarantee Certificate will not be re-issued, keep it in a safe place.
  - Please refer to the list on the web site: <http://www.olympus.com> for the authorized international Olympus service network.

## Trademarks

- Microsoft and Windows are registered trademarks of Microsoft Corporation.
- Macintosh is a trademark of Apple Inc.
- SDXC Logo is a trademark of SD-3C, LLC.
- Eye-Fi is a trademark of Eye-Fi, Inc.
- FlashAir is a trademark of Toshiba Corporation.
- "Shadow Adjustment Technology" function contains patented technologies from Apical Limited.



- Slideshow transition technology supplied by HI Corporation.
- All other company and product names are registered trademarks and/or trademarks of their respective owners.
- Micro Four Thirds and the Micro Four Thirds logo are trademarks or registered trademarks of OLYMPUS IMAGING Corporation in Japan, the United States, the countries of the European Union, and other countries.
- "PENPAL" is used in reference to the OLYMPUS PENPAL.
- The standards for camera file systems referred to in this manual are the "Design Rule for Camera File System/DCF" standards stipulated by the Japan Electronics and Information Technology Industries Association (JEITA).



THIS PRODUCT IS LICENSED UNDER THE AVC PATENT PORTFOLIO LICENSE FOR THE PERSONAL AND NONCOMMERCIAL USE OF A CONSUMER TO (i) ENCODE VIDEO IN COMPLIANCE WITH THE AVC STANDARD ("AVC VIDEO") AND/OR (ii) DECODE AVC VIDEO THAT WAS ENCODED BY A CONSUMER ENGAGED IN A PERSONAL AND NON-COMMERCIAL ACTIVITY AND/OR WAS OBTAINED FROM A VIDEO PROVIDER LICENSED TO PROVIDE AVC VIDEO. NO LICENSE IS GRANTED OR SHALL BE IMPLIED FOR ANY OTHER USE. ADDITIONAL INFORMATION MAY BE OBTAINED FROM MPEG LA, L.L.C. SEE [HTTP://WWW.MPEGLA.COM](http://WWW.MPEGLA.COM)

# Index

## Symbols

RC Mode.....	113
(Language selection).....	71
Menu Display.....	71, 72
Set Home.....	73
Face Priority.....	56, 73
Lock.....	74
H fps.....	74
L fps.....	74
+ IS Off.....	74
Info Settings.....	75
Control Settings.....	74
Close Up Mode.....	75
Slow Limit.....	77
X-Sync.....	77
WB+WB.....	77
WB.....	78
Warning Level.....	80
(Underwater wide/underwater macro).....	82
(Index display).....	39
(Close-up playback).....	39
(Movie mode).....	27
Mode.....	79
(Single-frame erase).....	21
(Picture selection).....	21
(Protecting).....	41
(AF Area).....	35
Keep Warm Color.....	78
(Image rotation).....	67
Set.....	77
(Beep sound).....	75
(Audio recording).....	41
(Monitor brightness adjustment).....	71
(Slideshow).....	42
<b>A</b>	
<b>A</b> (Aperture priority mode).....	25
Address Book.....	90
AEL/AFL.....	73, 80
AEL Metering.....	76

AF Illuminat.....	73
AF Mode.....	55, 73
Album Mem. Usage.....	91
All .....	78
Anti-Shock .....	76
ART (Art filter mode).....	28
Art Fade.....	88
Art LV Mode.....	75
Aspect.....	51

## B

Backlit LCD.....	75
Bracketing.....	62
BULB.....	27
BULB/TIME Focusing.....	73
BULB/TIME Timer.....	76
Button Function.....	73

## C

Card Setup.....	59
Color Space.....	78
Connection to Smartphone.....	70
Copy All.....	91
Copyright Settings.....	79

## D

Date/time setting .....	16
Dial Direction.....	74
Dial Function.....	73
Digital Tele-converter.....	66, 82
Displayed Grid.....	75
dpi Settings.....	78

## E

Edit Filename.....	78
Erase Selected.....	21
EVF Adjust.....	91
EV Step.....	76
Exposure Shift.....	79
Eye-Fi.....	80

<b>F</b>	
File Name .....	78
Firmware.....	71
Flash intensity control  .....	53
Flicker reduction .....	75
Focus Ring .....	73
Full-time AF .....	73

<b>H</b>	
HDMI .....	74
Histogram Settings .....	75

<b>I</b>	
<b>IAUTO</b> (iAuto mode).....	17, 19
Image Aspect.....	51
Image Overlay .....	69
Image Stabilizer.....	47
INFO button.....	23, 32, 38
ISO .....	56, 76
ISO-Auto.....	76
ISO-Auto Set .....	76
ISO Step.....	76

<b>J</b>	
JPEG Edit.....	68

<b>L</b>	
Lens I.S. Priority .....	74
Level Adjust .....	80
Live BULB.....	76
Live Guide .....	31, 82
Live TIME .....	76
LIVE TIME .....	27
Live View Boost.....	75
LV super control panel.....	85

<b>M</b>	
<b>M</b> (Manual shooting) .....	26
Metering.....	54
MF .....	81
MF Assist.....	73
Mode Dial Function.....	74
Mode Guide.....	75
Movie  .....	57, 79

Movie Play.....	40
Movie Tele-converter .....	88
MTP.....	98
Multi Echo.....	88
Multiple Exposure  .....	64
My OLYMPUS PENPAL.....	91

<b>N</b>	
Noise Filter .....	76
Noise Reduct.....	76

<b>O</b>	
OLYMPUS PENPAL Album .....	91
OLYMPUS PENPAL Share.....	89, 90
One Shot Echo .....	88

<b>P</b>	
<b>P</b> (Program shooting).....	24
Picture Copy Size .....	91
Picture Mode .....	48, 60
Picture Mode Settings .....	75
Pixel Count .....	77
Pixel Mapping.....	104
Print.....	93
Print reservation  .....	92
Priority Set.....	78

<b>Q</b>	
Quick Erase.....	78

<b>R</b>	
RAW Data Edit .....	67
RAW+JPEG Erase .....	78
Recording Volume .....	79
Rec View .....	71
Release Lag-Time .....	74
Reset Lens .....	73
Reset/Myset.....	59
Reset Protect.....	69, 91
RIs Priority C.....	74
RIs Priority S.....	74
Rotate.....	41

<b>S</b>	
S (Shutter priority shooting) .....	26
Shading Comp.....	77
Sleep .....	75
Storage.....	98
<b>T</b>	
Time Lapse Settings.....	65
Touch Screen Settings.....	80
<b>U</b>	
USB Mode .....	75
<b>V</b>	
Video Out.....	74
<b>W</b>	
WB.....	50, 77

## OLYMPUS EUROPA HOLDING GMBH

Premises: Consumer Product Division  
Wendenstrasse 14 – 18, 20097 Hamburg, Germany  
Tel.: +49 40 - 23 77 3-0 / Fax: +49 40 - 23 07 61

Goods delivery: Modul H, Willi-Bleicher Str. 36, 52353 Düren, Germany

Letters: Postfach 10 49 08, 20034 Hamburg, Germany

### European Technical Customer Support:

Please visit our homepage <http://www.olympus-europa.com>  
or call our TOLL FREE NUMBER\*: **00800 - 67 10 83 00**

for Austria, Belgium, Denmark, Finland, France, Germany, Luxemburg, Netherlands,  
Norway, Portugal, Spain, Sweden, Switzerland, United Kingdom.

\* Please note some (mobile) phone services / provider do not permit access or request an  
additional prefix to +800 numbers.

For all not listed European Countries and in case that you can't get connected  
to the above mentioned number please make use of the following

CHARGED NUMBERS: **+49 180 5 - 67 10 83** or **+49 40 - 237 73 48 99**.

Our Technical Customer Support is available from 9 am to 6 pm MET (Monday to Friday).

### Authorized Distributors

#### **United Kingdom: Olympus Service Department**

**/Eire**

Olympus Imaging & Audio  
KeyMed House  
Stock Road  
Southend-on-Sea  
Essex  
SS2 5QH  
United Kingdom

Service - 0800 111 4888

Fax: +44 (0) 1702 452763

E-mail: [customer.support@olympus.co.uk](mailto:customer.support@olympus.co.uk)

[www.olympus.co.uk](http://www.olympus.co.uk)

#### **South Africa: Tudortech (Pty) Ltd.**

Ground floor, Building 1A,  
Wedgefield Office Park,  
17 Muswell Road,  
Bryanston 219  
South Africa  
Tel: +27 (0) 11 803 2226  
Fax: +27 (0) 86 639 5359





<http://www.olympus.com/>

**OLYMPUS IMAGING AMERICA INC.**

3500 Corporate Parkway, P.O. Box 610, Center Valley, PA 18034-0610, U.S.A. Tel. 484-896-5000

**Technical Support (U.S.A.)**

24/7 online automated help: <http://www.olympusamerica.com/support>

Phone customer support: Tel. 1-800-260-1625 (Toll-free)

Our phone customer support is available from 9am to 9pm (Monday to Friday) ET

E-mail: [distec@olympus.com](mailto:distec@olympus.com)

To find the nearest Service Centers, please visit: <http://olympusamerica.com/repair>

**Service Centers**

**U.S.A./CANADA:**

**Olympus Imaging America Inc.**

Tel: (800)622-6372

<http://www.olympusamerica.com/repair>

**Mexico:**

**Olympus Imaging de Mexico**

**S.A. de C.V.**

Tel: 01 800 8002128

<http://www.olympus.com.mx>