

User's Guide

TRENDNET[®]



**Indoor/Outdoor 2MP 1080p
Varifocal PoE IR Dome Network Camera**

TV-IP341PI

Contents

Product Overview	4
Features	4
Hardware	4
Package Contents	5
Hardware	6
Warnings	7
Cautions	8
Plan for Installation	8
Viewing angle	8
Weather Conditions	8
Hardware Installation	9
Disassemble	9
Memory Card Installation	10
Mounting	10
Zoom and Focus	11
Setup Your Camera with CD	12
Access your Camera with the Web Browser	14
System Management and Default Settings	14
Logging-in to the Camera for the First Time (Windows)	14
Logging-in to the Camera for the First Time (OS X)	17
Live View	22
Playback	23
Log	26
System Information	27

System Configuration	28
Device Settings	28
User Accounts	29
Time Settings	29
Daylight Savings	30
Live View Settings	31
Maintenance	32
Network Settings	33
TCP/IP	33
Port	34
DDNS	34
PPPoE	35
SNMP	35
802.1X	37
IP Address Filter	37
Quality of Service (QoS)	38
UPnP	38
Video Settings	39
Video Format	39
Display Settings	40
On Screen Display Settings	42
Text Overlay	43
Privacy Mask	43
Video Recording	44

Events	45
Motion Detection	45
Video Tampering	47
Notification	48
Snapshot	48
Email	49
Alarm Input.....	50
Alarm Output.....	51
Network Storage	52
Network Storage.....	52
Storage Management.....	53
FTP Server	54
Regulations	55
Federal Communication Commission Interference Statement	55
RoHS	55
Europe – EU Declaration of Conformity	56
Limited Warranty	57

Product Overview



TV-IP341PI

Features

The Indoor/Outdoor 2MP 1080p Varifocal PoE IR Dome Network Camera, model TV-IP341PI, provides day and night surveillance with a night vision range of up to 30 meters (98 ft.) This dome network camera delivers year-round surveillance with an IP66 weather rated housing to withstand extreme environments. A built-in 2.8-12mm manual zoom varifocal lens allows you to adjust the field of view to meet your installation needs. Record 1080p video (1920 x 1080) at 30 fps in a space saving H.264 compression format. Manage up to 32 TRENDnet cameras with included complimentary software and mobile apps.

Hardware

Varifocal Lens

A built-in 2.8 – 12mm manual zoom varifocal lens allows you to adjust the field of view from 113° – 33.8° to achieve the perfect viewing field for your installation.

2 Megapixel

Record 1080p (1920 x 1080) HD video at 30 fps in the space saving H.264 compression format

Night Vision

Night vision up to 30 meters (98 ft.)

Smart IR

Dynamic IR adjustment optimizes night visibility

PoE

Save installation costs with Power over Ethernet (PoE)

IP66 Rating

Outdoor IP66 weather rated housing

Storage

Record video to a network storage device or to a Micro SD card (up to 64 GB sold separately).

Advanced Playback

Advanced in-camera archived video review functionality

Motion Detection

Create custom motion detection zones to record video and send email notifications when a zone is triggered.

Tamper Detection

Create custom tamper detection zones to send an email notification when the camera view has been obstructed.

Digital Wide Dynamic Range (D-WDR)

Adjustable D-WDR setting Improves image quality and focusing when a camera is exposed to high contrast lighting environments by enhancing the dark areas of the image to make them more visible.

Recording Flexibility

Define custom schedules using continuous (24/7) and/or event based recording modes.

Audio Support

Audio input/output for third party microphone and speaker (sold separately)

Input/Output Alarm

Network to an alarm system with the alarm input/output connections

BNC Port

BNC analog video-out port to connect directly to a video display for installation flexibility

IPv6

IPv6 support

ONVIF/PSIA

ONVIF Profile S, Profile G and PSIA compliant

Complimentary Software

Complimentary pro-grade software to manage up to 32 TRENDnet cameras

Complimentary Apps

Live video to a mobile device with free iOS® and Android™ apps

Package Contents

TV-IP341PI package includes:

- TV-IP341PI
- Quick Installation Guide
- CD-ROM (Utility and User's Guide)
- Camera mounting hardware
- (Optional power adapter not included)

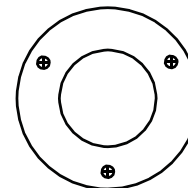

Drilling Template



Mounting Screws

Hardware

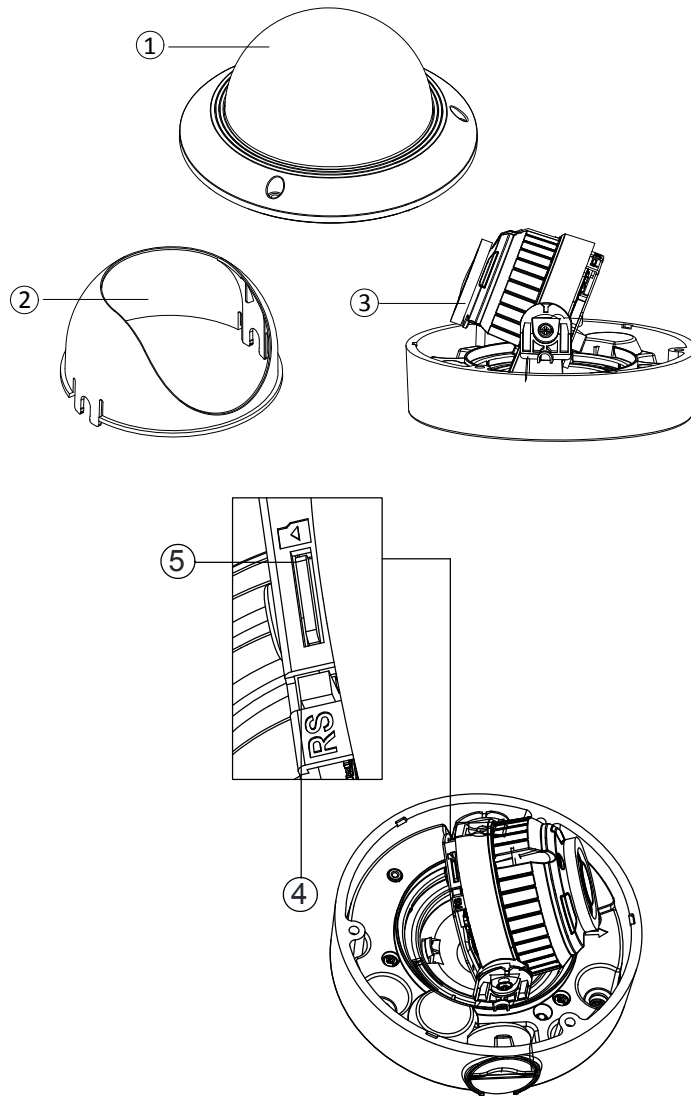

N o.	Description
1	Bubble
2	Black Liner
3	Lens
4	Reset
5	Memory Card Slot
6	GND

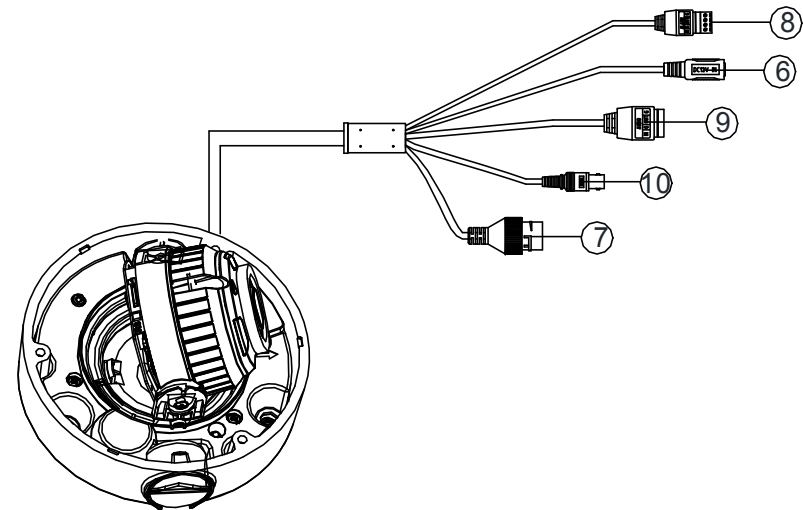

No.	Description
6	Power connector
7	PoE network connector
8	Alarm Wires
9	Audio I/O
10	BNC

The option power connector can work with 12V DC 1A power adapter.

Warnings

Serious injury or death may be caused if any of these warnings are neglected. Follow these safety guards to prevent serious injury or death.

- If using the power adapter, please choose the power adapter that meets the safety extra low voltage (SELV) standard and Limited Power Source standard.
- If the product does not work properly, please contact your dealer or the nearest service center. Never attempt to disassemble the camera yourself. Disassembling the product will void the warranty and may cause harm or injury.
- To reduce the risk of fire or electrical shock, do not expose this product to rain or water.
- The installation should be done by a qualified service person and should conform to all construction and electric regulations and other local codes.

Cautions

Injury or equipment damage may be caused if any of these cautions are neglected. Follow these precautions to prevent potential injury or material damage.

- Make sure the power supply voltage is correct before using the Camera.
- Do not drop the camera or subject to physical shock.
- Do not touch sensor modules with fingers. If cleaning is necessary, use a clean cloth with a bit of ethanol and wipe it gently. If the camera will not be used for an extended period of time, put on the lens cap to protect the sensor from dirt.
- Do not aim the camera lens at the strong light such as the Sun or an incandescent lamp. Strong light can damage the camera sensor.
- The sensor may be burned out by a laser beam, so when any laser equipment is being used, make sure that the surface of the sensor will not be exposed to the laser beam.
- Do not place the camera in extremely hot, cold temperatures (the operating temperature should be between -10°C to 60°C), dusty or damp environment, and do not expose it to high electromagnetic radiation.
- To avoid heat accumulation, good ventilation is required for a proper operating environment.
- Keep out of water and any liquid.
- While shipping, the camera should be packed in its original packing.

Plan for Installation

There are number of factors involved in a successful camera installation. Follow the suggested installation steps and go through the check lists. This guide will help you make your camera installation smoothly and easily.

Viewing angle

The TV-IP341PI is a bullet camera with a focused viewing angle (113° – 33.8°) that provides non-distorted and detailed images. Choose the location where has good angle to shoot the image you expect to see. The motion detection area should also be considered when installing the camera.

Weather Conditions

The TV-IP341PI is a small bullet camera, which fits most installations indoor and outdoor. The camera can work under a wide range of weather conditions. For severe weather conditions, a camera housing with temperature and moisture control is recommended. Using the camera in milder weather conditions will help extend the camera's product life and preserve the quality of the video image.

- **Moisture:** Avoid damp or moist environments whenever you can. The TV-IP341PI is an IP66 grade water proof camera, and it will work in moist environments. However, rain may affect the picture quality, especially at night, water may reflect the light from the infra-red illumination and degrade picture quality.

- **Temperature:** TV-IP341PI works within a specified temperature range. Areas with severe temperatures should be avoided when installing the camera. It's recommended that you use an enclosure with a heater and blower if you plan on using this camera outside of the specified temperature range.
- **Sunlight:** Avoid direct sun light exposure. Direct sun light will damage the image sensor. If sunlight is necessary for your viewing purposes, provide protection for the image sensor.
- **Lighting:** Consider installing your camera faces the same direction of the light sources. Shooting images with top-down position outdoor or next to the existing light source are good choices. Avoid the light source if it creates a shade that darkens the viewing area.

Hardware Installation

Disassemble

1. Loosen the three screws on the edge of the bubble with the screw driver.
2. Lift and put aside the bubble.
3. Remove the inner black liner.

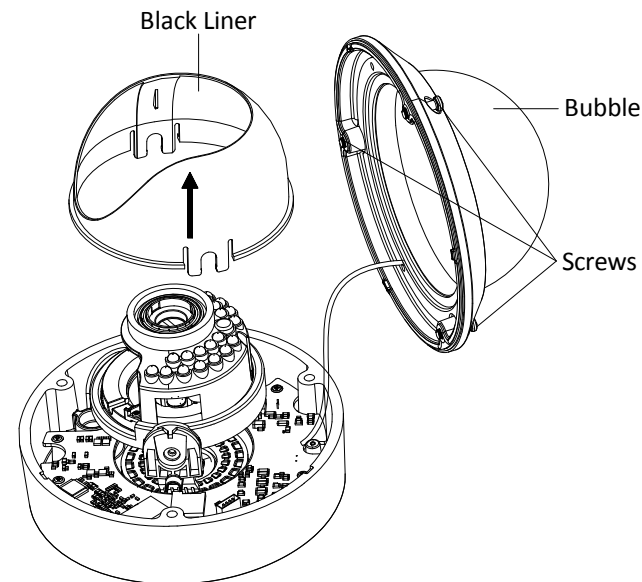

Memory Card Installation

1. Rotate the camera body to expose the memory card slot. Insert and push the memory card into the slot to mount.

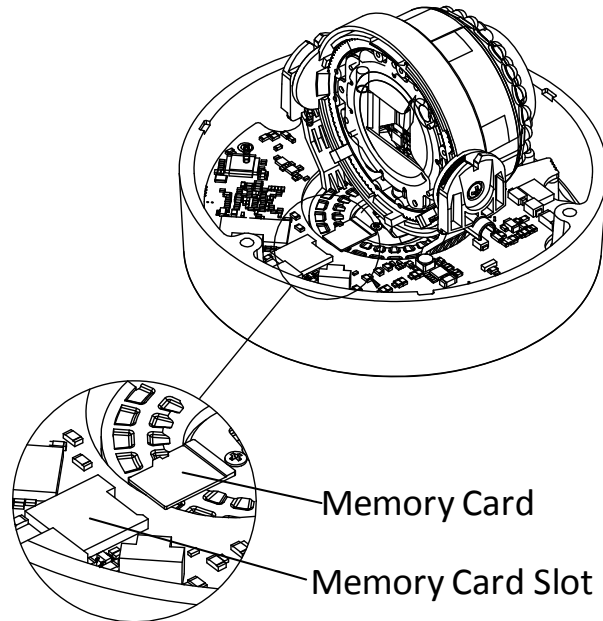

2. (Optional) To unmount the memory card, push to eject.

Mounting

1. Attach the drill template (supplied) to the wall or the ceiling where the camera is to be mounted.
2. Drill three screw holes on the ceiling.

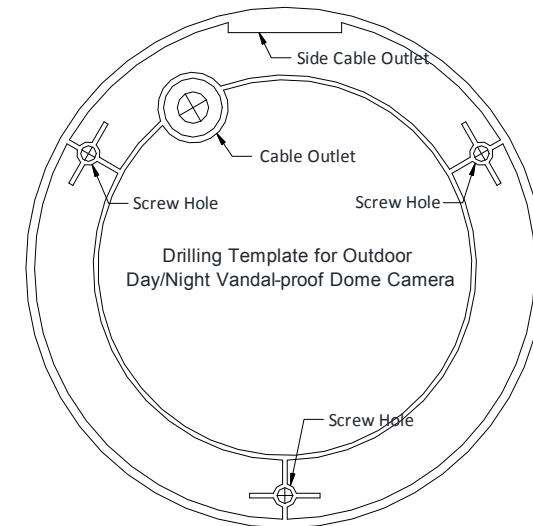

3. If you need to route cables through the wall (or the ceiling), cut a cable hole according to the drill template. Skip this step, if you want to route the cables on the surface of the wall (or the ceiling).
4. Align the holes from bottom of the device with the drilled holes and secure the camera with the supplied screws.

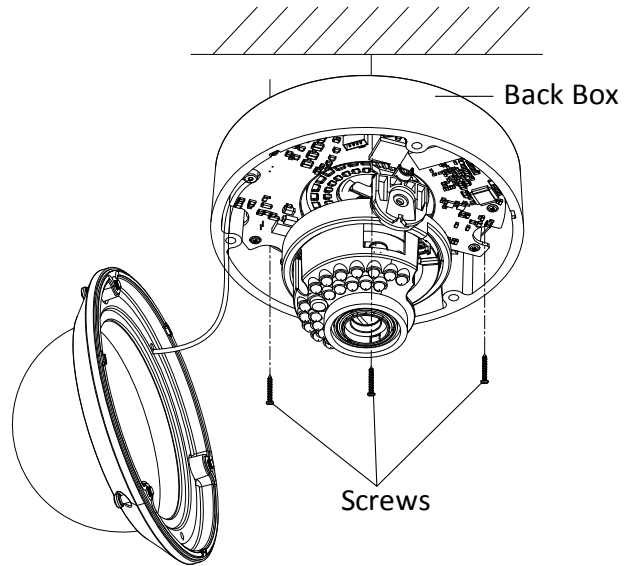

5. Adjust the view angle then put the black liner and bubble cover back on to the camera and secure it with screws.

6. (Optional) Install the water-proof jacket for network connector

Zoom and Focus

1. View the camera image by using a computer
2. Loosen the zoom lever and move the lever between T (Tele) and W (Wide) to obtain the desire viewing angle.

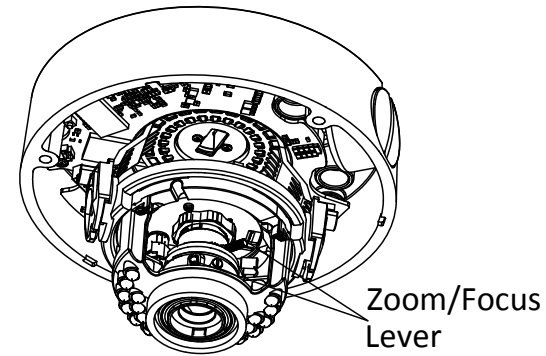

3. Tighten the zoom lever.
4. Loosen the focus lever and move the lever between F (Far) and N (Near) to adjust the desire focus.
5. After done, tighten the focus lever.

Setup Your Camera with CD

1. Insert the Installation CD-ROM into your computer's CD-ROM drive to initiate the Auto-Run program. Choose your preferred language and then click the **Install Camera Utility**.



2. Install the Camera Utility as instructed.

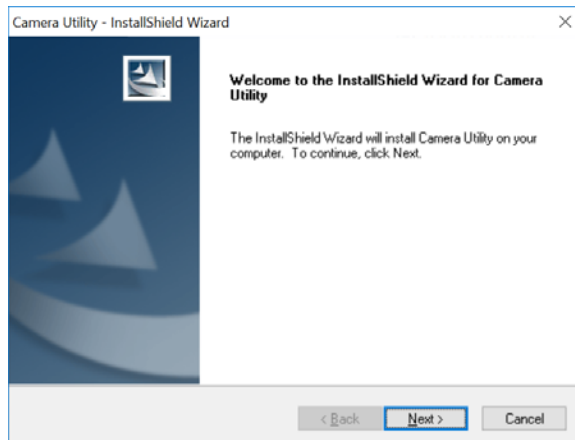

3. Last, click Next to finish the installation

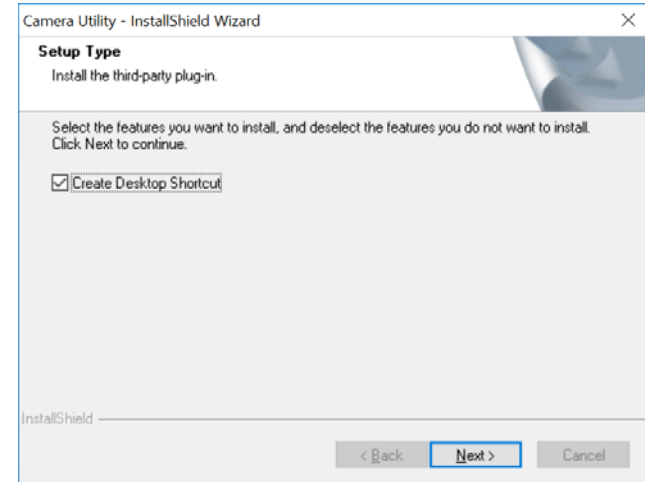

4. This will also require you to install WinPcap program if you don't have this installed before, please follow the on screen instruction to install it.

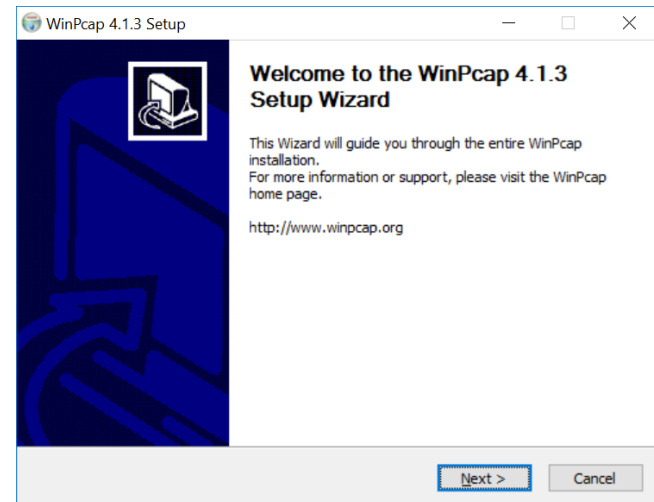

5. Restart the computer after the installations.

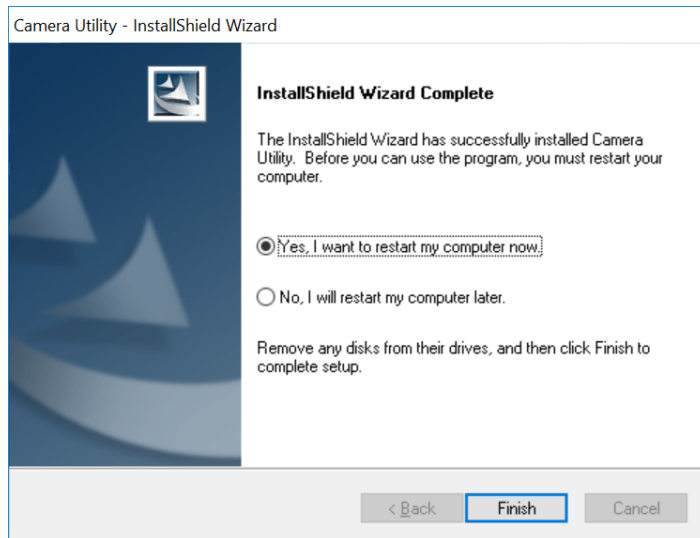

6. After computer is restarted, double click on the Camera Utility icon to launch the program.

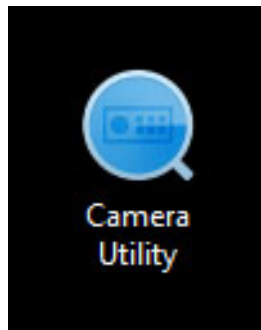

7. Find the camera you would like to access and configure then double click on the IP address.

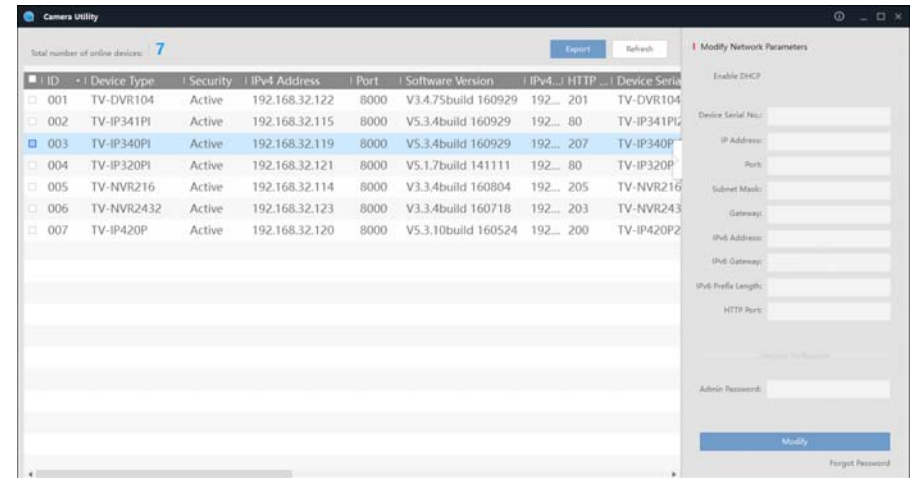

8. Continue to the next section **Access your Camera with the Web Browser** for detail configurations of the camera.

Access your Camera with the Web Browser

System Management and Default Settings

It is recommended that you install your camera with the CD that comes with the package and use accompanying TRENDnetVIEW Pro software (version 2.5.8 or later) for Windows computers. The software is included on the CD comes with the package. If you do not have the CD with you, you can go to <http://www.TRENDnet.com/support> enter the model number "TV-IP341PI" and download the software.

System Default	
Management IP	Dynamic assigned if there's a DHCP server on the network or self-assigned 192.168.10.30
Administrator name	admin
Administrator password	admin

If you want to access your camera directly instead of using software, you can follow the steps specified in this chapter to login to your camera. A web browser plug-in must be installed to watch video smoothly.

For **Windows** system, please go to the next paragraph.

For **OS X** system, please go directly to page 17

Logging-in to the Camera for the First Time (Windows)

1. Open the web browser on your computer. In the address bar, enter the IP address you setup through the setup CD or 192.168.10.30.
(If you have a DHCP server on your network, the IP address will be assigned dynamically. For example, if you have a home gateway on your network and you plug-in the camera on the same network, you can find the camera's IP address on your home gateway.), and then press **Enter**.

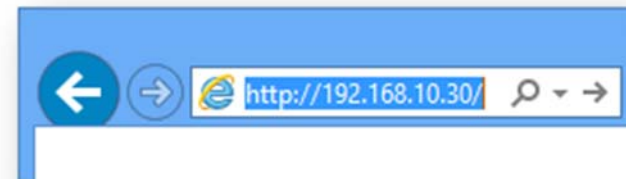

2. Enter the user name, **admin**, and the password you setup through the setup CD or the default password, **admin**, and then click **OK**.

 A screenshot of the camera's login interface. It features a dark grey background with white text and input fields. There are three rows of input fields: "User Name" with an empty text box, "Password" with an empty text box, and "Languages" with a dropdown menu showing "English". Below these fields is a blue "Login" button.

- The camera management page will detect if you installed the camera video streaming plug-in or not. Click the link to download the plug-in from the TV-IP341PI camera.

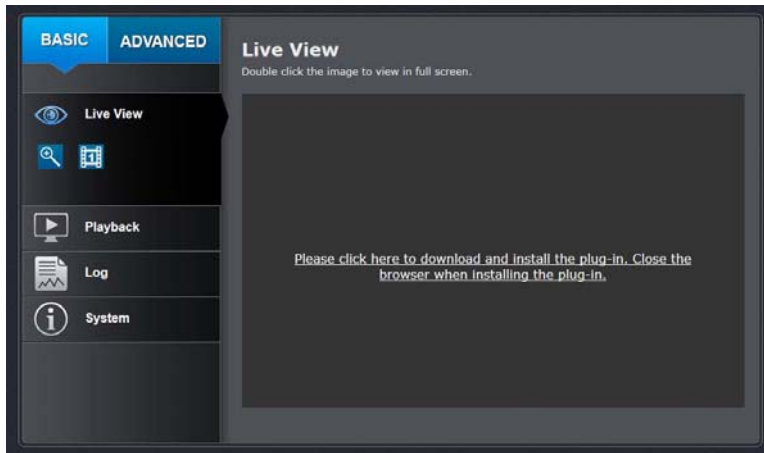

- Download the plug-in to your computer and then close your browser. Launch the plug-in installation to install the plug-in.



- Permission request may show up depends on the Internet security settings on your computer. Click **More Info** and then **Run anyway** to install the plug-in.

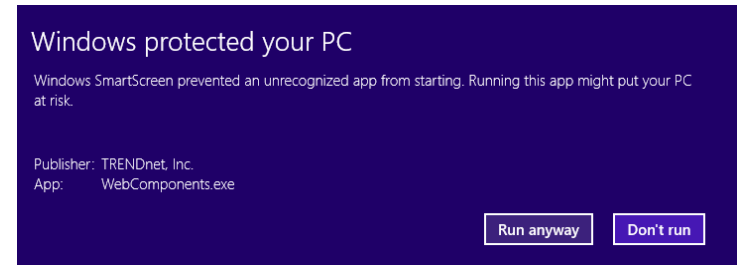
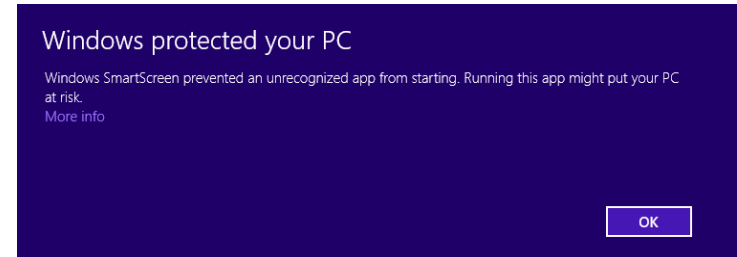

- Click **Next** to install the plug-in.

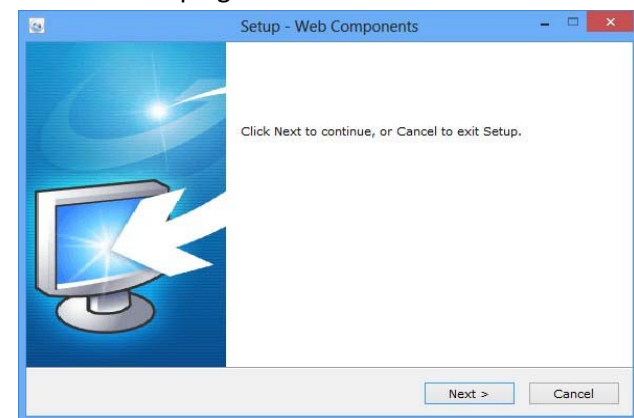

7. Click **Finish** to finish the installation.

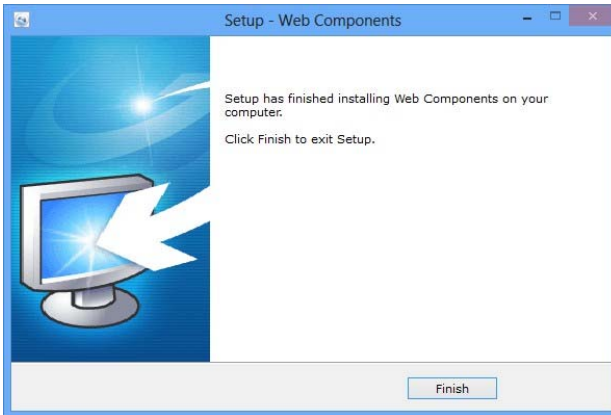

8. Open the browser and login again.

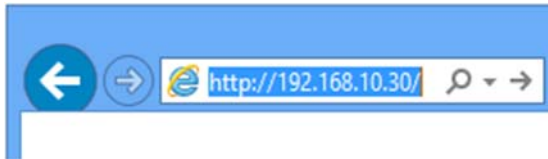

9. (Go to step 11 if you already changed your password with the setup CD). The TV-IP341PI will ask you to change your password from default setting. Please enter the new password twice and click **OK**. The password must be between 8 and 16 characters. (Alphanumeric: a-z, A-Z, 0-9, !, @, #, \$).

PLEASE ENTER YOUR NEW ADMINISTRATOR PASSWORD	
User Name	<input type="text" value="admin"/>
Password	<input type="password" value="....."/>
Confirm	<input type="password" value="..... "/>
<input type="button" value="OK"/>	

10. Enter the user name **admin** and new password again to start secured session.

User Name	<input type="text"/>
Password	<input type="password"/>
Languages	English <input type="button" value="v"/>
<input type="button" value="Login"/>	

11. The Live View page will show up and begin streaming video.

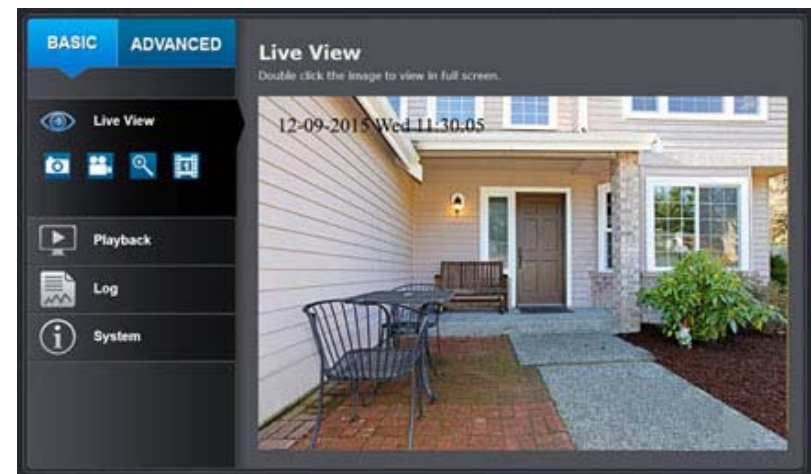

Logging-in to the Camera for the First Time (OS X)

1. Open the web browser on your computer. In the address bar, enter the IP address of the camera 192.168.10.30. (If you have a DHCP server on your network, the IP address will be assigned dynamically. For example, if you have a home gateway on your network and you plug-in the camera on the same network, then you can find the camera IP address on your home gateway), and then press Enter.

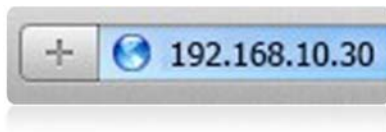

2. Enter the user name, **admin**, and the default password, **admin**, and then click **OK**.



3. The camera management page will detect if you installed the camera video streaming plug-in or not. Click the link to download the plug-in from the TV-IP341PI camera.

*Note: Internet connection is required to download the plug-in. If you do not have Internet access, you can find the plug-in on the CD comes with the package under **/Mac** folder.*

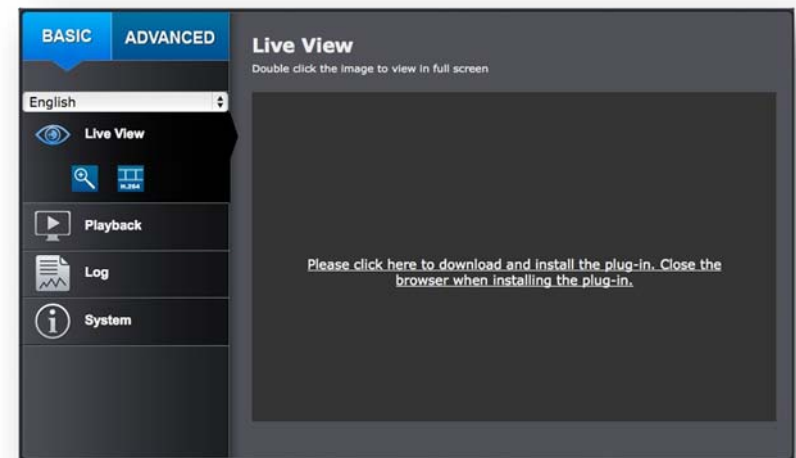

4. Quit your browser completely by **command-Click** on the browser icon and then click **Quit** before installing the plug-in.



5. Go to the **Finder** and navigate to the **Download** folder. **Command-Click** the **WebComponents.pkg** and then click **Open**. (If you are install the plug-in from the CD, just browse to /Mac folder and double click the **WebComponents.pkg** file.)

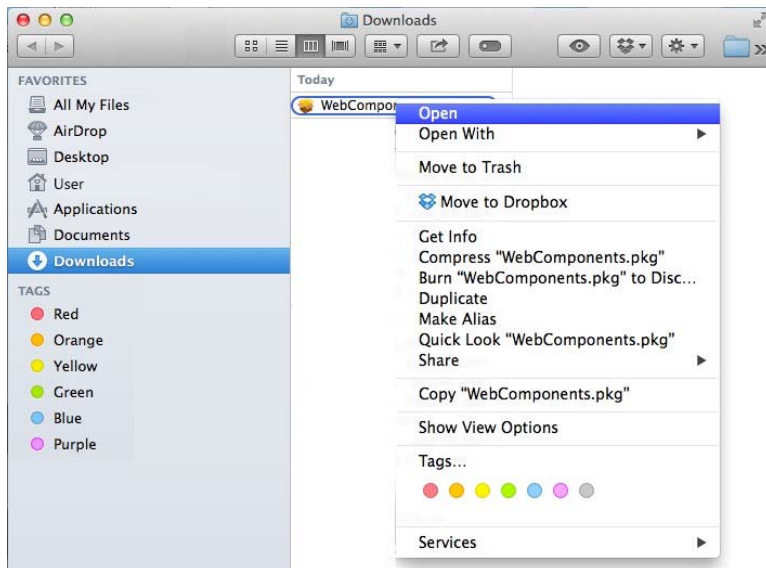

6. Click **Open** to start installation.



7. Click **Continue** to install the plug-in.



8. Select a destination to install the plug-in. Then click **Continue**.

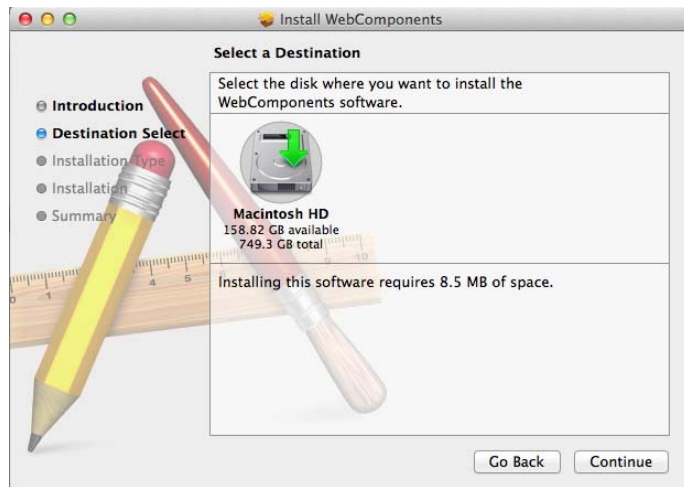

9. Use the default location and click **Install**.

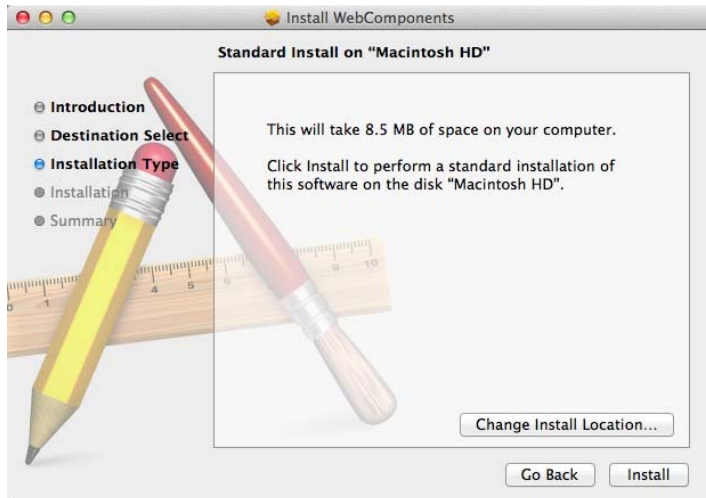

10. Enter your password and click **Install Software**



11. Installation will process automatically.

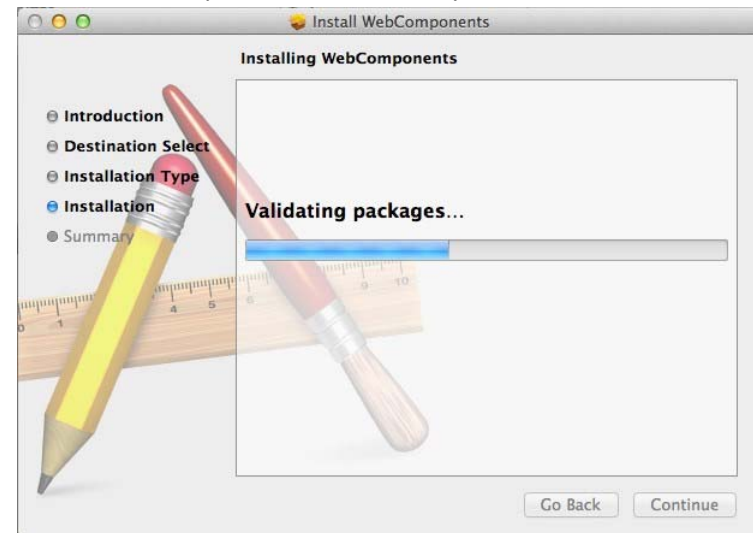

12. Click **Close** to exit the installation.

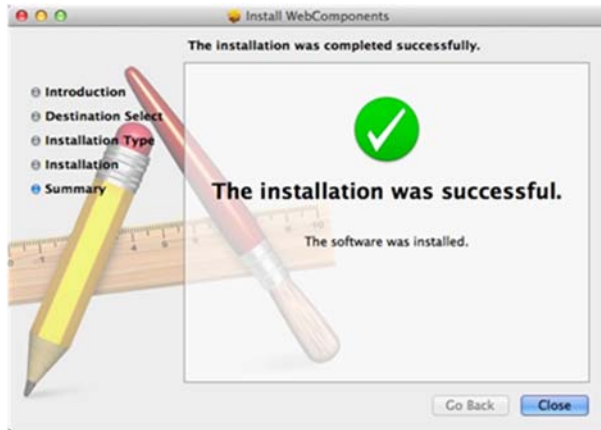

13. Open the browser and login again with the default IP 192.168.10.30 or the IP that was dynamically assigned by your router.

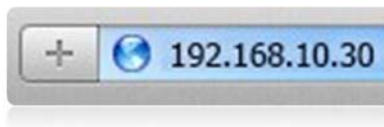

14. Enter the user name, **admin**, and the default password, **admin**, and then click **OK**.

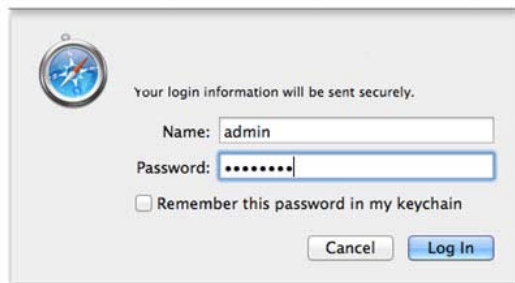

15. Click **Trust** (You'll have to do this again when your camera changes to a new IP address.)



16. The TV-IP341PI will ask you to change your password from the default setting. Please enter the new password twice and click **OK**. The password must be between 8 and 16 characters. (Alphanumeric: a-z, A-Z, 0-9, !, @, #, \$).

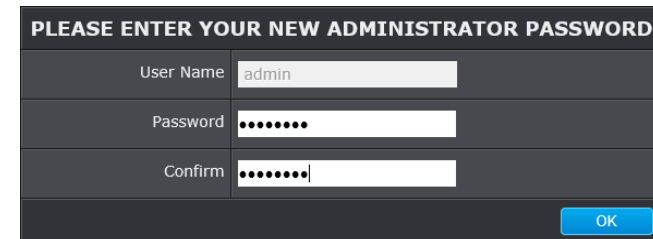

17. Enter the user name **admin** and new password again to start secured session.



18. The Live View page shows up and the video starts to stream.

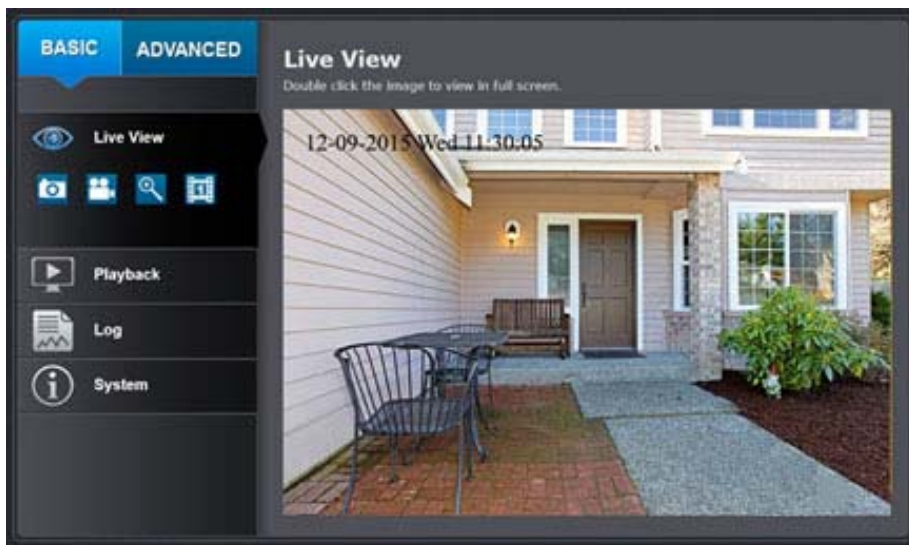

Live View

After you log-in into the camera management page, you'll see the Live View page.

Multi-Language

Change your preferred language anytime.

Snapshot

Click this icon to take a video snapshot.

Zoom

Click once to enable zoom. When enabled, click and drag the area on the picture to zoom in. Right click to resume 100% zoom. Click the icon again to disable zoom. The zoom function works in full screen mode as well.

Recording

Click once to start recording. Click it again to stop recording. The status bar will indicate if it is in recording state or not.

Video Stream

TV-IP340PI has two video streams: H.264 and MJPEG. Switch to view the different video streams by clicking this icon.

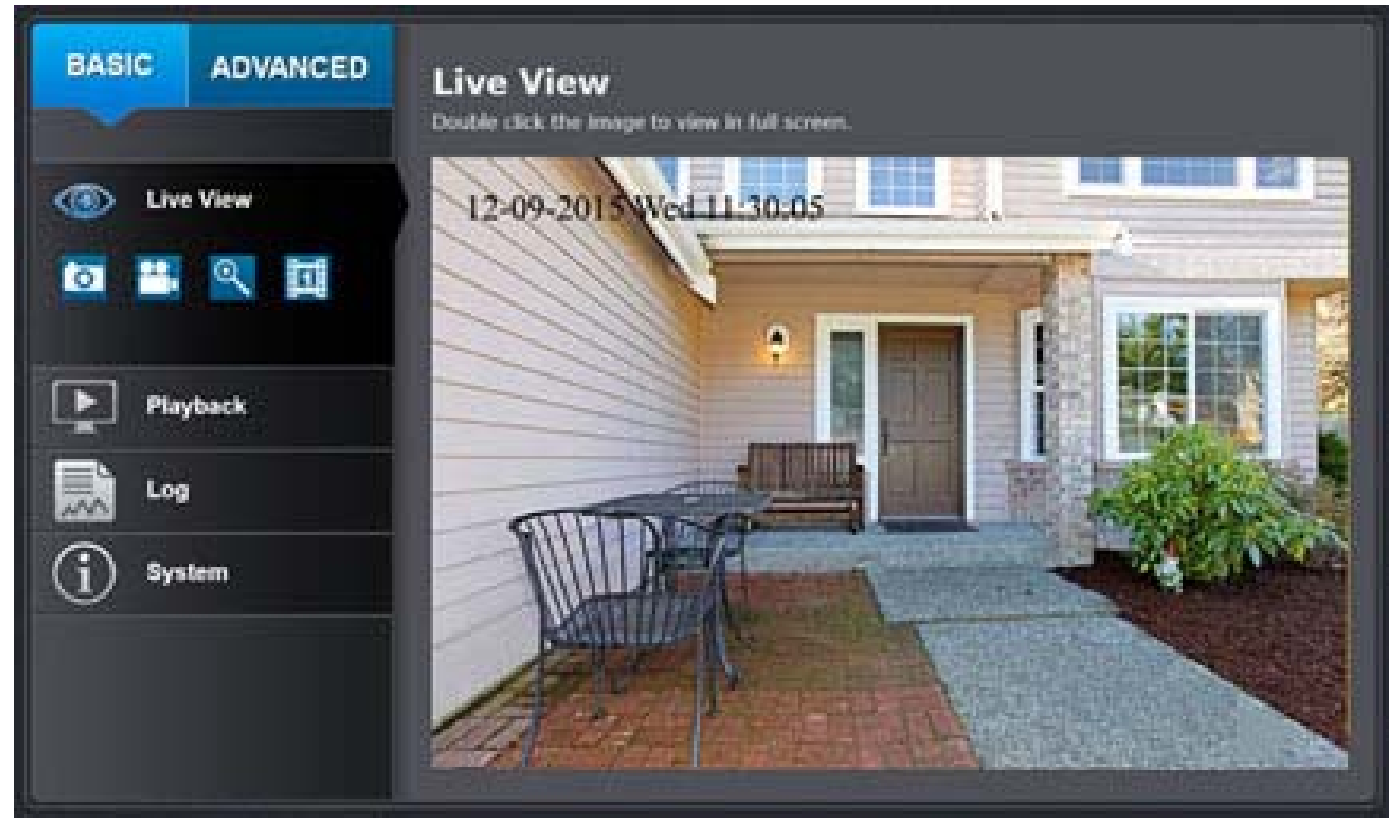

Full Screen Mode

Click the picture to view in full screen mode. Double click again or press escape key on your keyboard to exit full screen mode.

Status Bar

The status bar shows the status you are at, including enabled the zoom, recording video, and successfully taking a snapshot.

Where can I find saved files?

Videos and snapshots captured from Live View will save to your computer. See **Live View Settings** on page 31 for details.

Playback

You can playback the video recording on the network storage and download the video clip and snapshots to your local computer.

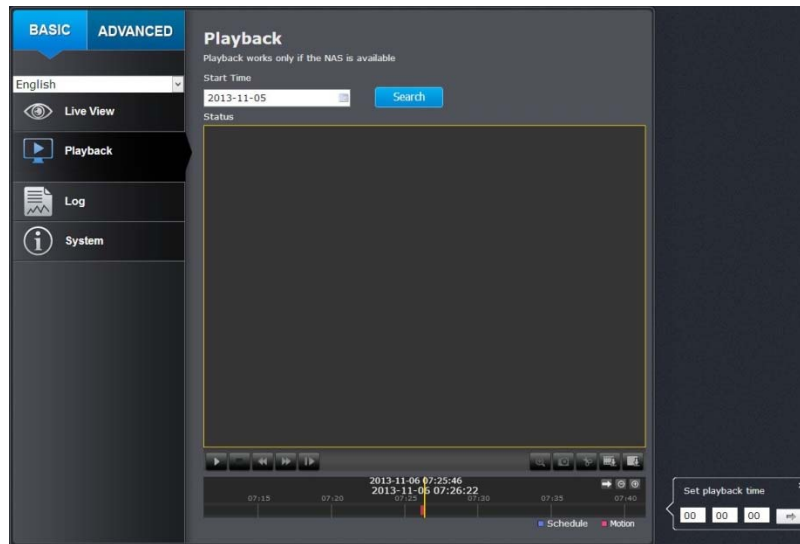

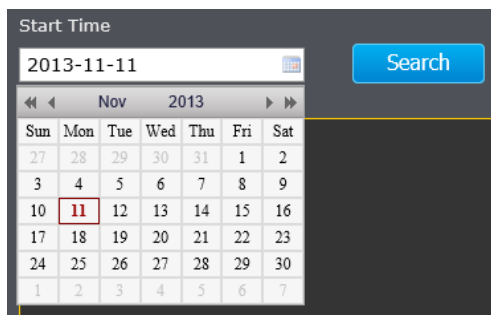

Search for video recordings

Click the date selection, and then choose a date as the date range of searching. Click **Search** to start searching.



Time Line

There is a play back head in the center of the time line represented in a yellow vertical line. To look for a specific video recording, move the time line by clicking and dragging it. If the recording is short, zoom in by clicking  button. Click  to zoom out the time scale. If you know the exact time of the day you are looking for, click  then enter the time you want to playback.

Different types of recordings are identified differently. The scheduled recordings are marked in blue, and the recordings triggered by motion detection are marked in red.

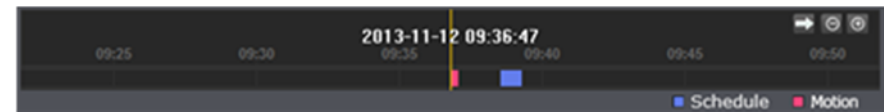

Click and drag the time line to move your time manually.



Click this button to zoom in the scale



Click this button to zoom out of the scale



Click this button to specify a specific time of the day.

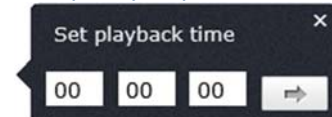





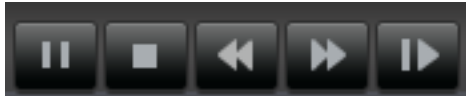

then click  to confirm selection and then click X to close this dialog box.

Playback

Use playback controls to play back the video recording.







-  Click this button to play the video.
-  Click this button to pause video playback.
-  Click this button to stop playback.
-  Click this button increase playback speed*.
-  Click this button decrease playback speed*.
-  Click to playback video frame by frame. Click again for the next frame↓

* Note: There are 5 steps of playback speed you can choose from: 1/4, 1/2, 1, 2, and 4 times of original speed.

Slice images from video playback

You can take snapshots from playback video or make new video clips from the video you are playing back.



-  Click this button to enable zoom. Then click and drag on the video to define the area you want to zoom in. Click again to get back to 100% zoom.
Double click to show video in full screen and press **ESC** on keyboard to exit full screen mode.
-  Click this button to disable zoom.
-  Click this button to take a snapshot of current playback.
-  Click this button to start clipping a video from playback.
-  Click this button to stop clipping a video from playback.

Where can I find saved files?

Videos and snapshots captured from Playback will be saved to your computer. See **Live View Settings** on page 31 for details.

Download sections of video

To save complete video sections or snapshots, you can download the files directly.



Click  button to download video sections.

No.	File Name	Start Time	End Time	File Size	Progress
<input checked="" type="checkbox"/>	1 ch01_08000000000000401	2013-11-06 07:26:02	2013-11-06 07:26:22	2 MB	Downloaded
<input type="checkbox"/>	2 ch01_08000000000000501	2013-11-06 07:37:00	2013-11-06 07:37:20	1 MB	

[Download](#)

Total 2 Items First Page Prev Page 1/1 Next Page Last Page

Check the time of the recording, select the videos you want to download, and then click **Download**.

Download snapshots

Click  button to list snapshots to download

No.	File Name	File Date	File Size	Progress
<input type="checkbox"/>	1 ch00_08000000000301901	2013-11-12 09:28:49	107 KB	
<input type="checkbox"/>	2 ch00_08000000000302001	2013-11-12 09:28:50	65 KB	
<input type="checkbox"/>	3 ch00_08000000000302101	2013-11-12 09:28:51	57 KB	
<input type="checkbox"/>	4 ch00_08000000000302201	2013-11-12 09:28:52	52 KB	
<input type="checkbox"/>	5 ch00_08000000000302301	2013-11-12 09:28:53	52 KB	
<input type="checkbox"/>	6 ch00_08000000000302401	2013-11-12 09:28:54	53 KB	
<input type="checkbox"/>	7 ch00_08000000000302501	2013-11-12 09:28:55	53 KB	
<input type="checkbox"/>	8 ch00_08000000000302601	2013-11-12 09:28:56	53 KB	
<input type="checkbox"/>	9 ch00_08000000000302701	2013-11-12 09:28:57	53 KB	
<input type="checkbox"/>	10 ch00_08000000000302801	2013-11-12 09:36:54	181 KB	
<input type="checkbox"/>	11 ch00_08000000000302901	2013-11-12 09:36:55	58 KB	
<input type="checkbox"/>	12 ch00_08000000000303001	2013-11-12 09:36:56	54 KB	
<input type="checkbox"/>	13 ch00_08000000000303101	2013-11-12 09:36:57	52 KB	
<input type="checkbox"/>	14 ch00_08000000000303201	2013-11-12 09:36:58	52 KB	
<input type="checkbox"/>	15 ch00_08000000000303301	2013-11-12 09:36:59	52 KB	
<input type="checkbox"/>	16 ch00_08000000000303401	2013-11-12 09:37:00	52 KB	
<input type="checkbox"/>	17 ch00_08000000000303501	2013-11-12 09:37:01	52 KB	
<input type="checkbox"/>	18 ch00_08000000000303601	2013-11-12 09:37:02	52 KB	
<input type="checkbox"/>	19 ch00_08000000000303701	2013-11-12 09:39:05	54 KB	
<input type="checkbox"/>	20 ch00_08000000000303801	2013-11-12 09:39:06	55 KB	
<input type="checkbox"/>	21 ch00_08000000000303901	2013-11-12 09:39:07	52 KB	
<input type="checkbox"/>	22 ch00_08000000000304001	2013-11-12 09:39:08	52 KB	
<input type="checkbox"/>	23 ch00_08000000000304101	2013-11-12 09:39:09	53 KB	
<input type="checkbox"/>	24 ch00_08000000000304201	2013-11-12 09:39:10	53 KB	
<input type="checkbox"/>	25 ch00_08000000000304301	2013-11-12 09:39:11	52 KB	
<input type="checkbox"/>	26 ch00_08000000000304401	2013-11-12 09:39:12	53 KB	
<input type="checkbox"/>	27 ch00_08000000000304501	2013-11-12 09:39:13	53 KB	

Total 27 Items First Page Prev Page 1/1 Next Page Last Page

Motion

Start Time
2013-11-12 00:00:00

End Time
2013-11-12 23:59:59

Schedule Motion

Select the type of event that triggered the snapshots. Choose the Start Time and End Time. Then, click **Search** to find the snapshot list. Check the time of the snapshot, and then select the snapshots you want to download, then click **Download**.

Where can I find saved files?

Videos and snapshots captured from Playback will be saved to your computer. See **Live View Settings** on page 31 for details.

Log

The log of the TV-IP341PI will be saved on the network storage. You can search the relevant records and save to your local computer.

Search for logs

Click the type of log and then the Start Time and End Time. Click **Search** to start searching.

Total 129 Items [First Page](#) [Prev Page 1/2](#) [Next Page](#) [Last Page](#)

Click **First Page**, **Prev Page**, **Next Page**, and **Last Page** to show the logs. Click **Save Log** to save the logs to your computer.

Where can I find saved files?

*Videos and snapshots captured from Playback will be saved to your computer. See **Live View Settings** on page 31 for details.*

System Information

System Information page shows the TV-IP341PI's basic information. Click System then click System Info to show the page.

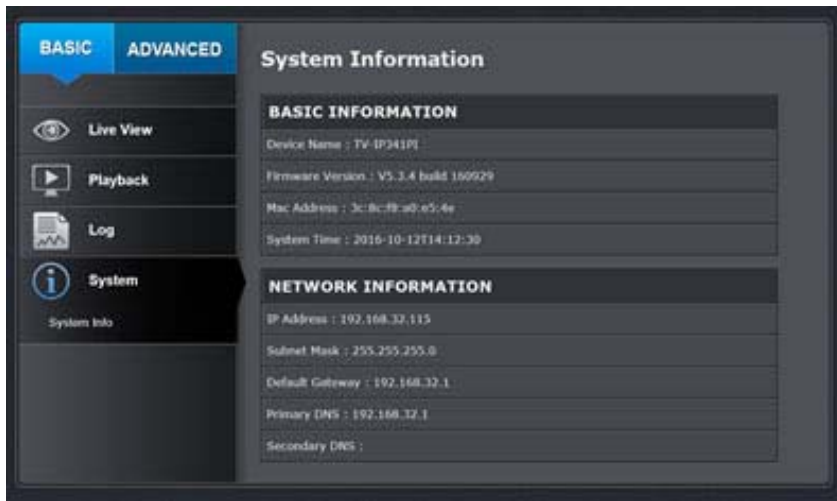

Basic Information

Device Name: Human readable device name for easy identification.

Firmware Version: Firmware version

MAC Address: The MAC address of Ethernet Interface

System Time: The system time setup in the camera. Keeping this time correct is important for recording, scheduled control and logging accurately.

Device Name: Human readable device name for easy identification.

Network Information

IP Address: IP address of the TV-IP341PI

Subnet Mask: Network range of IP address

Default Gateway: The default route going from the TV-IP341PI subnet.

Primary DNS: Primary DNS server address

Secondary DNS: Secondary DNS server address

System Configuration

Device Settings

Setup your camera name and location for easy identification. This camera name will also be recognized by other network camera software as the name of this camera. OSD, On Screen Display, camera name is referring to this setting as well.

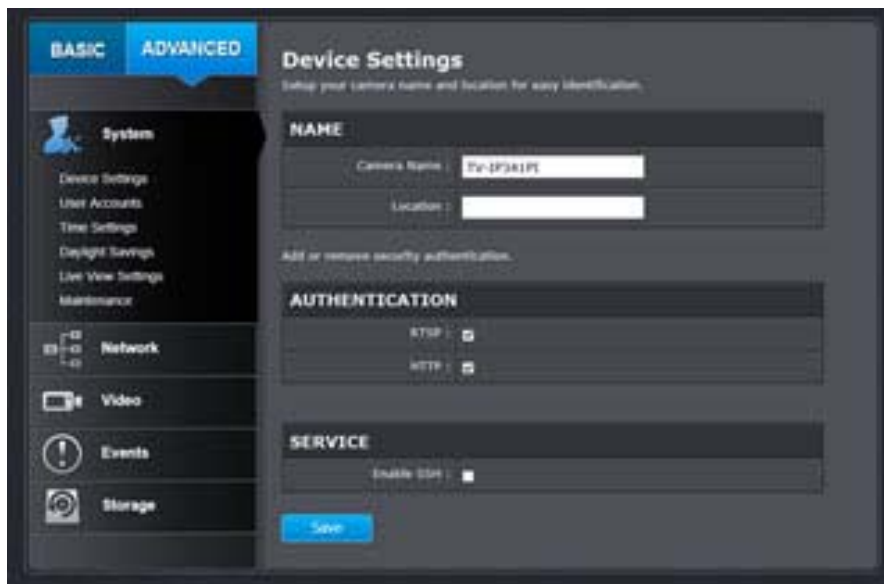

Names

Camera Name: Name of the camera. The camera name setup here can be discovered by other network camera software and OSD, On Screen Display. The default camera name is the model number: TV-IP341PI

Location: Label where you installed this camera for reference

Authentication

RTSP: TV-IP341PI's video stream can be accessed with RTSP, Real Time Streaming Protocol. Only the administrator and users can view this video stream. Un-checking this box will allow everyone access to this video stream without authentication. Default: Checked.

HTTP: TV-IP341PI can be accessed via password protected web management interface. Un-checking this box will allow anyone to access this camera and change its settings.

User Accounts

You can setup up to 16 user accounts to access the camera's video stream with a web browser or real time video stream (RTSP). Only one administrator account can be setup to configure the TV-IP341PI and cannot be deleted.

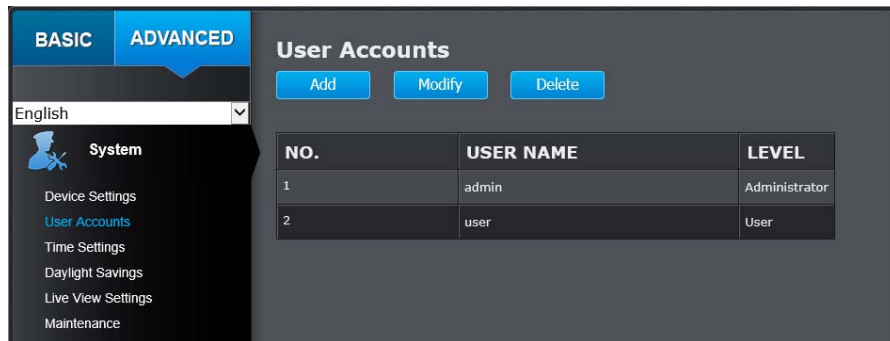

User Accounts

Add: Click **Add** button to add one user account

Modify: To change a user's name and password, highlight the user by clicking on it. Then, click **Modify** button. You can change the user's name and password. You can also change the administrator's password here. But, the administrator's name is fixed, you cannot change that.

Click **OK** to save the changes.

Time Settings

The accuracy of the system clock is important for scheduling and accurate logging. You can synchronize the system time with your computer, or automatically check the time accuracy with a network time server (NTP server).

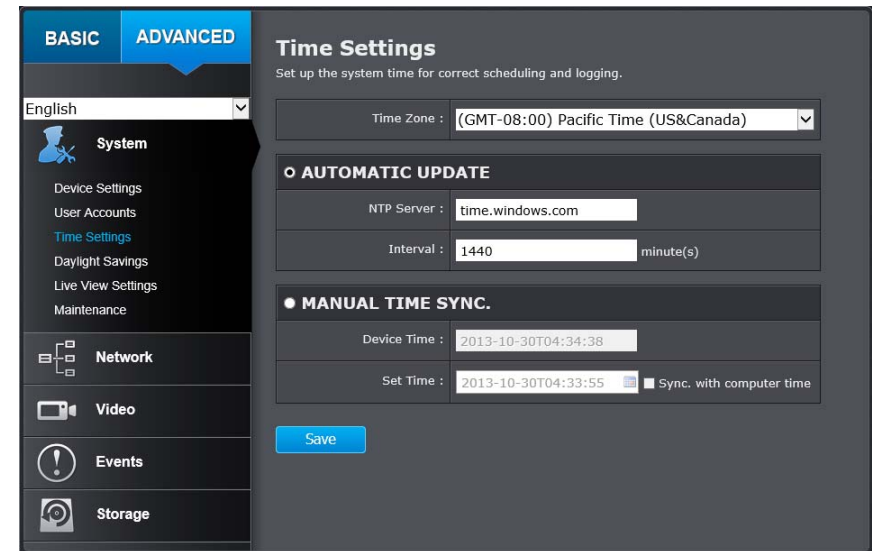

Automatic Update

- NTP Server:** Specify a time server (NTP server) to synchronize with. (e.g. pool.ntp.org)
- Interval:** The time interval that the TV-IP341PI will synchronize the time with NTP server. Default: 1440 minutes (24 hours)

Click **Save** to save the changes

Manual Time Sync

Device Time: The system time of this camera.

Set Time: Click the calendar icon and manually select the date. Check the **Sync. with computer time** to copy the time from your computer.

Click **Save** to save the changes

Daylight Savings

Setup daylight savings.

Automatic Update

Enable DST: Check this box if your time zone has daylight savings.

Start Time: Enter the date that daylight savings starts

End Time: Enter the date that daylight savings ends

DST Bias Enter how much time the daylight saving adjusted by daylight savings.

Click **Save** to save the changes

Live View Settings

Setup the live view video quality, file size and file saving directories.

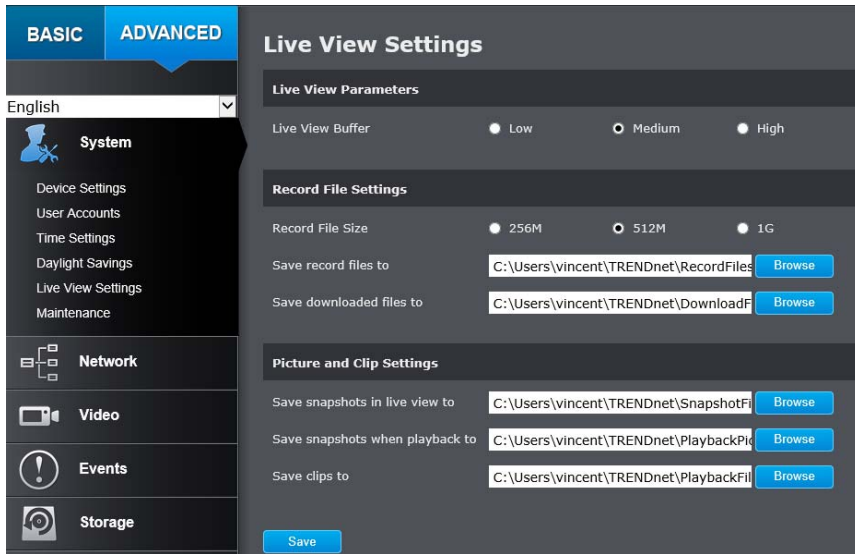

Live View Parameters

Live View Buffer: Configure the buffer size for live view video stream. With low buffer size setting, you can get real-time video stream, but the video may be stop and go if the network is congested. With high buffer setting, you can have smooth video streaming, but the video is delayed from the time happening. Medium size can have moderate video stream smoothness and time delay.

Record File Settings

Record file size: This size of live view video recording. You can choose 256MB, 512MB, or 1GB a file. Smaller file size is good for many short recordings.

Save record files to: By default, files will be saved under the folder with your user name, under the subdirectory TRENDnet/RecordFiles. Click **Browse** and then choose a new destination if you want to save the file somewhere else.

Save downloaded files to: By default, files will be saved under the folder with your user name, under the subdirectory TRENDnet/DownloadFiles. Click **Browse** and then choose a new destination if you want to save the file somewhere else.

Picture and Clip Settings

Save snapshots in live view to: By default, files will be saved under the folder with your user name, under the subdirectory TRENDnet/SnapshotFiles. Click **Browse** and then choose a new destination if you want to save the file somewhere else.

Save snapshots when playback to: By default, files will be saved under the folder with your user name, under the subdirectory TRENDnet/PlaybackPics. Click **Browse** and then choose a new destination if you want to save the file somewhere else.

Save clips to: By default, files will be saved under the folder with your user name, under the subdirectory TRENDnet/PlaybackFiles. Click **Browse** and then choose a new destination if you want to save the file somewhere else.

Click **Save** to save the changes

Maintenance

You can restart, load camera settings and upgrade the camera firmware on this page.

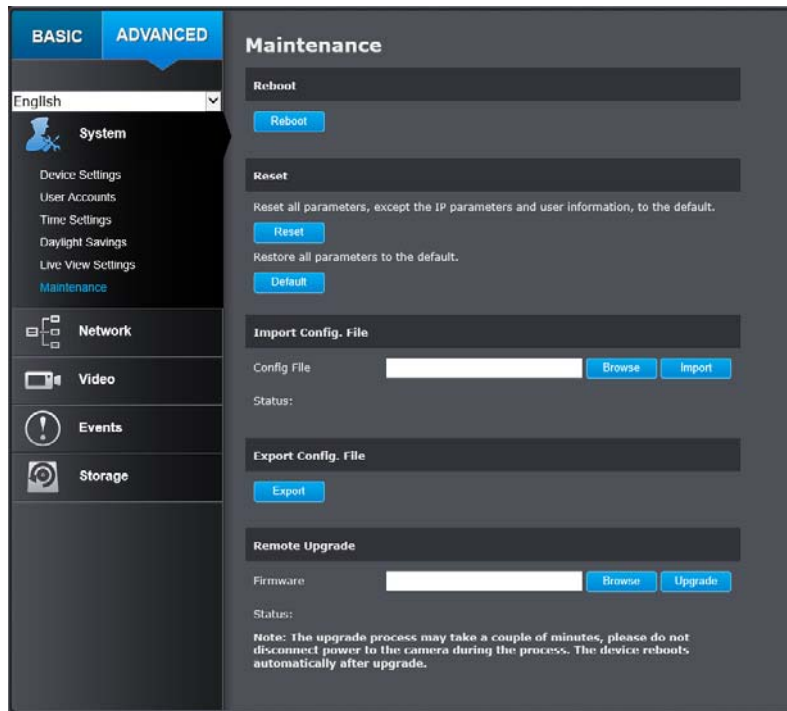

Reboot

Reboot: Click this button to reboot this camera.

Reset

Reset: Reset all camera parameters, except the IP parameters and user information.

Default: Load complete factory default to the camera.

Import Config. File

Config File: To load previously saved settings, click **Browse** to find the configuration file and then click **Import**.

Status: Shows the status in loading configuration file.

Export Config. File

Export: Click Export to download configuration file. The file will be downloaded to the Download folder by default.

Remote Upgrade

Firmware: Click Browse to find the latest firmware and then click Upgrade.

Status: Shows the status in firmware upgrade.

TRENDnet may periodically release firmware upgrades that might add features or fix problems associated with your TRENDnet model and version. To find out if there is a firmware upgrade available for your device, please check your TRENDnet model and version using the link.

<http://www.trendnet.com/downloads/>

1. If a firmware upgrade is available, download the firmware to your computer.
2. Unzip the file to a folder on your computer.
3. Read the firmware upgrade instruction for specific version update information.
4. Log into the TV-IP341PI.
5. Getting to this Maintenance page to upgrade firmware.

Network Settings

TCP/IP

Setup your basic IPv4 and IPv6 network settings on this page.

TCP/IP Network Settings
Setup your camera to get network address manually or dynamically.

NETWORK INTERFACE

Mac Address : 8c:e7:48:df:c1:05

Duplex and Speed : Auto

MTU : 1500

Primary DNS : 10.10.10.254

Secondary DNS :

IPV4

DHCP :

IPv4 Address : 10.10.10.1

Subnet Mask : 255.255.255.0

Default Gateway : 10.10.10.254

IPV6

IPv6 Mode : Route Advertisement [View Rout...](#)

IPv6 Address : fe80::8ee7:48ff:fedf:c105

Prefix Length : 64

Default Gateway :

[Save](#)

Network Interface

MAC Address: Click this button to reboot this camera.

Duplex and Speed: Choose one of the Ethernet duplex and speed to match your network. Default: auto.

MTU: Maximum transmission unit. The maximum field size in the Ethernet packet.

Primary DNS: Enter your first IPv4 or IPv6 DNS server address

Secondary DNS: Enter your second IPv4 or IPv6 DNS server address

IPv4

DHCP: Check this box if the IP address is assigned by DHCP server.

IPv4 Address: The IPv4 dynamic or static address

Subnet Mask: Network range of the subnet

Default Gateway: The default route going further from TV-IP341PI IPv4 subnet

IPv6

IPv6 Mode: Choose Manual, DHCP, or Route Advertisement. Click View Route Advertisement to find a route advertisement.

IPv6 Address: IPv6 address of TV-IP341PI

Prefix Length: Length of network prefix

Default Gateway: The default route going further from TV-IP341PI IPv6 subnet

Port

You can change the service port numbers of TV-IP341PI and enable/disable RTSP or HTTPS services.

Port Numbers

HTTP Port: The default web access port. You can change the port number. However, you cannot disable the web service. The default port number is 80.

RTSP Port: The Real-Time Streaming Protocol port for video streaming. You can change the port number or disable the service by uncheck the box. The default port number is 554.

HTTPS Port: The secured web service port. You can change the port number, or you can disable the service by uncheck the box. The default port number is 443.

Click **Save** to save the changes

DDNS

Dynamic Domain Name Service, DDNS, allows you to find your camera from the Internet with an easy to remember domain name.

DDNS

Enable DDNS: Check this box to enable DDNS Service.

DDNS Type: Select a DDNS service provider.

Server Address: Enter the DDNS server address.

Domain: Enter your registered domain/host name on selected DDNS service.

User Name: Enter the account name.

Password: Enter the password.

Confirm: Enter the password again.

Click **Save** to save the changes

PPPoE

Setup PPPoE (ADSL) connection to connect your camera with your ISP, Internet Service Provider.

PPPoE (ADSL)

Enable PPPoE: Check this box to enable PPPoE connection.

Dynamic IP: The IP address assigned by ISP

User Name: Enter the account name.

Password: Enter the password.

Confirm: Enter the password again.

Click **Save** to save the changes

SNMP

SNMP Settings allows you to assign the contact details, location, community name and trap settings of SNMP. This is a networking management protocol used to monitor network-attached devices. SNMP allows messages (called protocol data units) to be sent to various parts of a network. Upon receiving these messages, SNMP compatible devices (called agents) return data stored in their Management Information Bases.

SNMP V1/V2

Enable SNMPv1: Check this box to enable SNMP v1 management.

Enable SNMPv2c: Check this box to enable SNMP v2c management.

Read SNMP Community: Specify the password to access the SNMP community for read only access.

Write SNMP Community: Specify the password for access to the SNMP community with read/write access.

Trap Address: Specify the IP address for the SNMP trap community.

Trap Port: Specify the port number for the SNMP trap community.

Trap Community: Specify the name of SNMP trap community.

SNMP V3

Enable SNMPv3: Check this box to enable SNMP v3 management.

Read User Name: SNMP v3 member user name.

Security Level: Choose one of the security levels.

Authentication and Privacy
Authentication only
Privacy only

Authentication Algorithm: Choose the authentication method to verify the source of information: MD5 or SHA.

Authentication Password: Specify the authentication password between 8 to 32 letters.

Private-key Algorithm: Choose the privacy key to encrypt SNMP messages: DES or AES.

Private-key Password: Specify the privacy key between 8 to 32 letters.

Write User Name: SNMP v3 manager user name.

Security Level: Choose one of the security levels.

Authentication and Privacy
Authentication only
Privacy only

Authentication Algorithm: Choose the authentication method to verify the source of information: MD5 or SHA.

Authentication Password: Specify the authentication password between 8 to 32 letters.

Private-key Algorithm: Choose the privacy key to encrypt SNMP messages: DES or AES.

Private-key Password: Specify the privacy key between 8 to 32 letters.

SNMP Other Settings

SNMP Port: SNMP service port number.

Click **Save** to save the changes

802.1X

Setup 802.1X for remote authentication service.

802.1X Authentication

Enable IEEE 802.1X: Check this box to enable 802.1X authentication service.

EAPOL version: Extensible Authentication Protocol (EAP) over LAN (EAPoL). Choose version 1 or 2. This version number has to match to your 802.1X service EAPOL version.

User Name: Enter the account name.

Password: Enter the password.

Confirm: Enter the password again.

Click **Save** to save the changes

IP Address Filter

Set up a list of clients allow only the clients on the list to access this camera or to reject clients on the list from access this camera.

IP Address Filter

Enable IP Address Filter: Check this box to enable IP address filtering service.

IP Address Filter Type: Choose Forbidden to ban the listed IP addresses or Allowed to allow listed host to access this camera.

Add: Click Add to add a user account

Modify: To modify an entry on the list, highlight the entry by clicking on it. Then, click the Modify button.

Enter the IP address then click OK

Delete: To delete an entry on the list, highlight the entry by clicking on it. Then, click Delete

Clear: To clear all entries, click Clear

Click **Save** to save the changes

Quality of Service (QoS)

Setup traffic prioritization tags the video packets to go through network switches and routers with assigned priority. You can set the Differentiated Services Code Point (DSCP) bits on outgoing data streams. The QoS capable network device will forward different data in different priorities. The meaning of the value is different in different DiffServ domains. Consult your network manager for the setup details.

IP Address Filter

Video/Audio DSCP: Enter Video/Audio DSCP. Default: 0.

Event/Alarm DSCP: Enter Event/Alarm DSCP. Default: 0.

Management DSCP: Enter Management DSCP. Default: 0.

Click **Save** to save the changes

UPnP

Universal Plug-and-Play is a device discovery protocol set. It allows your camera to easily be found, for example, on a Windows operation system.

UPnP

Enable UPnP: Check this box to enable UPnP connection.

Friendly Name: The name that will be appeared when searched.

Port Mapping

Enable Port Mapping: Check this box to enable UPnP connection.

Port Mapping Mode: Choose **Manual** or **Auto** port mapping.

External Port: Choose the port number for mapping.

Click **Save** to save the changes

Video Settings

Video Format

Adjust the format of video.

Video Format	
Stream Type :	Main Stream(Normal)
Video Encoding :	H.264
Resolution :	1920*1080P
Bitrate Type :	Variable
Video Type :	Video Stream
Video Quality :	Medium
Frame Rate :	25 frames per second
Max. Bitrate :	4096 Kbps
I Frame Interval :	60
Stream Type :	Sub Stream
Video Encoding :	MJPEG
Resolution :	352*288
Bitrate Type :	Variable
Video Type :	Video Stream
Video Quality :	Medium
Frame Rate :	25 frames per second
Max. Bitrate :	512 Kbps
I Frame Interval :	60
<input type="button" value="Save"/>	

Video Encoding:

H.264
MJPEG

Choose the video stream you want to modify. H.264 and MJPEG videos are always streaming and can be configured separately.

Resolution:

H.264

1280*720P
1280*960
1920*1080P

MJPEG

320*240
352*240
640*480
704*480

Bitrate Type:

Choose between variable bit rate or constant bit rate for video compression. The default is variable rate.

Video Quality:

Choose the video quality. The default is medium quality.

Frame Rate:

Choose the capturing frame rate. The default value is 30 frames per second. Reduce the frame rate to reduce the capture file size.

Max. Bitrate:

Choose the maximum video sampling bit rate. Default: 2048

I Frame Interval

An I Frame is a frame that records a complete picture. Frames between I frames, (P frame or B frame) only records the image differences between two frames. Choose the I Frame Interval here. The default is 60.

Click **Save** to save the changes

Display Settings

Adjust video image quality, lightness, and color settings here.

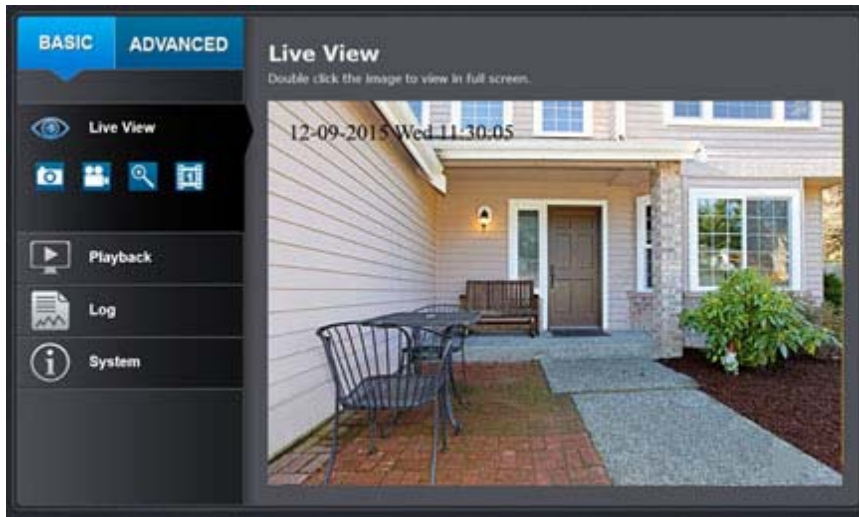

Brightness: Use the slider or enter a number (0-100) to adjust the image brightness. Default: 50

Contrast: Use the slider or enter a number (0-100) to adjust the image contrast. Default: 50

Saturation: Use the slider or enter a number (0-100) to adjust the color saturation. The greater number means the color will be more saturated. Default: 50

Sharpness: Use the slider or enter a number (0-100) to adjust the image sharpness. Default: 50

Brightness :	<input type="range" value="50"/>	50
Contrast :	<input type="range" value="50"/>	50
Saturation :	<input type="range" value="50"/>	50
Sharpness :	<input type="range" value="50"/>	50
Smart IR :	Enable	▼
Exposure Time :	1/30	▼
Video Standard :	60hz	▼
Day/Night Switch :	Auto	▼
Sensitivity :	Normal	▼
Switch Time :	<input type="range" value="5"/>	5
Mirror :	Default	▼
D-WDR :	Enabled	▼
D-WDR Level :	<input type="range" value="20"/>	20
White Balance :	Automatic	▼
Digital Noise Reduction :	Normal Mode	▼
Noise Reduction Level :	<input type="range" value="100"/>	100
<input type="button" value="Reset"/>		

Light sensitivities

Smart IR: Smart IR can adjust the strength of infrared lights at night depending on the distance of an object to maintain the maximum IR light distance and while maintaining a clear picture when object is close by. Default: On.

Max. Exposure Time: Adjust this value for exposure time for each picture. You can choose a value between 1/3 second to 1/100,000 second. The default value is 1/25 second exposure time for each picture.

- 1/3
- 1/6
- 1/12
- 1/30
- 1/60
- 1/120
- 1/250
- 1/500
- 1/750
- 1/1000
- 1/2000
- 1/4000
- 1/10000
- 1/100000

Video Standard: This is the base frequency for the video refresh rate. It is recommended to set to the same frequency of your local video standard (NTSC: 60, PAL: 50). Default: 60Hz.

Day/Night Switch: Choose whether you want the camera to be set to the day mode (color video) or night mode (IR enhanced black/white video). You can manually set it to day mode or night mode, adjust by lighting (Auto), or pre-define schedule.

- Day
- Night
- Auto
- Schedule

Auto:

Sensitivity: The light sensor sensitivity.

Switch Time: The time delayed to switch between modes. Longer switch time can prevent unnecessary mode flipping if an object is blocking the light source temporarily. Range: 5-120 seconds, default: 5 seconds.

Schedule:

Use quick selection or enter the time down below. Click **OK** to confirm the time you want to set.

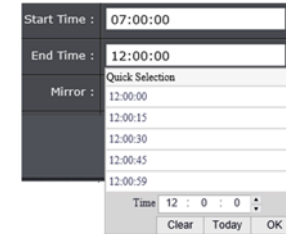

Start Time: The start time for day mode.

Stop Time: The start time for day mode.

Position adjustments

Mirror: Horizontal
Vertical
Horizontal/Vertical
Default

Choose horizontal, vertical or both to adapt to the physical position of installation.

Image adjustments

Back Light Compensation and Digital Wide-Dynamic-Range: **Back light compensation:** Setup a fixed light source position to compensate and adjust the image in the dark. Choose the area that you want to enhance (dark area, not light source).

Note: By default, the D-WDR is enabled. Please disable D-WDR to set up back light compensation.

D-WDR :	Disabled
Backlight Control :	Close

D-WDR: Digital Wide Dynamic Range compensates for the dark area dynamically.

- **D-WDR Level:** The level of compensation. Range: 0-100%, default: 20%.

White Balance: Choose a color temperature as the white color and compensate the color on the whole image.

Automatic
Locked
Incandescent Lamp(3000K)
Warm Light Lamp(4000K)
Natural Light(5500K)
Fluorescent Lamp(6500K)

Digital Noise Reduction: Choose the mode of noise reduction.

Normal Mode

Noise Reduction Level: Adjust the effect of digital noise reduction. Range: 0-100%, default : 100%

Expert Mode

Space DNR Level: Adjust the special digital noise reduction with adjacent pixels. Change the range (0-100%) to change the adjacency effect, default : 50%

Time DNR Level: Adjust the 3D digital noise reduction. Compare and reduce noise between video frames. Range: 0-100%, default : 100%

Click **Reset** to reset the display adjustments

On Screen Display Settings

Display the camera name and the time the video is shooting on the screen

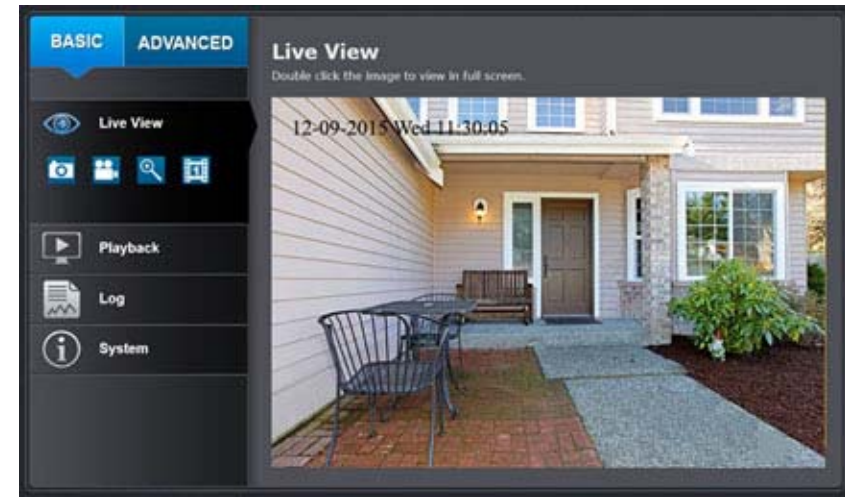

Display Name: Check this box to display the product name that was setup in the device settings (refer to page 28 **Device Settings** to change the device name.)

Display Date: Check this box to display system time.

Display Week: Check this box to display time of the week.

Time Format: Select 12 or 24-hour time format.

Date Format: Select the date format

Display Mode: Choose how the text will show on the screen.

OSD Size: Select the text size from 16 to 64 or adjusted by screen size automatically.

Move the red box to position the text. Click **Save** to save the changes.

Text Overlay

Display extra information on the screen over the image.

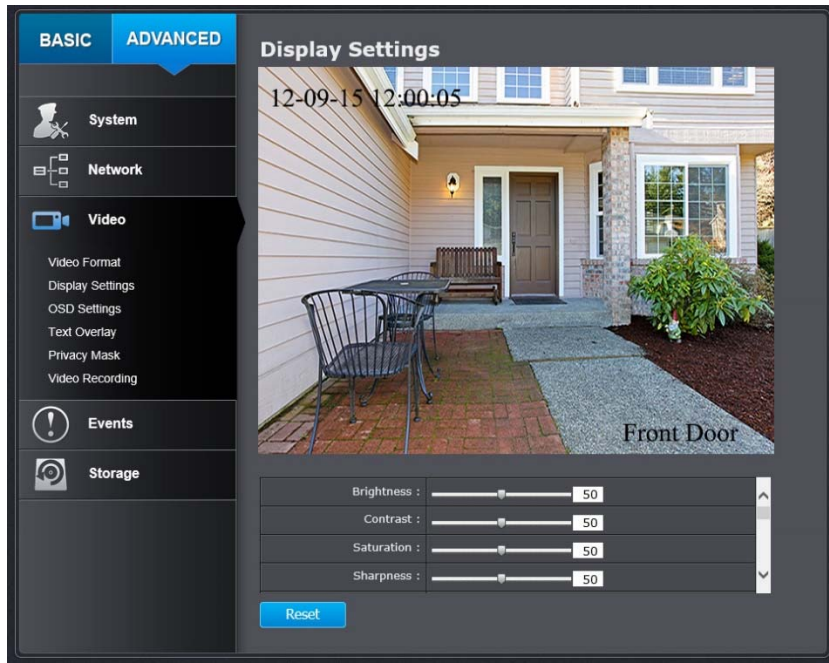

Check Box: Check this box to enable text overlay.

Text Field: Enter the text you want to display. You can enter your local language if you want. The text field allows maximum 44 English letters or 20 non-English characters.

Move the red box to position the text.

*Click **Save** to save the changes*

Privacy Mask

Create a masking area to keep your privacy. You can create up to four independent masking areas by clicking and dragging on the screen.

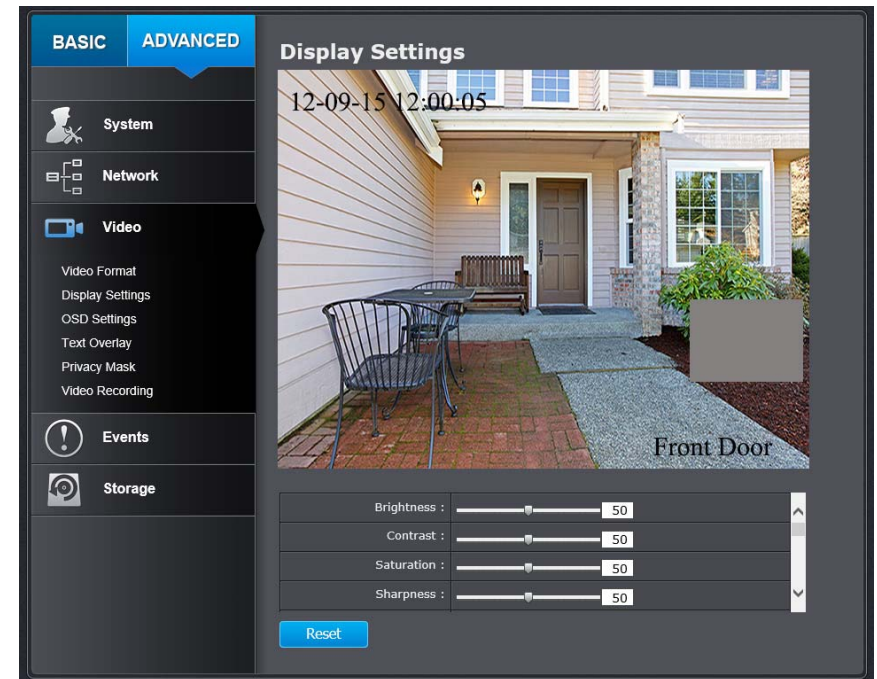

Enable Privacy Mask: Check this box to enable privacy masking.

Stop Drawing: Click this button to stop drawing.

Clear All: Click this button to clear all the masking areas.

*Click **Save** to save the changes*

Video Recording

Pre-record: Recording time before trigger event.

Post-record: Recording time after trigger event.

Overwrite: Select Yes to allow older recordings to be overwritten.

Enable Record Schedule: Check this box and then click Save to enable video recording.

Click **Save** to save the changes

Edit: Click **Edit** to edit the recording schedule. The Edit Schedule window will pop up.

1. Select day of the week you want to edit.
2. Select **All Day** or **Customized** schedule of the day.
3. Set the time period and the event you want to trigger the video recording **continuous** (always recording) or **motion detection**.
4. Click **Select All** or the weekday you want to have the same schedule on different day.
5. Click another day of the week by clicking on its tab to set the next schedule. Click **OK** when you have finished your settings.

Events

Motion Detection

Set up how the motion detection event will be triggered and what actions will be triggered.

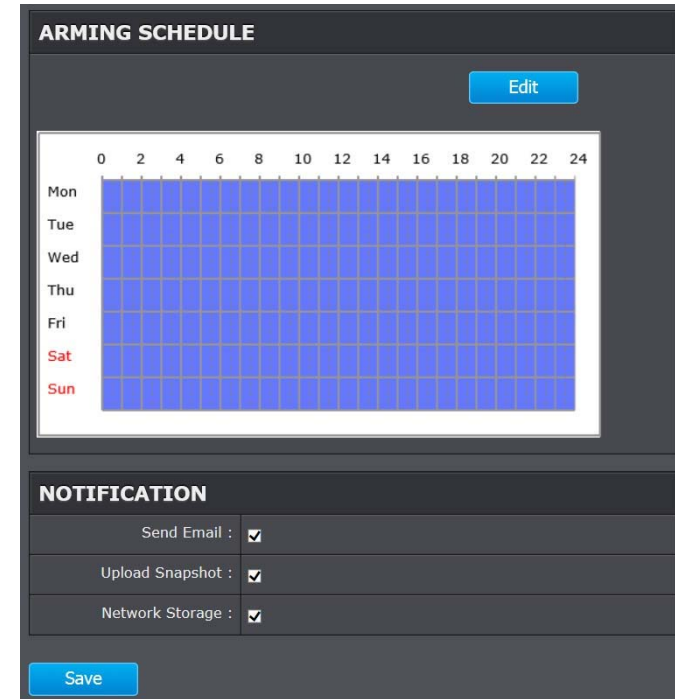
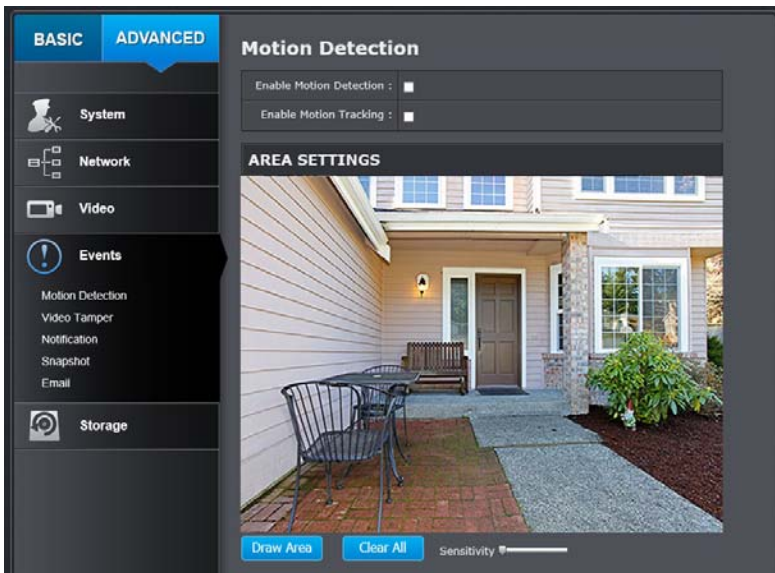

Enable Motion Detection: Check this box to enable motion detection. Click **Save** to save the choice.

Enable Motion Tracking: Check this box to enable motion tracking. Motion tracking is a dynamic display that shows the current status of motion detection. The motion tracking is displayed with grids in green. The grid area represents the camera motion is happening. Click **Save** to save the choices.

Draw Area: Click **Draw Area** button to start drawing. Click and drag on the area you want to set up the motion detection. You can draw up to 8 different areas. Click **Stop Drawing** to stop drawing motion detection areas.
The red grids represent the motion detection area.

Sensitivity: Move the slider to adjust detection sensitivity.

Clear All: Click this button to clear all the set up areas.

Arming Schedule

Edit: Click **Edit** to edit the recording schedule. The Edit Schedule window will pop up.

Period	Start Time	End Time	Record Type
1	00: 00	00: 00	Continuous
2	00: 00	00: 00	Continuous
3	00: 00	00: 00	Continuous
4	00: 00	00: 00	Continuous
5	00: 00	00: 00	Continuous
6	00: 00	00: 00	Continuous
7	00: 00	00: 00	Continuous
8	00: 00	00: 00	Continuous

1. Select day of the week you want to edit.
2. Select **All Day** or **Customized** schedule of the day.

3. Set the time period and the event you want to trigger the video recording **continuous** (always recording) or **motion detection**.
4. Click **Select All** or the weekday you want to have the same schedule on different day.
5. Click another day of the week by clicking on its tab to set the next schedule. Click **OK** when you have finished your settings.

Notification

Send Email: Check this box to send an e-mail notification when motion is detected.

Network Storage: Check this box to record video to network storage when motion is detected.

Upload to FTP: Check this box to send snapshots to an FTP server when motion is detected.

Click **Save** to save the changes

Video Tampering

This is to detect if the camera has been tampered with and surveillance is compromised. You can set up tamper proof notifications to alert the system manager to check the camera.

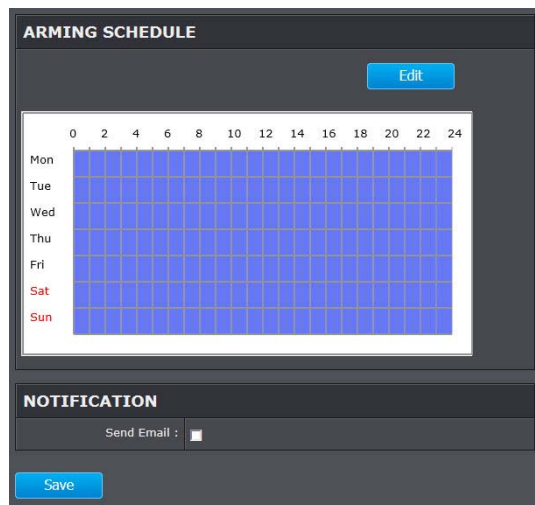
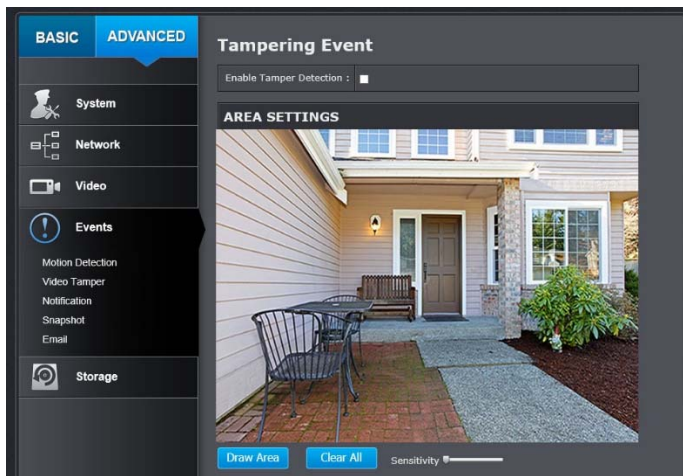

Enable Tamper Detection: Check this box to enable tamper detection. Click **Save** to save the settings.

Draw Area: Click **Draw Area** button to start drawing. Click and drag on the area you want to set up the tamper detection. You can setup only one area for tamper detection. Click **Stop Drawing** to stop drawing motion detection areas. The gray block represents the detection area.

Sensitivity: Move the slider to adjust detection sensitivity.

Clear All: Click this button to clear all the set up areas.

Arming Schedule

Edit: Click **Edit** to edit the recording schedule. The Edit Schedule window will pop up.

Period	Start Time	End Time	Record Type
1	00:00	00:00	Continuous
2	00:00	00:00	Continuous
3	00:00	00:00	Continuous
4	00:00	00:00	Continuous
5	00:00	00:00	Continuous
6	00:00	00:00	Continuous
7	00:00	00:00	Continuous
8	00:00	00:00	Continuous

1. Select day of the week you want to edit.
2. Select **All Day** or **Customized** schedule of the day.
3. Set the time period and the event you want to trigger the video recording **continuous** (always recording) or **motion detection**.

4. Click **Select All** or the weekday you want to have the same schedule on different day.
5. Click another day of the week by clicking on its tab to set the next schedule. Click **OK** when you have finished your settings.

Notification

Send Email: Check this box to send an e-mail notification when motion is detected.

Click **Save** to save the changes

Notification

Provide notifications for other system events, set up your notifications here.

The screenshot shows the 'System Notification' configuration page. On the left, there is a sidebar with tabs for 'BASIC' and 'ADVANCED'. Under 'ADVANCED', there are sections for 'System', 'Network', 'Video', 'Events', and 'Storage'. The 'Events' section is selected, showing a list of events: 'Motion Detection', 'Video Tamper', 'Notification', 'Snapshot', and 'Email'. The 'Notification' event is selected. The main area shows 'Notification Type' set to 'Storage Full'. Below this, there is an 'ACTION' section with a 'Send Email' checkbox that is currently unchecked. A 'Save' button is located at the bottom of the main area.

Notification

Notification Type: First, choose the exception type, and then choose the corresponding action.

Send Email: Check this box to send an e-mail notification when motion is detected.

Click **Save** to save the changes

Snapshot

You can set up your camera to continuously taking snapshots or taking snapshots only when events happening.

The screenshot shows the 'Snapshot' configuration page. On the left, there is a sidebar with tabs for 'BASIC' and 'ADVANCED'. Under 'ADVANCED', there are sections for 'System', 'Network', 'Video', 'Events', and 'Storage'. The 'Events' section is selected, showing a list of events: 'Motion Detection', 'Video Tamper', 'Exception', 'Snapshot', and 'Email'. The 'Snapshot' event is selected. The main area shows 'CONTENTIOUS' and 'EVENT-TRIGGERED' sections. Both sections have an 'Enable' checkbox that is currently unchecked. Below each section, there are dropdown menus for 'Format' (set to 'JPEG'), 'Resolution' (set to '1280*720'), and 'Quality' (set to 'High'). There is also an 'Interval' field with a value of '0' and a unit dropdown set to 'millisecond'. At the bottom of the 'EVENT-TRIGGERED' section, there is a 'Capture Number' field with a value of '5'. A 'Save' button is located at the bottom of the main area.

Continuous

Enable: Check this box to take snapshots continuously.

Format: Save snapshots in JPEG format

Resolution: Uses the same resolution set in Video Format for the snapshot resolution.

Quality: Choose a compression quality for snapshots.

Interval: State the time interval between snapshots. The default interval is 10 seconds.

Event triggered

Enable: Check this box to take snapshots when an event is occurred.

Format: Save snapshots in JPEG format

Resolution: Uses the same resolution set in Video Format for the snapshot resolution.

Quality: Choose a compression quality for snapshot.

Interval: State the time interval between this series of snapshots. The default interval is 1 second.

Capture Number: State how many snapshots you want to take in a single triggered event. Default: 3 pictures.

Click **Save** to save the changes

Email

Set up email accounts for notifications.

Sender

Sender: Enter the name to be appeared as the email sender.

Sender's Address: Enter sender's email address.

SMTP Server: Simple Mail Transportation Protocol Server address, the outgoing email server address. It may be has

address as your incoming email server, maybe not. Please ask your email service provider for detail.

SMTP Port: Service port number for outgoing email.*

Enable SSL: Check this box if your service provider requires a SSL secured connection.

Attach Image/Interval: Check Attach Image if you want to send a snapshot image with the email notification and select the interval of snapshots in seconds.

Authentication: Check this box if your server requires a password in order to send email. Most email servers require authentication when sending an email.

User name: Enter the user name of outgoing email account

Password: Enter the password

Confirm: Enter the password again to confirm that the password was entered correctly.

Click **Save** to save the changes

Receiver

Receiver 1: The first receiver's name.

Receiver 1's Address: The first receiver's email address.

Receiver 2: The second receiver's name.

Receiver 2's Address: The second receiver's email address.

Receiver 3: The third receiver's name.

Receiver 3's Address: The third receiver's email address.

Click **Save** to save the changes

*Note: Many ISPs does not allow service port 25 going through their network. Other popular ports are 587 and 465. Please consult your email service provider and ISP for detail.

Alarm Input

Set up alarm input value.

Alarm Input

Alarm Input No.:	A<-1	▼
Alarm Name:	(cannot copy)	
Alarm Type:	NO	▼

ARMING SCHEDULE

[Edit](#)

	0	2	4	6	8	10	12	14	16	18	20	22	24
Mon													
Tue													
Wed													
Thu													
Fri													
Sat													
Sun													

NORMAL LINKAGE

Send Email :	<input type="checkbox"/>
Upload to FTP :	<input type="checkbox"/>
Network Storage :	<input type="checkbox"/>
Audible Warning :	<input type="checkbox"/>
Notify Surveillance Center :	<input type="checkbox"/>

TRIGGER ALARM OUTPUT

Select All	<input type="checkbox"/>	A->1	<input type="checkbox"/>	A->2	<input type="checkbox"/>
------------	--------------------------	------	--------------------------	------	--------------------------

COPY TO ALARM

Select All	<input type="checkbox"/>	A<-1	<input checked="" type="checkbox"/>	A<-2	<input type="checkbox"/>
------------	--------------------------	------	-------------------------------------	------	--------------------------

[Save](#)

You can enter the alarm input settings on this page.

1. Choose the alarm input number and the alarm type, the alarm type can be NO (Normally Open) and NC (Normally Closed). Edit the name to set a name for the alarm input (optional)
2. Click the **Arming Schedule** to set the arming schedule for the alarm input.
3. Select the **Linkage** method for the alarm input.
4. You can copy your settings to other alarm inputs.
5. Click **Save** to save the settings.

Alarm Output

Set up alarm output value.

The screenshot shows the 'Alarm Output' configuration page. It includes a form with the following fields:

- Alarm Output: A dropdown menu showing 'A->1'.
- Alarm Name: A text input field with '(cannot copy)' next to it.
- Delay: A dropdown menu showing '5s'.

Below the form is the 'ARMING SCHEDULE' section, which features an 'Edit' button and a calendar grid. The calendar grid has columns for hours (0, 2, 4, 6, 8, 10, 12, 14, 16, 18, 20, 22, 24) and rows for days of the week (Mon, Tue, Wed, Thu, Fri, Sat, Sun). The 'Sat' and 'Sun' rows are highlighted in red.

At the bottom is the 'COPY TO ALARM' section, which includes a 'Select All' checkbox and two checkboxes for 'A->1' and 'A->2'. A 'Save' button is located at the bottom of the page.

You can enter the alarm output settings on this page.

1. Select one alarm output channel in the **Alarm Output** section, you can also set a name for the alarm output (optional).
2. The **Delay time** can be set to different durations or manual.
3. Click **Arming Schedule** to set the schedule.
4. You can copy the settings to other alarm outputs.
5. Click **Save** to save the settings.

Network Storage

Network Storage

Network Storage must be setup before it can be managed. For storage management, please refer to the next section.

The TV-IP341PI supports two formats of network storage file systems: NFS and CIFS. NFS, Network File System, is natively supported by Linux computers and most NAS, Network Attached Storage. CIFS, Common Internet File System, is natively supported by Windows® systems and now is generally supported by Linux. (OS X® file sharing is not standard SMB and not compatible as a network storage disk here.)

You can add up to 8 network storages for your camera. The recordings will subsequently be stored in these spaces. Save video from the first storage and then the next when the first one is full. Click on the entry to change the settings and click Save to save the settings.

The screenshot shows the 'Network Storage' configuration page. On the left is a navigation menu with 'Storage' selected. The main area has a table with 8 rows. The first row is populated with the following data:

No.	Type	Server Address	File Path	Capacity (GB)
1	NAS	10.10.10.3	/smb	10
2	NAS			
3	NAS			
4	NAS			
5	NAS			
6	NAS			
7	NAS			
8	NAS			

Below the table, there are input fields for 'User Name' (containing 'User') and 'Password' (containing '****'). A 'Save' button is located at the bottom of the configuration area.

No:	The sequential number of the network storage.
Type:	The type of storage.
Server Address:	Enter the IP address of your network storage.
File Path:	Enter the shared folder as file path for network storage. You can create a folder under the shared folder and make it a network volume here. Just create the folder and enter the correct path name here.
Capacity:	Enter the size of the disk space you want to assign for this storage. The minimum disk space requirement is 8GB. If you do not want to limit the size and use the full physical disk space, put number 0 in this field.
File System:	Choose between NFS or CIFS for file system. If you assign the network storage on a Windows® computer, set it to CIFS.
User Name:	Enter the user name if the network storage requires user name and password. Enter any non-blank letters if no authentication is required.
Password:	Enter the password to access the network storage. Enter any non-blank letters if no authentication is required.

Click **Save** to save the changes. The camera may reboot to make the network storage available. Go to the next section to format and manage your network storage.

Tip: To create a network storage on your Windows® based system, create a shared folder and then test your set up with another computer. Enter the IP address of the computer here and enter the shared folder name with a leading forward slash. For example, if you have a shared folder named "SMB", enter "/SMB" in the **File Path**.

Storage Management

Network Storage must be setup before it can be managed. To setup storage, please refer to the previous section.

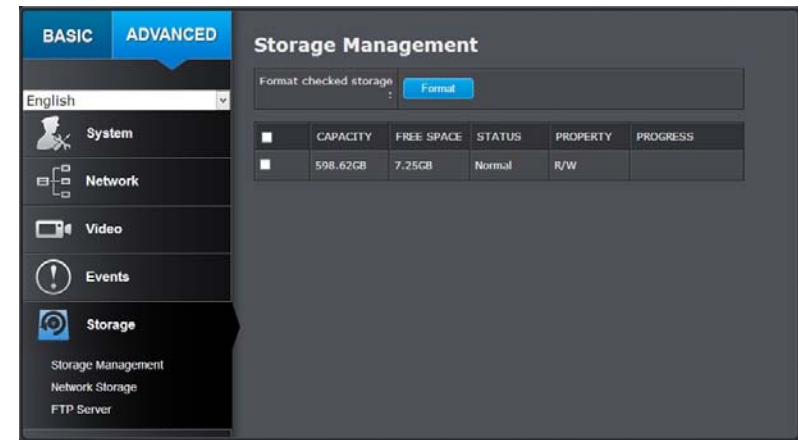

Format: Select a network storage volume and then click **Format** to format your network storage. This action will format the network volume (shared folder) for video recording. Placeholder files (formatting files) will be created to make sure disk allocation is appropriate and the file searching is optimized.

The volume format is a proprietary user space storage format. Meaning that you visit the shared folder and see some structured files. Please do not modify these files manually. Modifying these files may cause recording and playback problems. Access your recording and system log via the web management user interface to download the recording and snapshots.

Capacity: The total capacity this network storage can use.

Free Space: The free space left for video recording, snapshot and log.

Status: The connection status to the network storage.

Property: This network storage is read only or can be read and write.

Progress: The progress of ongoing task.

Note: The formatting progress depends on the size of the storage and the network bandwidth. It takes a while if you are formatting a big volume or the network connection is not stable.

FTP Server

Enable Snapshot to FTP: Check this box if you want to store snapshots on the FTP.

Server Address: Enter the FTP server IP address.

Port: Enter the service port number of the FTP server.

User Name/Anonymous: Check Anonymous if the FTP server does not require authentication. Enter the User Name if the FTP server requires authentication.

Password: Enter the password of the FTP account.

Confirm: Enter the password again to make sure the password was entered correctly.

Directory Structure: When saving snapshots on an FTP server, they can be saved in a single place or organized with meaningful directory names.

- Save in root directory: You can choose to store all files in the same folder of FTP login.
- Save in directory: Structure your folders with camera name or IP address.

Directory:

- Use Camera Name: Use the camera name to organize the saved files.
- Use Camera IP: Use the camera IP address to organize the saved files.

Click **Save** to save the changes

Regulations

Federal Communication Commission Interference Statement

This equipment has been tested and found to comply with the limits for a Class B digital device, pursuant to Part 15 of the FCC Rules. These limits are designed to provide reasonable protection against harmful interference in a residential installation. This equipment generates uses and can radiate radio frequency energy and, if not installed and used in accordance with the instructions, may cause harmful interference to radio communications. However, there is no guarantee that interference will not occur in a particular installation. If this equipment does cause harmful interference to radio or television reception, which can be determined by turning the equipment off and on, the user is encouraged to try to correct the interference by one of the following measures:

- Reorient or relocate the receiving antenna.
- Increase the separation between the equipment and receiver.
- Connect the equipment into an outlet on a circuit different from that to which the receiver is connected.
- Consult the dealer or an experienced radio/TV technician for help.

FCC Caution: Any changes or modifications not expressly approved by the party responsible for compliance could void the user's authority to operate this equipment.

This device complies with Part 15 of the FCC Rules. Operation is subject to the following two conditions: (1) This device may not cause harmful interference, and (2) this device must accept any interference received, including interference that may cause undesired operation.



IMPORTANT NOTE:

FCC Radiation Exposure Statement:

This equipment complies with FCC radiation exposure limits set forth for an uncontrolled environment. This equipment should be installed and operated with minimum distance 20cm between the radiator & your body.

This transmitter must not be co-located or operating in conjunction with any other antenna or transmitter.

The availability of some specific channels and/or operational frequency bands are country dependent and are firmware programmed at the factory to match the intended destination. The firmware setting is not accessible by the end user.

RoHS

This product is RoHS compliant.



Europe – EU Declaration of Conformity

This device complies with the essential requirements of the Directive 2004/108/EC and 2006/95/EC. The following test methods have been applied in order to prove presumption of conformity with the essential requirements of the Directive 2004/108/EC and 2006/95/EC:

Safety: EN60950-1:2006+A11:2009+A1:2010+A12:2011+A2:2013

EMC: EN 55022:2010 CLASS B

EN50130-4:2011

EN 61000-3-2:2014

EN 61000-3-3:2013

Directive: EMC Directive 2004/108/EC, RoHS Directive 2011/65/EU

WEEE Directive 2012/19/EU, REACH Regulation No.1907/2006



Česky [Czech]	TRENDnet tímto prohlašuje, že tento TV-IP341PI je ve shodě se základními požadavky a dalšími příslušnými ustanoveními směrnice 2004/108/ES a 2006/95/ES.
Dansk [Danish]	Undertegnede TRENDnet erklærer herved, at følgende udstyr TV-IP341PI overholder de væsentlige krav og øvrige relevante krav i direktiv 2004/108/EF og 2006/95/EF.
Deutsch [German]	Hiermit erkläre TRENDnet, dass sich das Gerät TV-IP341PI in Übereinstimmung mit den grundlegenden Anforderungen und den übrigen einschlägigen Bestimmungen der Richtlinie 2004/108/EG und 2006/95/EG befindet.
Eesti [Estonian]	Käesolevaga kinnitab TRENDnet seadme TV-IP341PI vastavust direktiivi 2004/108/EÜ ja 2006/95/EÜ põhinõuetele ja nimetatud direktiivist tulenevatele teistele asjakohastele sätetele.
English	Hereby, TRENDnet, declares that this TV-IP341PI is in compliance with the essential requirements and other relevant provisions of Directive 2004/108/EC and 2006/95/EC.
Español [Spanish]	Por medio de la presente TRENDnet declara que el TV-IP341PI cumple con los requisitos esenciales y cualesquiera otras disposiciones aplicables o exigibles de la Directiva 2004/108/CE y 2006/95/CE.
Ελληνική [Greek]	ΜΕ ΤΗΝ ΠΑΡΟΥΣΑΤRENDnet ΔΗΛΩΝΕΙ ΟΤΙ ΤV-IP341PI ΣΥΜΜΟΡΦΩΝΕΤΑΙ ΠΡΟΣ ΤΙΣ ΟΥΣΙΩΔΕΙΣ ΑΠΑΙΤΗΣΕΙΣ ΚΑΙ ΤΙΣ

	ΛΟΙΠΕΣ ΣΧΕΤΙΚΕΣ ΔΙΑΤΑΞΕΙΣ ΤΗΣ ΟΔΗΓΙΑΣ 2004/108/ΕΚ, 2006/95/ΕΚ κλπ.
Français [French]	Par la présente TRENDnet déclare que l'appareil TV-IP341PI est conforme aux exigences essentielles et aux autres dispositions pertinentes de la directive 2004/108/CE, 2006/95/CE et.
Italiano [Italian]	Con la presente TRENDnet dichiara che questo TV-IP341PI è conforme ai requisiti essenziali ed alle altre disposizioni pertinenti stabilite dalla direttiva 2004/108/CE e 2006/95/CE.
Latviski [Latvian]	Ar šo TRENDnet deklarē, ka TV-IP341PI atbilst Direktīvas 2004/108/EK un 2006/95/EK būtiskajām prasībām un cietimār to saistītajiem noteikumiem.
Lietuvių [Lithuanian]	Šiuo TRENDnet deklaruoją, kad šis TV-IP341PI atitinka esminius reikalavimus ir kitas 2004/108/EB ir 2006/95/EB Direktyvos nuostatas.
Nederlands [Dutch]	Hierbij verklaart TRENDnet dat het toestel TV-IP341PI in overeenstemming is met de essentiële eisen en de andere relevante bepalingen van richtlijn 2004/108/EG en 2006/95/EG.
Malti [Maltese]	Hawn hekk, TRENDnet, jiddikjara li dan TV-IP341PI jikkonforma mal-htigijiet essenzjali u ma provvedimenti oħrajn rilevanti li hemm fid-Direttiva 2004/108/KE u 2006/95/KE.
Magyar [Hungarian]	Alulírott, TRENDnet nyilatkozom, hogy a TV-IP341PI megfelel a vonatkozó alapvető követelményeknek és az 2004/108/EK és a 2006/95/EK irányelv egyéb előírásainak.
Polski [Polish]	Niniejszym TRENDnet oświadcza, że TV-IP341PI jest zgodny z zasadniczymi wymogami oraz pozostałymi stosownymi postanowieniami Dyrektywy 2004/108/WE i 2006/95/.
Português [Portuguese]	TRENDnet declara que este TV-IP341PI está conforme com os requisitos essenciais e outras disposições da Directiva 2004/108/CE e 2006/95/CE.
Slovensko [Slovenian]	TRENDnet izjavlja, da je ta TV-IP341PI v skladu z bistvenimi zahtevami in ostalimi relevantnimi določili direktive 2004/108/ES in 2006/95/ES.
Slovensky [Slovak]	TRENDnet týmto vyhlasuje, že TV-IP341PI spĺňa základné požiadavky a všetky príslušné ustanovenia Smernice 2004/108/ES a 2006/95/ES.
Suomi [Finnish]	TRENDnet vakuuttaa täten että TV-IP341PI tyyppinen laite on direktiivin 2004/108/EY ja 2006/95/EY oleellisten vaatimusten ja sitä koskevien direktiivin muiden ehtojen mukainen.
Svenska [Swedish]	Härmed intygar TRENDnet att denna TV-IP341PI står i överensstämmelse med de väsentliga egenskapskrav och övriga relevanta bestämmelser som framgår av direktiv 2004/108/EG och 2006/95/EG.

Limited Warranty

TRENDnet warrants its products against defects in material and workmanship, under normal use and service, for the following lengths of time from the date of purchase.

- TV-IP341PI – 3 Years Warranty

If a product does not operate as warranted during the applicable warranty period, TRENDnet shall reserve the right, at its expense, to repair or replace the defective product or part and deliver an equivalent product or part to the customer. The repair/replacement unit's warranty continues from the original date of purchase. All products that are replaced become the property of TRENDnet. Replacement products may be new or reconditioned. TRENDnet does not issue refunds or credit. Please contact the point-of purchase for their return policies.

TRENDnet shall not be responsible for any software, firmware, information, or memory data of customer contained in, stored on, or integrated with any products returned to TRENDnet pursuant to any warranty.

There are no user serviceable parts inside the product. Do not remove or attempt to service the product by any unauthorized service center. This warranty is voided if (i) the product has been modified or repaired by any unauthorized service center, (ii) the product was subject to accident, abuse, or improper use (iii) the product was subject to conditions more severe than those specified in the manual.

Warranty service may be obtained by contacting TRENDnet within the applicable warranty period and providing a copy of the dated proof of the purchase. Upon proper submission of required documentation a Return Material Authorization (RMA) number will be issued. An RMA number is required in order to initiate warranty service support for all TRENDnet products. Products that are sent to TRENDnet for RMA service must have the RMA number marked on the outside of return packages and sent to TRENDnet prepaid, insured and packaged appropriately for safe shipment. Customers shipping from outside of the USA and Canada are responsible for return shipping fees. Customers shipping from outside of the USA are responsible for custom charges, including but not limited to, duty, tax, and other fees.

WARRANTIES EXCLUSIVE: IF THE TRENDNET PRODUCT DOES NOT OPERATE AS WARRANTED ABOVE, THE CUSTOMER'S SOLE REMEDY SHALL BE, AT TRENDNET'S OPTION, REPAIR OR REPLACE. THE FOREGOING WARRANTIES AND REMEDIES ARE EXCLUSIVE AND ARE IN LIEU OF ALL OTHER WARRANTIES, EXPRESSED OR IMPLIED, EITHER IN FACT OR BY OPERATION OF LAW, STATUTORY OR OTHERWISE, INCLUDING WARRANTIES OF MERCHANTABILITY AND FITNESS FOR A PARTICULAR PURPOSE.

TRENDNET NEITHER ASSUMES NOR AUTHORIZES ANY OTHER PERSON TO ASSUME FOR IT ANY OTHER LIABILITY IN CONNECTION WITH THE SALE, INSTALLATION MAINTENANCE OR USE OF TRENDNET'S PRODUCTS.

TRENDNET SHALL NOT BE LIABLE UNDER THIS WARRANTY IF ITS TESTING AND EXAMINATION DISCLOSE THAT THE ALLEGED DEFECT IN THE PRODUCT DOES NOT EXIST OR WAS CAUSED BY CUSTOMER'S OR ANY THIRD PERSON'S MISUSE, NEGLIGENCE, IMPROPER INSTALLATION OR TESTING, UNAUTHORIZED ATTEMPTS TO REPAIR OR MODIFY, OR ANY OTHER CAUSE BEYOND THE RANGE OF THE INTENDED USE, OR BY ACCIDENT, FIRE, LIGHTNING, OR OTHER HAZARD.

LIMITATION OF LIABILITY: TO THE FULL EXTENT ALLOWED BY LAW TRENDNET ALSO EXCLUDES FOR ITSELF AND ITS SUPPLIERS ANY LIABILITY, WHETHER BASED IN CONTRACT OR TORT (INCLUDING NEGLIGENCE), FOR INCIDENTAL, CONSEQUENTIAL, INDIRECT, SPECIAL, OR PUNITIVE DAMAGES OF ANY KIND, OR FOR LOSS OF REVENUE OR PROFITS, LOSS OF BUSINESS, LOSS OF INFORMATION OR DATE, OR OTHER FINANCIAL LOSS ARISING OUT OF OR IN CONNECTION WITH THE SALE, INSTALLATION, MAINTENANCE, USE, PERFORMANCE, FAILURE, OR INTERRUPTION OF THE POSSIBILITY OF SUCH DAMAGES, AND LIMITS ITS LIABILITY TO REPAIR, REPLACEMENT, OR REFUND OF THE PURCHASE PRICE PAID, AT TRENDNET'S OPTION. THIS DISCLAIMER OF LIABILITY FOR DAMAGES WILL NOT BE AFFECTED IF ANY REMEDY PROVIDED HEREIN SHALL FAIL OF ITS ESSENTIAL PURPOSE.

Governing Law: This Limited Warranty shall be governed by the laws of the state of California.

Some TRENDnet products include software code written by third party developers. These codes are subject to the GNU General Public License ("GPL") or GNU Lesser General Public License ("LGPL").

Go to <http://www.trendnet.com/gpl> or <http://www.trendnet.com> Download section and look for the desired TRENDnet product to access to the GPL Code or LGPL Code. These codes are distributed WITHOUT WARRANTY and are subject to the copyrights of the developers. TRENDnet does not provide technical support for these codes. Please go to <http://www.gnu.org/licenses/gpl.txt> or <http://www.gnu.org/licenses/lgpl.txt> for specific terms of each license.



Product Warranty Registration

Please take a moment to register your product online.
Go to TRENDnet's website at <http://www.trendnet.com/register>

TRENDnet
20675 Manhattan Place
Torrance, CA 90501. USA