



**IDIS Co., Ltd.**

For more information, please visit  
[www.idisglobal.com](http://www.idisglobal.com)



# Network Camera

Quick Guide

# Safety Precautions

## WARNING

RISK OF ELECTRIC SHOCK  
DO NOT OPEN

**WARNING:** TO REDUCE THE RISK OF ELECTRIC SHOCK,  
DO NOT REMOVE COVER (OR BACK). NO USER-SERVICEABLE PARTS INSIDE.  
REFER SERVICING TO QUALIFIED SERVICE PERSONNEL.

## Important Safeguards

### 1. Read Instructions

All the safety and operating instructions should be read before the appliance is operated.

### 2. Retain Instructions

The safety and operating instructions should be retained for future reference.

### 3. Cleaning

Unplug this equipment from the wall outlet before cleaning it. Do not use liquid aerosol cleaners. Use a damp soft cloth for cleaning.

### 4. Attachments

Never add any attachments and/or equipment without the approval of the manufacturer as such additions may result in the risk of fire, electric shock or other personal injury.

### 5. Water and/or Moisture

Do not use this equipment near water or in contact with water.

### 6. Placing and Accessories

Do not place this equipment on a wall or ceiling that is not strong enough to sustain the camera. The equipment may fall, causing serious injury to a child or adult, and serious damage to the equipment. Wall or shelf mounting should follow the manufacturer's instructions, and should use a mounting kit approved by the manufacturer.



This equipment and cart combination should be moved with care. Quick stops, excessive force, and uneven surfaces may cause the equipment and cart combination to overturn.

Do not place this equipment in an enclosed space. Sufficient ventilation is required to prevent an increase in ambient temperature which can cause malfunction or the risk of fire.

### 7. Power Sources

This equipment should be operated only from the type of power source indicated on the marking label. If you are not sure of the type of power, please consult your equipment dealer or local power company.

You may want to install a UPS (Uninterruptible Power Supply) system for safe operation in order to prevent damage caused by an unexpected power stoppage. Any questions concerning UPS, consult your UPS retailer.

### 8. Power Cord

Operator or installer must remove power and TNT connections before handling the equipment.

### 9. Lightning

For added protection for this equipment during a lightning storm, or when it is left unattended and unused for long periods of time, unplug it from the wall outlet and disconnect the antenna or cable system. This will prevent damage to the equipment due to

lightning and power-line surges. If thunder or lightning is common where the equipment is installed, use a surge protection device.

### 10. Overloading

Do not overload wall outlets and extension cords as this can result in the risk of fire or electric shock.

### 11. Objects and Liquids

Never push objects of any kind through openings of this equipment as they may touch dangerous voltage points or short out parts that could result in a fire or electric shock. Never spill liquid of any kind on the equipment.

### 12. Servicing

Do not attempt to service this equipment yourself. Refer all servicing to qualified service personnel.

### 13. Damage requiring Service

Unplug this equipment from the wall outlet and refer servicing to qualified service personnel under the following conditions:

- When the power-supply cord or the plug has been damaged.
- If liquid is spilled, or objects have hit the equipment.
- If the equipment has been exposed to rain or water.
- If the equipment does not operate normally by following the operating instructions, adjust only those controls that are covered by the operating instructions as an improper adjustment of other controls may result in damage and will often require extensive work by a qualified technician to restore the equipment to its normal operation.
- If the equipment has been dropped, or the cabinet damaged.
- If the equipment exhibits a distinct change in performance — this indicates a need for service.

### 14. Replacement Parts

When replacement parts are required, be sure the service technician has used replacement parts specified by the manufacturer or that have the same characteristics as the original part. Unauthorized substitutions may result in fire, electric shock or other hazards.

### 15. Safety Check

Upon completion of any service or repairs to this equipment, ask the service technician to perform safety checks to determine that the equipment is in proper operating condition.

### 16. Field Installation

This installation should be made by a qualified service person and should conform to all local codes.

### 17. Correct Batteries

Warning: Risk of explosion if battery is replaced by an incorrect type. Dispose of used batteries according to the instructions.

### 18. Tmra

A manufacturer's maximum recommended ambient temperature (Tmra) for the equipment must be specified so that the customer and installer may determine a suitable maximum operating environment for the equipment.

## FCC Compliance Statement

THIS EQUIPMENT HAS BEEN TESTED AND FOUND TO COMPLY WITH THE LIMITS FOR A CLASS A DIGITAL DEVICE, PURSUANT TO PART 15 OF THE FCC RULES. THESE LIMITS ARE DESIGNED TO PROVIDE REASONABLE PROTECTION AGAINST HARMFUL INTERFERENCE WHEN THE EQUIPMENT IS OPERATED IN A COMMERCIAL ENVIRONMENT. THIS EQUIPMENT GENERATES, USES, AND CAN RADIATE RADIO FREQUENCY ENERGY AND IF NOT INSTALLED AND USED IN ACCORDANCE WITH THE INSTRUCTION MANUAL, MAY CAUSE HARMFUL INTERFERENCE TO RADIO COMMUNICATIONS. OPERATION OF THIS EQUIPMENT IN A RESIDENTIAL AREA IS LIKELY TO CAUSE HARMFUL INTERFERENCE, IN WHICH CASE USERS WILL BE REQUIRED TO CORRECT THE INTERFERENCE AT THEIR OWN EXPENSE.

**WARNING:** CHANGES OR MODIFICATIONS NOT EXPRESSLY APPROVED BY THE PARTY RESPONSIBLE FOR COMPLIANCE COULD VOID THE USER'S AUTHORITY TO OPERATE THE EQUIPMENT. THIS CLASS OF DIGITAL APPARATUS MEETS ALL REQUIREMENTS OF THE CANADIAN INTERFERENCE CAUSING EQUIPMENT REGULATIONS.

## WEEE (Waste Electrical & Electronic Equipment)

**Correct Disposal of This Product**  
(Applicable in the European Union and other European countries with separate collection systems)



This marking shown on the product or its literature, indicates that it should not be disposed with other household wastes at the end of its working life. To prevent possible harm to the environment or human health from uncontrolled waste disposal, please separate this from other types of wastes and recycle it responsibly to promote the sustainable reuse of material resources.

Household users should contact either the retailer where they purchased this product, or their local government office, for details of where and how they can take this item for environmentally safe recycling.

Business users should contact their supplier and check the terms and conditions of the purchase contract. This product should not be mixed with other commercial wastes for disposal.

## Copyright

© 2013 IDIS Co., Ltd.

IDIS Co., Ltd. reserves all rights concerning this operation manual.

Use or duplication of this operation manual in part or whole without the prior consent of IDIS Co., Ltd. is strictly prohibited.

Contents of this operation manual are subject to change without prior notice for reasons such as functionality enhancements.

## Registered Trademarks

IDIS is a registered trademark of IDIS Co., Ltd.

Other company and product names are registered trademarks of their respective owners.

This product contains software built partially on open-source content. Codes for the corresponding open-source content are available for download. For more information, refer to the software CD (OpenSourceGuide\OpenSourceGuide.pdf) or the open source guide accompanying this operation manual.

## Accessories

Upon purchasing the product, check inside the box to make sure all the following accessories are included. Some parts may differ depending on the situation.

Camera Type	Item
Dome	Network Camera
	Ferrite Core
	Open Source Guide
	Quick Guide
	Allen wrench (included with DC-D1022W / DC-D1022WR / DC-D1122V / DC-D1122VR / DC-D1122W / DC-D1122WR / DC-D1123V / DC-D1123VR / DC-D1123W / DC-D1123WR / DC-D1123VHR / DC-D1123VHR / DC-D1223V / DC-D1223VR / DC-D1223W / DC-D1223WR / DC-D1223VHR / DC-D1323WR / DC-D1323VHR only.)
	Screws (3 ea.)
	Desiccant and cable access hole rubber (included with DC-D1022W / DC-D1022WR / DC-D1122V / DC-D1122WR / DC-D1123V / DC-D1123VR / DC-D1123W / DC-D1123WR / DC-D1123VHR / DC-D1123VHR / DC-D1223V / DC-D1223VR / DC-D1323WR / DC-D1323VHR only.)
Box	Network Camera
	Ferrite Core
	Open Source Guide
	Quick Guide
	C-Mount Ring
	Installation Parts
Protective Cover (attaches to camera)	

# Overview



- Product color and design may vary depending on the model.
- For more details on each part name, refer to the operation manual.

## Dome Camera

DC-D1123 / DC-D1223

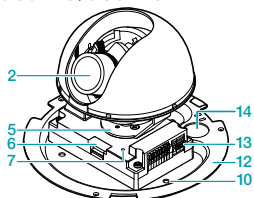

DC-D1123WHR / DC-D1223WHR /  
DC-D1323WHR

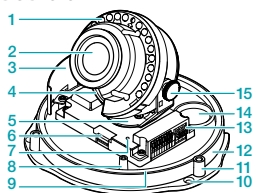

DC-D1122V / DC-D1022W /  
DC-D1122W

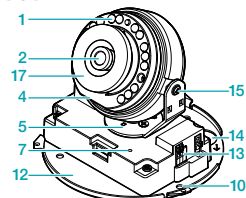

DC-D1123R / DC-D1223R /  
DC-D1323R

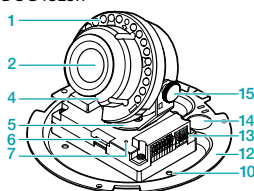

DC-D1011 / DC-D1111

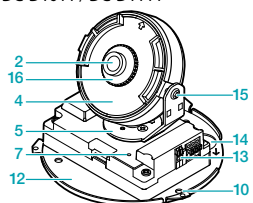

DC-D1122VR / DC-D1022WR /  
DC-D1122WR

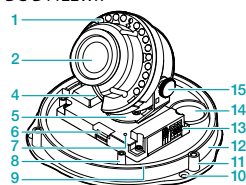

DC-D1123V / DC-D1223V /  
DC-D1123W / DC-D1223W

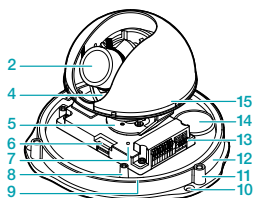

DC-D1122

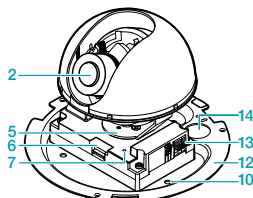

DC-D1212R

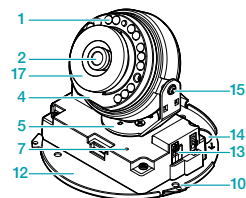

DC-D1123VR / DC-D1223VR /  
DC-D1123WR / DC-D1223WR /  
DC-D1323WR

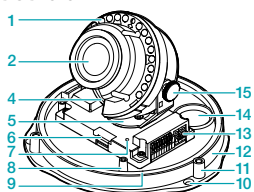

DC-D1122R

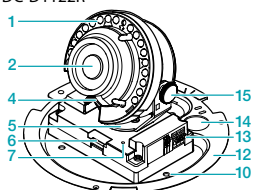

1	IR LED	10	Wall/Ceiling Installation Hole
2	Lens	11	Dome Cover Screw Hole
3	Heater	12	Bottom Cover
4	Lens Rotator	13	I/O Device Port
5	Horizontal Rotator	14	Cable Access Hole
6	SD Memory Card Slot	15	Vertical Rotation Adjustment Screw
7	Factory Reset Switch	16	Focus Lock Ring
8	Safety Wire Screw Hole	17	Focus Lock Spring
9	O-Ring Groove		

### I/O Device Port

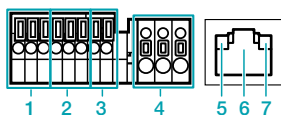

1	Alarm I/O	5	Network LED
2	Audio I/O	6	Network Port
3	Video Out	7	Power LED
4	Power		

- ✓ Alarm In/Out and Audio In/Out are supported by *DC-D1123 / DC-D1123R / DC-D1123V / DC-D1123VR / DC-D1123W / DC-D1123WR / DC-D1123WHR / DC-D1223 / DC-D1223R / DC-D1223V / DC-D1223VR / DC-D1223W / DC-D1223WR / DC-D1223WHR / DC-D1323R / DC-D1323WR / DC-D1323WHR models only.*

### Box Camera

#### Front

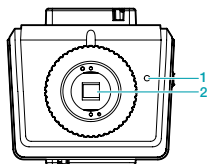

1	Built-in Microphone <i>DC-B1103 / DC-B1203 / DC-B1303 only</i>	2	Image Sensor
---	---	---	--------------

#### Rear

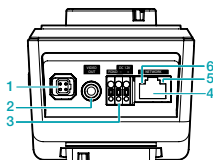

1	Auto Iris Lens Connector	4	Network Port
2	Video Out	5	Network LED
3	Power	6	Power LED

#### Side

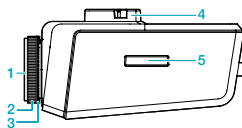

1	Protective Cover	4	Mount Bracket
2	C-Mount Ring	5	SD Memory Card Slot <i>DC-B1103 / DC-B1203 / DC-B1303 only</i>
3	Back Focus Adjustment Ring		

#### Top

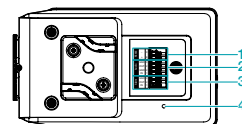

1	RS485 Port <i>DC-B1103 / DC-B1203 / DC-B1303 only</i>	3	Alarm I/O <i>DC-B1103 / DC-B1203 / DC-B1303 only</i>
2	Audio I/O <i>DC-B1103 / DC-B1203 / DC-B1303 only</i>	4	Factory Reset Switch

# Camera Installation

## Dome Camera

DC-D1022W / DC-D1022WR / DC-D1122V /  
DC-D1122VR / DC-D1122W / DC-D1122WR /  
DC-D1123V / DC-D1123VR / DC-D1123W /  
DC-D1123WHR / DC-D1123WR / DC-D1223V /  
DC-D1223VR / DC-D1223W / DC-D1223WHR /  
DC-D1223WR / DC-D1323WR / DC-D1323WHR

- Attach the enclosed desiccant beside the safety wire screw inside the dome cover to prevent moisture. *DC-D1022W / DC-D1022WR / DC-D1122W / DC-D1122WR / DC-D1123W / DC-D1123WR / DC-D1123WHR / DC-D1223W / DC-D1223WR / DC-D1223WHR / DC-D1323WR / DC-D1323WHR only.*

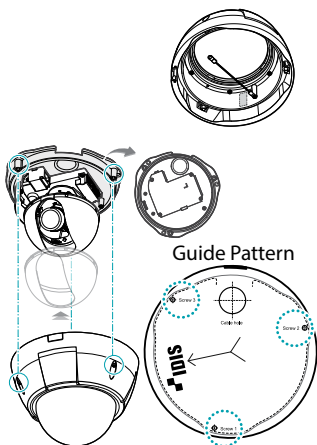

DC-D1122 / DC-D1122R / DC-D1123 /  
DC-D1123R / DC-D1223 / DC-D1223R / DC-D1323R

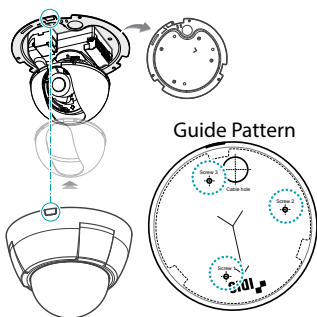

DC-D1011 / DC-D1111 / DC-D1212R

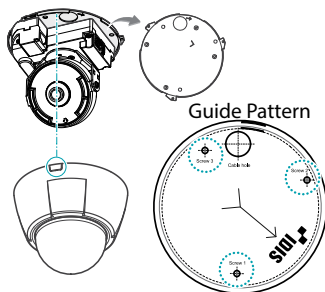

- 1 Use the screws provided with the camera to secure the bottom cover on a wall or a ceiling.
  - Use the provided guide pattern to check the distance between the screws.
- 2 Connect external devices, the network cable, and the power adapter. If the camera is *DC-D1022W / DC-D1022WR / DC-D1122W / DC-D1122WR / DC-D1123W / DC-D1123WR / DC-D1123WHR / DC-D1223W / DC-D1223WR / DC-D1223WHR / DC-D1323WR / DC-D1323WHR*, block the cable access hole for waterproofing by using the enclosed cable access hole rubber when routing cables and wires. Ask your retailer for details.
- 3 Adjust the angle of the lens. For more details, refer to **Angle Adjustment**.
- 4 Adjust the focus and zoom levers.
  - DC-D1011 / DC-D1111 / DC-D1212R* models do not have a zoom feature.
- 5 Attach the shield case to the vertical rotation adjustment screw and secure it in place. *DC-D1022W / DC-D1122 / DC-D1122V / DC-D1122WR / DC-D1123 / DC-D1123V / DC-D1123WR / DC-D1223W / DC-D1223VR / DC-D1223WHR / DC-D1223WR / DC-D1323WR / DC-D1323WHR* only
- 6 Attach the dome cover to the bottom cover.
  - *DC-D1022W / DC-D1022WR / DC-D1122V / DC-D1122VR / DC-D1122W / DC-D1122WR / DC-D1123V / DC-D1123VR / DC-D1123W / DC-D1123WHR / DC-D1123WR / DC-D1223V / DC-D1223VR / DC-D1223W / DC-D1223WHR / DC-D1223WR / DC-D1323WR / DC-D1323WHR*: Use the provided screws to secure the dome cover on to the bottom cover.
  - *DC-D1011 / DC-D1111 / DC-D1122 / DC-D1122R / DC-D1123 / DC-D1123R / DC-D1212R / DC-D1223 / DC-D1223R / DC-D1323R*: Align the marking next to the cable access hole on the bottom cover and the side cable access hole on the dome cover together and then turn the dome cover in clockwise direction to lock it in place.

## 7 Connect the power.



Check the wall or ceiling to see if it needs to be reinforced. The camera may fall off if the wall or ceiling is not strong enough to support its weight.

### Angle Adjustment

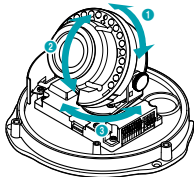

①	Lens Rotation	③	Horizontal Rotation
②	Vertical Rotation		

### Box Camera

CS-Mount Lens	
C-Mount Lens	

### Manual Iris Lens

- 1 Remove the protective cover from the camera.
- 2 Turn the lens in clockwise direction and mount it on the camera.
- 3 Rotate the lens' iris ring to open up the iris and then adjust accordingly.

### DC Type Auto Iris Lens

- 1 Solder on the lens connection line to the connector socket, if necessary. For more information about soldering on the lens control wire, refer to the lens manufacturer's **operation manual**.
- 2 Remove the protective cover from the camera.
- 3 Turn the lens in clockwise direction, mount it on to the camera, and connect the auto iris jack to the auto iris lens connector.



The auto iris jack must be at least 20cm long in order to connect it to the camera.

### CS-Mount Lens

- 1 Remove the protective cover from the camera.
- 2 Turn the lens in clockwise direction and mount it on the camera.

### C-Mount Lens

- 1 Remove the protective cover from the camera.
- 2 Turn the mount ring in clockwise direction and mount the ring on to the camera.
- 3 Turn the C-mount lens in clockwise direction and mount it on to the C-mount ring.

- **DirectIP NVR makes it easy to use cameras without extra network configurations. Each camera can be controlled via the DirectIP™ NVR setup menu, without any PC.**
  - For detailed camera settings, please see the camera setting pages of DirectIP™ NVR manual.
- **To use your camera with non-DirectIP system (e.g. other NVR or VMS), refer to the camera manual and it can be downloaded from our website: [www.idisglobal.com](http://www.idisglobal.com).**



# Specifications

## Dome Camera

<b>External Dimensions</b> (Ø x H)	DC-D1022W / DC-D1022WR / DC-D1122 / DC-D1122R / DC-D1122V / DC-D1122VR / DC-D1122W / DC-D1122WR / DC-D1123 / DC-D1123R / DC-D1123V / DC-D1123VR / DC-D1123W / DC-D1123WR / DC-D1123WHR / DC-D1223 / DC-D1223R / DC-D1223V / DC-D1223VR / DC-D1223W / DC-D1223WR / DC-D1223WHR / DC-D1323R / DC-D1323WR / DC-D1323WHR	160mm x 122mm (6.3" x 4.8")
	DC-D1011 / DC-D1111 / DC-D1212R	132mm x 103mm (5.2" x 4.06")
<b>Packaging Dimensions</b> (W x H x D)	DC-D1022W / DC-D1022WR / DC-D1122 / DC-D1122R / DC-D1122V / DC-D1122VR / DC-D1122W / DC-D1122WR / DC-D1123 / DC-D1123R / DC-D1123V / DC-D1123VR / DC-D1123W / DC-D1123WR / DC-D1123WHR / DC-D1223 / DC-D1223R / DC-D1223V / DC-D1223VR / DC-D1223W / DC-D1223WR / DC-D1223WHR / DC-D1323R / DC-D1323WR / DC-D1323WHR	205mm x 175mm x 205mm (8.07" x 6.89" x 8.07")
	DC-D1011 / DC-D1111 / DC-D1212R	200mm x 127mm x 169mm (7.87" x 5" x 6.65")
<b>Weight</b> (Main Unit)	DC-D1022W / DC-D1022WR / DC-D1122V / DC-D1122VR / DC-D1122W / DC-D1122WR / DC-D1123V / DC-D1123VR / DC-D1123W / DC-D1123WR / DC-D1123WHR / DC-D1223V / DC-D1223VR / DC-D1223W / DC-D1223WR / DC-D1223WHR / DC-D1323R / DC-D1323WR / DC-D1323WHR	0.87kg (1.92lb)
	DC-D1122 / DC-D1122R / DC-D1123 / DC-D1123R / DC-D1123V / DC-D1123VR / DC-D1223R / DC-D1223R	0.51 kg (1.12lb)
	DC-D1011 / DC-D1111 / DC-D1212R	0.35kg (0.77lb)
<b>Weight</b> (Packaging)	DC-D1022W / DC-D1022WR / DC-D1122V / DC-D1122VR / DC-D1122W / DC-D1122WR / DC-D1123V / DC-D1123VR / DC-D1123W / DC-D1123WR / DC-D1123WHR / DC-D1223V / DC-D1223VR / DC-D1223W / DC-D1223WR / DC-D1223WHR / DC-D1323R / DC-D1323WR / DC-D1323WHR	1.18kg (2.6lb)
	DC-D1122 / DC-D1122R / DC-D1123 / DC-D1123R / DC-D1123V / DC-D1123VR / DC-D1223R / DC-D1223R	0.82kg (1.81lb)
	DC-D1011 / DC-D1111 / DC-D1212R	0.53kg (1.17lb)
<b>Working Temperature</b>	DC-D1011 / DC-D1022W / DC-D1022WR / DC-D1111 / DC-D1122 / DC-D1122R / DC-D1122V / DC-D1122VR / DC-D1122W / DC-D1122WR / DC-D1123 / DC-D1123R / DC-D1123V / DC-D1123VR / DC-D1123W / DC-D1123WR / DC-D1123WHR / DC-D1223 / DC-D1223R / DC-D1223V / DC-D1223VR / DC-D1223W / DC-D1223WR / DC-D1223WHR / DC-D1323R / DC-D1323WR / DC-D1323WHR	-10°C ~ 50°C (14°F ~ 122°F) [Starting Temperature: 0°C ~ 50°C (32°F ~ 122°F)]
	DC-D1123WHR / DC-D1223WHR / DC-D1323R	-20°C ~ 50°C (-4°F ~ 122°F)
<b>Operating Humidity</b>		0% ~ 90%
<b>Power Input</b>	DC-D1011 / DC-D1022W / DC-D1022WR / DC-D1111 / DC-D1122 / DC-D1122R / DC-D1122V / DC-D1122VR / DC-D1122W / DC-D1122WR / DC-D1123 / DC-D1123R / DC-D1123V / DC-D1123VR / DC-D1123W / DC-D1123WR / DC-D1123WHR / DC-D1223 / DC-D1223R / DC-D1223V / DC-D1223VR / DC-D1223W / DC-D1223WR / DC-D1223WHR / DC-D1323R / DC-D1323WR / DC-D1323WHR	12V DC, PoE(IEEE 802.3af, Class2)
	DC-D1212R	PoE(IEEE 802.3af, Class 2)
<b>Power Consumption</b>	DC-D1011 / DC-D1022W / DC-D1022WR / DC-D1111 / DC-D1122 / DC-D1122R / DC-D1122V / DC-D1122VR / DC-D1122W / DC-D1122WR / DC-D1123 / DC-D1123R / DC-D1123V / DC-D1123VR / DC-D1123W / DC-D1123WR / DC-D1123WHR / DC-D1212R / DC-D1223 / DC-D1223R / DC-D1223V / DC-D1223VR / DC-D1223W / DC-D1223WR / DC-D1223WHR / DC-D1323R / DC-D1323WR / DC-D1323WHR	Max. 4.8W (DC-D1123WHR / DC-D1223WHR - With heater on: Max. 19.2W)
<b>Certifications</b>		FCC, CE, KC, IP66****

\*\*\*\* Applies to DC-D1022W / DC-D1022WR / DC-D1122W / DC-D1122WR / DC-D1123W / DC-D1123WR / DC-D1123WHR / DC-D1223W / DC-D1223WR / DC-D1223WHR / DC-D1323R / DC-D1323WR / DC-D1323WHR models only.

## Box Camera

	<b>DC-B1001 / DC-B1101 / DC-B1103 / DC-B1203</b>
<b>Exterior Dimensions (W x H x D)</b>	75.62mm x 61.02mm x 129.32mm (2.98" x 2.4" x 5.09")
<b>Packaging Dimensions (W x H x D)</b>	194mm x 113mm x 149mm (7.64" x 4.45" x 5.87")
<b>Weight (Main Unit)</b>	0.4 kg (0.88 lbs.)
<b>Weight (Packaging)</b>	0.68 kg (1.50 lbs.)
<b>Working Temperature</b>	-10°C ~ 50°C (14°F ~ 122°F) [Starting Temperature: 0°C ~ 50°C (32°F ~ 122°F)]
<b>Operating Humidity</b>	0% ~ 90%
<b>Power</b>	12 VDC, PoE (IEEE 802.3af, Class 2)
<b>Power Consumption</b>	Max. 4.8W
<b>Certifications</b>	FCC, CE, KC