

Acer Projector

U5530/U5330W/U5230/R350/R320/R310/
PU-F20/PU-W20/PU-X20/SP150/SP130/
SP110/FU-420/FU-320/FU-120/D1P1801/
DWX1802/DNX1803

User's Guide

Changes may be made periodically to the information in this publication without obligation to notify any person of such revisions or changes. Such changes will be incorporated in new editions of this manual or supplementary documents and publications. This company makes no representations or warranties, either expressed or implied, with respect to the contents hereof and specifically disclaims the implied warranties of merchantability or fitness for a particular purpose.

Record the model number, serial number, purchase date and place of purchase information in the space provided below. The serial number and model number are recorded on the label affixed to your projector. All correspondence concerning your unit should include the serial number, model number and purchase information.

No part of this publication may be reproduced, stored in a retrieval system, or transmitted, in any form or by any means, electronically, mechanically, by photocopy, recording or otherwise, without the prior written permission of Acer Incorporated.

Model number: _____

Serial number: _____

Date of purchase: _____

Place of purchase: _____

Acer and the Acer logo are registered trademarks of Acer Incorporated. Other companies' product names or trademarks are used herein for identification purposes only and belong to their respective companies.

"HDMI™, the HDMI logo and High-Definition Multimedia Interface are trademarks or registered trademarks of HDMI Licensing LLC."



Information for your safety and comfort

Read these instructions carefully. Keep this document for future reference. Follow all warnings and instructions marked on the product.

Turning the product off before cleaning

Unplug this product from the wall outlet before cleaning. Do not use liquid cleaners or aerosol cleaners. Use a damp cloth for cleaning.

Caution for plug as disconnecting device

Observe the following guidelines when connecting and disconnecting power to the external power supply unit:

- Install the power supply unit before connecting the power cord to the AC power outlet.
- Unplug the power cord before removing the power supply unit from the projector.
- If the system has multiple sources of power, disconnect power from the system by unplugging all power cords from the power supplies.

Caution for Accessibility

Be sure that the power outlet you plug the power cord into is easily accessible and located as close to the equipment operator as possible. When you need to disconnect power to the equipment, be sure to unplug the power cord from the electrical outlet.



Warnings!

- Do not use this product near water.
- Do not place this product on an unstable cart, stand or table. If the product falls, it could be seriously damaged.
- Slots and openings are provided for ventilation to ensure reliable operation of the product and to protect it from overheating. These openings must not be blocked or covered. The openings should never be blocked by placing the product on a bed, sofa, rug or other similar surface.
- This product should never be placed near or over a radiator or heat register, or in a built-in installation unless proper ventilation is provided.
- Never push objects of any kind into this product through cabinet slots as they may touch dangerous voltage points or short-out parts that could result in a fire or electric shock. Never spill liquid of any kind onto or into the product.
- To avoid damage of internal components and to prevent battery leakage, do not place the product on a vibrating surface.

- Never use it under sporting, exercising, or any vibrating environment which will probably cause unexpected short current or damage rotor devices, lamp.

Using electrical power

- This product should be operated from the type of power indicated on the marking label. If you are not sure of the type of power available, consult your dealer or local power company.
- Do not allow anything to rest on the power cord. Do not locate this product where people will walk on the cord.
- If an extension cord is used with this product, make sure that the total ampere rating of the equipment plugged into the extension cord does not exceed the extension cord ampere rating. Also, make sure that the total rating of all products plugged into the wall outlet does not exceed the fuse rating.
- Do not overload a power outlet, strip or receptacle by plugging in too many devices. The overall system load must not exceed 80% of the branch circuit rating. If power strips are used, the load should not exceed 80% of the power strip's input rating.
- This product's AC adapter is equipped with a three-wire grounded plug. The plug only fits in a grounded power outlet. Make sure the power outlet is properly grounded before inserting the AC adapter plug. Do not insert the plug into a non-grounded power outlet. Contact your electrician for details.



.....

Warning! The grounding pin is a safety feature. Using a power outlet that is not properly grounded may result in electric shock and/or injury.



.....

Note: The grounding pin also provides good protection from unexpected noise produced by other nearby electrical devices that may interfere with the performance of this product.

- Use the product only with the supplied power supply cord set. If you need to replace the power cord set, make sure that the new power cord meets the following requirements: detachable type, UL listed/CSA certified, VDE approved or its equivalent, 4.5 meters (15 feet) maximum length.

Product servicing

Do not attempt to service this product yourself, as opening or removing covers may expose you to dangerous voltage points or other risks. Refer all servicing to qualified service personnel.

Unplug this product from the wall outlet and refer servicing to qualified service personnel when:

- the power cord or plug is damaged, cut or frayed

- liquid was spilled into the product
- the product was exposed to rain or water
- the product has been dropped or the case has been damaged
- the product exhibits a distinct change in performance, indicating a need for service
- the product does not operate normally after following the operating instructions



.....

Note: Adjust only those controls that are covered by the operating instructions, since improper adjustment of other controls may result in damage and will often require extensive work by a qualified technician to restore the product to normal condition.



.....

Warning! For safety reasons, do not use non-compliant parts when adding or changing components. Consult your reseller for purchase options.

Your device and its enhancements may contain small parts. Keep them out of the reach of small children.

Additional safety information

- Do not look into the projector's lens when the lamp is on. The bright may hurt your eyes.
- Turn on the projector first and then signal sources
- Do not place the product in following environments:
 - Space that is poorly ventilated or confined. At least 50cm clearance from walls and free flow of air around the projector is necessary.
 - Locations where temperatures may become excessively high, such as inside of a car with all windows rolled up.
 - Locations where excessive humidity, dust, or cigarette smoke may contaminate optical components, shortening the life span and darkening the image.
 - Locations near fire alarms.
 - Locations with an ambient temperature above 40 °C/104 °F.
 - Locations where the altitudes are higher than 10000 feet.
- Unplug immediately if there is something wrong with your projector. Do not operate if smoke, strange noise or odor comes out of your projector. It might cause fire or electric shock. In this case, unplug immediately and contact your dealer.
- Do not keep using this product to break or drop it. In this case contact your dealer for inspection.
- Do not face the projector lens to the sun. It can lead to fire.
- When switching the projector off, suggest to ensure the projector completes its cooling cycle before disconnecting power.
- Do not frequently turn off the main power abruptly or unplug the projector during operation. The best way is to wait for the fan to turn off before turning main power off.

- Do not touch air outlet grille and bottom plate which becomes hot.
- Clean the air filter frequently if have. The temperature inside may rise and cause damage when the filter/ventilation slots clogged with dirt or dust.
- Do not look into the air outlet grille when projector is operating. It may hurt your eyes.
- Always open the lens shutter or remove the lens cap when the projector is on.
- Do not block the projector lens with any object when the projector is under operation as this could cause the object to become heated and deformed or even cause a fire.
- The lamp becomes extremely hot during operation. Allow the projector to cool for approximately 45 minutes prior to removing the lamp assembly for replacement.
- Do not operate lamps beyond the rated lamp life. It could cause it to break on rare occasions.
- Never replace the lamp assembly or any electronic components unless the projector is unplugged.
- The product will detect the life of the lamp itself. Please be sure to change the lamp when is showing warning message.
- When changing the lamp, please allow unit to cool down, and follow all changing instructions.
- Reset the "Lamp Reset" function from the Onscreen display "OPTIONS | Lamp Settings" menu after replacing the lamp module.
- Do not attempt to disassemble this projector. There are dangerous high voltages inside which may hurt you. The only user serviceable part is the lamp which has its own removable cover. Refer servicing only to suitable qualified professional service personnel.
- Do not stand the projector on end vertically. It may cause the projector to fall over, causing injury or damage.
- This product is capable of displaying inverted images for ceiling mount installation. Only use acer ceiling mount kit for mounting the projector and ensure it is securely installed.
- The projector should be placed in a horizontal way by means of desktop or ceiling mount mode only, and its tilt angles should not exceed 3.8 degrees, otherwise it would cause dramatical decrease of lamp life or severe safety concern of system malfunction.

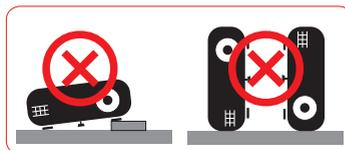
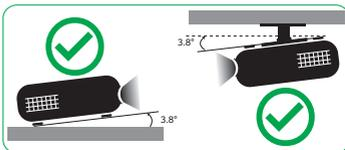

Caution for Listening

To protect your hearing, follow these instructions.

- Increase the volume gradually until you can hear clearly and comfortably.
- Do not increase the volume level after your ears have adjusted.
- Do not listen to music at high volumes for extended periods.
- Do not increase the volume to block out noisy surroundings.
- Decrease the volume if you can't hear people speaking near you.

Disposal instructions

Do not throw this electronic device into the trash when discarding. To minimize pollution and ensure utmost protection of the global environment, please recycle. For more information on the Waste from Electrical and Electronics Equipment (WEEE) regulations, visit

<http://www.acer-group.com/public/Sustainability/sustainability01.htm>



Mercury advisory

For projectors or electronic products containing an LCD/CRT monitor or display:

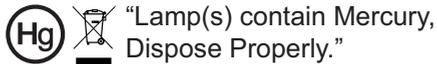

Lamp(s) inside this product contain mercury and must be recycled or disposed of according to local, state or federal laws. For more information, contact the Electronic Industries Alliance at www.eiae.org. For lamp-specific disposal information, check www.lamprecycle.org

First things first

Usage Notes

Do:

- Turn off the product before cleaning.
- Use a soft cloth moistened with mild detergent to clean the display housing.
- Disconnect the power plug from AC outlet if the product is not being used for a long period of time.

Don't:

- Block the slots and openings on the unit provided for ventilation.
- Use abrasive cleaners, waxes or solvents to clean the unit.
- Use under the following conditions:
 - In extremely hot, cold or humid environments.
 - In areas susceptible to excessive dust and dirt.
 - Near any appliance that generates a strong magnetic field.
 - Place In direct sunlight.

Precautions

Follow all warnings, precautions and maintenance as recommended in this user's guide to maximize the life of your unit.



Warning:

- Do not look into the projector's lens when the lamp is on. The bright light may hurt your eyes.
- To reduce the risk of fire or electric shock, do not expose this product to rain or moisture.
- Please do not open or disassemble the product as this may cause electric shock.
- When changing the lamp, please allow unit to cool down, and follow all changing instructions.
- This product will detect the life of the lamp itself. Please be sure to change the lamp when it shows warning messages.
- Reset the "Lamp Reset" function from the Onscreen display "OPTIONS | Lamp Settings" menu after replacing the lamp module.
- When switching the projector off, please ensure the projector completes its cooling cycle before disconnecting power.
- Turn on the projector first and then the signal sources.
- Do not use lens cap when projector is in operation.
- When the lamp reaches the end of its life, it will burn out and may make a loud popping sound. If this happens, the projector will not turn back on until the lamp module has been replaced. To replace the lamp, follow the procedures listed under "Replacing the Lamp".

Table of Contents

Table of Contents	1	SETUP Advanced	62
Introduction	2	OPTIONS	63
Package Overview	2	OPTIONS Lamp Settings	67
Product Overview	3	OPTIONS Advanced	69
Main Unit	3	OPTIONS Remote Settings	71
Control Panel	4	OPTIONS Filter Settings	72
Input/Output Connections	5	OPTIONS Filter Settings	73
Remote Control	6	Appendices	74
Installation	7	Troubleshooting	74
Connecting to the Projector	7	Image Problems	74
Connecting a Computer/Notebook	7	Other Problems	76
Connecting a Video source	8	Remote Control Problems	76
Connect to 3D Video Devices	9	LED Lighting Messages	77
Using the 3D glasses	11	On Screen Messages	78
Powering On/Off the Projector	12	Replacing the Lamp	79
Powering On the Projector	12	Installing and Cleaning the	
Powering Off the Projector	13	Dust Filter	81
Warning Indicator	14	Compatibility Modes	82
Adjusting the Projected Image	15	Ceiling Mount Installation	84
Adjusting the Projector's Height	15	Regulations and safety notices	85
Adjusting the Projector's Focus	16		
Adjusting Projection Image Size	16		
User Controls	19		
Control Panel & Remote Control	19		
Control Panel	19		
Remote Control	20		
On-screen Display Menus	23		
How to operate	23		
IMAGE	24		
IMAGE Advanced	27		
DISPLAY	32		
DISPLAY 3D	37		
SETUP	39		
SETUP Audio Settings	42		
SETUP Security	44		
SETUP Network	46		
SETUP Network LAN Settings	47		
SETUP Network Control Settings	49		
SETUP Signal (RGB)	59		
SETUP Signal (Video)	61		

Introduction

Package Overview

Unpack and inspect the box contents to ensure all parts listed below are in the box. If something is missing, please contact Acer customer service.

Standard Accessories

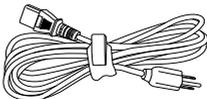
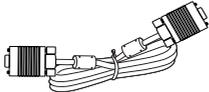
		
Projector	Power Cord	Remote
		<input checked="" type="checkbox"/> CD User Manual <input checked="" type="checkbox"/> Warranty Card <input checked="" type="checkbox"/> Quick Start Guide
VGA Cable	2 × AAA Batteries	Documentation

Product Overview

Main Unit

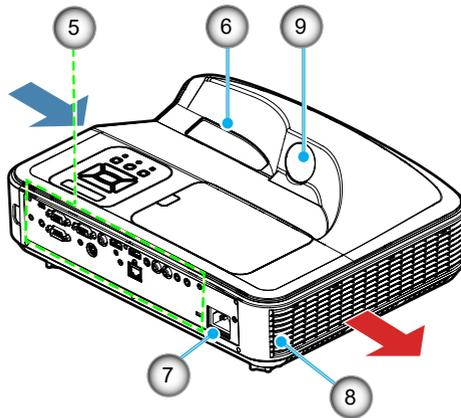
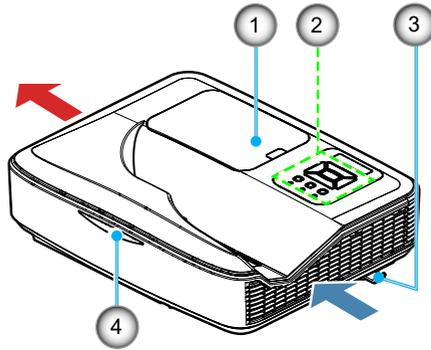

- ❖ Do not block projector in/out air vents.

- | | |
|-----------------------------|---|
| 1. Lamp Cover | 6. Lens |
| 2. Control Panel | 7. Power Socket |
| 3. Focus Switch | 8. Speaker |
| 4. IR Receiver | 9. IR Camera (Only for interactive version) |
| 5. Input/Output Connections | |

Introduction

Control Panel

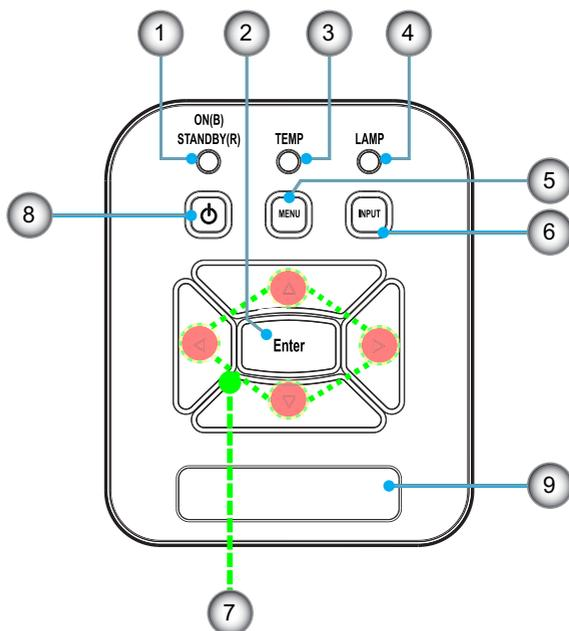

1. ON/STANDBY LED
2. Enter
3. TEMP LED
4. LAMP LED
5. Menu
6. Input
7. Four Directional Select Keys
8. Power/Standby button
9. IR Receiver

Introduction

Input/Output Connections

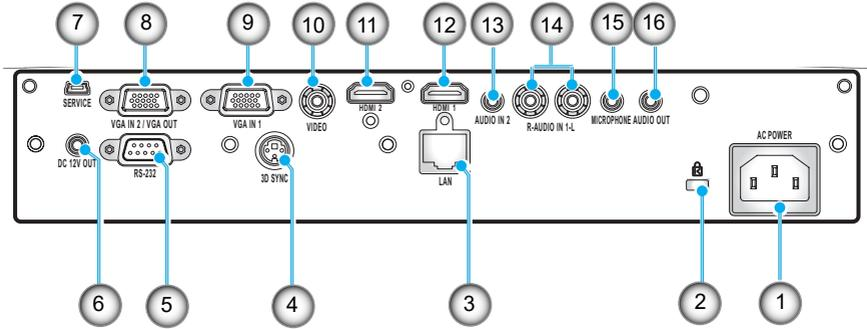

1. Power Socket
2. Kensington™ Lock Port
3. RJ45 Connector
4. 3D Sync Connector (5V)
5. RS-232C Connector (9-pin DIN Type)
6. 12V Out Connector
7. USB Connector (Connect to PC for Remote Mouse function)
8. VGA-Out/VGA2-In Connector
9. VGA1-In/YPbPr Connector (PC Analog Signal/Component Video Input/HDTV/YPbPr)
10. Composite Video Input Connector
11. HDMI2 Input Connector
12. HDMI1 Input Connector
13. Audio 2 In Connector (3.5mm mini Jack)
14. Composite Audio Input (right/left) Connector
15. Audio Input Connector (microphone)
16. Audio Output Connector (3.5mm mini Jack)



❖ Remote mouse requires special remote.

Introduction

Remote Control



❖ Some keys may have no function for models which do not support these features.

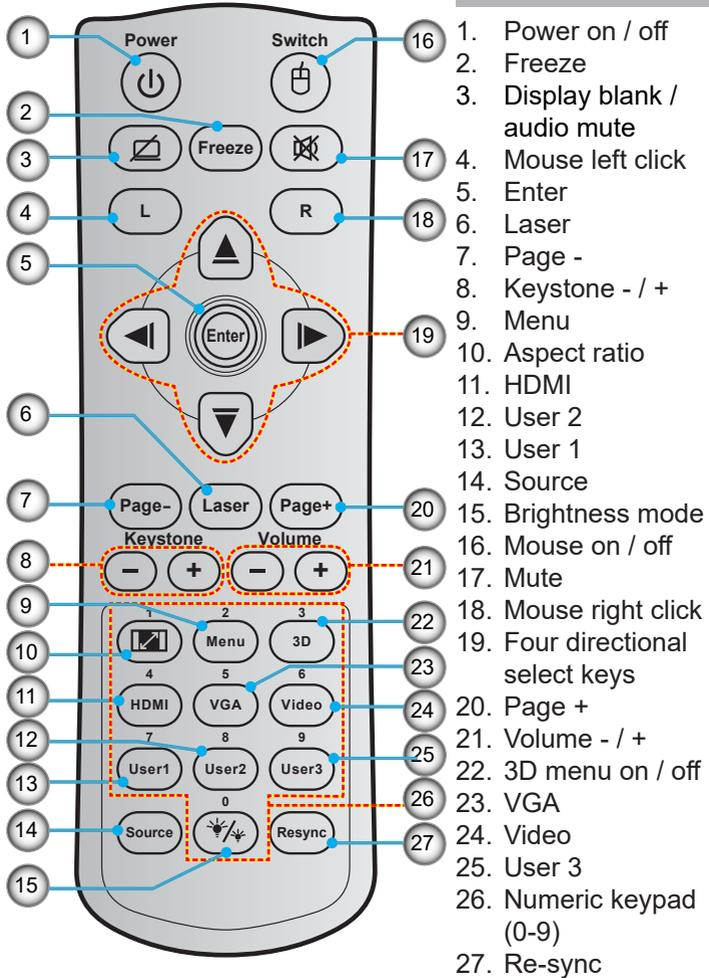

Installation

Connecting to the Projector

Connecting a Computer/Notebook

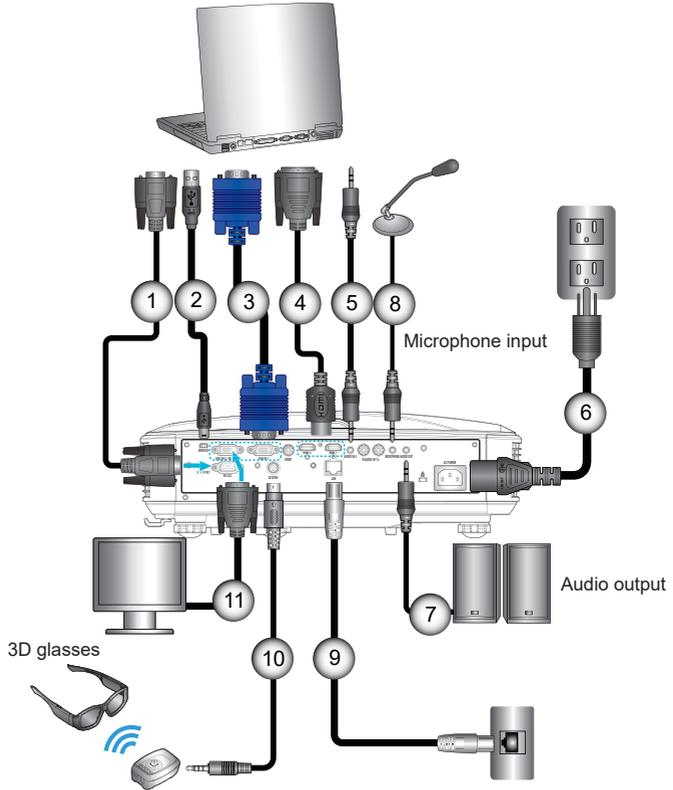

- ❖ Due to the difference in applications for each country, some regions may have different accessories.
- ❖ (*) Optional accessory

1.....	*RS-232C cable
2.....	*Remote Mouse USB cable
3.....	VGA1-In/YPbPr cable
4.....	*HDMI cable
5.....	*Audio 2 In cable
6.....	Power cord
7.....	*Audio Out cable
8.....	*Microphone In cable
9.....	*RJ-45 cable
10.....	*3D emitter cable
11.....	*VGA-Out/VGA2-In cable

Installation

Connecting a Video source

DVD player, Blu-ray player, Set-top box, HDTV receiver, Games console

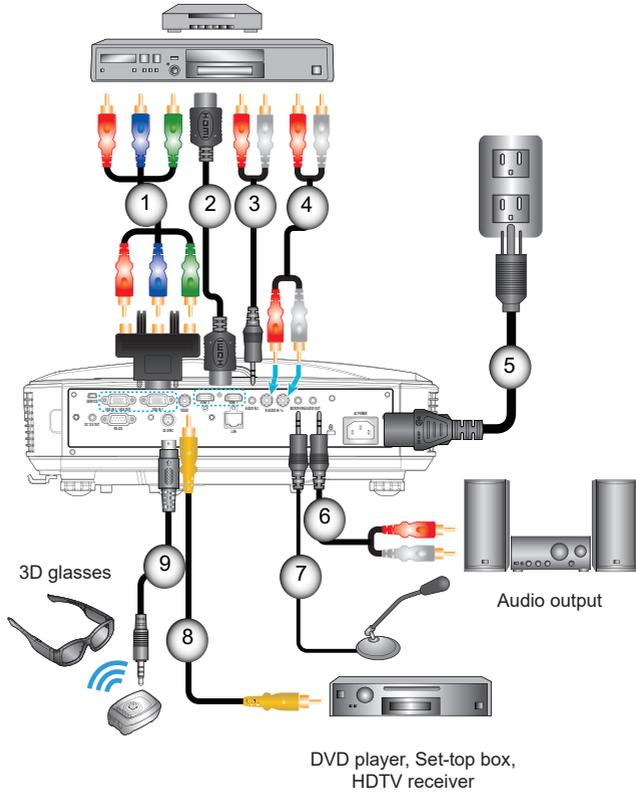

- ❖ Due to the difference in applications for each country, some regions may have different accessories.
- ❖ (*) Optional accessory

1.....	*3 RCA Component cable
2.....	*HDMI cable
3.....	*Audio2 In cable
4.....	*Audio In cable
5.....	Power cord
6.....	*Audio Out cable
7.....	*Microphone In cable
8.....	*Video cable
9.....	*3D emitter cable

Connect to 3D Video Devices



- ❖ The 3D video source device must be powered on before the 3D projector.

Once you have connected your devices together with HDMI cables, as shown in the diagram, you are ready to begin. Power ON your 3D video source and your 3D projector.

PlayStation® 3 Games

- Make sure that you have updated your console to the latest software version.
- Go to the “Settings menu -> Display settings -> Video output -> HDMI”. Select “Automatic” and follow the on-screen instructions.
- Insert your 3D game disc. Alternatively you can download games (and 3D updates) via the PlayStation® network.
- Launch the game. In the in-game menu, select “Play in 3D”.

Blu-ray 3D™ Player

- Make sure that your player can support 3D Blu-ray™ disc and that 3D output is enabled.
- Insert the 3D Blu-ray™ disc into the player, press “Play”.

3D TV (e.g. SKY 3D, DirectTV)

- Contact your TV service provider to enable any 3D channels on your channel package.
- Once enabled, switch to the 3D channel.
- You should see two images side-by-side.
- Switch to the “SBS” of the 3D projector. The option is located in the “DISPLAY” section of the projector OSD menu.

3D Device (e.g. 3D DV/DC) with 2D 1080i side by side signal output

- Connect your 3D device and switch to out 3D content with 2D side-by-side output to 3D Projector.
 - You should see two images side-by-side.
- Switch to the “SBS” of the 3D projector. The option is located in the “DISPLAY” section of the projector OSD menu.

If watching 3D content from an HDMI 1.4a source (e.g. 3D Blu-ray) your 3D glasses should always be in sync. If watching 3D content from an HDMI 1.3 source (e.g. 3D broadcast using SBS mode) it may be necessary to use the projector’s 3D Sync-Invert option to optimize your 3D experience. The option is located in the “DISPLAY ->3D” section of the projector OSD menu.



- ❖ If input video is normal 2D, please press “3D Format” and switch to “Auto”.
- ❖ If “SBS” is active, 2D video content will not display correctly.

Installation

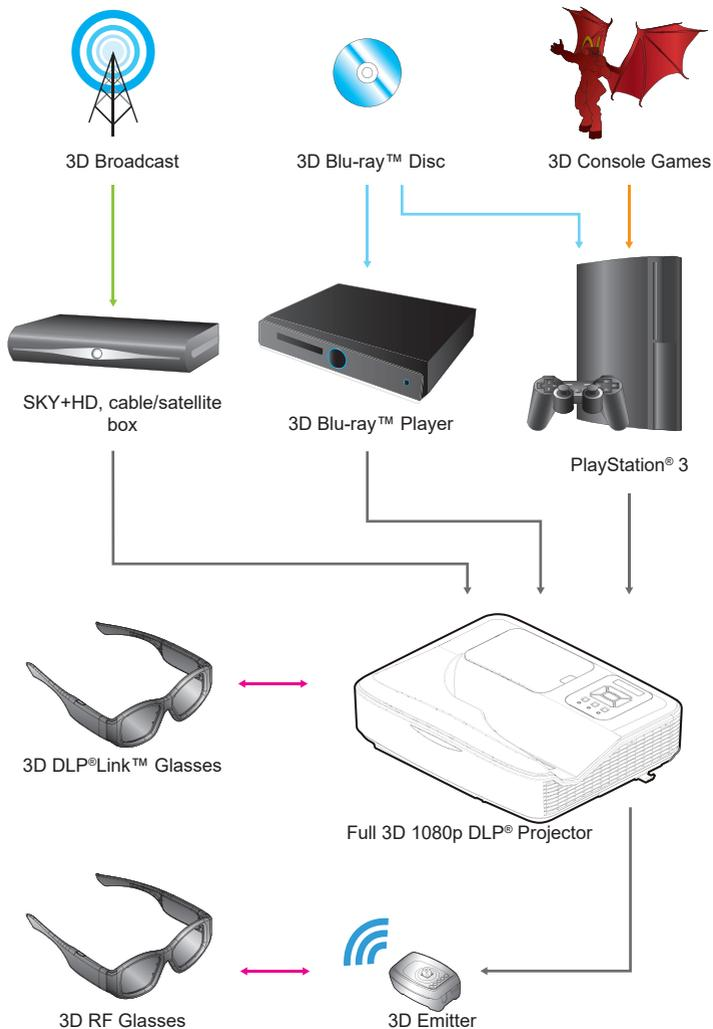



❖ For more detailed information, please refer to 3D glasses user's guide.

Using the 3D glasses

1. To turn ON 3D glasses.
2. Verify that 3D content is being sent to the projector and signal is compatible with projector specifications.
3. Turn on the "3D Mode" (Off/ DLP-Link/ VESA 3D - depending on which type of glasses you are using) of the 3D projector. The option is located in the "3D" section of the projector OSD menu.
4. Turn on 3D glasses and verify image appears in 3D without eyestrain.
5. If the image does not appear in 3D, please check 3D device set up correctly to send out 3D image or not. Or "SBS" should turn on when input signal is 2D 1080i side-by-side and repeat previous steps 1 ~ 4.
6. It may be necessary to use projector's "3D Sync. Invert" option to optimize your 3D experience. The option is located in the "3D" section of the projector OSD menu.
7. To turn OFF 3D glasses: Press the "Power" button and hold until the LED switches off.
8. For more detailed information, please refer to the 3D glasses user's guide, or manufacturer's Website.

Powering On/Off the Projector

Powering On the Projector

1. Securely connect the power cord and signal cable. When connected, the On/Standby LED will turn Red.
2. Turn on the lamp by pressing “

The startup screen will display in approximately 10 seconds. The first time you use the projector, you will be asked to select the preferred language and power saving mode.

3. Turn on and connect the source that you want to display on the screen (computer, notebook, video player, etc). The projector will detect the source automatically. If not, push menu button and go to “OPTIONS”.
Make sure that the “Source Lock” has been set to “Off”.
- ❖ If you connect multiple sources at the same time, press the “Source” button on the Remote Control or direct source keys on the remote control to switch between inputs.



- ❖ Turn on the projector first and then select the signal sources.
- ❖ (*) Optional accessory.

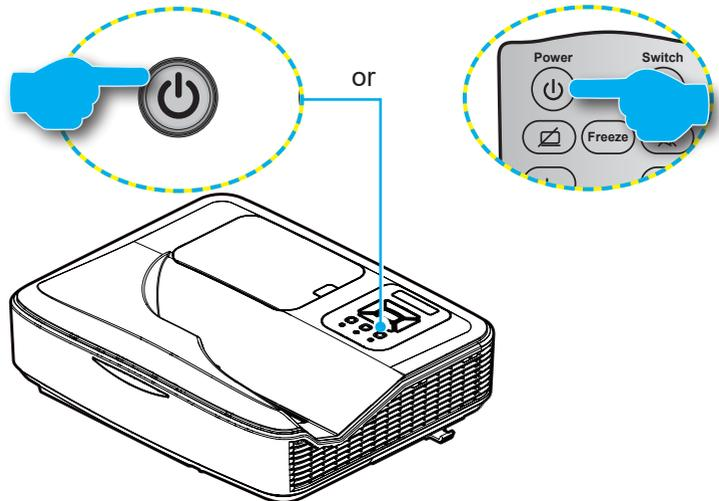

Powering Off the Projector

1. Press the “⏻” button on the remote control or on the Control Panel to turn off the projector. The following message will be displayed on the screen.



Press the “⏻” button again to confirm otherwise the message will disappear after 15 seconds. When you press the “⏻” button for the second time, the projector will shut down.

2. The cooling fans continue to operate for about 10 seconds for cooling cycle and the On/Standby LED will flash Blue. When the On/Standby LED lights solid Red, the projector has entered standby mode.

If you wish to turn the projector back on, you must wait until the projector has completed the cooling cycle and has entered standby mode. Once in standby mode, simply press “⏻” button to restart the projector.

3. Disconnect the power cord from the electrical outlet and the projector.
4. Do not turn on the projector immediately following a power off procedure.



- ❖ Contact the nearest service center if the projector displays these symptoms.

Warning Indicator

When the warning indicators (see below) come on, the projector will automatically shutdown:

- ❖ “LAMP” LED indicator is lit red and if “On/Standby” indicator flashes red.
- ❖ “TEMP” LED indicator is lit red and if “On/Standby” indicator flashes red. This indicates the projector has overheated. Under normal conditions, the projector can be switched back on.
- ❖ “TEMP” LED indicator flashes red and if “On/Standby” indicator flashes red.

Unplug the power cord from the projector, wait for 30 seconds and try again. If the warning indicator light up again, please contact your nearest service center for assistance.

Adjusting the Projected Image

Adjusting the Projector's Height

The projector is equipped with elevator feet for adjusting the image height.

1. Locate the adjustable foot you wish to modify on the underside of the projector.
2. Rotate the adjustable ring clockwise to raise the projector or counter clockwise to lower it. Repeat with the remaining feet as needed.

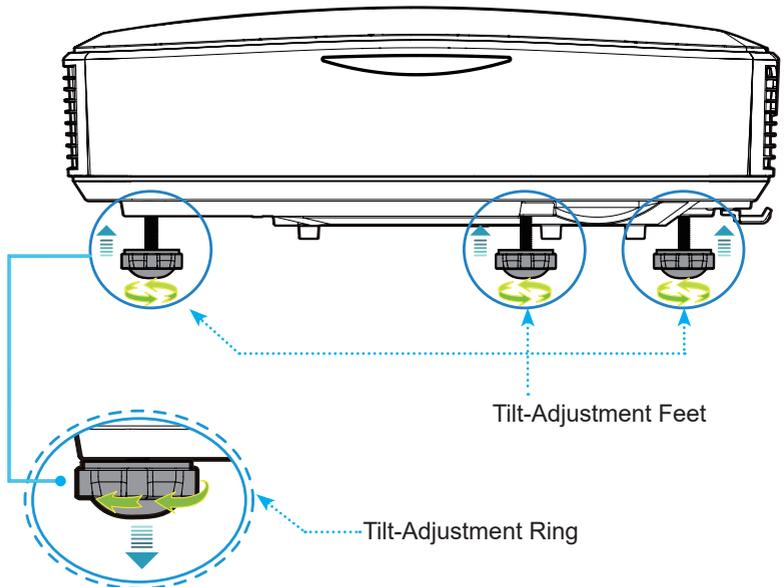

Adjusting the Projector's Focus

To focus the image, slide the focus switch until the image is clear.

- ▶ Standard throw series (XGA): The projector will focus at distances from 1.55 to 2.21 feet (0.47 to 0.68 meters) counted from the center of lens.
- ▶ Standard throw series (WXGA): The projector will focus at distances from 1.59 to 2.15 feet (0.49 to 0.66 meters) counted from the center of lens.
- ▶ Standard throw series (1080p): The projector will focus at distance from 1.46 to 1.83 feet (0.45 to 0.56 meters) counted from the center of lens.

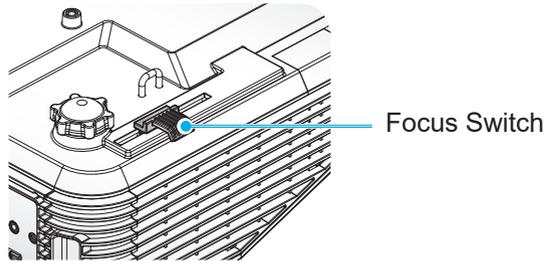

Adjusting Projection Image Size

- ▶ Projection Image Size (XGA) from 70"-100" (1.78 to 2.54 meters).
- ▶ Projection Image Size (WXGA) from 85"-115" (2.16 to 2.92 meters).
- ▶ Projection Image Size (1080p) from 80"-100" (2.03 to 2.54 meters).

Installation

Variables:

"a": Image Offset (m) from the center of the lens to the top of the vertical image.

"b": Distance from the center of the lens to the bottom of the projector.

"c": Distance between the wall (projection surface) to the back of the projector.

"d": Image Diagonal.

"g": Distance between the center of the lens and wall (projection surface).

"m": Distance between the wall (projection surface) and the front of the projector.

"p": Distance from top of projector to the mounting hole.

"H": Height of the Image.

"W": Width of the image.

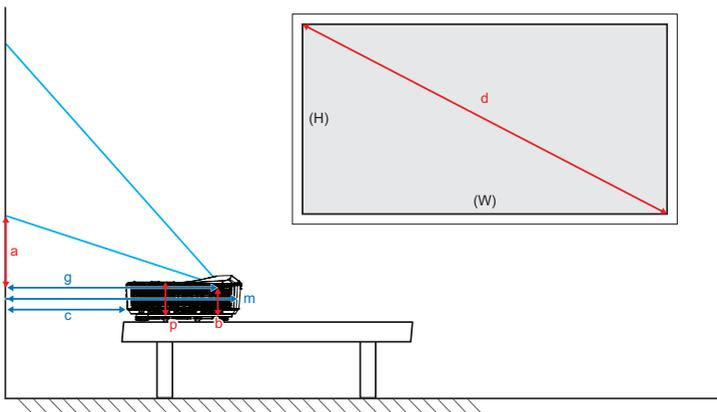
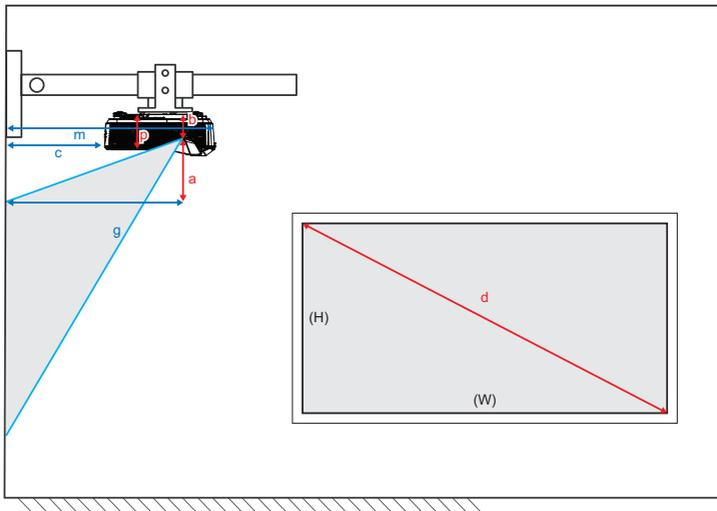

Installation

Standard throw XGA (4:3)

a	b	c	d	W		H		g		m	P
				Width of Image Size		Height of Image Size		Distance between the center of lens and wall (projection surface)			
				(inch)	(m)	(inch)	(m)	(feet)	(m)		
0.181	0.0631	0.219	70	56.0	1.42	42.0	1.07	1.55	0.47	0.253	0.115
0.192	0.0631	0.246	74	59.2	1.50	44.4	1.13	1.64	0.50	0.253	0.115
0.207	0.0631	0.287	80	64.0	1.63	48.0	1.22	1.77	0.54	0.253	0.115
0.233	0.0631	0.354	90	72.0	1.83	54.0	1.37	1.99	0.61	0.253	0.115
0.259	0.0631	0.422	100	80.0	2.03	60.0	1.52	2.21	0.68	0.253	0.115

Standard throw WXGA (16:10)

a	b	c	d	W		H		g		m	P
				Width of Image Size		Height of Image Size		Distance between the center of lens and wall (projection surface)			
				(inch)	(m)	(inch)	(m)	(feet)	(m)		
0.172	0.0631	0.232	85	72.1	1.83	45.0	1.14	1.59	0.49	0.253	0.115
0.176	0.0631	0.245	87	74.0	1.88	46.2	1.17	1.63	0.50	0.253	0.115
0.182	0.0631	0.261	90	76.4	1.94	47.7	1.21	1.69	0.51	0.253	0.115
0.202	0.0631	0.318	100	84.8	2.15	53.0	1.35	1.87	0.57	0.253	0.115
0.222	0.0631	0.375	110	93.3	2.37	58.3	1.48	2.06	0.63	0.253	0.115
0.232	0.0631	0.403	115	97.5	2.48	60.9	1.55	2.15	0.66	0.253	0.115

Standard throw 1080p (16:9)

a	b	c	d	W		H		g		m	P
				Width of Image Size		Height of Image Size		Distance between the center of lens and wall (projection surface)			
				(inch)	(m)	(inch)	(m)	(feet)	(m)		
0.179	0.0631	0.193	80	69.7	1.77	39.2	1.00	1.46	0.45	0.253	0.115
0.200	0.0631	0.244	89	77.6	1.97	43.7	1.11	1.63	0.50	0.253	0.115
0.202	0.0631	0.249	90	78.4	1.99	44.1	1.12	1.65	0.50	0.253	0.115
0.224	0.0631	0.305	100	87.2	2.21	49.0	1.25	1.83	0.56	0.253	0.115

❖ These tables are for user's reference only.

Control Panel & Remote Control

Control Panel

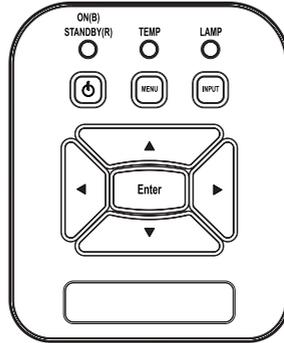

Using the Control Panel

POWER		Refer to the “Power On/Off the Projector” section on pages 12-13.
Enter		Confirm your item selection.
INPUT		Press “INPUT” to select an input source.
MENU		Press “MENU” to launch the on-screen display (OSD) menu. To exit OSD, press “MENU” again.
Four Directional Select Keys		Use ▲ ▼ ◀ ▶ to select items or make adjustments to your selection.
LAMP LED		Indicate the projector’s lamp status.
TEMP LED		Indicate the projector’s temperature status.
ON/STANDBY LED		Indicate the projector’s status.

User Controls

Remote Control

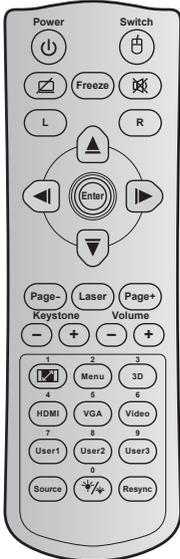

Using the Remote Control

Power		Press to turn on / off the projector.
Switch		Press to switch the USB mouse on / off.
Display blank/ audio mute		Press to hide / unhide the screen picture and turn off / on audio.
Freeze		Press to freeze the projector image.
Mute		Press to momentarily turn off / on the audio.
Mouse left click	L	Use as mouse left click.
Mouse right click	R	Use as mouse right click.
Four directional select keys		Use to select items or make adjustments to your selection.
Enter		Confirm your item selection.
Page -		Press to page down.
Laser		Use as laser pointer.
Page +		Press to page up.
Keystone		Press to adjust image distortion caused by tilting the projector.
Volume		Press to adjust to increase / decrease the volume.
Aspect ratio / 1		<ul style="list-style-type: none"> ▶ Press to change aspect ratio of a displayed image. ▶ Use as numeric keypad number "1".
Menu / 2		<ul style="list-style-type: none"> ▶ Press to display or exit the on-screen display menus for projector. ▶ Use as numeric keypad number "2".
3D / 3		<ul style="list-style-type: none"> ▶ Press to manually select a 3D mode that matches your 3D content. ▶ Use as numeric keypad number "3".



User Controls

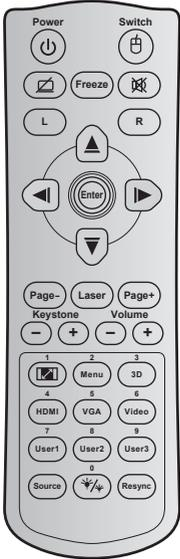

Using the Remote Control

HDMI / 4		<ul style="list-style-type: none"> ▶ Press to choose HDMI source. ▶ Use as numeric keypad number “4”.
VGA / 5		<ul style="list-style-type: none"> ▶ Press to choose VGA source. ▶ Use as numeric keypad number “5”.
Video / 6		<ul style="list-style-type: none"> ▶ Press to choose composite video source. ▶ Use as numeric keypad number “6”.
User1 / 7; User2 / 8; User3 / 9		<ul style="list-style-type: none"> ▶ User defined keys. ▶ Use as numeric keypad numbers “7”, “8”, and “9” accordingly.
Source		Press to select an input signal.
Brightness mode / 0		<ul style="list-style-type: none"> ▶ Press to automatically adjust the picture brightness to give an optimum contrast performance. ▶ Use as numeric keypad number “0”.
Resync		Press to automatically synchronize the projector to the input source.

User Controls

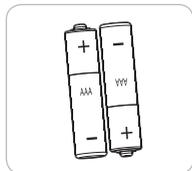

Installing Batteries

Two size AAA batteries are supplied for Remote Control.

Replace only with the same or equivalent type recommended by the manufacturer.



CAUTION

Improper use of batteries can result in chemical leakage or explosion. Be sure to follow the instructions below.

Do not mix batteries of different types. Different types of batteries have different characteristics.

Do not mix old and new batteries. Mixing old and new batteries can shorten the life of new batteries or cause chemical leakage in old batteries.

Remove batteries as soon as they are worn out. Chemicals that leak from batteries that come in contact with skin can cause a rash. If you find any chemical leakage, wipe thoroughly with a cloth.

The batteries supplied with this product may have a shorter life expectancy due to storage conditions.

If you will not be using the remote control unit for an extended period of time, remove batteries from it.

When you dispose of the battery, you must obey the law in the relative area or country.

On-screen Display Menus

The Projector has multilingual On-screen Display menus that allow you to make image adjustments and change a variety of settings. The projector will automatically detect the source.

How to operate

1. To open the OSD menu, press “Menu” on the Remote Control or Control Panel.
2. When OSD is displayed, use ◀▶ keys to select any item in the main menu. While making a selection on a particular page, press ▼ or “Enter” key to enter sub menu.
3. Use ▲▼ keys to select the desired item in the sub menu and then press ▶ or “Enter” key to view further settings. Adjust the settings by ◀▶ key.
4. Select the next item to be adjusted in the sub menu and adjust as described above.
5. Press “Enter” or “Menu” to confirm, and the screen will return to the main menu.
6. To exit, press “Menu” again. The OSD menu will close and the projector will automatically save the new settings.

NOTE

- ❖ Some of the following OSD settings may not be available. Please refer to the actual OSD of your projector.
- ❖ Functions vary depending on model definition.

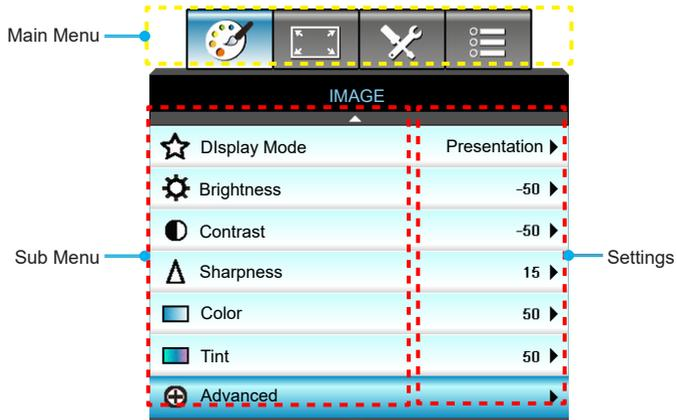

IMAGE



Display Mode

There are many factory presets optimized for various types of images.

- ▶ Presentation: This mode is suitable for showing in front of public in connection to the PC.
- ▶ Bright: Maximum brightness from PC input.
- ▶ Movie: This mode is suitable for watching video.
- ▶ User: Memorize user's settings.
- ▶ Blackboard: This mode should be selected to achieve optimum color settings when projecting onto a blackboard (green).
- ▶ DICOM SIM.: This mode can project a monochrome medical image such as an X ray radiography, MRI, etc.
- ▶ Standard Mode: Standardized accurate color.
- ▶ 3D: To experience the 3D effect, you need to have 3D glasses, make sure your PC/portable device has a 120 Hz signal output quad buffered graphics card and have a 3D Player installed.

User Controls

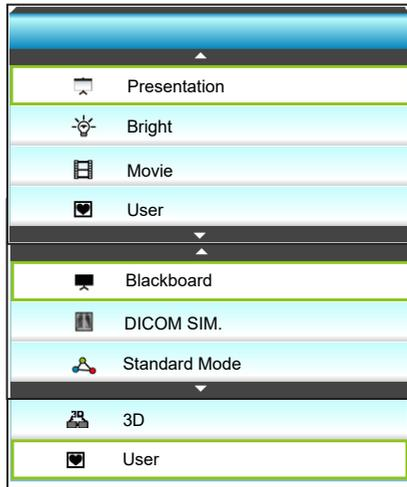

Brightness

Adjust the brightness of the image.

- ▶ Press the ◀ to darken image.
- ▶ Press the ▶ to lighten the image.



Contrast

The contrast controls the degree of difference between the lightest and darkest parts of the picture.

- ▶ Press the ◀ to decrease the contrast.
- ▶ Press the ▶ to increase the contrast.



User Controls

Sharpness

Adjust the sharpness of the image.

- ▶ Press the ◀ to decrease the sharpness.
- ▶ Press the ▶ to increase the sharpness.



Color

Adjust a video image from black and white to fully saturated color.

- ▶ Press the ◀ to decrease the amount of saturation in the image.
- ▶ Press the ▶ to increase the amount of saturation in the image.



Tint

Adjust the color balance of red and green.

- ▶ Press the ◀ to increase the amount of green in the image.
- ▶ Press the ▶ to increase the amount of red in the image.



Reset

Choose "Yes" to return the factory default settings for "IMAGE".

Exit

Choose "Exit" to exit the menu.

IMAGE | Advanced

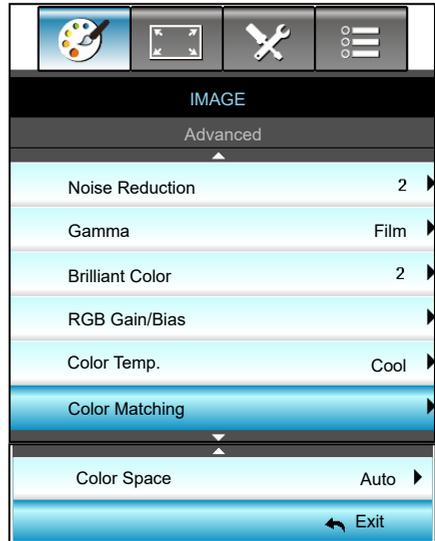

Noise Reduction

Selects a filter sensitivity to noise. A higher value may improve noisy sources, but it will soften the image.

- ▶ Press the ◀ to decrease the noise in the image.
- ▶ Press the ▶ to increase the noise in the image.



Gamma

This allows you to set up gamma curve type. After the initial setup and fine tuning is completed, utilize the Gamma Adjustment steps to optimize your image output.

- ▶ Film: for home theater.
- ▶ Graphic: for PC / Photo source.
- ▶ Blackboard: This mode should be selected to achieve optimum color settings when projecting onto a blackboard (green).
- ▶ DICOM SIM.: This mode can project a monochrome medical image such as an X ray radiography, MRI, etc.
- ▶ 1.8/2.0/2.2/2.6: For specific PC / Photo source.
- ▶ 3D: for 3D mode.

Press the ◀ or ▶ to select the mode.



User Controls

Brilliant Color™

This adjustable item utilizes a new color-processing algorithm and enhancements to enable higher brightness while providing true, more vibrant colors in picture.

- ▶ Press the ◀ to stronger enhance the image.
- ▶ Press the ▶ to less enhance the image.



RGB Gain/Bias

This settings allows to configure the brightness (gain) and contrast (bias) of an image.

- ▶ Press the ◀ to decrease a chosen color gain and bias.
- ▶ Press the ▶ to increase a chosen color gain and bias.



Color Temp.

Press the ◀ or ▶ to select a color temperature from Standard, Cool and Cold.



User Controls

Color Matching

Press the ► into the next menu and then use ▲ or ▼ or ◀ or ▶ to select the item.



- ▶ Red: Press the ▲ or ▼ to select Hue, Saturation and Gain Colors. Then press the ◀ or ▶ to decrease or increase the value respectively.



- ▶ Cyan: Press the ▲ or ▼ to select Hue, Saturation and Gain Colors. Then press the ◀ or ▶ to decrease or increase the value respectively.



User Controls

- ▶ Green: Press the ▲ or ▼ to select Hue, Saturation and Gain Colors. Then press the ◀ or ▶ to decrease or increase the value respectively.



- ▶ Magenta: Press the ▲ or ▼ to select Hue, Saturation and Gain Colors. Then press the ◀ or ▶ to decrease or increase the value respectively.

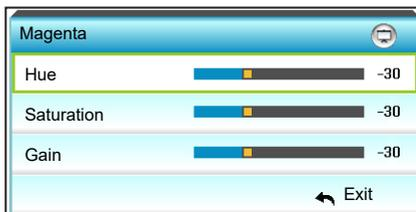

- ▶ Blue: Press the ▲ or ▼ to select Hue, Saturation and Gain Colors. Then press the ◀ or ▶ to decrease or increase the value respectively.

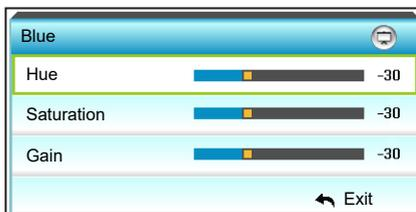

- ▶ Yellow: Press the ▲ or ▼ to select Hue, Saturation and Gain Colors. Then press the ◀ or ▶ to decrease or increase the value respectively.



User Controls

- ▶ White: Press the ▲ or ▼ to select Hue, Saturation and Gain Colors. Then press the ◀ or ▶ to decrease or increase the value respectively.



- ▶ Reset: Choose "Reset" to return the factory default settings for color adjustments.

Color Space

Press the ◀ or ▶ to select an appropriate color matrix type from the following:

- ▶ Non-HDMI Input: Auto, RGB or YUV
- ▶ HDMI Input: Auto, RGB(0-255), RGB(16-235) or YUV.

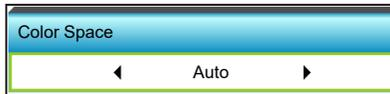

Exit

Choose "Exit" to exit the menu.

DISPLAY



Format

Press the ◀ or ▶ to choose your desired aspect ratio between 4:3, 16:9/16:10 (WXGA), LBX, Native, and Auto.



XGA

- ▶ 4:3: This format is for 4:3 input sources.
- ▶ 16:9: This format is for 16:9 input sources, like HDTV and DVD enhanced for Wide screen TV.
- ▶ Native: This format displays the original image without any scaling.
- ▶ Auto: Automatically selects the appropriate display format.

Source	480i/p	576i/p	1080i/p	720p
4:3	Scale to 1024 x 768			
16:9	Scale to 1024 x 576			
Native	No scaling will be made; the resolution is dependent on which input source and is then displayed.			
Auto	<ul style="list-style-type: none"> ▶ If source is 4:3, it will be auto resized to 1024 x 768 ▶ If source is 16:9, it will be auto resized to 1024 x 576 ▶ If source is 15:9, it will be auto resized to 1024 x 614 ▶ If the source is 16:10, it will be auto resized to 1024 x 640 			

User Controls

WXGA

- ▶ 4:3: This format is for 4:3 input sources.
- ▶ 16:9: This format is for 16:9 input sources, like HDTV and DVD enhanced for Wide screen TV.
- ▶ 16:10: This format is for 16:10 input sources, like widescreen laptops.
- ▶ LBX: This format is for non-16x9, letterbox source and for users who use external 16x9 lens to display 2.35:1 aspect ratio using full resolution.
- ▶ Native: This format displays the original image without any scaling.
- ▶ Auto: Automatically selects the appropriate display format.

Detail informations about LBX mode:

1. Some Letter-Box Format DVDs are not enhanced for 16x9 TVs. In this situation, the image will not look right when displayed in 16:9 mode. In this situation, please try to using the 4:3 mode to view the DVD. If the content is not 4:3, there will be black bars around the image in 16:9 display. For this type of content, you can use LBX mode to fill the image on the 16:9 display.
2. If you use an external anamorphic lens, this LBX mode also allows you to watch a 2.35:1 content (include Anamorphic DVD and HDTV film source) that support anamorphic wide is enhanced for 16x9 Display in a wide 2.35:1 image. In this case, there are no black bars. Lamp power and vertical resolution are fully utilized.

16:9 Screen	480i/p	576i/p	1080i/p	720p	PC
4:3	Scale to 960 x 720				
16:9	Scale to 1280 x 720				
LBX	Scale to 1280 x 960, in order to get the central 1280 x 720 image displayed on the screen.				
Native	1:1 mapping centered	1:1 mapping display 1280 x 720	1280 x 720 centered	1:1 mapping centered	
Auto	<ul style="list-style-type: none">▶ If this format is selected, the screen type will automatically set to 16:9 (1280 x 720)▶ If source is 4:3, it will be auto resized to 960 x 720▶ If source is 16:9, it will be auto resized to 1280 x 720▶ If source is 15:9, it will be auto resized to 1200 x 720▶ If the source is 16:10, it will be auto resized to 1152 x 720				

User Controls

16:10 Screen	480i/p	576i/p	1080i/p	720p	PC
4:3	Scale to 1066 x 800				
16:10	Scale to 1280 x 800				
LBX	Scale to 1280 x 960, in order to get the central 1280 x 800 image displayed on the screen.				
Native	1:1 mapping centered		1:1 mapping display 1280 x 800	1280 x 720 centered	1:1 mapping centered
Auto	<ul style="list-style-type: none"> ▶ Input source will be fit into 1280x800 display area and be kept its original aspect ratio ▶ If source is 4:3, auto resize to 1066 x 800 ▶ If source is 16:9 auto resize to 1280 x 720 ▶ If source is 15:9 auto resize to 1280 x 768 ▶ If source is 16:10 auto resize to 1280 x 800 				

1080P

- ▶ 4:3: This format is for 4:3 input sources.
- ▶ 16:10: This format is for 16:10 input sources, like widescreen laptops.
- ▶ LBX: This format is for non-16x9, letterbox source and for users who use external 16x9 lens to display 2.35:1 aspect ratio using full resolution.
- ▶ Native: This format displays the original image without any scaling.
- ▶ Auto: Automatically selects the appropriate display format.

16:9 Screen	480i/p	576i/p	1080i/p	720p	PC
4:3	Scale to 1440 x 1080				
16:10	Scale to 1920x1080				
LBX	Scale to 1920 x 1440, in order to get the central 1920 x 1080 image displayed on the screen.				
Native	1:1 mapping centered No scaling will be made; the resolution is dependent on which input source and is then displayed.				
Auto	<ul style="list-style-type: none"> ▶ If this format is selected, the screen type will automatically become 16:9 ▶ If source is 4:3, auto resize to 1440 x 1080 ▶ If source is 16:9 auto resize to 1920 x 1080 ▶ If source is 16:10 auto resize to 1920 x 1200 and cut to 1920 x x1080 area display 				

User Controls

Zoom

- ▶ Press the ◀ to reduce the size of an image.
- ▶ Press the ▶ to magnify an image on the projection screen.

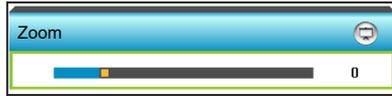

Edge Mask

Edge mask the image to remove video encoding noise on the edge of video source.

- ▶ Press the ◀ to decrease the edge mask in image.
- ▶ Press the ▶ to increase the edge mask in image.



- ❖ Each I/O has different setting of "Edge Mask".
- ❖ "Edge Mask" and "Zoom" can't work at same time.

Image Shift

Press the ▶ into the next menu as below and then press the ▲ or ▼ or ◀ or ▶ to select item.

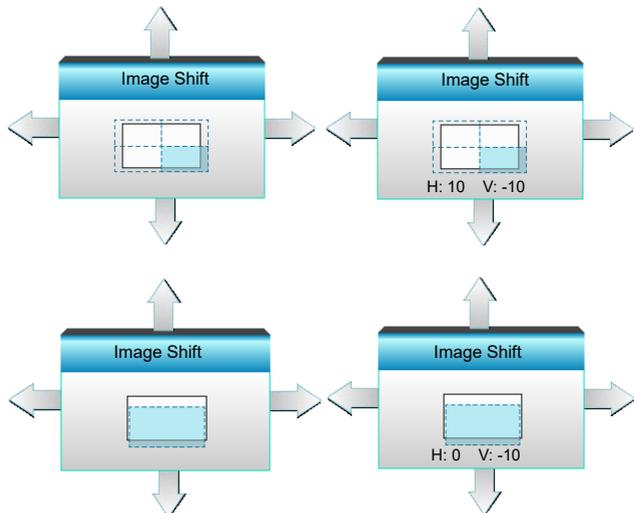

- ▶ H: Press the ◀▶ to shift the projected image position horizontally.
- ▶ V: Press the ▲▼ to shift the projected image position vertically.

User Controls

V. Keystone

Press the ◀ or ▶ to adjust image distortion vertically and make a squarer image.

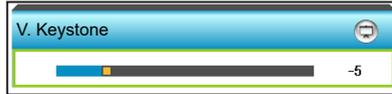

Exit

Choose "Exit" to exit the menu.

DISPLAY | 3D

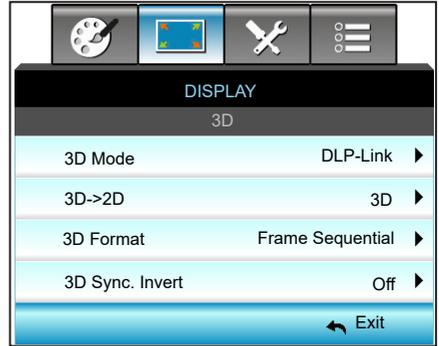

3D Mode

- ▶ Off: Select "Off" to turn off 3D mode.
- ▶ Press the ◀ or ▶ to select the 3D mode.



- ❖ 3D Format is only supported on 3D Timing on page 82.
- ❖ "3D Format" is only supported on non-HDMI 1.4a 3D timing.



- ▶ DLP-Link: Select "DLP-Link" to use optimized settings for DLP Link 3D Glasses. (refer to page 11).
- ▶ VESA 3D: Select "VESA 3D" to use optimized setting for VESA 3D Glasses. (refer to page 11).

3D->2D

- ▶ Press the ◀ or ▶ to select 3D -> 2D.



- ▶ 3D: Display 3D signal.
- ▶ L (Left): Display the left frame of 3D content.
- ▶ R (Right): Display the right frame of 3D content.

User Controls

3D Format

- ▶ Press the ◀ or ▶ to select 3D format.

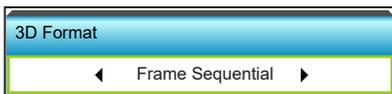

- ▶ Auto: When a 3D identification signal is detected, the 3D format is selected automatically.
- ▶ SBS: Display 3D signal in "Side-by-Side" format.
- ▶ Top and Bottom: Display 3D signal in "Top and Bottom" format.
- ▶ Frame Sequential: Display 3D signal in "Frame Sequential" format.

3D Sync. Invert

- ▶ Press the ◀ or ▶ to select 3D sync. invert.

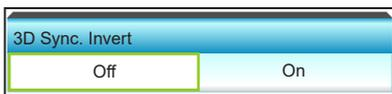

- ▶ Press the "On" to invert left and right frame contents.
- ▶ Press the "Off" for default frame contents.

Exit

Choose "Exit" to exit the menu.

SETUP



User Controls

Language

Choose the multilingual OSD menu. Press ► into the sub menu and then press the ▲ or ▼ or ◀ or ▶ key to select your preferred language. Press “Enter” to finalize the selection.

Language			
English	Nederlands	Čeština	Türkçe
Deutsch	Norsk/Dansk	عربي	فارسی
Français	Polski	繁體中文	Slovenský
Italiano	Русский	简体中文	Romanian
Español	Suomi	日本語	Slovakian
Português	ελληνικά	한국어	
Svenska	Magyar	ไทย	← Exit

Projection

Press the ▲ or ▼ or ◀ or ▶ key to select the preferred projection.



- ❖ Rear-Desktop and Rear-Ceiling are to be used with a translucent screen.



- ▶  Front-Projection
When selected, the image is projected straight on the screen.
- ▶  Rear-Desktop
When selected, the image will appear reversed.
- ▶  Front-Ceiling
This is the default selection. The image will turn upside down.
- ▶  Rear-Ceiling
When selected, the image will appear reversed in upside down position

User Controls

Menu Location

Press the ▲ or ▼ or ◀ or ▶ key to select the preferred menu location.



❖ *This screen type applies to WXGA only.

Screen Type

Press the ◀ or ▶ to choose the screen type from 16:10* or 16:9.



Exit

Choose "Exit" to exit the menu.

SETUP | Audio Settings



- ❖ "Mute" function affects both internal and external speaker volume.

Internal Speaker

Choose the "On" or "Off" to turn on or off the internal speaker.



Mute

- ▶ Choose the "On" to turn mute on.
- ▶ Choose the "Off" to turn mute off.



Volume

- ▶ Press the ◀ to decrease the volume.
- ▶ Press the ▶ to increase the volume.

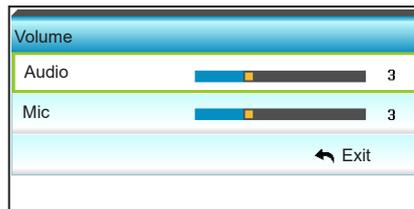

Audio Input

The default audio settings are on the back panel of the projector. Use this option to reassign any of the Audio Inputs (1 or 2) to the current image source. Each Audio input can be assigned to more than one video source.

- ▶ Press ◀ or ▶ to select audio input.



- ▶ Default.
- ▶ Audio 1: (RCA) for Composite
- ▶ Audio 2: (Mini jack) for VGA

Exit

Choose "Exit" to exit the menu.

SETUP | Security



Security

- ▶ On: Choose "On" to use security verification when the turning on the projector.
- ▶ Off: Choose "Off" to be able to switch on the projector without password verification.



Security Timer

Can be select the time (Month/Day/Hour) function to set the number of hours the projector can be used. Once this time has elapsed you will be requested to enter your password again.

Press the ◀ or ▶ to set the month, day, and hour.

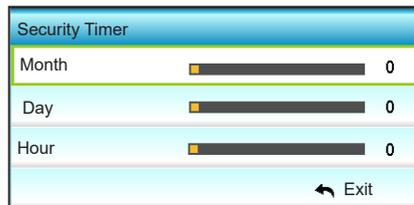



- ❖ Pass-code default value is "1234" (first time).

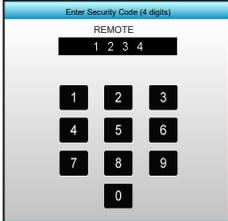

Change Password

- ▶ First time:
 1. Press "Enter" key to set the password.
 2. The password has to be 4 digits.
 3. Use number button on the remote or on-screen numeric keypad to enter your new password and then press "Enter" key to confirm your password.
- ▶ Change Password:

(If your remote does not have a number keypad, please use the up/down arrows to change each digit of the password, then press enter to confirm)

 1. Press "Enter" to input old password.
 2. Use number button or on-screen numeric keypad to enter current password and then press "Enter" to confirm.
 3. Enter new password (4 digits in length) using the number buttons on the remote, then press "Enter" to confirm.
 4. Enter new password again and press "Enter" to confirm.
 - ▶ If the incorrect password is entered 3 times, the projector will automatically shut down.
 - ▶ If you have forgotten your password, please contact your local office for support.

Exit

Choose "Exit" to exit the menu.

SETUP | Network



LAN Settings

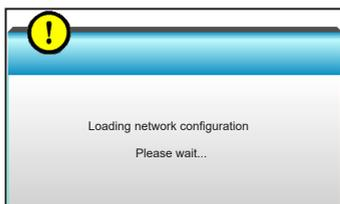

For more information on LAN Settings, refer to page 47-48, and 51-58.

Control Settings

For more information on Control Settings, refer to page 49-58.

SETUP | Network | LAN Settings

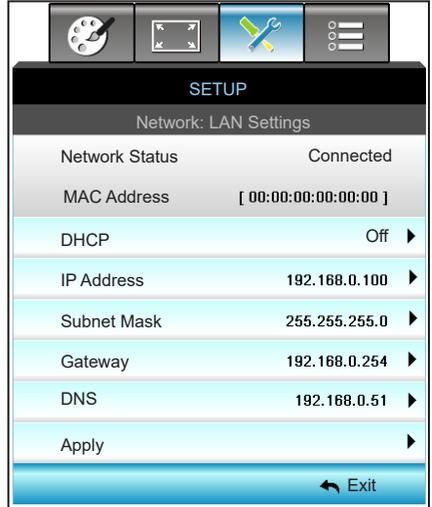

Network Status

Display the network connection status (read-only).

MAC Address

Display the MAC address (read-only).

DHCP

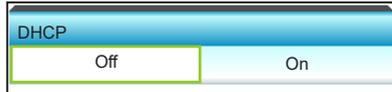

- ▶ On: Projector will obtain an IP address automatically from your network.
- ▶ Off: To assign IP, Subnet Mask, Gateway and DNS configuration manually.

Exiting OSD will automatically apply the entered values.

IP Address



Display the IP address.

User Controls

Subnet Mask



A dialog box titled "Subnet Mask" with a blue header. It contains four input fields, each with a value of "255.". The first field is highlighted with a green border and has up and down arrow icons above and below it.

Display subnet mask number.

Gateway

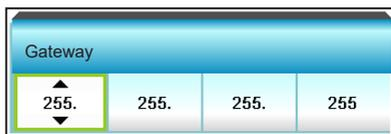

A dialog box titled "Gateway" with a blue header. It contains four input fields, each with a value of "255.". The first field is highlighted with a green border and has up and down arrow icons above and below it.

Display the default gateway of the network connected to the projector.

DNS

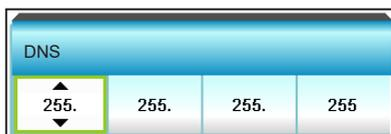

A dialog box titled "DNS" with a blue header. It contains four input fields, each with a value of "255.". The first field is highlighted with a green border and has up and down arrow icons above and below it.

Display DNS number.

Apply

Press ► and then choose "Yes" to apply the selection.



A dialog box titled "Apply" with a blue header. It contains two buttons: "No" and "Yes". The "No" button is highlighted with a green border.

Exit

Choose "Exit" to exit the menu.

SETUP | Network| Control Settings



Crestron

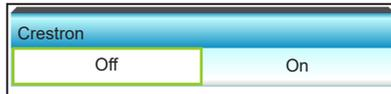

Use this function to select the network function (port: 41794). For more information, please visit <http://www.crestron.com> and www.crestron.com/getroomview.

- ▶ On: The Crestron function is active.
- ▶ Off: The Crestron function is inactive.

Extron

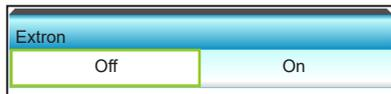

Use this function to select the network function (port: 2023).

- ▶ On: The Extron function is active.
- ▶ Off: The Extron function is inactive.

PJ Link

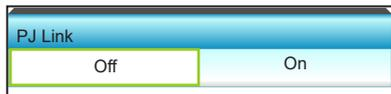

Use this function to select the network function (port: 4352).

- ▶ On: The PJ Link function is active.
- ▶ Off: The PJ Link function is inactive.

User Controls

AMX Device Discovery



Use this function to select the network function (port: 1023).

- ▶ On: The AMX Discovery function is active.
- ▶ Off: The AMX Discovery function is inactive.

Telnet



Use this function to select the network function (port: 23).

- ▶ On: Telnet is enabled.
- ▶ Off: Telnet is disabled.

Exit

Choose "Exit" to exit the menu.

LAN RJ45 Function



- ❖ Use Ethernet Normal Cable to connect the projector to LAN.

For simplicity and ease of operation, the projector provides diverse networking and remote management features. The LAN/RJ45 function of the projector through a network, such as remotely manage: Power On/Off, Brightness and Contrast settings. Also, projector status information, such as: Video-Source, Sound-Mute, etc.

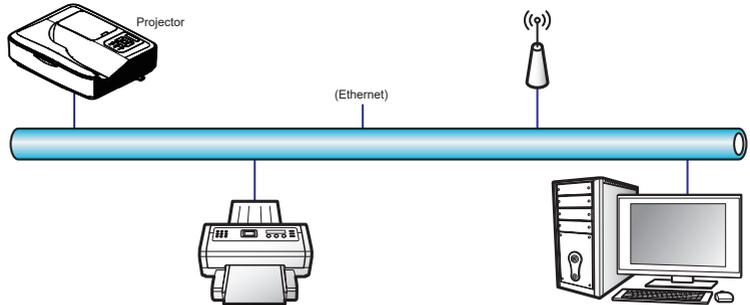

Wired LAN Terminal Functionalities

This projector can be controlled by using a PC (laptop) or other external device via LAN/RJ45 port and compatible with Crestron/ Extron / AMX (Device Discovery) / PJLink.

- ▶ Crestron is a registered trademark of Crestron Electronics, Inc. of the United States.
- ▶ Extron is a registered trademark of Extron Electronics, Inc. of the United States.
- ▶ AMX is a registered trademark of AMX LLC of the United States.
- ▶ PJLink applied for trademark and logo registration in Japan, the United States of America, and other countries by JBMIA.

The projector is supported by the specified commands of the Crestron Electronics controller and related software, for example RoomView®.

<http://www.crestron.com/>

This projector is compliant to support Extron device(s) for reference.

<http://www.extron.com/>

This projector is compliant to support Extron device(s) for reference.

<http://www.extron.com/>

This projector is supported by AMX (Device Discovery).

<http://www.amx.com/>

User Controls

This projector supports all commands of PJLink Class1 (Version 1.00).

<http://pjlink.jbmia.or.jp/english/>

For more detailed information about the various types of external devices which can be connected to the LAN/RJ45 port and remote/control the project, as well as the supported commands for these external devices, please contact the Support-Service directly.

LAN RJ45

1. Connect an RJ45 cable to RJ45 ports on the projector and the PC (laptop).

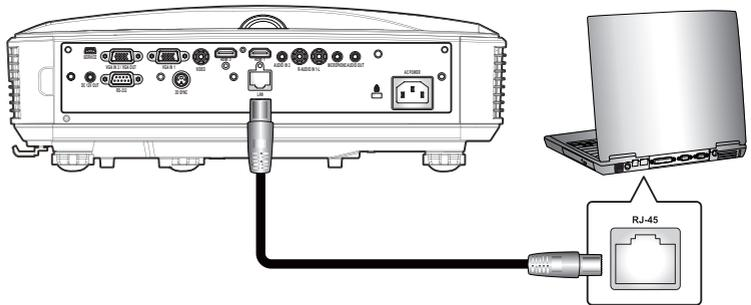

2. On the PC (Laptop), select Start > Control Panel > Network Connections.



User Controls

3. Right-click on the Local Area Connection, and select Property.

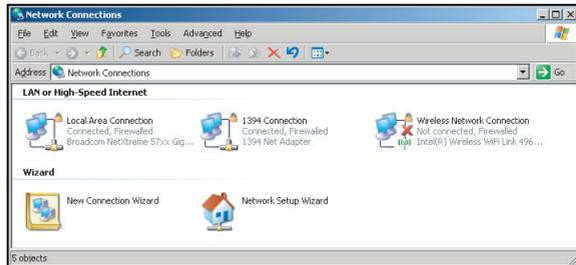

4. In the Properties window, select the General tab, and select Internet Protocol (TCP/IP).

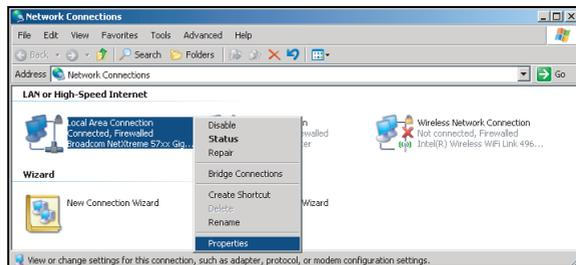

5. Click "Properties".

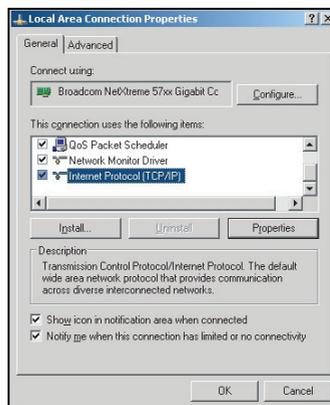

User Controls

6. Type in the IP address and Subnet mask, then press “OK”.



7. Press the “Menu” button on the projector.
8. Use ◀▶ keys to select SETUP > Network > LAN Settings.
9. After getting into LAN Settings, input the following connection parameters:
 - ▶ DHCP: Off
 - ▶ IP Address: 10.10.10.10
 - ▶ Subnet Mask: 255.255.255.255
 - ▶ Gateway: 0.0.0.0
 - ▶ DNS: 0.0.0.0
10. Press “Enter” to confirm settings.
11. Open a web browser, for example Microsoft Internet Explorer, with Adobe Flash Player 9.0 or higher installed.
12. In the Address bar, input the projector’s IP address: 10.10.10.10.

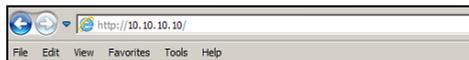

User Controls

13. Press "Enter".

The projector is setup for remote management. The LAN/RJ45 function displays as follows:

Main Page



Information Page



User Controls

Tool Page

The screenshot shows the Acer projector's web interface. At the top, there is a navigation bar with 'Tools', 'Info', and 'Contact IT Help' links. The main content area is divided into several sections:

- Crestron Control:** Includes fields for 'Ip Address' (192.168.1.7), 'IP ID' (7), and 'Port' (41784), with a 'Send' button below.
- Projector:** Includes fields for 'Projector Name' (Acer XGA), 'Location', and 'Assigned To' (Acer Projector), with a 'Send' button below.
- DHCP:** Includes a checkbox for 'Enabled' (checked), 'Ip Address' (192.168.0.100), 'Subnet Mask' (255.255.255.0), 'Default Gateway' (192.168.0.254), and 'DNS Server' (192.168.0.100), with a 'Send' button below.
- User Password:** Includes a checkbox for 'Enabled' (unchecked), 'New Password', and 'Confirm' fields, with a 'Send' button below.
- Admin Password:** Includes a checkbox for 'Enabled' (unchecked), 'New Password', and 'Confirm' fields, with a 'Send' button below.

At the bottom center, there is an 'exit' button.

Contact IT Helpdesk

The screenshot shows a small window titled 'HELP DESK'. It contains a text input field with a cursor, and a 'Send' button to the right. There is also a close button (X) in the top right corner.

RS232 by Telnet Function

There is alternative RS232 command control way, in projector so called "RS232 by TELNET" for LAN/RJ45 interface.

User Controls

Quick Start-Guide for "RS232 by Telnet"

- ▶ Check and get the IP address on OSD of the projector.
- ▶ Make sure that the PC/laptop can access the web-page of the projector.
- ▶ Make sure that "Windows Firewall" setting is set disabled in case of "TELNET" function filtering out by PC/laptop.



1. Start > All Programs.> Accessories > Command Prompt.

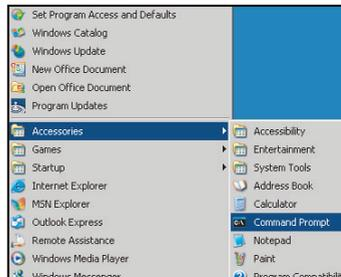

2. Input the command format as follows:
telnet ttt.xxx.yyy.zzz 23 ("Enter" key pressed)
(ttt.xxx.yyy.zzz: IP-Address of the projector)
3. If Telnet-Connection ready, and user can have RS232 command input, then "Enter" key pressed, the RS232 command will be workable.



- ❖ In Windows XP built-in “TELNET.exe” utility, “Enter” key pressed will have “Carriage-Return” and “New-Line” code.

Specification for “RS232 by TELNET”:

1. Telnet: TCP.
2. Telnet port: 23 (for more detail, kindly please get contact with the service agent or team).
3. Telnet utility: Windows “TELNET.exe” (console mode).
4. Disconnection for RS232-by-Telnet control normally: Close
5. Windows Telnet utility directly after TELNET connection ready.
 - ▶ Limitation 1 for Telnet-Control: there is less than 50 bytes for successive network payload for Telnet-Control application.
 - ▶ Limitation 2 for Telnet-Control: there is less than 26 bytes for one complete RS232 command for Telnet-Control.
 - ▶ Limitation 3 for Telnet-Control: Minimum delay for next RS232 command must be more than 200 (ms).

SETUP | Signal (RGB)



Automatic

- ❖ "Signal" is only supported in Analog VGA (RGB) signal.
- ❖ If "Signal" is automatic, the phase, frequency items are grayed out, and if "Signal" is not automatic, the phase, frequency items will appear for the user to manually tune and are saved Phase in the settings after that for the next time projector is turned off and on again.



Automatically selects the signal. If you use this function, the Phase, frequency items are grayed out, and if Signal is not automatic, the phase, frequency items will appear for user to manually tune and saved in settings after that for next time projector turns off and on again



Synchronize the signal timing of the display with the graphic card. If the image appears to be unstable or flickers, use this function to correct it.

- ▶ Press the ◀ to decrease the phase value.
- ▶ Press the ▶ to increase the phase value.

User Controls

Frequency



Change the display data frequency to match the frequency of your computer's graphic card. Use this function only if the image appears to flicker vertically.

- ▶ Press the ◀ to decrease the frequency.
- ▶ Press the ▶ to increase the frequency.

H. Position (Horizontal Position)



- ▶ Press the ◀ to move the image left.
- ▶ Press the ▶ to move the image right.

V. Position (Vertical Position)



- ▶ Press the ◀ to move the image down.
- ▶ Press the ▶ to move the image up.

Exit

Choose "Exit" to exit the menu.

SETUP | Signal (Video)



White Level



Adjust the overall white level of the projected image by applying a gain to the input image.

- ▶ Press the ◀ to decrease the white level.
- ▶ Press the ▶ to increase the white level.

Black Level

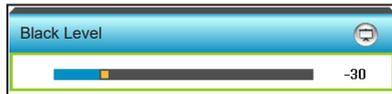

Adjust the overall black level of the projected image by applying a offset to the input image.

- ▶ Press the ◀ to decrease the black level.
- ▶ Press the ▶ to increase the black level.

Exit

Choose "Exit" to exit the menu.

SETUP | Advanced



Logo



Use this function to set the desired startup screen. If changes are made they will take effect the next time the projector is powered on.

- ▶ Neutral: Logo is not displayed on startup screen.
- ▶ Acer: Acer logo is displayed on startup screen.

Closed Captioning

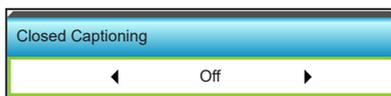

Closed Captioning is a text version of the program sound or other information displayed on the screen. If the input signal contains closed captions, you can turn on the feature and watch the channels. Press ◀ or ▶ to select between CCI, or CC2. Choose "Off" to disable this function.

Exit

Choose "Exit" to exit the menu.

OPTIONS



- ❖ “VGA 2” depends on the settings of “VGA2 Switch”.

Input Source

Use this option to enable/disable input sources. Press ► to enter the sub menu and select which sources you require. Press “Enter” to finalize the selection. The projector will only search for inputs that are enabled.

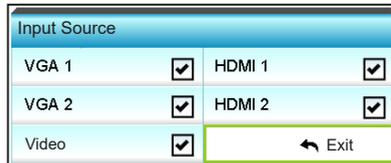

Source Lock

- ▶ On: The projector will only search current input connection.
- ▶ Off: The projector will search for other signals if the current input signal is lost.



High Attitude

When “On” is selected, the fans will spin faster. This feature is useful in high altitude areas where the air is thin.



User Controls

Information Hide

- ▶ On: Choose “On” to hide the info message.
- ▶ Off: Choose “Off” to show the “searching” message.

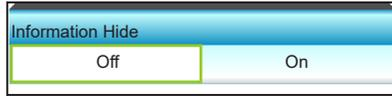

Keypad Lock

When the keypad lock function is “On”, the Keypad will be locked however, the projector can be operated by the remote control. By selecting “Off”, you will be able to unlock the Keypad.



Test Pattern

Display a test pattern. There are Grid, White Pattern and None.



12V Trigger

- ▶ Off: Choose “Off” to disable the trigger.
- ▶ On: Choose “On” to enable the trigger.



OPTIONS



Background Color

Use this feature to display a “Black”, “Red”, “Blue”, “Green” or “White”, screen when no signal is available.



VGA2 Switch

When the “VGA2 Switch” feature is “In” then VGA2 port functions as input port. If the “VGA2 Switch” is “Out” then the port functions as output port for VGA1.



User Controls

Reset

- ▶ Current: Choose “Yes” to return the display parameters on this menu to the factory default settings.
- ▶ All: Choose “Yes” to return the display parameters on all menus to the factory default settings.

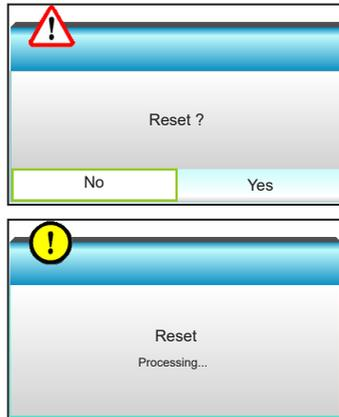

Exit

Choose “Exit” to exit the menu.

OPTIONS | Lamp Settings



- ❖ When ambient temperature is over 40°C in operating, the projector will switch to Eco automatically.
- ❖ Dynamic mode-lamp power can be dynamically adjusted from 100% to 30%.

Lamp Hour

Display the projection time.

Lamp Reminder

Choose this function to show or to hide the warning message when the changing lamp message is displayed.

The message will appear 30 hours before suggested replacement of lamp.

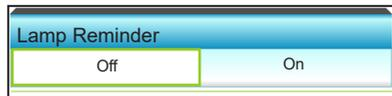

Brightness Mode

- ▶ Bright: Choose "Bright" to increase the brightness.
- ▶ Eco.: Choose "Eco." to dim the projector lamp which will lower power consumption and extend the lamp life.
- ▶ Dynamic: Choose "Dynamic" to dim the lamp power which will be based on brightness level of the content and adjust lamp power consumption between 100% and 30% dynamically. The lamp life will be extended.
- ▶ Eco+: When Eco+ mode is activated, the brightness level of the content is automatically detected to significantly reduced lamp power consumption (up to 70%) during periods of inactivity.



User Controls

Lamp Reset

Resets the lamp hour counter after replacing the lamp.

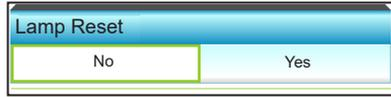

Exit

Choose "Exit" to exit the menu.

Lamp Behavior in different mode and function:

Brightness Mode	Bright	Eco.	Dynamic	Eco+
White Pattern	100%	80%	100%	80%
Dimming range	N/A	N/A	100%~30%	80%~30%
Black Pattern	100%	80%	30% (Sleep mode)	30% (Sleep mode)
AV Mute	30% (Sleep mode)	30% (Sleep mode)	30% (Sleep mode)	30% (Sleep mode)
Quick Resume	30% (Sleep mode)	30% (Sleep mode)	30% (Sleep mode)	30% (Sleep mode)

OPTIONS | Advanced

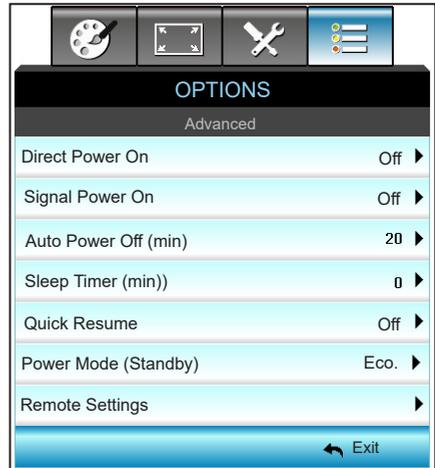

Direct Power On

Choose “On” to activate Direct Power mode. The projector will automatically power on when AC power is supplied, without pressing the “” key on the projector Control Panel or on the remote control.



- ❖ The Signal Power On function is not applicable if the input source is Video.
- ❖ (*)Functions vary depending on model definition.

Signal Power On*

Choose “On” to activate Signal Power mode. The projector will automatically power on when a signal is detected, without pressing the “” key on the projector Control Panel or on the remote control.



User Controls



- ❖ The value of sleep timer will be reset to zero after the projector power off.

Auto Power Off (min)

Sets the countdown timer interval. The countdown timer will start, when there is no signal being sent to the projector. The projector will automatically power off when the countdown has finished (in minutes).



- ▶ Press the ◀ to decrease the timer interval.
- ▶ Press the ▶ to increase the timer interval.

Sleep Timer (min)

Sets the countdown timer interval. The countdown timer will start, with or without a signal being sent to the projector. The projector will automatically power off when the countdown has finished (in minutes).



- ▶ Press the ◀ to decrease the timer interval.
- ▶ Press the ▶ to increase the timer interval.

Quick Resume

- ▶ On: If the projector is accidentally turned off, this feature allows the projector to be instantly powered on again, if selected within a period of 100 seconds.
- ▶ Off: The fan will start cooling the system after 10 seconds when user turns off the projector.

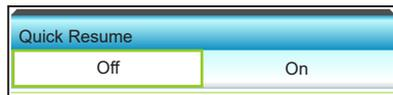

Power Mode (Standby)

- ▶ Eco.: Choose "Eco." to save power dissipation further < 0.5W.
- ▶ Active: Choose "Active" to return to normal standby.



Exit

Choose "Exit" to exit the menu.

OPTIONS | Remote Settings

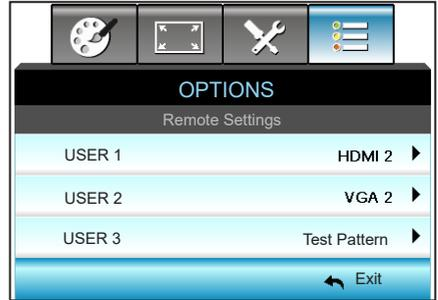

USER 1

The default value is HDMI 2.



Press the ▶ into the next menu and then press the ◀ or ▶ to select HDMI 2/ VGA 2/ Test Pattern/ LAN/ Brightness/ Contrast/ Sleep Timer/ Color Matching/ Color Temp./ Gamma/ Source Lock / Projection/ Lamp Settings/ Zoom/ Freeze.

USER 2

The default value is VGA 2.



Press the ▶ into the next menu and then press the ◀ or ▶ to select HDMI 2/ VGA 2/ Test Pattern/ LAN/ Brightness/ Contrast/ Sleep Timer/ Color Matching/ Color Temp./ Gamma/ Source Lock / Projection/ Lamp Settings/ Zoom/ Freeze.

USER 3

The default value is Test Pattern.



Press the ▶ into the next menu and then press the ◀ or ▶ to select HDMI 2/ VGA 2/ Test Pattern/ LAN/ Brightness/ Contrast/ Sleep Timer/ Color Matching/ Color Temp./ Gamma/ Source Lock / Projection/ Lamp Settings/ Zoom/ Freeze.

OPTIONS | Filter Settings



- ❖ "Filter Usage Hours/ Filter Reminder/ Filter Reset" will only appear when "Optional Filter Installed" is "Yes".

Filter Usage Hours

Display the filter time.

Filter Reminder

Choose this function to show or hide the warning message when the changing filter message is displayed. (Factory default setting: Off)



- ▶ Press the ◀ to decrease the time period.
- ▶ Press the ▶ to increase the time period.

Filter Reset

Reset the dust filter counter after replacing or cleaning the dust filter.

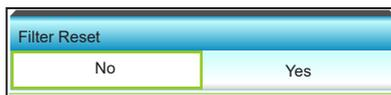

Exit

Choose "Exit" to exit the menu.

OPTIONS | Filter Settings

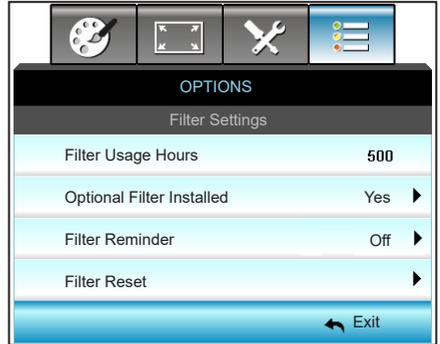

Optional Filter Installed (Depending on models)

Set the warning message setting.

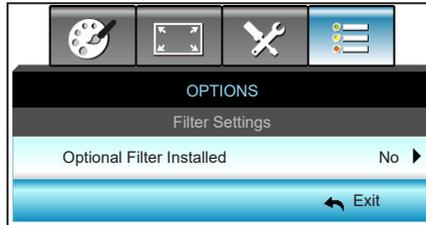

- ▶ Yes: Display warning message after 500 hours of use.
- ▶ No: Turn off warning message.

Troubleshooting

If you experience a problem with your projector, please refer to the following information. If a problem persists, please contact your local reseller or service center.

Image Problems

No image appears on-screen

- ▶ Ensure all the cables and power connections are correctly and securely connected as described in the “Installation” section.
- ▶ Ensure the pins of connectors are not crooked or broken.
- ▶ Check if the projection lamp has been securely installed. Please refer to the “Replacing the Lamp” section.
- ▶ Make sure the projector is switched on.
- ▶ Ensure that the “AV Mute” feature is not turned on.

Image is out of focus

- ▶ Make sure the projection screen is between the required distance from the projector. (refer to pages 15-18)

The image is stretched when displaying 16:9 DVD title

- ▶ When you play anamorphic DVD or 16:9 DVD, the projector will show the best image in 16: 9 format on projector side.
- ▶ If you play the LBX format DVD title, please change the format as LBX in projector OSD.
- ▶ If you play 4:3 format DVD title, please change the format as 4:3 in projector OSD.
- ▶ If the image is still stretched, you will also need to adjust the aspect ratio by referring to the following:
- ▶ Please setup the display format as 16:9 (wide) aspect ratio type on your DVD player.

Image is too small or too large

- ▶ Move the projector closer to or further from the screen.
- ▶ Press “Menu” on the projector panel, go to “DISPLAY--> Format”. Try the different settings.

Image has slanted sides:

- ▶ If possible, reposition the projector so that it is centered on the screen and below the bottom of the screen.
- ▶ Use “DISPLAY-->V. Keystone” from the OSD to make an adjustment.

Image is reversed

- ▶ Select “SETUP-->Projection” from the OSD and adjust the projection direction.

Blurry double image

- ▶ Press “3D” button and switch to “Off” to avoid normal 2D image is blurry double image.

Two images, side-by-side format

- ▶ Press “3D” button and switch to “SBS” for input signal is HDMI 1.3 2D 1080i side-by-side.

Image does not display in 3D

- ▶ Check if the battery of 3D glasses is drained.
- ▶ Check if the 3D glasses is turned on.
- ▶ When the input signal is HDMI 1.3 2D (1080i side-by-side half), press “3D” button and switch to “SBS”.

Other Problems

The projector stops responding to all controls

- ▶ If possible, turn off the projector, then unplug the power cord and wait at least 20 seconds before reconnecting power.

Lamp burns out or makes a popping sound

- ▶ When the lamp reaches its end of life, it will burn out and may make a loud popping sound. If this happens, the projector will not turn on until the lamp module has been replaced. To replace the lamp, follow the procedures in the “Replacing the Lamp” section.

Remote Control Problems

If the remote control does not work

- ▶ Check the operating angle of the remote control is within $\pm 15^\circ$ both horizontally and vertically of one of the IR receivers on the projector.
- ▶ Make sure there are not any obstructions between the remote control and the projector. Move to within 6 m (20 ft) of the projector.
- ▶ Make sure batteries are inserted correctly.
- ▶ Replace batteries if they are exhausted.

LED Lighting Messages

Message			
	On/Standby LED (Red/Green/Blue)	Temp-LED (Red)	Lamp-LED (Red)
Standby state (Input power cord)	Red	○	○
Power on (Warming)	Flashing Blue	○	○
Lamp lighting	Blue	○	○
Power off (Cooling)	Flashing Blue. Red (cooling fan has turned off)	○	○
Quick Resume (100 secs)	Flashing Blue	○	○
Error (Over temp.)	Flashing Red		○
Error (Fan failure)	Flashing Red	Flashing	
Error (Lamp failure)	Flashing Red		



❖ Steady light → 
No light → ○

On Screen Messages

❖ Power off:



❖ Lamp warning:



❖ Temperature warning:

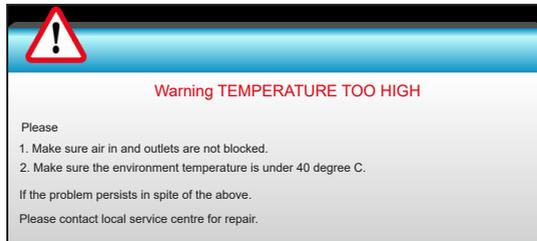

❖ Fan failed:

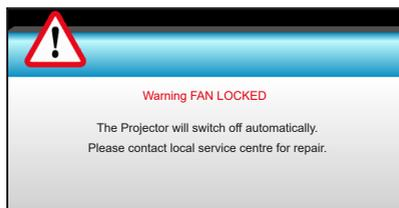

❖ Out of display range:

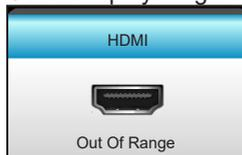

Replacing the Lamp

The projector automatically detects the lamp life. When the lamp life is nearing the end of use, you will receive a warning message.

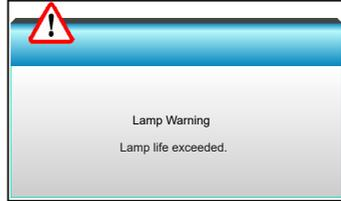

When you see this message, please contact your local reseller or service center to change the lamp as soon as possible. Make sure the projector has been cooled down for at least 30 minutes before changing the lamp.

 **CAUTION! 小心!**
CAUTION:
HIGH-PRESSURE LAMP MAY EXPLODE IF IMPROPERLY HANDLED.
REFER TO LAMP REPLACEMENT INSTRUCTIONS
ATTENTION: Les lampes à haute pression peuvent exploser si elles sont mal utilisées. Confier l'entretien à une personne qualifiée
注意: 如果处理不当, 高压灯泡可能会爆炸, 请参阅更换灯泡的说明
注意: 如果处理不当, 高压灯泡可能会爆炸, 请参阅更换灯泡的说明
 LAMPS CONTAIN MERCURY AND MUST BE RECYCLED OR DISPOSED OF ACCORDING TO LOCAL, STATE, OR FEDERAL LAWS.
灯泡内含汞, 必须根据当地、州或联邦法律进行回收或处理。
燈泡內含汞, 必須根據當地、州或聯邦法律進行回收或處理。



Warning: If ceiling mounted, please use caution when opening the lamp access panel. It is recommended to wear safety glasses if changing the bulb when ceiling mounted. "Caution must be used to prevent any loose parts from falling out of projector."



Warning: Lamp compartment is hot! Allow it to cool down before changing lamp!



Warning: To reduce the risk of personal injury, do not drop the lamp module or touch the lamp bulb. The bulb may shatter and cause injury if it is dropped.

Appendices

NOTE

- ❖ The screw on the lamp cover and the lamp cannot be removed.
- ❖ The projector cannot be turned on if the lamp cover has not been placed back on the projector.
- ❖ Do not touch the glass area of the lamp. Hand oil can cause the lamp to shatter. Use a dry cloth to clean the lamp module if it was accidentally touched.

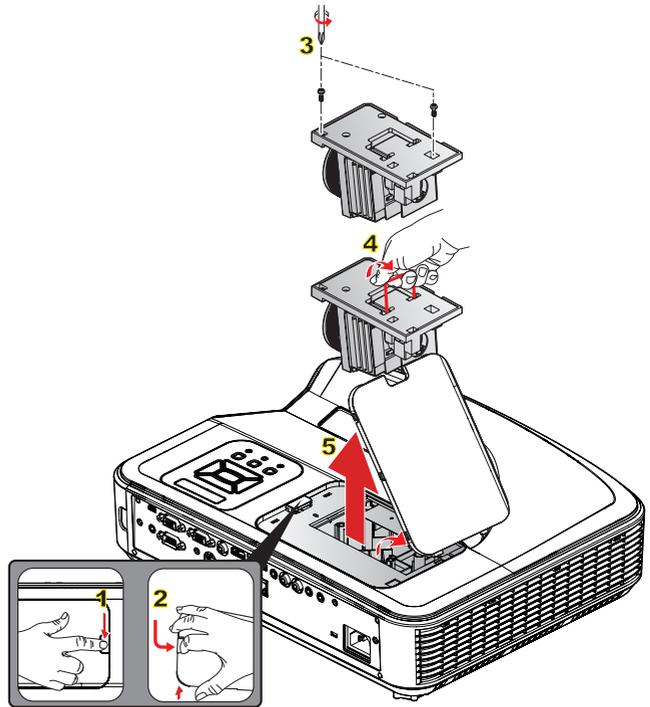

Lamp Replacement Procedure:

1. Switch off the power to the projector by pressing the “**U**” button on the remote control or on the Control Panel of the projector.
 2. Allow the projector to cool down for at least 30 minutes.
 3. Disconnect the power cord.
 4. Press the release button to disengage the lamp cover from the main unit. **1**
 5. Use your fingernail to pry the lamp cover loose and then remove it. **2**
 6. Unscrew the two screws on the lamp module. **3**
 7. Lift up the lamp handle **4** and remove the lamp module slowly and carefully. **5**
- To replace the lamp module, reverse the previous steps.
10. Turn on the projector and reset the lamp timer.

Lamp Reset: (i) Press “Menu” → (ii) Select “OPTIONS” → (iii) Select “Lamp Settings” → (iv) Select “Lamp Reset” → (v) Select “Yes”.

Installing and Cleaning the Dust Filter



- ❖ Dust filters are only required/ supplied in selected regions with excessive dust.

We recommend you clean the dust filter every 500 hours of operation, or more often if you are using the projector in a dusty environment.

When the warning message appears on the screen, do the following to clean the air filter:

The usage time of the dust filter is reached.
Please clean the dust filters for better performance.

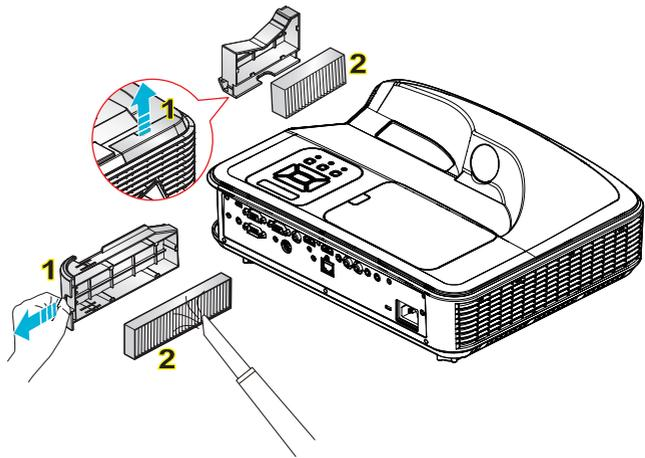

○ Air Filter Cleaning Procedure: ○

1. Switch off the power to the projector by pressing the “**⏻**” button on the remote control or on the Control Panel of the projector.
2. Disconnect the power cord.
3. Pull out the latch to remove the dust filter compartment, as shown in the illustration. **1**
4. Carefully remove the air filter. Then clean or replace the dust filter. **2**
To install the dust filter, reverse the previous steps.
5. Turn on the projector and reset the filter usage counter after the dust filter is replaced.

Compatibility Modes

Digital compatibility

B0/Established Timing	B0/Standard Timing	B0/Detail Timing	B1/Video Mode	B1/Detail Timing
720 x 400 @ 70Hz	XGA / WXGA:	Native timing:	640 x 480p @ 60Hz	720 x 480p @ 60Hz
640 x 480 @ 60Hz	1440 x 900 @ 60Hz	XGA: 1024 x 768 @ 60Hz	720 x 480p @ 60Hz	1280 x 720p @ 60Hz
640 x 480 @ 67Hz	1024 x 768 @ 120Hz	WXGA: 1280 x 800 @ 60Hz	1280 x 720p @ 60Hz	1366 x 768 @ 60Hz
640 x 480 @ 72Hz	1280 x 800 @ 60Hz	1080P: 1920 x 1080 @ 60Hz	1920 x 1080i @ 60Hz	1920 x 1080i @ 50Hz
640 x 480 @ 75Hz	1280 x 1024 @ 60Hz		720(1440) x 480i @ 60Hz	1920 x 1080p @ 60Hz
800 x 600 @ 56Hz	1680 x 1050 @ 60Hz		1920 x 1080p @ 60Hz	
800 x 600 @ 60Hz	1280 x 720 @ 60Hz		720 x 576p @ 50Hz	
800 x 600 @ 72Hz	1280 x 720 @ 120Hz		1280 x 720p @ 50Hz	
800 x 600 @ 75Hz	1600 x 1200 @ 60Hz		1920 x 1080i @ 50Hz	
1024 x 768 @ 60Hz			720(1440) x 576i @ 50Hz	
1024 x 768 @ 70Hz	1080P / WUXGA:		1920 x 1080p @ 50Hz	
1024 x 768 @ 75Hz	1280 x 720 @ 60Hz		1920 x 1080p @ 24Hz	
1280 x 1024 @ 75Hz	1280 x 800 @ 60Hz		1920 x 1080p @ 30Hz	
	1280 x 1024 @ 60Hz			
	1400 x 1050 @ 60Hz			
	1600 x 1200 @ 60Hz			
	1440 x 900 @ 60Hz			
	1280 x 720 @ 120Hz			
	1024 x 768 @ 120Hz			

VGA analog compatibility

B0/Established Timing	B0/Standard Timing	B0/Detail Timing	B1/Video Mode	B1/Detail Timing
720 x 400 @ 70Hz	XGA / WXGA:	Native timing:		1366 x 768 @ 60Hz
640 x 480 @ 60Hz	1440 x 900 @ 60Hz	XGA: 1024 x 768 @ 60Hz		
640 x 480 @ 67Hz	1024 x 768 @ 120Hz	WXGA: 1280 x 800 @ 60Hz		
640 x 480 @ 72Hz	1280 x 800 @ 60Hz	1080P: 1920 x 1080 @ 60Hz		
640 x 480 @ 75Hz	1280 x 1024 @ 60Hz			
800 x 600 @ 56Hz	1680 x 1050 @ 60Hz			
800 x 600 @ 60Hz	1280 x 720 @ 60Hz			
800 x 600 @ 72Hz	1280 x 720 @ 120Hz			
800 x 600 @ 75Hz	1600 x 1200 @ 60Hz			
1024 x 768 @ 60Hz				
1024 x 768 @ 70Hz	1080P / WUXGA:			

Appendices

B0/Established Timing	B0/Standard Timing	B0/Detail Timing	B1/Video Mode	B1/Detail Timing
1024 x 768 @ 75Hz	1280 x 720 @ 60Hz			
1280 x 1024 @ 75Hz	1280 x 800 @ 60Hz			
	1280 x 1024 @ 60Hz			
	1400 x 1050 @ 60Hz			
	1600 x 1200 @ 60Hz			
	1440 x 900 @ 60Hz			
	1280 x 720 @ 120Hz			
	1024 x 768 @ 120Hz			

True 3D video compatibility

<i>Input resolution</i>	Input	Input timing		
		HDMI 1.4a 3D	1280 x 720P @ 50Hz	Top - and - Bottom
		1280 x 720P @ 60Hz	Top - and - Bottom	
		1280 x 720P @ 50Hz	Frame packing	
		1280 x 720P @ 60Hz	Frame packing	
		1920 x 1080i @ 50 Hz	Side- by-Side (Half)	
		1920 x 1080i @ 60 Hz	Side- by-Side (Half)	
		1920 x 1080P @ 24 Hz	Top - and- Bottom	
		1920 x 1080P @ 24 Hz	Frame packing	
	HDMI 1.3	1920 x 1080i @ 50Hz	Side-by-Side(Half)	SBS mode is on
		1920 x1080i @ 60Hz		
		1280 x 720P @ 50Hz		
		1280 x 720P @ 60Hz		
		1920 x 1080i @ 50Hz	Top-and-Bottom	TAB mode is on
		1920 x1080i @ 60Hz		
		1280 x 720P @ 50Hz		
		1280 x 720P @ 60Hz		
		480i	HQFS	3D format is Frame sequential

Ceiling Mount Installation

If you wish to use a third party ceiling mount kit, please ensure the screws used to attach a mount to the projector meet the following specifications:

- ▶ Screw type: M4*4
- ▶ Maximum screw length: 11mm
- ▶ Minimum screw length: 8mm



❖ Please note that damage resulting from incorrect installation will void the warranty.



 Warning:

1. If you buy a ceiling mount from another company, please be sure to use the correct screw size. Screw size will vary depending on the thickness of the mounting plate.
2. Be sure to keep at least 10 cm gap between the ceiling and the bottom of the projector.
3. Avoid installing the projector near a heat source.

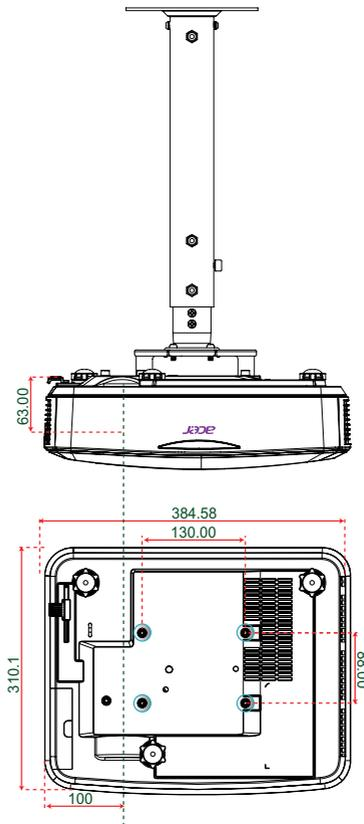

Unit: mm

Regulations and safety notices

Compliant with Russian/ Ukraine regulatory certification



Radio device regulatory notice



Note: The regulatory information below is for models with wireless LAN and/or Bluetooth only.

General

This product complies with the radio frequency and safety standards of any country or region in which it has been approved for wireless use. Depending on configurations, this product may or may not contain wireless radio devices (such as wireless LAN and/or Bluetooth modules).

Canada — Low-power license-exempt radio communication devices (RSS-247)

a Common information

Operation is subject to the following two conditions:

1. This device may not cause interference, and
2. This device must accept any interference, including interference that may cause undesired operation of the device.

b Operation in 2.4 GHz band

To prevent radio interference to the licensed service, this device is intended to be operated indoors and installation outdoors is subject to licensing.

List of applicable countries

This device must be used in strict accordance with the regulations and constraints in the country of use. For further information, please contact the local office in the country of use. Please see <http://ec.europa.eu/enterprise/rtte/implement.htm> for the latest country list.



Acer Incorporated
8F, 88, Sec. 1, Xintai 5th Rd., Xizhi
New Taipei City 221, Taiwan

Declaration of Conformity

We,

Acer Incorporated

8F, 88, Sec. 1, Xintai 5th Rd., Xizhi, New Taipei City 221, Taiwan

And,

Acer Italy s.r.l.

Via Lepetit, 40, 20020 Lainate (MI) Italy

Tel: +39-02-939-921 ,Fax: +39-02 9399-2913

www.acer.it

Product: DLP Projector
Trade Name: Acer
Model Number: D1P1801/DWX1802/DNX1803

**Marketing name: U5530/U5330W/U5230/R350/R320/R310/PU-F20/PU-W20/PU-X20/
SP150/SP130/SP110/FU-420/FU-320/FU-120**

We, Acer Incorporated, hereby declare under our sole responsibility that the product described above is in conformity with the relevant Union harmonization legislations as below Directive and following harmonized standards and/or other relevant standards have been applied:

EMC Directive: 2014/30/EU

<input checked="" type="checkbox"/> EN 55032:2015+AC:2016, Class B	<input checked="" type="checkbox"/> EN 61000-3-2:2014, Class A
<input checked="" type="checkbox"/> EN 55024:2010+A1:2015	<input checked="" type="checkbox"/> EN 61000-3-3:2013

R&TTE Directive: 1999/5/EC (until Jun 12, 2017)

RED Directive: 2014/53/EU (From Jun 13, 2017)

<input type="checkbox"/> EN 300 328 V1.8.1	<input type="checkbox"/> EN 301 511 V9.0.2	<input type="checkbox"/> EN 301 489-7 V1.3.1
<input type="checkbox"/> EN 301 893 V1.7.1	<input type="checkbox"/> EN 301 908-1 V6.2.1	<input type="checkbox"/> EN 301 489-17 V2.2.1
<input type="checkbox"/> EN 300 440-1 V1.6.1	<input type="checkbox"/> EN 301 908-2 V6.2.1	<input type="checkbox"/> EN 301 489-24 V1.5.1
<input type="checkbox"/> EN 300 440-2 V1.4.1	<input type="checkbox"/> EN 301 908-13 V6.2.1	<input type="checkbox"/> EN 50360:2001
<input type="checkbox"/> EN 302 291-1 V1.1.1	<input type="checkbox"/> EN 301 489-1 V1.9.2	<input type="checkbox"/> EN 50566:2013
<input type="checkbox"/> EN 302 291-2 V1.1.1	<input type="checkbox"/> EN 301 489-3 V1.6.1	<input type="checkbox"/> EN 62479:2010
		<input type="checkbox"/> EN 62311:2008
		<input type="checkbox"/> EN 62209-1:2006
		<input type="checkbox"/> EN 62209-2:2010

LVD Directive: 2014/35/EU

<input checked="" type="checkbox"/> EN 60950-1:2006/A11:2009/A1:2010/A12:2011/A2:2013	
<input type="checkbox"/> EN 50332-1:2000	<input type="checkbox"/> EN 50332-2:2003

RoHS Directive: 2011/65/EU

<input checked="" type="checkbox"/> EN 50581:2012

ErP Directive: 2009/125/EC

<input type="checkbox"/> Regulation (EU) No. 617/ 2013	<input type="checkbox"/> Regulation (EC) No. 278/2009; EN 50563:2011
<input checked="" type="checkbox"/> Regulation (EC) No. 1275/2008; EN 50564:2011	

Year to begin affixing CE marking 2018.

RU Jan / Sr. Manager
Acer Incorporated (Taipei, Taiwan)

Jun. 28, 2018

Date