

SyncMaster 460UTn-2, 460UT-2, 460UTn-B, 460UT-B

LCD Display

User Manual

The color and the appearance may differ depending on the product, and the specifications are subject to change without prior notice to improve the performance.

SAMSUNG

Safety Instructions

Notational



Note

These safety instructions must be followed to ensure your safety and prevent property damage.

Make sure to read the instructions carefully and use the product in the correct manner.

Warning / Caution



Failure to follow directions noted by this symbol could result in bodily harm or damage to the equipment.

Note



Prohibited



Important to read and understand at all times



Do not disassemble



Disconnect the plug from the outlet



Do not touch



Ground to prevent an electric shock

Power





When not used for extended period of time, set your computer to DPM.

If using a screen saver, set it to active screen mode.

The images here are for reference only, and are not applicable in all cases (or countries).

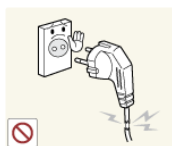
Shortcut to Anti-Afterimage Instructions



 Do not use a damaged power cord or plug or a damaged or loose power outlet.

- Otherwise, this may result in electric shock or fire.



 Do not touch the power plug with wet hands when removing or plugging the plug into the outlet.

- Otherwise, this may result in electric shock.

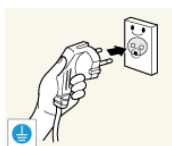

 Make sure to connect the power cord to a grounded power outlet.

- Otherwise, it may result in electric shock or personal injury.

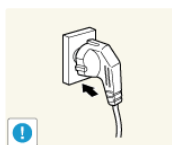

▶ Ensure that the power plug is plugged into the power outlet firmly and correctly.

- Otherwise, this may result in fire.

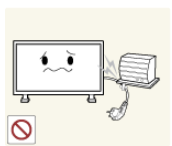

▶ Do not forcefully bend or pull the power plug and do not place any heavy material on it.

- Otherwise, this may result in fire.



▶ Do not connect multiple appliances to the same power outlet.

- Otherwise, this may cause fire due to overheating.



▶ Do not disconnect the power cord while using the product.

- Otherwise, this may result in damage to the product due to electric shock.

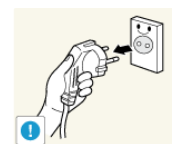

▶ To disconnect the apparatus from the mains, the plug must be pulled out from the mains socket, therefore the mains plug shall be readily operable.

- Otherwise, this may cause electric shock or fire.



▶ Use only the power cord provided by our company. Do not use the provided power cord of another product.

- Otherwise, this may result in fire or electric shock.

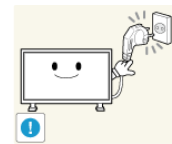

▶ Connect the power plug to a wall outlet that can be easily reached.

- When a problem occurs with the product, you must unplug the power plug to cut the power off completely. You cannot cut the power off completely using only the power button on the product.

Installation



Be sure to contact an authorized Service Center when installing your monitor in a location with heavy dust, high or low temperatures, high humidity, and exposed to chemical substances and where it operates for 24 hours such as at airports, train stations etc.

Failure to do so may cause serious damage to your monitor.



▶ Ensure that at least two persons lift and move the product.

- Otherwise, it may be dropped and cause personal injury, and/or damage the product.

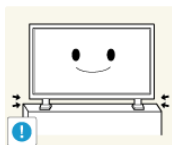

▶ When installing the product in a cabinet or rack, make sure that the front end of the bottom of the product does not project out.

- Otherwise, it may fall or cause personal injury.
- Use a cabinet or rack of a size appropriate to the product.

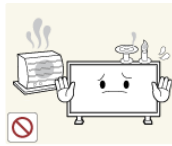

▶ DO NOT PLACE CANDLES, MOSQUITO REPELLANT, CIGARETTES AND ANY HEATING APPLIANCES NEAR THE PRODUCT.

- Otherwise, this may result in fire.

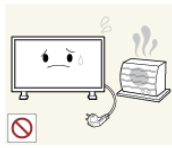

▶ Keep heating appliances as far away from the power cord or the product as possible.

- Otherwise, this may result in electric shock or fire.



▶ Do not install it in a badly ventilated location such as a bookcase or closet.

- Otherwise, this may result in fire due to an increase in the internal temperature.



▶ When putting the product down, make sure to put it down softly.

- Otherwise, this may result in damage to the screen display.

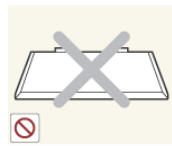

▶ Do not place the front of the product on the floor.

- Otherwise, this may result in damage to the screen display.

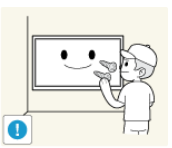

▶ Ensure that an authorized installation company installs the wall mount.

- Otherwise, it may fall and cause personal injury.

- Make sure to install the specified wall mount.

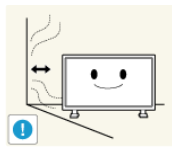

▶ Install your product in a well ventilated location. Ensure that there is a clearance of more than 4 inches (10 cm) from the wall.

- Otherwise, it may result in fire due to an increase in the internal temperature.



▶ Ensure that the packaging vinyl is kept away from children.

- Otherwise, it may result in serious harm (suffocation) if children play with it.

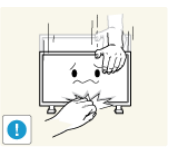

▶ If the height of your monitor is adjustable, do not place any object or part of your body on the stand when lowering it.

- This may cause damage to the product or the person carrying it.

Clean



When cleaning the monitor case or the surface of the TFT-LCD screen, wipe with a slightly moistened, soft cloth.



▶ Do not spray cleaner directly onto the surface of the product.

- Otherwise, this may result in the discoloration and distortion of the structure and the screen surface may peel off.



▶ When cleaning the power plug pins or dusting the power outlet, clean it with a dry cloth.

- Otherwise, it may result in fire.

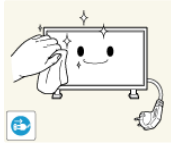

▶ When cleaning the product, make sure to disconnect the power cord.

- Otherwise, it may result in electric shock or fire.



▶ When cleaning the product, disconnect the power cord and clean it with a soft, dry cloth.

- (Do not use chemicals such as wax, benzene, alcohol, thinner, mosquito repellent, lubricant, or cleaner.) These may change the appearance of the product surface and peel off the indication labels on the product.

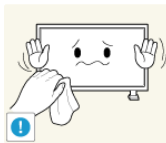

▶ Since the product housing is easily scratched, make sure to use the specified cloth only.



▶ When cleaning the product, do not spray water directly onto the main body of the product.

- Ensure that water does not enter the product and that it is not wet.
- Otherwise, this may result in electric shock, fire or a malfunction.

Others



▶ The product is a high voltage product. Do not disassemble, repair or modify the product yourself.

- Otherwise, this may result in electric shock or fire. If the product needs to be repaired, contact a Service Center.



▶ If there is a strange smell or a strange sound or smoke is coming from the product, disconnect the power plug immediately and contact a Service Center.

- Otherwise, this may result in electric shock or fire.

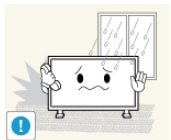

▶ Do not place this product in a location exposed to moisture, dust, smoke, water, or in a car.

- Otherwise, this may result in electric shock or fire.

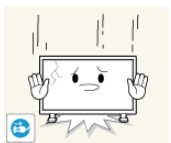

▶ When you drop the product or the case is broken, turn the power off and disconnect the power cord. Contact a Service Center.

- Otherwise, this may result in electric shock or fire.

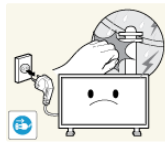

▶ If thunder or lightning is occurring, do not touch the power cord or antenna cable.

- Otherwise, this may result in electric shock or fire.



▶ Do not try to move the monitor by pulling only the wire or the signal cable.

- Otherwise, it may fall and result in electric shock, damage to the product or fire due to damage to the cable.

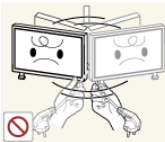

▶ Do not lift or move the product back and forwards or right and left while only holding the power cord or signal cables.

- Otherwise, it may fall and result in electric shock, damage to the product or fire due to damage to the cable.



▶ Make sure that the ventilating opening is not blocked by a table or curtain.

- Otherwise, it may result in fire due to an increase in the internal temperature.



▶ Do not place any containers containing water, vases, flower-pots, medicines as well as any metal on the product.

- If water or a foreign material enters the product, disconnect the power cord and contact a Service Center.

- This may result in a product malfunction, electric shock, or fire.

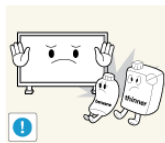

▶ Do not use or keep combustible spray or flammable material near the product.

- Otherwise, this may result in an explosion or fire.

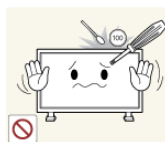

▶ Do not insert any metal, such as chopsticks, coins, pins and steel, or flammable objects, such as matches or paper, inside the product (through the ventilating openings, input and output terminals, etc).

- If water or foreign material enters the product, disconnect the power cord and contact a Service Center.

- Otherwise, this may result in electric shock or fire.

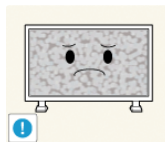

▶ When using a fixed screen for a long time, an afterimage or stain may occur.

- If you are not using your product for a long period of time, put it into sleep mode or use a moving screen saver.

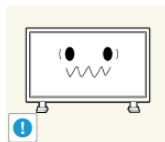

▶ Set a resolution and frequency appropriate to the product.

- Otherwise, your eyesight may be damaged.



▶ When using headphones or earphones, do not turn the volume too high.

- Having the sound too loud may damage your hearing.

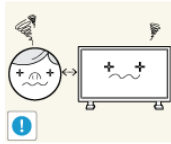

▶ To avoid eyestrain, do not sit too close to the product.

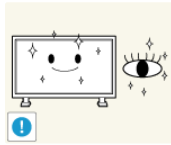

▶ Take a rest for at least five (5) minutes after using the monitor for one (1) hour.

This reduces eye fatigue.



▶ Do not install it in an unstable location such as an unstable rack or uneven surface or a location exposed to vibrations.

- Otherwise, it may fall and cause personal injury and/or damage the product.
- If you use the product in a location exposed to vibrations, it may damage the product and result in fire.

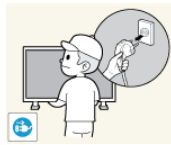

▶ When moving the product, turn the power off and disconnect the power plug, antenna cable, and all the cables connected to the product.

- Otherwise, it may result in electric shock or fire.



▶ Ensure that children do not hang onto the product or climb up onto the product.

- The product may fall and cause personal injury or death.

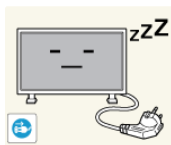

▶ If you do not use the product for a long period of time, disconnect the power cord from the power outlet.

- Otherwise, this may result in overheating or fire due to dust, and may result in fire due to electric shock or leakage.



▶ Do not place any heavy items or toys or confectionery, such as cookies etc. that may attract the attention of children and to the product.

- Your children may hang onto the product causing it to fall and this may result in personal injury or death.



▶ Be careful that children do not place the battery in their mouths when removed from the remote control. Place the battery in a location that children or infants cannot reach.

- If children have had the battery in their mouths, consult your doctor immediately.

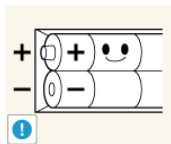

▶ When replacing the battery, insert it with the right polarity (+, -).

- Otherwise, the battery may become damaged or it may cause fire, personal injury or damage due to leakage of the internal liquid.

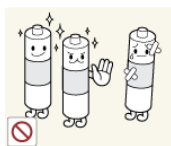

▶ Use only the specified standardized batteries, and do not use a new battery and a used battery at the same time.

- Otherwise, the batteries may be damaged or cause fire, personal injury or damage due to a leakage of the internal liquid.

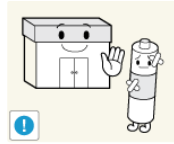

▶ The batteries (and rechargeable batteries) are not ordinary refuse and must be returned for recycling purposes. The customer is responsible for returning the used or rechargeable batteries for recycling.

- The customer can return used or rechargeable batteries to a nearby public recycling center or to a store selling the same type of the battery or rechargeable battery.

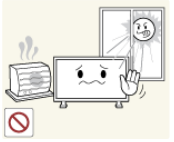

▶ Do not place the product in a location exposed to direct sunlight or near any heat such as a fire or heater.

- This may reduce the lifetime of the product, and may result in fire.



▶ Do not drop any objects onto the product or cause any impact to the product.

- Otherwise, this may result in electric shock or fire.



▶ Do not use a humidifier near the product.

- Otherwise, this may result in electric shock or fire.

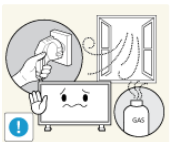

▶ When there is a gas leak, do not touch the product or the power plug; ventilate immediately.

- If a spark occurs, it may cause an explosion or fire.



▶ If the product has been turned on for a long time, the display panel becomes hot. Do not touch it.



▶ Keep the small accessories in a location out of the reach of children.



▶ Be careful when adjusting the angle of the product or the height of the stand.

- This may result in personal injury as your hand or fingers may become caught.
- Also, if you tilt the product too far, it may fall and cause personal injury.



▶ Do not install the product in a location low enough for children to reach.

- Otherwise, it may fall and result in personal injury.
- Since the front part of the product is heavy, install the product on a level and stable surface.



▶ Do not put any heavy objects on the product.

- This may result in personal injury and/or damage to the product.

Introduction

Package Contents

Checking the Contents of the Package

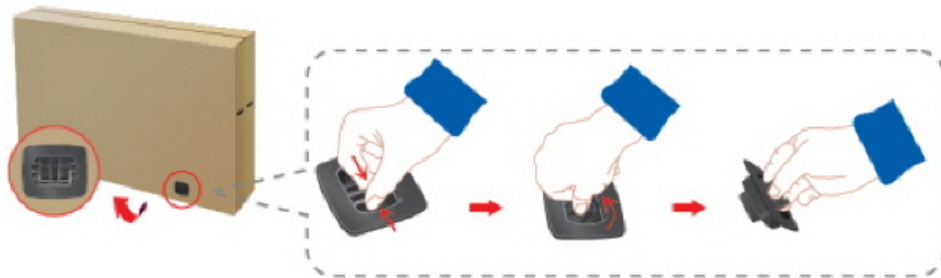

Remove the lock from the package box, as shown in the figure above.



Lift up the package box by holding the grooves on both sides of the package box.

Check the contents of the package.

Remove the Styrofoam and vinyl cover.

Note

- After unpacking the package, make sure to check the contents of the package.
- Store the packaging box in case you need to move the Product later.
- If any items are missing, contact your dealer.
- Contact a local dealer to purchase optional items.
- After unpacking, you may use the lower part of the package box as a temporary stand for product test or operation check.

Unpacking



LCD Display

Manuals



Quick Setup Guide



Warranty Card

(Not available in all locations)



User's Guide

Cables



Power Cord



D-Sub Cable



MagicInfo Software CD,
MagicInfo Manual CD

(Applicable to the
460UTn-2, 460UTn-B
model only)

Others



Remote Control

(BP59-00138B)



Batteries (AAA X 2)

(Not available in all locations)

Sold separately



Semi Stand KIT



LAN Cable



USB Cable

(Applicable to the
460UTn-2, 460UTn-B
model only)

Sold separately



RGB to BNC Cable



RGB to COMPONENT Cable



Network Box

(Applicable to the 460UT-2, 460UT-B model only)

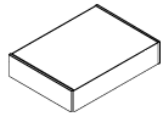

Wall Mount KIT

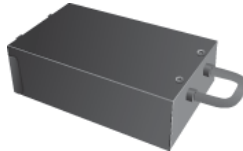

TV Tuner Box

Your LCD Display

Front

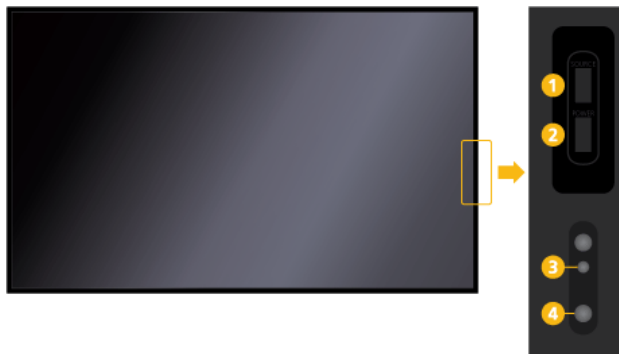

1 SOURCE button

Switches from PC mode to Video mode. Selects the input source that an external device is connected to.

[PC] → [DVI] → [AV] → [Component] → [HDMI1] → [HDMI2] → [Display-Port] → [MagicInfo] → [TV]

Note

- A TV tuner box (sold separately) must be connected to use the TV.
- A network box (sold separately) must be connected to use **MagicInfo** with a 460UT-2, 460UT-B model.

2 POWER button

Use this button for turning the LCD Display on and off.

3 Power indicator

Shows PowerSaver mode by blinking green

 **Note**

See PowerSaver described in the manual for further information regarding power saving functions. For energy conservation, turn your LCD Display OFF when it is not needed or when leaving it unattended for long periods.

4 Remote Control Sensor

Aim the remote control towards this spot on the LCD Display.

Rear
 **Note**

See the "Connections" section for details about cable connections. The LCD Display's configuration at the back may vary slightly depending on the model.



A

1 POWER SW ON [|] / OFF

Switches the LCD Display On/Off.

2 POWER

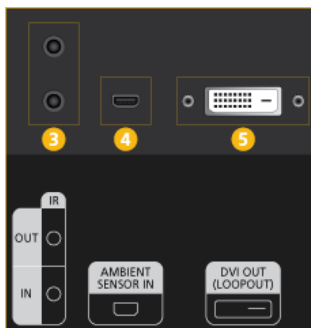
The power cord plugs into the LCD Display and the wall outlet.

B

3 IR OUT/IN

Receives a signal from the remote control and outputs the signal through Loopout when a removable sensor board is connected.

4 AMBIENT SENSOR IN

Supplies power to the removable sensor board and receives a signal from the light sensor.

5 DVI OUT (LOOPOUT)

- Connect a monitor to another monitor through a DVI, DVI to HDMI cable.

- Connect a DVI or DVI-HDMI cable to *[DVI OUT (LOOPOUT)]* on the product and *[DVI IN]* or *[HDMI IN]* on another monitor.
- HDMI and network signals sent via the *[DVI OUT (LOOPOUT)]* port are displayed on the second display which has the *[DVI IN]* port.

 **Note**

- The Loopout function can be used to duplicate the screen of the primary display. Connect *[DVI OUT]* on the primary display to *[DVI IN]* or *[HDMI]* on another display.
- A maximum of 50 monitors can be connected to DVI-Loopout (using a 2m-long DVI cable). Up to Full HD resolution can be supported. Compatible input sources include DVI IN, HDMI IN 1, and HDMI IN 2 (MagicInfo).

C

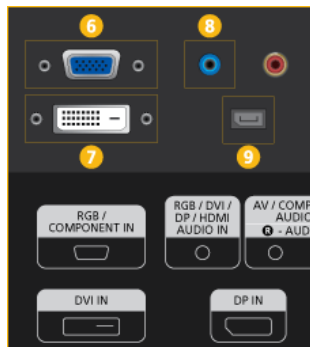

6 *RGB/COMPONENT IN (PC/COMPONENT Connection Terminal (Input))*

- Connect the *[RGB/COMPONENT IN]* port on the monitor to the RGB port on the PC using the D-SUB cable.
- Connect the *[RGB/COMPONENT IN]* port on the monitor to the COMPONENT port on the external device using the RGB to COMPONENT cable.
- Connect the *[RGB/COMPONENT IN]* port on the monitor to the BNC port on the PC using the RGB to BNC cable.

7 *DVI IN (PC Video Connection Terminal)*

Connect the *[DVI IN]* port on the monitor to the DVI port on the PC using the DVI cable.

8 *RGB/DVI/DP/HDMI AUDIO IN (PC/DVI/DP/HDMI Audio Connection Terminal (Input))*

Connect the *[RGB/DVI/DP/HDMI AUDIO IN]* terminal of the monitor and the speaker output terminal of your computer's sound card using a stereo cable (sold separately).

9 *DP IN*

Receives a signal from the Display port.

D

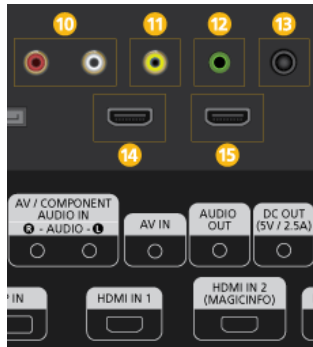

10 AV/COMPONENT AUDIO IN [L-AUDIO-R]

Connect the [AV/COMPONENT AUDIO IN [L-AUDIO-R]] port on the monitor to the audio output port on the PC or on the external device using an audio cable.

11 AV IN

Connect the [AV IN] terminal of your monitor to the video output terminal of the external device using a VIDEO cable.

12 AUDIO OUT

Connect a headphone or an External speaker.

13 DC OUT

Make sure to use connecting [DC OUT] terminal to the authorized TV-Tuner Box [SBB_DTC/ZA].



Otherwise, this may result in damage to the product.

14 HDMI IN 1

- Connect the [HDMI IN 1] terminal at the back of your LCD Display to the HDMI terminal of your digital output device using a HDMI cable.
- Up to HDMI 1.3 can be supported.



Note

The [HDMI IN 1] port can be connected to general external devices (DVD players, camcorders, etc.) or the TV set-top box.

15 HDMI IN 2 (MAGICINFO)

- Connect the [HDMI IN 2 (MAGICINFO)] terminal at the back of your LCD Display to the HDMI terminal of your digital output device using a HDMI cable.
- Up to HDMI 1.3 can be supported.

E

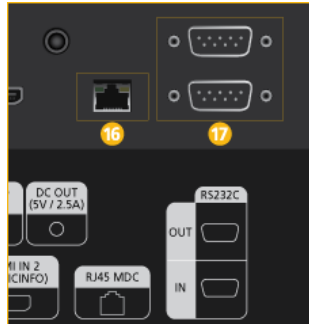

 **Note**

The MAGICINFO OUT port must be connected to the *[HDMI IN 2 (MAGICINFO)]* port.

16 *RJ 45 MDC (MDC PORT)*

MDC(Multiple Display Control) Program Port

Connect the LAN cable to *[RJ45 MDC]* on the product and LAN on the PC. To use an MDC, the MDC program must be installed on the PC.

 **Note**

Go to **Multi Control** and select **RJ45 MDC** as the **MDC Connection**.

17 *RS232C OUT/IN (RS232C Serial PORT)*

MDC(Multiple Display Control) Program Port

Connect a serial cable (cross type) to *[RS232C]* on the product and RS232C on the PC. To use an MDC, the MDC program must be installed on the PC.

 **Note**

Go to **Multi Control** and select **RS232C MDC** as the **MDC Connection**.

F

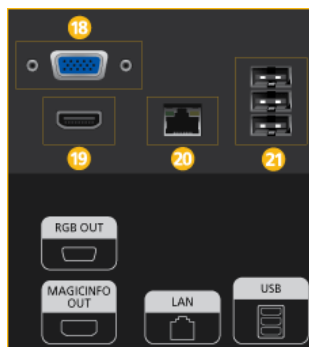

18 RGB OUT

MagicInfo video output port

 **Note**

Applicable to the 460UTn-2, 460UTn-B model only.

19 MAGICINFO OUT

Outputs **MagicInfo** HDMI signals. It should be connected to *[HDMI IN 2 (MAGICINFO)]* via an HDMI cable.

20 *LAN (LAN Connection Terminal)*

Connects to a LAN cable to allow Internet or network access in **MagicInfo** mode.

 **Note**

Applicable to the 460UTn-2, 460UTn-B model only.

21 *USB (USB Connection Terminal)*

Keyboard / Mouse, Mass Storage Device Compatible.

 **Note**

Applicable to the 460UTn-2, 460UTn-B model only.

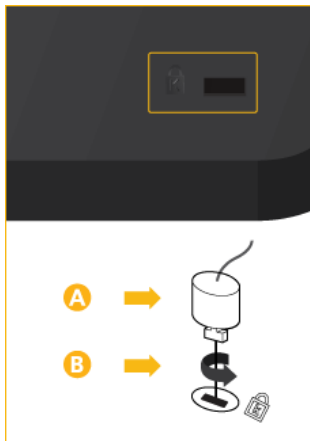
G*Kensington Lock slot*

A Kensington Lock is an anti-theft device that enables users to lock the product so that they can safely use it in public locations. Since the shape and usage of the locking device may differ depending on the model and the manufacturer, for more information, refer to the User Manual supplied with the locking device for more information.

 **Note**

You must purchase the Kensington Lock separately.

To lock the product, follow these steps:

1. Wrap the Kensington lock cable around a large, stationary object such as a desk or chair.
2. Slide the end of the cable with the lock attached through the looped end of the Kensington lock cable.
3. Insert the Kensington Lock into the security slot (**A**) on the back of the display.
4. Lock the lock (**B**).

 **Note**

- These are general instructions. For exact instructions, see the User Manual supplied with the locking device.
- You can purchase the locking device from an electronics store, an online shop, or our service center.

 **Note**

See the "Connections" section for details about cable connections.

Remote Control



Note

The performance of the remote control may be affected by a TV or other electronic device operating near the LCD Display, causing a malfunction due to interference with the frequency.



- | | | |
|---|---------------------|--|
| 1 | POWER | Turns the product On/Off. |
| 2 | OFF | Turns the product Off. |
| 3 | Number Buttons | Used to enter the password during the OSD adjustment or to use MagicInfo. |
| 4 | DEL / GUIDE button | Press to change the channel.
The "-" button is used to select Digital channels.
Electronic Program Guide (EPG) display.
- This function does not work for this LCD Display. |
| 5 | + VOL - | Adjusts the audio volume. |

6  SOURCE Selects a connected external input source or **MagicInfo** mode.

Press the button to change the input signal SOURCE.

Changing the SOURCE is only allowed for external devices that are connected to the LCD Display at the time.

7  D.MENU DTV menu display

DTV menu display

- This function does not work for this LCD Display.

8  TOOLS Use to quickly select frequently used functions.

Use to quickly select frequently used functions.

- This function does not work for this LCD Display.

9 Up-Down Left-Right buttons Moves from one menu item to another horizontally, vertically or adjusts selected menu values.

Moves from one menu item to another horizontally, vertically or adjusts selected menu values.

10  INFO Current picture information is displayed on the upper left corner of the screen.

Current picture information is displayed on the upper left corner of the screen.

11 PC/DVI/HDMI/DP Directly selects an external input source: **PC, DVI, HDMI** or **DP(DisplayPort)**.

Directly selects an external input source: **PC, DVI, HDMI** or **DP(DisplayPort)**.

12  TTX/MIX TV channels provide written information services via teletext.

TV channels provide written information services via teletext.

- Teletext Buttons

6 , **7** , **10** , **12** , **13** , **14** , **16** , **18** , **19** , **20** 

- This is activated when a TV tuner box is installed.

13 MTS/DUAL

MTS-

You can select MTS (Multichannel Television Stereo) mode.

	Audio Type	MTS/S_Mode	Default
FM Stereo	Mono	Mono	Manual
	Stereo	Mono ↔ Stereo	Change
	SAP	Mono ↔ SAP	Mono

DUAL-

STEREO/MONO, DUAL I / DUAL II and MONO/NICAM MONO/NICAM STEREO can be operated depending on the broadcasting type by using the DUAL button on the remote control while watching TV.

- This is activated when a TV tuner box is installed.

14  ENTER/PRE-CH This button is used to return to the immediately previous channel.

This button is used to return to the immediately previous channel.

- This is activated when a TV tuner box is installed.

15  MUTE Pauses (mutes) the audio output temporarily. This is displayed on the lower left corner of the screen. The audio

Pauses (mutes) the audio output temporarily. This is displayed on the lower left corner of the screen. The audio

comes back on if MUTE or - VOL + is pressed in the Mute mode.

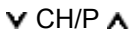
16  CH/P

In **TV** mode, selects TV channels.

- This is activated when a TV tuner box is installed.

17  TV

Selects the TV mode directly.

- This is activated when a TV tuner box is installed.

18  MENU

Opens the on-screen menu and exits from the menu or closes the adjustment menu.

19  RETURN

Returns to the previous menu.

20  EXIT

Exits from the menu screen.

21  MagicInfo

MagicInfo Quick Launch Button.



This button is disabled for products that do not support **MagicInfo**.

Mechanical Layout

Mechanical Layout

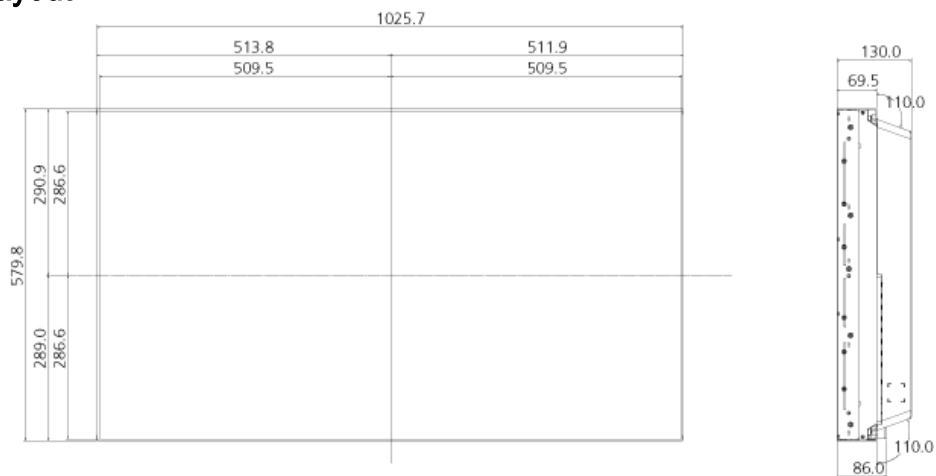

Installation VESA Bracket

- When installing VESA, make sure to comply with the international VESA standards.
- Purchasing VESA Bracket and Installation Information : Please contact your nearest SAMSUNG Distributor to place an order. After your order is placed, installation professionals will visit you and install the bracket.
- At least 2 persons are needed in order to move the LCD Display.
- SAMSUNG is not responsible for any product damage or any injury caused by installation at customer's discretion.

Dimensions

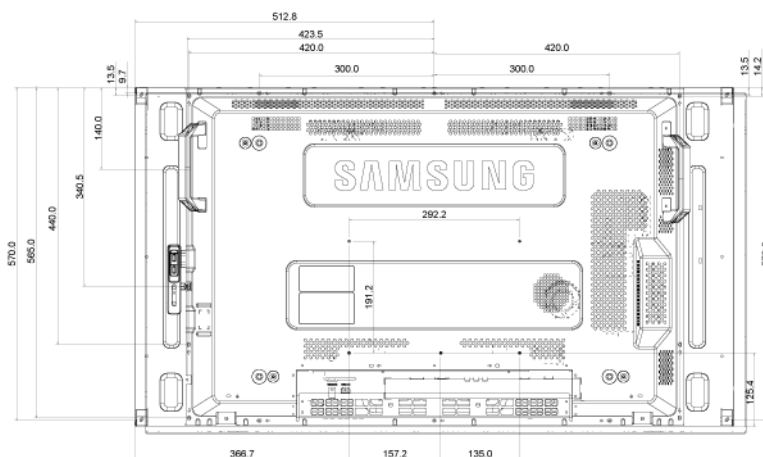
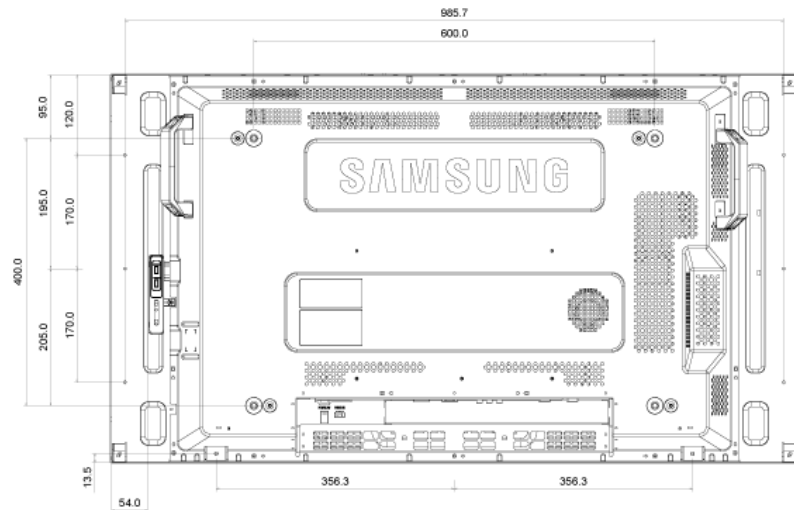

 **Notice**

For securing the bracket on a wall, use only machine screws of 6 mm diameter and 8 to 12 mm length.

Wall Bracket Installation

- Contact a technician for installing the wall bracket.
- SAMSUNG Electronics is not responsible for any damages to the product or harm to customers when the installation is done by the customer.
- This product is for installing on cement walls. The product may not stay in place when installed on plaster or wood.

Components

Only use the components and accessories shipped with the product.

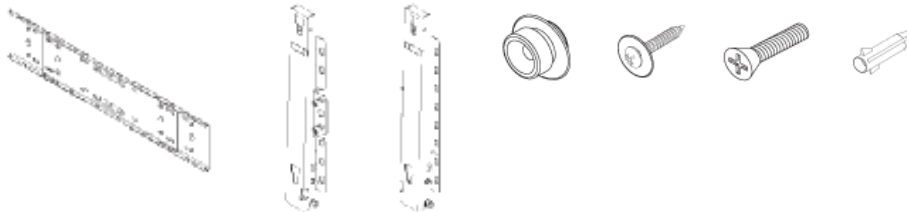

Wall Bracket(1)

Hinge(Left 1, Right
1) Plastic
Hanger
(4)

Screw
(A)(11)

Screw
(B)(4)

Anchor
(11)

Wall Bracket Assembly

 **Note**

There are two hinges(left and right). Use the correct one.

1. Insert and tighten the Captive Screw in the direction of the arrow.

When done, mount the wall bracket on the wall.

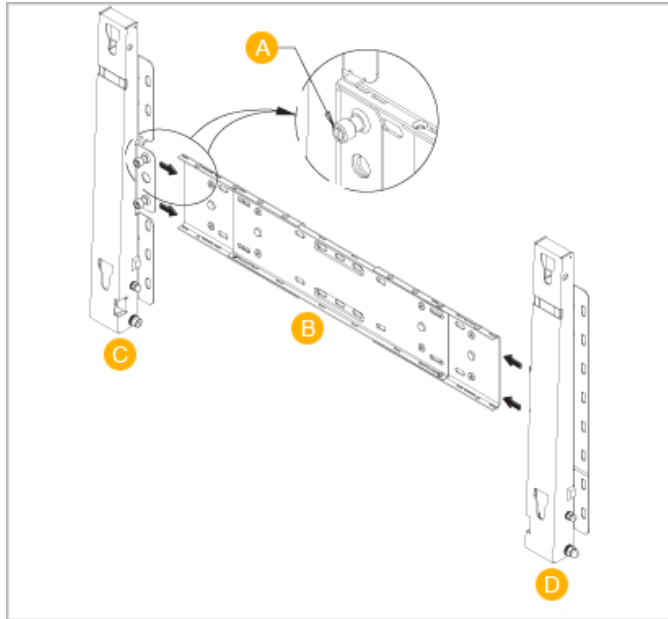

There are two hinges(left and right). Use the correct one.

- A - Captive Screw
- B - Wall Bracket
- C - Hinge (Left)
- D - Hinge (Right)

2. Before drilling into the wall, check if the length between the two locking holes at the back of the product is correct.

If the length is too short or long, loosen all or some of the 4screws on the wall bracket to adjust the length.

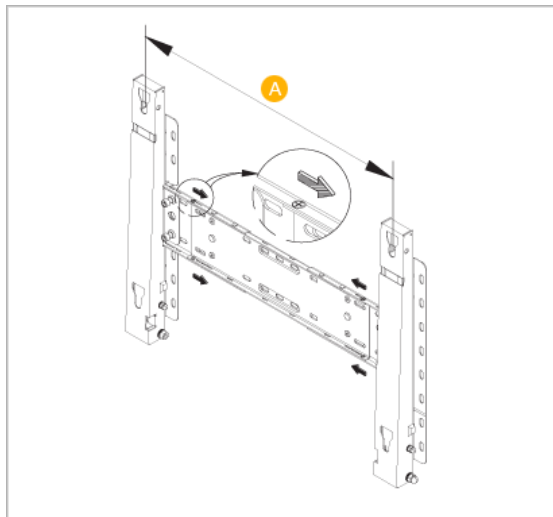

- A - Length between the two locking holes

3. Check the installation diagram and mark the drill points on the wall. Use the 5.0 mm bit to drill holes deeper than 35 mm. Fix each anchor in the corresponding hole. Match each of the brackets and hinge holes to the corresponding anchor holes and insert and tighten the 11 screws A.

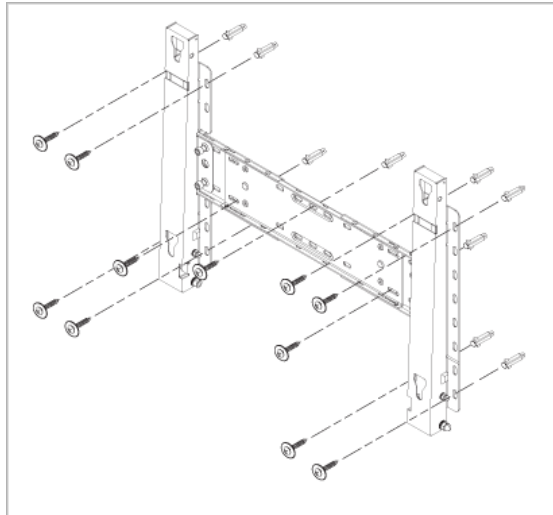

To mount the product on the wall bracket

The shape of the product may vary depending on the model. (The assemblies of the plastic hanger and the screw are the same)

1. Remove the 4 screws on the back of the product.

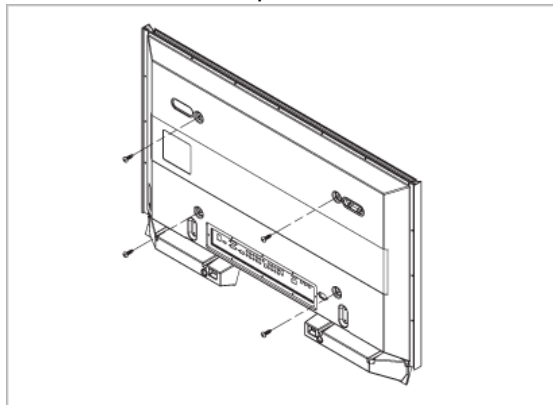

2. Insert the screw B into the plastic hanger.

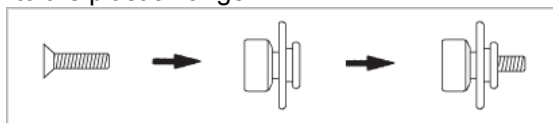

 **Notice**

- Mount the product on the wall bracket and make sure it is properly fixed to the left and right plastic hangers.
 - Be careful when installing the product on the bracket as fingers can be caught in the holes.
 - Make sure the wall bracket is securely fixed to the wall, or the product may not stay in place after installation.
3. Tighten the 4 screws in step 2 (plastic hanger + screw B) to the rear holes of the product.

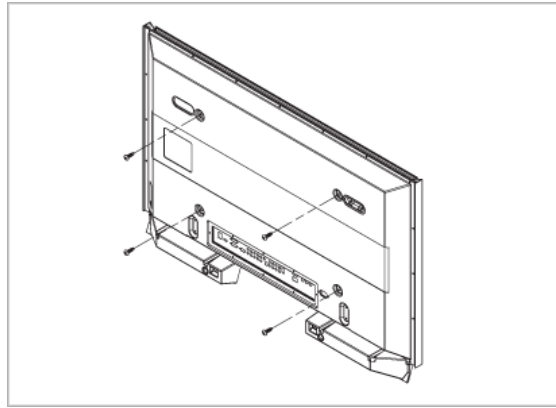

4. Remove safety pin (3) and insert the 4 product holders into the corresponding bracket holes (1). Then place the product(2) so that it is firmly fixed to the bracket. Make sure to re-insert and tighten the safety pin (3) to securely hold the product to the bracket.

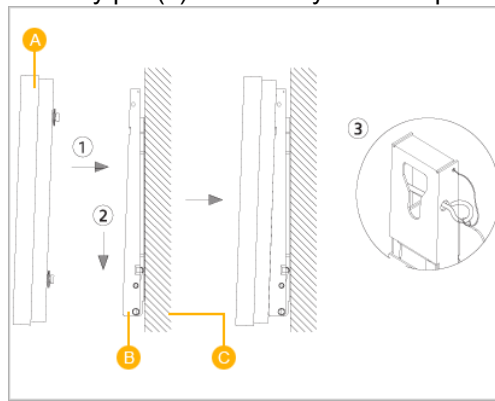

- A - LCD Display
- B - Wall Bracket
- C - Wall

Wall Bracket Angle Adjustment

Adjust the bracket angle to -2° before installing it on the wall.

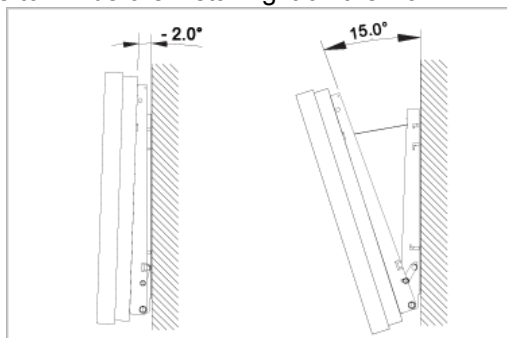

1. Fix the product to the wall bracket.
2. Hold the product at the top in the center and pull it forward (direction of the arrow) to adjust the angle.

 **Note**

You can adjust the bracket angle between -2° and 15° .

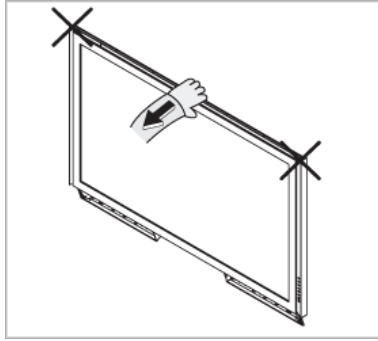

Make sure to use the top center, and not the left or the right side of the product to adjust the angle.

Connections

Connecting a Computer

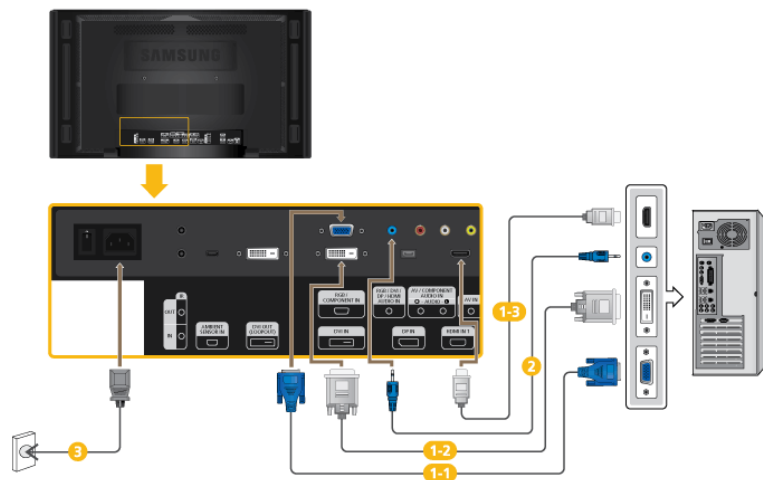

- 1 There are several ways to connect the computer to the monitor. Choose one from the following options.

1-1 Using the D-sub (Analog) connector on the video card.

- Connect the D-sub to the 15-pin, *[RGB/COMPONENT IN]* port on the back of your LCD Display and the 15 pin D-sub Port on the computer.



1-2 Using the DVI (Digital) connector on the video card.

- Connect the DVI Cable to the *[DVI IN]* port on the back of your LCD Display and the DVI port on the computer.



1-3 Using the HDMI (Digital) connector on the video card.

- Connect the *[HDMI IN 1]* port on the LCD Display to the HDMI port on the PC using the HDMI cable.



 **Note**

Select **HDMI2** (only with a 460UT-2, 460UT-B model) or **HDMI1** as an input source when connected to the PC via an HDMI cable.

To obtain normal picture and audio from the PC, **HDMI2** (only with a 460UT-2, 460UT-B model) or **HDMI1** must be selected before **PC** is selected in **Edit Name**.

To enable audio when **DVI Device** is selected, be sure to establish the connection using step (2).

- 2 Connect the Audio cable for your LCD Display to the AUDIO port on the back of the LCD Display.
- 3 Connect the power cord for your LCD Display to the POWER port on the back of the LCD Display. Turn on the power switch.

 **Note**

Contact a local SAMSUNG Electronics Service Center to buy optional items.

Connecting to Other devices

 **Note**

- AV input devices such as DVD players, VCRs or camcorders as well as your computer can be connected to the LCD Display. For detailed information on connecting AV input devices, refer to the contents under Adjusting Your LCD Display.
- The LCD Display 's configuration at the back may vary slightly depending on the LCD Display model.

Connecting an External Monitor

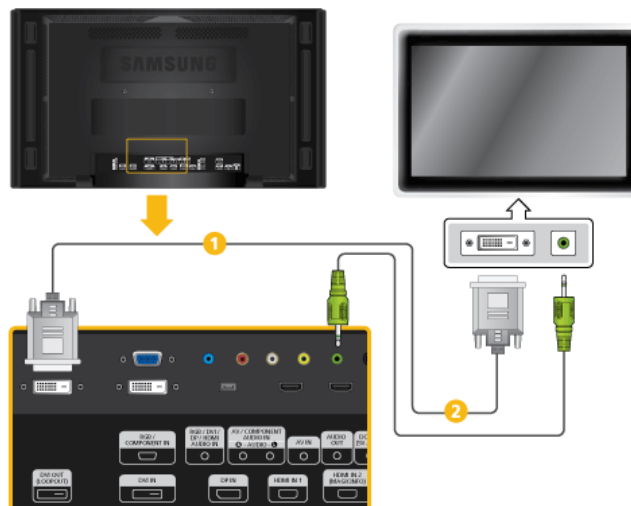

- 1 Connect between the *[DVI OUT(LOOPOUT)]* port on the LCD Display and the input port on another monitor using a DVI cable.
- 2 Connect between the *[AUDIO OUT]* port on the LCD Display and the audio input port on another monitor using a stereo cable.

 **Note**

Select **DVI Mode** as an input source for the external monitor connected to *[DVI OUT]*.

DVI OUT does not support HDCP.

Connecting AV Devices

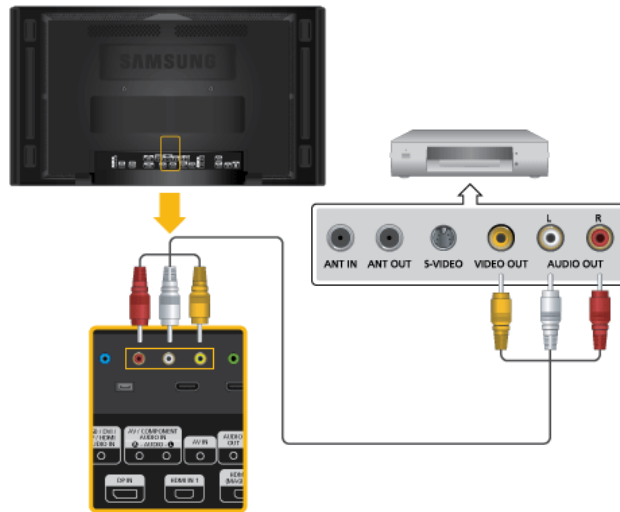

1. Connect an audio cable to *[AV/COMPONENT AUDIO IN [L-AUDIO-R]]* on the product and the audio port on an external device such as a VCR or DVD player.
2. Connect a video cable to *[AV IN]* on the product and the video output port on the external device.
3. Then, start the DVD, VCR or Camcorders with a DVD disc or tape inserted.
4. Press *SOURCE* on the product or remote control and select "**AV**".

 **Note**

AV input devices such as DVD players, VCRs or camcorders as well as your computer can be connected to the LCD Display. For detailed information on connecting AV input devices, refer to the contents under Adjusting Your LCD Display.

Connecting to a Camcorder

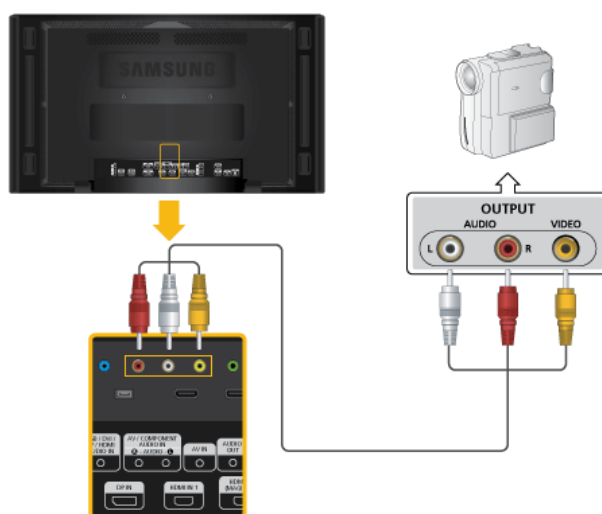

1. Locate the AV output jacks on the camcorder. They are usually found on the side or back of the camcorder. Connect a video cable between the VIDEO OUTPUT jack on the camcorder and the *[AV IN]* on the LCD Display .
2. Connect a set of audio cables between the AUDIO OUTPUT jacks on the camcorder and the *[AV /COMPONENT AUDIO IN [L-AUDIO-R]]* on the LCD Display .
3. Press *SOURCE* on the product or remote control and select "**AV**".
4. Then, start the Camcorders with a tape inserted.

Note

The audio-video cables shown here are usually included with a Camcorder.

(If not, check your local electronics store.)

If your camcorder is stereo, you need to connect a set of two cables.

Connecting Using a HDMI Cable

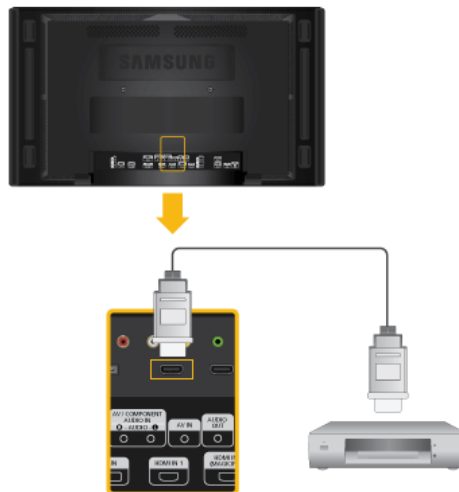

1. Connect an HDMI cable to *[HDMI IN 2 (MAGICINFO)]* (only with a 460UT-2, 460UT-B model) or *[HDMI IN 1]* on the product and the HDMI output port on a digital device.
2. Press *SOURCE* on the product or remote control and select "**HDMI1 / HDMI2**(only with a 460UT-2, 460UT-B model)"

Note

In **HDMI** mode, only PCM format audio is supported.

Connecting Using a DVI to HDMI Cable

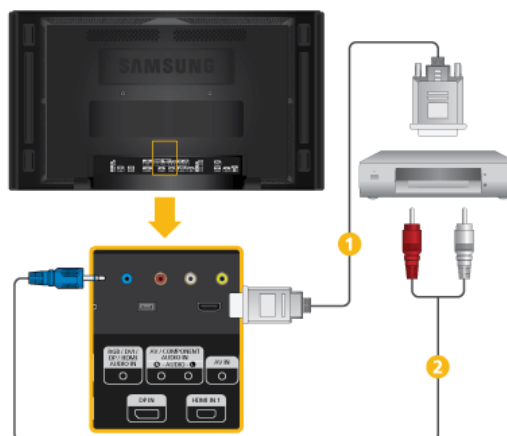

- 1 Connect a DVI-HDMI cable to *[HDMI IN 2 (MAGICINFO)]* (only with a 460UT-2, 460UT-B model) or *[HDMI IN 1]* and the DVI output port on the digital device.
- 2 Connect the red and white jacks of an RCA to stereo (for PC) cable to the same colored audio output terminals of the digital output device, and con-

nect the opposite jack to the *[RGB/DVI/DP/HDMI AUDIO IN]* terminal of the LCD Display.

3. Press *SOURCE* on the product or remote control and select "**HDMI1 / HDMI2**(only with a 460UT-2, 460UT-B model)"

Connecting a DVD Player

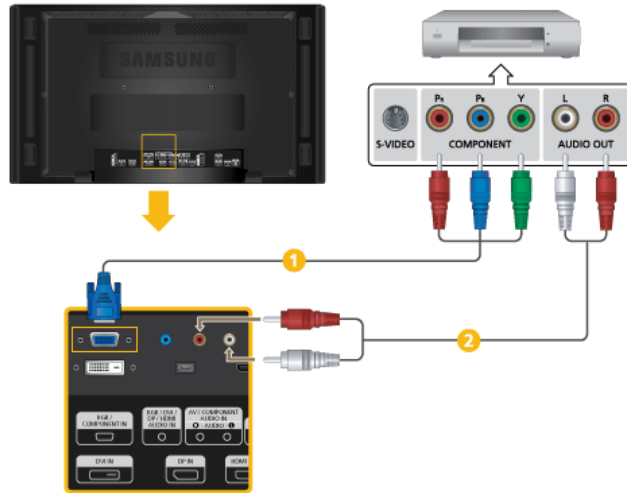

- 1 Connect a RGB to Component cable between the *[RGB/COMPONENT IN]* port on the LCD Display and the P_R, Y, P_B jacks on the DVD player.
- 2 Connect a set of audio cables between the *[AV/COMPONENT AUDIO IN [L-AUDIO-R]]* on the LCD Display and the AUDIO OUT jacks on the DVD player.

Note

- Press *SOURCE* on the product or remote control and select "**Component**".
- Then, start the DVD Player with a DVD disc inserted.
- A RGB to component cable is optional.
- For an explanation of Component video, consult your DVD manual.

Connecting a DTV Set Top (Cable/Satellite) Box

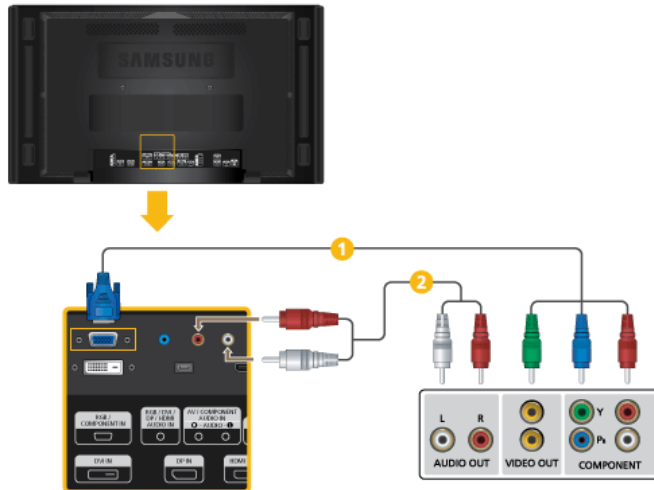

- 1 Connect a RGB to Component cable between the *[RGB/COMPONENT IN]* port on the LCD Display and the P_R, Y, P_B jacks on the Set Top Box.
- 2 Connect a set of audio cables between the *[AV/COMPONENT AUDIO IN [L-AUDIO-R]]* on the LCD Display and the AUDIO OUT jacks on the Set Top Box.

Note

- Press *SOURCE* on the product or remote control and select "**Component**".
- For an explanation of Component video, see your Set Top Box owner's manual.

Connecting to an Audio System

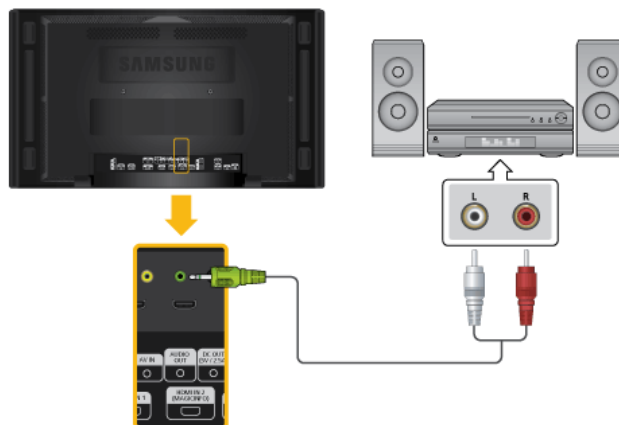

1. Connect a set of audio cables between the AUX L, R jacks on the AUDIO SYSTEM and *[AUDIO OUT]* on LCD Display.

Connecting a LAN Cable

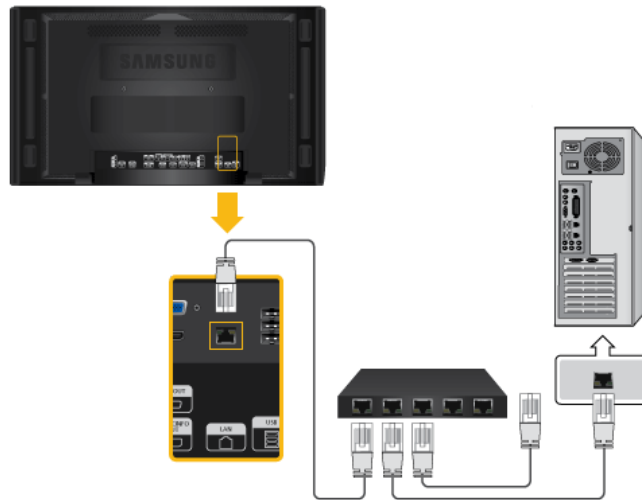

1. Connect the LAN cable between the [LAN] port on the product and the [LAN] port on your PC.

 **Note**

Applicable to the 460UTn-2, 460UTn-B model only.

Connecting a USB devices

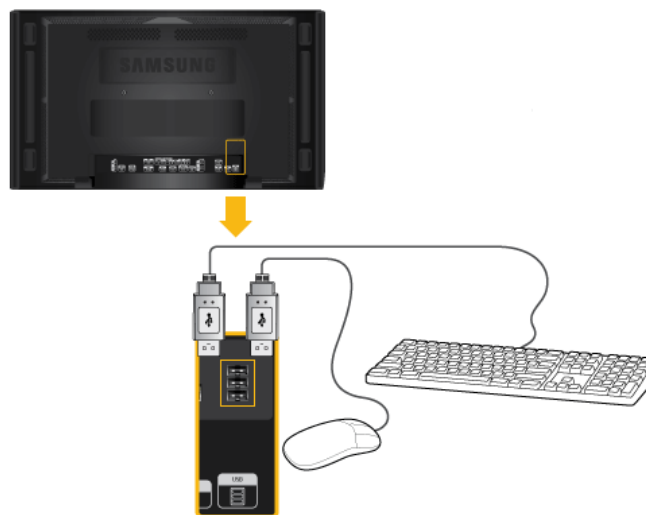

1. You can connect USB devices such as a mouse or keyboard.

 **Note**

Applicable to the 460UTn-2, 460UTn-B model only.

Using the Software

Monitor Driver



Note

When prompted by the operating system for the monitor driver, insert the CD-ROM included with this monitor. Driver installation is slightly different from one operating system to another. Follow the directions appropriate for the operating system you have.

Prepare a blank disk and download the driver program file at the Internet web site shown here.

Internet web site :

<http://www.samsung.com/>

Installing the Monitor Driver (Automatic)

1. Insert CD into the CD-ROM drive.
2. Click "Windows".
3. Choose your monitor model in the model list, then click the "OK" button.

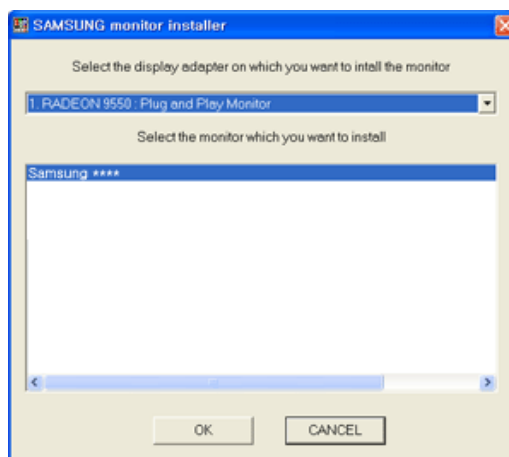

4. If you can see following message window, then click the "Continue Anyway" button. Then click "OK" button (Microsoft® Windows® XP/2000 Operating System).





Note

This monitor driver is certified by Microsoft, and installing it will not damage your system.

The certified driver will be posted on Samsung Monitor homepage.

<http://www.samsung.com/>

Installing the Monitor Driver (Manual)

Microsoft® Windows Vista™, Operating System

1. Insert your Manual CD into your CD-ROM drive.
2. Click  (Start) and "Control Panel". Then, double-click on "Appearance and Personalization".



3. Click "Personalization" and then "Display Settings".



4. Click "Advanced Settings...".



5. Click "Properties" in the "Monitor" tab. If the "Properties" button is deactivated, it means the configuration for your monitor is completed. The monitor can be used as is.

If the message "Windows needs..." is displayed, as shown in the figure below, click "Continue".



 **Note**

This monitor driver is under certifying MS logo, and this installation will not damage your system.

The certified driver will be posted on Samsung Monitor homepage.

6. Click "Update Driver..." in the "Driver" tab.

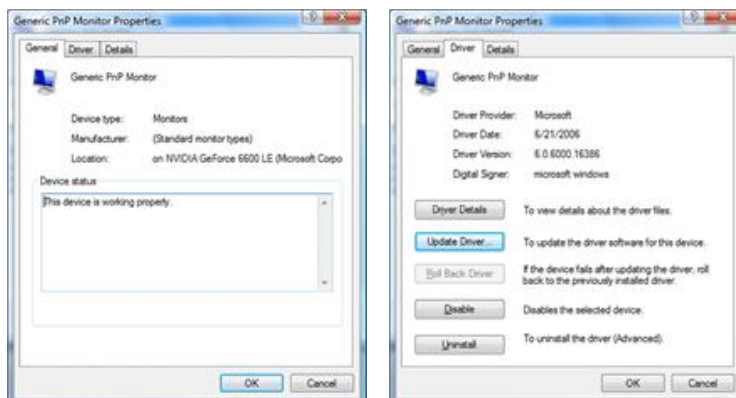

7. Check the "Browse my computer for driver software" checkbox and click "Let me pick from a list of device drivers on my computer".

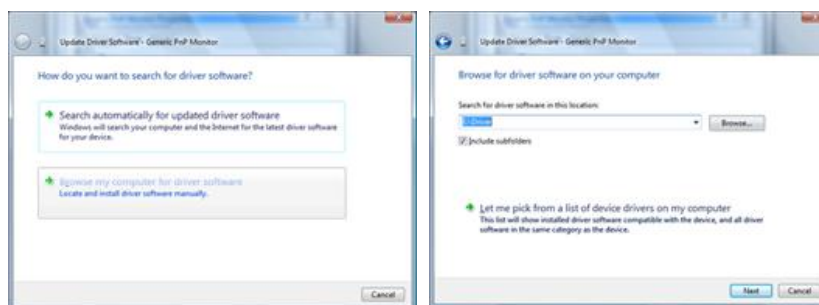

8. Click "Have Disk..." and select the folder (for example, D:\Drive) where the driver setup file is located, and click "OK".

Using the Software

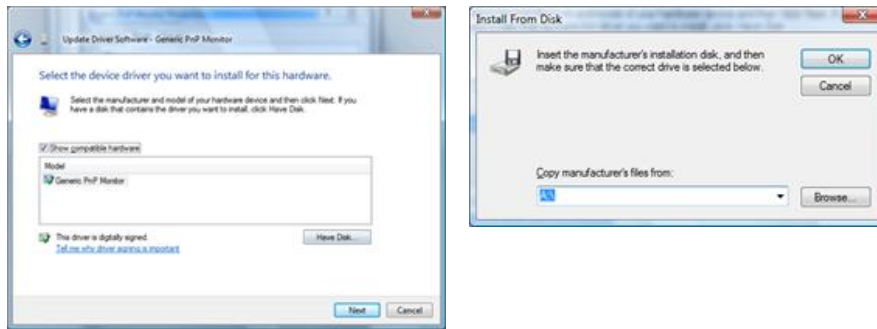

9. Select the model that matches your monitor from the list of monitor models on the screen, and click "Next".

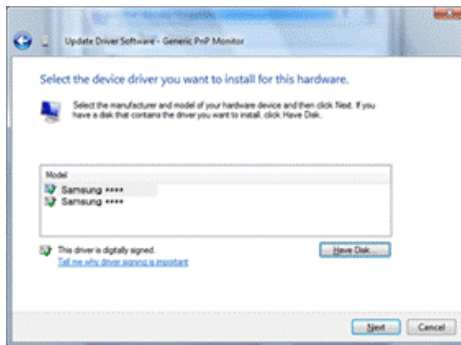

10. Click "Close" → "Close" → "OK" → "OK" on the following screens displayed in sequence.

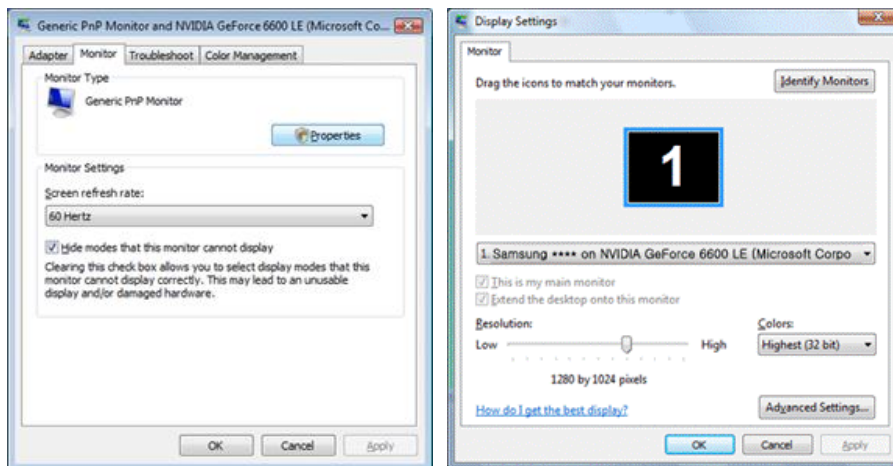
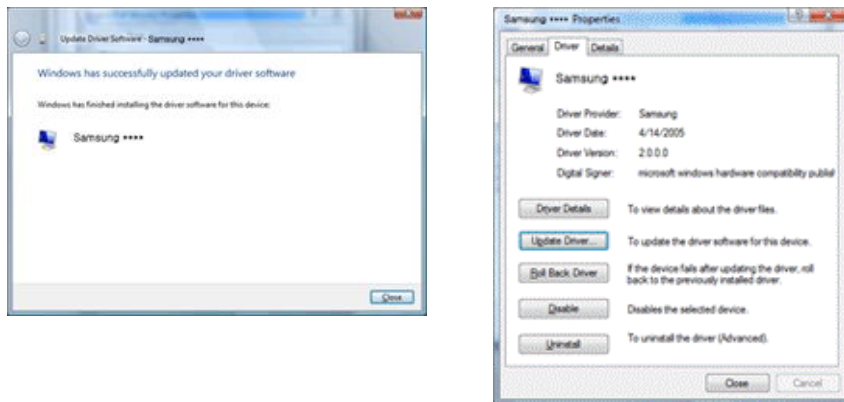

Microsoft® Windows® XP Operating System

1. Insert CD into the CD-ROM drive.
2. Click "Start" → "Control Panel", then click the "Appearance and Themes" icon.

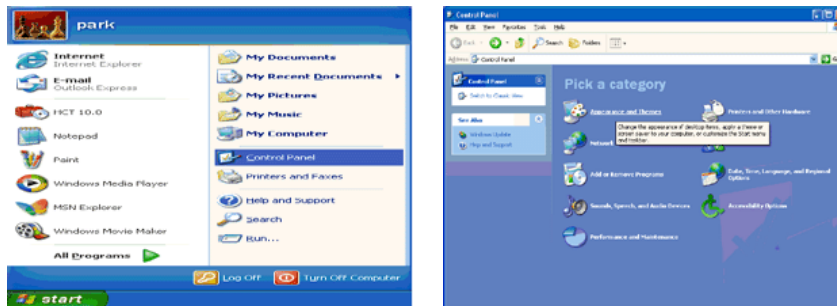

3. Click "Display" icon and choose the "Settings" tab then click "Advanced...".

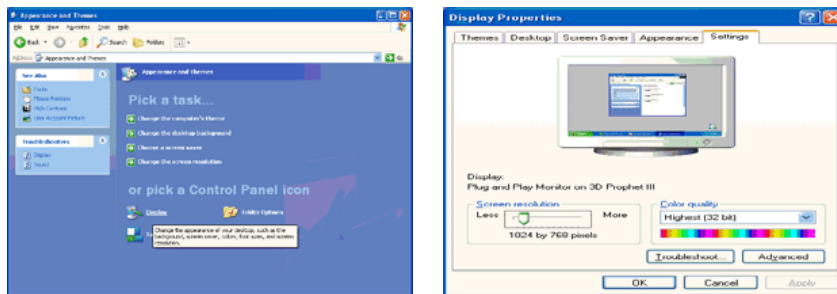

4. Click the "Properties" button on the "Monitor" tab and select "Driver" tab.

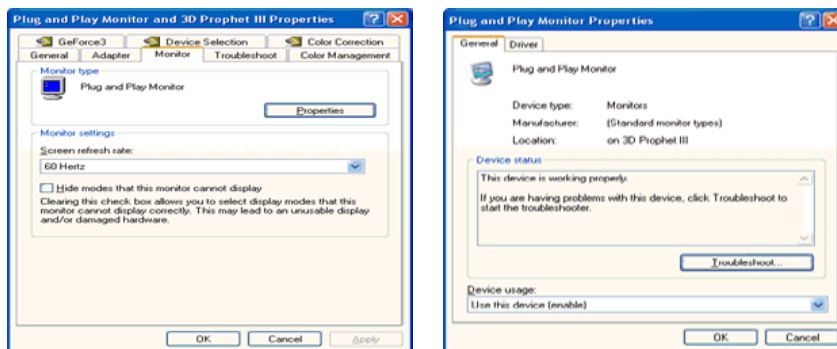

5. Click "Update Driver..." and select "Install from a list or..." then click "Next" button.

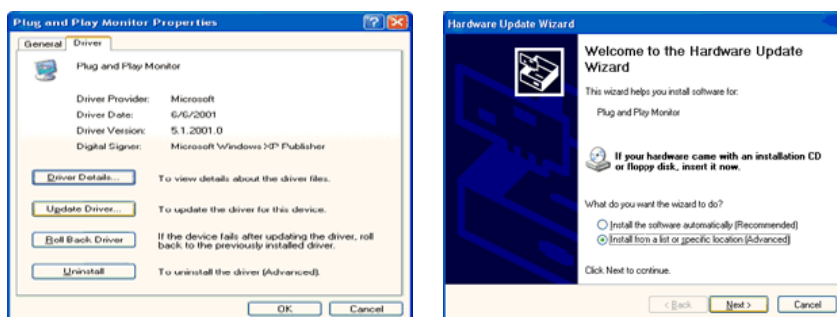

6. Select "Don't search, I will...", then click "Next" and then click "Have disk".

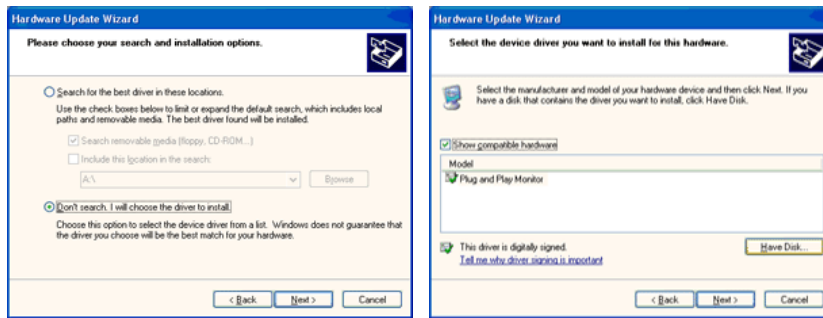

7. Click the "Browse" button then choose A:(D:\Driver) and choose your monitor model in the model list and click the "Next" button.

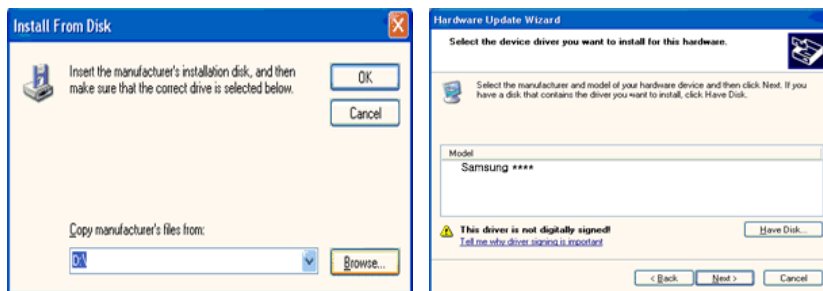

8. If you can see the following message window, then click the "Continue Anyway" button. Then click "OK" button.



Note

This monitor driver is certified by Microsoft, and this installation will not damage your system.

The certified driver will be posted on Samsung Monitor homepage.

<http://www.samsung.com/>

9. Click the "Close" button, then click the "OK" button continually.

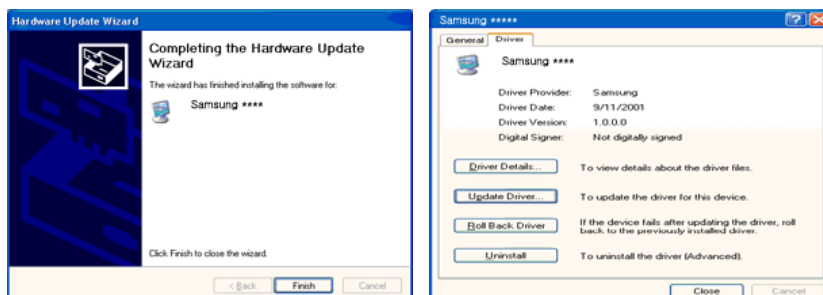



10. Monitor driver installation is completed.

Microsoft® Windows® 2000 Operating System

When you can see "Digital Signature Not Found" on your monitor, follow these steps.

1. Choose "OK" button on the "Insert disk" window.
2. Click the "Browse" button on the "File Needed" window.
3. Choose A:(D:\Driver), then click the "Open" button and then click "OK" button.

How to install

1. Click "Start", "Setting", "Control Panel".
2. Double click the "Display" icon.
3. Select the "Settings" tab and click "Advanced Properties" button.
4. Choose "Monitor".

Case1 : If the "Properties" button is inactive, it means your monitor is properly configured. Please stop installation

Case2 : If the "Properties" button is active, click the "Properties" button, then follow the next steps.

5. Click "Driver" and then click on "Update Driver...", then click on the "Next" button.
6. Choose "Display a list of the known drivers for this device so that I can choose a specific driver", then click "Next" and then click "Have disk".
7. Click the "Browse" button, then choose A:(D:\Driver).
8. Click the "Open" button, then click "OK" button.
9. Choose your monitor model and click the "Next" button. Then click "Next" button.
10. Click the "Finish" button, then the "Close" button.

If you can see the "Digital Signature Not Found" window, then click the "Yes" button. Then click the "Finish" button and the "Close" button.

Microsoft® Windows® Millennium Operating System

1. Click "Start", "Setting", "Control Panel".
2. Double click the "Display" icon.
3. Select the "Settings" tab and click "Advanced Properties" button.

4. Select the "Monitor" tab.
5. Click the "Change" button in the "Monitor Type" area.
6. Choose "Specify the location of the driver".
7. Choose "Display a list of all the driver in a specific location...", then click "Next" button.
8. Click the "Have Disk" button.
9. Specify A:\(D:\driver), then click "OK" button.
10. Select "Show all devices" and choose the monitor that corresponds to the one you connected to your computer and click "OK".
11. Continue choosing "Close" button and "OK" button until you close the Display Properties dialogue box.

Microsoft® Windows® NT Operating System

1. Click "Start", "Settings", "Control Panel", and then double-click "Display" icon.
2. In Display Registration Information window, click Settings Tab and then click "All Display Modes".
3. Select a mode that you wish to use (Resolution, Number of colors and Vertical frequency) and then click "OK".
4. Click "Apply" button if you see the screen working normally after clicking "Test". If the screen is not normal, change to a different mode (lower mode of resolution, colors or frequency).



Note

If there is no Mode at All Display Modes, select the level of resolution and vertical frequency by referring to the Preset Timing Modes in the user guide.

Linux Operating System

To execute X-Window, you need to make the X86Config file, which is a type of system setting file.

1. Press "Enter" at the first and the second screen after executing the X86Config file.
2. The third screen is for setting your mouse.
3. Set a mouse for your computer.
4. The next screen is for selecting a keyboard.
5. Set a Keyboard for your computer.
6. The next screen is for setting your monitor.
7. First of all, set a horizontal frequency for your monitor. (You can enter the frequency directly.)
8. Set a vertical frequency for your monitor. (You can enter the frequency directly.)
9. Enter the model name of your monitor. This information will not affect the actual execution of X-Window.

10. You have finished setting up your monitor. Execute X-Window after setting other requested hardware.

MDC(Multiple Display Control)



Installation

1. Insert the installation CD into the CD-ROM drive.
2. Click the MDC System installation program.
3. If the installation wizard screen does appear, click "Next."
4. The "License Agreement" screen will appear. Click "Yes."
5. The "Customer Information" window will appear. Register the user information and click "Yes."
6. The "Choose Destination Location" window will appear. Specify the file location to install to and click "Next."



If the file location is not specified, the program will be installed in the default file location.

7. The "Start Copying Files" window will appear. Confirm the file location and click "Next."
8. The installation progress screen will appear.
9. The "InstallShield Wizard Complete" screen will appear. Click "Finish."



Select " Launch MDC System" and click "Finish." The MDC program will immediately be run.



10. If the installation is successfully completed, the quick MDC System execution icon will appear on the desktop.

MDC execution icon may not appear depending on specification of computer system or monitor. If that happens, press F5 Key.

Installation Problems

The installation of MDC can be affected by such factors as the video card, motherboard and the network environment.

Uninstall

The MDC program can be removed only by using the "Add or Remove Programs" option of the Windows® Control Panel.

Perform the following steps remove MDC.

Select "Setting/Control Panel" on the "Start" menu and then double-click "Add/Delete a program".

Select MDC System from the list and then click the "Add/Delete" button.

■ Using Serial MDC

■ Using Ethernet MDC

MDC System

Introduction

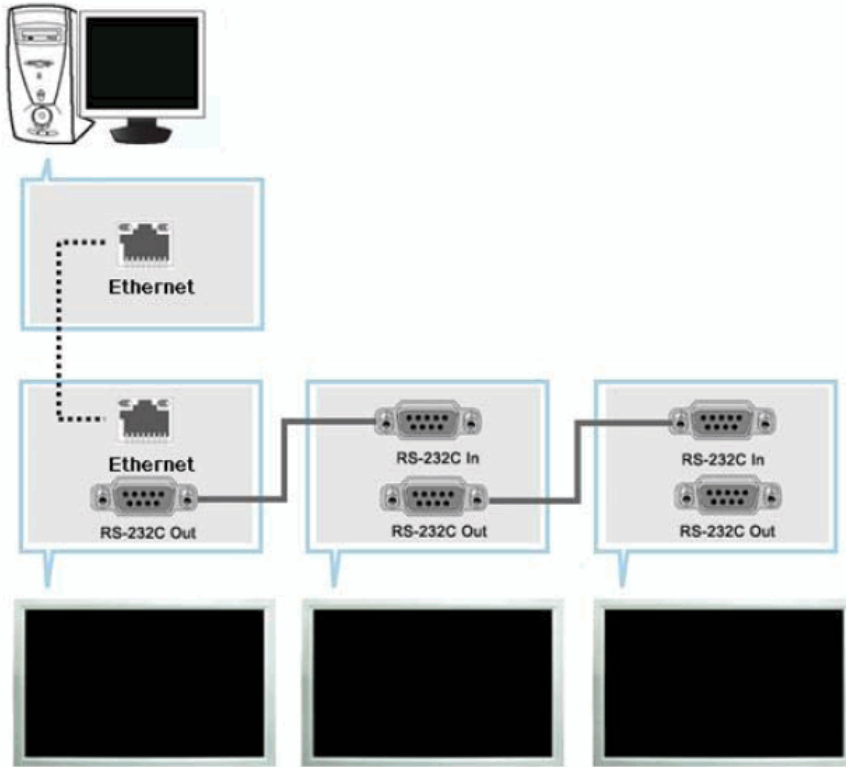

Unlike the previous method which used the serial data communication specifications RS-232C, an Ethernet function has been added. Connect the first display device and the PC by entering the IP address. To connect to another display device, use an RS-232C serial cable. Refer to the figure above.

Main Screen

Click Start > Program > Samsung > MDC System to start the program.

Select a set to see the volume of the selected set within the slider.

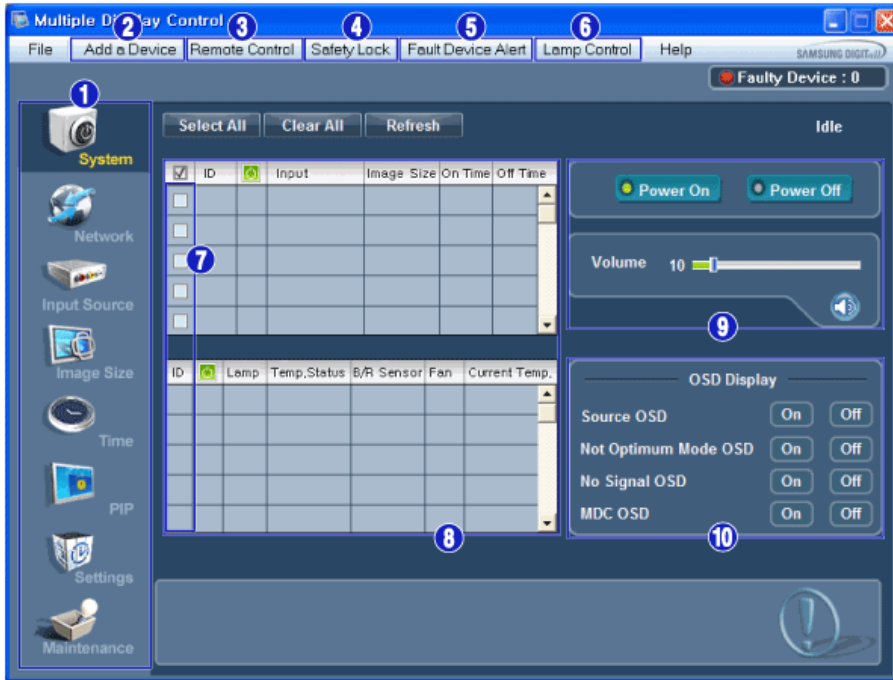

- | | |
|----------------------|---------------------|
| ① Main Icons | ⑥ Lamp Control |
| ② Add a Device | ⑦ Display Selection |
| ③ Remote Control | ⑧ All |
| ④ Safety Lock | ⑨ Control Tools |
| ⑤ Fault Device Alert | ⑩ OSD Display |

1. Use the main icons to switch into each screen.
2. You can add a device by entering the IP address configured on the monitor.
3. Allows you to enable or disable the remote control signal receiving function of the display unit.
4. Set the Safety Lock function.
When setting the Lock function, you can only operate power and lock buttons on the remote control and set.
5. When connecting to the monitor fails, it turns the function that transfers the result through an email on or off.
6. Selects a Lamp adjustment mode.
7. Select a display from Display Selection.
8. All of the monitors can be selected or deselected.
9. Use Control Tools to control displays.
10. Switches the OSD function On/Off.
- May not be supported depending on the product.

<Note> The remote control Enable/Disable function operates whether or not the power is On/Off, and this applies to all displays connected to the MDC. However, regardless of the status at the time the MDC is shut down, the remote control signal receiving function of all displays is initialized to Enable when the MDC is closed.

Add a Device

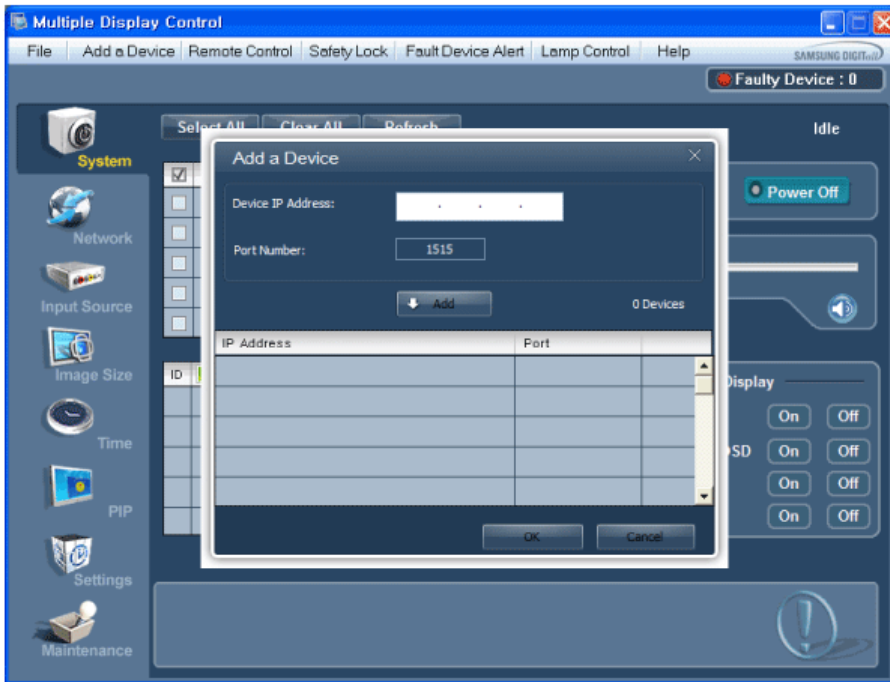

1. Enter the IP address of the monitor to be connected and press the Add button to add the IP address. If you click the OK button, adding the monitor is completed.



System

1. Click System in the main menu to open the system adjustment screen.

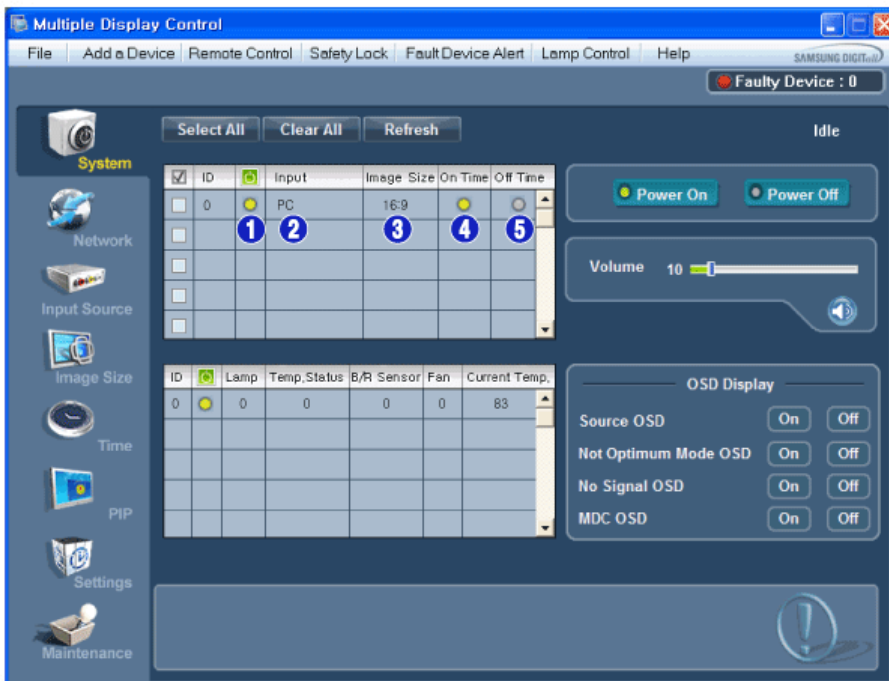

✱ Info Grid shows some basic information necessary to System.

- 1) (Power Status)
- 2) Input
- 3) Image Size
- 4) On Timer
- 5) Off Timer

2. Selects displays you want to adjust using the Select All button or checkboxes.

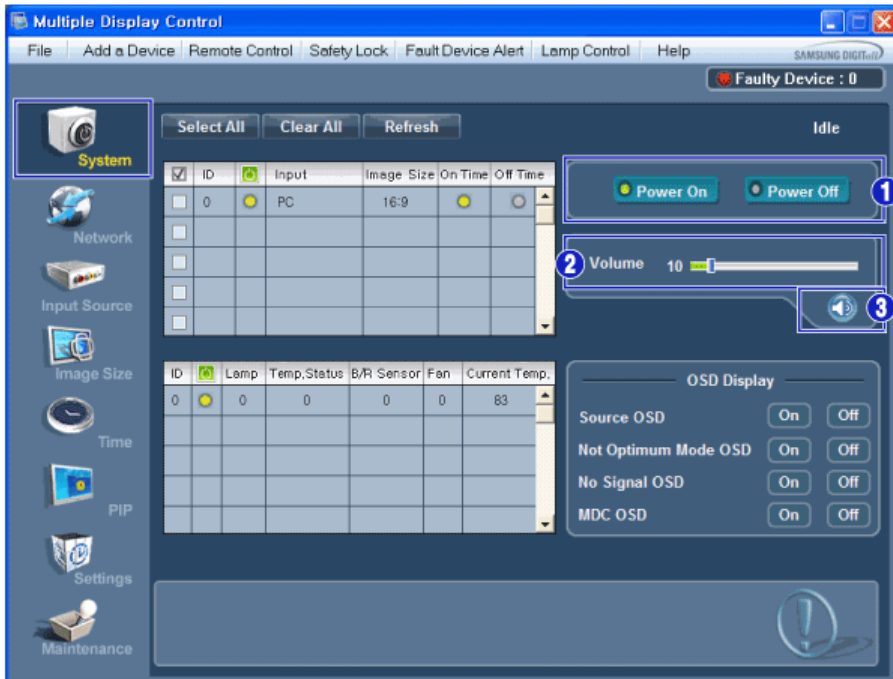

* System allows controlling some of the functions of the selected display.

1) Power On/Off

- Turns the power of the selected display On/Off.

2) Volume

- Controls the volume level of the selected display.

It receives the volume value of the selected display from the sets and displays it in the slider.

(If you deselect a single display or all displays, the default value 10 will be restored.)

3) (Mute On/Off)

- Turns on/off the Mute function of the selected display.

When selecting one set at a time, turn on the Mute function for the selected set.

The Mute function is disabled automatically when you adjust the volume level.

(The values return to the default settings when you undo the selections or choose "Select All".)

* **The Volume Control and Mute features are available only for the displays whose power status is ON.**

3. Selects whether to display the menu screen using the OSD Display menu.

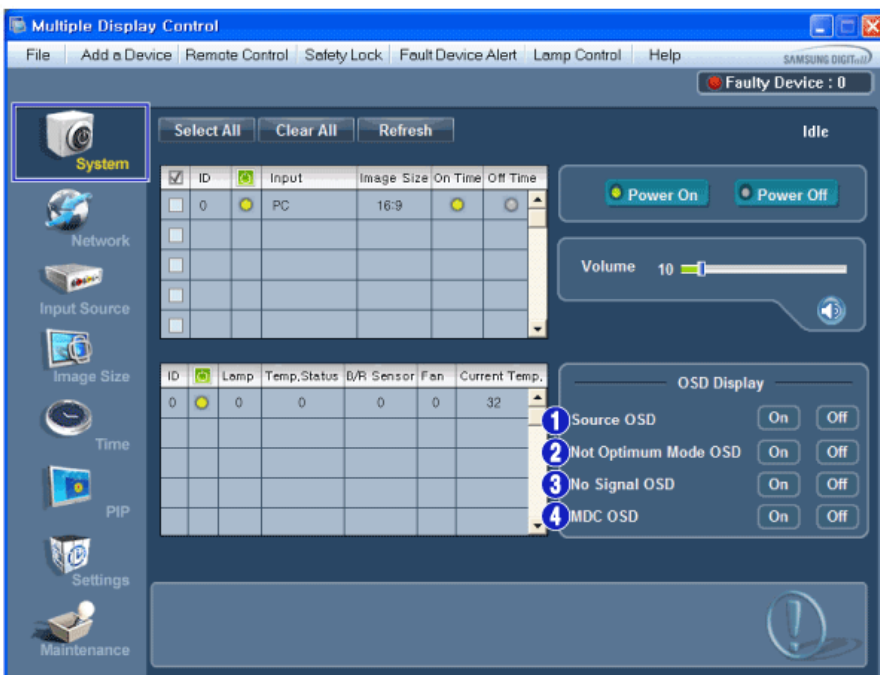

1) Source OSD

- Sets whether the Source OSD will be displayed to indicate when the Source is changed.
- 2) Not Optimum Mode OSD
 - Sets whether the Optimum Mode OSD will be displayed to indicate if the current mode is not supported.
- 3) No Signal OSD
 - Sets whether the No Signal OSD will be displayed to indicate when there is no signal.
- 4) MDC OSD
 - Sets whether the MDC OSD will be displayed to indicate when the settings are changed using the MDC.

Network

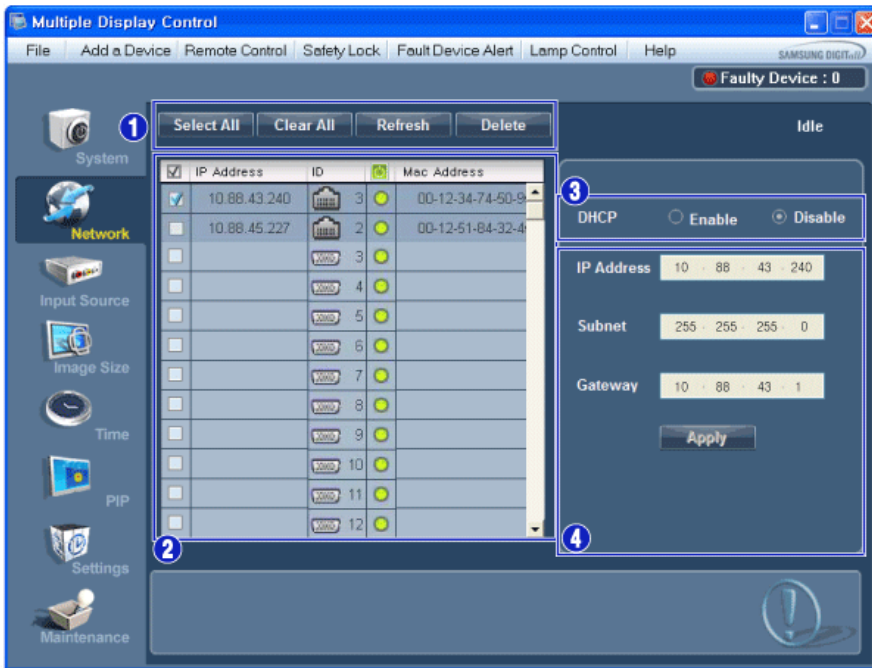

- 1) Select or clear all the added devices; or refresh or delete selected devices.
- 2) The IP Address, ID (Ethernet or Serial), Mac Address and connection status of the connected monitor is displayed.
- 3) It can automatically check whether DHCP IP is set and then set the IP address.
- 4) It can automatically or manually set and then apply the IP Address, Subnet and Gateway of the selected monitor.

Input Source

- 1) Click Input Source of the main icons and the Input Source control screen appears. Selects displays you want to adjust using the Select All button or checkboxes.

- TV Mode

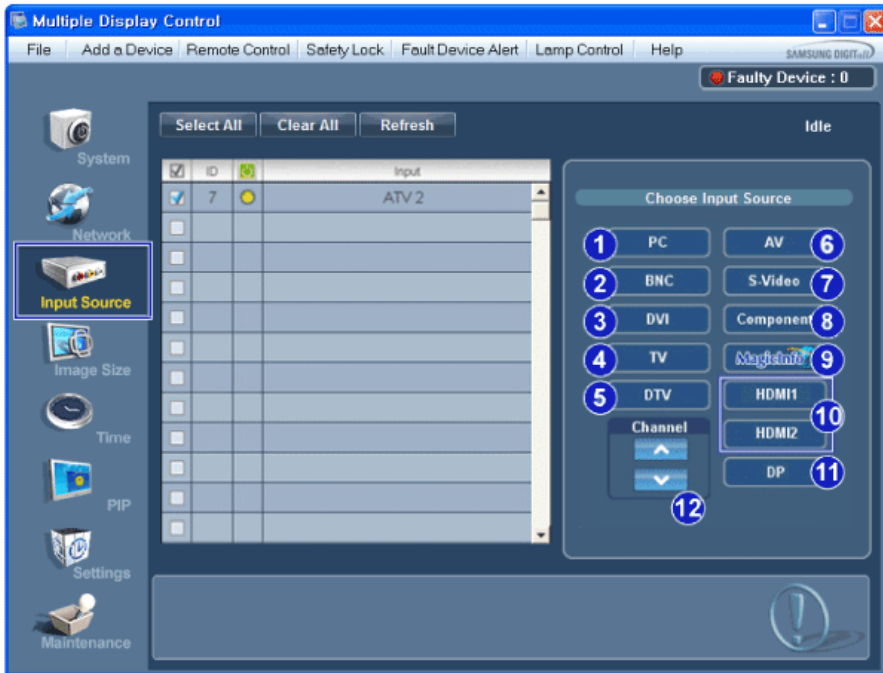

- PC Mode

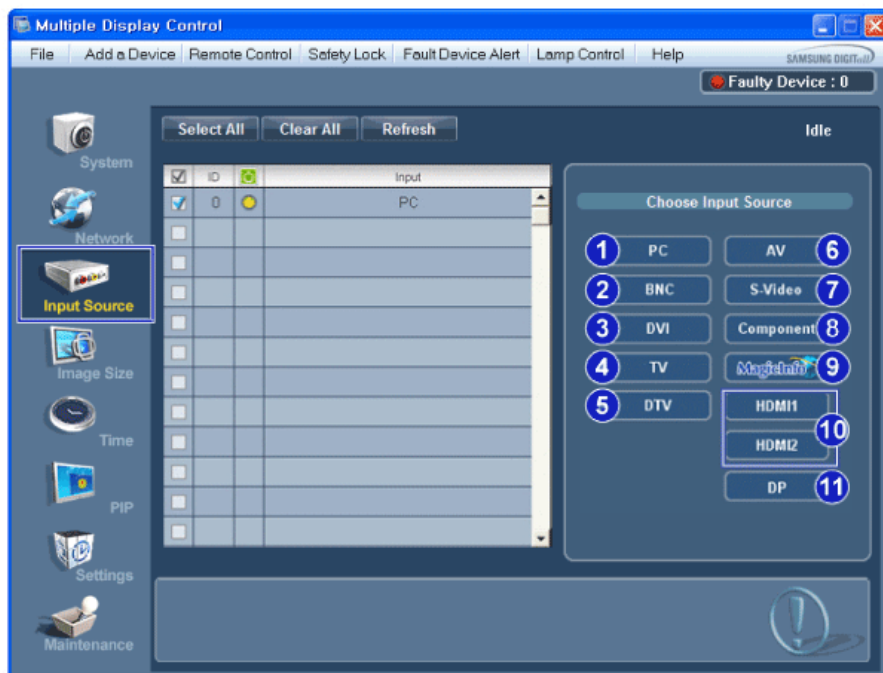

✱ Info Grid shows some basic information necessary to Input Source Control.

- 1) PC
- Changes the Input Source of the selected display to PC.
- 2) BNC
- Changes the Input Source of the selected display to BNC.
- 3) DVI
- Changes the Input Source of the selected display to DVI.
- 4) TV
- Changes the Input Source of the selected display to TV.
- 5) DTV
- Changes the Input Source of the selected display to DTV.
- 6) AV
- Changes the Input Source of the selected display to AV.
- 7) S-Video
- Changes the Input Source of the selected display to S-Video.
- 8) Component

- Changes the Input Source of the selected display to Component.
 - 9) MagicInfo
 - The Input source of MagicInfo works only on MagicInfo model.
 - 10) HDMI1/HDMI2
 - Changes the Input Source of the selected display to HDMI.
 - 11) DP
 - Switches the input source for the selected display to DP.
 - 12) Channel
 - Channel arrow appears when the Input Source is TV.
- * **HDMI2 may not be supported depending on the product.**
 * **DP may not be supported depending on the product.**
 * **The Input Source Control feature is available only for the displays whose power status is ON.**
 * **TV Source can be selected only in products with TV and controlling channels is allowed only when Input Source is TV.**

Image Size

PC, BNC, DVI, DP

1. Click Image Size of the main icons and the Image Size control screen appears.

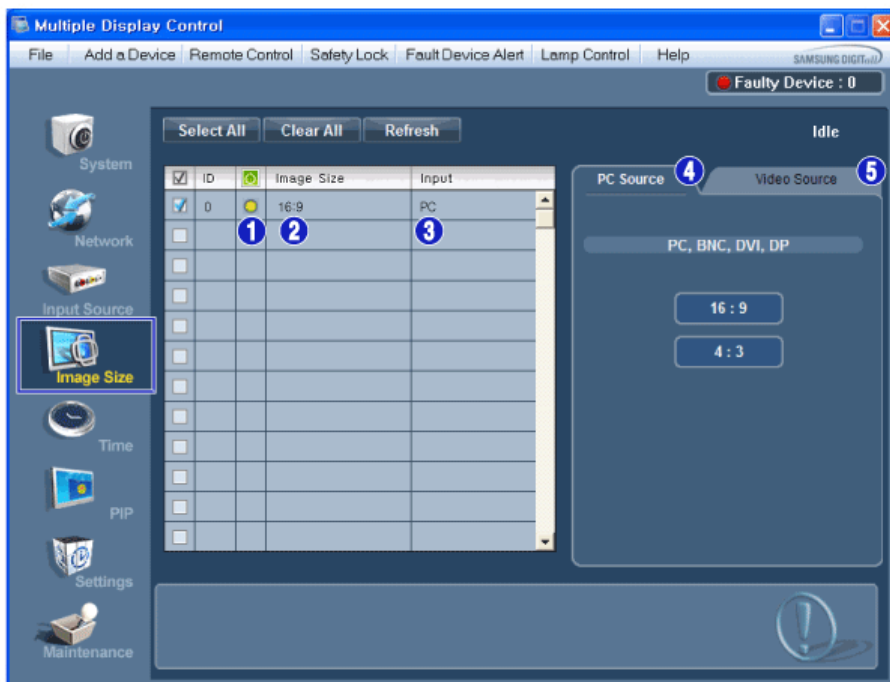

* Info Grid shows some basic information necessary to Image Size Control.

- 1)  (Power Status)
 - Shows the power status of the current display.
- 2) Image Size
 - Shows the current Image Size of the display in use.
- 3) Input
 - Info Grid displays only the displays whose Input Source is PC, BNC, DVI and DP.
- 4) PC Source
 - Click Image Size in the main menu to display the PC, BNC, DVI and DP tabs.
 - The Image Size Control button controls Image Size available for PC, BNC, DVI and DP.
- 5) Video Source
 - Click the Video Source tab to control Image Size for respective Input Source.

- * **The Input source of MagicInfo works only on MagicInfo model.**
 * **The Input source of TV works only on TV model.**
 * **Image Size Control is available only for the displays for which power status is ON.**
 * **DP may not be supported depending on the product.**



Image Size

TV, AV, S-Video, Component, DVI(HDCP), HDMI1, HDMI2, DTV

1. Click Image Size of the main icons and the Image Size control screen appears.

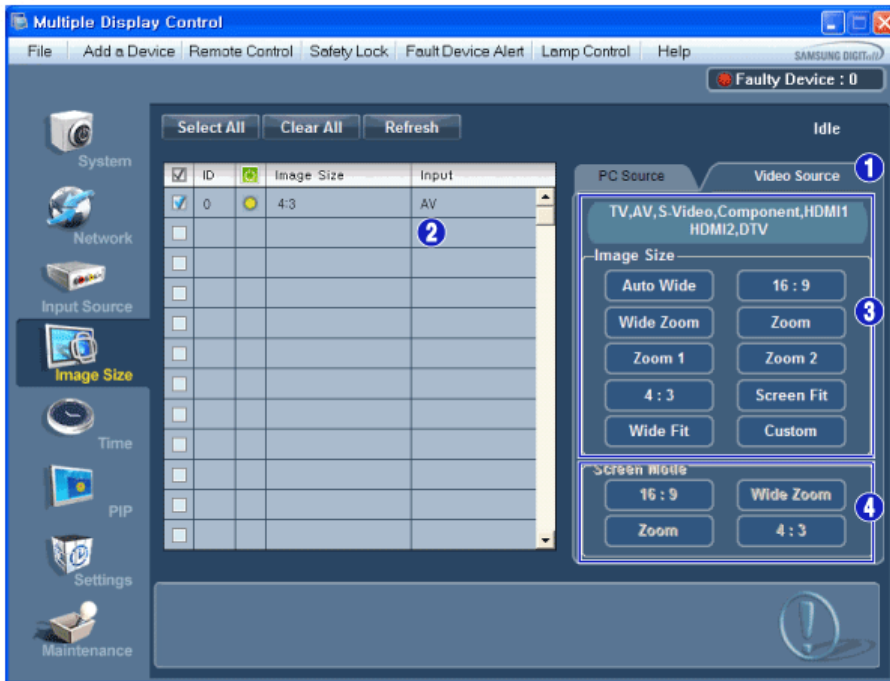

* Info Grid shows some basic information necessary to Image Size Control.

- 1) To adjust Image Size in TV, AV, S-Video, Component, HDMI1, HDMI2 or DTV mode, click the Video Source tab.
Select the display you want to adjust by using the Select All button or by checking the checkbox.
- 2) Info Grid displays only the display having TV, AV, S-Video, Component, HDMI1, HDMI2 or DTV as input source.
- 3) Switch Image Size of the selected display randomly.
- 4) The screen modes can only be adjusted when a TV (PAL only) is connected and the Image Size item is set to Auto Wide.

* **Custom may not be supported depending on the product.**

* **Auto Wide, Zoom1 and Zoom2 are not available for selection when the input signal type for Component and DVI (HDCP) is 720p or 1080i.**
(The Auto Wide mode is available only for TV, AV, and S-Video.)

* **The Input source of MagicInfo works only on MagicInfo model.**

* **The Input source of TV works only on TV model.**

* **The Image Size Control feature is available only for the displays whose power status is ON.**

* **HDMI2 may not be supported depending on the product.**



Time

1. Click Time of the main icons and the Time Control screen appears.

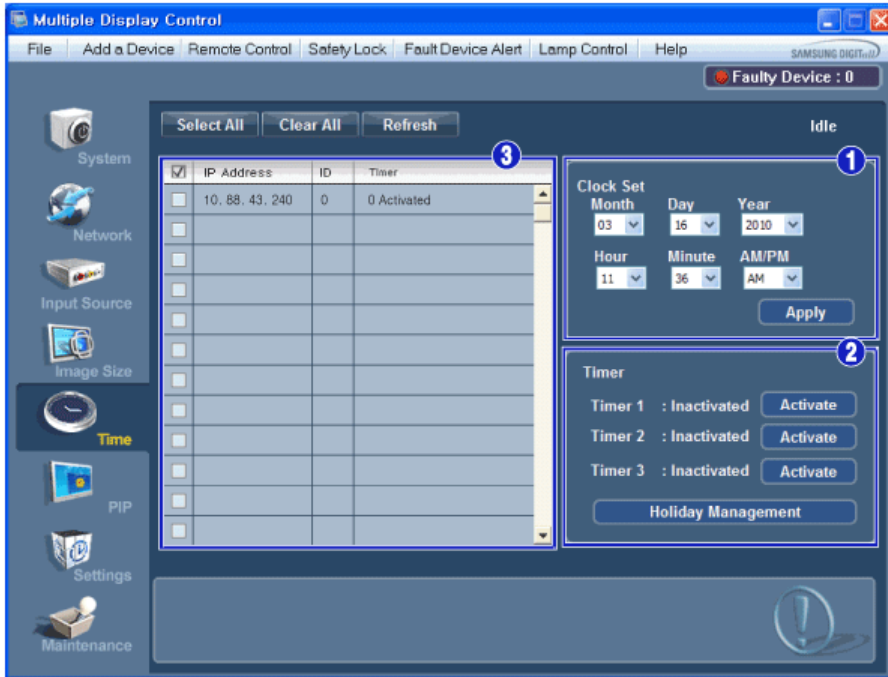

✱ Info Grid shows some basic information necessary to Time Control.

1) Clock Set

- Set the current time for the selected display (PC Time).
- To change the current time, first change the PC Time.

2) Timer

- Sets up Timer1, Timer2, Timer3 and Holiday Management.

3) Shows whether Timer is activated.

✱ **The Input source of MagicInfo works only on MagicInfo model.**

✱ **The Input source of TV works only on TV model.**

✱ **Time Control is available only for the displays for which the power status is ON.**



Time

Setting up Timer and Holiday Management

1. Setting up Timer1, Timer2 and Timer3

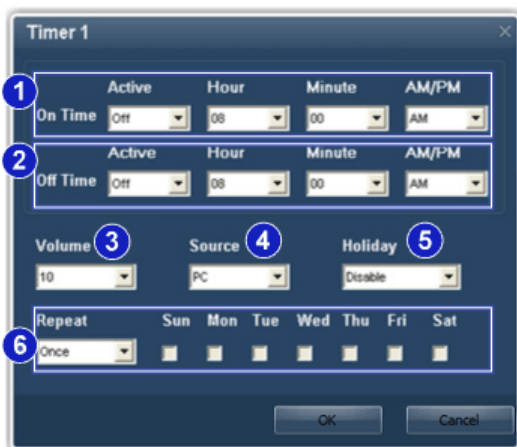

1) On Time

- Sets the time in hours, in minutes and as AM/PM for turning the selected monitor on.

2) Off Time

- Sets the time in hours, in minutes and as AM/PM for turning the selected monitor off.

3) Volume

- Selects the volume when the selected monitor is turned on.

4) Source

- Selects the external input source that will be displayed when the selected monitor is turned on.

- 5) Holiday
 - Applies the Holiday Management function to the Timer.
- 6) Repeat
 - Available selections include Once, EveryDay, Mon~Fri, Mon~Sat, Sat~Sun, and Manual.
 - Once : The Timer goes off only once.
 - EveryDay : EveryDay: The Timer repeats daily.
 - Mon~Fri : The Timer repeats from Monday through Friday.
 - Mon~Sat : The Timer repeats from Monday through Saturday.
 - Sat~Sun : Sat~Sun: The Timer goes off on Saturday and Sunday.
 - Manual : Select a day of the week you want the Timer to go off.

2. Setting Holiday Management

The Holiday Management function specifies the dates in which the monitor will not be turned on or off by the Timer.

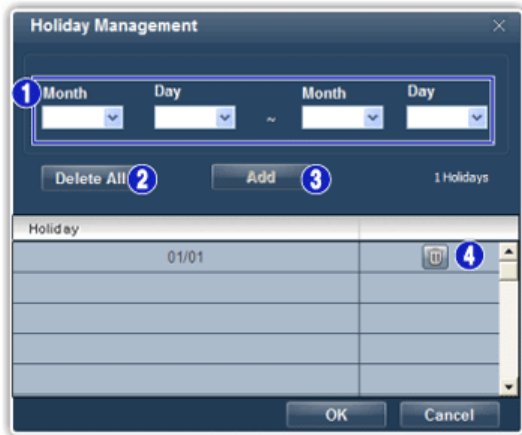

- 1) Specifies the date.
- 2) Delete All
 - Deletes all of the holidays.
- 3) Add
 - Adds the specified date.
- 4) 
 - Deletes the schedule in the selected line.

- * **The Holiday Management function can be turned on or off in the Timer setup menu.**
- * **The Input source of MagicInfo works only on MagicInfo model.**
- * **The Input source of TV works only on TV model.**
- * **Time Control is available only for the displays for which the power status is ON.**
- * **Only enabled for a TV when Source is set to TV in On Time mode.**
- * **Only enabled for a model with MagicInfo installed when Source is set to MagicInfo in On Time mode.**



PIP Size

1. Click PIP of the main icons and the PIP control screen appears.
Selects displays you want to adjust using the Select All button or checkboxes.

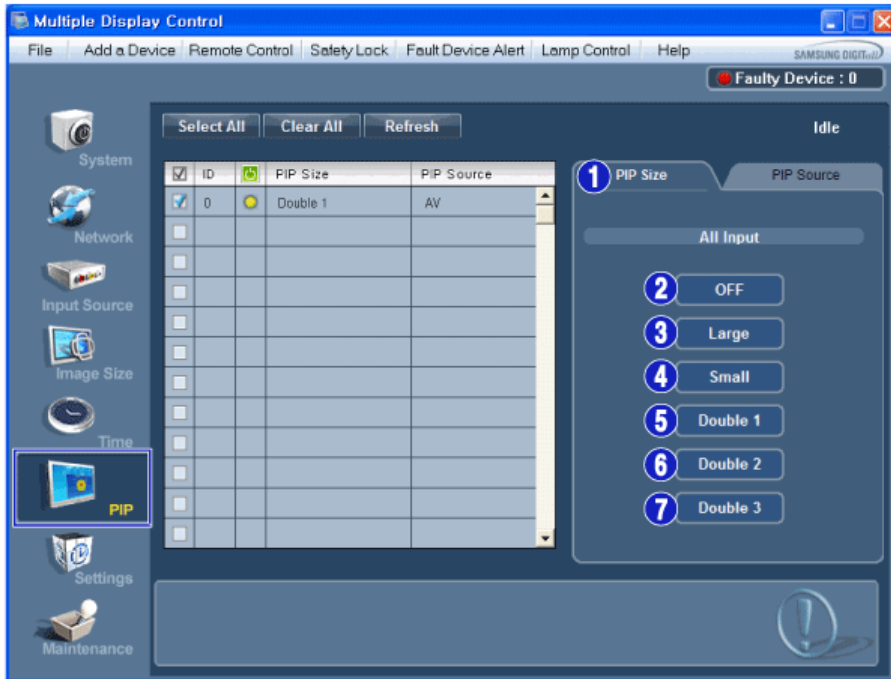

✱ Info Grid shows some basic information necessary to PIP Size Control.

- 1) PIP Size
 - Shows the current PIP Size of the display in use.
- 2) OFF
 - Turns off the PIP of the selected display.
- 3) Large
 - Turns on the PIP of the selected display and changes the size to Large.
- 4) Small
 - Turns on the PIP of the selected display and changes the size to Small.
- 5) Double 1
 - Turns on the PIP of the selected display and changes the size to Double 1.
- 6) Double 2
 - Turns on the PIP of the selected display and changes the size to Double 2.
- 7) Double 3 (Picture By Picture)
 - Turns on the PBP of the selected display and changes the size to Double 3.

✱ **PIP Size can be controlled with turning on the LCD Display power.**

✱ **The Input source of TV works only on TV model.**

✱ **The Input source of MagicInfo works only on MagicInfo model.**



PIP

PIP Source

1. Click PIP of the main icons and the PIP control screen appears.

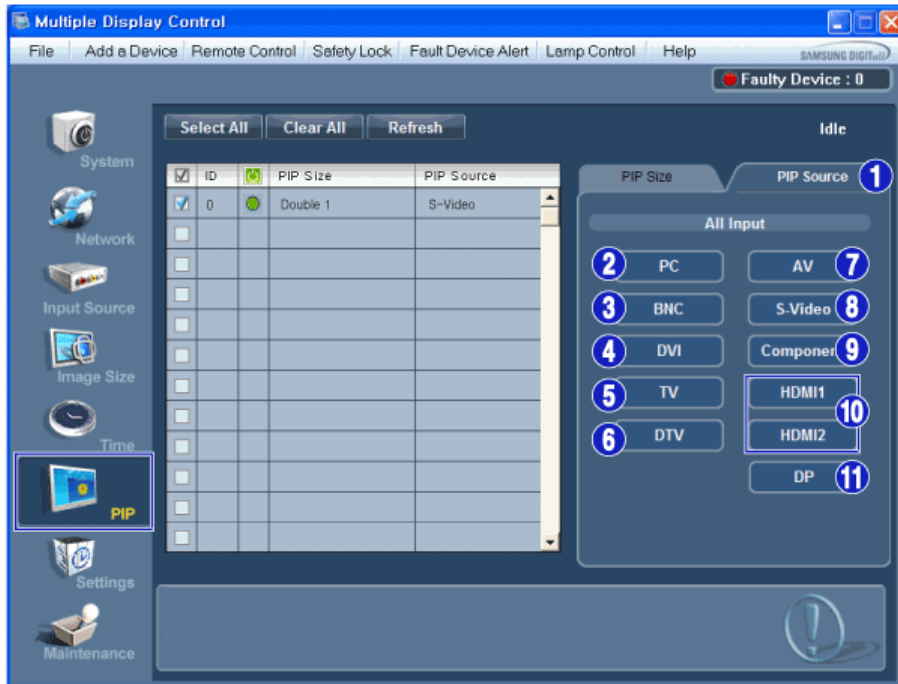

✱ Info Grid shows some basic information necessary to PIP Source Control.

- 1) PIP Source
 - PIP Source can be controlled with turning on the LCD Display power.
- 2) PC
 - Changes the source of the PIP of the selected display to PC.
- 3) BNC
 - Changes the source of the PIP of the selected display to BNC.
- 4) DVI
 - Changes the source of the PIP of the selected display to DVI.
- 5) TV
 - Changes the source of the PIP of the selected display to TV.
- 6) DTV
 - Changes the source of the PIP of the selected display to DTV.
- 7) AV
 - Changes the source of the PIP of the selected display to AV.
- 8) S-Video
 - Changes the source of the PIP of the selected display to S-Video.
- 9) Component
 - Changes the source of the PIP of the selected display to Component.
- 10) HDMI1/HDMI2
 - Changes the source of the PIP of the selected display to HDMI.
- 11) DP
 - Switches the PIP Source of the selected Display to DP.

✱ **Some of the PIP Sources may not be available for selection, depending on the input source type of the Main Screen.**

✱ **The PIP Control feature is available only for the displays whose power status is ON and the PIP function is set to ON.**

✱ **HDMI2 may not be supported depending on the product.**

✱ **DP may not be supported depending on the product.**

✱ **The Input source of MagicInfo works only on MagicInfo model.**

✱ **HDMI2 may not be supported depending on the product.**



Setting

Picture

1. Click Settings of the main icons and the Settings Control screen appears.

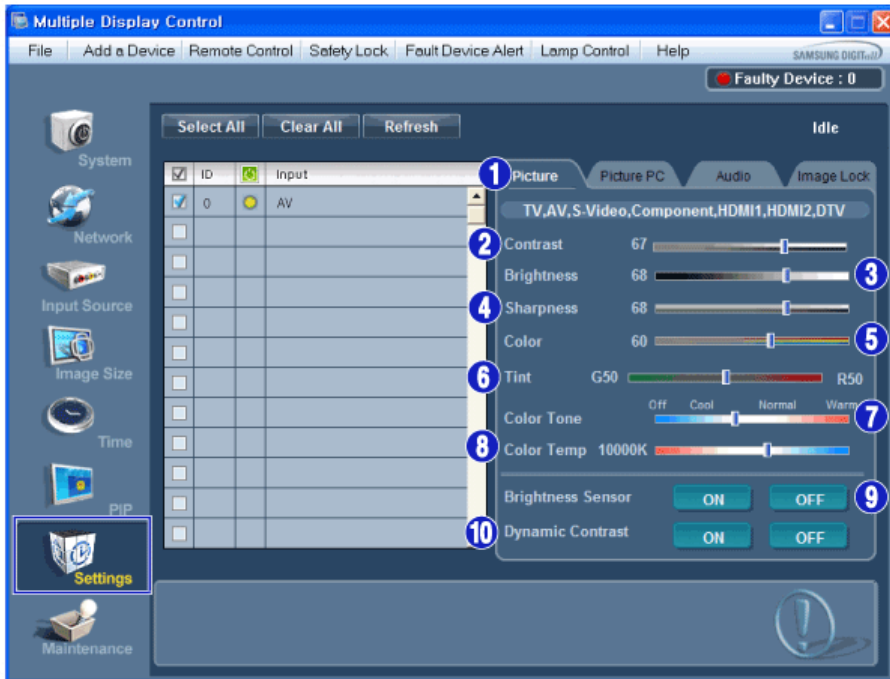

* Basic information required to adjust the Picture is displayed in the main menu. Settings for the selected monitor will be displayed if one of the connected monitors is selected, and the default settings will be displayed if all monitors are selected by clicking All and Select. If a value is changed in this screen, the current mode will automatically switch to custom mode.

1) Picture
- Available only for TV, AV, S-Video, Component, HDMI1, HDMI2, DTV.

2) Contrast
- Adjusts Contrast of the selected display.

3) Brightness
- Adjusts Brightness of the selected display.

4) Sharpness
- Adjusts Sharpness of the selected display.

5) Color
- Adjusts Color of the selected display.

6) Tint
- Adjusts Tint of the selected display.
- Available only for NT.

7) Color Tone
- Adjusts the Color Tone for the selected display.

8) Color Temp
- Adjusts the Color Temp for the selected display.

9) Brightness Sensor
- Adjusts the Brightness Sensor for the selected display.

10) Dynamic Contrast
- Adjusts the Dynamic Contrast for the selected display.

* **Brightness Sensor may not be supported depending on the product.**

* **The Input source of MagicInfo works only on MagicInfo model.**

* **Color Temp is only enabled if the Color Tone is set to Off.**

* **The Input source of TV works only on TV model.**

* **This feature is available only for the displays whose power status is ON and if no selection is made, the factory default is displayed.**

* **HDMI2 may not be supported depending on the product.**



Setting

Picture PC

1. Click Settings of the main icons and the Settings Control screen appears.



* Basic information required to adjust settings is displayed. Settings for the corresponding SET will be imported and displayed on the slider if a display ID is selected, and the default settings will be displayed if all display IDs are selected by clicking All and Select. If a value is changed in this screen, the current mode will automatically switch to custom mode.

- 1) Picture PC
 - Available only for PC, BNC, DVI and DP.
- 2) Contrast
 - Adjusts Contrast of the selected display.
- 3) Brightness
 - Adjusts Brightness for the selected display.
- 4) Red
 - Adjusts red Color of the selected display.
 - Available only for NT.
- 5) Green
 - Adjusts green Color of the selected display.
 - Available only for NT.
- 6) Blue
 - Adjusts blue Color of the selected display.
 - Available only for NT.
- 7) Color Tone
 - Adjusts the Color Tone for the selected display.
- 8) Color Temp
 - Adjusts the Color Temp for the selected display.
- 9) Brightness Sensor
 - Adjusts the Brightness Sensor for the selected display.
- 10) Dynamic Contrast
 - Adjusts the Dynamic Contrast for the selected display.

* **Brightness Sensor may not be supported depending on the product.**

* **The Input source of MagicInfo works only on MagicInfo model.**

* **The Input source of TV works only on TV model.**

* **Color Temp is only enabled if the Color Tone is set to Off.**

* **This feature is available only for the displays whose power status is ON and if no selection is made, the factory default is displayed**

* **DP may not be supported depending on the product.**



Setting

Audio

1. Click Settings of the main icons and the Settings Control screen appears.

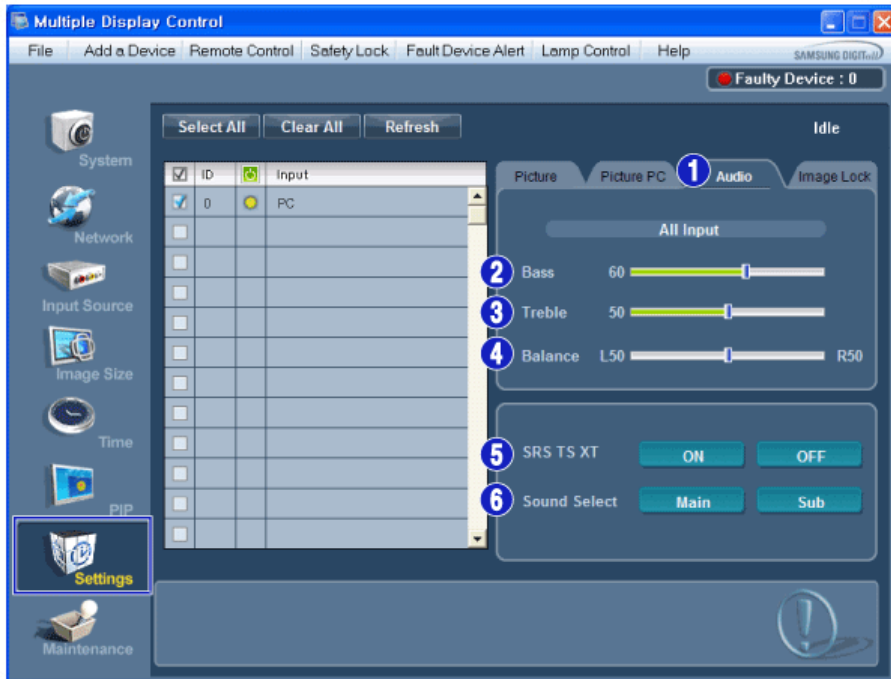

* Basic information required to adjust Audio is displayed in the display window. Settings for the corresponding SET will be imported and displayed on the slider if a display ID is selected, and the default settings will be displayed if all display IDs are selected by clicking All and Select. If a value is changed in this screen, the current mode will automatically switch to custom mode.

- 1) Audio
 - Controls audio settings for all input sources.
- 2) Bass
 - Adjusts Bass of the selected display.
- 3) Treble
 - Adjusts Treble of the selected display.
- 4) Balance
 - Adjusts Balance of the selected display.
- 5) SRS TS XT
 - SRS TS XT Sound ON/OFF of the selected display.
- 6) Sound Select
 - Select either Main or Sub when PIP is On.

* **This feature is available only for the displays whose power status is ON and if no selection is made, the factory default is displayed.**

* **The Input source of MagicInfo works only on MagicInfo model.**

* **The Input source of TV works only on TV model.**



Setting

Image Lock

1. Click Settings of the main icons and the Settings Control screen appears.

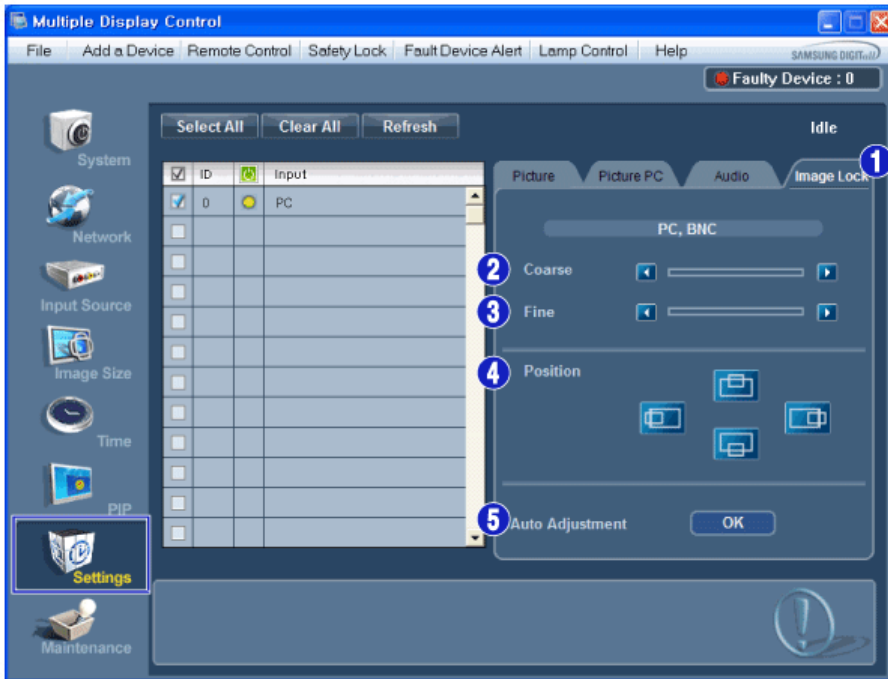

✱ Info Grid shows some basic information necessary to Settings Control.

- 1) Image Lock
- Available only for PC, BNC.
- 2) Coarse
- Adjusts Coarse of the selected display.
- 3) Fine
- Adjusts Fine of the selected display.
- 4) Position
- Adjusts Position of the selected display.
- 5) Auto Adjustment
- Self-Adjust to the incoming PC signal.

✱ **The Maintenance Control feature is available only for the displays whose power status is ON.**

✱ **The Input source of MagicInfo works only on MagicInfo model.**

✱ **The Input source of TV works only on TV model.**



Maintenance

Lamp Control

1. Click on the "Maintenance" icon in the Main Icon column to display the Maintenance screen.

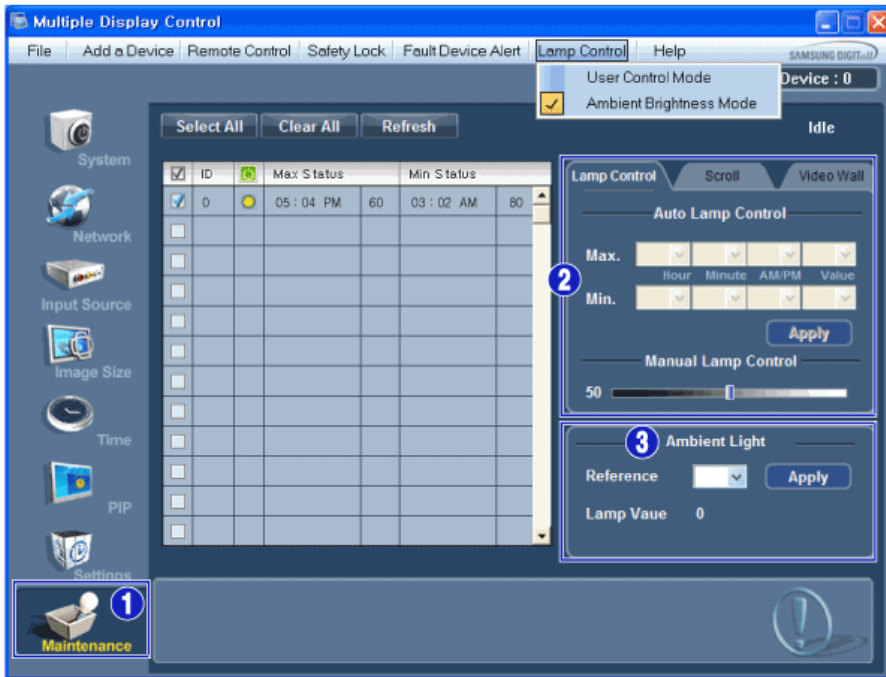

* An "Info Grid" showing several basic data items appears.

1) Maintenance

- Allows the Maintenance Control function for all input sources.

2) Lamp Control

- Automatically adjusts the backlight of the selected display at a specified time.

The Manual Lamp Control automatically turns off if you adjust using the Auto Lamp Control.

- Allows you to adjust the backlight of the selected display regardless of the time.

The Auto Lamp Control automatically turns off if you adjust using the Manual Lamp Control.

3) Ambient Light

- Detects the ambient light intensity at the designated monitor and automatically adjusts the picture brightness.

- You can specify a Reference value and designate a monitor that will automatically determine Lamp Value (the light intensity from the lamp), based on the ambient light intensity.

* **Ambient Light is only supported for models that have a brightness sensor and is only enabled when Ambient Brightness Mode is selected in the Lamp Control menu.**

* **Auto Lamp Control and Manual Lamp Control are only enabled when User Control Mode is selected in the Lamp Control menu.**

* **The Maintenance Control feature is available only for the displays whose power status is ON.**

* **The Input source of MagicInfo works only on MagicInfo model.**

* **The Input source of TV works only on TV model.**



Maintenance

Scroll

1. Click on the "Maintenance" icon in the Main Icon column to display the Maintenance screen.

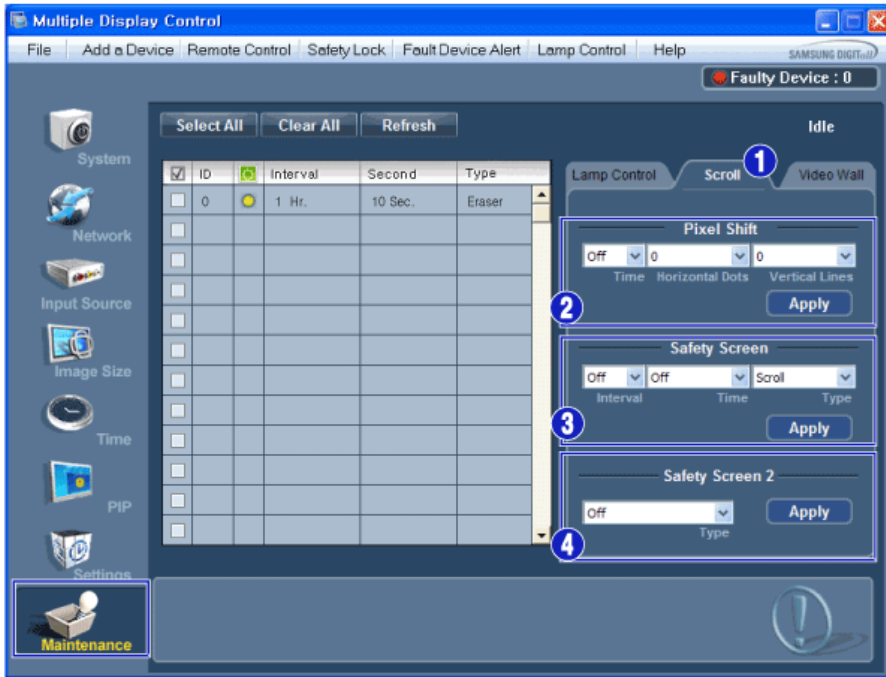

1) Scroll

- This function is used to remove the afterimages that occur when a still screen is displayed on the selected display for a long time.

2) Pixel Shift

- This allows the screen to be moved finely at the specified time interval.

3) Safety Screen

- The Safety Screen function is used to prevent afterimages from occurring when a still screen is displayed on the monitor for a long time. The Interval item is used to set the repetition cycle in hour units and the Time item is used to set the time when the Safety Screen function must be performed. The Type item can be set to Scroll, Pixel, Bar, Eraser, All White, or Pattern.

4) Safety Screen2

- This function is used to prevent afterimages from occurring. There are five (5) types that you can select and control with this function.

*** For the Scroll type, the Time item can be set to 1, 2, 3, 4 or 5. For the Bar and Eraser types, it can be set to 10, 20, 30, 40 or 50. For the All White and Pattern type, it can be set to 1, 5, 10, 20 or 30.**

*** The Maintenance Control feature is available only for the displays whose power status is ON.**

*** The Input source of MagicInfo works only on MagicInfo model.**

*** The Input source of TV works only on TV model.**



Maintenance

Video Wall

1. Click on the "Maintenance" icon in the Main Icon column to display the Maintenance screen.

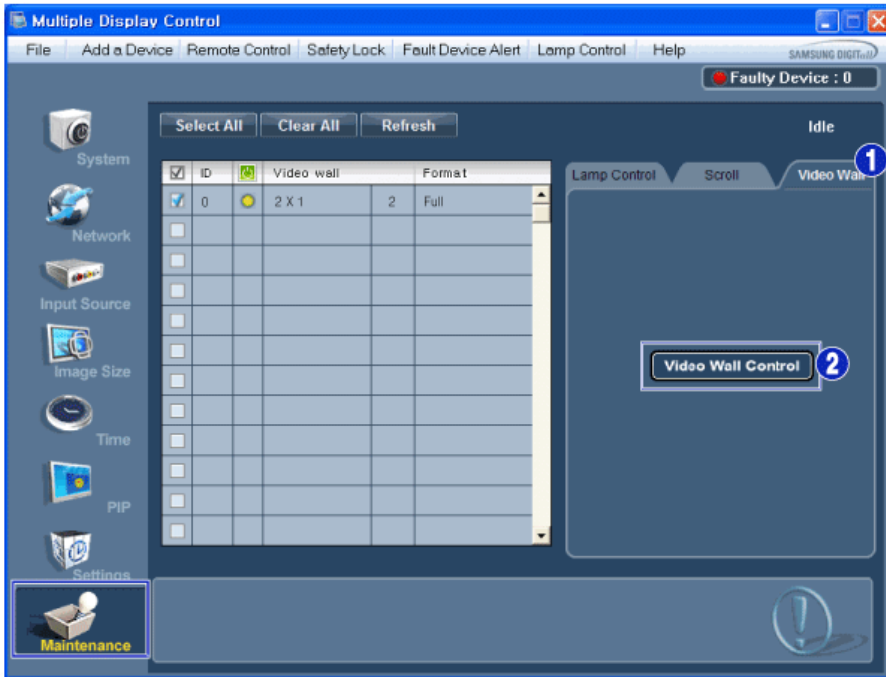

1) Video Wall

- A Video Wall is a set of video screens that are connected together, so that each screen shows a part of the whole picture or so that the same picture is repeated on each screen.

2) Video Wall Control

- Video Wall properties can be configured.

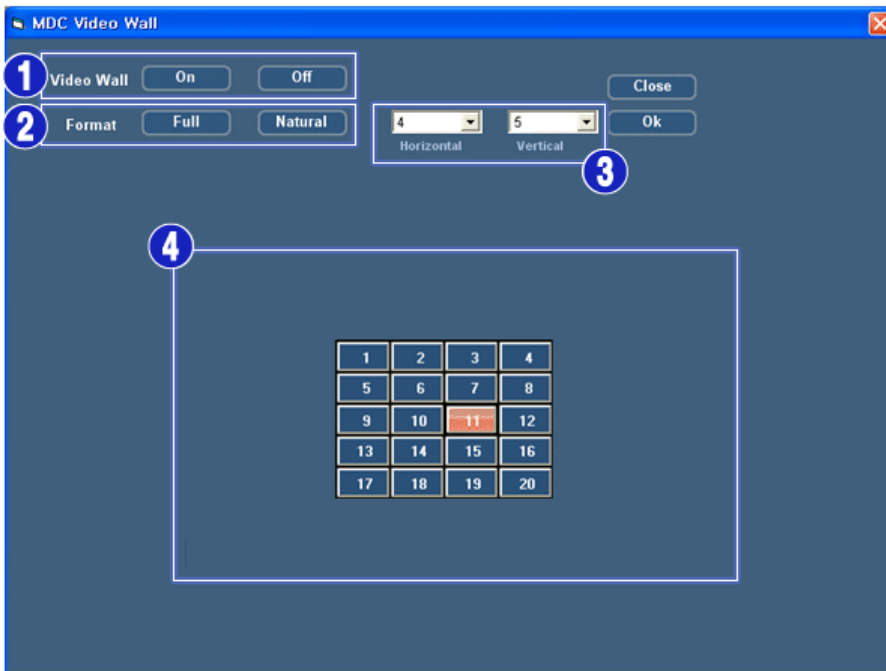

1) On / Off

- Turns on/off the Video Wall function of the selected display.

2) Format

- The format can be selected to see a divided screen.

- Full

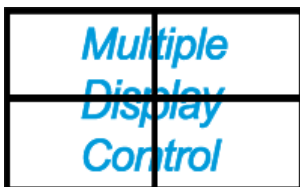

- Natural

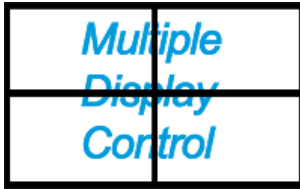

3) Video Wall (Screen divider)

- The screen can be divided into.

You can select a number of screens with a different layout when dividing.

- Select a mode from Screen divider.
- Select a display from Display Selection.
- The place will be set up by pressing a number in the selected mode.
- The maximum number of monitors that can be arranged: Horizontal X Vertical = 100
- Up to 15 monitors can be arranged in a row. The maximum value for Horizontal is 6 if Vertical is set to 15 while the maximum value for Vertical is 6 if Horizontal is set to 15.

4) Viewing Screen Splits

- You can view and change the layout of screens using the Screen Divider settings.

- * **The range of the Screen Divider setting may differ depending on the model.**
- * **You may not operate this function in MagicInfo.**
- * **The Input source of TV works only on TV model.**
- * **The Maintenance Control function is available only for the displays where the power status is ON.**

Troubleshooting

1. The display you wish to control does not appear on the System Info Grid

- Check if the entered IP address is correct and check the connection status of the Ethernet cable.
- Check the displays to see if any of the other displays connected have the same ID. If more than one displays have the same ID, those displays are not properly detected by the program due to data conflict.
- For monitors that support a Set ID between 0 to 99, you have to set the Set ID to a value between 0 and 99.

Note : Check if the Set ID of the monitor is a value between 0 and 99 (set the value using the Display menu).

2. The display you wish to control does not appear on the other Control Info Grids

- Check to see if the display power is ON. (You can check this in System Info Grid)
- Check if you can change the input source of the display.

3. The dialogue box appears repeatedly.

- Check to see if the display you wish to control is selected.

4. Both On Timer and Off Timer have been set but different time is showing.

- Apply current time to synchronize the display clocks.

5. The remote may not function properly when you turn off the remote Function, disconnect the Ethernet cable, or exit the program in an Irregular manner. Rerun the program and turn the remote function again to Restore normal functions.

<**Note**> This program may malfunction due to problems in communication circuits or interference from electronic appliances nearby.



Settings Value Display In Multiple Display Mode

* When there are more than one displays connected, the settings values are displayed as follows.

1. No selection: Displays the Factory Default Value.
2. Selected one display: Fetches and displays the settings value for the selected display.
3. Selected one display (ID1) and add another display (ID3): The program, which was displaying the settings value of ID 1, fetches and displays the value of ID3.
4. If all sets are selected at the same time by clicking All and Select, the default value will be restored.

Adjusting the LCD Display

Input

Available Modes

- **P** PC / DVI / DP
- **A** AV
- **C** Component
- **H** HDMI
- **M** MagicInfo



For an 460UT-2, 460UT-B model,

MagicInfo can only be enabled when a network box is connected.

Source List **PACHM**



Use to select PC, HDMI or other external input sources connected to the LCD Display. Use to select the screen of your choice.

1. PC
2. DVI
3. AV
4. Component
5. HDMI1
6. HDMI2
7. DisplayPort
8. MagicInfo
9. TV

PIP **PAH**





Note

The PIP function is not available when **Video Wall is On**.

When external AV devices such as VCRs or DVDs are connected to the LCD Display , **PIP** allows you to watch video from those devices in a small window super-imposed on the PC Video signal. (**Off/On**)

 **Note**

- PIP turns off when the LCD Display is switched to an external source.
- If you select  ,  ,  in **Size**, **Position** and **Transparency** will not be activated.

PIP

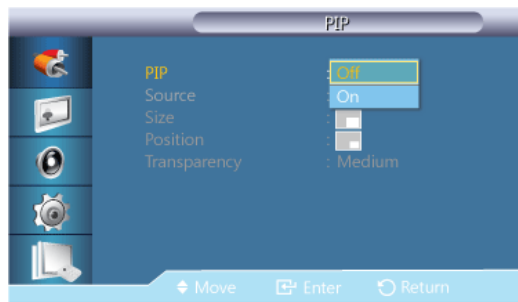

Turns the **PIP** Screen **Off/On**.

- **Off**
- **On**

Source

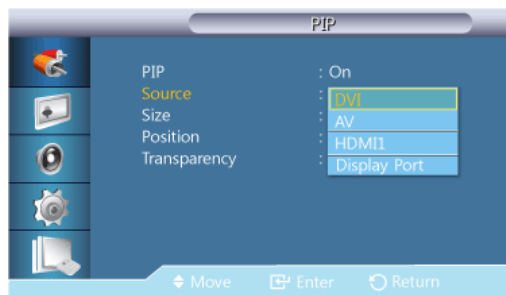

 **Note**

For PC, this is deactivated if the cable is disconnected.

Selects the input source for the PIP.

- **PC : DVI / AV / HDMI1 / DisplayPort**
- **DVI : PC**
- **AV : PC**
- **HDMI : PC**

Size

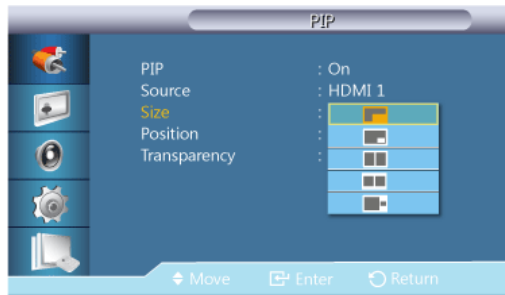

Changes the Size of the PIP window.

Position



Changes the Position of the PIP window.

Transparency

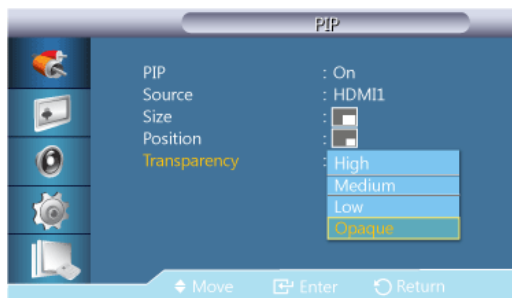

Adjusts the Transparency of PIP windows.

- High
- Medium
- Low
- Opaque

Edit Name PACHM



Name the input device connected to the input jacks to make your input source selection easier.

VCR / DVD / Cable STB / HD STB / Satellite STB / AV Receiver / DVD Receiver / Game / Camcorder / DVD Combo / DHR / PC / DVI Devices

 **Note**

- The displayed devices differ depending on the external input mode.
- When connecting a PC to the HDMI terminal, set **Edit Name** to **PC**. In other cases, set **Edit Name** to **AV**. However, since 640x480, 720P (1280x720), and 1080p (1920x1080) are common signals for **AV** and **PC**, make sure to set the **Edit Name** in accordance with the input signal.
- The **Picture** menu changes depending on the input signal and **Edit Name**.

Picture [PC / DVI / DP / MagicInfo Mode]

Available Modes

- **P** PC / DVI / DP
- **A** AV
- **C** Component
- **H** HDMI
- **M** MagicInfo

 For an 460UT-2, 460UT-B model,

MagicInfo can only be enabled when a network box is connected.

Mode **PM**

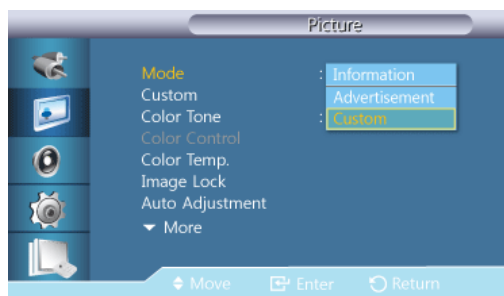

 **Note**

Not available when **Dynamic Contrast** is set to **On**.

1. **Information**
2. **Advertisement**
3. **Custom**

Custom **PM**

By using the on-screen menus, the contrast and brightness can be changed to your personal preference.

 **Note**

- By adjusting the picture using the **Custom** function, **MagicBright** will change to **Custom** mode.
- Not available when **Dynamic Contrast** is set to **On**.

1. **Contrast**



Adjusts the Contrast.

2. **Brightness**



Adjusts the Brightness.

3. **Sharpness**



Adjusts the Sharpness.

4. **Gamma**



Adjust the mid-range brightness (Gamma) for the picture.

- **Natural**
- **Mode 1**
- **Mode 2**
- **Mode 3**

Color Tone PM



 **Note**

Not available when **Dynamic Contrast** is set to **On**.

The color tones can be changed.

1. **Off**
2. **Cool**
3. **Normal**
4. **Warm**
5. **Custom**

 **Note**

If you set the **Color Tone** to **Cool**, **Normal**, **Warm**, or **Custom**, the **Color Temp.** function is disabled.

If you set the **Color Tone** to **Off**, the **Color Control** function is disabled

Color Control **PM**

Adjusts individual Red, Green, Blue color balance.

 **Note**

Not available when **Dynamic Contrast** is set to **On**.

1. **Red**



2. **Green**



3. **Blue**



Color Temp. **PM**



Color Temp. is a measure of the 'warmth' of the image colors.

 **Note**

- Not available when **Dynamic Contrast** is set to **On**.
- This function is only enabled if the **Color Tone** is set to **Off**.

Image Lock **P**

Image Lock is used to fine-tune and get the best image by removing noise that creates unstable images with jitters and shakiness. If satisfactory results are not obtained using the Fine adjustment, use the Coarse adjustment and then use Fine again.

 **Note**

Available in **PC** mode only.

Coarse



Removes noise such as vertical stripes. Coarse adjustment may move the screen image area. You may relocate it to the center using the horizontal control menu.

Fine



Removes noise such as horizontal stripes. If the noise persists even after Fine tuning, repeat it after adjusting the frequency (clock speed).

Position



Adjusts the screen location horizontally and vertically.

Auto Adjustment **P**

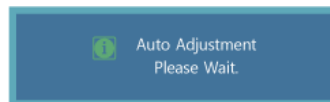

The values of **Fine**, **Coarse**, **Position** are adjusted automatically. By changing the resolution in the control panel, the auto function is performed.

 **Note**

Available in **PC** mode only.

Signal Balance **P**

This is used to make up for the weak RGB signal transmitted by a long signal cable.

 **Note**

- Not available when **Dynamic Contrast** is set to **On**.
- Available in **PC** mode only.

Signal Balance

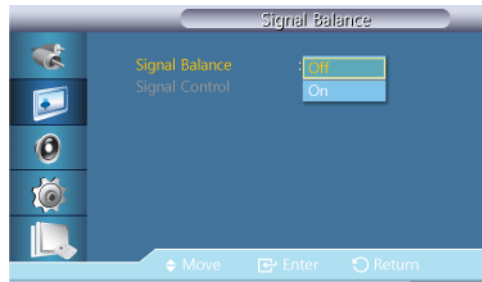

Selects either **On** or **Off** with the signal balance.

Signal Control



Note

Available when **Signal Balance** is set to **On**.

1. R-Gain



2. G-Gain



3. B-Gain



4. R-Offset



5. G-Offset



6. B-Offset



Size **P**

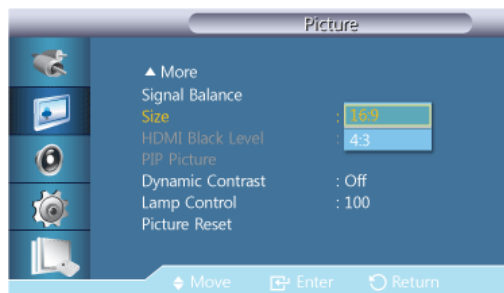

The **Size** can be switched.

1. 16:9

2. 4:3

HDMI Black Level P

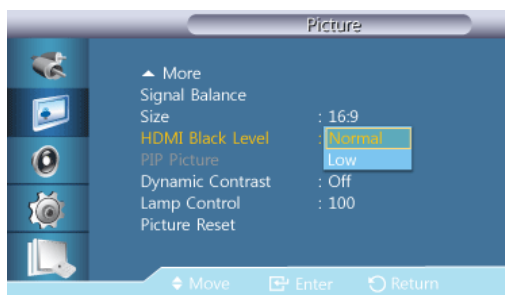

When watching with a DVD or set-top box connecting to the product via HDMI, image quality deterioration (black level, lower-quality contrast, lighter color tone, etc.) may occur depending on the connected external device.

1. **Normal**
2. **Low**

Note

For Timing which can be used for both the PC and the DTV in **HDMI** mode, **HDMI Black Level** will be activated.

PIP Picture P

Adjusts the PIP Screen Settings.

Note

- Available Modes: **PIP On**

1. **Contrast**



Adjusts the Contrast of the PIP window on the screen.

2. **Brightness**



Adjusts the Brightness of the PIP window on the screen.

3. **Sharpness**



Adjusts the Sharpness of the PIP window on the screen.

4. **Color**



Adjusts the Color of the PIP window on the screen.

 **Note**

Only enabled when the **PIP** input source is **HDMI**.

5. **Tint**



Adds a natural tone to the PIP window.

 **Note**

The **Tint** slider is only displayed when the input signal is NTSC and is only enabled when the **PIP** input source is **HDMI**.

Dynamic Contrast **PM**

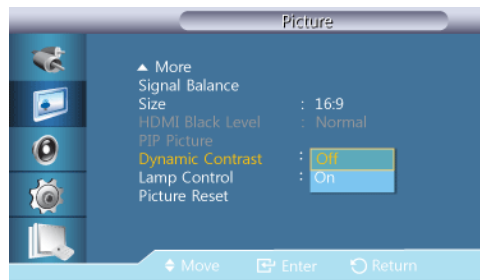

Dynamic Contrast automatically detects the distribution of the visual signal and adjusts to create an optimum contrast.

1. **Off**
2. **On**

 **Note**

Disabled when **PIP** is set to **On**.

Lamp Control **PM**



Adjusts the inverter lamp in order to reduce energy consumption.

 **Note**

Not available when **Dynamic Contrast** is set to **On**.

Picture Reset **PM**

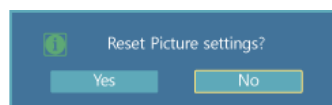

Reset the screen settings.

Picture [AV / HDMI / Component Mode]

Available Modes

- **P** PC / DVI / DP
- **A** AV
- **C** Component
- **H** HDMI
- **M** MagicInfo

 For an 460UT-2, 460UT-B model,

MagicInfo can only be enabled when a network box is connected.

Mode **A H C**



The LCD Display has four automatic picture settings ("**Dynamic**", "**Standard**", "**Movie**" and "**Custom**") that are preset at the factory.

Dynamic, **Standard**, **Movie**, or **Custom** can be activated.

 **Note**

Not available when **Dynamic Contrast** is set to **On**.

1. **Dynamic**
2. **Standard**
3. **Movie**
4. **Custom**

Custom **A H C**

By using the on-screen menus, the contrast and brightness can be changed to your personal preference.

 **Note**

Not available when **Dynamic Contrast** is set to **On**.

Contrast



Adjusts the Contrast.

Brightness



Adjusts the Brightness.

Sharpness



Adjusts the picture Sharpness.

Color



Adjusts the picture Color.

Tint



Adds a natural tone to the display.

 **Note**

Operates only if the video signal is NTSC.

Color Tone **A H C**



The color tones can be changed. The individual Color components are also user adjustable.

 **Note**

Not available when **Dynamic Contrast** is set to **On**.

1. **Off**
2. **Cool2**
3. **Cool1**
4. **Normal**
5. **Warm1**
6. **Warm2**

 **Note**

If you set the **Color Tone** to **Cool2**, **Cool1**, **Normal**, **Warm1**, or **Warm2**, the **Color Temp.** function is disabled.

Color Temp. **AHC**



Color temp. is a measure of the 'warmth' of the image colors.

 **Note**

When **Dynamic Contrast** mode and **Color Tone** are **Off**, this function is activated.

Size **AHC**

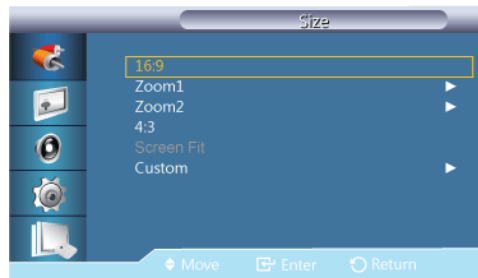

The **Size** can be switched.

1. **16:9** - Sets the picture to 16:9 wide mode.
2. **Zoom 1** - Magnifies the size of the picture on the screen.
3. **Zoom 2** - Magnifies the size of the picture more than **Zoom 1**.
4. **4:3** - Sets the picture to 4:3 normal mode.
5. **Screen Fit** - Displays the input scenes as they are without any cutoff when HDMI 720p, 1080i, 1080p signals are input.
6. **Custom** - Changes the resolution to suit the user's preferences.

 **Note**

- Certain external devices may feed the display an out of spec signal that may cause cutoff even when using the **Screen Fit** feature.
- **Zoom 1**, **Zoom 2** are unavailable in **HDMI** mode.
- The **Position** and **Reset** functions are available in **Zoom 1** or **Zoom 2** modes.
- Not available when **Dynamic Contrast** is set to **On**.

Digital NR (Digital Noise Reduction) **AHC**



Turns the Digital Noise Reduction feature **Off/On**. The Digital Noise Reduction feature allows you to enjoy clearer and crisper images.

1. **Off**
2. **On**



Digital NR function is not available for all resolutions.

HDMI Black Level



When a DVD or set-top box is connected to your TV via HDMI, it may cause a degradation in the screen quality, such as an increase in the black level, a low contrast, or discoloration, etc., depending on the external device connected. In this case, adjust the screen quality of your TV by configuring the **HDMI Black Level**.

1. **Normal**
2. **Low**



For Timing which can be used for both the PC and the DTV in **HDMI** mode, **HDMI Black Level** will be activated.

Film Mode



Film Mode calibrates unnatural picture when watching a movie (24 frames) played on a TV (30 frames).

Moving subtitles may appear corrupted when this mode is enabled.

(In **HDMI** mode, this function is available when the input signal is interlaced scan; it is not available in progressive scan.)

1. **Off**
2. **On**

PIP Picture **AH**

Adjusts the **PIP** Screen Settings.



Available Modes: **PIP On**

1. **Contrast**



Adjusts the Contrast of the PIP window on the screen.

2. **Brightness**



Adjusts the Brightness of the PIP window on the screen.

3. **Sharpness**



Adjusts the Sharpness of the PIP window on the screen.

Dynamic Contrast **AHC**



Dynamic Contrast automatically detects the distribution of the visual signal and adjusts to create an optimum contrast.

1. **Off**

2. **On**



Disabled when **PIP** is set to **On**.

Lamp Control **AHC**



Adjusts the inverter lamp in order to reduce energy consumption.



Not available when **Dynamic Contrast** is set to **On**.

Picture Reset **A H C**

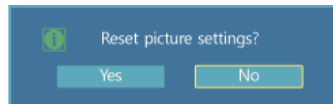

Reset the screen settings.

Sound

Available Modes

- **P** PC / DVI / DP
- **A** AV
- **C** Component
- **H** HDMI
- **M** MagicInfo

 For an 460UT-2, 460UT-B model,

MagicInfo can only be enabled when a network box is connected.

Mode **P A C H M**

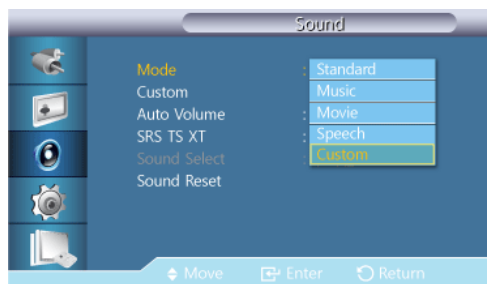

The LCD Display has a built-in high fidelity stereo amplifier.

1. **Standard**

Selects **Standard** for the standard factory settings.

2. **Music**

Selects **Music** when watching music videos or concerts.

3. **Movie**

Selects **Movie** when viewing movies.

4. **Speech**

Selects **Speech** when watching a show that is mostly dialog (i.e., news).

5. **Custom**

Selects **Custom** if you want to adjust the settings according to your personal preferences.

Custom **PACHM**

The sound settings can be adjusted to suit your personal preferences.

Note

- You can hear the sound even when sound value is set to 0.
- If you adjust sound using **Custom** function, **Mode** will turn to **Custom** mode.

Bass



Emphasizes low frequency audio.

Treble



Emphasizes high frequency audio.

Balance



Allows you to Adjusts the sound balance between the left and right speakers.

Auto Volume **PACHM**



Reduces the difference in volume control between broadcasters.

1. **Off**
2. **On**

SRS TS XT **PACHM**

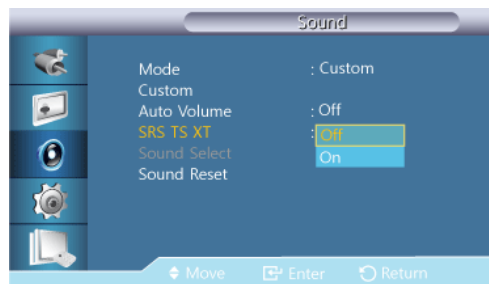

SRS TS XT is a patented SRS technology that solves the problem of playing 5.1 multichannel content over two speakers. TruSurround XT delivers a compelling, virtual surround sound

experience through any two-speaker playback system, including internal television speakers. It is fully compatible with all multichannel formats.

1. **Off**
2. **On**

Sound Select **PAH**

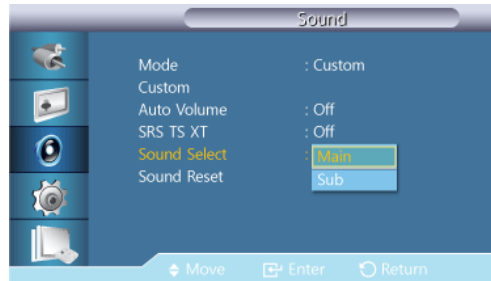

Enable the sound of either the primary or secondary display in **PIP** mode.

Note

Available when **PIP** is set to **On**.

1. **Main**
2. **Sub**

Sound Reset **PACHM**

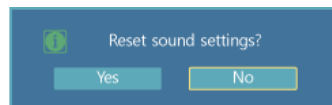

Reset the sound settings.

Setup

Available Modes

- **P** PC / DVI / DP
- **A** AV
- **C** Component
- **H** HDMI
- **M** MagicInfo

 For an 460UT-2, 460UT-B model,

MagicInfo can only be enabled when a network box is connected.

Language PACHM



You can choose one of 13 languages.

English, Deutsch, Español, Français, Italiano, Svenska, Русский, Português, Türkçe, 简体中文, 繁體中文, 日本語, 한국어

Note

The language chosen affects only the language of the OSD. It has no effect on any software running on the computer.

Time PACHM

Selects from one of 4 time settings, **Clock Set**, **Sleep Timer**, **On Timer**, and **Off Timer**.

Clock Set



Current Time Setting.

Sleep Timer



Turns the LCD Display off automatically at certain times.

1. Off
2. 30
3. 60
4. 90
5. 120

6. 150

7. 180

Timer1 / Timer2 / Timer3



You can set the LCD display to automatically turn on or off at a specified time.

 **Note**

- Only enabled when the clock is set using the **Clock Set** menu.
- The Manual option allows you to select a day of the week.

Holiday Management

- **Add**

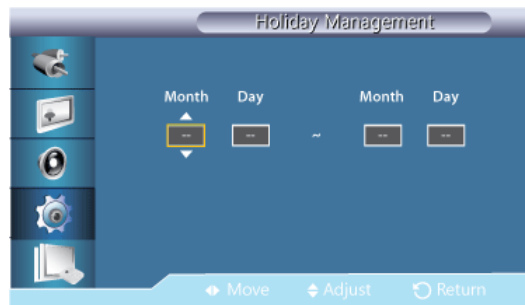

You can register holidays.

- **Delete Selected**

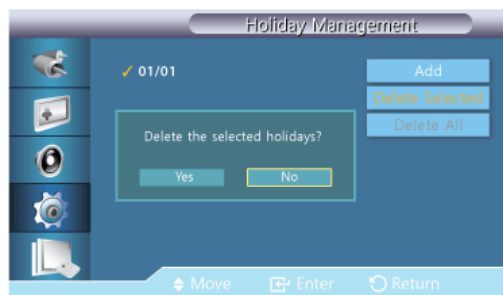

You can delete selected holidays.

 **Note**

- Only enabled when registered holidays are selected.
- More than one holiday can be selected and deleted.

- **Delete All**

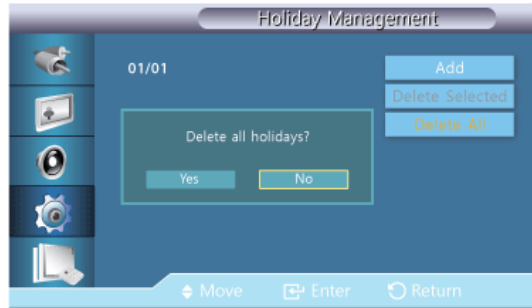

You can delete all the registered holidays.

Menu Transparency **PACHM**



Change the transparency of the background of the OSD.

1. **High**
2. **Medium**
3. **Low**
4. **Opaque**

Safety Lock **PACHM**

Change PIN

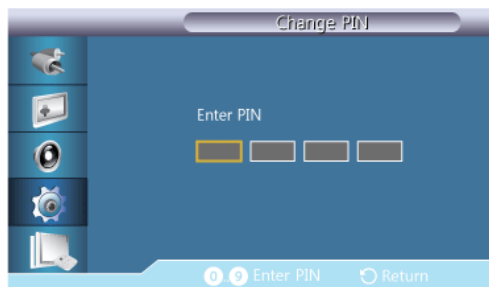

The password can be changed.

The preset password for the LCD Display is "0000".

 **Note**

If you forgot your password, press the remote buttons MUTE → 1 → 8 → 6 → On to reset the password to "0000."

Lock On

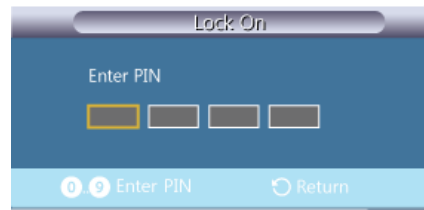

→ [0~9] → [0~9] → [0~9] → [0~9]

This is the function that locks the OSD in order to keep the current settings or to prevent others from adjusting the settings.

Energy Saving **PACHM**



This feature adjusts the power consumption of the unit in order to save energy.

1. Off
2. On

Video Wall **PACHM**

A **Video Wall** is a set of video screens connected together, so that each screen shows a part of the whole picture or where the same picture is repeated on each screen.

When the **Video Wall** is on, you can adjust the **Video Wall** screen setting.

Note

- When **Video Wall** is running, the **Auto Adjustment**, **Image Lock**, and **Size** functions are not available.
- Disabled when **PIP** is set to **On**.

Video Wall

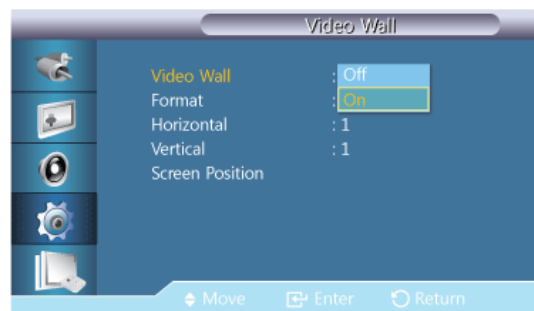

Turns Off/On the **Video Wall** function of the selected display Off/On.

- Off
- On

Format



The **Format** can be selected to see a divided screen.

- **Full**
Provides a full screen without any margins.
- **Natural**
Displays a natural image with the original aspect ratio intact.

Horizontal



Sets how many parts the screen should be divided horizontally.

Fifteen adjustment levels: 1~13.

Vertical



Sets how many parts the screen should be divided vertically.

Fifteen adjustment levels: 1~13.

Screen Position



The screen can be divided into several images. A number of screens can be selected with a different layout when dividing.

- Select a mode in **Screen Position**.
- Select a display in Display Selection.
- The selection will be set up by pressing a number in the selected mode.
- The screen can be split into a maximum of 100 sub-screens.

Note

When more than four displays are connected, we recommend a resolution of XGA (1024*768) or greater to prevent any picture degradation.

Safety Screen **PACHM**

The **Safety Screen** function is used to prevent afterimages that may appear when a still picture is displayed on the screen over a long time.

Note

This function is not available when the power is turned off.

Pixel Shift

Pixel Shift

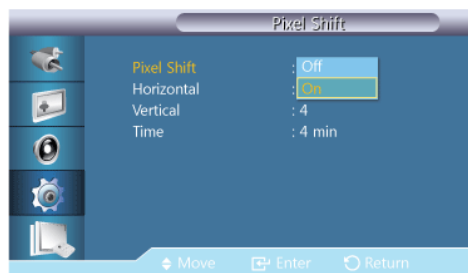

To prevent after-images on the screen, you can use this function to have pixels move on the LCD in the horizontal or vertical direction.

- **Off**
- **On**

Horizontal

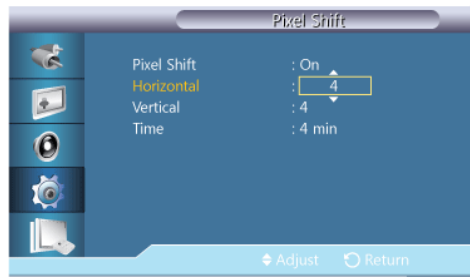

Sets how many pixels the screen moves horizontally.

Five adjustment levels: 0, 1, 2, 3, and 4.

Vertical

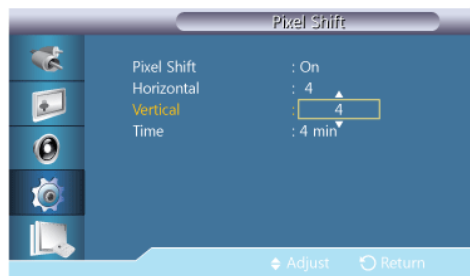

Sets how many pixels the screen moves vertically.

Five adjustment levels: 0, 1, 2, 3, and 4.

Time

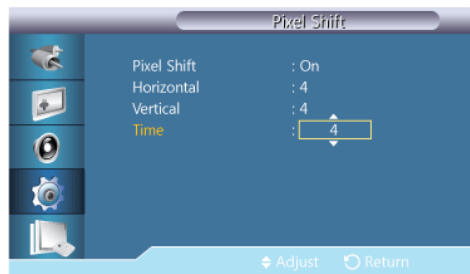

Set the time interval for performing the horizontal or vertical movement, respectively.

Timer

Timer

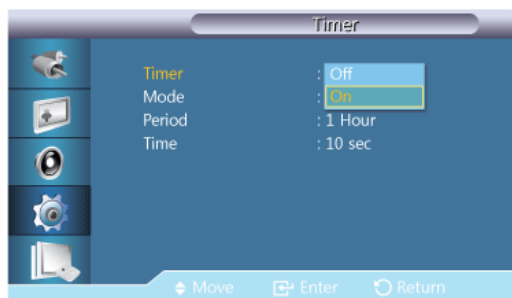

You can set the timer for Screen Burn Protection.

If you start the operation to erase any residual image, the operation will be performed for the set period of time and then automatically finish.

- Off
- On

Mode

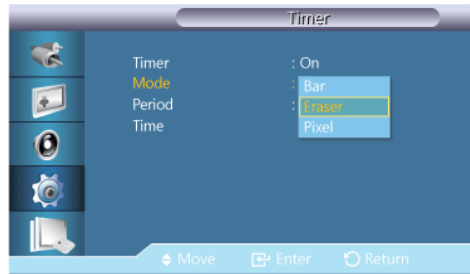

You can change the **Safety Screen Type**.

- Bar
- Eraser
- Pixel

Period



Use this function to set the execution period for each mode set in the timer.

Time



Within the set period of time specify a time for execution.

- **Mode - Bar, Eraser, Pixel : 10~50 sec**

Bar



This function prevents after-images on the screen by moving long black and white vertical lines.

Eraser



This function prevents after-images on the screen by moving a rectangular pattern.

Pixel

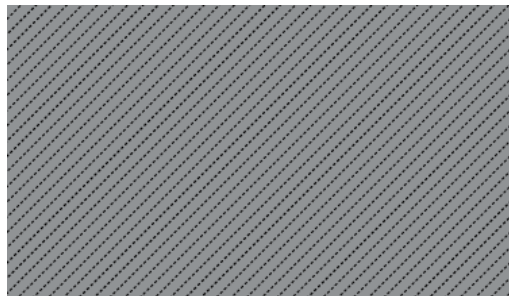

This function prevents after-images by moving many pixels on the screen.

Side Gray



Select the brightness of the grey for the screen background.

- OFF
- Light
- Dark

Resolution Select **P**



When the picture is not displayed properly on the screen when setting the graphics card resolution of the computer to **1024 x 768 @ 60Hz**, **1280 x 768 @ 60Hz**, **1360 x 768 @ 60Hz** or **1366 x 768 @ 60Hz**, by using this function(Resolution Select), you can have the picture displayed on the screen in the specified resolution.

 **Note**

Available in **PC** mode only.

1. **Off**
2. **1024 X 768**
3. **1280 X 768**
4. **1360 x 768**
5. **1366 X 768**

 **Note**

Selecting the menu is only allowed when the graphics resolution is set to **1024 x 768 @ 60Hz**, **1280 x 768 @ 60Hz**, **1360 x 768 @ 60Hz** or **1366 x 768 @ 60Hz**.

Power On Adjustment **PACHM**

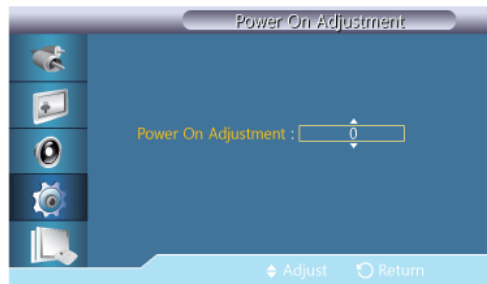

Adjusts the Power On time for the screen.



Caution: Set the Power On time to be longer to avoid overvoltage.

OSD Rotation **PACHM**



OSD Rotate

1. **Landscape**
2. **Portrait**

Advanced Settings **PACHM**

Configures the settings more elaborately.

Fan & Temperature

Prevents the product from overheating using **Fan Speed Setting** and **Temperature Control**.

Fan Control



Selects auto or manual for the fan speed settings.

Fan Speed Setting

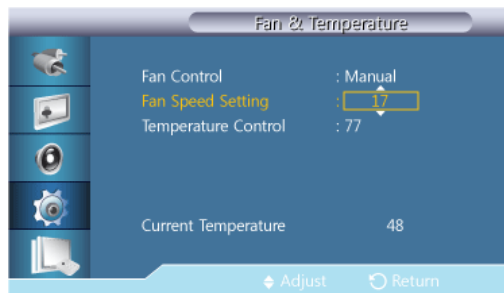

Sets the fan speed within a range of **0** and **100**.

 **Note**

Enabled when **Fan Control** is set to **Manual**.

Temperature Control

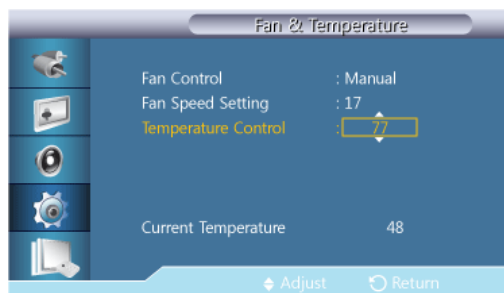

Sets a maximum temperature to prevent the product from overheating.

 **Note**

The product will power off automatically to prevent itself from overheating when the temperature exceeds the maximum temperature.

Current Temperature

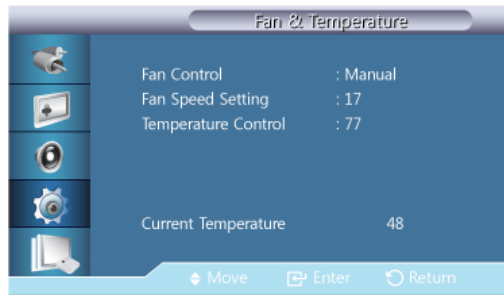

Shows the current temperature of the product.

Auto Power



Enables or disables **Auto Power** for the product.

- Off
- On

Note

When **Auto Power** is **On**, the product will power on automatically as soon as it is connected to power.

Button Lock



Locks or unlocks the monitor control buttons on the product.

- Off
- On

User Auto Color

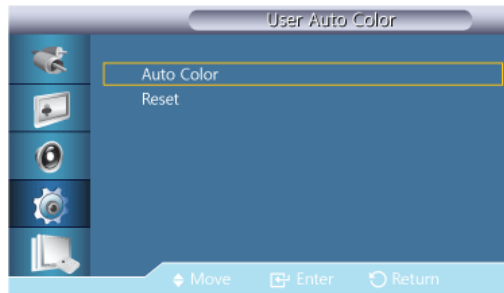

1. **Auto Color**

Automatically adjusts the colors.

2. **Reset**

Resets the color settings.



Note

Enabled only in **PC** mode.

Standby Control

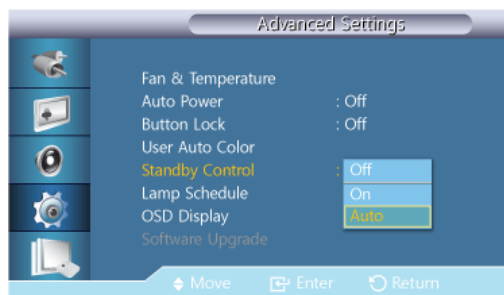

Sets the standby mode, which will be activated when no input signal is detected.

- **Off**

A message will read **<No Signal>** if no input signal is detected.

- **On**

Power-saving mode will be activated if no input signal is detected.

- **Auto**

When no input signal is detected,

- Power-saving mode will be activated if an external device is connected.

- A message will read **<No Signal>** if no external device is connected.



Note

- Enabled only in **PC, DVI, HDMI, or DP(DisplayPort)** mode.

- **Auto** will be disabled in **HDMI** mode.

Lamp Schedule

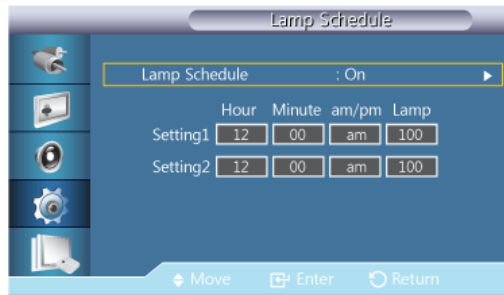

Enables the Lamp value to be adjusted to a user-specified value at a specified time in MDC mode.

OSD Display

Displays or hides a menu item on the screen.

Source OSD

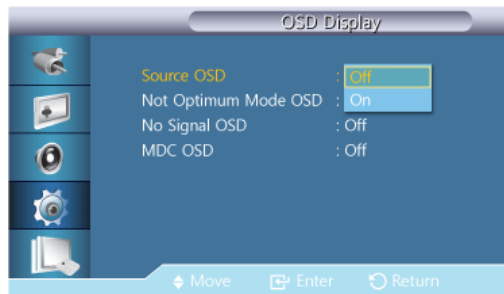

- Off
- On

Not Optimum Mode OSD

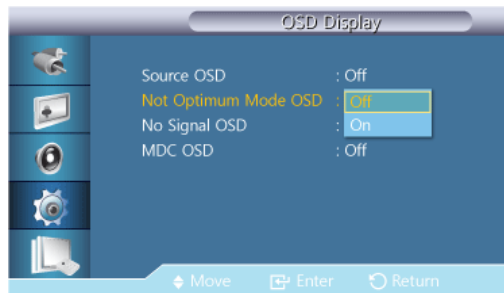

- Off
- On

No Signal OSD

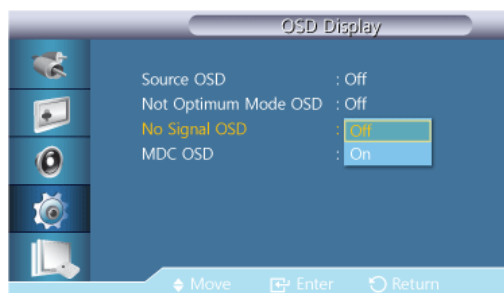

- Off
- On

MDC OSD

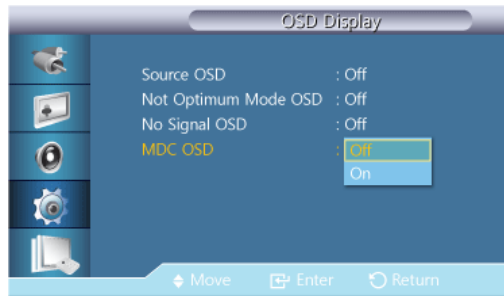

- Off
- On

Software Upgrade

Performs a software upgrade.



Note

- Enabled only in **DVI**, **HDMI**, **HDMI2**, or **MagicInfo** mode.
- Enabled only with an aspect ratio of **16:9**.

Setup Reset **PACHM**

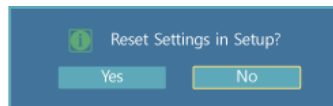

Reset all the values for a setting.

Reset All **PACHM**

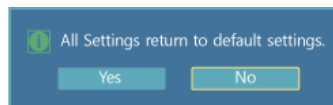

Reset all the settings for the display.

Multi Control

Available Modes

- **P** PC / DVI / DP
- **A** AV
- **C** Component
- **H** HDMI
- **M** MagicInfo

 For an 460UT-2, 460UT-B model,

MagicInfo can only be enabled when a network box is connected.

Multi Control **PACHM**

Assigns an individual ID to the SET.

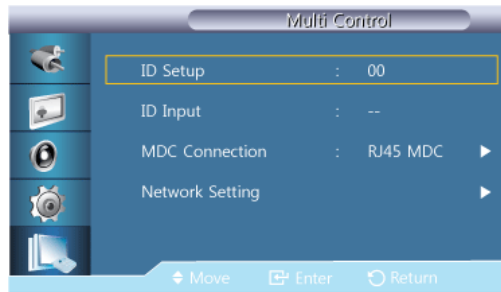

- **ID Setup**

Assigns distinctive IDs to the SET.

- **ID Input**

Use to select the transmitter functions of the individual SET. Only a SET where the ID corresponds to the transmitter setting becomes activated.

- **MDC Connection**

Selects a port to receive the MDC inputs from.

- Communicates with the MDC via a **RS232C MDC** cable.
- Communicates with the MDC via an **RJ45 MDC** cable.

- **Network Setting**

- **IP Setting** : Manual, Auto
- **IP Address** : Manually enter the **IP Address** if **IP Setting** is set to **Manual**.
- **Subnet Mask** : Manually enter the **Subnet Mask** if **IP Setting** is set to **Manual**.
- **Gateway** : Manually enter the **Gateway** if **IP Setting** is set to **Manual**.

MagicInfo

Available Modes

- **P** PC / DVI / DP
- **A** AV
- **C** Component
- **H** HDMI
- **M** MagicInfo

 For an 460UT-2, 460UT-B model,

MagicInfo can only be enabled when a network box is connected.

 **Note**

- The remote control can be used to select **MagicInfo**. However, it is recommended to use a separate USB keyboard to utilize **MagicInfo** fully.
- For **MagicInfo** in Device mode, moving external devices while booting may cause errors. Set up external devices only if the LCD Display turns on.
- Do not unplug the LAN cable used for the network (ex: video display). Otherwise, the program (MagicInfo) may stop. If you do unplug the cable, restart the system.
- Do not unplug the LAN cable used by an USB device (ex: video display). Otherwise, the program (MagicInfo) may stop.
- To access other sources, press the SOURCE button in **MagicInfo**.
- The preset password for the LCD Display is "000000".
- The server program's Power-On option works only if the LCD Display's power is completely shut off.

Please make sure not to use the Power-On option when the LCD Display is in the process of shutting down since this may cause system errors on the LCD Display.

- When using **MagicInfo** with the MagicInfo Server Program: perform Network mode.
- When using **MagicInfo** with the device directly connected to LCD Display : execute Device mode.
- Press ESC to directly go to the **MagicInfo** Window screen.
- To setup **MagicInfo** on a Windows screen, a keyboard and mouse are required.
- To setup **MagicInfo** on a Windows screen, refer to the MagicInfo Server Help.

It is highly recommended not to turn off the AC power during an operation.

- For pivoted LCD Displays, ticker transparency is not supported.
- For pivoted LCD Displays, a screen resolution of up to 720*480(SD) is supported for movies.
- For drive D:, **EFW** is not applied.
- To save Setup contents that have been changed when **EFW** is in the **Enable** state, you must **Commit** them.
- By selecting **Disable**, **Enable** or **Commit**, the system is restarted.

MagicInfo

1. Select Application - step 1

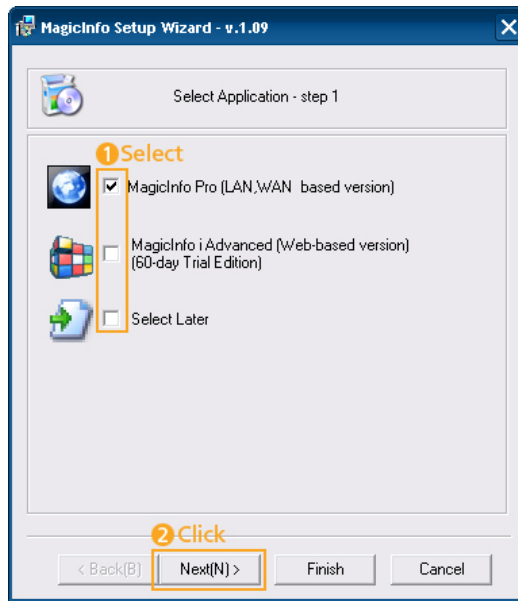

You can select an Application to be executed in your computer when Windows starts.

2. Select TCP/IP - step 2

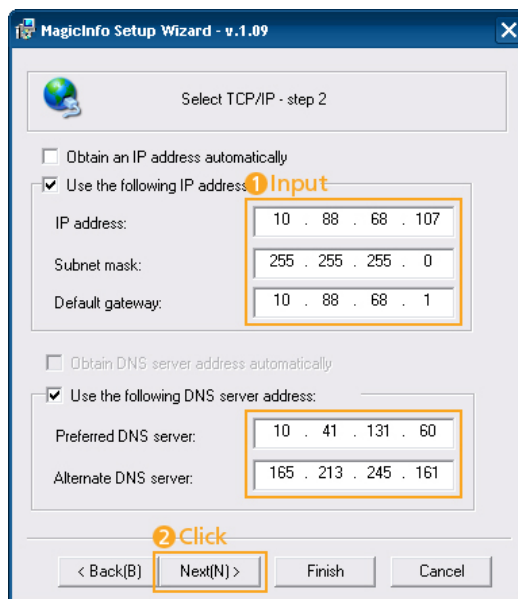

In step 2 of MagicInfo Setup Wizard, you don't have to go to Network Setting on the desktop to make your settings for TCP/IP. You just do that at step 2 of MagicInfo installation.

3. Select Language - step 3

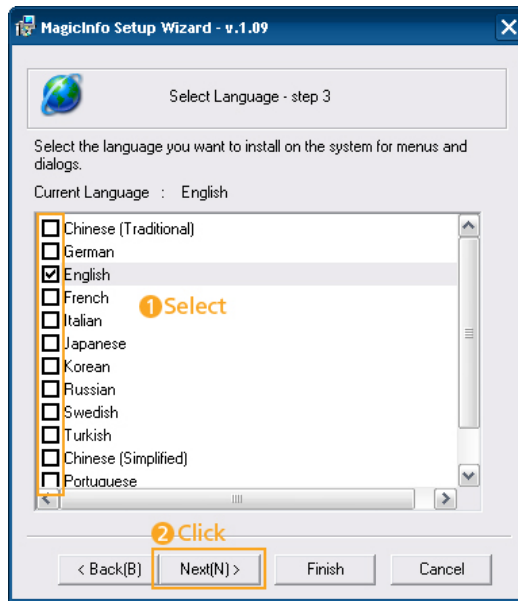

When using multiple languages, you can choose and set a specific language among them.

4. Select Screen Type - step 4

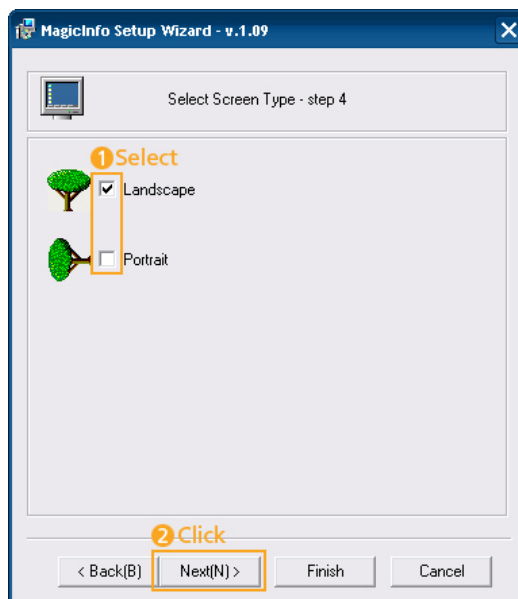

You can select which rotation type will be applied to your device.

5. Setup Information

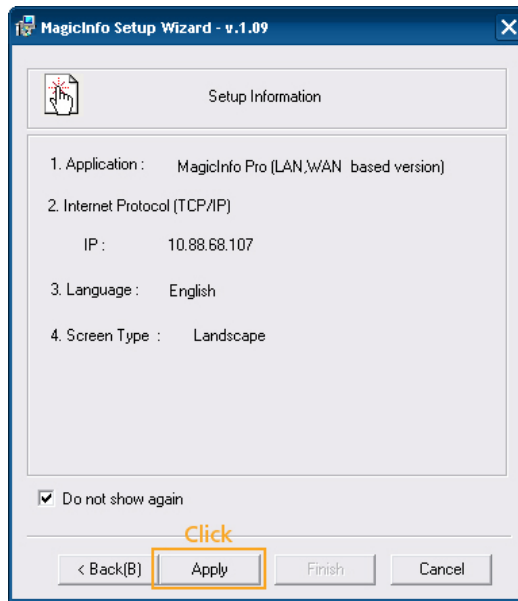

Shows the settings that have been selected by the user.

 **Note**

If the **MagicInfo** icon is not displayed on the notification area, double click the **MagicInfo** icon on the window desktop. The icon will appear.

Troubleshooting

Self-Test Feature Check



Check the following items yourself before calling for assistance. Contact a Service Center for problems that you cannot solve by yourself.

Self-Test Feature Check

1. Turn off both your computer and the LCD Display.
2. Unplug the video cable from the back of the computer.
3. Turn on the LCD Display.

The figure shown below ("**No Signal**") appears on a black background when the LCD Display is working normally even though no video signal is detected: While in the Self-Test mode, the LED power indicator remains green and the figure moves around on the screen.

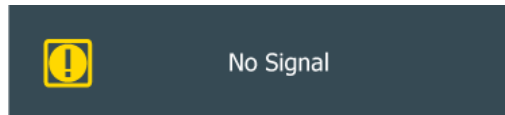

4. Turn off your LCD Display and reconnect the video cable; then turn on both your computer and the LCD Display

If your LCD Display screen remains blank after using the previous procedure, check your video controller and computer system; your LCD Display is functioning properly.

Warning Messages

You can even view the screen at a resolution of 1920 x 1080. However, you will receive the following message for a minute; You can choose to change the screen resolution or stay in the current mode during that time. If the resolution is more than 85Hz, you will see the black screen because the LCD Display does not support over 85Hz.

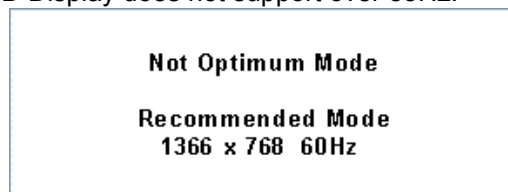

Refer to Specifications > Preset Timing Modes for the resolutions or frequencies supported by the LCD Display.

Maintenance and Cleaning

- 1) Maintaining the LCD Display Case.

Clean with a soft cloth after disconnecting the power cord.



- Do not use benzene, thinner or other flammable substances.

2) Maintaining the Flat Panel Display Screen.

Clean with a soft cloth (cotton flannel).



- Never use acetone, benzene or thinner.
(They may cause flaws or deformation of the screen surface.)
- The user is responsible for any damage caused by using these substances.

Symptoms and Recommended Actions



Note

A LCD Display recreates visual signals received from the computer. Therefore, if there is a problem with the computer or the video card, this can cause the LCD Display to become blank, have poor coloring, become noisy, etc. In this case, first check the source of the problem, and then contact a Service Center or your dealer.

1. Check if the power cord and the video cables are properly connected to the computer.
2. Check if the computer beeps more than 3 times when booting.
(If it does, request service.)
3. If you installed a new video card or if you assembled the PC, check if you installed the Adaptor(video).
4. Check if the scanning ratio of the video screen is set to between 50 Hz ~ 85 Hz.
(Do not exceed 60Hz when using the maximum resolution.)
5. If you have problems in installing the Adaptor (video) driver, boot the computer in Safe Mode, remove the Display Adaptor in the "Control Panel -> System -> Device Administrator" and then reboot the computer to reinstall the Adaptor (video) driver.

Check List



Note

- The following table lists possible problems and their solutions. Before calling for assistance, check the information in this section to see if you can remedy any problems for yourself. If you do need assistance, please call the phone number on the Information section or contact your dealer.
- For more network-related information, refer to the MagicInfo Troubleshooting section.

Problems related to the Installation (PC Mode)



Note

Problems related to the LCD Display installation and their solutions are listed.

Q: The LCD Display screen flickers.

A: Check if the signal cable between the computer and the LCD Display is securely connected.

(Refer to Connecting a Computer)

Problems related to the Screen



Problems related to the LCD Display screen and their solutions are listed.

Q: The screen is blank and the power indicator is off.

A: Ensure that the power cord is firmly connected and the LCD Display is on.

(Refer to the Connecting a Computer)

Q: "**Check Signal Cable**" message.

A: Ensure that the signal cable is firmly connected to the PC or video sources.

(Refer to the Connecting a Computer)

A: Ensure that the PC or video sources are turned on.

Q: "**Not Optimum Mode**" message.

A: Check the maximum resolution and the frequency of the video Adaptor.

A: Compare these values with the data in the Preset Timing Modes Chart.

Q: The picture rolls vertically.

A: Check if the signal cable is securely connected. Re-connect it, if necessary.

(Refer to Connecting a Computer)

Q: The image is not clear; picture is blurred.

A: Run Frequency **Coarse** and **Fine** tuning.

A: Turn on again after removing all accessories (video extension cable, etc.)

A: Set the resolution and frequency to the recommended ranges.

Q: The picture image is unstable and shakes.

A: Check if the resolution and frequency set for the computer video card falls in the range supported by the LCD Display. If not, reset them referring to the current Information under the LCD Display menu and Preset Timing Modes.

Q: Ghost images are shown in the picture.

A: Check if the resolution and frequency set for the computer video card falls in the range supported by the LCD Display. If not, reset them referring to the current Information under the LCD Display menu and Preset Timing Modes.

Q: The image is too light or too dark.

A: Adjust the **brightness** and **contrast**.

(Refer to the **Brightness, Contrast**)

- Q: The screen color is inconsistent.
- A: Adjust color using **Custom** under OSD Color Adjustment menu.
- Q: The color image is distorted by dark shadows.
- A: Adjust color using **Custom** under OSD Color Adjustment menu.
- Q: The color white is poor.
- A: Adjust color using **Custom** under OSD Color Adjustment menu.
- Q: The Power Indicator blinks.
- A: The LCD Display is currently saving the changes made in the settings to the OSD memory.
- Q: The screen is blank and the power indicator light blinks every 0.5 or 1 seconds.
- A: The LCD Display is using its power management system. Press any key on the keyboard.
- Q: The screen is blank and it is blinking.
- A: If you see the "**TEST GOOD**" message on the screen when you pressing the MENU button, check the cable connection between the LCD Display and the computer to ensure that the connector is properly connected.

Problems related to Audio



Problems related to audio signals and their solutions are listed below.

- Q: No sound.
- A: Ensure that the audio cable is firmly connected to both the audio-in port on your LCD Display and the audio-out port on your sound card.
- (Refer to the Connecting a Computer)
- A: Check the volume level.
- Q: The sound level is too low.
- A: Check the volume level.
- A: If the volume is still too low after turning the control to its maximum, check the volume control on the computer sound card or software program.
- Q: The sound is too high or too low.
- A: Adjusts the **Treble** and **Bass** to the appropriate levels.

Problems related to the Remote Control



Problems related to the remote control and their solutions are listed.

- Q: The remote control buttons do not respond.
- A: Check the polarities (+/-) of the batteries.

- A: Check if the batteries are empty.
- A: Check if the power is on.
- A: Check if the power cord is securely connected.
- A: Check if a special fluorescent or neon lamp is on in the vicinity.

Q & A

Q: How can I change the frequency?

A: The frequency can be changed by reconfiguring the video card.



That video card support can vary, depending on the version of the driver used. (Refer to the computer or the video card manual for details.)

Q: How can I adjust the resolution?

A: Windows XP:

Set the resolution in the Control Panel → Appearance and Themes → Display → Settings.

A: Windows ME/2000:

Set the resolution in the Control Panel → Display → Settings.

* Contact the video card manufacturer for details.

Q: How can I set the Power Saving function?

A: Windows XP:

Set the resolution in the Control Panel → Appearance and Themes → Display → Screen Saver.

Set the function in the BIOS-SETUP of the computer. (Refer to the Windows / Computer Manual).

A: Windows ME/2000:

Set the resolution at the Control Panel → Display → Screen Saver.

Set the function in the BIOS-SETUP of the computer. (Refer to the Windows / Computer Manual).

Q: How can I clean the outer case/LCD Panel?

A: Disconnect the power cord and then clean the LCD Display with a soft cloth, using either a cleaning solution or plain water.

Do not leave any detergent or scratches on the case. Do not let any water enter the LCD Display.

Q: How can I play the video?

A: The video supports the MPEG1 and WMV codecs only. Install the corresponding codec to play the video. Note that some of the codecs can be incompatible.

 **Note**

Before calling for assistance, check the information in this section to see if you can remedy any problems yourself. If you do need assistance, please call the phone number on the Information section or contact your dealer.

Specifications

General

General

Model Name SyncMaster 460UTn-2 / 460UT-2 / 460UTn-B / 460UT-B

LCD Panel

Size 46 inches (116 cm)

Display area 1018.35 mm (H) x 572.54 mm (V)

Pixel Pitch 0.746 mm (H) x 0.746 mm (V)

Synchronization

Horizontal 30 ~ 81 kHz

Vertical 56 ~ 85 Hz

Display Color

16.7M

Resolution

Optimum resolution 1366 x 768 @ 60 Hz

Maximum resolution 1920 x 1080 @ 60 Hz

Input Signal, Terminated

RGB Analog, DVI(Digital Visual Interface) Compliant Digital RGB

0.7 Vp-p \pm 5 %

Separate H/V sync, Composite, SOG

TTL level (V high \geq 2.0 V, V low \leq 0.8 V)

Maximum Pixel Clock

148.5 MHz (Analog,Digital)

Power Supply

This product supports 100 - 240 V.

Since the standard voltage may differ from country to country, please check the label on the back of the product.

Signal Cable

D-sub(Component), DVI-D In/Out, VCR, HDMI 1/2, RS232C In/Out, DP

DC Out, Stereo Audio In/Out, Audio In(L/R), RJ45, IR In/Out, Mini USB

- USB, LAN, D-sub out (460UTn-2, 460UTn-B Only)

Dimensions (W x H x D) / Weight

460UTn-2 1025.7 mm x 579.8 mm x 130.0 mm (40.4 x 22.8 x 5.1 inches) /
27.8 Kg (61.3 lbs)

Dimensions (W x H x D) / Weight

460UT-2	1025.7 mm x 579.8 mm x 130.0 mm (40.4 x 22.8 x 5.1 inches) / 26.3 Kg (58.0 lbs)
460UTn-B	1025.7 mm x 579.8 mm x 130.0 mm (40.4 x 22.8 x 5.1 inches) / 20.8 Kg (45.9 lbs)
460UT-B	1025.7 mm x 579.8 mm x 130.0 mm (40.4 x 22.8 x 5.1 inches) / 19.3 Kg (42.5 lbs)

VESA Mounting Interface

600 mm × 400 mm

Environmental considerations

Operating	460UTn	Temperature : 50°F ~ 104°F (10°C ~ 40°C)
	-2	Humidity : 10 % ~ 80 %, non-condensing
	460UTn	
	-B	
460UT-	2	Temperature : 32°F ~ 104°F (0°C ~ 40°C)
		Humidity : 10 % ~ 80 %, non-condensing
	460UT-	
	B	
Storage	460UTn	Temperature : -4°F ~ 113°F (-20°C ~ 45°C)
	-2	Humidity : 5 % ~ 95 %, non-condensing
	460UTn	
	-B	
	460UT-	
	2	
	460UT-	
	B	

Plug and Play Capability

This LCD Display can be installed on any Plug & Play compatible system. The interaction of the LCD Display and the computer systems will provide the best operating conditions and LCD Display settings. In most cases, the LCD Display installation will proceed automatically, unless the user wishes to select alternate settings.

Dot Acceptable

TFT-LCD panels manufactured by using advanced semiconductor technology with precision of 1ppm (one millionth) above are used for this product. But the pixels of RED, GREEN, BLUE and WHITE color appear to be bright sometimes or some black pixels may be seen. This is not from bad quality and you can use it without any problems.

For example, the number of TFT-LCD sub pixels contained in this product are 3,147,264.



Note

Design and specifications are subject to change without prior notice.

 **Class A (Information Communication equipment for industrial use) : 460UTn-2, 460UTn-B**

Attention dealers and users. This device is registered for EMC requirements for industrial use (Class A) and can be used in areas other than general households.

 **Class B (Information Communication equipment for residential use) : 460UT-2, 460UT-B**

This device is registered for EMC requirements for home use (Class B). It can be used in all areas. (Class B equipment emits less electromagnetic waves than Class A equipment.)

PowerSaver

This LCD Display has a built-in power management system called PowerSaver. This system saves energy by switching your LCD Display to low-power mode when it has not been used for a certain amount of time. The LCD Display automatically returns to normal operation when you press a key on the keyboard. For energy conservation, turn your LCD Display OFF when it is not needed, or when leaving it unattended for long periods. The PowerSaver system operates with a VESA DPM compliant video card installed in your computer. Use the software utility installed on your computer to set up this feature.

PowerSaver

	State	Normal Operation	Power saving mode	Power off	Power off (Power Switch)
	Power Indicator	On	Blinking	Amber	Off
Power Consumption (Typical)	460UTn-2	280 Watts	5 Watts	5 Watts	0 Watts
	460UT-2	200 Watts	2 Watts	1 Watts	0 Watts
	460UTn-B	240 Watts	5 Watts	5 Watts	0 Watts
	460UT-B	185 Watts	2 Watts	1 Watts	0 Watts

 **Note**

- The actual power consumption may be different from the indicated power consumption above if the system conditions or settings are changed.
- To stop any power consumption, turn off the switch or disconnect the power cable on the back. Be sure to disconnect the power if you intend to stay away from home for many hours.

Preset Timing Modes

If the signal transferred from the computer is the same as the following Preset Timing Modes, the screen will be adjusted automatically. However, if the signal differs, the screen may go blank while the power LED is on. Refer to the video card manual and adjusts the screen as follows.

Display Mode	Horizontal Frequency (kHz)	Vertical Frequency (Hz)	Pixel Clock (MHz)	Sync Polarity (H/V)
IBM, 640 x 350	31.469	70.086	25.175	+/-
IBM, 640 x 480	31.469	59.940	25.175	-/-
IBM, 720 x 400	31.469	70.087	28.322	-/+

Display Mode	Horizontal Frequency (kHz)	Vertical Frequency (Hz)	Pixel Clock (MHz)	Sync Polarity (H/V)
MAC, 640 x 480	35.000	66.667	30.240	-/-
MAC, 832 x 624	49.726	74.551	57.284	-/-
MAC, 1152 x 870	68.681	75.062	100.000	-/-
VESA, 640 x 480	37.861	72.809	31.500	-/-
VESA, 640 x 480	37.500	75.000	31.500	-/-
VESA, 800 x 600	35.156	56.250	36.000	+/+
VESA, 800 x 600	37.879	60.317	40.000	+/+
VESA, 800 x 600	48.077	72.188	50.000	+/+
VESA, 800 x 600	46.875	75.000	49.500	+/+
VESA, 848 x 480	31.020	60.000	33.750	+/+
VESA, 1024 x 768	48.363	60.004	65.000	-/-
VESA, 1024 x 768	56.476	70.069	75.000	-/-
VESA, 1024 x 768	60.023	75.029	78.750	+/+
VESA, 1152 x 864	67.500	75.000	108.000	+/+
VESA, 1280 x 768	47.776	59.870	79.500	-/+
VESA, 1280 x 960	60.000	60.000	108.000	+/+
VESA, 1280 x 1024	63.981	60.020	108.000	+/+
VESA, 1280 x 1024	79.976	75.025	135.000	+/+
VESA, 1360 x 768	47.712	60.015	85.500	+/+
VESA, 1366 x 768	47.712	59.790	85.500	+/+
VESA, 1600 x 1200	75.000	60.000	162.000	+/+
VESA, 1920 x 1080	67.500	60.000	148.500	+/+

Horizontal Frequency

The time to scan one line connecting the right edge to the left edge of the screen horizontally is called the Horizontal Cycle and the inverse number of the Horizontal Cycle is called the Horizontal Frequency. Unit: kHz



Vertical Frequency

Like a fluorescent lamp, the screen has to repeat the same image many times per second to display an image to the user. The frequency of this repetition is called the Vertical Frequency or Refresh Rate. Unit: Hz

Information

For a Better Display

- Adjust the computer resolution and screen injection rate (refresh rate) on the computer as described below to enjoy the best picture quality. You can have an uneven picture quality on screen if the best picture quality is not provided for TFT-LCD.
- Resolution: 1366 x 768
- Vertical frequency (refresh rate): 60 Hz
- TFT-LCD panels manufactured by using advanced semiconductor technology with a precision of 1ppm (one millionth) and above is used for this product. But the pixels of RED, GREEN, BLUE and WHITE color seem to be bright sometimes or some of black pixels could be seen. This is not from bad quality and you can use it without any problems.
- For example, the number of TFT-LCD sub pixels contained in this product are 3,147,264.
- When cleaning the monitor and the panel outside, please apply a small amount of water to a soft cloth. Rub softly when cleaning the LCD area. If excessive force is applied, you may stain it.
- If you are not satisfied with the picture quality, you can get better quality of picture by performing the "**Auto Adjustment** function" in display screen that is appeared as window termination button is pressed. If there's still noise after the automatic adjustment, use the **Fine/Coarse** adjustment function.
- When viewing a fixed screen for an extended period of time, a residual image or blurriness may appear. Change the mode to energy save or set a screensaver to move the picture when you need to be away from the monitor for an extended period of time.

PRODUCT INFORMATION (Image Retention Free)

➤ *What is Image Retention ?*

Image retention may not occur when a LCD panel is operated under normal conditions.

Normal conditions are defined as continuously changing video patterns. When the LCD panel is operated for a long time with a fixed pattern (over 12 hours), there may be slight difference in voltage between electrodes that work the liquid crystal (LC) in a pixel. The voltage difference between electrodes increases with time, forcing the liquid crystal to lean. When this occurs, the previous image may be seen when the pattern is changed. To prevent this, the accumulated voltage difference must be decreased.

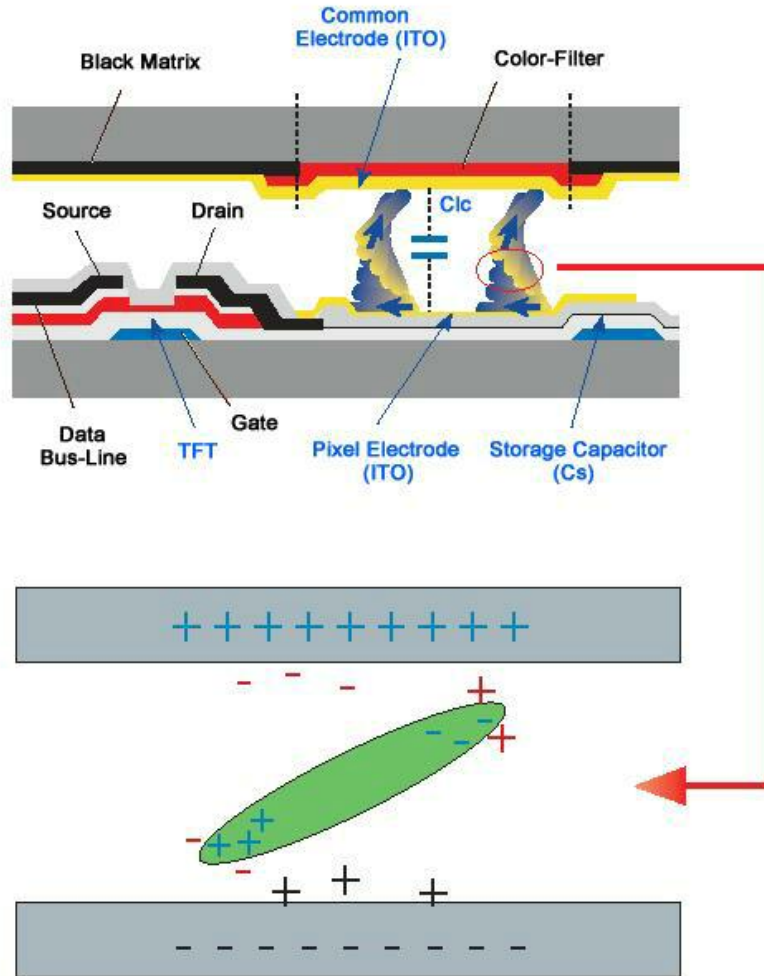

+ *Power Off, Screen Saver, or Power Save Mode*

- Turn the power off for 2 hours after 12 hours in use
- Set the Monitor to power off with the PC Display Properties Power Scheme.
- Use a Screen saver if possible - Screen saver in one color or a moving image is recommended.
- The Image Retention Free function applied to the product is recommended.
- For detailed configuration procedures, refer to the back page.

+ *Change the Color Information periodically*

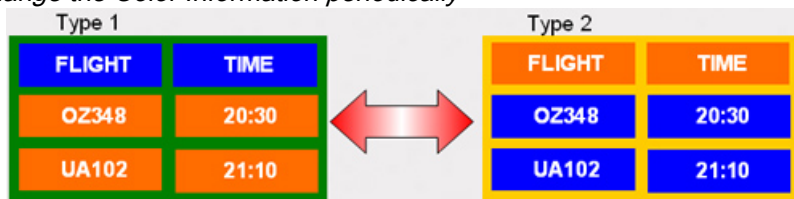

Note

Use Two different colors

Rotate the Color Information with 2 different colors every 30 minutes.

- Avoid using a combination of characters and background color with large difference in luminance.

Avoid using Grey colors, which can cause Image retention easily.

Avoid: Colors with big difference in luminance (Black & White, Grey)



+ *Change the characters color periodically*

- Use Bright colors with little difference in luminance.
 - Cycle : Change the characters color and background color every 30 minutes



- Every 30 minutes, change the characters with movement.



- Have the images and logo cycle periodically.
 - Cycle: Display moving image together with Logo for 60 seconds after 4 hours in use.
- The best way to protect your monitor from Image retention is to turn the Power off, or set your PC or System to operate a Screen Saver program when you are not using it. If these guidelines are not followed, it may affect your warranty.

+ *Apply the Screen Pixel function on Product*

- Apply the Screen Pixel function
 - Symptom: Dot with Black Color move up and down.

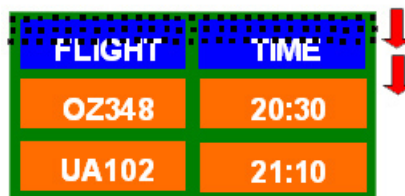

- Apply the Screen Bar function
 - Symptom: Horizontal / Vertical Bar with Black Color move up and down.



+ Apply the Screen Erasing function on Product

- Apply the Screen Erasing function
 - Symptom: 2 Vertical blocks move while erasing the display

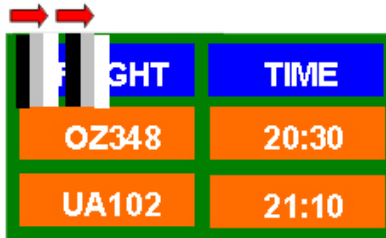

Appendix

Contact SAMSUNG WORLDWIDE



If you have any questions or comments relating to Samsung products, please contact the SAMSUNG customer care center.

North America

U.S.A	1-800-SAMSUNG(726-7864)	http://www.samsung.com
CANADA	1-800-SAMSUNG(726-7864)	http://www.samsung.com
MEXICO	01-800-SAMSUNG (726-7864)	http://www.samsung.com

Latin America

ARGENTINA	0800-333-3733	http://www.samsung.com
BRAZIL	0800-124-421	http://www.samsung.com
	4004-0000	
CHILE	800-SAMSUNG(726-7864)	http://www.samsung.com
COLOMBIA	01-8000112112	http://www.samsung.com
COSTA RICA	0-800-507-7267	http://www.samsung.com
ECUADOR	1-800-10-7267	http://www.samsung.com
EL SALVADOR	800-6225	http://www.samsung.com
GUATEMALA	1-800-299-0013	http://www.samsung.com
HONDURAS	800-7919267	http://www.samsung.com
JAMAICA	1-800-234-7267	http://www.samsung.com
NICARAGUA	00-1800-5077267	http://www.samsung.com
PANAMA	800-7267	http://www.samsung.com
PUERTO RICO	1-800-682-3180	http://www.samsung.com
REP. DOMINICA	1-800-751-2676	http://www.samsung.com
TRINIDAD & TOBAGO	1-800-SAMSUNG(726-7864)	http://www.samsung.com
VENEZUELA	0-800-100-5303	http://www.samsung.com

Europe

AUSTRIA	0810 - SAMSUNG (7267864, € 0.07/min)	http://www.samsung.com
BELGIUM	02-201-24-18	http://www.samsung.com/be (Dutch) http://www.samsung.com/ be_fr (French)
CZECH	800 - SAMSUNG (800-726786)	http://www.samsung.com
<small>Distributor pro Českou republiku: Samsung Zrt., česká organizační složka, Oasis Florenc, Sokolovská394/17, 180 00, Praha 8</small>		
DENMARK	70 70 19 70	http://www.samsung.com

Europe

EIRE	0818 717100	http://www.samsung.com
ESTONIA	800-7267	http://www.samsung.com
FINLAND	030 - 6227 515	http://www.samsung.com
FRANCE	01 48 63 00 00	http://www.samsung.com
GERMANY	01805 - SAMSUNG (726-7864, € 0,14/Min)	http://www.samsung.com
HUNGARY	06-80-SAMSUNG (726-7864)	http://www.samsung.com
ITALIA	800-SAMSUNG (726-7864)	http://www.samsung.com
LATVIA	8000-7267	http://www.samsung.com
LITHUANIA	8-800-77777	http://www.samsung.com
LUXEMBURG	261 03 710	http://www.samsung.com
NETHERLANDS	0900-SAMSUNG (0900-7267864) (€ 0,10/Min)	http://www.samsung.com
NORWAY	815-56 480	http://www.samsung.com
POLAND	0 801 1SAMSUNG(172678) 022-607-93-33	http://www.samsung.com
PORTUGAL	80820 - SAMSUNG (7267864)	http://www.samsung.com
SLOVAKIA	0800 - SAMSUNG(726-7864)	http://www.samsung.com
SPAIN	902 - 1 - SAMSUNG (902 172 678)	http://www.samsung.com
SWEDEN	0771 726 7864 (SAMSUNG)	http://www.samsung.com
SWITZERLAND	0848 - SAMSUNG (7267864, CHF 0.08/min)	<a href="http://www.samsung.com/ch
ch_fr/(French)">http://www.samsung.com/ ch_fr/(French)
U.K	0845 SAMSUNG (7267864)	http://www.samsung.com

CIS

ARMENIA	0-800-05-555	
AZERBAIJAN	088-55-55-555	
BELARUS	810-800-500-55-500	
GEORGIA	8-800-555-555	
KAZAKHSTAN	8-10-800-500-55-500	
KYRGYZSTAN	00-800-500-55-500	http://www.samsung.com
MOLDOVA	00-800-500-55-500	
RUSSIA	8-800-555-55-55	http://www.samsung.com
TADJIKISTAN	8-10-800-500-55-500	http://www.samsung.com
UKRAINE	0-800-502-000	http://www.samsung.com/ua
		http://www.samsung.com/ ua_ru
UZBEKISTAN	8-10-800-500-55-500	http://www.samsung.com

Asia Pacific

AUSTRALIA	1300 362 603	http://www.samsung.com
CHINA	400-810-5858	http://www.samsung.com
	010-6475 1880	
HONG KONG	(852) 3698 - 4698	http://www.samsung.com/hk
		http://www.samsung.com/hk_en/
INDIA	3030 8282	http://www.samsung.com
	1800 110011	
	1800 3000 8282	
	1800 266 8282	
INDONESIA	0800-112-8888	http://www.samsung.com
	021-5699-7777	
JAPAN	0120-327-527	http://www.samsung.com
MALAYSIA	1800-88-9999	http://www.samsung.com
NEW ZEALAND	0800 SAMSUNG (0800 726 786)	http://www.samsung.com
PHILIPPINES	1-800-10-SAMSUNG (726-7864)	http://www.samsung.com
	1-800-3-SAMSUNG (726-7864)	
	1-800-8-SAMSUNG (726-7864)	
	02-5805777	
SINGAPORE	1800-SAMSUNG(726-7864)	http://www.samsung.com
TAIWAN	0800-329-999	http://www.samsung.com
THAILAND	1800-29-3232	http://www.samsung.com
	02-689-3232	
VIETNAM	1 800 588 889	http://www.samsung.com

Middle East & Africa

BAHRAIN	8000-4726	
JORDAN	800-22273	
SOUTH AFRICA	0860-SAMSUNG(726-7864)	http://www.samsung.com
TURKEY	444 77 11	http://www.samsung.com
U.A.E	800-SAMSUNG(726-7864)	http://www.samsung.com

Terms

Dot Pitch	The image on a monitor is composed of red, green and blue dots. The closer the dots, the higher the resolution. The distance between two dots of the same color is called the 'Dot Pitch'. Unit: mm
-----------	---

Vertical Frequency	<p>The screen must be redrawn several times per second in order to create and display an image for the user. The frequency of this repetition per second is called the Vertical Frequency or Refresh Rate. Unit: Hz</p> <p>Example: If the same light repeats itself 60 times per second, this is regarded as 60 Hz.</p>
Horizontal Frequency	<p>The time to scan one line connecting the right edge to the left edge of the screen horizontally is called the Horizontal Cycle. The inverse number of the Horizontal Cycle is called Horizontal Frequency. Unit: kHz</p>
Interlace and Non-Interlace Methods	<p>Showing the horizontal lines of the screen from the top to the bottom sequentially is called the Non-Interlace method while showing odd lines and then even lines in turn is called the Interlace method. The Non-Interlace method is used for the majority of monitors to ensure a clear image. The Interlace method is the same as that used in TVs.</p>
Plug & Play	<p>This is a function that provides the best quality screen for the user by allowing the computer and the monitor to exchange information automatically. This monitor follows the international standard VESA DDC for the Plug & Play function.</p>
Resolution	<p>The number of horizontal and vertical dots used to compose the screen image is called the 'resolution'. This number shows the accuracy of the display. A high resolution is good for performing multiple tasks as more image information can be shown on the screen.</p> <p>Example: If the resolution is 1920 x 1080, this means the screen is composed of 1920 horizontal dots (horizontal resolution) and 1080 vertical lines (vertical resolution).</p>

Correct Disposal

Correct Disposal of This Product (Waste Electrical & Electronic Equipment) - Europe only



(Applicable in the European Union and other European countries with separate collection systems)

This marking on the product, accessories or literature indicates that the product and its electronic accessories (e.g. charger, headset, USB cable) should not be disposed of with other household waste at the end of their working life. To prevent possible harm to the environment or human health from uncontrolled waste disposal, please separate these items from other types of waste and recycle them responsibly to promote the sustainable reuse of material resources.

Household users should contact either the retailer where they purchased this product, or their local government office, for details of where and how they can take these items for environmentally safe recycling.

Business users should contact their supplier and check the terms and conditions of the purchase contract. This product and its electronic accessories should not be mixed with other commercial wastes for disposal.

Correct disposal of batteries in this product - Europe only



(Applicable in the European Union and other European countries with separate battery return systems.)

This marking on the battery, manual or packaging indicates that the batteries in this product should not be disposed of with other household waste at the end of their working life. Where marked, the chemical symbols Hg, Cd or Pb indicate that the battery contains mercury, cadmium or lead above the reference levels in EC Directive 2006/66. If batteries are not properly disposed of, these substances can cause harm to human health or the environment.

To protect natural resources and to promote material reuse, please separate batteries from other types of waste and recycle them through your local, free battery return system.



Note

The rechargeable battery incorporated in this product is not user replaceable. For information on its replacement, please contact your service provider.

Authority

Information in this document is subject to change without notice.

© 2010 Samsung Electronics Co., Ltd. All rights reserved.

Reproduction in any manner whatsoever without the written permission of Samsung Electronics Co., Ltd. is strictly forbidden.

Samsung Electronics Co., Ltd. shall not be liable for errors contained herein or for incidental or consequential damages in connection with the furnishing, performance, or use of this material.

Samsung is the registered trademark of Samsung Electronics Co., Ltd.; Microsoft, Windows and Windows NT are registered trademarks of Microsoft Corporation; VESA, DPM and DDC are registered trademarks of Video Electronics Standard Association; All other product names mentioned herein may be the trademarks or registered trademarks of their respective owners.



TruSurround XT, SRS and (●) Symbol are trademarks of SRS Labs, Inc.
TruSurround XT technology is incorporated under license from SRS Labs, Inc.

CALIFORNIA USA ONLY (Applicable for networking models only.)

This Perchlorate warning applies only to primary CR(Manganese Dioxide) Lithium coin cells in the product sold or distributed ONLY in California USA

*Perchlorate Material - special handling may apply,
See www.dtsc.ca.gov/hazardouswaste/perchlorate.*