

HP Notebook

Reference Guide

© Copyright 2011 Hewlett-Packard
Development Company, L.P.

Bluetooth is a trademark owned by its proprietor and used by Hewlett-Packard Company under license. Intel is a trademark of Intel Corporation in the U.S. and other countries. Microsoft and Windows are U.S. registered trademarks of Microsoft Corporation. Java is a U.S. trademark of Sun Microsystems, Inc.

The information contained herein is subject to change without notice. The only warranties for HP products and services are set forth in the express warranty statements accompanying such products and services. Nothing herein should be construed as constituting an additional warranty. HP shall not be liable for technical or editorial errors or omissions contained herein.

Third Edition: January 2011

First Edition: April 2010

Document Part Number: 607194-003

Product notice

This reference guide describes features that are common to most models. Some features may not be available on your computer.

Safety warning notice

-
- ⚠ **WARNING!** To reduce the possibility of heat-related injuries or of overheating the computer, do not place the computer directly on your lap or obstruct the computer air vents. Use the computer only on a hard, flat surface. Do not allow another hard surface, such as an adjoining optional printer, or a soft surface, such as pillows or rugs or clothing, to block airflow. Also, do not allow the AC adapter to come into contact with the skin or a soft surface, such as pillows or rugs or clothing, during operation. The computer and the AC adapter comply with the user-accessible surface temperature limits defined by the International Standard for Safety of Information Technology Equipment (IEC 60950).
-

Table of contents

1 Introduction	1
Finding more information about your new computer	1
2 Networking (select models only)	2
Creating a wireless connection	2
Identifying wireless and network status icons	2
Turning wireless devices on or off	3
Using the wireless button	3
Using HP Wireless Assistant (select models only) to turn wireless devices on or off	4
Using HP Connection Manager (select models only)	4
Using operating system controls	5
Using a WLAN	5
Connecting to an existing WLAN	5
Setting up a new WLAN	6
Protecting your WLAN	7
Roaming to another network	7
Using HP Mobile Broadband (select models only)	7
Inserting a SIM	8
Removing a SIM	8
Using Bluetooth wireless devices	9
Bluetooth and Internet Connection Sharing (ICS)	9
Using GPS (select models only)	9
Connecting to a wired network	9
Using a modem (select models only)	9
Connecting a modem cable	10
Connecting a country- or region-specific modem cable adapter	10
Selecting a location setting	11
Viewing the current location selection	11
Adding new locations when traveling	11
Connecting to a local area network (LAN) (select models only)	13

3 Multimedia	15
Using the media activity controls	15
Audio	15
Adjusting the volume	16
Checking audio functions on the computer	16
Webcam (select models only)	17
Using SkyRoom (select models only)	17
Video	17
VGA	17
DisplayPort	18
HDMI	18
Configuring audio for HDMI	19
Intel Wireless Display (select models only)	19
Using HP MediaSmart (select models only)	20
4 Power management	21
Shutting down the computer	21
Setting power options	22
Using power-saving states	22
Initiating and exiting Sleep	22
Initiating and exiting Hibernation	23
Using the power meter	23
Using power plans	23
Viewing the current power plan	23
Selecting a different power plan	24
Customizing power plans	24
Setting password protection on wakeup	24
Using battery power	25
Finding battery information in Help and Support in Windows 7	25
Using Battery Check in Windows 7	26
Displaying the remaining battery charge	26
Maximizing battery discharge time	26
Managing low battery levels	26
Identifying low battery levels	26
Resolving a low battery level	27
Resolving a low battery level when external power is available	27
Resolving a low battery level when a charged battery is available ...	27
Resolving a low battery level when no power source is available	27
Resolving a low battery level when the computer cannot exit	
Hibernation	27
Conserving battery power	27

Storing a battery	28
Disposing of a used battery	28
Replacing the battery	28
Using external AC power	29
Testing an AC adapter	30
5 External cards and devices	31
Using Digital Media Slot cards (select models only)	31
Inserting a digital card	31
Removing a digital card	32
Using PC Cards (select models only)	32
Configuring a PC Card	33
Inserting a PC Card	33
Removing a PC Card	34
Using ExpressCards (select models only)	35
Configuring an ExpressCard	35
Inserting an ExpressCard	36
Removing an ExpressCard	37
Using smart cards (select models only)	37
Inserting a smart card	38
Removing a smart card	38
Using a USB device	38
Connecting a USB device	38
Removing a USB device	39
Using 1394 devices (select models only)	39
Connecting a 1394 device	40
Removing a 1394 device	40
Using an eSATA device (select models only)	40
Connecting an eSATA device	41
Removing an eSATA device	41
Using optional external devices	42
Using optional external drives	42
Using the expansion port (select models only)	42
Using the docking connector (select models only)	43
6 Drives	44
Handling drives	44
Using hard drives	45
Improving hard drive performance	45
Using Disk Defragmenter	45
Using Disk Cleanup	45

Using HP ProtectSmart Hard Drive Protection in Windows 7 (select models only)	46
Identifying HP ProtectSmart Hard Drive Protection status	46
Managing power with a parked hard drive	46
Using HP ProtectSmart Hard Drive Protection software	47
Using optical drives (select models only)	47
Identifying the installed optical drive	47
Inserting an optical disc	48
Tray load	48
Slot load	48
Removing an optical disc	49
Tray load	49
When the disc tray opens normally	49
When the disc tray fails to open	49
Slot load	50
Sharing optical drives	51
Using RAID (select models only)	51
7 Security	52
Protecting the computer	52
Using passwords	52
Setting passwords in Windows	53
Setting passwords in Setup Utility	53
Managing an administrator password	54
Entering an administrator password	54
Managing a power-on password	55
Entering a power-on password	55
Using antivirus software	55
Using firewall software	55
Installing critical security updates	56
Installing an optional security cable	56
Using the fingerprint reader (select models only)	57
Locating the fingerprint reader	57
8 Maintenance	58
Cleaning your computer	58
Cleaning the display	58
Cleaning the TouchPad and keyboard	58
Updating programs and drivers	58
Using SoftPaq Download Manager	59

9 Setup Utility (BIOS) and System Diagnostics	60
Using Setup Utility	60
Starting Setup Utility	60
Changing the language of Setup Utility	60
Navigating and selecting in Setup Utility	61
Displaying system information	61
Restoring factory settings in Setup Utility	62
Exiting Setup Utility	62
Updating the BIOS	62
Determining the BIOS version	62
Downloading a BIOS update	63
Using System Diagnostics	64
Appendix A Traveling with the computer	65
Appendix B Troubleshooting resources	67
Appendix C Electrostatic Discharge	68
Index	69

1 Introduction

This guide contains general information about HP and Compaq notebook computers, including connecting to a wireless network, multimedia, power management, security, and so on.

 **NOTE:** Some of the features described in this guide may not be available on your computer.

Finding more information about your new computer

The following user guides and reference material are provided with your computer, either in print, on the computer hard drive, or on an optical disc or SD Card:

- *Quick Setup* poster—Guides you through setting up your computer and turning it on. The poster is located in the computer box.

 **NOTE:** Refer to the poster for the location of your user guides and reference material.

- *Getting Started*—Contains information about your computer, including product-specific features, backup and recovery, maintenance, and specifications.
- Help and Support—Contains information about the operating system, drivers, troubleshooting tools, and technical support. To access Help and Support, select **Start > Help and Support**. For country- or region-specific support, go to <http://www.hp.com/support>, select your country or region, and follow the on-screen instructions.
- *Safety & Comfort Guide*—Describes proper workstation setup and proper posture, health, and work habits for computer users. It also provides important electrical and mechanical safety information. To access this guide, select **Start > Help and Support > User Guides**. This guide is also available on the Web at <http://www.hp.com/ergo>.
- *Regulatory, Safety, and Environmental Notices*—Contains safety and regulatory information, and battery disposal information. To access the notices, select **Start > Help and Support > User Guides**.

2 Networking (select models only)

Your computer supports 2 types of Internet access:

- **Wireless**—Refer to [Creating a wireless connection on page 2](#).
- **Wired**—Refer to [Connecting to a wired network on page 9](#).

 **NOTE:** You must set up Internet service before you can connect to the Internet.

Creating a wireless connection





Your computer may be equipped with one or more of the following wireless devices:





- Wireless local area network (WLAN) device
- HP Mobile Broadband Module (wireless wide area network (WWAN))
- Bluetooth® device

For more information on wireless technology, refer to the information and Web site links provided in Help and Support.







Identifying wireless and network status icons

Windows 7

Icon	Name	Description
	Wireless (connected)	Indicates that one or more wireless devices are on.
	Wireless (disconnected)	Indicates that all wireless devices are off.
	HP Connection Manager	Opens HP Connection Manager, which enables you to create a connection with an HP Mobile Broadband Module (select models only).
	Wired network (connected)	Indicates that one or more network devices are connected to the network.

	Network (disabled/ disconnected)	Indicates that all network devices are disabled in Windows Control Panel.
	Network (connected)	Indicates that one or more network devices are connected to a network.
	Network (disconnected)	Indicates that network devices are not connected to a network.
	Network (disabled/ disconnected)	Indicates that no wireless connections are available.

Windows XP

Icon	Name	Description
	HP Connection Manager	Opens HP Connection Manager, which enables you to create a connection with an HP Mobile Broadband Module (select models only).
	Wireless (connected)	Indicates that one or more wireless devices are on.
	Wireless (disconnected)	Indicates that all wireless devices are off.
	Wireless network connection (connected)	Indicates that one or more WLAN devices are connected to a network.
	Wireless network connection (disconnected)	Indicates that one or more WLAN devices are not connected to a network.
	Network status (connected)	Connected to the wired network.
	Network status (disconnected)	Not connected to the wired network.

Turning wireless devices on or off

Using the wireless button

 **NOTE:** A computer may have a wireless button, a wireless switch, or a wireless action key on the keyboard. The term *wireless button* is used throughout this guide to refer to all types of wireless controls. Refer to the *Getting Started* guide for information on identifying the location of the wireless button on your computer.

You can use the wireless button to simultaneously turn on or turn off the wireless network controller and Bluetooth device. These devices can be controlled through Wireless Assistant (select models only).

Using HP Wireless Assistant (select models only) to turn wireless devices on or off

A wireless device can be turned on or off using Wireless Assistant. If a wireless device is disabled in Setup Utility, it must be reenabled in Setup Utility before it can be turned on or off using Wireless Assistant.

 **NOTE:** Enabling and turning on a wireless device does not automatically connect the computer to a network or a Bluetooth-enabled device.

To view the state of the wireless devices, click the **Show hidden icons** icon, the arrow at the left of the notification area, and position the mouse pointer over the wireless icon.

▲ To open Wireless Assistant, double-click the wireless icon in the notification area.

If the wireless icon is not displayed in the notification area, complete the following steps:

Windows 7

1. Select **Start > Control Panel > Hardware and Sound > Windows Mobility Center**.
2. Click the wireless icon in the Wireless Assistant tile, which is located in the bottom row of Windows® Mobility Center.
3. Click **Properties**.
4. Select the check box next to **HP Wireless Assistant icon in notification area**.
5. Click **Apply**.
6. Click **Close**.

For more information, refer to the Wireless Assistant software Help:

1. Open Wireless Assistant by clicking the wireless icon in Windows Mobility Center.
2. Click the **Help** button.

Windows XP

1. Select **Start > Control Panel > Network and Internet Connections > HP Wireless Assistant**.
2. Click **Properties**.
3. Select the check box next to **Wireless Assistant icon in notification area**.
4. Click **Apply**.

Using HP Connection Manager (select models only)

You can use HP Connection Manager to connect to WWANs using the HP Mobile Broadband Module in your computer (select models only).

▲ To start Connection Manager, click the **HP Connection Manager** icon in the notification area, at the far right of the taskbar.

– or –

Select **Start > All Programs > HP Connection Manager > HP Connection Manager**.

For more details about using Connection Manager, refer to the Connection Manager software Help.

Using operating system controls

The Network and Sharing Center allows you to set up a connection or network, connect to a network, manage wireless networks, and diagnose and repair network problems.

Windows 7

- ▲ Select **Start > Control Panel > Network and Internet > Network and Sharing Center**.

Windows XP

- ▲ Select **Start > Control Panel > Network and Internet Connections > Network Connections**.

For more information, select **Start > Help and Support**.

Using a WLAN

A wireless connection connects the computer to Wi-Fi networks, or WLANs. A WLAN is composed of other computers and accessories that are linked by a wireless router or a wireless access point.

Connecting to an existing WLAN

Windows 7

1. Be sure that the WLAN device is on. (Refer to [Turning wireless devices on or off on page 3](#).)
2. Click the network icon in the notification area, at the far right of the taskbar.
3. Select your WLAN from the list.
4. Click **Connect**.

If the network is a security-enabled WLAN, you are prompted to enter a network security code. Type the code, and then click **OK** to complete the connection.

 **NOTE:** If no WLANs are listed, you are out of range of a wireless router or access point.

NOTE: If you do not see the network you want to connect to, click **Open Network and Sharing Center**, and then click **Set up a new connection or network**. A list of options is displayed. You can choose to manually search for and connect to a network or to create a new network connection.

Windows XP

1. Be sure that the WLAN device is on. (Refer to [Turning wireless devices on or off on page 3.](#))
2. Select **Start > Connect to**.
3. Select your WLAN from the list.
 - If the network is unsecured, a warning is displayed. Click **Connect Anyway** to accept the warning and complete the connection.
 - If the network is a security-enabled WLAN, you are prompted to enter a network security code. Type the code, and then click **Connect** to complete the connection.

 **NOTE:** If no WLANs are listed, you are out of range of a wireless router or access point.

NOTE: If you do not see the network you want to connect to, click **Set up a connection or network**. A list of options is displayed. You can choose to manually search for and connect to a network or to create a new network connection.

After the connection is made, you can place the mouse pointer over the network icon in the notification area, at the far right of the taskbar, to verify the name and status of the connection.

 **NOTE:** The functional range (how far your wireless signals travel) depends on WLAN implementation, router manufacturer, and interference from other electronic devices or structural barriers such as walls and floors.

Setting up a new WLAN

Required equipment:

- A broadband modem (either DSL or cable) **(1)** and high-speed Internet service purchased from an Internet service provider (ISP)
- A wireless router (purchased separately) **(2)**
- The wireless computer **(3)**

 **NOTE:** Some cable modems include a built-in router. Check with your ISP to see if you need a separate router.

The illustration below shows an example of a wireless network installation that is connected to the Internet.

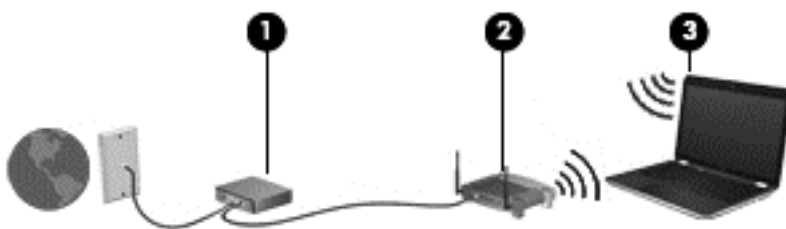

 **NOTE:** When setting up a wireless connection, be sure that your computer and wireless router are synchronized. To synchronize your computer and wireless router, turn your computer and wireless router off and then back on.

As your network grows, additional wireless and wired computers can be connected to the network to access the Internet.

For help in setting up your WLAN, refer to the information provided by your router manufacturer or your ISP.

Protecting your WLAN

When you set up a WLAN or access an existing WLAN, always enable security features to protect your network from unauthorized access. WLANs in public areas (hotspots) like coffee shops and airports may not provide any security. If you are concerned about the security of your computer in a hotspot, limit your network activities to e-mail that is not confidential and basic Internet surfing.

Wireless radio signals travel outside the network, so other WLAN devices can pick up unprotected signals. You can take the following precautions to protect your WLAN:

- **Firewall**—Checks both data and requests for data that are sent to your network, and discards any suspicious items. Firewalls are available in both software and hardware. Some networks use a combination of both types.
- **Wireless encryption**—Wi-Fi Protected Access (WPA) uses security settings to encrypt and decrypt data transmitted over the network. WPA uses Temporal Key Integrity Protocol (TKIP) to dynamically generate a new key for every packet. It also generates different sets of keys for each computer on the network.

Roaming to another network

When you move your computer within range of another WLAN, Windows attempts to connect to that network. If the attempt is successful, your computer is automatically connected to the new network. If Windows does not recognize the new network, follow the same procedure you used initially to connect to your WLAN.

Using HP Mobile Broadband (select models only)

HP Mobile Broadband enables your computer to use wireless wide area networks (WWANs) to access the Internet from more places and over larger areas than it can by using WLANs. Using HP Mobile Broadband requires a network service provider, which in most cases is a mobile phone network provider.

When used with mobile network provider service, HP Mobile Broadband gives you the freedom to stay connected to the Internet, send e-mail, or connect to your corporate network whether you are on the road or outside the range of Wi-Fi hotspots.

 **NOTE:** You may need the HP Mobile Broadband Module serial number to activate mobile broadband service. Refer to the *Getting Started* guide for the location of the serial number.

Some mobile network service providers require the use of a subscriber identity module (SIM). A SIM contains basic information about you, such as a personal identification number (PIN), as well as network information. Some computers include a preinstalled SIM. If the SIM is not preinstalled, it may be included with the HP Mobile Broadband information provided with your computer, or it may be provided separately by the mobile network service provider.

For information on inserting and removing the SIM, refer to [Inserting a SIM on page 8](#) and [Removing a SIM on page 8](#).

For information on HP Mobile Broadband and how to activate service with a preferred mobile network service provider, refer to the HP Mobile Broadband information included with your computer. For additional information, see the HP Web site at <http://www.hp.com/go/mobilebroadband> (U.S. only).

Inserting a SIM

 **NOTE:** To identify the SIM slot location, refer to the *Getting Started* guide.

1. Shut down the computer. If you are not sure whether the computer is off or in Hibernation, turn the computer on by pressing the power button. Then shut down the computer through the operating system.
2. Close the display.
3. Disconnect all external devices connected to the computer.
4. Unplug the power cord from the AC outlet.
5. Remove the battery.
6. Insert the SIM into the SIM slot, and gently press the SIM into the slot until it is firmly seated.

△ **CAUTION:** When inserting a SIM, position the card to match the icon next to the SIM slot on the computer. If a SIM is inserted incorrectly, it could damage the SIM and the SIM connector.

To reduce the risk of damage to the connector, use minimal force when inserting a SIM.

7. Replace the battery.

 **NOTE:** HP Mobile Broadband is disabled if the battery is not replaced.

8. Reconnect external power and external devices.
9. Turn on the computer.

Removing a SIM

 **NOTE:** To identify the SIM slot location, refer to the *Getting Started* guide.

1. Shut down the computer. If you are not sure whether the computer is off or in Hibernation, turn the computer on by pressing the power button. Then shut down the computer through the operating system.
2. Close the display.
3. Disconnect all external devices connected to the computer.
4. Unplug the power cord from the AC outlet.
5. Remove the battery.
6. Press in on the SIM, and then remove it from the slot.
7. Replace the battery.
8. Reconnect external power and external devices.
9. Turn on the computer.

Using Bluetooth wireless devices

A Bluetooth device provides short-range wireless communications that replace the physical cable connections that traditionally link electronic devices such as the following:

- Computers
- Phones
- Imaging devices (cameras and printers)
- Audio devices

Bluetooth devices provide peer-to-peer capability that allows you to set up a personal area network (PAN) of Bluetooth devices. For information on configuring and using Bluetooth devices, refer to the Bluetooth software Help.

Bluetooth and Internet Connection Sharing (ICS)

HP does **not** recommend setting up one computer with Bluetooth as a host and using it as a gateway through which other computers may connect to the Internet. When two or more computers are connected using Bluetooth, and Internet Connection Sharing (ICS) is enabled on one of the computers, the other computers may not be able to connect to the Internet using the Bluetooth network.

The strength of Bluetooth is in synchronizing information transfers between your computer and wireless devices including cellular phones, printers, cameras, and PDAs. The inability to consistently connect two or more computers to share the Internet through Bluetooth is a limitation of Bluetooth and the Windows operating system.

Using GPS (select models only)

Your computer may be equipped with a Global Positioning System (GPS). GPS satellites deliver location, speed, and direction information to GPS-equipped systems.

For more information, refer to the HP Connection Manager software Help.

Connecting to a wired network

Using a modem (select models only)

A modem must be connected to an analog telephone line using a 6-pin, RJ-11 modem cable (purchased separately). In some countries or regions, a specific modem cable adapter is also required. Jacks for digital PBX systems may resemble analog telephone jacks, but they are not compatible with the modem.

⚠ **WARNING!** To reduce the risk of electric shock, fire, or damage to the equipment, do not plug a modem or telephone cable into the RJ-45 (network) jack.

If the modem cable contains noise suppression circuitry **(1)**, which prevents interference from TV and radio reception, orient the circuitry end of the cable **(2)** toward the computer.



Connecting a modem cable

1. Plug the modem cable into the modem jack **(1)** on the computer.
2. Plug the modem cable into the RJ-11 telephone wall jack **(2)**.

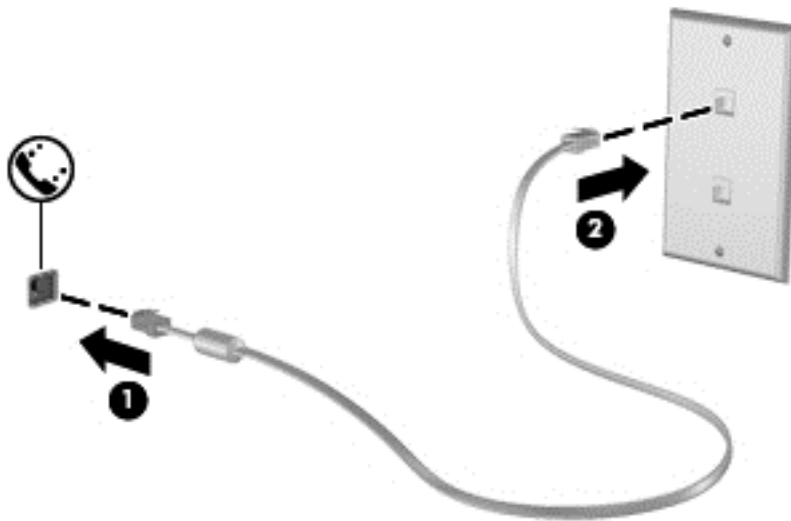

Connecting a country- or region-specific modem cable adapter

Telephone jacks vary by country or region. To use the modem and the modem cable outside the country or region in which you purchased the computer, you must obtain a country- or region-specific modem cable adapter.

To connect the modem to an analog telephone line that does not have an RJ-11 telephone jack, follow these steps:

1. Plug the modem cable into the modem jack **(1)** on the computer.
2. Plug the modem cable into the modem cable adapter **(2)**.

3. Plug the modem cable adapter (3) into the telephone wall jack.

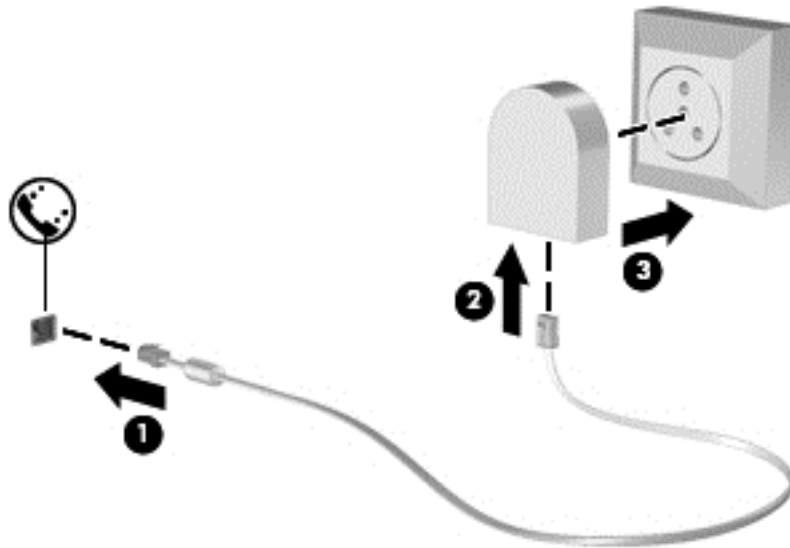

Selecting a location setting

Viewing the current location selection

Windows 7

1. Select **Start > Control Panel**.
2. Click **Clock, Language, and Region**.
3. Click **Region and Language**.
4. Click the **Location** tab to display your location.

Windows XP

1. Select **Start > Control Panel**.
2. Click **Date, Time, Language, and Regional Options**.
3. Click **Regional and Language Options**.

Your location is displayed under Location.

Adding new locations when traveling

On a new computer, the only location setting available to the modem is a location setting for the country or region in which you purchased the computer. As you travel to different countries or regions, set the internal modem to a location setting that meets the operating standards of the country or region in which you are using the modem.

As you add new location settings, they are saved by the computer so that you can switch among settings at any time. You can add multiple location settings for any country or region.

△ **CAUTION:** To reduce the risk of losing your home country or region settings, do not delete your current modem country or region settings. To enable modem use in other countries or regions while preserving your home country or region configuration, add a new configuration for each location in which you will use the modem.

CAUTION: To reduce the risk of configuring the modem in a way that violates the telecommunications regulations and laws of the country or region you are visiting, select the country or region in which the computer is located. The modem may not function properly if the correct country or region selection is not made.

Windows 7

1. Select **Start > Devices and Printers**.
2. Right-click the device that represents your computer, and click **Modem settings**.

 **NOTE:** You must set up an initial (current) location area code before you can view the Dialing Rules tab. If you do not have a location already set up, you are prompted to enter the location when you click Modem settings.

3. Click the **Dialing Rules** tab.
4. Click **New**. The New Location window opens.
5. In the **Location name** box, type a name (such as **home** or **work**) for the new location setting.
6. Select a country or region from the **Country/region** list. (If you select a country or region that is not supported by the modem, the country/region selection for USA or UK is displayed.)
7. Enter the area code, a carrier code (if necessary), and the number for an outside line (if necessary).
8. Next to **Dial using**, click **Tone** or **Pulse**.
9. Click **OK** to save your new location setting. The Phone and Modem Options window opens.
10. Do one of the following:
 - To set your new location setting as the current location, click **OK**.
 - To select another location setting as the current location setting, select your preference from the settings in the **Location** list, and then click **OK**.

 **NOTE:** You can use the preceding procedure to add location settings for places within your own country or region as well as in other countries or regions. For example, you could add a setting named “Work” that includes dialing rules for accessing an outside line.

Windows XP

1. Select **Start > Control Panel**.
2. Click **Printers and Other Hardware**.
3. Click **Phone and Modem Options**.
4. Click the **Dialing Rules** tab.
5. Click **New**. The New Location window opens.
6. In the **Location name** box, type a name (such as **home** or **work**) for the new location setting.

7. Select a country or region from the **Country/region** list. (If you select a country or region that is not supported by the modem, the country/region selection for USA or UK is displayed.)
8. Enter the area code, a carrier code (if necessary), and the number for an outside line (if necessary).
9. Next to **Dial using**, click **Tone** or **Pulse**.
10. Click **OK** to save your new location setting. The Phone and Modem Options window opens.
11. Do one of the following:
 - To set your new location setting as the current location, click **OK**.
 - To select another location setting as the current location setting, select your preference from the settings in the **Location** list, and then click **OK**.

 **NOTE:** You can use the preceding procedure to add location settings for places within your own country or region as well as in other countries or regions. For example, you could add a setting named “Work” that includes dialing rules for accessing an outside line.

Connecting to a local area network (LAN) (select models only)

Connecting to a local area network (LAN) requires an 8-pin, RJ-45 network cable (purchased separately). If the network cable contains noise suppression circuitry **(1)**, which prevents interference from TV and radio reception, orient the circuitry end of the cable **(2)** toward the computer.



To connect the network cable:

1. Plug the network cable into the network jack **(1)** on the computer.

2. Plug the other end of the network cable into a network wall jack (2).

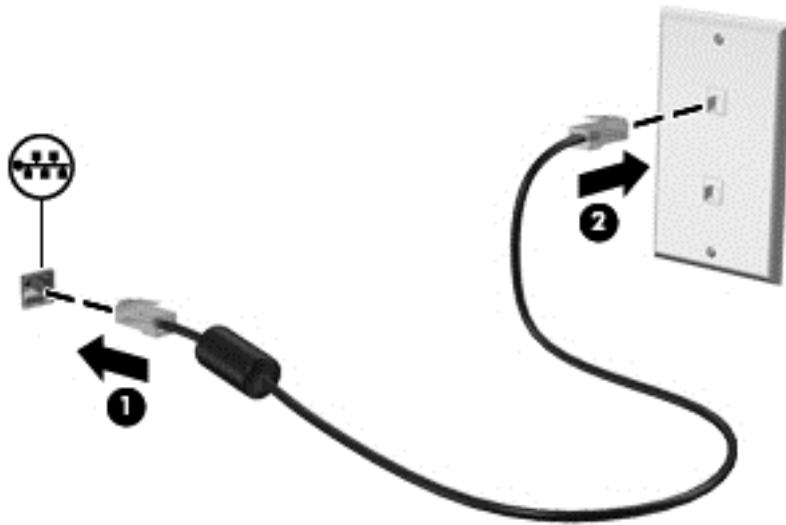

⚠ **WARNING!** To reduce the risk of electric shock, fire, or damage to the equipment, do not plug a modem cable or telephone cable into an RJ-45 (network) jack.

3 Multimedia

Your computer may include the following:

- One or two integrated speakers
- One or two integrated microphones
- Integrated webcam
- Preinstalled multimedia software
- Multimedia buttons or keys

Using the media activity controls

Depending on your computer model, you may have the following media activity controls that allow you to play, pause, fast forward, or rewind a media file:

- Media buttons
- Media hotkeys (specific keys pressed in combination with the [fn](#) key)
- Media action keys

Refer to the *Getting Started* guide for information about your computer's media activity controls.

Audio

Your computer provides a variety of audio-related opportunities:

- Play music.
- Record sound.
- Download music from the Internet.
- Create multimedia presentations.
- Transmit sound and images with instant messaging programs.
- Stream radio programs.
- Create (burn) audio CDs using the installed optical drive (select models only) or on an optional external optical drive (purchased separately).

Adjusting the volume

Depending on your computer model, you can adjust the volume using the following:

- Volume buttons
- Volume hotkeys
- Volume keys

 **WARNING!** To reduce the risk of personal injury, adjust the volume before putting on headphones, earbuds, or a headset. For additional safety information, refer to the *Regulatory, Safety, and Environmental Notices*.

 **NOTE:** Volume can also be controlled through the operating system and some programs.

NOTE: Refer to the *Getting Started* guide for information on what type of volume controls your computer has.

Checking audio functions on the computer

Windows 7

To check the audio functions on your computer, follow these steps:

1. Select **Start > Control Panel > Hardware and Sound > Sound**.
2. When the Sound window opens, click the **Sounds** tab. Under **Program Events**, select any sound event, such as a beep or alarm, and click the **Test** button.

You should hear sound through the speakers or through connected headphones.

To check the recording functions on your computer, follow these steps:

1. Select **Start > All Programs > Accessories > Sound Recorder**.
2. Click **Start Recording** and speak into the microphone. Save the file to your desktop.
3. Open a multimedia program and play back the sound.

 **NOTE:** For best results when recording, speak directly into the microphone and record sound in a setting free of background noise.

To confirm or change the audio settings on your computer, select **Start > Control Panel > Hardware and Sound > Sound**.

Windows XP

To check the audio functions on your computer, follow these steps:

1. Select **Start > Control Panel > Sounds, Speech, and Audio Devices > Sounds and Audio Devices**.
2. When the Sound and Audio Device Properties window opens, click the **Sounds** tab. Under **Program events**, select any sound event, such as a beep or alarm, and click the arrow button to check the sound.

You should hear sound through the speakers or through connected headphones.

To check the recording functions on your computer, follow these steps:

1. Select **Start > All Programs > Accessories > Entertainment > Sound Recorder**.
2. Click the recording button and speak into the microphone. Save the file to your desktop.
3. Open a multimedia program and play back the sound.

 **NOTE:** For best results when recording, speak directly into the microphone and record sound in a setting free of background noise.

To confirm or change the audio settings on your computer, right-click the **Volume** icon on the taskbar, or select **Start > Control Panel > Sounds, Speech, and Audio Devices > Sounds and Audio Devices**.

Webcam (select models only)

Some computers include an integrated webcam, located at the top of the display. With the preinstalled software, you can use the webcam to take a photo or record a video. You can preview and save the photo or video recording.

The webcam software enables you to experiment with the following features:

- Capturing and sharing video
- Streaming video with instant message software
- Taking still photos

For information on how to access the webcam, refer to the *Getting Started* guide. For information on using the webcam, select **Start > Help and Support**.

Using SkyRoom (select models only)

HP SkyRoom is a video tool that allows video conferencing and desktop sharing so that participants across the world can collaborate in real time.

You can utilize your existing Microsoft Office Communicator or Jabber contact lists or you can create your own list and add contacts manually. For more information, refer to the SkyRoom software Help.

Video

Your computer may have one or more of the following external video ports:

- VGA
- DisplayPort
- HDMI

VGA

The external monitor port, or VGA port, is an analog display interface that connects an external VGA display device such as an external VGA monitor or a VGA projector to the computer.

- ▲ To connect a VGA display device, connect the device cable to the external monitor port.

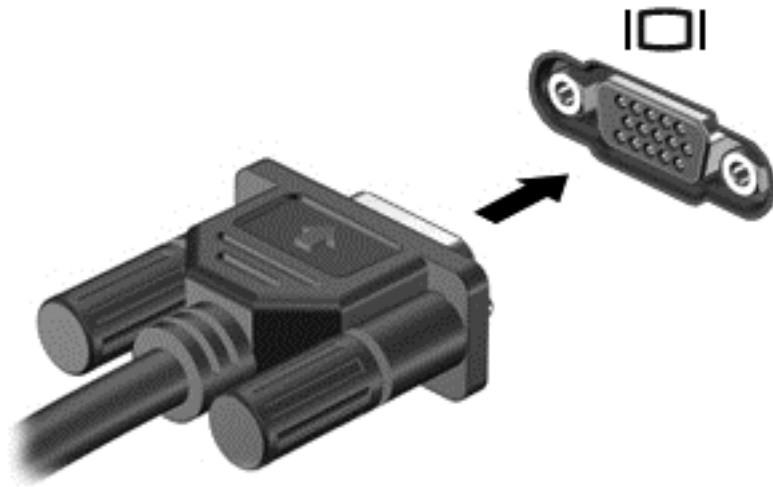

 **NOTE:** For product-specific instructions on switching the screen image, refer to your *Getting Started* guide.

DisplayPort

The DisplayPort connects a digital display device such as a high-performance monitor or projector. The DisplayPort delivers higher performance than the VGA external monitor port and improves digital connectivity.

- ▲ To connect a digital display device, connect the device cable to the DisplayPort.



 **NOTE:** For product-specific instructions on switching the screen image, refer to your *Getting Started* guide.

HDMI

The HDMI (High Definition Multimedia Interface) port connects the computer to an optional video or audio device, such as a high-definition television, or to any compatible digital or audio component.

-  **NOTE:** To transmit video signals through the HDMI port, you need an HDMI cable (purchased separately).
-

One HDMI device can be connected to the HDMI port on the computer. The information displayed on the computer screen can be simultaneously displayed on the HDMI device.

To connect a video or audio device to the HDMI port:

1. Connect one end of the HDMI cable to the HDMI port on the computer.

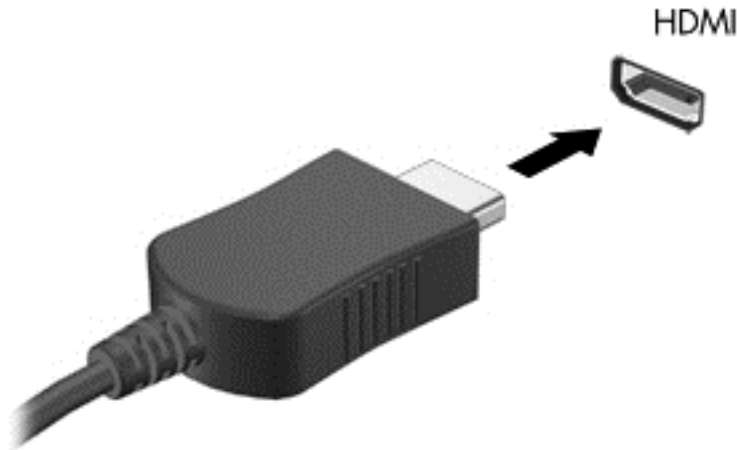

2. Connect the other end of the cable to the video device, and then refer to the device manufacturer's instructions for additional information.

 **NOTE:** For product-specific instructions on switching the screen image, refer to your *Getting Started* guide.

Configuring audio for HDMI

To configure HDMI audio, first connect an audio or video device, such as a high-definition TV, to the HDMI port on your computer. Then configure the default audio playback device as follows:

1. Right-click the **Speakers** icon in the notification area, at the far right of the taskbar, and then click **Playback devices**.
2. On the **Playback** tab, click either **Digital Output** or **Digital Output Device (HDMI)**.
3. Click **Set Default**, and then click **OK**.

To return audio to the computer speakers, follow these steps:

1. Right-click the **Speakers** icon in the notification area, at the far right of the taskbar, and then click **Playback devices**.
2. On the **Playback** tab, click **Speakers**.
3. Click **Set Default**, and then click **OK**.

Intel Wireless Display (select models only)

Intel® Wireless Display allows you to share your computer content wirelessly on your TV. To experience wireless display, a wireless TV adapter (purchased separately) is required. Content that asserts output protection, such as DVD and Blu-ray discs, will not play on Intel Wireless Display. For details about using the wireless adapter, refer to the device manufacturer's instructions.

 **NOTE:** Be sure that wireless is enabled on your computer before using the wireless display.

Using HP MediaSmart (select models only)

HP MediaSmart turns your computer into a mobile entertainment center. With MediaSmart, you can enjoy music CDs and DVD and Blu-ray Disc (BD) movies. You can also manage and edit your photo collections. MediaSmart includes the following features:

- Playlist upload support:
 - Upload your MediaSmart photo playlists to Internet photo albums.
 - Upload your MediaSmart video playlists to YouTube.
 - Export your MediaSmart playlist to the CyberLink DVD Suite.
- Pandora Internet radio (North America only)—Listen to music selected just for you, streamed from the Internet.
- ▲ To start MediaSmart, select **Start > All Programs > HP > HP MediaSmart**.

For more information on using MediaSmart, select **Start > Help and Support**.

4 Power management

 **NOTE:** A computer may have a power button or a power switch. The term *power button* is used throughout this guide to refer to both types of power controls.

NOTE: Windows 7 uses *Sleep* and Windows XP uses *Standby*. The term *Sleep* is used throughout this guide to refer to both. Differences between the operating systems that affect any of the procedures are noted.

Shutting down the computer

 **CAUTION:** Unsaved information is lost when the computer shuts down.

The Shut down command closes all open programs, including the operating system, and then turns off the display and computer.

Shut down the computer under any of the following conditions:

- When you need to replace the battery or access components inside the computer
- When you are connecting an external hardware device that does not connect to a USB port
- When the computer will be unused and disconnected from external power for an extended period

Although you can shut down the computer with the power button, the recommended procedure is to use the Windows Shut down command:

 **NOTE:** If the computer is in the Sleep state or in Hibernation, you must first exit Sleep or Hibernation before shutdown is possible.

1. Save your work and close all open programs.
2. **Windows 7**—Select **Start > Shut down**.

Windows XP—Select **Start > Turn Off Computer > Turn Off**.

 **NOTE:** If you have been registered to a network domain, the button you click is called Shut Down instead of Turn Off Computer.

If the computer is unresponsive and you are unable to use the preceding shutdown procedures, try the following emergency procedures in the sequence provided:

- **Windows 7**—Press **ctrl+alt+delete**, and then click the **Power** button.
Windows XP—Press **ctrl+alt+delete**. Click **Shut Down**, and then click **Turn Off**.
- Press and hold the power button for at least 5 seconds.
- Disconnect the computer from external power and remove the battery.

Setting power options

Using power-saving states

The computer has two power-saving states that are enabled at the factory: Sleep and Hibernation.

When Sleep is initiated, the power lights blink and the screen clears. Your work is saved to memory, letting you exit Sleep faster than exiting Hibernation. If the computer is in the Sleep state for an extended period or if the battery reaches a critical battery level while in the Sleep state, the computer initiates Hibernation.

When Hibernation is initiated, your work is saved to a hibernation file on the hard drive and the computer turns off.

△ **CAUTION:** To reduce the risk of possible audio and video degradation, loss of audio or video playback functionality, or loss of information, do not initiate Sleep or Hibernation while reading from or writing to a disc or an external media card.

📝 **NOTE:** You cannot initiate any type of networking connection or perform any computer functions while the computer is in the Sleep state or in Hibernation.

Initiating and exiting Sleep

The system is set at the factory to initiate Sleep after a period of inactivity when running on battery power or on external power.

Power settings and timeouts can be changed using Power Options in Windows® Control Panel.

With the computer on, you can initiate Sleep in any of the following ways:

- Briefly press the power button.
- Close the display.
- **Windows 7**—Select **Start**, click the arrow next to the Shut down button, and then click **Sleep**.
Windows XP—Select **Start > Turn Off Computer > Stand By**.

To exit Sleep:

- Briefly press the power button.
- If the display is closed, open the display.
- Press a key on the keyboard.
- Tap or swipe the TouchPad.

When the computer exits Sleep, the power lights turn on and your work returns to the screen where you stopped working.

 **NOTE:** If you have set a password to be required on wakeup, you must enter your Windows password before your work will return to the screen.

Initiating and exiting Hibernation

The system is set at the factory to initiate Hibernation after a period of inactivity when running on battery power or on external power, or when the battery reaches a critical battery level.

Power settings and timeouts can be changed in Windows Control Panel.

To initiate Hibernation:

- ▲ **Windows 7**—Select **Start**, click the arrow next to the Shut down button, and then click **Hibernate**.

Windows XP—Select **Start > Turn Off Computer**, and then hold down the **shift** key and select **Hibernate**.

To exit Hibernation:

- ▲ Briefly press the power button.

The power lights turn on and your work returns to the screen where you stopped working.

 **NOTE:** If you have set a password to be required on wakeup, you must enter your Windows password before your work will return to the screen.

Using the power meter

The power meter is located in the notification area, at the far right of the taskbar. The power meter allows you to quickly access power settings and view the remaining battery charge.

- To display the percentage of remaining battery charge and the current power plan (or power scheme in Windows XP), move the pointer over the power meter icon.
- To access Power Options, or to change the power plan, click the power meter icon and select an item from the list.

Different power meter icons indicate whether the computer is running on battery or external power. The icon also displays a message if the battery has reached a low or critical battery level.

Using power plans

A power plan (or power scheme in Windows XP) is a collection of system settings that manages how the computer uses power. Power plans can help you conserve power or maximize performance.

Viewing the current power plan

Use any of the following methods:

- Click the power meter icon in the notification area, at the far right of the taskbar.
- **Windows 7**—Select **Start > Control Panel > System and Security > Power Options**.

Windows XP—Select **Start > Control Panel > Performance and Maintenance > Power Options**.

Selecting a different power plan

Use any of the following methods:

- Click the power meter icon in the notification area, and then select a power plan from the list.
- **Windows 7**—Select **Start > Control Panel > System and Security > Power Options**, and then select an item from the list.

Windows XP—Select **Start > Control Panel > Performance and Maintenance > Power Options**, and then select an item from the list.

Customizing power plans

Windows 7

1. Click the power meter icon in the notification area, and then click **More power options**.

– or –

Select **Start > Control Panel > System and Security > Power Options**.

2. Select a power plan, and then click **Change plan settings**.
3. Change the settings as needed.
4. To change additional settings, click **Change advanced power settings** and make your changes.

Windows XP

1. Select **Start > Control Panel > Performance and Maintenance > Power Options**.
2. Select a power scheme from the **Power schemes** list.
3. Modify the **Plugged in** and **Running on batteries settings** as needed.
4. Click **OK**.

Setting password protection on wakeup

Windows 7

To set the computer to prompt for a password when the computer exits Sleep or Hibernation, follow these steps:

1. Select **Start > Control Panel > System and Security > Power Options**.
2. In the left pane, click **Require a password on wakeup**.
3. Click **Change Settings that are currently unavailable**.
4. Click **Require a password (recommended)**.

 **NOTE:** If you need to create a user account password or change your current user account password, click **Create or change your user account password**, and then follow the on-screen instructions. If you do not need to create or change a user account password, go to step 5.

5. Click **Save changes**.

Windows XP

1. Right-click the **Power Meter** icon in the notification area, and then click **Adjust Power Properties**.
2. Click the **Advanced** tab.
3. Select the **Prompt for password when computer resumes from Standby** check box.
4. Click **Apply**.

Using battery power

When a charged battery is in the computer and the computer is not plugged into external power, the computer runs on battery power. When the computer is plugged into external AC power, the computer runs on AC power.

If the computer contains a charged battery and is running on external AC power, the computer switches to battery power if the AC adapter is disconnected from the computer.

 **NOTE:** When you disconnect AC power, the display brightness is automatically decreased to save battery life. For information on increasing or decreasing display brightness, refer to the *Getting Started* guide.

You can keep a battery in the computer or in storage, depending on how you work. Keeping the battery in the computer whenever the computer is plugged into AC power charges the battery and also protects your work in case of a power outage. However, a battery in the computer slowly discharges when the computer is off and unplugged from external power.

 **WARNING!** To reduce potential safety issues, use only the battery provided with the computer, a replacement battery provided by HP, or a compatible battery purchased from HP.

Computer battery life varies, depending on power management settings, programs running on the computer, display brightness, external devices connected to the computer, and other factors.

Finding battery information in Help and Support in Windows 7

Help and Support provides the following tools and information about the battery:

- Battery Check tool to test battery performance
- Information on calibration, power management, and proper care and storage to maximize battery life
- Information on battery types, specifications, life cycles, and capacity

To access battery information:

- ▲ Select **Start > Help and Support > Learn > Power Plans: Frequently Asked Questions**.

Using Battery Check in Windows 7

Battery Check in Help and Support provides information on the status of the battery installed in the computer.

To run Battery Check:

1. Connect the AC adapter to the computer.

 **NOTE:** The computer must be connected to external power for Battery Check to work properly.

2. Select **Start > Help and Support > Troubleshoot > Power, Thermal and Mechanical**.
3. Click the **Power** tab, and then click **Battery Check**.

Battery Check examines the battery and its cells to see if they are functioning properly, and then reports the results of the examination.

Displaying the remaining battery charge

- ▲ Move the pointer over the power meter icon in the notification area, at the far right of the taskbar.

Maximizing battery discharge time

Battery discharge time varies depending on the features you use while on battery power. Maximum discharge time gradually decreases as the battery storage capacity naturally degrades.

Tips for maximizing battery discharge time:

- Lower the brightness on the display.
- Remove the battery from the computer when it is not being used or charged.
- Store the battery in a cool, dry location.
- **Windows 7**—Select the **Power saver** setting in Power Options.

Managing low battery levels

The information in this section describes the alerts and system responses set at the factory. Some low-battery alerts and system responses can be changed using Power Options in Windows Control Panel. Preferences set using Power Options do not affect lights.

Identifying low battery levels

When a battery that is the sole power source for the computer reaches a low or critical battery level, the following behavior occurs:

- The battery light (select models only) indicates a low or critical battery level.

 **NOTE:** For additional information about the battery light, refer to the *Getting Started* guide.

– or –

- The power meter icon in the notification area shows a low or critical battery notification.

 **NOTE:** For additional information about the power meter, refer to [Using the power meter on page 23](#).

The computer takes the following actions for a critical battery level:

- If Hibernation is enabled and the computer is on or in the Sleep state, the computer initiates Hibernation.
- If Hibernation is disabled and the computer is on or in the Sleep state, the computer remains briefly in the Sleep state, and then shuts down and loses any unsaved information.

Resolving a low battery level

Resolving a low battery level when external power is available

- ▲ Connect one of the following devices:
 - AC adapter
 - Optional docking or expansion device
 - Optional power adapter purchased as an accessory from HP

Resolving a low battery level when a charged battery is available

1. Turn off the computer or initiate Hibernation.
2. Replace the discharged battery with a charged battery.
3. Turn on the computer.

Resolving a low battery level when no power source is available

- Initiate Hibernation.
- Save your work and shut down the computer.

Resolving a low battery level when the computer cannot exit Hibernation

When the computer lacks sufficient power to exit Hibernation, follow these steps:

1. Replace the discharged battery with a charged battery, or connect the AC adapter to the computer and to external power.
2. Exit Hibernation by pressing the power button.

Conserving battery power

- Select low power-use settings through Power Options in Windows Control Panel.
- Turn off wireless and local area network (LAN) connections and exit modem applications when you are not using them.
- Disconnect unused external devices that are not plugged into an external power source.
- Stop, disable, or remove any external media cards that you are not using.
- Decrease screen brightness.
- Before you leave your work, initiate Sleep or Hibernation, or shut down the computer.

Storing a battery

△ **CAUTION:** To reduce the risk of damage to a battery, do not expose it to high temperatures for extended periods of time.

If a computer will be unused and unplugged from external power for more than 2 weeks, remove the battery and store it separately.

To prolong the charge of a stored battery, place it in a cool, dry place.

📝 **NOTE:** A stored battery should be checked every 6 months. If the capacity is less than 50 percent, recharge the battery before returning it to storage.

Calibrate a battery before using it if it has been stored for one month or more.

Disposing of a used battery

△ **WARNING!** To reduce the risk of fire or burns, do not disassemble, crush, or puncture; do not short external contacts; do not dispose of in fire or water.

Refer to the *Regulatory, Safety, and Environmental Notices* for proper battery disposal.

Replacing the battery

In Windows 7, Battery Check in Help and Support notifies you to replace the battery when an internal cell is not charging properly or when the battery storage capacity has reached a weak condition. If the battery is possibly covered by an HP warranty, instructions include a warranty ID. A message refers you to the HP Web site for more information about ordering a replacement battery.

Using external AC power

 **NOTE:** For information on connecting to AC power, refer to the *Quick Setup* poster provided in the computer box.

External AC power is supplied through an approved AC adapter or an optional docking or expansion device.

 **WARNING!** To reduce potential safety issues, use only the AC adapter provided with the computer, a replacement AC adapter provided by HP, or a compatible AC adapter purchased from HP.

Connect the computer to external AC power under any of the following conditions:

 **WARNING!** Do not charge the computer battery while you are onboard aircraft.

- When charging or calibrating a battery
- When installing or modifying system software
- When writing information to a CD, a DVD, or a BD (select models only)
- When running Disk Defragmenter
- When performing a backup or recovery

When you connect the computer to external AC power, the following events occur:

- The battery begins to charge.
- If the computer is turned on, the power meter icon in the notification area changes appearance.

When you disconnect external AC power, the following events occur:

- The computer switches to battery power.
- The display brightness is automatically decreased to save battery life.

Testing an AC adapter

Test the AC adapter if the computer exhibits any of the following symptoms when it is connected to AC power:

- The computer does not turn on.
- The display does not turn on.
- The power lights are off.

To test the AC adapter:

1. Shut down the computer.
2. Remove the battery from the computer.
3. Connect the AC adapter to the computer, and then plug it into an AC outlet.
4. Turn on the computer.
 - If the power lights turn **on**, the AC adapter is working properly.
 - If the power lights remain **off**, the AC adapter is not functioning and should be replaced.

Contact technical support for information on obtaining a replacement AC power adapter.

5 External cards and devices

Using Digital Media Slot cards (select models only)

Optional digital cards provide secure data storage and convenient data sharing. These cards are often used with digital media–equipped cameras and PDAs as well as with other computers.

To determine the digital card formats that are supported on your computer, refer to the *Getting Started* guide.

Inserting a digital card

△ **CAUTION:** To reduce the risk of damage to the digital card connectors, use minimal force to insert a digital card.

1. Hold the card label-side up, with the connectors facing the computer.
2. Insert the card into the Digital Media Slot, and then press in on the card until it is firmly seated.

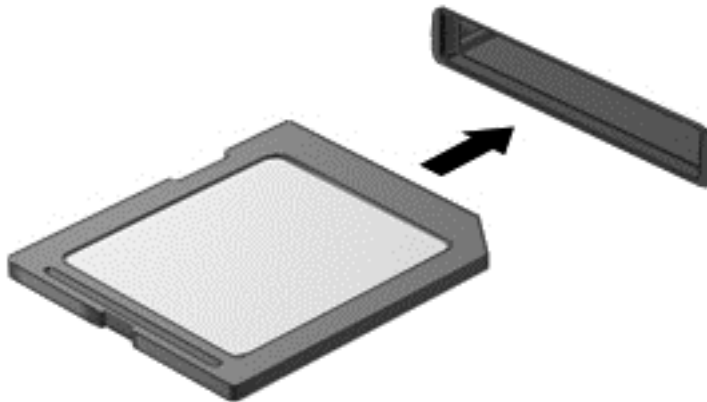

You will hear a sound when the device has been detected, and a menu of options may be displayed.

Removing a digital card

△ **CAUTION:** To reduce the risk of loss of data or an unresponsive system, use the following procedure to safely remove the digital card.

1. Save your information and close all programs associated with the digital card.
2. Click the remove hardware icon in the notification area, at the far right of the taskbar. Then follow the on-screen instructions.
3. Either press in on the card (1), and then remove it from the slot (2).

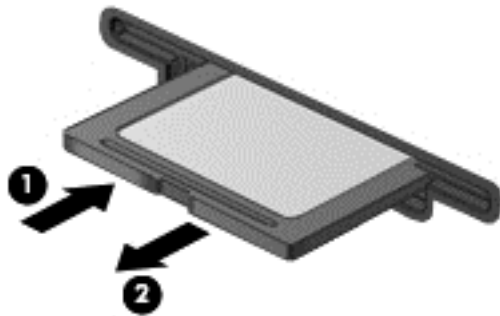

– or –

Pull the card out of the slot.

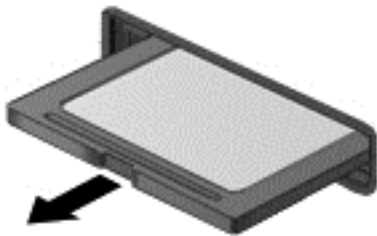

Using PC Cards (select models only)

A PC Card is a credit card–sized accessory designed to conform to the standard specifications of the Personal Computer Memory Card International Association (PCMCIA). The PC Card slot supports the following types of PC Cards:

- 32-bit (CardBus) and 16-bit PC Cards
- Type I and Type II PC Cards

📄 **NOTE:** Zoomed video PC Cards and 12-V PC Cards are not supported.

Configuring a PC Card

To reduce the risk of loss of support for other PC Cards during configuration, install only the software required for the device. If you are instructed by the PC Card manufacturer to install device drivers:

- Install only the device drivers for your operating system.
- Do not install other software, such as card services, socket services, or enablers, supplied by the PC Card manufacturer.

Inserting a PC Card

△ **CAUTION:** To prevent damage to the computer and external media cards, do not insert an ExpressCard into a PC Card slot.

CAUTION: To reduce the risk of damage to the connectors:

Use minimal force when inserting a PC Card.

Do not move or transport the computer when a PC Card is in use.

The PC Card slot may contain a protective insert. The insert must be removed before you can insert a PC Card:

1. Press the PC Card eject button **(1)**.
This action extends the button into position for releasing the insert.
2. Press the PC Card eject button again to release the insert.
3. Pull the insert out of the slot **(2)**.

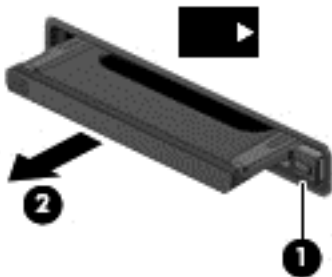

To insert a PC Card:

1. Hold the card label-side up, with the connectors facing the computer.

2. Insert the card into the PC Card slot, and then press in on the card until it is firmly seated.

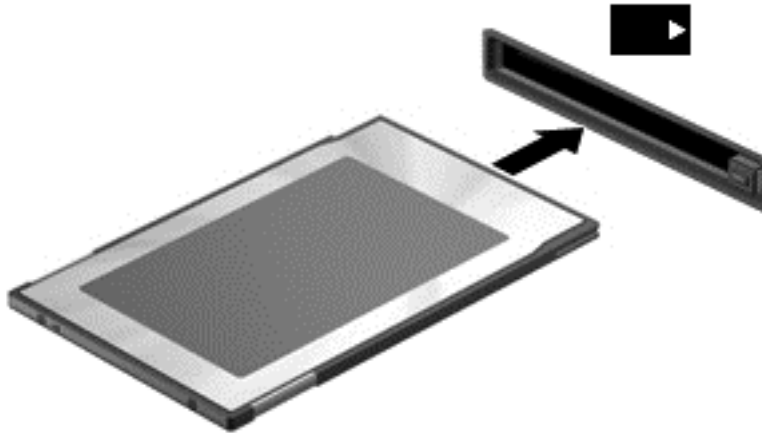

You will hear a sound when the card has been detected, and a menu of available options may be displayed.

 **NOTE:** The first time you connect a PC Card, a message in the notification area lets you know that the device is recognized by the computer.

 **NOTE:** To conserve power, stop or remove a PC Card when it is not in use.

Removing a PC Card

 **CAUTION:** To reduce the risk of loss of data or an unresponsive system, stop a PC Card before removing it.

1. Save your information and close all programs associated with the PC Card.
2. Click the remove hardware icon in the notification area, at the far right of the taskbar, and then follow the on-screen instructions.
3. Release and remove the PC Card:
 - a. Press the PC Card eject button **(1)**.
This action extends the button into position for releasing the PC Card.
 - b. Press the PC Card eject button again to release the PC Card.
 - c. Pull the PC Card **(2)** out of the slot.

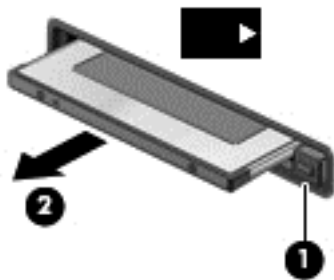

Using ExpressCards (select models only)

An ExpressCard is a high-performance PC Card that is inserted into the ExpressCard slot.

Like standard PC Cards, ExpressCards are designed to conform to the standard specifications of the Personal Computer Memory Card International Association (PCMCIA).

Configuring an ExpressCard

Install only the software required for the card. If you are instructed by the ExpressCard manufacturer to install device drivers:

- Install only the device drivers for your operating system.
- Do not install additional software, such as card services, socket services, or enablers, that are supplied by the ExpressCard manufacturer.

Inserting an ExpressCard

△ **CAUTION:** To prevent damage to the computer and external media cards, do not insert a PC Card into an ExpressCard slot.

CAUTION: To reduce the risk of damage to the connectors:

Use minimal force when inserting an ExpressCard.

Do not move or transport the computer when an ExpressCard is in use.

The ExpressCard slot may contain a protective insert. To remove the insert:

1. Press in on the insert (1) to unlock it.
2. Pull the insert out of the slot (2).

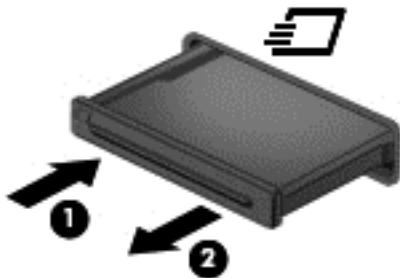

To insert an ExpressCard:

1. Hold the card label-side up, with the connectors facing the computer.
2. Insert the card into the ExpressCard slot, and then press in on the card until it is firmly seated.

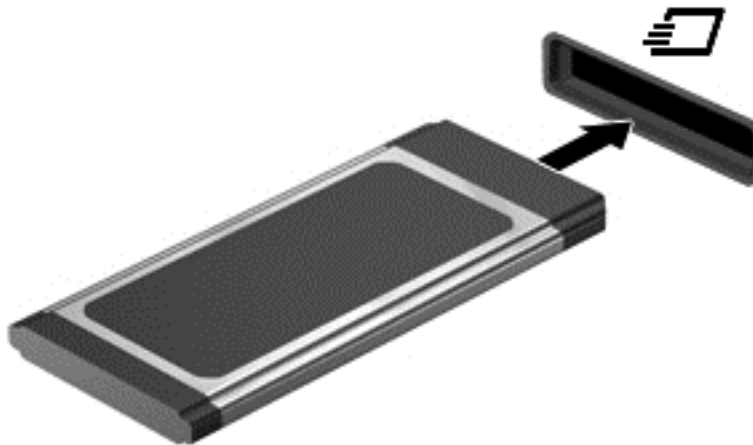

You will hear a sound when the card has been detected, and a menu of options may be displayed.

📄 **NOTE:** The first time you connect an ExpressCard, a message in the notification area lets you know that the card is recognized by the computer.

📄 **NOTE:** To conserve power, stop or remove an ExpressCard when it is not in use.

Removing an ExpressCard

△ **CAUTION:** To reduce the risk of loss of data or an unresponsive system, use the following procedure to safely remove the ExpressCard.

1. Save your information and close all programs associated with the ExpressCard.
2. Click the remove hardware icon in the notification area, at the far right of the taskbar, and then follow the on-screen instructions.
3. Release and remove the ExpressCard:
 - a. Gently press in on the ExpressCard **(1)** to unlock it.
 - b. Pull the ExpressCard out of the slot **(2)**.

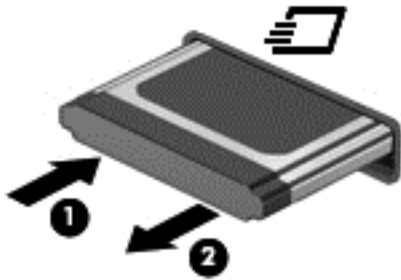

Using smart cards (select models only)

📄 **NOTE:** The term *smart card* is used throughout this chapter to refer to both smart cards and Java™ Cards.

A smart card is a credit card–sized accessory that carries a microchip containing memory and a microprocessor. Like personal computers, smart cards have an operating system to manage input and output, and they include security features to protect against tampering. Industry-standard smart cards are used with the smart card reader (select models only).

A personal identification number (PIN) is needed to gain access to the contents of the microchip. For more information about smart card security features, refer to Help and Support.

Inserting a smart card

1. Hold the card label-side up, and gently slide the card into the smart card reader until the card is seated.

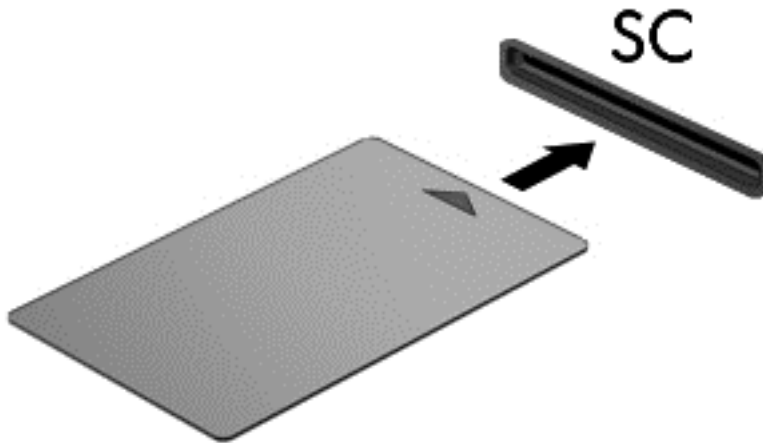

2. Follow the on-screen instructions for logging on to the computer using the smart card PIN.

Removing a smart card

- ▲ Grasp the edge of the smart card, and then pull it out of the smart card reader.

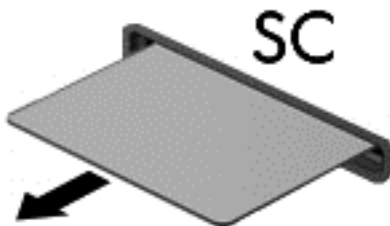

Using a USB device

Universal Serial Bus (USB) is a hardware interface that can be used to connect an optional external device, such as a USB keyboard, mouse, drive, printer, scanner, or hub.

Some USB devices may require additional support software, which is usually included with the device. For more information about device-specific software, refer to the manufacturer's instructions. These instructions may be provided with the software, on disc, or on the manufacturer's Web site.

The computer has at least 1 USB port that supports USB 1.0, 1.1, 2.0, or 3.0 devices. Your computer may also have a powered USB port that provides power to an external device if it is used with a powered USB cable. An optional docking device or USB hub provides additional USB ports that can be used with the computer.

Connecting a USB device

-
- △ **CAUTION:** To reduce the risk of damage to a USB connector, use minimal force to connect the device.
-

- ▲ Connect the USB cable for the device to the USB port.



You will hear a sound when the device has been detected.

 **NOTE:** The first time you connect a USB device, a message in the notification area lets you know that the device is recognized by the computer.

Removing a USB device

△ **CAUTION:** To reduce the risk of damage to a USB connector, do not pull on the cable to remove the USB device.

CAUTION: To reduce the risk of loss of information or an unresponsive system, use the following procedure to safely remove the USB device.

1. To remove a USB device, save your information and close all programs associated with the device.
2. Click the remove hardware icon in the notification area, at the far right of the taskbar, and then follow the on-screen instructions.
3. Remove the device.

Using 1394 devices (select models only)

IEEE 1394 is a hardware interface that connects a high-speed multimedia or data storage device to the computer. Scanners, digital cameras, and digital camcorders often require a 1394 connection.

Some 1394 devices may require additional support software, which is usually included with the device. For more information about device-specific software, refer to the manufacturer's instructions.

The 1394 port also supports IEEE 1394a devices.

Connecting a 1394 device

△ **CAUTION:** To reduce the risk of damage to a 1394 port connector, use minimal force to connect the device.

- ▲ To connect a 1394 device to the computer, connect the 1394 cable for the device to the 1394 port.

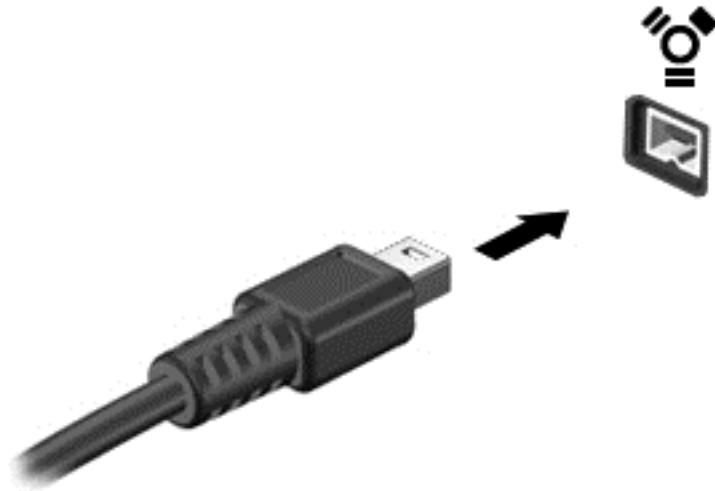

You will hear a sound when the device has been detected.

Removing a 1394 device

△ **CAUTION:** To reduce the risk of loss of information or an unresponsive system, stop the 1394 device before removing it.

CAUTION: To reduce the risk of damage to a 1394 connector, do not pull on the cable to remove the 1394 device.

1. To remove a 1394 device, save your information and close all programs associated with the device.
2. Click the remove hardware icon in the notification area, at the far right of the taskbar, and then follow the on-screen instructions.
3. Remove the device.

Using an eSATA device (select models only)

An eSATA port connects an optional high-performance eSATA component, such as an eSATA external hard drive.

Some eSATA devices may require additional support software, which is usually included with the device. For more information about device-specific software, refer to the manufacturer's instructions.

📄 **NOTE:** The eSATA port also supports an optional USB device.

Connecting an eSATA device

△ **CAUTION:** To reduce the risk of damage to an eSATA port connector, use minimal force to connect the device.

- ▲ To connect an eSATA device to the computer, connect the eSATA cable for the device to the eSATA port.

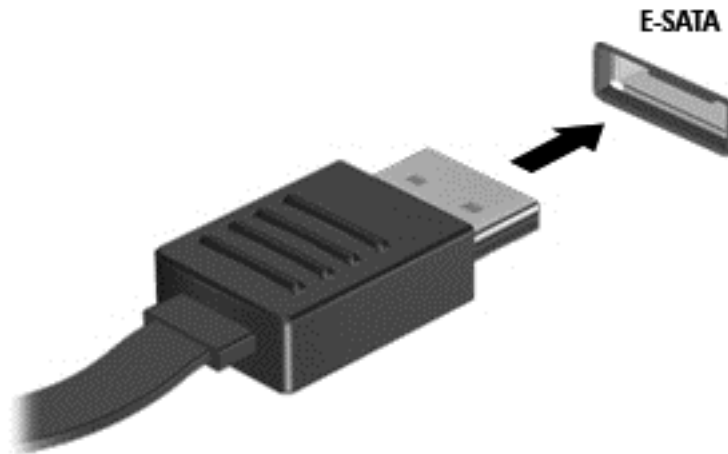

You will hear a sound when the device has been detected.

Removing an eSATA device

△ **CAUTION:** To reduce the risk of damage to an eSATA connector, do not pull on the cable to remove the eSATA device.

CAUTION: To reduce the risk of loss of information or an unresponsive system, use the following procedure to safely remove the device.

1. To remove an eSATA device, save your information and close all programs associated with the device.
2. Click the remove hardware icon in the notification area, at the far right of the taskbar, and then follow the on-screen instructions.
3. Remove the device.

Using optional external devices

 **NOTE:** For more information about required software and drivers, or to learn which computer port to use, refer to the manufacturer's instructions.

To connect an external device to the computer:

 **CAUTION:** To reduce the risk of damage to the equipment when connecting a powered device, be sure that the device is turned off and the AC power cord is unplugged.

1. Connect the device to the computer.
2. If you are connecting a powered device, plug the device power cord into a grounded AC outlet.
3. Turn on the device.

To disconnect an unpowered external device, turn off the device, and then disconnect it from the computer. To disconnect a powered external device, turn off the device, disconnect it from the computer, and then unplug the AC power cord.

Using optional external drives

Removable external drives expand your options for storing and accessing information. A USB drive can be added by connecting the drive to a USB port on the computer.

 **NOTE:** HP external USB optical drives should be connected to the powered USB port on the computer.

USB drives include the following types:

- 1.44-megabyte diskette drive
- Hard drive module (a hard drive with an adapter attached)
- External optical drive (CD, DVD, and Blu-ray)
- MultiBay device

Using the expansion port (select models only)

The expansion port connects the computer to an optional docking or expansion device, so that additional ports and connectors can be used with the computer.

 **NOTE:** The computer has only one expansion port. The term *expansion port 3* describes the type of expansion port.



Using the docking connector (select models only)

The docking connector connects the computer to an optional docking device. An optional docking device provides additional ports and connectors that can be used with the computer.

 **NOTE:** The following image may look slightly different than your computer or docking device.

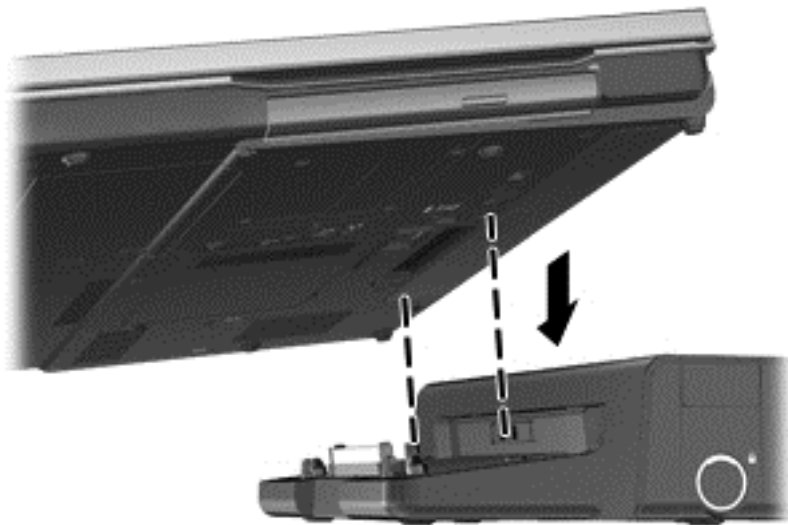

6 Drives

Handling drives

Drives are fragile computer components that must be handled with care. Refer to the following cautions before handling drives. Additional cautions are included with the procedures to which they apply.

Observe these precautions:

- Before you move a computer that is connected to an external hard drive, initiate Sleep and allow the screen to clear, or properly disconnect the external hard drive.
- Before handling a drive, discharge static electricity by touching the unpainted metal surface of the drive.
- Do not touch the connector pins on a removable drive or on the computer.
- Handle a drive carefully; do not drop a drive or place items on it.
- Before removing or inserting a drive, shut down the computer. If you are unsure whether the computer is off, in the Sleep state, or in Hibernation, turn the computer on, and then shut it down through the operating system.
- Do not use excessive force when inserting a drive into a drive bay.
- Do not type on the keyboard or move the computer while an optical drive is writing to a disc. The write process is sensitive to vibration.
- When the battery is the only source of power, be sure that the battery is sufficiently charged before writing to media.
- Avoid exposing a drive to temperature or humidity extremes.
- Avoid exposing a drive to liquids. Do not spray the drive with cleaning products.
- Remove media from a drive before removing the drive from the drive bay, or traveling with, shipping, or storing a drive.
- If a drive must be mailed, place the drive in a bubble-pack mailer or other suitable protective packaging and label the package “FRAGILE.”
- Avoid exposing a drive to magnetic fields. Security devices with magnetic fields include airport walk-through devices and security wands. Airport conveyer belts and similar security devices that check carry-on baggage use X-rays instead of magnetism and do not damage drives.

Using hard drives

Improving hard drive performance

Using Disk Defragmenter

As you use the computer, files on the hard drive become fragmented. Disk Defragmenter consolidates the fragmented files and folders on the hard drive so that the system can run more efficiently.

 **NOTE:** It is not necessary to run Disk Defragmenter on solid-state drives.

After you start Disk Defragmenter, it works without supervision. Depending on the size of your hard drive and the number of fragmented files, Disk Defragmenter may take more than an hour to complete. You may want to set it to run during the night or at another time when you do not need access to your computer.

HP recommends defragmenting your hard drive at least once a month. You may set Disk Defragmenter to run on a monthly schedule, but you can defragment your computer manually at any time.

To run Disk Defragmenter:

1. Connect the computer to AC power.
2. Select **Start > All Programs > Accessories > System Tools > Disk Defragmenter**.
3. **Windows 7**—Click **Defragment disk**.

 **NOTE:** Windows includes the User Account Control feature to improve the security of your computer. You may be prompted for your permission or password for tasks such as installing software, running utilities, or changing Windows settings. Refer to Help and Support for more information.

Windows XP— Under **Volume**, click the listing for the hard drive, usually listed as (C:), and then click **Defragment**.

For additional information, access the Disk Defragmenter software Help.

Using Disk Cleanup

Disk Cleanup searches the hard drive for unnecessary files that you can safely delete to free up disk space and help the computer to run more efficiently.

To run Disk Cleanup:

1. Select **Start > All Programs > Accessories > System Tools > Disk Cleanup**.
2. Follow the on-screen instructions.

Using HP ProtectSmart Hard Drive Protection in Windows 7 (select models only)

HP ProtectSmart Hard Drive Protection protects a hard drive by parking the drive and halting data requests under either of the following conditions:

- You drop the computer.
- You move the computer with the display closed while the computer is running on battery power.

A short time after the end of one of these events, HP ProtectSmart Hard Drive Protection returns the hard drive to normal operation.

 **NOTE:** Because solid-state drives (SSD) lack moving parts, HP ProtectSmart Hard Drive Protection is unnecessary.

NOTE: Hard drives in the primary hard drive bay or in the secondary hard drive bay are protected by HP ProtectSmart Hard Drive Protection. Hard drives connected to USB ports are not covered by HP ProtectSmart Hard Drive Protection.

For more information, refer to the HP ProtectSmart Hard Drive Protection software Help.

Identifying HP ProtectSmart Hard Drive Protection status

The drive light on the computer changes color to show that a drive in the primary hard drive bay or a drive in the secondary hard drive bay (select models only) is parked. To determine whether drives are currently protected or whether a drive is parked, select **Start > Control Panel > Hardware and Sound > Windows Mobility Center**:

- If HP ProtectSmart Hard Drive Protection is enabled, a green check mark is superimposed over the hard drive icon.
- If HP ProtectSmart Hard Drive Protection is disabled, a red X is superimposed over the hard drive icon.
- If the drives are parked, a yellow moon is superimposed over the hard drive icon.

The icon in the Mobility Center may not show the most up-to-date status for the drive. For immediate updates after a change in status, you need to enable the notification area icon.

To enable the notification area icon:

1. Select **Start > Control Panel > Hardware and Sound > HP ProtectSmart Hard Drive Protection**.

 **NOTE:** If prompted by User Account Control, click **Yes**.

2. On the **Icon in System Tray** row, click **Show**.
3. Click **OK**.

Managing power with a parked hard drive

If HP ProtectSmart Hard Drive Protection has parked the drive, the computer behaves in the following ways:

- The computer will not shut down.
- The computer will not initiate Sleep or Hibernation, except as described in the following Note.

 **NOTE:** If the computer is running on battery power and reaches a critical battery level, HP ProtectSmart Hard Drive Protection allows the computer to initiate Hibernation.

Before you move the computer, HP recommends that you either shut it down or initiate Sleep or Hibernation.

Using HP ProtectSmart Hard Drive Protection software

The HP ProtectSmart Hard Drive Protection software can be enabled or disabled by an Administrator.

 **NOTE:** Depending on your user privileges, you may be unable to enable or disable HP ProtectSmart Hard Drive Protection. Privileges for non-Administrator users can be changed by members of an Administrator group.

To open the software and change settings, follow these steps:

1. In Mobility Center, click the hard drive icon to open the HP ProtectSmart Hard Drive Protection window.

– or –

Select **Start > Control Panel > Hardware and Sound > HP ProtectSmart Hard Drive Protection**.

 **NOTE:** If prompted by User Account Control, click **Yes**.

2. Click the appropriate button to change settings.
3. Click **OK**.

Using optical drives (select models only)

Optical drives include the following:

- CD
- DVD
- Blu-ray (BD)

Identifying the installed optical drive

▲ **Windows 7**—Select **Start > Computer**.

Windows XP—Select **Start > My Computer**.

A list of all the devices installed in your computer, including your optical drive, is displayed.

Inserting an optical disc

Tray load

1. Turn on the computer.
2. Press the release button (1) on the drive bezel to release the disc tray.
3. Pull out the tray (2).
4. Hold the disc by the edges to avoid touching the flat surfaces and position the disc label-side up over the tray spindle.

 **NOTE:** If the tray is not fully accessible, tilt the disc carefully to position it over the spindle.

5. Gently press the disc (3) down onto the tray spindle until the disc snaps into place.

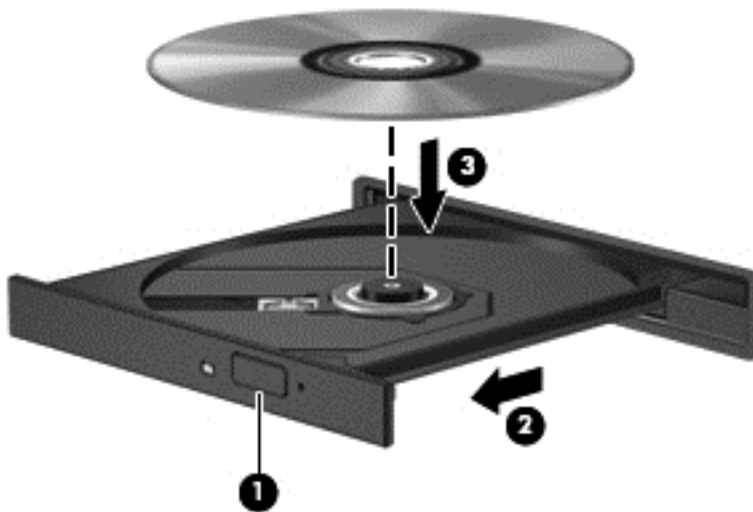

6. Close the disc tray.

 **NOTE:** After you insert a disc, a short pause is normal. If you have not selected a media player, an AutoPlay dialog box opens. It prompts you to select how you want to use the media content.

Slot load

 **CAUTION:** Do not insert **8-cm** optical discs into a slot load optical drive. It may cause damage to the optical drive.

1. Turn on the computer.
2. Hold the disc by the edges to avoid touching the flat surfaces and position the disc label-side up.

3. Gently slide the disc into the slot load optical drive.



Removing an optical disc

Tray load

There are 2 ways to remove a disc, depending on whether the disc tray opens normally or not.

When the disc tray opens normally

1. Press the release button (1) on the drive bezel to release the disc tray, and then gently pull out the tray (2) until it stops.
2. Remove the disc (3) from the tray by gently pressing down on the spindle while lifting the outer edges of the disc. Hold the disc by the edges and avoid touching the flat surfaces.

 **NOTE:** If the tray is not fully accessible, tilt the disc carefully as you remove it.

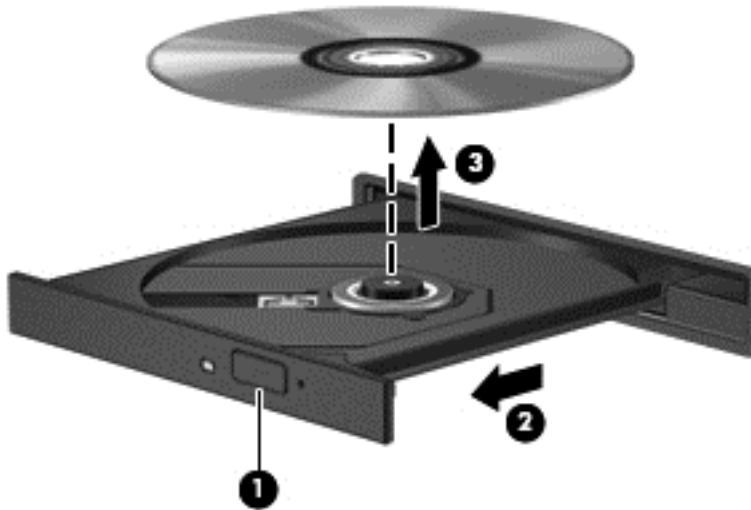

3. Close the disc tray and place the disc in a protective case.

When the disc tray fails to open

1. Insert the end of a paper clip (1) into the release access in the front bezel of the drive.
2. Press in gently on the paper clip until the tray is released, and then pull out the tray (2) until it stops.

3. Remove the disc **(3)** from the tray by gently pressing down on the spindle while lifting the outer edges of the disc. Hold the disc by the edges and avoid touching the flat surfaces.

 **NOTE:** If the tray is not fully accessible, tilt the disc carefully as you remove it.

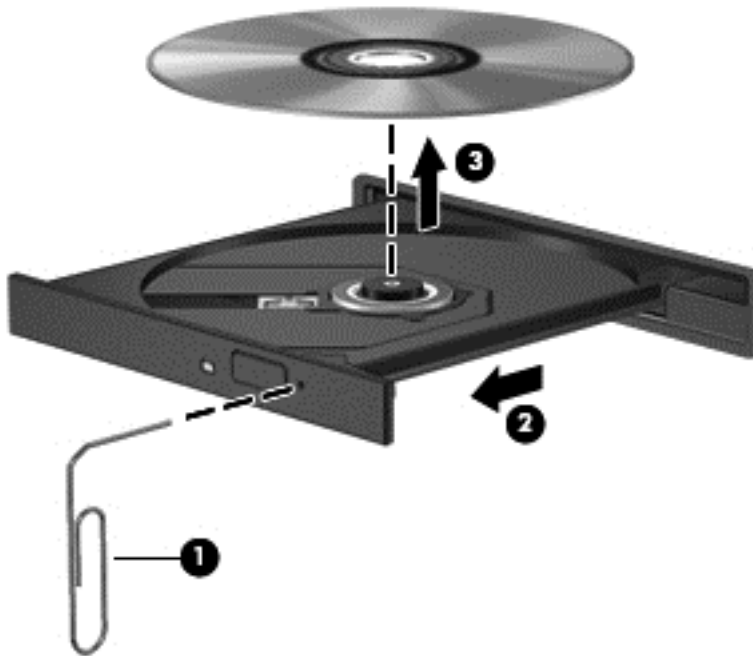

4. Close the disc tray and place the disc in a protective case.

Slot load

1. Press the release button **(1)** next to the drive.
2. Remove the disc **(2)** by holding it by the edges and avoid touching the flat surfaces.



3. Place the disc in a protective case.

Sharing optical drives

Although your computer may not have an integrated optical drive, you can access software and data, and install applications, by sharing an optical drive connected to another computer in your network. Sharing drives is a feature of the Windows operating system that allows a drive on one computer to be accessible to other computers on the same network.

 **NOTE:** You must have a network set up in order to share an optical drive; refer to [Networking \(select models only\) on page 2](#) for additional information on setting up a network.

NOTE: Some discs, such as DVD movies and game discs, may be copy-protected and therefore unusable through DVD or CD drive sharing.

To share an optical drive:

1. **Windows 7**—From the computer with the optical drive you are sharing, select **Start > Computer**.

Windows XP—From the computer with the optical drive you are sharing, select **Start > My Computer**.

2. Right-click the optical drive you want to share, and click **Properties**.

3. **Windows 7**—Select the **Sharing** tab > **Advanced Sharing**.

Windows XP—Select the **Sharing** tab.

4. Select the **Share this folder** check box.

5. Type a name for the optical drive in the **Share name** text box.

6. Click **Apply**, and then click **OK**.

7. To view the shared optical drive:

Windows 7—Select **Start > Control Panel > Network and Internet > Network and Sharing Center**.

Windows XP—Select **Start > Control Panel > Network and Internet Connections**.

Using RAID (select models only)

Redundant Arrays of Independent Disks (RAID) technology allows a computer to use two or more hard disks at the same time. RAID treats multiple drives as one contiguous drive, either through hardware or software settings. If multiple disks are set up to work together in this fashion, they are referred to as a RAID array.

For additional information about RAID, refer to the HP Web site at <http://www.hp.com/support>.

7 Security

Protecting the computer

Standard security features provided by the Windows® operating system and the non-Windows Setup Utility can protect your personal settings and data from a variety of risks.

 **NOTE:** Security solutions are designed to act as deterrents, but they may not deter software attacks or prevent the computer from being mishandled or stolen.

NOTE: Before you send your computer for service, back up and delete confidential files, and remove all password settings.

NOTE: Some features listed in this chapter may not be available on your computer.

Computer risk	Security feature
Unauthorized use of the computer	<ul style="list-style-type: none">• QuickLock (select models only)• Power-on password• Fingerprint reader
Computer viruses	Antivirus software
Unauthorized access to data	<ul style="list-style-type: none">• Firewall software• Windows updates• File encryption
Unauthorized access to Setup Utility, BIOS settings, and other system identification information	Administrator password
Ongoing or future threats to the computer	Critical security updates from Microsoft
Unauthorized access to a Windows user account	User password
Unauthorized removal of the computer	Security cable slot (used with an optional security cable)

Using passwords

A password is a group of characters that you choose to secure your computer information. Several types of passwords can be set, depending on how you want to control access to your information. Passwords can be set in Windows or in the non-Windows Setup Utility that is preinstalled on the computer.

 **NOTE:** To reduce the risk of being locked out of the computer, record each password and store it in a secure place.

You can use the same password for a Setup Utility feature and for a Windows security feature. You can also use the same password for more than one Setup Utility feature.

For additional information about Windows passwords, such as screen-saver passwords, select **Start > Help and Support**.

Setting passwords in Windows

Password	Function
Administrator password	Protects administrator-level access to computer contents. NOTE: This password cannot be used to access Setup Utility contents.
User password	Protects access to a Windows user account. It also protects access to the computer contents and must be entered when you exit Sleep or Hibernation.
QuickLock (select models only)	Protects your information by displaying the operating system Log On window. While the Log On window is displayed, the computer cannot be accessed until a Windows user password or a Windows administrator password is entered. After you set a user or administrator password, follow these steps: <ol style="list-style-type: none">1. Initiate QuickLock.2. Exit QuickLock by entering your Windows user or administrator password.

Setting passwords in Setup Utility

Password	Function
Administrator password*	<ul style="list-style-type: none">• Protects access to Setup Utility.• After this password is set, it must be entered each time you access Setup Utility. <p>CAUTION: If you forget your administrator password, you cannot access Setup Utility.</p> <p>NOTE: The administrator password can be used in place of the power-on password.</p> <p>NOTE: Your administrator password is not interchangeable with an administrator password set in Windows, nor is it displayed as it is set, entered, changed, or deleted.</p> <p>NOTE: If you enter the power-on password at the first password check before the "Press the ESC key for Startup Menu" message is displayed, you must enter the administrator password to access Setup Utility.</p>

Password	Function
Power-on password*	<ul style="list-style-type: none"> Protects access to the computer contents. After this password is set, it must be entered each time you turn on or restart the computer, or exit Hibernation. <p>CAUTION: If you forget your power-on password, you cannot turn on or restart the computer, or exit Hibernation.</p> <p>NOTE: The administrator password can be used in place of the power-on password.</p> <p>NOTE: A power-on password is not displayed as it is set, entered, changed, or deleted.</p>

*For details about each of these passwords, refer to the following topics.

Managing an administrator password

To set, change, or delete this password, follow these steps:

- Open Setup Utility by turning on or restarting the computer. While the “Press the ESC key for Startup Menu” message is displayed in the lower-left corner of the screen, press **esc**. When the Startup Menu is displayed, press **f10**.
- Use the arrow keys to select **Security > Set Administrator Password**, and then press **enter**.
 - To set an administrator password, type your password in the **Enter New Password** and **Confirm New Password** fields, and then press **enter**.
 - To change an administrator password, type your current password in the **Enter Current Password** field, type a new password in the **Enter New Password** and **Confirm New Password** fields, and then press **enter**.
 - To delete an administrator password, type your current password in the **Enter Password** field, and then press **enter** 4 times.
- To save your changes and exit Setup Utility, use the arrow keys to select **Exit > Exit Saving Changes**.

Your changes take effect when the computer restarts.

Entering an administrator password

At the **Enter Password** prompt, type your administrator password, and then press **enter**. After 3 unsuccessful attempts to enter the administrator password, you must restart the computer and try again.

Managing a power-on password

To set, change, or delete this password, follow these steps:

1. Open Setup Utility by turning on or restarting the computer. While the “Press the ESC key for Startup Menu” message is displayed in the lower-left corner of the screen, press [esc](#). When the Startup Menu is displayed, press [f10](#).
2. Use the arrow keys to select **Security > Set Power-On Password**, and then press [enter](#).
 - To set a power-on password, type your password in the **Enter New Password** and **Confirm New Password** fields, and then press [enter](#).
 - To change a power-on password, type your current password in the **Enter Current Password** field, type a new password in the **Enter New Password** and **Confirm New Password** fields, and then press [enter](#).
 - To delete a power-on password, type your current password in the **Enter Current Password** field, and then press [enter](#) 4 times.
3. To save your changes and exit Setup Utility, use the arrow keys to select **Exit > Exit Saving Changes**.

Your changes take effect when the computer restarts.

Entering a power-on password

At the **Enter Password** prompt, type your password, and then press [enter](#). After 3 unsuccessful attempts to enter the password, you must restart the computer and try again.

Using antivirus software

When you use the computer to access e-mail, a network, or the Internet, you potentially expose it to computer viruses. Computer viruses can disable the operating system, programs, or utilities, or cause them to function abnormally.

Antivirus software can detect most viruses, destroy them, and, in most cases, repair any damage they have caused. To provide ongoing protection against newly discovered viruses, antivirus software must be kept up to date.

An antivirus program may be preinstalled on your computer and may include a trial offer. It is strongly recommended that you upgrade the trial offer or purchase the antivirus program of your choice in order to fully protect your computer.

For more information about computer viruses, type `viruses` in the Search box in Help and Support.

Using firewall software

Firewalls are designed to prevent unauthorized access to a system or network. A firewall can be a software program you install on your computer and/or network, or it can be a solution made up of both hardware and software.

There are two types of firewalls to consider:

- Host-based firewalls—Software that protects only the computer it is installed on.
- Network-based firewalls—Installed between your DSL or cable modem and your home network to protect all the computers on the network.

When a firewall is installed on a system, all data sent to and from the system is monitored and compared with a set of user-defined security criteria. Any data that does not meet those criteria is blocked.

Your computer or networking equipment may already have a firewall installed. If not, firewall software solutions are available.

 **NOTE:** Under some circumstances a firewall can block access to Internet games, interfere with printer or file sharing on a network, or block authorized e-mail attachments. To temporarily resolve the problem, disable the firewall, perform the task that you want to perform, and then reenable the firewall. To permanently resolve the problem, reconfigure the firewall.

Installing critical security updates

△ **CAUTION:** Microsoft sends out alerts regarding critical updates. To protect the computer from security breaches and computer viruses, install all critical updates from Microsoft as soon as you receive an alert.

Updates to the operating system and other software may have become available after the computer left the factory. To be sure that all available updates are installed on the computer, observe these guidelines:

- Run Windows Update as soon as possible after you set up your computer. Use the update link at **Start > All Programs > Windows Update**.
- Run Windows Update monthly thereafter.
- Obtain updates to Windows and other Microsoft® programs, as they are released, from the Microsoft Web site and through the updates link in Help and Support.

Installing an optional security cable

 **NOTE:** A security cable is designed to act as a deterrent, but it may not prevent the computer from being mishandled or stolen.

NOTE: The security cable slot on your computer may look slightly different from the illustration in this section. Refer to the *Getting Started* guide for the location of the security cable slot on your computer.

1. Loop the security cable around a secured object.
2. Insert the key **(1)** into the cable lock **(2)**.

3. Insert the cable lock into the security cable slot on the computer (3), and then lock the cable lock with the key.

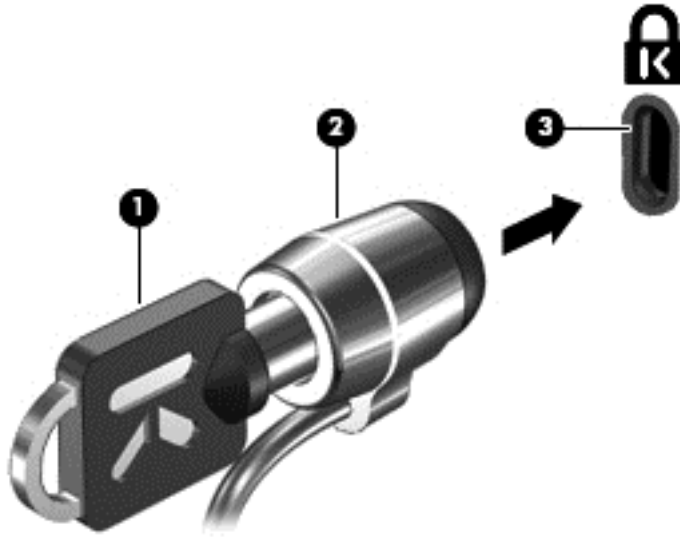

4. Remove the key and keep it in a safe place.

Using the fingerprint reader (select models only)

Integrated fingerprint readers are available on select computer models. In order to use the fingerprint reader, you must set up a user account with a password on the computer. This account allows you to log on to your computer with a swipe of a designated finger. You may also use the fingerprint reader to fill in password fields on Web sites and other programs that require a logon. Refer to the fingerprint software Help for instructions.

After you create your fingerprint identity, you can set up a Single Sign On service that allows you to use your fingerprint scanner to create credentials for any application that requires a user name and password.

Locating the fingerprint reader

The fingerprint reader is a small metallic sensor that is located in one of the following areas of your computer:

- Near the bottom of the TouchPad
- On the right side of the keyboard
- On the upper-right side of the display
- On the left side of the display

Depending on your computer model, the fingerprint reader may be oriented horizontally or vertically. Both orientations require that you swipe your finger perpendicular to the metallic sensor. Refer to the *Getting Started* guide for the location of the fingerprint reader on your computer.

8 Maintenance

Cleaning your computer

Cleaning the display

△ **CAUTION:** To prevent permanent damage to the computer, never spray water, cleaning fluids, or chemicals on the display.

To remove smudges and lint, frequently clean the display with a soft damp, lint-free cloth. If the screen requires additional cleaning, use premoistened antistatic wipes or an antistatic screen cleaner.

Cleaning the TouchPad and keyboard

Dirt and grease on the TouchPad can cause the pointer to jump around on the screen. To avoid this, clean the TouchPad with a damp cloth, and wash your hands frequently when using the computer.

△ **WARNING!** To reduce the risk of electric shock or damage to internal components, do not use a vacuum cleaner attachment to clean the keyboard. A vacuum cleaner can deposit household debris on the keyboard surface.

Clean the keyboard regularly to prevent keys from sticking, and to remove dust, lint, and particles that can become trapped beneath the keys. A can of compressed air with a straw extension can be used to blow air around and under the keys to loosen and remove debris.

Updating programs and drivers

HP recommends that you update your programs and drivers on a regular basis with the latest versions. Go to <http://www.hp.com/support> to download the latest versions. You can also register to receive automatic update notifications when they become available.

Using SoftPaq Download Manager

HP SoftPaq Download Manager (SDM) is a tool that provides quick access to SoftPaq information for HP business computers without requiring the SoftPaq number. Using this tool, you can easily search for SoftPaqs, and then download and unpack them.

SoftPaq Download Manager works by reading and downloading, from the HP FTP site, a published database file containing computer model and SoftPaq information. SoftPaq Download Manager allows you to specify one or more computer models to determine which SoftPaqs are available for download.

SoftPaq Download Manager checks the HP FTP site for updates to the database and software. If updates are found, they are downloaded and applied automatically.

SoftPaq Download Manager is available on the HP Web site. To use SoftPaq Download Manager to download SoftPaqs, you must first download and install the program. Go to the HP Web site at <http://www.hp.com/go/sdm>, and follow the instructions to download and install SoftPaq Download Manager.

To download SoftPaqs:

1. Select **Start > All Programs > HP Software Setup > HP SoftPaq Download Manager**.
2. When SoftPaq Download Manager opens for the first time, a window is displayed asking if you want to show only software for the computer you are using or to show the software for all supported models. Select **Show software for all supported models**. If you have used HP SoftPaq Download Manager previously, go to Step 3.
 - a. Select your operating system and language filters in the Configuration Options window. The filters limit the number of options that are listed in the Product Catalog pane. For example, if only Windows 7 Professional is selected in the operating system filter, the only operating system that is displayed in the Product Catalog is Windows 7 Professional.
 - b. To add other operating systems, change the filter settings in the Configuration Options window. Refer to the HP SoftPaq Download Manager software Help for more information.
3. In the left pane, click the plus sign (+) to expand the model list, and then select the model or models of the products you want to update.
4. Click **Find Available SoftPaqs** to download a list of available SoftPaqs for the selected computer.
5. Select from the list of available SoftPaqs, and then click **Download Only** if you have many SoftPaqs to download, because the SoftPaq selection and Internet connection speed determine how long the download process will take.

If you want to download only one or two SoftPaqs and have a high-speed Internet connection, click **Download & Unpack**.

6. Right-click **Install SoftPaq** in the SoftPaq Download Manager software to install the selected SoftPaqs on the computer.

9 Setup Utility (BIOS) and System Diagnostics

Using Setup Utility

Setup Utility, or Basic Input/Output System (BIOS), controls communication between all the input and output devices on the system (such as disk drives, display, keyboard, mouse, and printer). Setup Utility includes settings for the types of peripherals installed, the startup sequence of the computer, and the amount of system and extended memory.

 **NOTE:** Use extreme care when making changes in Setup Utility. Errors can prevent the computer from operating properly.

Starting Setup Utility

 **NOTE:** An external keyboard or mouse connected to a USB port can be used with Setup Utility only if USB legacy support is enabled.

To start Setup Utility, follow these steps:

1. Turn on or restart the computer, and then press **esc** while the “Press the ESC key for Startup Menu” message is displayed at the bottom of the screen.
2. Press **f10** to enter Setup Utility.

Changing the language of Setup Utility

1. Start Setup Utility.
2. Use the arrow keys to select **System Configuration > Language**, and then press **enter**.
3. Use the arrow keys to select a language, and then press **enter**.
4. When a confirmation prompt with your language selected is displayed, press **enter**.
5. To save your change and exit Setup Utility, use the arrow keys to select **Exit > Exit Saving Changes**, and then press **enter**.

Your change takes effect immediately.

Navigating and selecting in Setup Utility

To navigate and select in Setup Utility, follow these steps:

1. Turn on or restart the computer, and then press **esc** while the “Press the ESC key for Startup Menu” message is displayed at the bottom of the screen.
 - To select a menu or a menu item, use the tab key and the keyboard arrow keys and then press **enter**, or use a pointing device to click the item.
 - To scroll up and down, click the up arrow or the down arrow in the upper-right corner of the screen, or use the up arrow key or the down arrow key.
 - To close open dialog boxes and return to the main Setup Utility screen, press **esc**, and then follow the on-screen instructions.

 **NOTE:** You can use either a pointing device (TouchPad, pointing stick, or USB mouse) or the keyboard to navigate and make selections in Setup Utility.

2. Press **f10** to enter Setup Utility.

To exit Setup Utility menus, choose one of the following methods:

- To exit Setup Utility menus without saving your changes, click the **Exit** icon in the lower-left corner of the screen, and then follow the on-screen instructions.

– or –

Use the tab key and the arrow keys to select **File > Ignore Changes and Exit**, and then press **enter**.

– or –
- To save your changes and exit Setup Utility menus, click the **Save** icon in the lower-left corner of the screen, and then follow the on-screen instructions.

– or –

Use the tab key and the arrow keys to select **File > Save Changes and Exit**, and then press **enter**.

Your changes go into effect when the computer restarts.

Displaying system information

1. Start Setup Utility.
2. Select the **Main** menu. System information such as the system time and date, and identification information about the computer is displayed.
3. To exit Setup Utility without changing any settings, use the arrow keys to select **Exit > Exit Discarding Changes**, and then press **enter**.

Restoring factory settings in Setup Utility

 **NOTE:** Restoring defaults will not change the hard drive mode.

To return all settings in Setup Utility to the values that were set at the factory, follow these steps:

1. Turn on or restart the computer, and then press **esc** while the “Press the ESC key for Startup Menu” message is displayed at the bottom of the screen.
2. Press **f10** to enter Setup Utility.
3. Use a pointing device or the arrow keys to select **File > Restore Defaults**.
4. Follow the on-screen instructions.
5. To save your changes and exit, click the **Save** icon in the lower-left corner of the screen, and then follow the on-screen instructions.

– or –

Use the arrow keys to select **File > Save Changes and Exit**, and then press **enter**.

Your changes go into effect when the computer restarts.

 **NOTE:** Your password settings and security settings are not changed when you restore the factory settings.

Exiting Setup Utility

- To exit Setup Utility and save your changes from the current session:
If the Setup Utility menus are not visible, press **esc** to return to the menu display. Then use the arrow keys to select **Exit > Exit Saving Changes**, and then press **enter**.
- To exit Setup Utility without saving your changes from the current session:
If the Setup Utility menus are not visible, press **esc** to return to the menu display. Then use the arrow keys to select **Exit > Exit Discarding Changes**, and then press **enter**.

Updating the BIOS

Updated versions of the BIOS may be available on the HP Web site.

Most BIOS updates on the HP Web site are packaged in compressed files called *SoftPaqs*.

Some download packages contain a file named *Readme.txt*, which contains information regarding installing and troubleshooting the file.

Determining the BIOS version

To determine whether available BIOS updates contain later BIOS versions than those currently installed on the computer, you need to know the version of the system BIOS currently installed.

BIOS version information (also known as *ROM date* and *System BIOS*) can be displayed by pressing **fn+esc** (if you are already in Windows) or by using Setup Utility.

1. Start Setup Utility.
2. Use a pointing device or the arrow keys to select **File > System Information**.
3. To exit Setup Utility without saving your changes, click the **Exit** icon in the lower-left corner of the screen, and then follow the on-screen instructions.

– or –

Use the tab key and the arrow keys to select **File > Ignore Changes and Exit**, and then press **enter**.

Downloading a BIOS update

- △ **CAUTION:** To reduce the risk of damage to the computer or an unsuccessful installation, download and install a BIOS update only when the computer is connected to reliable external power using the AC adapter. Do not download or install a BIOS update while the computer is running on battery power, docked in an optional docking device, or connected to an optional power source. During the download and installation, follow these instructions:

Do not disconnect power from the computer by unplugging the power cord from the AC outlet.

Do not shut down the computer or initiate Sleep or Hibernation.

Do not insert, remove, connect, or disconnect any device, cable, or cord.

1. **Windows 7**—Select **Start > Help and Support > Maintain**.
Windows XP—Select **Start > Help and Support**, and then select the software and drivers update.
2. Follow the on-screen instructions to identify your computer and access the BIOS update you want to download.
3. At the download area, follow these steps:
 - a. Identify the BIOS update that is later than the BIOS version currently installed on your computer. Make a note of the date, name, or other identifier. You may need this information to locate the update later, after it has been downloaded to your hard drive.
 - b. Follow the on-screen instructions to download your selection to the hard drive.

Make a note of the path to the location on your hard drive where the BIOS update is downloaded. You will need to access this path when you are ready to install the update.

- 📄 **NOTE:** If you connect your computer to a network, consult the network administrator before installing any software updates, especially system BIOS updates.

BIOS installation procedures vary. Follow any instructions that are displayed on the screen after the download is complete. If no instructions are displayed, follow these steps:

1. **Windows 7**—Open Windows Explorer by selecting **Start > Computer**.
Windows XP—Open Windows Explorer by selecting **Start > My Computer**.
2. Double-click your hard drive designation. The hard drive designation is typically Local Disk (C:).

3. Using the hard drive path you recorded earlier, open the folder on your hard drive that contains the update.
4. Double-click the file that has an .exe extension (for example, *filename.exe*).
The BIOS installation begins.
5. Complete the installation by following the on-screen instructions.

 **NOTE:** After a message on the screen reports a successful installation, you can delete the downloaded file from your hard drive.

Using System Diagnostics

System Diagnostics allows you to run diagnostic tests to determine if the computer hardware is functioning properly. The following diagnostic tests are available in System Diagnostics:

- **Start-up test**—This test analyzes the main computer components that are required to start the computer.
- **Run-in test**—This test repeats the start-up test and checks for intermittent problems that the start-up test does not detect.
- **Hard disk test**—This test analyzes the physical condition of the hard drive, and then checks all data in every sector of the hard drive. If the test detects a damaged sector, it attempts to move the data to a good sector.
- **Memory test**—This test analyzes the physical condition of the memory modules. If it reports an error, replace the memory modules immediately.
- **Battery test**—This test analyzes the condition of the battery. If the battery fails the test, contact HP support to report the issue and purchase a replacement battery.

You can also view system information and error logs in the System Diagnostics window.

To start System Diagnostics:

1. Turn on or restart the computer. While the “Press the ESC key for Startup Menu” message is displayed in the lower-left corner of the screen, press **esc**. When the Startup Menu is displayed, press **f2**.
2. Click the diagnostic test you want to run, and then follow the on-screen instructions.

 **NOTE:** If you need to stop a diagnostics test while it is running, press **esc**.

A Traveling with the computer

For best results, follow these traveling and shipping tips:

- Prepare the computer for traveling or shipping:
 - Back up your information.
 - Remove all discs and all external media cards, such as digital cards.
 - △ **CAUTION:** To reduce the risk of damage to the computer, damage to a drive, or loss of information, remove the media from a drive before removing the drive from a drive bay and before shipping, storing, or traveling with a drive.
 - Turn off and then disconnect all external devices.
 - Shut down the computer.
- Take along a backup of your information. Keep the backup separate from the computer.
- When traveling by air, carry the computer as hand luggage; do not check it in with the rest of your bags.
- △ **CAUTION:** Avoid exposing a drive to magnetic fields. Security devices with magnetic fields include airport walk-through devices and security wands. Airport conveyer belts and similar security devices that check carry-on baggage use X-rays instead of magnetism and do not damage drives.
- In-flight computer use is at the discretion of the airline. If you plan to use the computer during a flight, check with the airline in advance.
- If the computer will be unused and disconnected from external power for more than 2 weeks, remove the battery and store it separately.
- If you are shipping the computer or a drive, use suitable protective packaging and label the package “FRAGILE.”
- If the computer has a wireless device or an HP Mobile Broadband Module installed, such as an 802.11b/g device, a Global System for Mobile Communications (GSM) device, or a General Packet Radio Service (GPRS) device, the use of these devices may be restricted in some environments. Such restrictions may apply onboard aircraft, in hospitals, near explosives, and in

hazardous locations. If you are uncertain of the policy that applies to the use of a particular device, ask for authorization to use it before you turn it on.

- If you are traveling internationally, follow these suggestions:
 - Check the computer-related customs regulations for each country or region on your itinerary.
 - Check the power cord and adapter requirements for each location in which you plan to use the computer. Voltage, frequency, and plug configurations vary.
-
- ⚠ **WARNING!** To reduce the risk of electric shock, fire, or damage to the equipment, do not attempt to power the computer with a voltage converter kit sold for appliances.

B Troubleshooting resources

- Access Web site links and additional information about the computer through Help and Support. Select **Start > Help and Support**.

 **NOTE:** Some checkup and repair tools require an Internet connection. HP also provides additional tools that do not require an Internet connection.

- Contact HP Customer Support at <http://www.hp.com/go/contactHP>.

 **NOTE:** For worldwide support, click **Contact HP worldwide** on the left side of the page, or go to http://welcome.hp.com/country/us/en/wwcontact_us.html.

Choose from the following types of support:

- Chat online with an HP technician.

 **NOTE:** When chat is not available in a particular language, it is available in English.

- E-mail HP Customer Support.
- Find HP Customer Support worldwide telephone numbers.
- Locate an HP service center.

C Electrostatic Discharge

Electrostatic discharge is the release of static electricity when two objects come into contact—for example, the shock you receive when you walk across the carpet and touch a metal door knob.

A discharge of static electricity from fingers or other electrostatic conductors may damage electronic components. To prevent damage to the computer, damage to a drive, or loss of information, observe these precautions:

- If removal or installation instructions direct you to unplug the computer, unplug it after being properly grounded and before removing a cover.
- Keep components in their electrostatic-safe containers until you are ready to install them.
- Avoid touching pins, leads, and circuitry. Handle electronic components as little as possible.
- Use nonmagnetic tools.
- Before handling components, discharge static electricity by touching an unpainted metal surface of the component.
- If you remove a component, place it in an electrostatic-safe container.

If you need more information about static electricity or assistance with component removal or installation, contact Customer Support.

Index

Symbols/Numerics

- 1394 cable, connecting 40
- 1394 devices
 - connecting 40
 - defined 39
 - removing 40
- 16-bit PC Cards 32
- 32-bit PC Cards 32

A

- AC adapter, testing 30
- action keys
 - media 15
 - volume 16
- administrator password
 - creating 54
 - entering 54
 - managing 54
- airport security devices 44
- antivirus software, using 55
- audio functions, checking 16

B

- battery
 - conserving power 27
 - discharging 26
 - displaying remaining charge 26
 - disposing 28
 - low battery levels 26
 - replacing 28
 - storing 28
- Battery Check 26
- battery information, finding 25
- battery power 25
- battery temperature 28
- BIOS
 - determining version 62

- downloading an update 63
- updating 62
- Bluetooth device 2, 9
- buttons
 - media 15
 - power 21
 - volume 16
 - wireless 3

C

- cables
 - 1394 40
 - eSATA 41
 - USB 39
- CardBus PC Cards 32
- checking audio functions 16
- computer, traveling 28, 65
- configuring audio for HDMI 19
- configuring ExpressCards 35
- configuring PC Cards 33
- connecting to a wired network 9
- connecting to an existing wireless network 5
- Connection Manager 4
- connector, docking 43
- conservation, power 27
- creating a wireless connection 2
- critical battery level 22, 27
- critical security updates, installing 56

D

- digital card
 - inserting 31
 - removing 32
 - supported formats 31
- Disk Cleanup software 45
- Disk Defragmenter software 45
- DisplayPort, connecting 18

- docking connector 43
- drive light 46
- drive media 22
- drivers 33
- drives
 - external 42
 - handling 44
 - hard 42
 - optical 42
 - using 45

E

- electrostatic discharge 68
- entering a power-on password 55
- entering an administrator password 54
- eSATA cable, connecting 41
- eSATA devices
 - connecting 41
 - defined 40
 - removing 41
- existing wireless network, connecting to 5
- expansion port 42
- ExpressCard
 - configuring 35
 - defined 35
 - inserting 36
 - removing 37
 - removing insert 36
- external AC power, using 29
- external devices 42
- external drive 42
- external monitor port 17

F

- finding more information 1

fingerprint reader
 locating 57
 using 57
firewall software 7, 55

G

GPS 9

H

hard drive
 external 42
 HP ProtectSmart Hard Drive Protection 46
HDMI
 configuring audio 19
HDMI port, connecting 18
Hibernation
 exiting 23
 initiated during critical battery level 27
 initiating 23
high-definition devices,
 connecting 18, 19
HP Connection Manager 4
HP MediaSmart 20
HP Mobile Broadband Module 7, 8
HP ProtectSmart Hard Drive Protection 46
HP SkyRoom 17
HP USB Ethernet Adapter,
 connecting 13
HP Wireless Assistant 4
hubs 38

I

icons
 network 2
 wireless 2
installing
 critical security updates 56
 optional security cable 56
Intel Wireless Display 19
Internet connection setup 6

J

Java Card
 defined 37
 inserting 38
 removing 38

K

keys
 media 15
 volume 16

L

legacy support, USB 60
lights, drive 46
local area network (LAN)
 cable required 13
 connecting cable 13
low battery level 26

M

maintenance
 Disk Cleanup 45
 Disk Defragmenter 45
managing a power-on password 55
managing an administrator password 54
media action keys 15
media activity controls 15
media hotkeys 15
MediaSmart 20
modems
 connecting a modem cable 10
 connecting a modem cable adapter 10
 selecting a location setting 11

N

network cable, connecting 13
network icon 2

O

operating system controls 5
optical disc
 inserting 48
 removing 49
optical drive 42
optional external devices, using 42

P

passwords
 set in Setup Utility 53
 set in Windows 53
PC Cards
 configuring 33
 description 32

inserting 33
removing 34
removing insert 33
software and drivers 33
supported types 32

ports

DisplayPort 18
expansion 42
external monitor 17
HDMI 18
Intel Wireless Display 19
VGA 17

power

battery 25
conserving 27
options 22
power button 21
power meter 23
power plans
 customizing 24
 selecting 24
 viewing current 23

power switch 21
power-on password
 creating 55
 entering 55
 managing 55
power-saving states 22
protecting the computer 52
protecting your wireless network 7

Q

QuickLock 52, 53

R

RAID 51
readable media 22
roaming to another network 7

S

security cable, installing 56
security, wireless 7
setting password protection on
 wake up 24
setting power options 22
setup of WLAN 6
Setup Utility
 changing the language 60
 displaying system information 61

- exiting 62
 - navigating and selecting 61
 - passwords set in 53
 - restoring factory settings 62
- setup utility
 - navigating and selecting 61
 - restoring factory settings 62
- sharing optical drives 51
- shutdown 21
- SIM
 - inserting 8
 - removing 8
- SkyRoom 17
- Sleep
 - exiting 22
 - initiating 22
- slot-load optical drive 48
- smart card
 - defined 37
 - inserting 38
 - removing 38
- SoftPaqs, downloading 59
- software
 - Disk Cleanup 45
 - Disk Defragmenter 45
 - HP Connection Manager 4
 - HP MediaSmart 20
 - HP ProtectSmart Hard Drive Protection 47
 - HP SkyRoom 17
 - HP Wireless Assistant 4
- Standby 21
- storing a battery 28
- switch, power 21
- system information, displaying 61

T

- temperature 28
- testing an AC adapter 30
- traveling with the computer 28, 65
- tray-load optical drive 48
- troubleshooting resources 67
- turning off the computer 21
- turning wireless devices on or off 3

U

- unresponsive system 21
- USB cable, connecting 39

- USB devices
 - connecting 38
 - description 38
 - removing 39
- USB hubs 38
- USB legacy support 60
- using a modem 9
- using external AC power 29
- using passwords 52
- using power plans 23
- using power-saving states 22
- using the power meter 23

V

- VGA port, connecting 17
- video 17
- volume
 - adjusting 16
 - buttons 16
 - keys 16

W

- webcam 17
- Windows, passwords set in 53
- wireless
 - action key 3
 - button 3
 - icons 2
 - protecting 7
 - set up 6
 - switch 3
- Wireless Assistant software 4
- wireless connection, creating 2
- wireless devices, turning on or off 3
- wireless encryption 7
- wireless network (WLAN)
 - connecting to existing 5
 - equipment needed 6
 - security 7
- writable media 22
- WWAN device 7

Z

- zoomed video PC Cards 32

