

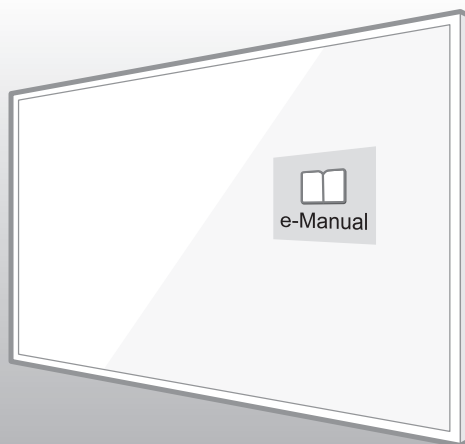

Samsung **UHD TV**
Ultra High Definition 4K
user manual

Thank you for purchasing this Samsung product.
To receive more complete service, please register
your product at
www.samsung.com/register

Model _____ Serial No. _____



CAUTION

RISK OF ELECTRIC SHOCK DO NOT OPEN

CAUTION: TO REDUCE THE RISK OF ELECTRIC SHOCK, DO NOT REMOVE COVER (OR BACK). THERE ARE NO USER SERVICEABLE PARTS INSIDE. REFER ALL SERVICING TO QUALIFIED PERSONNEL.



This symbol indicates that high voltage is present inside. It is dangerous to make any kind of contact with any internal part of this product.



This symbol indicates that this product has included important literature concerning operation and maintenance.

The slots and openings in the cabinet and in the back or bottom are provided for necessary ventilation. To ensure reliable operation of this apparatus and to protect it from overheating, these slots and openings must never be blocked or covered.

- Do not place this apparatus in a confined space, such as a bookcase or built-in cabinet, unless proper ventilation is provided.
- Do not place this apparatus near or over a radiator or heat register, or where it is exposed to direct sunlight.
- Do not place vessels (vases etc.) containing water on this apparatus, as this can result in a fire or electric shock.

Do not expose this apparatus to rain or place it near water (near a bathtub, washbowl, kitchen sink, or laundry tub, in a wet basement, or near a swimming pool etc.). If this apparatus accidentally gets wet, unplug it and contact an authorised dealer immediately.

This apparatus uses batteries. In your community, there might be environmental regulations that require you to dispose of these batteries properly. Please contact your local authorities for disposal or recycling information.

Do not overload wall outlets, extension cords or adaptors beyond their capacity, since this can result in fire or electric shock.

Power-supply cords should be placed so that they are not likely to be walked on or pinched by items placed upon or against them. Pay particular attention to cords at the plug end, at wall outlets, and at the point where they exit from the appliance.

To protect this apparatus from a lightning storm, or when left unattended and unused for long periods of time, unplug it from the wall outlet and disconnect the antenna or cable system. This will prevent damage to the set due to lightning and power line surges.

Before connecting the AC power cord to the DC adaptor outlet, make sure that the voltage designation of the DC adaptor corresponds to the local electrical supply.

Never insert anything metallic into the open parts of this apparatus. This may cause a danger of electric shock.

To avoid electric shock, never touch the inside of this apparatus. Only a qualified technician should open this apparatus.

Be sure to plug in the power cord until it is firmly seated. When unplugging the power cord from a wall outlet, always pull on the power cord's plug. Never unplug it by pulling on the power cord. Do not touch the power cord with wet hands.

If this apparatus does not operate normally - in particular, if there are any unusual sounds or smells coming from it - unplug it immediately and contact an authorised dealer or service centre.

Be sure to pull the power plug out of the outlet if the TV is to remain unused or if you are to leave the house for an extended period of time (especially when children, elderly or disabled people will be left alone in the house).

- Accumulated dust can cause an electric shock, an electric leakage, or a fire by causing the power cord to generate sparks and heat or by causing the insulation to deteriorate.

Be sure to contact an authorised service centre for information if you intend to install your TV in a location with heavy dust, high or low temperatures, high humidity, chemical substances, or where it will operate 24 hours a day such as in an aerial port, a train station, etc. Failure to do so may lead to serious damage to your TV.

Use only a properly grounded plug and wall outlet.

- An improper ground may cause electric shock or equipment damage. (Class I Equipment only.)

To turn off this apparatus completely, disconnect it from the wall outlet. Be sure to have the wall outlet and power plug readily accessible.

Do not allow children to hang onto the product.

Store the accessories (battery, etc.) in a location safely out of the reach of children.

Do not install the product in an unstable location such as a shaky shelf or a slanted floor or in a location exposed to vibration.

Do not drop or strike the product. If the product is damaged, disconnect the power cord and contact a service centre.

To clean this apparatus, unplug the power cord from the wall outlet and wipe the product with a soft, dry cloth. Do not use any chemicals such as wax, benzene, alcohol, thinners, insecticide, aerial fresheners, lubricants, or detergents. These chemicals can damage the appearance of the TV or erase the printing on the product.

Do not expose this apparatus to dripping or splashing.

Do not dispose of batteries in a fire.

Do not short-circuit, disassemble, or overheat the batteries.

There is danger of an explosion if you replace the batteries used in the remote with the wrong type of battery. Replace only with the same or equivalent type.

WARNING - TO PREVENT THE SPREAD OF FIRE, KEEP CANDLES OR OTHER ITEMS WITH OPEN FLAMES AWAY FROM THIS PRODUCT AT ALL TIMES.



What's in the Box?

Remote Control & Batteries (AAA x 2)

User Manual

Warranty Card (Not available in some locations)

Regulatory Guide

Power Cord

- Make sure that the following items are included with your TV. If there are any items missing, contact your local dealer.
- The colours and shapes of the items differ with the model.
- Cables not supplied with this product can be purchased separately.
- Open the box and check for any accessory items hidden behind or inside the packing materials.



Warning: Screens can be damaged from direct pressure when handled incorrectly. We recommend lifting the TV at the edges, as shown.

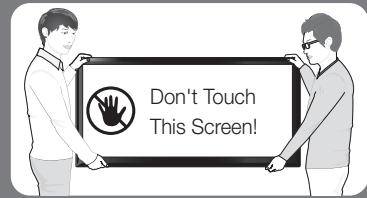

IMPORTANT INFORMATION

If a television is not positioned in a sufficiently stable location, it can be potentially hazardous due to falling. Many injuries, particularly to children, can be avoided by taking simple precautions such as:

- Using cabinets or stands recommended by the manufacturer of the television.
- Only using furniture that can safely support the television.
- Ensuring the television is not overhanging the edge of the supporting furniture.
- Not placing the television on tall furniture (for example, cupboards or bookcases) without anchoring both the furniture and the television to a suitable support.
- Not standing the televisions on cloth or other materials placed between the television and supporting furniture.
- Educating children about the dangers of climbing on furniture to reach the television or its controls.

Initial Setup

When you turn on your TV for the first time, it immediately starts the Initial Setup. During Initial Setup, connects to your network, implements **Smart Hub** agreements, links to the source of your live TV signal, and sets up control of your cable or set-top box.

To learn more about operating your TV, launch the TV's built in **e-Manual** after you have completed the Initial Setup. For Information about the **e-Manual**, see "The **e-Manual**" on page 8.

Password Change

System > Change PIN

Changing the TV's password.

1. Run **Change PIN** and then enter the current password in the password field. The default password is "0-0-0-0".
 2. Enter a new password and then enter it again to confirm it. The password change is complete.
- If you forgot your **PIN** code, press the buttons in the following sequence to reset the **PIN** to "0-0-0-0":
In Standby mode: MUTE → 8 → 2 → 4 → POWER (On)

Using the TV Controller

You can use the TV Controller on the back of the TV instead of the remote control to control most of the functions of your TV.

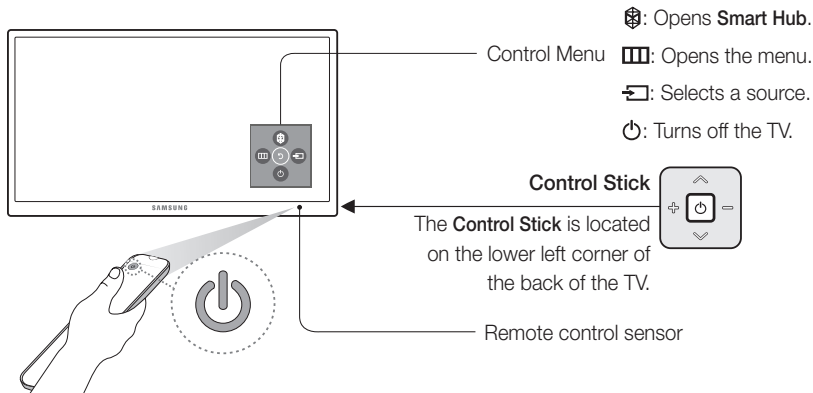

The Standard Remote Control

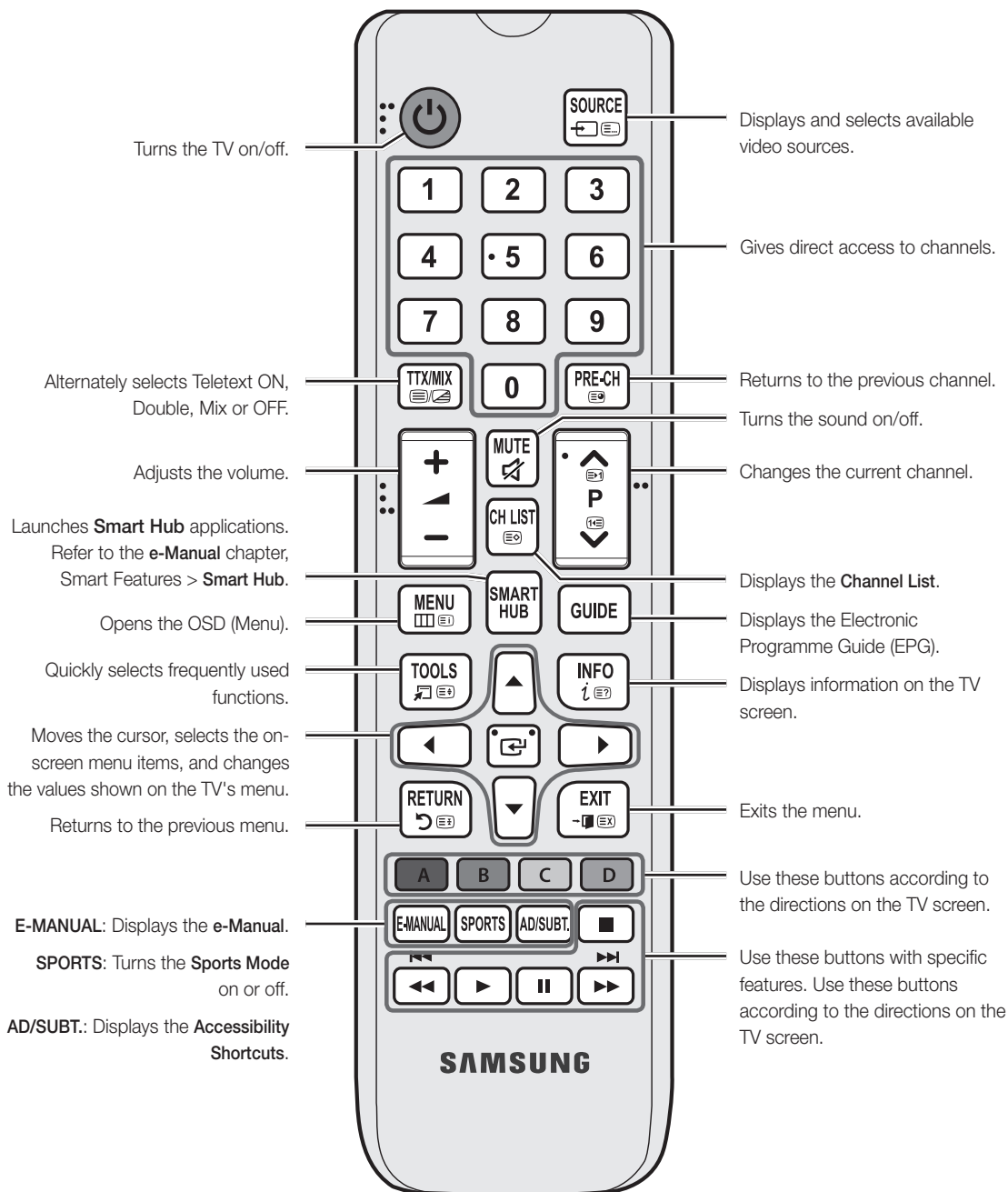

- The button names above may be differ from the actual names.

Installing batteries into the remote control

Match the polarity of the batteries to the symbols on the battery compartment.

- Use the remote control within 7m of the TV.
- Bright light may affect the performance of the remote control. Avoid using near bright fluorescent lights or neon signs.
- The colour and shape of the remote may vary depending on the model.

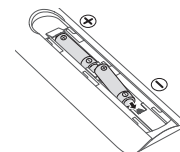

Connecting to a Network

Connecting the TV to a network gives you access to online services, such as **Smart Hub**, as well as software updates.

Network Connection - Wireless

Connect the TV to the Internet using a standard router or modem.

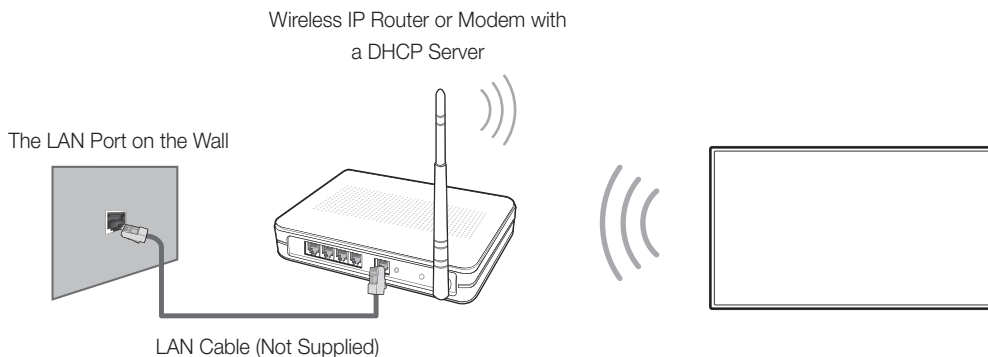

Network Connection - Wired

TV Rear Panel

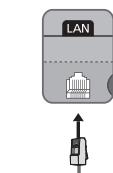

Connect your TV to your network using a LAN cable.

- The TV does not support the network speeds less than or equal to 10 Mbps.
- Use a Category 7 cable for the connection.

Mobile Network

Availability depends on the specific model and area.

While connecting to the mobile network, some functions might be unavailable.

Refer to the diagram and insert the Mobile Dongle (sold separately) into the USB port. The Mobile Dongle must be connected to the TV in order to connect to the mobile network. However, the Mobile Dongle is sold separately and is not available from Samsung.

If you have any problems using online services, please contact your Internet service provider.

- When you use a large mobile dongle(Data Card), USB devices may not work properly due to interferences among the USB ports, or the wireless network may not work properly due to interferences from the peripherals and surroundings. In this case, use a USB extension cable.

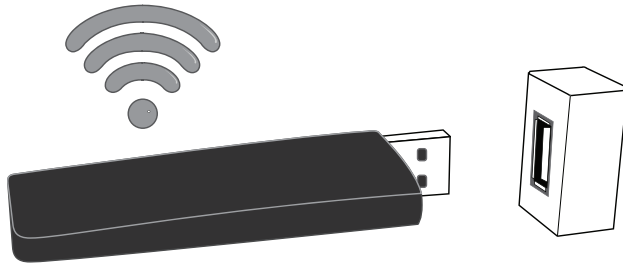

Supported Telecom and Model Name

For more information, refer to the **e-Manual**.

TV Camera Connection

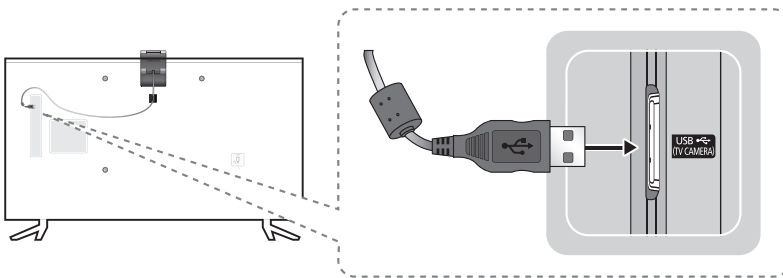

- The TV camera is sold separately.
- Make sure to connect only the TV camera to the TV CAMERA port.

The e-Manual

The embedded **e-Manual** contains information about the key features of your TV.

- You can download and view a printable version of the **e-Manual** on the Samsung website.

Displaying the **e-Manual**:

- On the Standard Remote Control, press the **E-MANUAL** button.
- On the TV's menu, select **Support > e-Manual**.

Using the buttons available on the main screen of the e-Manual

 (**Search**): Select an item from the search results to load the corresponding page.

 (**Index**): Select a topic from the list to navigate to the relevant page.

- Availability depends on the area or language.

 (**Recent pages**): Select a page. The **e-Manual** jumps to the selected page.

Accessing the associated menu screen from an e-Manual topic page

 (**Try Now**): Allows you to access the corresponding menu item and try out the feature right away.

 (**Link**): Allows you to access the corresponding reference page.

- The **e-Manual** cannot be accessed from some menu screens.

Updating the e-Manual to the latest version

You can update the **e-Manual** in the same way you update apps.

Troubleshooting and Maintenance

Troubleshooting

If the TV seems to have a problem, first review this list of possible problems and solutions. Alternatively, review the Troubleshooting Section in the **e-Manual**. If none of these troubleshooting tips apply, please visit “www.samsung.com” and click on Support, or contact the call centre listed on the back cover of this manual.

- This TFT LED panel is made up of sub pixels which require sophisticated technology to produce. There may be, however, a few bright or dark pixels on the screen. These pixels will have no impact on the performance of the product.
- To keep your TV in optimum condition, upgrade to the latest software. Use the Update Now or Auto Update functions on the TV's menu (**MENU > Support > Software Update > Update now** or **MENU > Support > Software Update > Auto update**).

Issues	Solutions and explanations
The TV is not powered on.	Make sure that the power cord is connected and that the remote has live batteries and is functioning properly. If the power cord is properly connected and the remote control is operating normally, there might arise a problem with the antenna cable connection, or the cable/set-top box might not be turned on. Check the antenna connection or turn on the cable/satellite box.
The TV won't turn on.	Make sure that the AC power cord is securely plugged in to the TV and the wall outlet. Make sure that the wall outlet is working. Try pressing the  button on the TV to make sure that the problem is not with the remote. If the TV turns on, refer to “The remote control does not work” below.
There is no picture/video.	Check the cable connections. Remove and reconnect all cables connected to the TV and external devices. Set the video outputs of your external devices (Cable/set-top box, DVD, Blu-ray etc) to match the TV's input connections. For example, if an external device's output is HDMI, connect it to an HDMI input on the TV. Make sure that your connected devices are powered on. Be sure to select the correct input source. Reboot the connected device by unplugging it and reconnecting the device's power cable.
The remote control does not work.	Replace the remote control batteries. Make sure that the batteries are installed with their poles (+/-) in the correct direction. Clean the sensor's transmission window on the remote. Try pointing the remote directly at the TV from 1.5 ~ 1.8 m away.
The Cable or set-top box remote control doesn't turn on/off the TV or adjust the volume.	Programme the cable or set-top box remote control to operate the TV. Refer to the Cable or set-top box user manual for the SAMSUNG TV code.

Eco Sensor and screen brightness

Eco Sensor adjusts the brightness of the TV automatically. This feature measures the light in your room and optimises the brightness of the TV automatically to reduce power consumption. If you want to turn this off, go to **MENU > System > Eco Solution > Eco Sensor**.

- If the screen is too dark while you are watching TV in a dark environment, it may be due to the **Eco Sensor**.
- Do not block the sensor with any object. This can decrease picture brightness.

Caring for the TV

- If a sticker was attached to the TV screen, some debris can remain after you remove the sticker. Please clean the debris off before watching TV.
- The exterior and screen of the TV can get scratched during cleaning. Be sure to wipe the exterior and screen carefully using a soft cloth to prevent scratches.

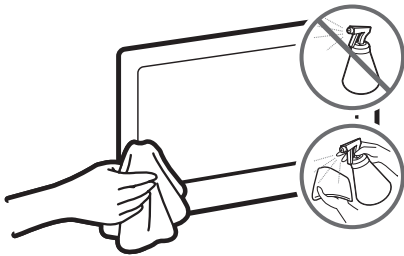

Do not spray water or any liquid directly onto the TV. Any liquid that goes into the product may cause a failure, fire, or electric shock.

Turn off the TV, then gently wipe away smudges and fingerprints on the screen with a micro-fiber cloth. Clean the body of the TV with a soft cloth dampened with a small amount of water. Do not use flammable liquids (benzene, thinners, etc.) or a cleaning agent. For stubborn smudges, spray a small amount of screen cleaner on the cloth.

Still image warning

Avoid displaying still images (such as jpeg picture files), still image elements (such as TV channel logos, stock or news crawls at the screen bottom etc.), or programmes in panorama or 4:3 image format on the screen. If you constantly display still pictures, it can cause image burn-in on the LED screen and affect image quality. To reduce the risk of this adverse effect, please follow the recommendations below:

- Avoid displaying the same TV channel for long periods.
- Always try to display any image in full screen. Use the picture format menu of the TV set for the best possible match.
- Reduce brightness and contrast to avoid the appearance of after-images.
- Use all TV features designed to reduce image retention and screen burn. Refer to the **e-Manual** for details.

TV Installation

Mounting the TV on a wall



If you mount this TV on a wall, follow the instructions exactly as set out by the manufacturer. Unless it is correctly mounted, the TV may slide or fall and cause serious injury to a child or adult and serious damage to the TV.

Installing the wall mount kit

You can mount the TV on the wall using a wall mount kit (sold separately).

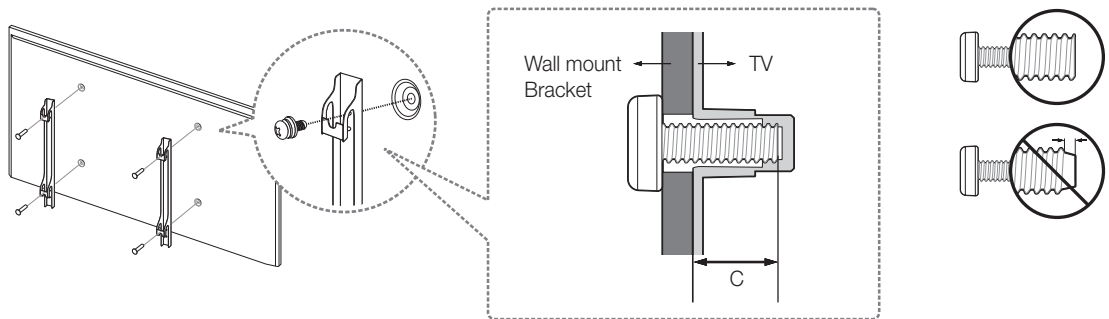

For detailed information about installing the wall mount, see the instructions provided with the wall mount kit. We recommend that you contact a technician for assistance when installing the wall mount bracket. We do not advise you to do it yourself. Samsung Electronics is not responsible for any damage to the product or injury to yourself or others if you choose to install the wall mount on your own.

VESA wall mount kit notes and specifications

You can install your wall mount on a solid wall perpendicular to the floor. Before attaching the wall mount to surfaces other than plaster board, contact your nearest dealer for additional information. If you install the TV on a ceiling or slanted wall, it may fall and result in severe personal injury.

Product Family	TV size in inches	VESA screw hole specs (A * B) in millimetres	C (mm)	Standard Screw	Quantity
UHD-TV	40	200 x 200	13.8 ~ 21.4	M8	4
	48	400 x 400			
	55				
	65				

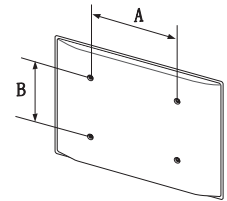

Do not install your wall mount kit while your TV is turned on. This may result in personal injury from electric shock.

- For wall mounts that do not comply with the VESA standard screw specifications, the length of the screws may differ depending on the wall mount specifications.
- Do not fasten the screws too firmly. This may damage the product or cause the product to fall, leading to personal injury. Samsung is not liable for these kinds of accidents.
- Samsung is not liable for product damage or personal injury when a non-VESA or non-specified wall mount is used or the consumer fails to follow the product installation instructions.
- Do not mount the TV at more than a 15 degree tilt.
- Always have two people mount the TV onto a wall.

Providing proper ventilation for your TV

When you install your TV, maintain a distance of at least 10 cm between the TV and other objects (walls, cabinet sides, etc.) to ensure proper ventilation. Failing to maintain proper ventilation may result in a fire or a problem with the product caused by an increase in its internal temperature.

When you install your TV with a stand or a wall mount, we strongly recommend you use parts provided by Samsung Electronics only. Using parts provided by another manufacturer may cause difficulties with the product or result in injury caused by the product falling.

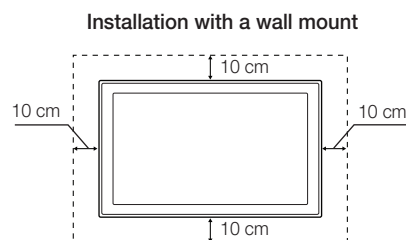
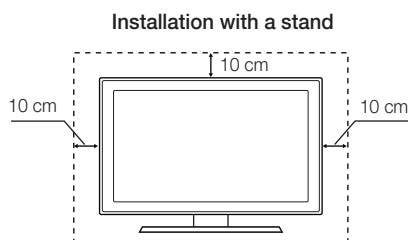

Attaching the TV to the Stand

Make sure you have all the accessories shown, and that you assemble the stand following the provided assembly instructions.

Safety Precaution: Securing the TV to the wall



Caution: Pulling, pushing, or climbing on the TV may cause the TV to fall. In particular, ensure your children do not hang on or destabilise the TV. This action may cause the TV to tip over, causing serious injuries or death. Follow all safety precautions provided in the Safety Flyer included with your TV. For added stability and safety, you can purchase and install the anti-fall device as described below.

Preventing the TV from falling

These are general instructions. The clamps, screws, and string are not supplied by Samsung. They must be purchased separately. We suggest consulting an installation service or professional TV installer for specific hardware and anti-fall hardware installation.

1. Put the screws into the clamps and firmly fasten them onto the wall.
Confirm that the screws have been firmly installed onto the wall.
 - You may need additional material such as an anchor depending on the type of wall.
2. Remove the screws from the back centre of the TV, put the screws into the clamps, and then fasten the screws onto the TV again.
 - These screws may not be supplied with the TV. For a 40-65 inch model, purchase M8 screws.
3. Connect the clamps fixed onto the TV and the clamps fixed onto the wall with a durable, heavy-duty string, and then tie the string tightly.
 - Install the TV near to the wall so that it does not fall backwards.
 - Connect the string so that the clamps fixed on the wall are at the same height as or lower than the clamps fixed on the TV.
 - Untie the string before moving the TV.
4. Make sure that all connections are properly secured. Periodically check the connections for any sign of fatigue or failure. If you have any doubt about the security of your connections, contact a professional installer.

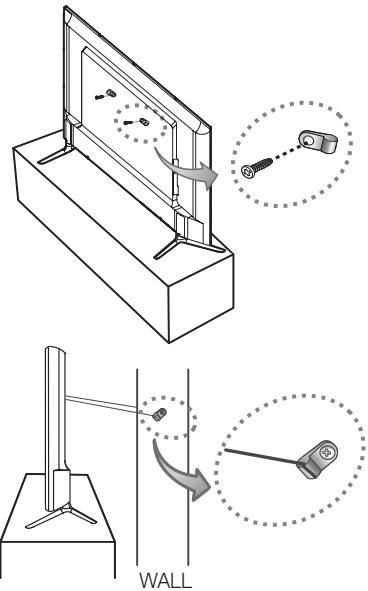

Specifications and Other Information

Specifications

Display Resolution	3840 × 2160	
Environmental Considerations		
Operating Temperature	10°C to 40°C (50°F to 104°F)	
Operating Humidity	10% to 80%, non-condensing	
Storage Temperature	-20°C to 45°C (-4°F to 113°F)	
Storage Humidity	5% to 95%, non-condensing	
Stand Swivel (Left / Right)	0°	
Sound(Output)	10W × 2	
Model Name	UA40JU6000	UA48JU6000
Screen Size (Diagonal)	102 cm	121 cm
Dimensions (W × H × D)		
Body	91.7 × 53.5 × 6.2 cm	108.7 × 63.0 × 6.3 cm
With Stand	93.1 × 59.6 × 20.1 cm	108.7 × 70.0 × 27.7 cm
Weight		
Without Stand	7.8 kg	11.0 kg
With Stand	8.0 kg	11.3 kg
Model Name	UA55JU6000	UA65JU6000
Screen Size (Diagonal)	139 cm	164 cm
Dimensions (W × H × D)		
Body	124.2 × 71.8 × 6.3 cm	146.3 × 84.4 × 6.4 cm
With Stand	124.2 × 78.7 × 27.7 cm	146.3 × 91.3 × 27.7 cm
Weight		
Without Stand	15.9 kg	23.9 kg
With Stand	16.2 kg	24.2 kg

- The design and specifications are subject to change without prior notice.
- For information about the power supply, and about power consumption, refer to the label attached to the product.

Decreasing power consumption

When you shut the TV off, it enters Standby mode. In Standby mode, it continues to draw a small amount of power. To decrease power consumption, unplug the power cord when you don't intend to use the TV for a long time.

Licences



HDMI

The terms HDMI and HDMI High-Definition Multimedia Interface, and the HDMI Logo are trademarks or registered trademarks of HDMI Licensing LLC in the United States and other countries.

For India only

This product is RoHS compliant.



This marking on the product, accessories or literature indicates that the product and its electronic accessories should not be disposed of with other household waste at the end of their working life. To prevent possible harm to the environment or human health from uncontrolled waste disposal, please separate these items from other types of waste and recycle them responsibly to promote the sustainable reuse of material resources.

For more information on safe disposal and recycling visit our website www.samsung.com/in or contact our Helpline numbers -18002668282, 180030008282.



Contact SAMSUNG WORLD WIDE

If you have any questions or comments relating to Samsung products, please contact the SAMSUNG customer care centre.

Country	Customer Care Centre ☎	Web Site
SINGAPORE	1800-SAMSUNG (726-7864)	www.samsung.com/sg/support
AUSTRALIA	1300 362 603	www.samsung.com/au/support
NEW ZEALAND	0800 726 786	www.samsung.com/nz/support
VIETNAM	1800 588 889	www.samsung.com/vn/support
THAILAND	0-2689-3232, 1800-29-3232	www.samsung.com/th/support
MYANMAR	+95-01-2399-888	www.samsung.com/support
MALAYSIA	1800-88-9999 603-77137477 (Overseas contact)	www.samsung.com/my/support
INDONESIA	021-56997777 08001128888	www.samsung.com/id/support
PHILIPPINES	1-800-10-7267864 [PLDT] 1-800-8-7267864 [Globe landline and Mobile] 02-4222111 [Other landline]	www.samsung.com/ph/support
TAIWAN	0800-329999	www.samsung.com/tw/support
JAPAN	0120-363-905	www.samsung.com/jp/support
INDIA	1800 3000 8282 - Toll Free 1800 266 8282 - Toll Free	www.samsung.com/in/support
BANGLADESH	9612300300	www.samsung.com/in/support
SRI LANKA	94117540540	www.samsung.com/support
EGYPT	08000-7267864 16580	www.samsung.com/eg/support
ALGERIA	021 36 11 00	www.samsung.com/n_africa/support
IRAN	021-8255 [CE]	www.samsung.com/iran/support
SAUDI ARABIA	8002474357	www.samsung.com/sa/support www.samsung.com/sa_en/support (English)
PAKISTAN	0800-Samsung (72678)	www.samsung.com/pk/support
TUNISIA	80-1000-12	www.samsung.com/n_africa/support
U.A.E	800-SAMSUNG (800 - 726 7864)	www.samsung.com/ae/support (English) www.samsung.com/ae_ar/support (Arabic)
OMAN	800-SAMSUNG (800 - 726 7864)	
KUWAIT	183-CALL (183-2255)	
BAHRAIN	8000-GSAM (8000-4726)	
QATAR	800-CALL (800-2255)	
TURKEY	444 77 11	www.samsung.com/tr/support
JORDAN	0800-22273 06 5777444	www.samsung.com/Levant/support (English)
SYRIA	18252273	www.samsung.com/Levant/support (English)
MOROCCO	080 100 22 55	www.samsung.com/n_africa/support

