

CyberPower[®]
Reliability. Quality. Value.

User Manual

Power Distribution Unit



CyberPower[®]
Reliability. Quality. Value.

4241 12th Ave E #400,
Shakopee, MN 55379
1-877-297-6937
www.CPSww.com

Table of Contents

Model List	1
PDU Naming Convention	1
Package Contents	2
Safety Precautions	2
Installation	3
Horizontal Installation	3
Vertical Installation with Brackets ...	4
Vertical Installation -	
Keyhole Mounts (0U models only) ...	5
Cord Retention Tray installation	5
Meter Configuration	5
Electrical Installation	6
Troubleshooting	6
Product Features	
Technical Specification	7
Basic Series	7
Metered Series	9
Basic Series (0U)	10
Metered Series (0U)	11
Warranty & Service	12

Model List:

Basic Series:

PDU15B8R	PDU20B8R	PDU20BT8R
PDU15B10R	PDU20B10R	PDU20BT10R
PDU15B12R	PDU20B12R	PDU20BT12R

PDU15B2F8R	PDU20B2F8R	PDU20BT2F8R
PDU15B2F10R	PDU20B2F10R	PDU20BT2F10R
PDU15B2F12R	PDU20B2F12R	PDU20BT2F12R
PDU15B4F8R	PDU20B4F8R	PDU20BT4F8R
PDU15B4F10R	PDU20B4F10R	PDU20BT4F10R
PDU15B4F12R	PDU20B4F12R	PDU20BT4F12R
PDU15B6F8R	PDU20B6F8R	PDU20BT6F8R
PDU15B6F10R	PDU20B6F10R	PDU20BT6F10R
PDU15B6F12R	PDU20B6F12R	PDU20BT6F12R

Metered Series:

PDU15M2F8R	PDU20M2F8R	PDU20MT2F8R
PDU15M2F10R	PDU20M2F10R	PDU20MT2F10R
PDU15M2F12R	PDU20M2F12R	PDU20MT2F12R

Basic Series (0U):

PDU15BV14F	PDU20BV14F	PDU20BVT14F
PDU15BV16F	PDU20BV16F	PDU20BVT16F
PDU15BV20F	PDU20BV20F	PDU20BVT20F
PDU15BV28F	PDU20BV28F	PDU20BVT28F
PDU15BV32F	PDU20BV32F	PDU20BVT32F

Metered Series (0U):

PDU15MV20F	PDU20MV20F	PDU20MVT20F
PDU15MV26F	PDU20MV26F	PDU20MVT26F
PDU15MV32F	PDU20MV32F	PDU20MVT32F

PDU Naming Convention:

PDU	XX	M	V	HV	T	F	R	NET
	1	2	3	4	5	6	7	8

- | | |
|------------------------|--|
| 1. Amperage: | Amperage – 15A, 20A, 30A |
| 2. Series: | B: =Basic M: =Metered
SW: = Switched |
| 3. Rack Space: | NULL: =Horizontal V:= Vertical |
| 4. Input Voltage: | NULL: =120V HV:= High Voltage – 200V to 230V |
| 5. Plug Type: | NULL: =NEMA 5-15P / 5-20P
T: = Twist (NEMA L5-L6 Plug)
IEC:= (IEC C14/C20) |
| 6. Outlet Number Front | Number of Outlets followed by F – Example 8F |
| 7. Outlet Number Rear | Number of Outlets followed by R – Example 8R |
| 8. Network Management | NET |

Package Contents

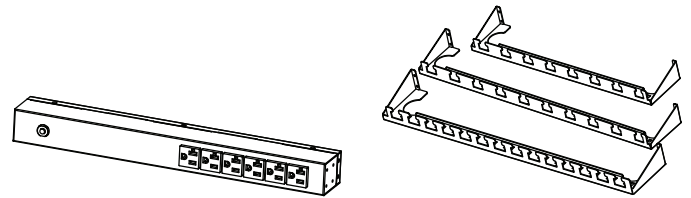

PDU (1)

Cord Retention Tray
(1/2/3/4 pcs - varies by model)

Mounting Brackets

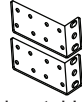

Horizontal Installation
Used (1 set)



Vertical Installation
Used (1 set)

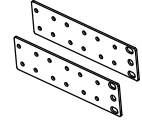

Vertical Mounting Brackets (1 set)
(for 0U models only)



Bracket Mounting
Screws M4 X 8 (4pcs)



Cord Retention Tray
Mounting Screws M3 X 6
(4/8/12/16 pcs - varies by model)

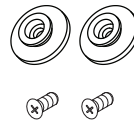

Keyhole Mounting Pegs (2pcs)
with Screws M4 X 8 (2pcs)
(for 0U models only)



Cord Retainer Clips (8/10/12/14/16/
20/24/30/32/38 pcs - varies by model)
for Cord Retention Tray



Ground Screw M4 X 6 (1 pcs)

Documentation:



User Manual



Product Registration Card



Check

Before using, please check to ensure the package contains all the items shown above. If there are missing parts please contact CyberPower technical support at www.CPSww.com or call 1-877-297-6937.

Safety Precautions -

Read the following before installing or operating the Power Distribution Unit (PDU):

1. Use only the supplied hardware to attach the mounting brackets.
2. The PDU must only be plugged into a three-wire, grounded outlet on a circuit protected by a fuse or circuit breaker. Connection to any other type of power outlet may result in a shock hazard.
3. Do not use extension cords or adapters with this PDU.
4. Never install a PDU, or associated wiring or equipment, during a lightning storm.
5. Check that the power cord, plug, and socket are in good condition.
6. **CAUTION!** To prevent the risk of fire or electric shock, this PDU should be installed in a temperature and humidity controlled indoor area free of conductive contaminants. Do not install this PDU where excessive moisture or heat is present..

Installation

Horizontal Installation (1U models only)

Step 1 – Mounting bracket installation

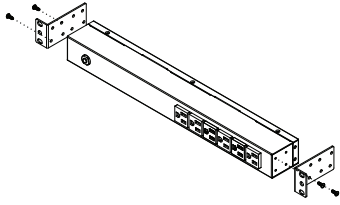

Install the screws (M4 X 8) in holes diagonal from each other.

Step 2 – PDU Mounting

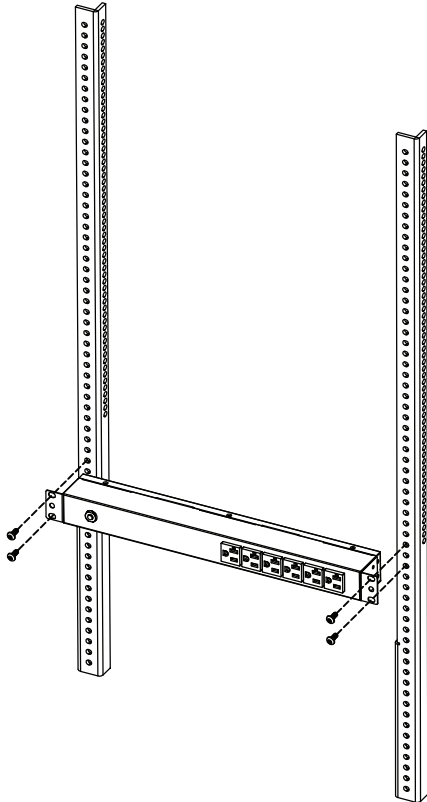

Install the PDU using fasteners compatible with the rack.

Vertical Installation with Brackets

Step 1 – Mounting bracket installation

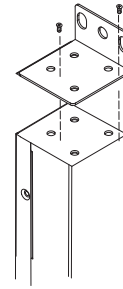

Install the screws (M4 X 8) in holes diagonal from each other.

Step 2 – PDU Mounting

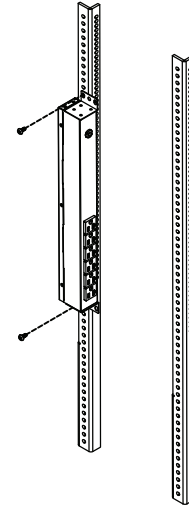

Install the PDU using fasteners compatible with the rack.

Vertical Installation with Brackets (0U models only)

Step 1 – Mounting bracket installation

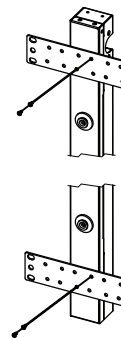

Attach the Vertical Mounting Brackets to the PDU with the 4 supplied Bracket Mounting Screws (M4 X 8).

Step 2 – PDU Mounting

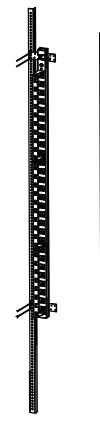

Install the PDU using fasteners compatible with the rack.

Vertical Installation with Keyhole Mounts (0U Models)

Step 1 – Keyhole Mount installation

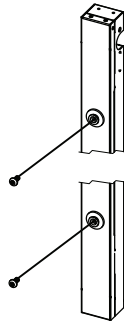

Attach the Keyhole Mounting Pegs to the PDU with the 2 supplied Bracket Mounting Screws (M4 X 8).

Step 2 – PDU Mounting

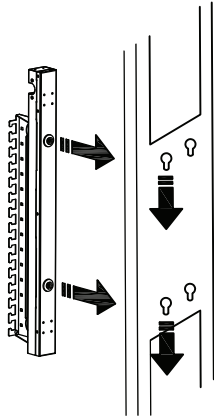

Align the the Keyhole Mounts to the Keyhole Slots on the rack. Insert and slide down to lock firmly into place.

Cord Retention Tray installation (Optional for both horizontal and vertical installations)

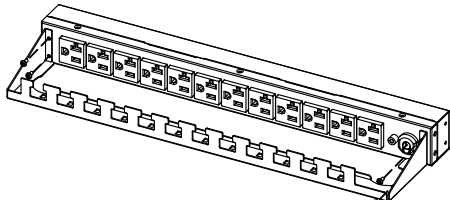

Attach the Cord Retention Tray to the PDU with the 4 supplied Cord Retention Tray Mounting Screws (M3 X 6).

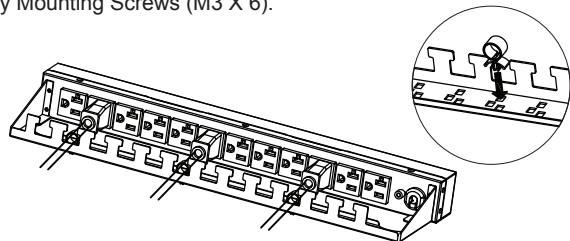

Attach the Cord Retainer Clips to the Cord Retention Tray.

Meter Configuration



Depending on installation method (vertical or horizontal), the LED Meter may need to be rotated, before installation, for proper orientation.

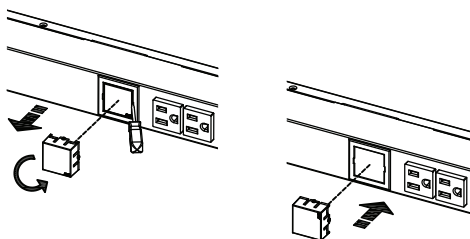

Use a screwdriver to gently remove the LED Meter. Rotate the LED Meter 90 degrees, and insert back into the PDU.

Electrical Installation

Step 1 – Receptacle evaluation

Ensure that the plug type of your PDU unit (e.g. NEMA 5-15P, NEMA 5-20P, NEMA L5-30P) matches the wall receptacle type that you are using.



PDU must be plugged into a three-wire, grounded wall receptacle only. The wall receptacle must also be connected to an appropriate branch circuit/main with fuse or circuit breaker protection. Connection to any other type of wall receptacle may result in a shock hazard.

Step 2 – Plug the PDU into the wall receptacle

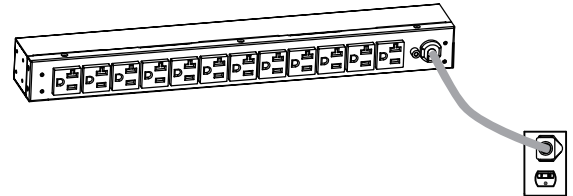

Step 3 – Attach equipment

Before attaching equipment, it is important to calculate the total load that you will be placing on the PDU. It is extremely important not to exceed the PDU's maximum current load (as outlined in the Specifications section). In order to determine your total load, simply add up the amperage of your devices and ensure that it does not exceed the unit's capacity.

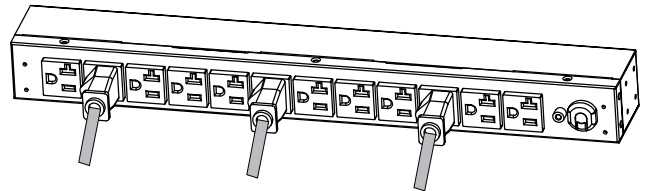

Troubleshooting

Problem	Possible Cause	Solution
PDU Outlets do not provide power to connected equipment	1. Open breaker 2. Loose power cord	Reset Breaker check if plug is completely connected. If the problem remains contact tech support.
Amperage displayed on Amperage Meter exceeds the unit's capability (Metered type only)	1. Overload 2. Amperage meter is damaged	The meter will flash when overloaded. Reduce the load on the PDU until the overload is gone. If the problem remains contact tech support.
Circuit breaker has tripped	1. Sustained overload 2. Excessive ambient or internal temperatures. 3. Faulty breaker	Reset Breaker. If the problem remains contact tech support.

Basic Series

Product Features

Front View

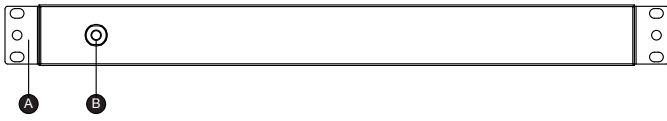

- A. Mounting Bracket
- B. Circuit Breaker

Back View

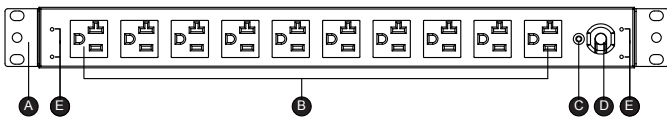

- A. Mounting Bracket
- B. Rear Outlets
- C. External Site Ground
- D. AC Power Cord
- E. Cord Retention Tray Screw Holes

Technical Specifications

Model Name	PDU15B8R PDU15B10R PDU15B12R	PDU20B8R PDU20B10R PDU20B12R	PDU20BT8R PDU20BT10R PDU20BT12R
Input			
Voltage	100 ~ 125 V		
Max current	15 A	20 A	
Circuit Breaker	15 A	20 A	
Plug Type	NEMA 5-15P	NEMA 5-20P	NEMA L5-20P
Power Cord Length	15 ft		
Output			
Voltage	100 ~ 125 V		
Current	15 A	20 A	
Outlet Type	NEMA 5-15R	NEMA 5-20R	
Indicators			
LED Indicators	N/A		
Meter Readout	N/A		
Physical			
Dimension (WxDxH)	17.5" x 1.5" x 1.75" / 44.5 x 3.81 x 4.45 cm		
Environmental			
Humidity	Operating 0 to 95% Non-condensing Non-Operating 0 to 95% Non-condensing		
Altitude	Operating 0ft to 10,000ft Non-Operating 0ft to 50,000ft		
Temperature	Operating 32F to 95F Non-Operating 5F to 113F		
Safety Approvals			
Certifications	ETL (test followed UL 1363) RoHS		
Warranty	Lifetime		

Basic Series

Product Features

Front View

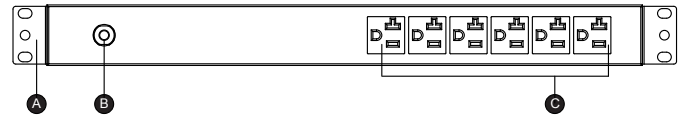

- A. Mounting Bracket
- B. Circuit Breaker
- C. Front Outlets

Back View

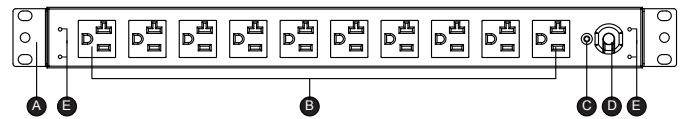

- A. Mounting Bracket
- B. Rear Outlets
- C. External Site Ground
- D. AC Power Cord
- E. Cord Retention Tray Screw Holes

Technical Specifications

Model Name	PDU15B2F8R PDU15B2F10R PDU15B2F12R PDU15B4F8R PDU15B4F10R PDU15B4F12R PDU15B6F8R PDU15B6F10R PDU15B6F12R	PDU20B2F8R PDU20B2F10R PDU20B2F12R PDU20B4F8R PDU20B4F10R PDU20B4F12R PDU20B6F8R PDU20B6F10R PDU20B6F12R	PDU20BT2F8R PDU20BT2F10R PDU20BT2F12R PDU20BT4F8R PDU20BT4F10R PDU20BT4F12R PDU20BT6F8R PDU20BT6F10R PDU20BT6F12R
Input			
Voltage	100 ~ 125 V		
Max current	15 A	20 A	
Circuit Breaker	15 A	20 A	
Plug Type	NEMA 5-15P	NEMA 5-20P	NEMA L5-20P
Power Cord Length	15 ft		
Output			
Voltage	100 ~ 125 V		
Current	15 A	20 A	
Outlet Type	NEMA 5-15R	NEMA 5-20R	
Indicators			
LED Indicators	N/A		
Meter Readout	N/A		
Physical			
Dimension (WxDxH)	17.5" x 2.25" x 1.75" / 44.5 x 5.72 x 4.45 cm		
Environmental			
Humidity	Operating 0 to 95% Non-condensing Non-Operating 0 to 95% Non-condensing		
Altitude	Operating 0ft to 10,000ft Non-Operating 0ft to 50,000ft		
Temperature	Operating 32F to 95F Non-Operating 5F to 113F		
Safety Approvals			
Certifications	ETL (test followed UL 1363) RoHS		
Warranty	Lifetime		

Metered Series

Product Features

Front View

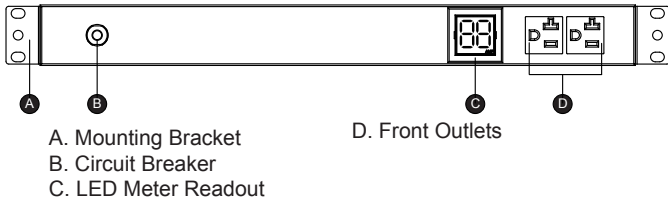

Back View

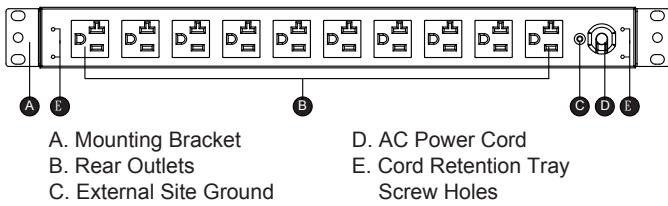

Technical Specifications

Model Name	PDU15M2F8R PDU15M2F10R PDU15M2F12R	PDU20M2F8R PDU20M2F10R PDU20M2F12R	PDU20MT2F8R PDU20MT2F10R PDU20MT2F12R
Input			
Voltage	100 ~ 125 V		
Max Current	15 A	20 A	
Circuit Breaker	15 A	20 A	
Plug Type	NEMA 5-15P	NEMA 5-20P	NEMA L5-20P
Power Cord Length	15 ft		
Output			
Voltage	100 ~ 125 V		
Current	15 A	20 A	
Outlet Type	NEMA 5-15R	NEMA 5-20R	
Filters & Protection			
EMI/RFI Filtration	N/A		
Surge Suppression	N/A		
Indicators			
LED Indicators	N/A		
Meter Readout	Amperage		
Physical			
Dimension (WxDxH)	17.5" x 2.25" x 1.75" / 44.5 x 5.72 x 4.45 cm		
Environmental			
Humidity	Operating 0 to 95% Non-condensing Non-Operating 0 to 95% Non-condensing		
Altitude	Operating 0ft to 10,000ft Non-Operating 0ft to 50,000ft		
Temperature	Operating 32F to 95F Non-Operating 5F to 113F		
Safety Approvals			
Certifications	ETL (test followed UL 1363) RoHS		
Warranty	Lifetime		

Basic Series (0U)

Product Features

Front View

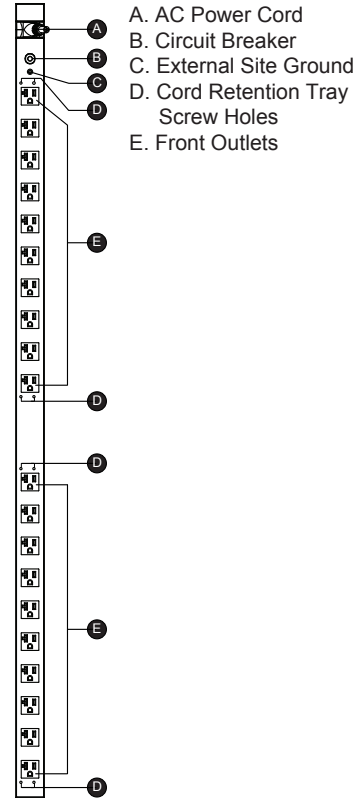

Back View

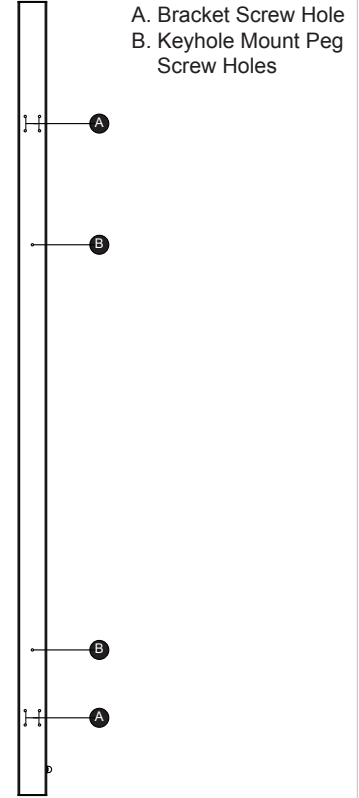

Technical Specifications

Model Name	PDU15BV14F PDU15BV16F PDU15BV20F PDU15BV28F PDU15BV32F	PDU20BV14F PDU20BV16F PDU20BV20F PDU20BV28F PDU20BV32F	PDU20BVT14F PDU20BVT16F PDU20BVT20F PDU20BVT28F PDU20BVT32F
Input			
Voltage	100 ~ 125 V		
Max Current	15 A	20 A	
Circuit Breaker	15 A	20 A	
Plug Type	NEMA 5-15P	NEMA 5-20P	NEMA L5-20P
Power Cord Length	10 ft		
Output			
Voltage	100 ~ 125 V		
Current	15 A	20 A	
Outlet Type	NEMA 5-15R	NEMA 5-20R	
Indicators			
LED Indicators	N/A		
Meter Readout	N/A		
Physical			
Dimension (WxDxH)	1.75" x 1.5" x 24" / 4.45 x 3.81 x 60.96 cm 1.75" x 1.5" x 36" / 4.45 x 3.81 x 91.44 cm 1.75" x 1.5" x 48" / 4.45 x 3.81 x 121.92 cm 1.75" x 1.5" x 60" / 4.45 x 3.81 x 152.40 cm 1.75" x 1.5" x 70" / 4.45 x 3.81 x 177.80 cm		
Environmental			
Humidity	Operating 0 to 95% Non-condensing Non-Operating 0 to 95% Non-condensing		
Altitude	Operating 0ft to 10,000ft Non-Operating 0ft to 50,000ft		
Temperature	Operating 32F to 95F Non-Operating 5F to 113F		
Safety Approvals			
Certifications	ETL (test followed UL 1363) RoHS		
Warranty	Lifetime		

Metered Series (0U)

Product Features

Front View

Back View

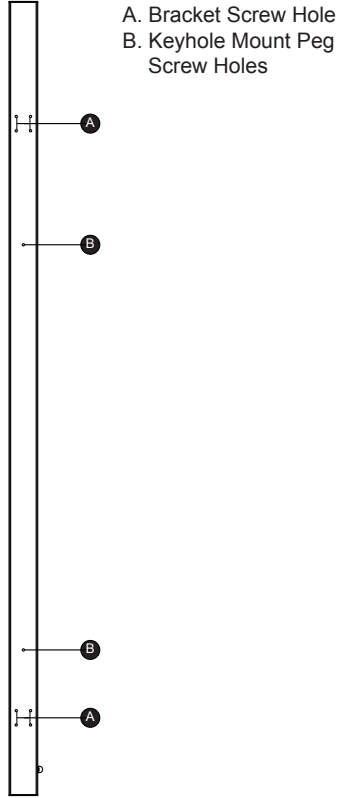
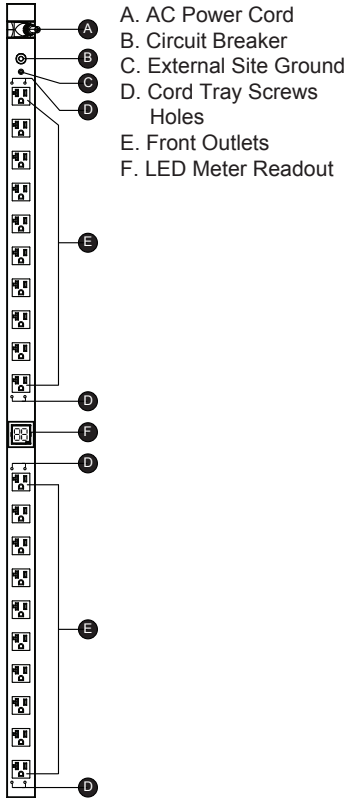

Technical Specifications

Model Name	PDU15MV20F PDU15MV26F PDU15MV32F	PDU20MV20F PDU20MV26F PDU20MV32F	PDU20MTV20F PDU20MTV26F PDU20MTV32F
Input			
Voltage	100 ~ 125 V		
Max Current	15 A	20 A	
Circuit Breaker	15 A	20 A	
Plug Type	NEMA 5-15P	NEMA 5-20P	NEMA L5-20P
Power Cord Length	10 ft		
Output			
Voltage	100 ~ 125 V		
Current	15 A	20 A	
Outlet Type	NEMA 5-15R	NEMA 5-20R	
Indicators			
LED Indicators	N/A		
Meter Readout	Amperage		
Physical			
Dimension (WxDxH)	1.75" x 2.25" x 48" / 4.45 x 5.72 x 121.92 cm 1.75" x 2.25" x 60" / 4.45 x 5.72 x 152.40 cm 1.75" x 2.25" x 70" / 4.45 x 5.72 x 177.80 cm		
Environmental			
Humidity	Operating 0 to 95% Non-condensing Non-Operating 0 to 95% Non-condensing		
Altitude	Operating 0ft to 10,000ft Non-Operating 0ft to 50,000ft		
Temperature	Operating 32F to 95F Non-Operating 5F to 113F		
Safety Approvals			
Certifications	ETL (test followed UL 1363) RoHS		
Warranty	Lifetime		

Product Registration

Thank you for purchasing a CyberPower product. Prompt product registration entitles coverage under the Limited Warranty, and also allows the opportunity to be notified of product enhancements, upgrades, and other announcements.

Registration is quick and easy at www.cpsww.com/register.

Need Additional Help?

Feel free to contact our Tech Support department with installation, troubleshooting, or general product questions.

CyberPower Technical Support
 Phone: 1-877-297-6937
 Email: tech@cpsww.com
 Web: www.CPSww.com
 Mail: 4241 12th Avenue E, Suite 400 Shakopee, MN 55379

Hours of Operation: Monday – Friday, 8:00am – 5:00pm (CST)

Limited Warranty

Read the following terms and conditions carefully before using the CyberPower PDU (the "Product"). By using the Product you consent to be bound by and become a party to the terms and conditions of this Limited Warranty (together referred to as this "Warranty"). If you do not agree to the terms and conditions of this Warranty, you should return the Product for a full refund prior to using it.

Who is Providing this Warranty?

CyberPower Systems (USA), Inc. ("CyberPower") provides this Limited Warranty.

What Does This Warranty Cover?

This warranty covers defects in materials and workmanship in the Product under normal use and conditions.

What is the Period of Coverage?

This Warranty is for as long as the original owner owns the Product.

Who Is Covered?

This warranty only covers the original purchaser. Coverage ends if you sell or otherwise transfer the Product.

How Do You Get Service?

1. Call us at (877) 297-6937 or write to us at Cyber Power Systems (USA), Inc., 4241 12th Ave. E., STE 400, Shakopee, MN 55379 or send us an e-mail message at claims@cyberpowersystems.com for instructions.
2. When you contact CyberPower, identify the Product, the Purchase Date, and the item(s) of Connected Equipment. Have information on all applicable insurance or other resources of recovery/payment that are available to the Initial Customer and Request a Claim Number.
3. You must provide a purchase receipt (or other proof of the original purchase) and provide a description of the defect.
4. Pack and ship the product to CyberPower and, if requested, the item(s) of Connected Equipment, a repair cost estimate for the damage to the Connected Equipment, and all claim forms that CyberPower provides to you. Show the Claim Number on the shipping label or include it with the product. You must prepay all shipping costs, you are responsible for packaging and shipment, and you must pay the cost of the repair estimate.

What Will We Do To Correct Problems?

CyberPower will inspect and examine the Product.

If the Product is defective in material or workmanship, CyberPower will repair or replace it at CyberPower's expense, or, if CyberPower is unable to or decides not to repair or replace the Product (if defective) within a reasonable time, CyberPower will refund to you the full purchase price you paid for the Product (purchase receipt showing price paid is required).

Who Pays For Shipping?

We pay when we send items to you; you pay when you send items to us.

What Are Some Things This Warranty Does Not Cover?

1. This Warranty does not cover any software that was damaged or needs to be replaced due to the failure of the Product or any data that is lost as a result of the failure or the restoration of data or records, or the reinstallation of software.
2. This Warranty does not cover or apply to: misuse, modification, operation or storage outside environmental limits of the Product or the equipment connected to it, nor for damage while in transit or in storage, nor if there has been improper operation or maintenance, or use with items not designed or intended for use with the Product, such as laser printers, appliances, aquariums, medical or life support devices, etc.

What are the Limitations?

1. This Warranty does not apply unless the Product and the equipment that was connected to it were connected to properly wired and grounded outlets (including compliance with electrical and safety codes of the most current electrical code), without the use of any adapters or other connectors.
2. The Product must have been plugged directly into the power source and the equipment connected to the Product must be directly connected to the Product and not "daisy-chained" together in serial fashion with any extension cords, another Product or device similar to the Product, surge suppressor, or power tap. Any such installation voids the Limited Warranty.
3. The Product and equipment connected to it must have been used properly in a suitable and proper environment and in conformance with any license, instruction manual, or warnings provided with the Product and the equipment connected to it.
4. The Product must have been used at all times within the limitations on the Product's VA capacity.
5. The sole and exclusive remedies of the Initial Customer are those provided by this Warranty.

Contact Information

CyberPower Systems, Inc.
4241 12th Ave. East
Suite 400
Shakopee, MN 55379
Phone: (952) 403-9500
Toll-free: (877) 297-6937

CyberPower is the warrantor under this Limited Warranty.
You may also contact CyberPower on the web at CPSww.com.