

User's Manual

DuraVision® FDF2305W

Color LCD Monitor

Important

Please read PRECAUTIONS, this User's Manual, and the Setup Guide (separate volume) carefully to familiarize yourself with safe and effective usage.

-
- Please refer to the Setup Guide for basic information ranging from connection of the monitor to a PC to using the monitor.
 - The latest User's Manual is available for download from our web site:
<http://www.eizo.com>
-



Location of Caution Statement

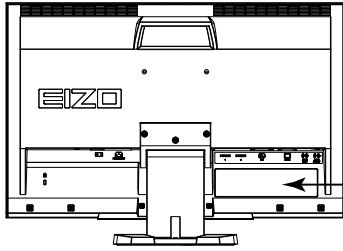



CAUTION
RISK OF ELECTRIC SHOCK. DO NOT OPEN.

ATTENTION
RISQUE DE CHOC ELECTRIQUE. NE PAS OUVRIR.

ACHTUNG
GEFAHR DES ELEKTRISCHEN SCHLAGES. RÜCKWAND NICHT ENTFERNEN.

小心
有触电的风险。请勿打开。

警告
感電の恐れあり、カバーをあけないでください。

The equipment must be connected to a grounded main outlet.
Jordet stikkontakt skal benyttes når apparatet tilkobles datanett.
Apparaten skall anslutas till jordat nätuttag.
这设备必须连接至接地主插座。
電源コードのアースは必ず接地してください。

<For USA-California Only>

CR Coin Lithium Battery contains Perchlorate Material - special handling may apply.

See www.dtsc.ca.gov/hazardouswaste/perchlorate.

This product has been adjusted specifically for use in the region to which it was originally shipped. If operated outside this region, the product may not perform as stated in the specifications.

No part of this manual may be reproduced, stored in a retrieval system, or transmitted, in any form or by any means, electronic, mechanical, or otherwise, without the prior written permission of EIZO Corporation. EIZO Corporation is under no obligation to hold any submitted material or information confidential unless prior arrangements are made pursuant to EIZO Corporation's receipt of said information. Although every effort has been made to ensure that this manual provides up-to-date information, please note that EIZO monitor specifications are subject to change without notice.

Notice for this monitor

This product is suited for displaying surveillance camera images.

This product has been adjusted specifically for use in the region to which it was originally shipped. If the product is used outside the region, it may not operate as specified in the specifications.

This product may not be covered by warranty for uses other than those described in this manual.

The specifications noted in this manual are only applicable when the following are used:

- Power cords provided with the product
 - Signal cables specified by us
-

Only use optional products manufactured or specified by us with this product.

It takes about 30 minutes for the performance of electrical parts to stabilize. Please wait 30 minutes or more after the monitor power has been turned on, and then adjust the monitor.

Monitors should be set to a lower brightness to reduce changes in luminosity caused by long-term use and maintain a stable display.

When the screen image is changed after displaying the same image for extended periods of time, an afterimage may appear. Use the screen saver or power save function to avoid displaying the same image for extended periods of time.

Periodic cleaning is recommended to keep the monitor looking new and to prolong its operation lifetime (refer to [“Cleaning” \(page 4\)](#)).

The LCD panel is manufactured using high-precision technology. Although, missing pixels or lit pixels may appear on the LCD panel, this is not a malfunction. Percentage of effective dots: 99.9994% or higher.

The backlight of the LCD panel has a fixed lifetime. When the screen becomes dark or begins to flicker, please contact your EIZO representative.

Do not press on the panel or edge of the frame strongly, as this may result in display malfunctions, such as interference patterns, etc. If pressure is continually applied to the panel, it may deteriorate or damage your panel. (If the pressure marks remain on the panel, leave the monitor with a black or white screen. The symptom may disappear.)

Do not scratch or press on the panel with any sharp objects, as this may result in damage to the panel. Do not attempt to brush with tissues as this may scratch the panel.

When the monitor is cold and brought into a room or the room temperature goes up quickly, dew condensation may occur on the interior and exterior surfaces of the monitor. In that case, do not turn the monitor on. Instead wait until the dew condensation disappears, otherwise it may cause some damage to the monitor.

Cleaning

Attention

- Chemicals such as alcohol and antiseptic solution may cause gloss variation, tarnishing, and fading of the cabinet or panel, and also quality deterioration of the image.
- Never use any thinner, benzene, wax, and abrasive cleaner, which may damage the cabinet or panel.

Note

- The optional ScreenCleaner is recommended for cleaning the cabinet and panel surface.

The stains on the cabinet and panel surface can be removed by moistening part of a soft cloth with water.

To use the monitor comfortably

- An excessively dark or bright screen may affect your eyes. Adjust the brightness of the monitor according to the environmental conditions.
- Staring at the monitor for a long time tires your eyes. Take a 10-minute rest every hour.

CONTENTS

Notice for this monitor	3	3-2. Switching sound source for HDMI signal input	29
Cleaning	4	3-3. To adjust the sound level	29
To use the monitor comfortably	4	3-4. Enabling/Disabling DDC/CI communication	29
CONTENTS	5	3-5. Locking Operation Buttons	30
Chapter 1 Introduction	7	3-6. Showing and hiding the EIZO logo	30
1-1. Features	7	3-7. Setting Language	30
1-2. Controls and Functions	8	3-8. Changing the authentication method for HDMI signal input	31
● Before Using Remote Control	9	3-9. Resetting the Monitor to the Default Settings	31
1-3. EIZO LCD Utility Disk	10	● To reset the color adjustments	31
● Disk contents and software overview	10	● To reset all adjustments to the default settings	32
1-4. Basic Operations and Functions	11	Chapter 4 Using Smart Function	33
● Basic operation of the Setting menu	11	4-1. Using Smart Function “Smart Detection” “Smart Resolution” “Smart Insight”	33
● Functions	12	Chapter 5 Power Saving Functions	36
Chapter 2 Adjusting Screens	13	5-1. Setting Power Saving	36
2-1. Compatible Resolutions/Formats	13	● Monitor	36
● Analog Input (D-Sub)	13	● To change the exiting method from the power saving mode	37
● Digital Input (DVI-D, HDMI: PC signal)	13	● Audio Output	37
● Digital Input (HDMI: video signal)	13	5-2. Setting Power Indicator	38
2-2. Setting the Resolution	14	5-3. Enabling/Disabling Automatic Brightness Adjustment “Auto EcoView”	38
2-3. Adjusting Color	15	5-4. Reducing Glare “EcoView Optimizer”	38
● To select the display mode (Color Mode)	15	5-5. Checking the power saving level	39
● To perform advanced adjustments	16	5-6. Enabling/Disabling Auto Power-OFF “Off Timer”	39
● Adjustable settings in each mode	16	Chapter 6 Connecting Cables	40
● To adjust brightness	17	6-1. Connecting Multiple External Devices	40
● Adjusting the brightness and color of black “Black Level”	17	● To switch among input signals	40
● To adjust contrast	17	6-2. Connecting External Speaker	41
● To adjust the color saturation	18	Chapter 7 Troubleshooting	42
● To adjust hue	18	7-1. No picture	42
● To adjust color temperature	19	7-2. Imaging problems (for both digital and analog)	43
● To adjust gamma	19	7-3. Imaging problems (for digital only)	43
● To adjust gain	20	7-4. Imaging problems (for analog only)	44
● To set the enhancement ratio of Contrast Enhancer	20	7-5. Other problems	45
● Enabling Overdrive	21	Chapter 8 Reference	46
2-4. Screen Adjustment	22	8-1. How to Attach the Optional Arm	46
● Digital Signal Input	22	8-2. Detaching/Attaching Stand Base	47
● Analog Signal Input	22	8-3. Attaching/Detaching Cable Holder	49
2-5. Screen Size Changing	26		
● Analog Input (D-Sub)/Digital Input (DVI-D, HDMI: PC signal)	26		
● Digital Input (HDMI: video signal)	27		
Chapter 3 Setting Monitor	28		
3-1. Adjusting Volume	28		
● To turn the volume up/down	28		
● To mute the sound temporarily	28		

8-4. Displaying Monitor Information	50
8-5. Specifications	51
8-6. Preset Timing	54
Chapter 9 Glossary	55
Appendix	58
Trademark	58
License / Copyright	58
FCC Declaration of Conformity	59
LIMITED WARRANTY	60
Recycling Information	69
China Measures for RoHS Compliance in ChinaRoHS	73

Chapter 1 Introduction

Thank you very much for choosing an EIZO color LCD monitor.

1-1. Features

- 23" wide format LCD
- Supports a resolution of 1920 × 1080
- HDMI connector × 2
- A Color Mode function that provides optimal display modes for video captured by surveillance cameras
See ["To select the display mode \(Color Mode\)" \(page 15\)](#).
- EIZO's unique "Smart" technology
 - Smart Insight function
This function analyzes the image and corrects the brightness for each pixel to make dark area of images visible.
 - Smart Resolution function
This function adjusts the perceived resolution of the images so that the blurs are reduced and images are displayed vividly and clearly.
 - Smart Detection function
This function allows the user to change the area on the screen to which the Smart Resolution or Smart Insight function is applied (only animated images or whole screen).
See ["Chapter 4 Using Smart Function" \(page 33\)](#).
- Remote control enables easy operation, setting and adjustment of the monitor.
See ["1-2. Controls and Functions" \(page 8\)](#).
- Standard VESA mounting holes
Wall mounting is also supported.
- Displays HDCP (High-bandwidth Digital Content Protection) protected contents.
- A 2-year long-term warranty for 24-hour continuous use.

1-2. Controls and Functions

Monitor

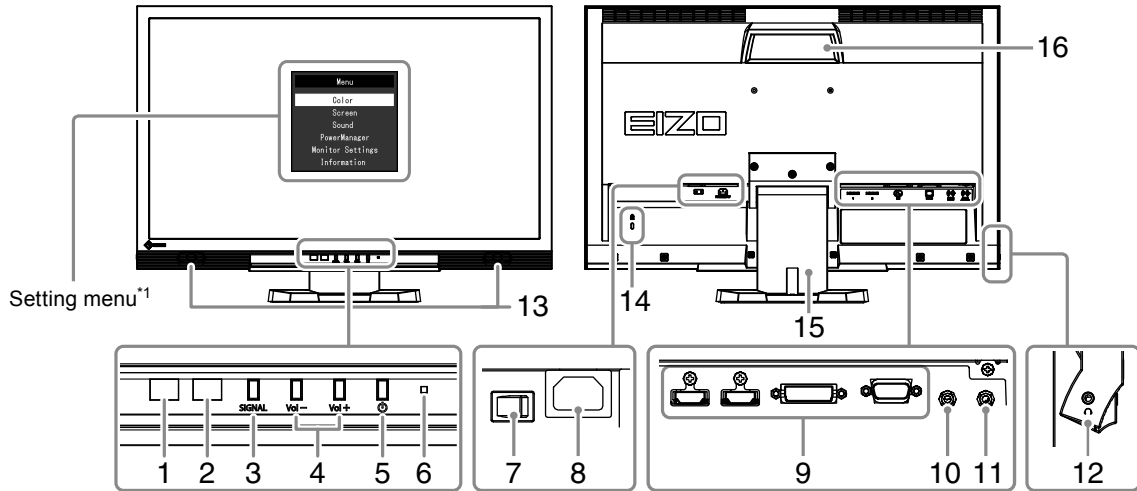

1. Auto EcoView sensor	Detects ambient brightness (Auto EcoView function (page 38), EcoView Optimizer function (page 38)).
2. Remote control detector	Receives the signal from the remote control.
3. SIGNAL button	Switches input signals for display (page 40). PC1 (DVI) → PC2 (D-SUB) → HDMI1 → HDMI2
4. Vol - / Vol + button	Displays the volume adjustment menu to volume up or down.
5. ⏻ button	Turns the power on or off.
6. Power indicator	Indicates the monitor's operation status. Blue: Operating Orange: Power saving mode Red: Power off OFF: Main power off
7. Main power switch	Turns the main power on or off.
8. Power connector	Connects the power cord.
9. Input signal connector	(Left: HDMI connector × 2 (HDMI1, HDMI2) / Center: DVI-D connector / Right: D-Sub mini 15-pin connector) Connects external devices such as a PC.
10. Line input connector	(Stereo mini jack) Connects external devices such as a PC.
11. Line output connector	(Stereo mini jack) Connects a speaker with built-in amplifier (page 41).
12. Headphone jack	Connects the headphones.
13. Speaker	Outputs audio source.
14. Security lock slot	Complies with Kensington's MicroSaver security system.
15. Stand^{*2}	Adjusts the height and angle (tilt and swivel) of the monitor.
16. Handle	Handle used for transportation Attention • Firmly grasp and hold the monitor by the bottom while grabbing the handle, and carefully convey the monitor so as not to drop it.

*1 See "Basic operation of the Setting menu" (page 11) for how to use.

*2 An optional arm (or an optional stand) can be attached by removing the stand (see "8-1. How to Attach the Optional Arm" (page 46)).

Remote Control

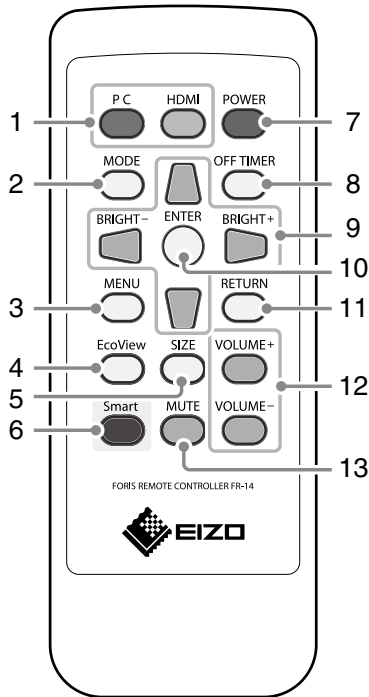

1. PC/HDMI	Switches input signals for display. <ul style="list-style-type: none"> PC: PC1 (DVI) ↔ PC2 (D-SUB) HDMI: HDMI1 ↔ HDMI2
2. MODE	Changes the color mode.
3. MENU	Displays/Exits the Setting menu.
4. EcoView	Displays/Exits "EcoView Menu".
5. SIZE	Changes the screen size.
6. Smart	Displays/Exits the "Smart Functions" menu.
7. POWER	Turns the power on or off.
8. OFF TIMER	Sets the time until the monitor power-off.
9.	<ul style="list-style-type: none"> Provides the menu selection as well as the adjustment and setting of a function. Displays the brightness adjustment menu (page 17).
10. ENTER	Determines an item on the menu screen, and saves values adjusted.
11. RETURN	Returns to the previous menu in menu operation.
12. VOLUME +/-	Adjusts the volume.
13. MUTE	Mutes sound temporarily.

● Before Using Remote Control

How to install battery

1. On the back of the remote control, slide the battery cover off in the direction of an arrow.
2. Insert a battery with the positive side up. (Battery model number: CR2025)
3. Reattach the cover.

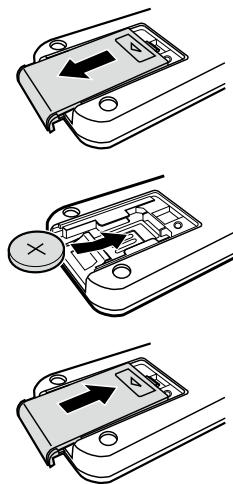

Receivable Range of Remote Control

Use the remote control inside of the range as below.

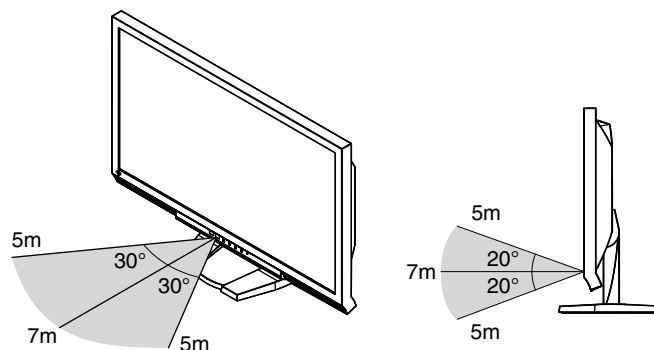

1-3. EIZO LCD Utility Disk

An “EIZO LCD Utility Disk” (CD-ROM) is supplied with this product. The following table shows the disk contents and the overview of the software programs.

● Disk contents and software overview

The disk includes software programs for adjustment, and User’s Manual. Refer to Readme.txt file on the disk for software startup procedures or file access procedures.

Item	Overview	Windows	Macintosh
Screen adjustment pattern files	Used when adjusting the image of analog signal input manually.	√	√
User’s Manual of this monitor (PDF file)		√	√
A Readme.txt file		√	√

1-4. Basic Operations and Functions



● Basic operation of the Setting menu

1. Displaying the Setting menu

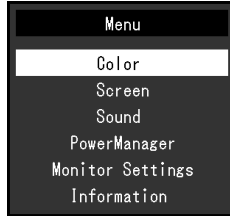

1. Press MENU on the remote control. The Setting menu appears.

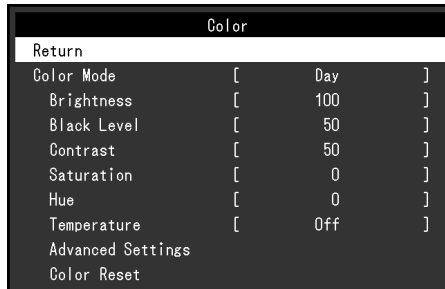

2. Adjusting/Setting

1. Choose a menu to adjust/set with , , and then press ENTER. The Sub menu appears.



2. Choose an item to adjust/set with , , and then press ENTER. The adjustment/setting menu appears.



3. Adjust/set the selected item with , , , , and then press ENTER.

3. Exiting

1. Press MENU.

Note

- To go back to the previous menu, press RETURN.
-

● Functions

The following table shows the Setting menu and setting items of each menu.

Main menu	Setting	Reference	
Color ^{*1}	Color Mode	“2-3. Adjusting Color” (page 15) (Regarding “Smart Functions”, see “Chapter 4 Using Smart Function” (page 33).)	
	Brightness		
	Black Level		
	Contrast		
	Saturation		
	Hue		
	Temperature		
	Advanced Settings		Gamma
			Gain
			ContrastEnhancer
Smart Functions			
Overdrive			
Color Reset	“3-9. Resetting the Monitor to the Default Settings” (page 31)		
Screen	Auto Screen Adjust ^{*2}	“2-4. Screen Adjustment” (page 22)	
	Auto Range Adjust ^{*2}		
	Clock ^{*2}		
	Phase ^{*2}		
	Position ^{*2}		
	Color Space ^{*3}		
	Smoothing		
Sound	Source ^{*3}	“3-2. Switching sound source for HDMI signal input” (page 29)	
	Sound Level	“3-3. To adjust the sound level” (page 29)	
	Power Save	“5-1. Setting Power Saving” (page 36)	
PowerManager	Power Save	“5-1. Setting Power Saving” (page 36)	
Monitor Settings	DDC/CI	“3-4. Enabling/Disabling DDC/CI communication” (page 29)	
	Key Lock	“3-5. Locking Operation Buttons” (page 30)	
	Logo	“3-6. Showing and hiding the EIZO logo” (page 30)	
	Power Indicator	“5-2. Setting Power Indicator” (page 38)	
	Language	“3-7. Setting Language” (page 30)	
	Reset	“3-9. Resetting the Monitor to the Default Settings” (page 31)	
Information		“8-4. Displaying Monitor Information” (page 50)	

*1 The adjustment/settings available on the “Color” menu depend on the selected Color mode. The above table shows the sub menus when the Day or Night mode is selected.

*2 These functions can be adjusted with analog input.

*3 This function is available with HDMI signal input.

Chapter 2 Adjusting Screens

2-1. Compatible Resolutions/Formats

The monitor supports the following resolutions and signal format.

● Analog Input (D-Sub)

Resolution	Vertical Scan Frequency
640 × 480	up to 75 Hz
720 × 400	70 Hz
800 × 600	up to 75 Hz
1024 × 768	up to 75 Hz
1280 × 720	60 Hz
1280 × 960	60 Hz
1280 × 1024	up to 75 Hz
1680 × 1050	60 Hz
1920 × 1080 ^{*1}	60 Hz

● Digital Input (DVI-D, HDMI: PC signal)

Resolution	Vertical Scan Frequency
640 × 480	60 Hz
720 × 400	70 Hz
800 × 600	60 Hz
1024 × 768	60 Hz
1280 × 720	60 Hz
1280 × 960	60 Hz
1280 × 1024	60 Hz
1680 × 1050	60 Hz
1920 × 1080 ^{*1}	60 Hz

*1 Recommended resolution

● Digital Input (HDMI: video signal)

- Video signal

Formats	Vertical Scan Frequency	
	50 Hz	60 Hz
VGA	-	√
480p	-	√
480i	-	√
576p	√	-
576i	√	-
720p	√	√
1080p	√	√
1080i	√	√

- Audio signal
 - 2ch linear PCM (32 kHz / 44.1 kHz / 48 kHz)

2-2. Setting the Resolution

When you connect the monitor to the PC and find that the resolution is improper, or when you want to change the resolution, follow the procedure below.

Windows 8.1 / Windows 8 / Windows 7

1. For Windows 8.1 / Windows 8, click the “Desktop” tile on the Start Screen to display the desktop.
2. Right-click the mouse anywhere on the desktop except for icons.
3. From the displayed menu, click “Screen resolution”.
4. On the “Screen Resolution” dialog box, select the monitor.
5. Click “Resolution” to select the desired resolution.
6. Click the [OK] button.
7. When a confirmation dialog box is displayed, click [Keep changes].

Windows Vista

1. Right-click the mouse anywhere on the desktop except for icons.
2. From the displayed menu, click “Personalize”.
3. On the “Personalization” window, click “Display Settings”.
4. On the “Display Settings” dialog box, select the “Monitor” tab and select desired resolution in the “Resolution” field.
5. Click the [OK] button.
6. When a confirmation dialog box is displayed, click [Yes].

Mac OS X

1. Select “System Preferences” from the Apple menu.
2. When the “System Preferences” dialog box is displayed, click “Displays” for “Hardware”.
3. On the displayed dialog box, select the “Display” tab and select desired resolution in the “Resolutions” field.
4. Your selection will be reflected immediately. When you are satisfied with the selected resolution, close the window.

2-3. Adjusting Color

● To select the display mode (Color Mode)

This function allows easy selection of a desired mode according to monitor application.

Display Modes

Mode	Purpose
Day	Suitable for displaying common video captured by surveillance cameras.
Night	Suitable for displaying monochrome video such as that captured at night by surveillance cameras.
sRGB	Suitable for color matching with sRGB compatible peripherals.

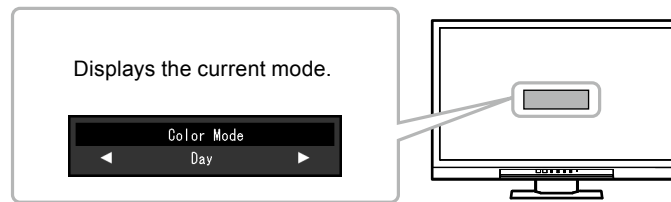

Procedure

1. Press MODE on the remote control.
The mode name appears at the center of the screen.
2. The mode among the list is highlighted in turn each time MODE is pressed.
You can switch the current mode with ◀ or ▶ while the mode menu is being displayed.

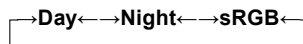

Note

- The Setting menu and the Mode menu cannot be displayed at the same time.

● To perform advanced adjustments

The “Color” menu of the Setting menu allows you to set and save the independent color adjustment for each mode.

Attention

- It takes about 30 minutes for the performance of electrical parts to stabilize. Please wait 30 minutes or more after the monitor power has been turned on, and then adjust the monitor.
- Perform the range adjustment first when adjusting color for analog signals (see [“To adjust color gradation automatically” \(page 25\)](#)).
- The same image may be seen in different colors on multiple monitors due to their monitor-specific characteristics. Make fine color adjustment visually when matching colors on multiple monitors.

● Adjustable settings in each mode

The adjustable settings depend on the mode. (Non-adjustable or non-settable function cannot be selected.)

For instructions on how to adjust or set each function, refer to subsequent pages. (Regarding “Smart Functions”, see [“Chapter 4 Using Smart Function” \(page 33\)](#).)

√: Adjustable -: Not adjustable

Function		Color Mode			
		Day	Night	sRGB	
Brightness		√	√	√	
Black Level		√	√	-	
Contrast		√	√	-	
Saturation		√	√	-	
Hue		√	√	-	
Temperature		√	√	-	
Advanced Settings	Gamma	√	√	-	
	Gain	√	√	-	
	Contrast Enhancer	√	√	-	
	Smart Functions		√	√	-
	Smart Detection				
	Smart Resolution				
	Smart Insight				
Overdrive		√	√	-	
Color Reset		√	√	√	





● To adjust brightness

The screen brightness is adjusted by changing the brightness of the backlight (light source from the LCD back panel).

Adjustable range

0 to 100

Procedure

1. Press  or .
- The Brightness menu appears.
2. Use  or  for adjustment.
3. Press ENTER to exit.

Note

- If you feel that the image is too dark even if the brightness is set to 100, adjust the contrast.
 - Alternatively, you can use “Brightness” under “Color” in the Adjustment menu to adjust it.
-



● Adjusting the brightness and color of black “Black Level”

You can adjust the brightness and chromaticity of black by adjusting the black level of red, green, and blue respectively. Please use a black test pattern or background for adjustment of the black level.

Adjustable range

0 to 100

Procedure

1. Choose “Color” in the Setting menu, and press ENTER .
2. Choose “Black Level” in the “Color” menu, and press ENTER .
- The “Black Level” menu appears.
3. Use  or  for adjustment.
4. Press ENTER to exit the adjustment.

Note

- After completing black level adjustment, readjust the contrast as appropriate.
-



● To adjust contrast

The brightness of the screen is adjusted by varying the video signal level.

Adjustable range

0 to 100

Procedure

1. Choose “Color” in the Setting menu, and press ENTER.
2. Choose “Contrast” in the “Color” menu, and press ENTER.
- The “Contrast” menu appears.
3. Use  or  for adjustment.
4. Press ENTER to exit the adjustment.

Note

- In the contrast of 50, every color gradation is displayed (for PC input signal only).
 - When adjusting the monitor, it is recommended to perform the brightness adjustment which may not lose the gradation characteristics, prior to the contrast adjustment.
 - Perform the contrast adjustment in the following cases.
 - When you feel the image is too dark even if the brightness is set to 100 (Set the contrast to higher than 50.)
-



● To adjust the color saturation

This function allows you to adjust color saturation.

Adjustable range

-50 to 50

Procedure

1. Choose "Color" in the Setting menu, and press ENTER.
2. Choose "Saturation" in the "Color" menu, and press ENTER.
The "Saturation" menu appears.
3. Use  or  for adjustment.
4. Press ENTER to exit the adjustment.

Attention

- Using this function may make some color gradations unavailable for display.

Note

- The minimum value (-50) changes the screen to monochrome.
-



● To adjust hue

This function allows you to adjust hue.

Adjustable range

-50 to 50

Procedure

1. Choose "Color" in the Setting menu, and press ENTER.
2. Choose "Hue" in the "Color" menu, and press ENTER.
The "Hue" menu appears.
3. Use  or  for adjustment.
4. Press ENTER to exit the adjustment.

Attention

- Using this function may make some color gradations unavailable for display.
-

● To adjust color temperature

Color temperature can be adjusted.

The color temperature is normally used to express the hue of “White” and/or “Black” by a numerical value. The value is expressed in degrees “K” (Kelvin).

The screen becomes reddish at a low color temperature, and bluish at a high color temperature, like the flame temperature. A gain preset value is set for each color temperature setting value.



Adjustable range

Off, 4000K-10000K (specified by every 500K unit, including 9300K)

Procedure

1. Choose “Color” in the Setting menu, and press ENTER.
2. Choose “Temperature” in the “Color” menu, and press ENTER.

The “Temperature” menu appears.

3. Use  or  for adjustment.
4. Press ENTER to exit the adjustment.

Note

- The value shown in “K” is available only as reference.
 - “Gain” allows you to perform more advanced adjustment (see [“To adjust gain” \(page 20\)](#)).
 - If you set to “Off”, the image is displayed in the preset color of the monitor (Gain: 100 for each RGB).
 - When gain is changed, the color temperature is changed to “Off”.
-

● To adjust gamma

Gamma can be adjusted. The brightness of the monitor varies depending on the input signal, however, the variation rate is not proportional to the input signal. To keep the balance between the input signal and the brightness of the monitor is called as “Gamma correction”.



Adjustable range

1.8, 2.0, 2.2, 2.4, 2.6, 2.8, Power

Procedure

1. Choose “Color” in the Setting menu, and press ENTER.
2. Choose “Advanced Settings” in the “Color” menu, and press ENTER.
3. Choose “Gamma” in the “Advanced Settings” menu, and press ENTER.

The “Gamma” menu appears.

4. Use  or  for adjustment.
5. Press ENTER to exit the adjustment.

Note

- Choosing “Power” will help to sharpen halftone images by increasing their contrast.
-

● To adjust gain

The brightness of each color component red, green, and blue is called “Gain”. You can change the hue of “white” by adjusting gain.



Adjustable range

0 to 100

Procedure

1. Choose “Color” in the Setting menu, and press ENTER.
2. Choose “Advanced Settings” in the “Color” menu, and press ENTER.
3. Choose “Gain” in the “Advanced Settings” menu, and press ENTER.

The “Gain” menu appears.

4. Adjust gain with  or  for each of red, green, and blue.
5. Press ENTER to exit the adjustment.

Attention

- Using this function may make some color gradations unavailable for display.

Note

- The value of gain changes with that of color temperature.
 - When gain is changed, the color temperature is changed to “Off”.
-

● To set the enhancement ratio of ContrastEnhancer

This function allows you to automatically adjust the contrast according to the darkness or brightness of an image and change in scenes. You can set the level of the adjustment.



Adjustable range

Enhanced, Standard, Off

Procedure

1. Choose “Color” in the Setting menu, and press ENTER.
2. Choose “Advanced Settings” in the “Color” menu, and press ENTER.
3. Choose “ContrastEnhancer” in the “Advanced Settings” menu, and press ENTER.

The “ContrastEnhancer” menu appears.

4. Use  or  for adjustment.
5. Press ENTER to exit the adjustment.

Attention

- Using this function may make some color gradations unavailable for display.
-

● Enabling Overdrive

This function allows you to turn on overdrive in order to reduce image lag when displaying fast moving images.



Adjustable range

Standard, Off

Procedure

1. Choose “Color” in the Setting menu, and press ENTER.
2. Choose “Advanced Settings” in the “Color” menu, and press ENTER.
3. Choose “Overdrive” in the “Advanced Settings” menu, and press ENTER.

The “Overdrive” menu appears.

4. Use  or  for adjustment.
5. Press ENTER to exit the adjustment.

2-4. Screen Adjustment

● Digital Signal Input

When digital signals are input, images are displayed correctly based on the preset data of the monitor, but if characters and/or lines appear blurred, go to “[6. Modify blurred characters or lines.](#)” (page 25).

When performing more advanced adjustment, see “[2-3. Adjusting Color](#)” (page 15) and subsequent pages.

● Analog Signal Input

Attention

- It takes about 30 minutes for the performance of electrical parts to stabilize. Please wait 30 minutes or more after the monitor power has been turned on, and then adjust the monitor.
 - The Self Adjust (automatic screen adjustment) function does not work for the images under the resolution of 800 × 600 (SVGA).
 - The self adjustment (or automatic screen adjustment) function works correctly when an image is fully displayed over the Windows or Macintosh display area. They do not work properly in the cases below:
 - When an image is displayed only on a part of the screen (command prompt window, for example)
 - When a black background (wallpaper, etc.) is in useAlso, these functions cannot work properly in some graphic boards.
-

The monitor screen adjustment is used to suppress flickering of the screen or adjust screen position and screen size correctly according to the PC to be used.

Note

- The Self Adjust function works when all of the following conditions are satisfied:
 - When a signal is input into the monitor for the first time or when a resolution or vertical/horizontal scan frequency not used before is set
-



If the screen is not displayed correctly even after performing the Self Adjust operation, adjust the screen according to the procedures on the following pages to use the monitor comfortably.

Setting Procedures

1. Perform the auto adjustment.

● To adjust flickering, screen position, and screen size automatically

Procedure

1. Choose “Screen” in the Setting menu, and press ENTER.
2. Choose “Auto Screen Adjust” in the “Screen” menu, and press ENTER.
3. Select “Yes” with  or , and press ENTER.

Flickering, screen position, and screen size are corrected by the auto-adjustment function.

If the screen is not displayed correctly even after performing the auto adjustment, perform adjustments according to the following procedure. If the screen is displayed correctly, go to “[5. Adjusting color gradation.](#)” (page 25).

2. Prepare to use analog screen adjustment patterns.

Load the “EIZO LCD Utility Disk” to your PC, and then open the “Screen adjustment pattern files”.

Note

- For details and instructions on opening the “Screen adjustment pattern files”, refer to the Readme.txt file.



3. Perform the auto adjustment again with the analog screen adjustment pattern displayed.

● To adjust flickering, screen position, and screen size automatically

Procedure

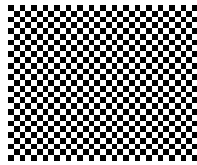
1. Display Pattern 1 in full screen on the monitor using the “Screen adjustment pattern files”.



2. Choose “Screen” in the Setting menu, and press ENTER.
3. Choose “Auto Screen Adjust” in the “Screen” menu, and press ENTER.
4. Select “Yes” with  or , and press ENTER.

Flickering, screen position, and screen size are corrected by the auto-adjustment function.

If the screen is not displayed correctly even after performing the auto adjustment, perform adjustments according to the following procedure. If the screen is displayed correctly, go to [“5. Adjusting color gradation.”](#) (page 25).

4. Choose “Screen” from the Setting menu to perform advanced adjustments.



Adjust the clock, phase and position, in this order.



● To eliminate vertical bars

Procedure

1. Choose “Clock” in the “Screen” menu, and press ENTER.

The “Clock” menu appears.

2. Adjust the clock with  or  to eliminate vertical bars.

Press  or  slowly so as not to miss the adjustment point.

3. Press ENTER to exit the adjustment.

When blurring, flickering or bars appear on the screen after adjustment, proceed to “Phase” to remove flickering or blurring.

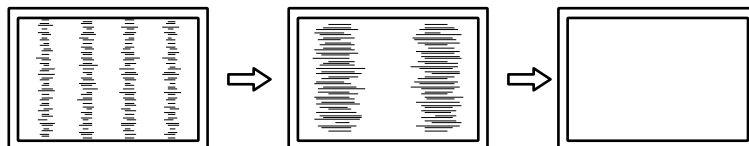

● To remove flickering or blurring

Procedure

1. Choose “Phase” in the “Screen” menu, and press ENTER.
The “Phase” menu appears.
2. Adjust the phase with ◀ or ▶ to minimize flickering or blurring.
3. Press ENTER to exit the adjustment.
When vertical bars appear on the screen after adjustment, go back to “To eliminate vertical bars”.
(Clock → Phase → Position)

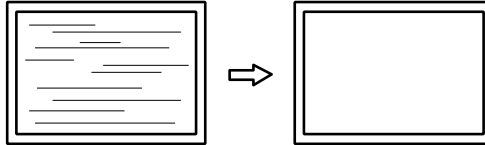

Attention

- Flickering or blurring may not be eliminated depending on your PC or graphics board.
-

● To correct the screen position

Note

- Since the number of pixels and the pixel positions are fixed on the LCD monitor, only one position is provided to display images correctly. The position adjustment is made to shift an image to the correct position.
-

Procedure

1. Choose “Position” in the “Screen” menu, and press ENTER.
The “Position” menu appears.
2. Adjust the position with ◀ / ▲ / ▼ / ▶.
3. Press ENTER to exit the adjustment.

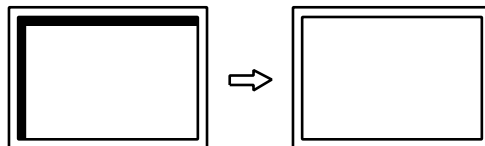

4. Close Pattern 1.

5. Adjusting color gradation.



● To adjust color gradation automatically

Every color gradation (0 to 255) can be displayed by adjusting the signal output level.

Procedure

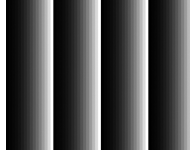
1. Display Pattern 2 in full screen on the monitor using the “Screen adjustment pattern files”.



2. Choose “Screen” in the Setting menu, and press ENTER.
3. Choose “Auto Range Adjust” in the “Screen” menu, and press ENTER.
4. Select “Yes” with  or , and press ENTER.
The output range is set automatically.
5. Close Pattern 2.

6. Modify blurred characters or lines.

● To modify blurred characters/lines

When an image is displayed with a resolution other than recommended, the characters or lines of the displayed image may blur.



Attention

- Smoothing setting may not be required depending on the display resolution. (You cannot choose the smoothing icon.)
-

Adjustable range

1 to 5

Procedure

1. Choose “Screen” in the Setting menu, and press ENTER.
2. Choose “Smoothing” in the “Screen” menu, and press ENTER.
The “Smoothing” menu appears.
3. Use  or  for adjustment.
4. Press ENTER to exit the adjustment.

2-5. Screen Size Changing

● Analog Input (D-Sub)/Digital Input (DVI-D, HDMI: PC signal)

The image with the resolution other than the recommended resolution is displayed in full screen automatically. You can change the screen size by using the “Screen Size” function.

Setting	Function
Full Screen	Displays an image in full screen. Images are distorted in some cases because the vertical rate is not equal to the horizontal rate.
Enlarged	Displays an image in full screen. In some cases, a blank horizontal or vertical border appears to equalize the vertical rate and the horizontal rate.
Normal	Displays images with the specified resolution.

Example: Image size 1024 × 768

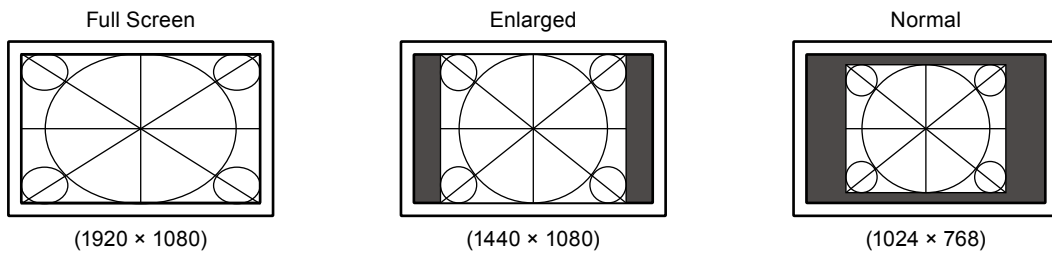

Procedure

1. Press SIZE on the remote control.
Each time you press SIZE, the size changes.

Attention

- Selecting “Normal” may make some color gradations unavailable for display.

● Digital Input (HDMI: video signal)

The screen size can be changed with the “Screen Size” function.

Setting	Function	Screen Display
Auto	The monitor automatically changes the screen size according to the aspect ratio ^{*1} and resolution information from the external device. This can be set only for HDMI (SD Signal) input.	
Full Screen	Displays an image in full screen. Images are distorted in some cases because the vertical rate is not equal to the horizontal rate.	
Enlarged	Displays an image in full screen. In some cases, a blank horizontal or vertical border appears to equalize the vertical rate and the horizontal rate.	
Letterbox	Displays Letterbox of 16 : 9 in full screen. Except for Letterbox, the upper and lower parts of the projected image are cut. This can be set only for HDMI (SD Signal) input.	
Normal ^{*2}	The image is displayed without scaling the input signals.	

*1 The aspect ratio information of letterbox cannot be identified automatically.

*2 When “Screen Size” is “Normal”, “Overscan” is fixed at “Off”.

Procedure

1. Press SIZE on the remote control.
Each time you press SIZE, the size changes.

Attention

- Selecting “Normal” may make some color gradations unavailable for display.

To set the screen ratio

In order to hide distortion or noise at the image’s edge, the display area of the input image can be changed so that peripheral images are not displayed.

Setting	Function
On	Displays an input image in the screen by trimming the vertical and horizontal parts of the image.
Off	Displays most of the input image.

Procedure

1. Press SIZE on the remote control.
The “Screen Size” menu appears.
2. Select “Overscan” with .
3. Use or for adjustment.
4. Press ENTER to exit.

Attention

- When “Screen Size” is “Normal”, “Overscan” is fixed at “Off”.

Chapter 3 Setting Monitor

3-1. Adjusting Volume

● To turn the volume up/down

This function allows you to adjust the volume.

Adjustable range

0 to 30

Procedure

1. Press VOLUME+ or VOLUME– on the remote control.

Note

- Alternatively, you can use **Vol +** or **Vol –** on the monitor for adjustment (see “1-2. Controls and Functions” (page 8)).
- The volume setting is common for the HDMI input and stereo mini jack.

Attention

- If a speaker with built-in amplifier is attached to the line output connector, adjust the volume on the external speaker. You cannot adjust the volume using the remote control or control buttons on the monitor.
 - When you try to adjust the volume with all the conditions below, “This operation is not available on current status.” is displayed.
 - The headphones are not connected.
 - A speaker with built-in amplifier is attached to the line output connector.
-

● To mute the sound temporarily

Procedure

1. Press MUTE on the remote control.

Mute sound temporarily.

By pressing the button again or pressing VOLUME+, the sound comes back.

Note

- The mute setting can also be released by pressing **Vol +** on the monitor.
- While the monitor is muted, press VOLUME– or **Vol –** on the monitor to decrease the volume setting.



Attention

- If a speaker with built-in amplifier is attached to the line output connector, adjust the volume on the external speaker. You cannot adjust the volume using the remote control of the monitor.
 - When you try to mute the speaker with all the conditions below, “This operation is not available on current status.” is displayed.
 - The headphones are not connected.
 - A speaker with built-in amplifier is attached to the line output connector.
-

3-2. Switching sound source for HDMI signal input

This function allows you to switch sound source for HDMI signal input. You can select the HDMI or stereo mini jack.

Procedure

1. Choose "Sound" in the Setting menu, and press ENTER.
2. Choose "Source" in the "Sound" menu, and press ENTER.
The "Source" menu appears.
3. Select "HDMI" or "Stereo Mini Jack" with  or .
4. Press ENTER to exit the adjustment.

Note

- This function is available with HDMI signal input. However, if a DVI-HDMI adapter cable is used, the sound source is automatically "Stereo Mini Jack" and cannot be changed.

3-3. To adjust the sound level



The input sound level can be adjusted.

The volume difference may occur depending on the kinds of input signals, since the average sound level of the external device differs.

Adjustable range

-1 to 1

Procedure

1. Choose "Sound" in the Setting menu, and press ENTER.
2. Choose "Sound Level" in the "Sound" menu, and press ENTER.
The "Sound Level" menu appears.
3. Use  or  for adjustment.
4. Press ENTER to exit the adjustment.

Attention

- This function is applicable to sound from the monitor speakers and headphones.



Note

- For example, if the volume difference of PC1 and PC2 input signals becomes large, you can reduce the volume difference between them by raising the "Sound Level" of the lower volume side.

3-4. Enabling/Disabling DDC/CI communication

This function allows you to enable/disable the DDC/CI communication (see ["Chapter 9 Glossary" \(page 55\)](#)).



Procedure

1. Choose "Monitor Settings" in the Setting menu, and press ENTER.
2. Choose "DDC/CI" in the "Monitor Settings" menu, and press ENTER.
The "DDC/CI" menu appears.
3. Select "Enable" or "Disable" with  or .
4. Press ENTER to exit the adjustment.

3-5. Locking Operation Buttons

This function allows you to lock the buttons on the monitor.

Procedure

1. Choose “Monitor Settings” in the Setting menu, and press ENTER.
2. Choose “Key Lock” in the “Monitor Settings” menu, and press ENTER.
The “Key Lock” menu appears.
3. Select “On” with  or .
4. Press ENTER to exit the adjustment.



Note

- The following operations are available even if the buttons are locked:
 - Turning on or off the monitor with the Power button
 - Does not lock the remote control operation.
-

3-6. Showing and hiding the EIZO logo

When the monitor is turned on, the EIZO logo appears on the screen. You can choose to show or hide the display of the EIZO logo.

Procedure

1. Choose “Monitor Settings” in the Setting menu, and press ENTER.
2. Choose “Logo” in the “Monitor Settings” menu, and press ENTER.
The “Logo” menu appears.
3. Select “On” or “Off” with  or .
4. Press ENTER to exit the adjustment.



3-7. Setting Language

This function allows you to select a language for the Setting menu or messages.

Selectable languages

English, German, French, Spanish, Italian, Swedish, Japanese, Simplified Chinese, Traditional Chinese

Procedure

1. Choose “Monitor Settings” in the Setting menu, and press ENTER.
2. Choose “Language” in the “Monitor Settings” menu, and press ENTER.
The “Language” menu appears.
3. Choose a language with  or .
4. Press ENTER to exit the adjustment.

3-8. Changing the authentication method for HDMI signal input

The external device cannot be authenticated successfully according to your external device and the screen cannot be displayed. In this case, follow the procedures below to change the authentication method.



Procedure

1. Press POWER on the remote control or \mathcal{O} on the monitor to turn OFF the monitor power.
2. Press SIGNAL on the monitor for five seconds or more.

The authentication method changes and the monitor power is turned on.

Note

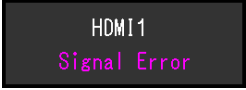
- The current authentication method can be identified based on the color used to display the input port or signal error.

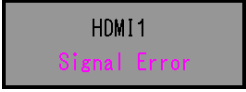
Method	Input port	Signal Error
1 (Default setting)		
2		

3-9. Resetting the Monitor to the Default Settings

There are two different Resets: Color Reset for only resetting the color adjustments to the default settings and Full Reset for resetting all settings to the defaults.

Attention

- After resetting, you cannot undo the operation.



Note

- Regarding the default setting, see [“Main Default Settings” \(page 52\)](#).

● To reset the color adjustments

This function only resets the color adjustments for the currently selected mode to the default settings.

Procedure

1. Choose “Color” in the Setting menu, and press ENTER.
2. Choose “Color Reset” in the “Color” menu, and press ENTER.
3. Select “Yes” with  or .
4. Press ENTER.

The color adjustments revert to the default settings.



● To reset all adjustments to the default settings

This function resets all adjustments to the default settings.

Attention

- The reset operation cannot return the authentication method for HDMI signal input ([“3-8. Changing the authentication method for HDMI signal input” \(page 31\)](#)) and the exiting method from the power saving mode ([“To change the exiting method from the power saving mode” \(page 37\)](#)) to the default setting.
-

Procedure

1. Choose “Monitor Settings” in the Setting menu, and press ENTER.
2. Choose “Reset” in the “Monitor Settings” menu, and press ENTER.
3. Select “Yes” with  or .
4. Press ENTER.

All adjustments revert to the default settings.

Chapter 4 Using Smart Function

4-1. Using Smart Function “Smart Detection” “Smart Resolution” “Smart Insight”

Smart Detection	This function allows you to select the area on the screen to which the “Smart Resolution” or “Smart Insight” setting is applied (only animated images or whole screen).
Smart Resolution	This function adjusts the perceived resolution of the images so that the blurs are reduced and images are displayed vividly and clearly. In addition, you can correct the color of skin and text affected by the “Smart Resolution” settings. Skin Tone Enhancer: Detects the skin tone in the image, and corrects the skin tone to look natural. Text Enhancer: Detects the text in the image, and corrects the coloring of the text and blurring around the text.
Smart Insight	This function analyzes the image and corrects the brightness for each pixel to make dark area of images visible. It is effective for images with dark area that are less visible and for bright environments. Attention <ul style="list-style-type: none">• “Smart Insight” detects the displayed scenes and corrects the screen brightness automatically. Therefore, the brightness may change slowly, for example, during scene transitions.

The setup for these functions is performed in the “Smart Functions” menu.

Attention

- When “sRGB” is selected for the color mode, the “Smart Functions” menu is not displayed. (When you press Smart on the remote control, “This operation is not available on current status” is displayed.)



Note

- Set “Smart Resolution” or “Smart Insight” to “Off” to disable the function.

To set “Smart Detection”

Setting	Function
Video	Detects the animated images on the screen, and applies the setting only to the detected area.
Full Screen	Applies the setting to the whole screen.

Procedure

1. Press Smart on the remote control.
The “Smart Functions” menu appears.
2. Select “Smart Detection”, and press ENTER.
The “Smart Detection” menu appears.
3. Select “Video” or “Full Screen” with  or .
4. Press ENTER to exit.

Note





- Under the following conditions, the setting for “Smart Detection” is fixed to “Full Screen”.
 - At analog signal input
 - At interlace signal input
 - “Full Screen” should be set to display animated images using the whole screen.
-

To set “Smart Resolution”

Adjustable range

1 - 5, Off

Procedure

1. Press Smart on the remote control.
The “Smart Functions” menu appears.
2. Select “Smart Resolution” with , and press ENTER.
The “Smart Resolution” menu appears.
3. Set the correction level with  or .
4. To complete the setting, proceed to step 7.
To continuously set “Skin Tone Enhancer” and “Text Enhancer”, proceed to step 5.
5. Choose the item to correct, and press ENTER.
Each setting menu appears.
6. Select “Enable” or “Disable” with  or .
7. Press ENTER to exit.

Attention



- When “Smart Resolution” is set to “Off”, “Skin Tone Enhancer” and “Text Enhancer” cannot be selected.
 - “Text Enhancer” is enabled only when all the conditions below are met.
 - At digital signal input
 - At non-interlace signal input
 - The screen is not enlarged using the Screen Size function (see [“2-5. Screen Size Changing” \(page 26\)](#)).
-

To set “Smart Insight”

Adjustable range

1 - 5, Off



Procedure

1. Press Smart on the remote control.
The “Smart Functions” menu appears.
2. Select “Smart Insight” with , and press ENTER.
The “Smart Insight” menu appears.
3. Set the correction level with  or .
4. Press ENTER to exit.





To check the setting status

The setting status of the “Smart Functions” menu can be checked on the demo screen.

Switching to the demo mode

1. Press  or  for 2 seconds or more while the “Smart Functions” menu is displayed.
The screen is switched to the demo mode.
 - Left half of screen: The settings of the “Smart Functions” menu are applied.
 - Right half of screen: The settings of the “Smart Functions” menu are not applied.

Note

- During the demo mode, the “Smart Functions” menu can be displayed to change each setting. If any of the Smart, MENU, , and  buttons is pressed, the menu appears.
 - When “Smart Detection” is set to “On”, the magenta colored frame that covers the area detected as an animated image appears.
 - To return to normal display from the demo screen, press  or  for 2 seconds or more while the “Smart Functions” menu is displayed.
-

Chapter 5 Power Saving Functions

5-1. Setting Power Saving

● Monitor

This function allows you to specify whether to set the monitor into the power saving mode, depending on the state of an external device connected to it. When the monitor has shifted to the power saving mode, the images on the screen are not displayed.



Attention

- Turning off the main power switch or unplugging the power cord completely shuts off power supply to the monitor.
- Power consumption varies even when the stereo mini jack cable is connected.

Note

- The monitor changes to the power saving mode about 15 seconds after the signal input ceases to be detected.

Procedure

1. Choose “PowerManager” in the Setting menu, and press ENTER.
2. Choose “Power Save” in the “PowerManager” menu, and press ENTER.
The “Power Save” menu appears.
3. Select “Enable” or “Disable” with  or .
4. Press ENTER to exit the adjustment.

Power Saving System

Analog Signal Input

This monitor complies with the VESA DPM standard.

PC		Monitor	Power Indicator
On		Operating	Blue
Power saving mode	STAND-BY SUSPENDED OFF	Power saving mode	Orange
Power Off		Power saving mode	Orange

Digital Signal Input

When the external device connected is a PC

This monitor complies with the DVI DMPM standard.

PC	Monitor	Power Indicator
On	Operating	Blue
Power saving mode	Power saving mode	Orange
Power Off	Power saving mode	Orange

When the external device connected is not a PC

Ext. Device	Monitor	Power Indicator
Power On	Operating	Blue
Power Off	Power saving mode	Orange

Attention

- When all the conditions below are met, the monitor does not change to the power saving mode even if “Power Save” is set to “Enable”:
 - “Power Save” for Sound is set to “Sound On” (“Audio Output” (page 37))
 - In the mute state (“To mute the sound temporarily” (page 28))In these cases, reset the mute.
-

Exiting the power saving mode

If the monitor receives input, it automatically exits the power saving mode and returns to the normal display mode.

● To change the exiting method from the power saving mode

Change the method of exiting from the power saving mode in the following cases.

- To reduce the time for exiting from the power saving mode
- The screen is not displayed when a signal is input to the monitor.

Procedure

1. Press POWER on the remote control or  on the monitor to turn OFF the monitor power.
2. Press **Vol** — on the monitor for five seconds or more.

The exiting method changes and the monitor power is turned on.

Attention

- After the exiting method is changed, the power consumption during the power saving mode increases slightly. In addition, “*” is displayed on the menu title of “Information” of the Setting menu (see “8-4. Displaying Monitor Information” (page 50)).

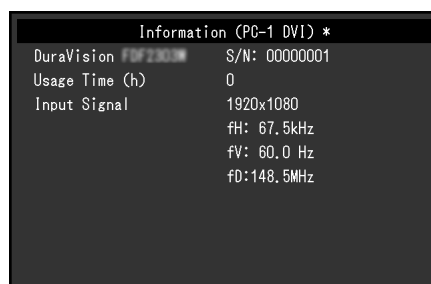



● Audio Output

This monitor allows you to turn off the audio output from the speakers/headphone at the power saving mode.

Procedure

1. Choose “Sound” in the Setting menu, and press ENTER.
2. Choose “Power Save” in the “Sound” menu, and press ENTER.

The “Power Save” menu appears.

3. Select “Sound On” or “Sound Off” with  or .
 4. Press ENTER to exit the adjustment.
-



Attention

- No audio is output while the monitor is in the Power Saving mode, if the HDMI signal is input or the sound source is of HDMI.
-

5-2. Setting Power Indicator

This function allows you to set the power indicator (blue) ON/OFF in the monitor ON condition.

Procedure

1. Choose “Monitor Settings” in the Setting menu, and press ENTER.
2. Choose “Power Indicator” in the “Monitor Settings” menu, and press ENTER.
The “Power Indicator” menu appears.
3. Select “Enable” or “Disable” with  or .
4. Press ENTER to exit the adjustment.



5-3. Enabling/Disabling Automatic Brightness Adjustment “Auto EcoView”

The ambient light sensor on the front side of the monitor detects the environmental brightness to adjust the screen brightness automatically and comfortably by using the Auto EcoView function.

Attention

- Be careful not to block the sensor on the lower side of the monitor when using the Auto EcoView function.

Procedure

1. Press Eco View on the remote control.
2. Choose “Auto EcoView” in the “EcoView Menu” menu, and press ENTER.
The “Auto EcoView” menu appears.
3. Select “High”, “Standard”, or “Off” with  or .
4. Press ENTER to exit.



Note

- As “Brightness” in the Setting menu is changed, the auto adjustment range for Auto EcoView is also changed.
- Set to “High” if you feel a little brighter with “Standard” setting status.

5-4. Reducing Glare “EcoView Optimizer”

Using EcoView Optimizer adjusts the screen brightness according to the environment brightness and white level of the input signal. Using this function with Auto EcoView can create a more comfortable level of brightness and reduce glare.

Procedure

1. Press Eco View on the remote control.
2. Choose “EcoView Optimizer” in the “EcoView Menu” menu, and press .
The “EcoView Optimizer” menu appears.
3. Select “On” or “Off” with  or .
4. Press ENTER to exit.

Attention

- Be careful not to block the ambient light sensor on the lower side of the monitor when using the EcoView Optimizer function.

5-5. Checking the power saving level

The EcoView menu allows you to check Power Reduction, CO₂ Reduction, and Eco Performance Level. The more indicators light up representing the Eco Performance Level, the higher the power saving level attained.

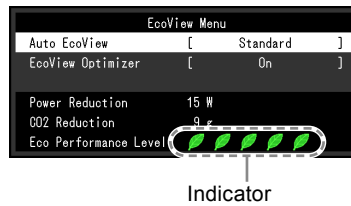

Procedure

1. Press Eco View on the remote control.
The “EcoView Menu” appears.

5-6. Enabling/Disabling Auto Power-OFF “Off Timer”

This function allows you to set the time to power off the monitor automatically.

Adjustable range

Disable, 30, 60, 90, 120, 150, 180 min

Procedure

1. Press OFF TIMER on the remote control.
Each time you press OFF TIMER, the set time changes.

Cancelling procedure

1. Press OFF TIMER until “Disable” appears.

Checking the remaining time

1. Press OFF TIMER when the Off Timer is set.
The time to turn off the power appears.

Time extension procedure

1. Press OFF TIMER while the remaining time is displayed.
Each time you press OFF TIMER, the time is extended.

Chapter 6 Connecting Cables

6-1. Connecting Multiple External Devices

The product has multiple connections to external devices and allows you to switch to one of the connections for display.

Attention

- Do not use dual link cables.

Connection examples

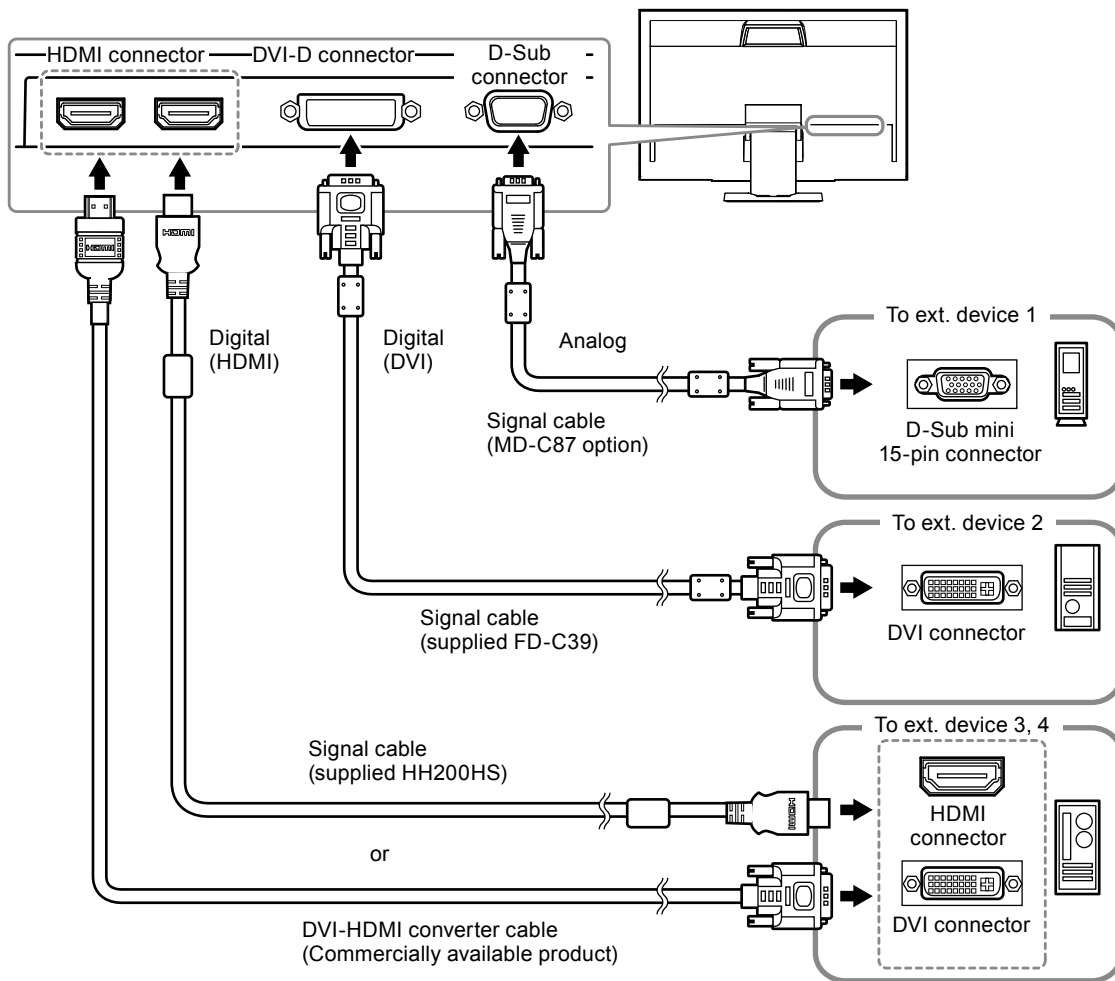

● To switch among input signals

Press P C or HDMI on the remote control to change the input signal.

When the signal is switched, the active input port name appears at the top right corner of the screen.

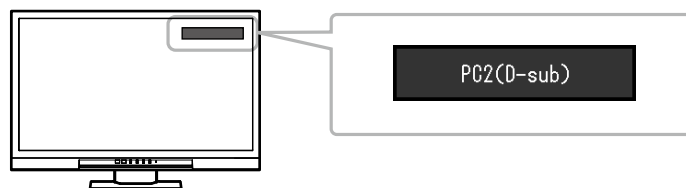

Note

- **SIGNAL** on the monitor also can change the input (see "1-2. Controls and Functions" (page 8)).

6-2. Connecting External Speaker

A speaker with built-in amplifier can be connected to this product to output sound from external devices such as PCs and game players.

Connection examples

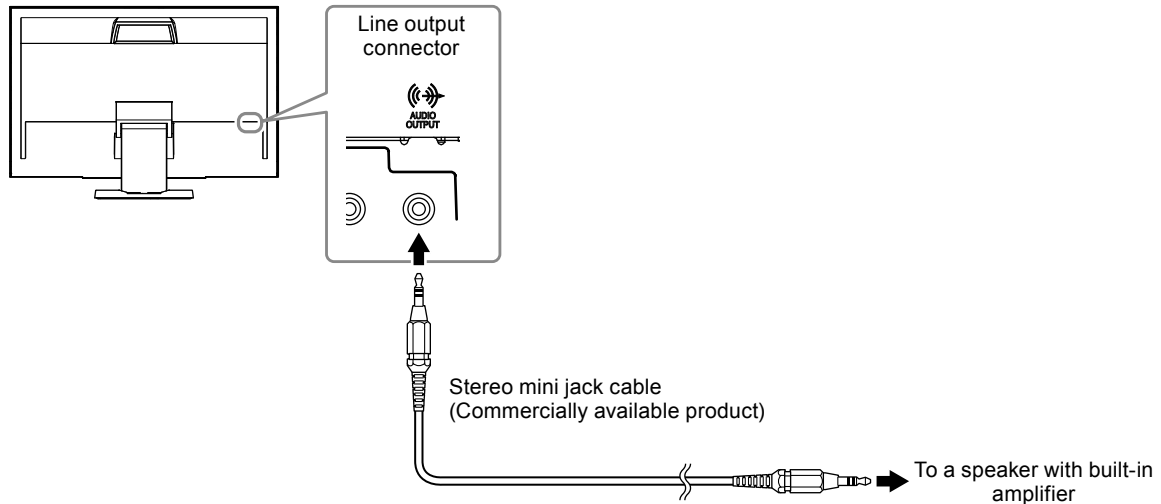

Attention

- Adjust the volume on the external speaker. You cannot adjust the volume using the remote control or control buttons on the monitor.
 - When a speaker with built-in amplifier is attached to the line output connector, the monitor speaker does not output any sound.
 - When headphones are connected to the monitor while a speaker with built-in amplifier is attached to the line output connector, the speaker with built-in amplifier does not output any sound.
-

Chapter 7 Troubleshooting

If a problem still remains after applying the suggested remedies, contact your local EIZO representative.

7-1. No picture

Problem	Possible cause and remedy
1. No picture <ul style="list-style-type: none"> Power indicator does not light. 	<ul style="list-style-type: none"> Check whether the power cord is connected properly. Turn the main power switch on. Turn off the main power, and then turn it on again a few minutes later.
<ul style="list-style-type: none"> Power indicator is lighting red. 	<ul style="list-style-type: none"> Press POWER on the remote control (or  on the monitor).
<ul style="list-style-type: none"> Power indicator is lighting blue. 	<ul style="list-style-type: none"> Increase “Brightness”, “Contrast”, or “Gain” in the Setting menu (see “To perform advanced adjustments” (page 16)).
<ul style="list-style-type: none"> Power indicator is lighting orange. 	<ul style="list-style-type: none"> Check whether the signal cable is connected properly. Check whether the external device is turned on. Operate the mouse or keyboard. Switch the input signal. If an external device is connected, change the method of exiting from the power saving mode. Turn off the power once and then press Vol — on the monitor for five seconds or more to change the exiting method and then turn on the power again (see “To change the exiting method from the power saving mode” (page 37)). If an external device is plugged into the HDMI port, change the authentication method. Power off once and then press SIGNAL on the monitor for five seconds or more to change the authentication method and then turn on the power again (see “3-8. Changing the authentication method for HDMI signal input” (page 31)).
2. The message below appears.	This message appears when the signal is not input correctly even when the monitor functions properly.
Example: <div data-bbox="338 1391 604 1487" style="border: 1px solid black; padding: 5px; margin: 10px auto; width: fit-content;"> PC2(D-sub) Signal Error </div>	<ul style="list-style-type: none"> The message shows that the input signal is out of the specified range. When the analog signal (D-Sub)/ digital signal (DVI-D, HDMI: PC signal) is input, take the measures below: <ul style="list-style-type: none"> Check whether the PC is configured to meet the resolution and vertical scan frequency requirements of the monitor (see “2-1. Compatible Resolutions/Formats” (page 13)). Reboot the PC. Select an appropriate setting using the graphics board's utility. Refer to the manual of the graphics board for details.



7-2. Imaging problems (for both digital and analog)

Problem	Possible cause and remedy
1. The screen is too bright or too dark.	<ul style="list-style-type: none"> Use “Brightness” or “Contrast” in the Setting menu to adjust it (see “To perform advanced adjustments” (page 16)). (The LCD monitor backlight has a limited life span. When the screen becomes dark or begins to flicker, contact your local EIZO representative.) If the screen is too bright, turn on Auto EcoView and EcoView Optimizer (see “5-3. Enabling/Disabling Automatic Brightness Adjustment “Auto EcoView”” (page 38), “5-4. Reducing Glare “EcoView Optimizer”” (page 38)). The monitor detects the environmental brightness to adjust the screen brightness automatically.
2. Characters are blurred.	<ul style="list-style-type: none"> Check whether the PC is configured to meet the resolution and vertical scan frequency requirements of the monitor (see “2-1. Compatible Resolutions/Formats” (page 13)). Use “Smoothing” in the Setting menu to adjust it (see “To modify blurred characters/lines” (page 25)).
3. Afterimages appear.	<ul style="list-style-type: none"> Afterimages are particular to LCD monitors. Avoid displaying the same image for a long time. Use the screen saver or power save function to avoid displaying the same image for extended periods of time.
4. Green/red/blue/white dots or defective dots remain on the screen.	<ul style="list-style-type: none"> This is due to LCD panel characteristics and is not a failure.
5. Interference patterns or pressure marks remain on the screen.	<ul style="list-style-type: none"> Leave the monitor with a white or black screen. The symptom may disappear.
6. Noise appears on the screen.	<ul style="list-style-type: none"> In the Setting menu, set “Overdrive” to “Off” (see “Enabling Overdrive” (page 21)). When entering the HDCP signals, the normal images may not be displayed immediately.
7. The screen is whitish or blackish.	<ul style="list-style-type: none"> Use “Black Level” (see “Adjusting the brightness and color of black “Black Level”” (page 17)), and “Contrast” (see “To adjust contrast” (page 17)) in the Setting menu to adjust it.

7-3. Imaging problems (for digital only)

Problem	Possible cause and remedy
1. The color shown on the display is not correct (for HDMI input).	<ul style="list-style-type: none"> Change the color space of the video signal in “Screen” – “Color Space” under the Setting menu.
2. The screen flashes (for HDMI input).	<ul style="list-style-type: none"> Transmittable signals differ on the category of the HDMI cable. Check whether the cable support High Speed.
3. The screen is whitish or blackish (for HDMI input).	<ul style="list-style-type: none"> Use “Screen” – “Color Space” under the Setting menu to adjust it.

7-4. Imaging problems (for analog only)

Problem	Possible cause and remedy
<p>1. Display position is incorrect.</p> 	<ul style="list-style-type: none">• Use “Position” in the Setting menu to correct the image position (see “To correct the screen position” (page 24)).• If the problem persists, use the graphics board’s utility if available to change the display position.
<p>2. Vertical bars appear on the screen or a part of the image is flickering.</p> 	<ul style="list-style-type: none">• Use “Clock” in the Setting menu to adjust it (see “To eliminate vertical bars” (page 23)).
<p>3. Whole screen is flickering or blurring.</p> 	<ul style="list-style-type: none">• Use “Phase” in the Setting menu to adjust it (see “To remove flickering or blurring” (page 24)).

7-5. Other problems

Problem	Possible cause and remedy
1. The “Smoothing” on the Setting menu “Screen” cannot be selected.	<ul style="list-style-type: none"> • You cannot choose “smoothing” when the screen is displayed in the following resolutions or settings. <ul style="list-style-type: none"> - The resolution is 1920 × 1080 - Screen Size is “Normal”
2. The auto adjustment function does not work.	<ul style="list-style-type: none"> • This function does not work during digital signal input. • This function is intended for use on the Macintosh and on AT-compatible PC running Windows. It does not work properly when an image is displayed only on a part of the screen (command prompt window, for example) or when a black background (wallpaper, etc.) is in use. • This function does not work correctly with some graphics boards.
3. No audio output.	<ul style="list-style-type: none"> • Check whether the stereo mini jack cable is connected properly. • Check the current external device and audio playback software to see whether they are configured correctly. • If HDMI input is used, check the current external device and the “Source” setting in the Setting menu (see “3-2. Switching sound source for HDMI signal input” (page 29)). • Monitor speaker <ul style="list-style-type: none"> - Check whether a speaker with built-in amplifier is attached to the line output connector. - Check whether volume is set to 0. • Headphones <ul style="list-style-type: none"> - Check whether volume is set to 0. • Speaker with built-in amplifier attached to the line output connector <ul style="list-style-type: none"> - Check whether the headphones are connected.
4. The volume of the speaker with built-in amplifier attached to the line output connector cannot be adjusted.	<ul style="list-style-type: none"> • With this product, the volume of an external speaker cannot be adjusted. Adjust the volume on the external speaker.
5. Will not change to the power saving mode	<ul style="list-style-type: none"> • When all the conditions below are met, the monitor does not change to the power saving mode even if “Power Save” is set to “Enable”: <ul style="list-style-type: none"> - “Power Save” for Sound is set to “Sound On” (“Audio Output” (page 37)) - In the mute state (“To mute the sound temporarily” (page 28)) <p>In these cases, reset the mute.</p>
6. “This operation is not available on current status.” is displayed.	<ul style="list-style-type: none"> • This message appears in the following cases. <ul style="list-style-type: none"> - When VOLUME+ / VOLUME– on the remote control or Vol + / Vol – on the monitor is pressed: <p>The volume of the speaker with built-in amplifier attached to the line output connector cannot be adjusted (see “3-1. Adjusting Volume” (page 28)).</p> - When Smart on the remote control is pressed: <p>When “sRGB” is selected for the color mode, the Smart function cannot be used (see “Chapter 4 Using Smart Function” (page 33)).</p>

Chapter 8 Reference

8-1. How to Attach the Optional Arm

An optional arm (or an optional stand) can be attached by removing the stand section. Please refer to our web site for the corresponding optional arm (or optional stand). <http://www.eizo.com>

Attention

- When attaching an arm or stand, follow the instructions of their user's manual.
- When using another manufacturer's arm or stand, confirm the following in advance and select one conforming to the VESA standard. Use the M4 × 12 mm screws supplied with this product.
 - Clearance between the screw holes: 100 mm × 100 mm
 - Strong enough to support weight of the monitor unit (except the stand) and attachments such as cables.
- When using an arm or stand, attach it to meet the following tilt angles of the monitor.
 - Up 45°, down 45° (horizontal display)
- Connect the cables after attaching an arm or stand.
- The monitor and arm or stand are heavy. Dropping them may result in injury or equipment damage.

Procedure

1. Lay the LCD monitor on a soft cloth spread over on a stable surface with the panel surface facing down.

2. Remove the stand.

Prepare a screwdriver. Using a screwdriver, remove the screws (three) securing the unit and the stand.

3. Attach the arm or stand to the monitor.

Secure the monitor to the arm or stand using the screws specified in the user's manual of the arm or stand.

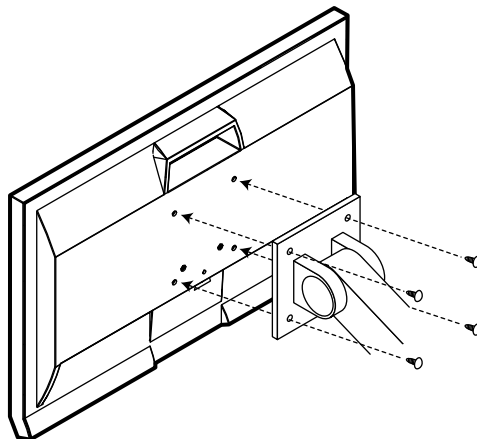

8-2. Detaching/Attaching Stand Base

Detaching procedure

The Stand base that was attached during setup can be detached using the following procedures.

- 1. Lay the LCD monitor on a soft cloth spread over on a stable surface with the panel surface facing down.**
- 2. Turn the fixing screw for the Stand base in the “RELEASE” direction to detach the base.**

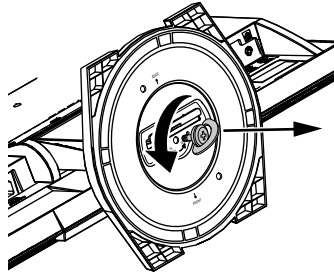

- 3. Remove the Stand base while lifting it up.**

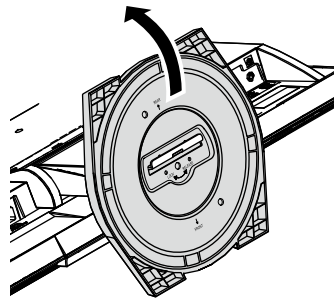

Attaching procedure

The once removed the Stand base can be attached to the monitor again with the following procedures.

- 1. Lay the LCD monitor on a soft cloth spread over on a stable surface with the panel surface facing down.**
- 2. Hold the Stand base with the “REAR” side facing upward, align the hole (a) of the Stand base with the tab (b) at the bottom of the monitor, and snap the tab into the hole.**

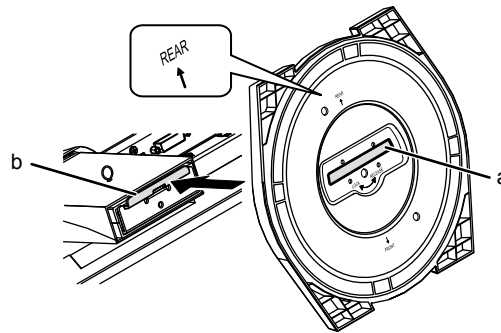

- 3. Turn the supplied screw in the “LOCK” direction to lock the Stand base.**
Tighten the screw firmly to the end.

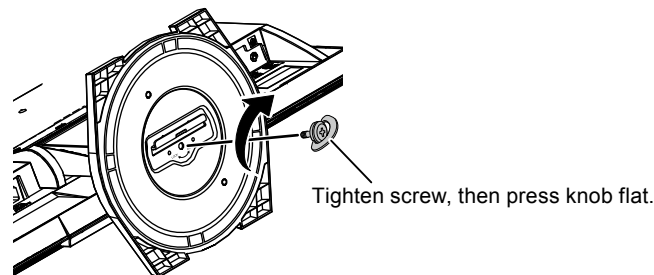

- 4. Place the monitor on a stable surface.**

8-3. Attaching/Detaching Cable Holder

A cable holder is supplied with this product. Use the holder to organize the cables connected to the monitor.

Attaching procedure

1. Pass the cables through the cable holder.
2. Shut the bottom of the cable holder.

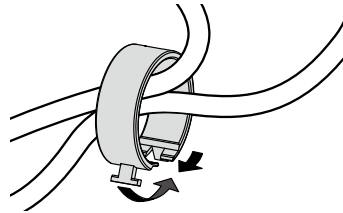

3. While holding the shut section, insert the cable holder into the Stand base.

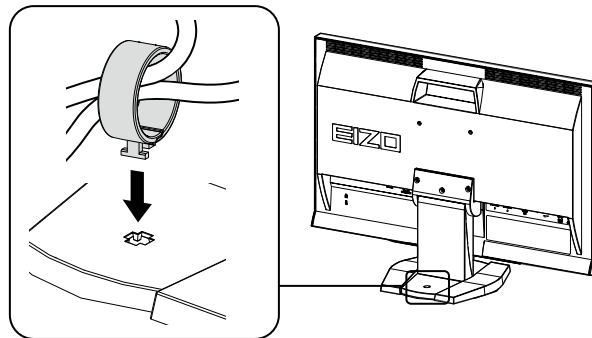

Note

- The cable holder can be inserted either perpendicular or parallel to the base. Change the direction of the cable holder according to the conditions of the cables.

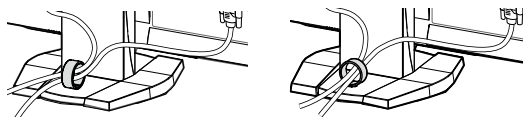

Detaching procedure

1. Shut the bottom of the cable holder.
2. While holding the shut section, lift the cable holder upward to remove it from the Stand base.

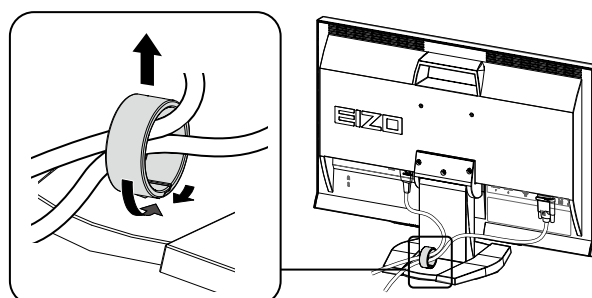

8-4. Displaying Monitor Information

This function allows you to display the model name, serial number, usage time, resolution, and input signal.

Procedure

1. Choose “Information” in the Setting menu, and press ENTER.

The “Information” menu appears.

Attention

- When you turn on the monitor for the first time, the usage time may be more than 0 due to a factory inspection.
-

8-5. Specifications

LCD Panel	Type	TN (Anti-Glare)
	Backlight	LED
	Size	58 cm (23.0 inch) (58.4 cm diagonal)
	Resolution	1920 dots × 1080 lines
	Display Size (H × V)	509.7 mm × 286.7 mm
	Pixel Pitch	0.2655 mm
	Display Colors	8-bit colors : 16.77 million colors
	Viewing Angles (H / V, typical)	170 ° / 160 °
	Response Time (typical)	10 ms (Black-white-black) 4 ms (Gray-to-gray) ^{*1} (Overdrive setting: Enhanced)
Contrast Ratio	1000:1 (when ContrastEnhancer setting is "Enhanced" 5000:1)	
Video Signals	Input Terminals	DVI-D connector (HDCP) × 1 D-Sub mini 15-pin × 1 HDMI Type A ² (HDCP) × 2
	Digital Scanning Frequency (H / V)	DVI : 31 kHz - 68 kHz / 59 Hz - 61 Hz (VGA TEXT: 69 Hz - 71 Hz) HDMI : 15 kHz - 68 kHz / 49 Hz - 61 Hz Frame synchronous mode : 49 Hz - 61 Hz
	Analog Scanning Frequency (H / V)	31 kHz - 81 kHz / 55 Hz - 76 Hz
	Maximum Dot Clock	148.5 MHz
	Synchronization Signal	Separate, TTL, positive / negative
Audio	Speaker output	0.5 W + 0.5 W
	Headphones	2 mW+2 mW
	Input Terminals	Line: Stereo mini jack × 1
		HDMI Type A ² × 2 (Shared with video signals)
	Output Terminals	Headphone: Stereo mini jack × 1
Line: Stereo mini jack × 1		
Power supply	Input	100 - 240 VAC ±10 %, 50 / 60 Hz 0.70 A - 0.45A
	Maximum Power Consumption	37 W or less
	Power Save Mode	0.4 W or less (When only the HDMI1 signal connector is connected with no stereo mini jack cables, "Sound" - "Power Save" is set to "Sound Off".)
	Standby Mode	0.3 W or less
Physical Specifications	Dimensions	545 mm × 390 - 450 mm × 200 mm (W × H × D) (for tilt of 0 °)
	Dimensions (Without Stand)	545 mm × 348.5 mm × 54 mm (W × H × D)
	Net Weight	Approx. 5.2 kg
	Net Weight (Without Stand)	Approx. 3.9 kg
	Height Adjustment Range	60 mm
	Tilt	25 ° up, 0 ° down
	Swivel	344 °
Operating Environmental Requirements	Temperature	5°C to 35°C (41°F to 95°F)
	Humidity	20% to 80% R.H. (no condensation)
	Air pressure	540 hPa to 1,060 hPa

Transportation/ Storage Environmental Requirements	Temperature	-20°C to 60°C (-4°F to 140°F)
	Humidity	10% to 90% R.H. (no condensation)
	Air pressure	200 hPa to 1,060 hPa

*1 Average value of response time in the gray-to-gray area.

*2 HDMI CEC (or mutual control) is not supported.

Main Default Settings

Color Mode	Day
Off Timer	Disable
Screen Size	D-Sub/DVI-D input: Full screen HDMI (PC signal/HD signal) input: Full screen HDMI (SD signal) input: Auto
Auto EcoView	Off
EcoView Optimizer	Off
Smoothing	3
Sound Level	0
Sound - Power Save	Sound Off
PowerManager - Power Save	Enable
DDC/CI	Disable
Key Lock	Off
Logo	On
Power Indicator	Enable
Language	English

Outside Dimensions

Unit: mm

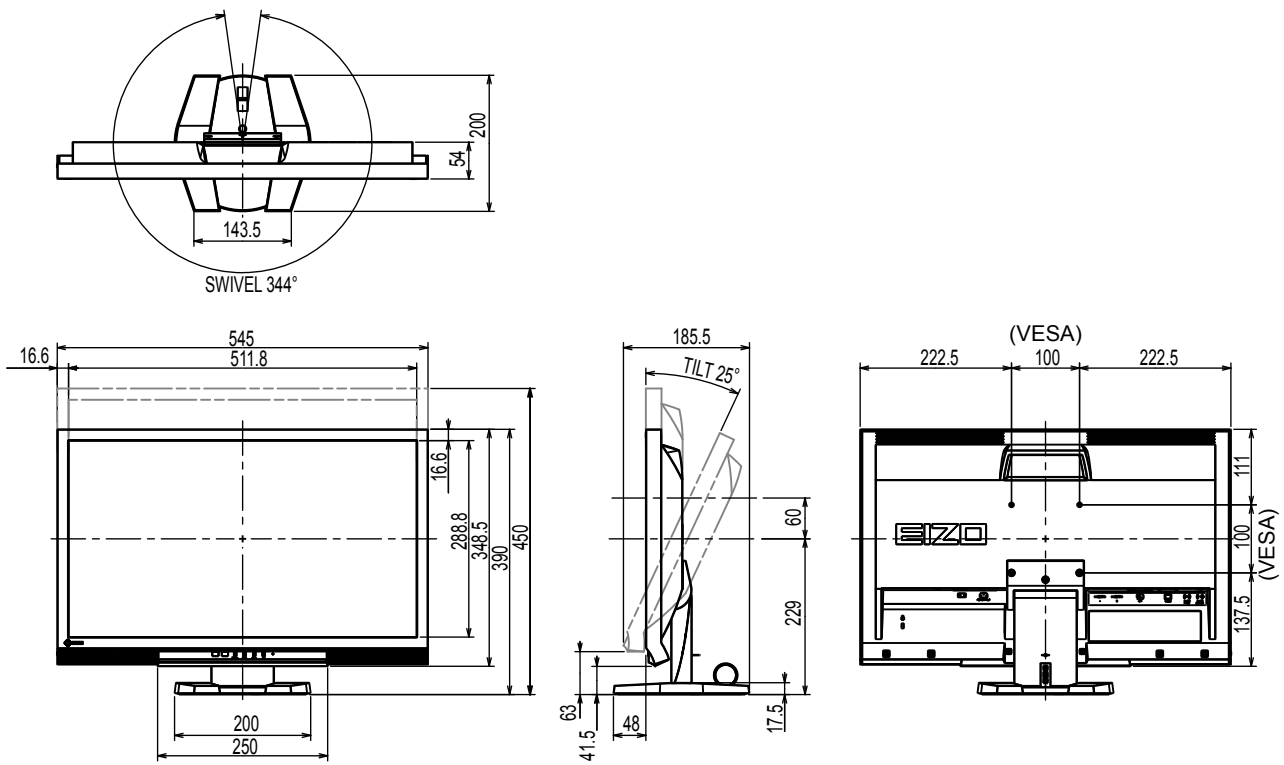

Accessories

Cleaning Kit	EIZO "ScreenCleaner"
Signal cable (D-Sub mini 15-pin)	MD-C87

For the latest information about the accessories, refer to our web site.

<http://www.eizo.com>

8-6. Preset Timing

The following table shows factory preset analog signal timing:

Attention

- Display position may be deviated depending on the PC connected, which may require screen adjustment using Setting menu.
- If a signal other than those listed in the table is input, adjust the screen using the Setting menu. However, screen display may still be incorrect even after the adjustment.
- When interlace signals are used, the screen cannot be displayed correctly even after screen adjustment using the Setting menu.

Resolution	Frequency		
	Dot Clock: MHz	Horizontal: kHz	Vertical: Hz
640 × 480	25.18	31.47	59.94
720 × 400	28.32	31.47	70.09
640 × 480	31.50	37.50	75.00
800 × 600	40.00	37.88	60.32
800 × 600	49.50	46.88	75.00
1024 × 768	65.00	48.36	60.00
1024 × 768	78.75	60.02	75.03
1280 × 720	74.25	45.00	60.00
1280 × 960	108.00	60.00	60.00
1280 × 1024	108.00	63.98	60.02
1280 × 1024	135.00	79.98	75.03
1680 × 1050	146.25	65.29	59.95
1680 × 1050	119.00	64.67	59.88
1920 × 1080	148.50	67.50	60.00

Chapter 9 Glossary

Clock

The analog signal input monitor needs to reproduce a clock of the same frequency as the dot clock of the graphics system in use, when the analog signal is converted to a digital signal for image display. This is called clock adjustment. If the clock pulse is not set correctly, some vertical bars appear on the screen.

Color Space

YUV and RGB, etc. are available. YUV expresses the color by using the luminance (Y), the color difference of Blue (U), and the color difference of Red (V). RGB does this by using the gradation of the 3 colors, Red (R), Green (G), and Blue (B).

DDC/CI (Display Data Channel/Command Interface)

VESA provides the standardization for the interactive communication of the setting information, etc. between a PC and the monitor.

DVI (Digital Visual Interface)

DVI is a digital interface standard. DVI allows direct transmission of the PC's digital data without loss.

This adopts the TMDS transmission system and DVI connectors. There are two types of DVI connectors. One is a DVI-D connector for digital signal input only. The other is a DVI-I connector for both digital and analog signal inputs.

DVI DMPM (DVI Digital Monitor Power Management)

DVI DMPM is a digital interface power saving function. The "Monitor ON (operating mode)" and "Active Off (power saving mode)" are indispensable for DVI DMPM as the monitor's power mode.

Gain

This is used to adjust each color parameter for red, green and blue. An LCD monitor displays the color by the light passing through the panel color filter. Red, green and blue are the three primary colors. All the colors on the screen are displayed by combining these three colors. The color tone can be changed by adjusting the light intensity (volume) passing through each color's filter.

Gamma

Generally, the monitor brightness varies nonlinearly with the input signal level, which is called "Gamma Characteristic". A small gamma value produces a low-contrast image, while a large gamma value produces a highcontrast image.

HDCP (High-bandwidth Digital Content Protection)

Digital signal coding system developed to copy-protect the digital contents, such as video, music, etc.

This helps to transmit the digital contents safely by coding the digital contents sent via the DVI or HDMI connector on the output side and decoding them on the input side.

Any digital contents cannot be reproduced if both of the equipments on the output and input sides are not applicable to HDCP system.

HDMI (High-Definition Multimedia Interface)

HDMI is a digital interface standard, developed for consumer electrical appliance or AV device. This standard is issued on the basis of the DVI standard which is one of an interface specification for the connection between a PC and a monitor. The projected image, sound and control signal without compressed enable to be transmitted with one cable.

Overdrive

This technology enhances response speed by increasing the potential difference at the time of motion of liquid-crystal pixels, and it is used for liquid-crystal TV sets and others in general. It provides clear-cut three-dimensional display with little afterimage, by improving response speed of the intermediate graduation range that frequently appears in moving images.

Phase

Phase means the sampling timing to convert the analog input signal to a digital signal. Phase adjustment is made to adjust the timing. It is recommended that phase adjustment be made after the clock is adjusted correctly.

Range Adjustment

Range adjustment controls the signal output levels to display every color gradation. It is recommended that range adjustment be made before color adjustment.

Resolution

The LCD panel consists of numerous pixels of specified size, which are illuminated to form images. This monitor consists of horizontal 1920 pixels and 1080 vertical pixels. At a resolution of 1920 × 1080, all pixels are illuminated as a full screen (1:1).

sRGB (Standard RGB)

International standard for color reproduction and color space among peripheral devices (such as monitors, printers, digital cameras, scanners). As a form of simple color matching for the Internet, colors can be displayed using tones close to those of the transmission and reception devices.

Temperature

Color temperature is a method to measure the white color tone, generally indicated in degrees Kelvin. The screen becomes reddish at a low temperature, and bluish at a high temperature, like the flame temperature.

5000 K: Slightly reddish white

6500 K: White referred to as daylight-balanced color

9300 K: Slightly bluish white

TMDS (Transition Minimized Differential Signaling)

A signal transmission system for digital interface.

VESA DPM (Video Electronics Standards Association - Display Power Management)

VESA specifications achieve increased energy efficiency for computer monitors. This involves standardization of signals sent from the computer (graphics board).

DPM defines the status of signals transmitted between the computer and monitor.

Appendix

Trademark

The terms HDMI and HDMI High-Definition Multimedia Interface, and the HDMI Logo are trademarks or registered trademarks of HDMI Licensing, LLC in the United States and other countries.

VESA is a registered trademark of Video Electronics Standards Association.

Acrobat, Adobe, Adobe AIR, and Photoshop are registered trademarks of Adobe Systems Incorporated in the United States and other countries.

AMD Athlon and AMD Opteron are trademarks of Advanced Micro Devices, Inc.

Apple, ColorSync, eMac, iBook, iMac, iPad, Mac, MacBook, Macintosh, Mac OS, PowerBook, and QuickTime are registered trademarks of Apple Inc.

ColorMunki, Eye-One, and X-Rite are registered trademarks or trademarks of X-Rite Incorporated in the United States and/or other countries.

ColorVision and ColorVision Spyder2 are registered trademarks of DataColor Holding AG in the United States.

Spyder3 and Spyder4 are trademarks of DataColor Holding AG.

ENERGY STAR is a registered trademark of the United States Environmental Protection Agency in the United States and other countries.

GRACoL and IDEAlliance are registered trademarks of International Digital Enterprise Alliance.

NEC is a registered trademark of NEC Corporation.

PC-9801 and PC-9821 are trademarks of NEC Corporation.

NextWindow is a trademark of NextWindow Ltd.

Intel, Intel Core, Pentium, and Thunderbolt are trademarks of Intel Corporation in the U.S. and/or other countries.

PowerPC is a registered trademark of International Business Machines Corporation.

PlayStation is a registered trademark of Sony Computer Entertainment Inc.

PSP and PS3 are trademarks of Sony Computer Entertainment Inc.

RealPlayer is a registered trademark of RealNetworks, Inc.

TouchWare is a trademark of 3M Touch Systems, Inc.

Windows, Windows Media, Windows Vista, SQL Server, Xbox 360, and Internet Explorer are registered trademarks of Microsoft Corporation in the United States and other countries.

YouTube is a registered trademark of Google Inc.

Firefox is a registered trademark of the Mozilla Foundation.

Kensington and MicroSaver are registered trademarks of ACCO Brands Corporation.

EIZO, the EIZO Logo, ColorEdge, DuraVision, FlexScan, FORIS, RadiCS, RadiForce, RadiNET, Raptor, and ScreenManager are registered trademarks of EIZO Corporation in Japan and other countries.

ColorNavigator, EcoView NET, EIZO EasyPIX, EIZO ScreenSlicer, i•Sound, Screen Administrator, UniColor, and Re/Vue are trademarks of EIZO Corporation.

All other company and product names are trademarks or registered trademarks of their respective owners.

License / Copyright

A round gothic bold bit map font designed by Ricoh is used for the characters displayed on this product.

FCC Declaration of Conformity

For U.S.A. , Canada, etc. (rated 100-120 Vac) Only

FCC Declaration of Conformity

We, the Responsible Party

EIZO Inc.

5710 Warland Drive, Cypress, CA 90630

Phone: (562) 431-5011

declare that the product

Trade name: EIZO

Model: DuraVision FDF2305W

is in conformity with Part 15 of the FCC Rules. Operation of this product is subject to the following two conditions: (1) this device may not cause harmful interference, and (2) this device must accept any interference received, including interference that may cause undesired operation.

This equipment has been tested and found to comply with the limits for a Class B digital device, pursuant to Part 15 of the FCC Rules. These limits are designed to provide reasonable protection against harmful interference in a residential installation. This equipment generates, uses, and can radiate radio frequency energy and, if not installed and used in accordance with the instructions, may cause harmful interference to radio communications. However, there is no guarantee that interference will not occur in a particular installation. If this equipment does cause harmful interference to radio or television reception, which can be determined by turning the equipment off and on, the user is encouraged to try to correct the interference by one or more of the following measures.

- * Reorient or relocate the receiving antenna.
- * Increase the separation between the equipment and receiver.
- * Connect the equipment into an outlet on a circuit different from that to which the receiver is connected.
- * Consult the dealer or an experienced radio/TV technician for help.

Changes or modifications not expressly approved by the party responsible for compliance could void the user's authority to operate the equipment.

Note

Use the attached specified cable below or EIZO signal cable with this monitor so as to keep interference within the limits of a Class B digital device.

- AC Cord
- Shielded Signal Cable (Enclosed)

Canadian Notice

This Class B digital apparatus complies with Canadian ICES-003.

Cet appareil numérique de la classe B est conforme à la norme NMB-003 du Canada.

LIMITED WARRANTY

LIMITED WARRANTY

EIZO Corporation (hereinafter referred to as “EIZO”) and distributors authorized by EIZO (hereinafter referred to as the “Distributors”) warrant, subject to and in accordance with the terms of this limited warranty (hereinafter referred to as the “Warranty”), to the original purchaser (hereinafter referred to as the “Original Purchaser”) who purchased the product specified in this document (hereinafter referred to as the “Product”) from EIZO or Distributors, that EIZO and Distributors shall, at their sole discretion, either repair or replace the Product at no charge if the Original Purchaser becomes aware within the Warranty Period (defined below) that the Product malfunctions or is damaged in the course of normal use of the Product in accordance with the description in the instruction manual attached to the Product (hereinafter referred to as the “User’s Manual”).

The period of this Warranty is two (2) years from the date of purchase of the Product (hereinafter referred to as the “Warranty Period”). EIZO and Distributors shall bear no liability or obligation with regard to the Product in relation to the Original Purchaser or any third parties other than as provided under this Warranty.

EIZO and Distributors will cease to hold or store any parts of the Product upon expiration of seven (7) years after the production of such parts is discontinued. In repairing the monitor, EIZO and Distributors will use renewal parts which comply with our QC standards.

The Warranty is valid only in the countries or territories where the Distributors are located. The Warranty does not restrict any legal rights of the Original Purchaser.

Notwithstanding any other provision of this Warranty, EIZO and Distributors shall have no obligation under this Warranty whatsoever in any of the cases as set forth below:

- (a) Any defect of the Product caused by freight damage, modification, alteration, abuse, misuse, accident, incorrect installation, disaster, faulty maintenance and/or improper repair by third party other than EIZO and Distributors;
- (b) Any incompatibility of the Product due to possible technical innovations and/or regulations;
- (c) Any deterioration of the sensor;
- (d) Any deterioration of display performance caused by the deterioration of expendable parts such as the LCD panel and/or backlight, etc. (e.g. changes in brightness, changes in brightness uniformity, changes in color, changes in color uniformity, defects in pixels including burnt pixels, etc.);
- (e) Any defect of the Product caused by external equipment;
- (f) Any defect of the Product on which the original serial number has been altered or removed;
- (g) Any defect of the Product caused by liquid leaking from battery;
- (h) Any normal deterioration of the product, particularly that of consumables, accessories, and/or attachments (e.g. batteries, buttons, rotating parts, remote control, cables, User’s Manual, etc.); and
- (i) Any deformation, discoloration, and/or warp of the exterior of the product including that of the surface of the LCD panel.

To obtain service under the Warranty, the Original Purchaser must deliver the Product, freight prepaid, in its original package or other adequate package affording an equal degree of protection, assuming the risk of damage and/or loss in transit, to the local Distributor. The Original Purchaser must present proof of purchase of the Product and the date of such purchase when requesting services under the Warranty.

The Warranty Period for any replaced and/or repaired product under this Warranty shall expire at the end of the original Warranty Period.

EIZO OR DISTRIBUTORS ARE NOT RESPONSIBLE FOR ANY DAMAGE TO, OR LOSS OF, DATA OR OTHER INFORMATION STORED IN ANY MEDIA OR ANY PART OF ANY PRODUCT RETURNED TO EIZO OR DISTRIBUTORS FOR REPAIR.

EIZO AND DISTRIBUTORS MAKE NO FURTHER WARRANTIES, EXPRESSED OR IMPLIED, WITH RESPECT TO THE PRODUCT AND ITS QUALITY, PERFORMANCE, MERCHANTABILITY OR FITNESS FOR ANY PARTICULAR USE. IN NO EVENT SHALL EIZO OR DISTRIBUTORS BE LIABLE FOR ANY INCIDENTAL, INDIRECT, SPECIAL, CONSEQUENTIAL OR OTHER DAMAGE WHATSOEVER (INCLUDING, WITHOUT LIMITATION, DAMAGES FOR LOSS OF PROFIT, BUSINESS INTERRUPTION, LOSS OF BUSINESS INFORMATION, OR ANY OTHER PECUNIARY LOSS) ARISING OUT OF THE USE OR INABILITY TO USE THE PRODUCT OR IN ANY CONNECTION WITH THE PRODUCT, WHETHER BASED ON CONTRACT, TORT, NEGLIGENCE, STRICT LIABILITY OR OTHERWISE, EVEN IF EIZO OR DISTRIBUTORS HAVE BEEN ADVISED OF THE POSSIBILITY OF SUCH DAMAGES. THIS EXCLUSION ALSO INCLUDES ANY LIABILITY WHICH MAY ARISE OUT OF THIRD PARTY CLAIMS AGAINST THE ORIGINAL PURCHASER. THE ESSENCE OF THIS PROVISION IS TO LIMIT THE POTENTIAL LIABILITY OF EIZO AND DISTRIBUTORS ARISING OUT OF THIS LIMITED WARRANTY AND/OR SALES.

BEGRENZTE GARANTIE

EIZO Corporation (im Weiteren als „**EIZO**“ bezeichnet) und die Vertragsimporteure von EIZO (im Weiteren als „**Vertrieb(e)**“ bezeichnet) garantieren dem ursprünglichen Käufer (im Weiteren als „**Erstkäufer**“ bezeichnet), der das in diesem Dokument vorgegebene Produkt (im Weiteren als „**Produkt**“ bezeichnet) von EIZO oder einem Vertrieb erworben hat, gemäß den Bedingungen dieser beschränkten Garantie (im Weiteren als „**Garantie**“ bezeichnet), dass EIZO und der Vertrieb nach eigenem Ermessen das Produkt entweder kostenlos reparieren oder austauschen, falls der Erstkäufer innerhalb der Garantiefrist (weiter unten festgelegt) eine Fehlfunktion bzw. Beschädigung des Produkts feststellt, die während des normalen Gebrauchs des Produkts gemäß den Anweisungen des zum Lieferumfang des Produkts gehörenden Benutzerhandbuchs (im Weiteren als „**Benutzerhandbuch**“ bezeichnet) aufgetreten ist.

Die Dauer der Garantieleistung (im Weiteren als „**Garantiefrist**“ bezeichnet) beträgt zwei (2) Jahre ab dem Kaufdatum des Produkts. EIZO und die Vertriebe übernehmen über den Rahmen dieser Garantie hinaus hinsichtlich des Produkts keinerlei Haftung oder Verpflichtung dem Erstkäufer oder Dritten gegenüber.

EIZO und die Vertriebe verpflichten sich, Ersatzteile für das Produkt über einen Zeitraum von sieben (7) Jahren nach Einstellung der Produktion der Ersatzteile zu lagern bzw. anzubieten. EIZO und seine Vertriebspartner verpflichten sich, bei einer etwaigen Reparatur des Monitors ausschließlich Produkte gemäß den EIZO-Qualitätssicherungsstandards zu verwenden.

Diese Garantie gilt nur in Ländern oder Gebieten, in denen sich Vertriebe befinden. Die gesetzlichen Gewährleistungsrechte des Erstkäufers gegenüber dem Verkäufer werden durch diese Garantie nicht berührt.

EIZO und die Vertriebe besitzen im Rahmen dieser Garantie keinerlei Verpflichtung in den folgenden Fällen:

- (a) Produktdefekte, die auf Frachtschäden, Modifikation, Nachgestaltung, Missbrauch, Fehlbedienung, Unfälle, unsachgemäße Installation, Naturkatastrophen, fehlerhafte Wartung und/oder unsachgemäße Reparatur durch eine andere Partei als EIZO und die Vertriebe zurückzuführen sind.
- (b) Eine Inkompatibilität des Produkts aufgrund von technischen Neuerungen und/oder neuen Bestimmungen, die nach dem Kauf in Kraft treten.
- (c) Jegliche Verschlechterung des Sensors.
- (d) Jegliche Verschlechterung der Bildschirmleistung, die durch Verschleißteile wie das LCD-Panel und/oder die Hintergrundbeleuchtung usw. hervorgerufen werden (z.B. Veränderungen von Helligkeit oder Helligkeitsverteilung, Veränderungen von Farbe oder Farbverteilung, Pixeldefekte einschließlich von durchgebrannten Pixeln usw.).
- (e) Produktdefekte, die durch externe Geräte verursacht werden.
- (f) Jeglicher Defekt eines Produkts, dessen ursprüngliche Seriennummer geändert oder entfernt wurde.
- (g) Produktdefekte, die durch Austritt von Batterieflüssigkeit verursacht werden.
- (h) Normale Abnutzung des Produkts, insbesondere von Verbrauchsteilen, Zubehörteilen und/oder Beilagen (z.B. Batterien, Tasten, drehbare Teile, Fernbedienung, Kabel, Benutzerhandbuch usw.); sowie
- (i) Verformungen, Verfärbungen und/oder Verziehungen am Produktäußeren, einschließlich der Oberfläche des LCD-Panels.

Bei Inanspruchnahme der Garantieleistung ist der Erstkäufer verpflichtet, das Produkt auf eigene Kosten und in der Originalverpackung bzw. einer anderen geeigneten Verpackung, die einen gleichwertigen Schutz gegen Transportschäden bietet, an den örtlichen Vertrieb zu übersenden, wobei der Erstkäufer das Transportrisiko gegenüber Schäden und/oder Verlust trägt. Zum Zeitpunkt der Inanspruchnahme der Garantieleistung muss der Erstkäufer einen Verkaufsbeleg vorweisen, auf dem das Kaufdatum angegeben ist.

Die Garantiefrist für ein im Rahmen dieser Garantie ausgetauschtes und/oder repariertes Produkt erlischt nach Ablauf der ursprünglichen Garantiefrist.

EIZO ODER DIE EIZO-VERTRAGSIMPORTEURE HAFTEN NICHT FÜR ZERSTÖRTE DATENBESTÄNDE ODER DIE KOSTEN DER WIEDERBESCHAFFUNG DIESER DATENBESTÄNDE AUF JEDLICHEN DATENTRÄGERN ODER TEILEN DES PRODUKTS, DIE IM RAHMEN DER GARANTIE BEI EIZO ODER DEN EIZO-VERTRAGSIMPORTEUREN ZUR REPARATUR EINGEREICHT WURDEN.

EIZO UND DIE EIZO-VERTRAGSIMPORTEURE GEBEN WEDER EXPLIZITE NOCH IMPLIZITE GARANTIE IN BEZUG AUF DIESES PRODUKT UND SEINE QUALITÄT, LEISTUNG, VERKÄUFLICHKEIT ODER EIGNUNG FÜR EINEN BESTIMMTEN ZWECK. AUF KEINEN FALL SIND EIZO ODER DIE EIZO-VERTRAGSIMPORTEURE VERANTWORTLICH FÜR JEDLICHE ZUFÄLLIGE, INDIREKTE, SPEZIELLE, FOLGE- ODER ANDERE SCHÄDEN JEDLICHER ART (EINSCHLIESSLICH OHNE JEDE BEGRENZUNG SCHÄDEN BEZÜGLICH PROFITVERLUST, GESCHÄFTSUNTERBRECHUNG, VERLUST VON GESCHÄFTSINFORMATION ODER JEDLICHE ANDEREN FINANZIELLEN EINBUSSEN), DIE DURCH DIE VERWENDUNG DES PRODUKTES ODER DIE UNFÄHIGKEIT ZUR VERWENDUNG DES PRODUKTES ODER IN JEDLICHER BEZIEHUNG MIT DEM PRODUKT, SEI ES BASIEREND AUF VERTRAG, SCHADENSERSATZ, NACHLAESSIGKEIT, STRIKTE HAFTPFLICHT ODER ANDEREN FORDERUNGEN ENTSTEHEN, AUCH WENN EIZO UND DIE EIZO-VERTRAGSIMPORTEURE IM VORAUS ÜBER DIE MÖGLICHKEIT SOLCHER SCHÄDEN INFORMIERT WURDEN. DIESER AUSSCHLUSS ENTHÄLT AUCH JEDE HAFTPFLICHT, DIE AUS FORDERUNGEN DRITTER GEGEN DEN ERSTKÄUFER ENTSTEHEN KANN. ZWECK DIESER KLAUSEL IST ES, DIE HAFTUNG VON EIZO UND DEN VERTRIEBEN GEGENÜBER FORDERUNGEN ZU BEGRENZEN, DIE AUS DIESER BESCHRÄNKTEN GARANTIE UND/ODER DEM VERKAUF ENTSTEHEN KÖNNEN.

GARANTIE LIMITÉE

EIZO Corporation (ci-après dénommé « **EIZO** ») et les distributeurs autorisés par EIZO (ci-après dénommés « **Distributeurs** »), sous réserve et conformément aux termes de cette garantie limitée (ci-après dénommée « **Garantie** »), garantissent à l'acheteur initial (ci-après dénommé « **Acheteur initial** ») du produit spécifié dans la présente (ci-après dénommé « **Produit** ») acheté auprès d'EIZO ou de Distributeurs agréés EIZO, que EIZO et ses Distributeurs auront pour option de réparer ou remplacer gratuitement le Produit si l'Acheteur initial constate, pendant la Période de garantie (définie ci-dessous), qu'il y a un dysfonctionnement ou que le Produit a subi un dommage dans le cadre d'une utilisation normale du Produit conformément à la description du mode d'emploi qui accompagne le Produit (ci-après dénommé « **Manuel d'utilisation** »).

La période de cette Garantie est de deux (2) ans à partir de la date d'achat du Produit (ci-après dénommée « Période de Garantie »). EIZO et ses Distributeurs déclinent toute responsabilité ou obligation concernant ce Produit face à l'Acheteur initial ou à toute autre personne à l'exception de celles stipulées dans la présente Garantie.

EIZO et ses Distributeurs cesseront de tenir ou conserver en stock toute pièce de ce Produit après l'expiration de la période de sept (7) ans suivant l'arrêt de la production de telles pièces. Pour réparer le moniteur, EIZO et ses distributeurs utiliseront des pièces de rechange conformes à nos normes de contrôle qualité.

La Garantie est valable uniquement dans les pays ou les territoires où se trouvent les Distributeurs. La Garantie ne limite aucun des droits reconnus par la loi à l'Acheteur initial.

Nonobstant toute autre clause de cette Garantie, EIZO et ses Distributeurs n'auront d'obligation dans le cadre de cette Garantie pour aucun des cas énumérés ci-dessous :

- (a) Tout défaut du Produit résultant de dommages occasionnés lors du transport, d'une modification, d'une altération, d'un abus, d'une mauvaise utilisation, d'un accident, d'une installation incorrecte, d'un désastre, d'un entretien et/ou d'une réparation incorrects effectués par une personne autre que EIZO ou ses Distributeurs ;
- (b) Toute incompatibilité du Produit résultant d'améliorations techniques et/ou réglementations possibles ;
- (c) Toute détérioration du capteur ;
- (d) Toute détérioration des performances d'affichage causée par la détérioration des éléments consommables tels que le panneau LCD et/ou le rétroéclairage, etc. (par exemple des changements de luminosité, des changements de l'uniformité de la luminosité, des modifications de couleur, des changements de l'uniformité des couleurs, des défauts de pixels y compris des pixels brûlés, etc.);
- (e) Tout défaut du Produit causé par un appareil externe ;
- (f) Tout défaut d'un Produit sur lequel le numéro de série original a été altéré ou supprimé ;
- (g) Tout défaut du Produit causé par un écoulement du liquide contenu dans les piles ;
- (h) Toute détérioration normale du Produit, particulièrement celle des consommables, des accessoires et/ou des pièces reliées au Produit (piles, touches, éléments pivotants, télécommande, câbles, Manuel d'utilisation etc.), et
- (i) Toute déformation, décoloration, et/ou gondolage de l'extérieur du Produit, y compris celle de la surface du panneau LCD.

Pour bénéficier d'un service dans le cadre de cette Garantie, l'Acheteur initial doit renvoyer le Produit port payé, dans son emballage d'origine ou tout autre emballage approprié offrant un degré de protection équivalent, au Distributeur local, et assumera la responsabilité des dommages et/ou perte possibles lors du transport. L'Acheteur initial doit présenter une preuve d'achat du Produit comprenant sa date d'achat pour bénéficier de ce service dans le cadre de la Garantie.

La Période de garantie pour tout Produit remplacé et/ou réparé dans le cadre de cette Garantie expirera à la fin de la Période de garantie initiale.

EIZO OU SES DISTRIBUTEURS NE SAURAIENT ÊTRE TENUS RESPONSABLES DES DOMMAGES OU PERTES DE DONNÉES OU D'AUTRES INFORMATIONS STOCKÉES DANS UN MÉDIA QUELCONQUE OU UNE AUTRE PARTIE DU PRODUIT RENVOYÉ À EIZO OU AUX DISTRIBUTEURS POUR RÉPARATION.

AUCUNE AUTRE GARANTIE, EXPLICITE OU TACITE, N'EST OFFERTE PAR EIZO ET SES DISTRIBUTEURS CONCERNANT LE PRODUIT ET SES QUALITÉS, PERFORMANCES, QUALITÉ MARCHANDE OU ADAPTATION À UN USAGE PARTICULIER. EN AUCUN CAS, EIZO OU SES DISTRIBUTEURS NE SERONT RESPONSABLES DES DOMMAGES FORTUITS, INDIRECTS, SPÉCIAUX, INDUITS, OU DE TOUT AUTRE DOMMAGE QUEL QU'IL SOIT (Y COMPRIS, SANS LIMITATION, LES DOMMAGES RÉSULTANT D'UNE PERTE DE PROFIT, D'UNE INTERRUPTION D'ACTIVITÉS, D'UNE PERTE DE DONNÉES COMMERCIALES, OU DE TOUT AUTRE MANQUE À GAGNER) RÉSULTANT DE L'UTILISATION OU DE L'INCAPACITÉ D'UTILISER LE PRODUIT OU AYANT UN RAPPORT QUELCONQUE AVEC LE PRODUIT, QUE CE SOIT SUR LA BASE D'UN CONTRAT, D'UN TORT, D'UNE NÉGLIGENCE, D'UNE RESPONSABILITÉ STRICTE OU AUTRE, MÊME SI EIZO OU SES DISTRIBUTEURS ONT ÉTÉ AVERTIS DE LA POSSIBILITÉ DE TELS DOMMAGES. CETTE LIMITATION INCLUT AUSSI TOUTE RESPONSABILITÉ QUI POURRAIT ÊTRE SOULEVÉE LORS DES RÉCLAMATIONS D'UN TIERS CONTRE L'ACHETEUR INITIAL. L'ESSENCE DE CETTE CLAUSE EST DE LIMITER LA RESPONSABILITÉ POTENTIELLE DE EIZO ET DE SES DISTRIBUTEURS RÉSULTANT DE CETTE GARANTIE LIMITÉE ET/OU DES VENTES.

GARANTÍA LIMITADA

EIZO Corporation (en lo sucesivo “EIZO”) y sus distribuidores autorizados (en lo sucesivo los “Distribuidores”), con arreglo y de conformidad con los términos de esta garantía limitada (en lo sucesivo la “Garantía”), garantizan al comprador original (en lo sucesivo el “Comprador original”) que compró el producto especificado en este documento (en lo sucesivo el “Producto”) a EIZO o a sus Distribuidores, que EIZO y sus Distribuidores, a su propio criterio, repararán o sustituirán el Producto de forma gratuita si el Comprador original detecta dentro del periodo de la Garantía (indicado posteriormente) que el Producto no funciona correctamente o que se ha averiado durante el uso normal del mismo de acuerdo con las indicaciones del manual de instrucciones suministrado con el Producto (en lo sucesivo el “Manual del usuario”).

El periodo de esta Garantía es de dos (2) años a partir de la fecha de compra del Producto (en adelante designado como el “Periodo de Garantía”). EIZO y sus Distribuidores no tendrán ninguna responsabilidad ni obligación con respecto al Producto para con el Comprador original ni con terceros que no sean las estipuladas en la presente Garantía.

EIZO y sus Distribuidores no estarán obligados a suministrar cualquier recambio del Producto una vez pasados siete (7) años desde que se deje de fabricar el mismo. Para la reparación del monitor, EIZO y los distribuidores utilizarán repuestos que cumplan con nuestros estándares de control de calidad.

La Garantía es válida sólo en los países y territorios donde están ubicados los Distribuidores. La Garantía no restringe ningún derecho legal del Comprador original.

A pesar de las estipulaciones de esta Garantía, EIZO y sus Distribuidores no tendrán obligación alguna bajo esta Garantía en ninguno de los casos expuestos a continuación:

- (a) Cualquier defecto del Producto causado por daños en el transporte, modificación, alteración, abuso, uso incorrecto, accidente, instalación incorrecta, desastre, mantenimiento incorrecto y/o reparación indebida realizada por un tercero que no sea EIZO o sus Distribuidores.
- (b) Cualquier incompatibilidad del Producto debida a posibles innovaciones técnicas y/o reglamentaciones.
- (c) Cualquier deterioro del sensor.
- (d) Cualquier deterioro en el rendimiento de la visualización causado por fallos en las piezas consumibles como el panel LCD y/o la "Backlight", etc. (p. ej. cambios de brillo, cambios de uniformidad del brillo, cambios de color, cambios de uniformidad del color, defectos de píxeles, incluyendo píxeles muertos, etc.).
- (e) Cualquier defecto del Producto causado por un equipo externo.
- (f) Cualquier defecto del Producto en el que haya sido alterado o borrado el número de serie original.
- (g) Cualquier defecto del Producto causado por fugas de líquido de las pilas.
- (h) Cualquier deterioro normal del Producto, y en particular de las piezas consumibles, accesorios y demás (p. ej. pilas, botones, piezas giratorias, mando a distancia, cables, Manual del usuario, etc.).
- (i) Cualquier deformación, decoloración y/o alabeo del exterior del Producto incluida la superficie del panel LCD.

Para obtener servicio en los términos de esta Garantía, el Producto deberá ser enviado por el Comprador original, a su Distribuidor local, con el transporte previamente pagado, en el embalaje original u otro embalaje adecuado que ofrezca el mismo grado de protección, asumiendo el riesgo de daños y/o pérdida del Producto durante el transporte. El Comprador original deberá presentar un comprobante de compra del Producto en el que se refleje la fecha de compra del mismo cuando lo solicite el servicio de Garantía.

El Periodo de garantía para cualquier Producto reemplazado y/o reparado en los términos de esta Garantía expirará al vencer el Periodo de garantía original.

EIZO O LOS DISTRIBUIDORES AUTORIZADOS DE EIZO NO SE RESPONSABILIZAN DE NINGÚN DAÑO O PÉRDIDA QUE PUEDAN SUFRIR LOS DATOS U OTRA INFORMACIÓN ALMACENADA EN CUALQUIER MEDIO O CUALQUIER PARTE DE CUALQUIER PRODUCTO DEVUELTO A EIZO O A LOS DISTRIBUIDORES DE EIZO PARA SU REPARACIÓN.

EIZO Y LOS DISTRIBUIDORES AUTORIZADOS DE EIZO NO OFRECEN NINGUNA OTRA GARANTÍA, IMPLÍCITA NI EXPLÍCITA, CON RESPECTO AL PRODUCTO Y A SU CALIDAD, RENDIMIENTO, COMERCIABILIDAD E IDONEIDAD PARA CUALQUIER USO EN PARTICULAR. EN NINGÚN CASO SERÁN EIZO O LOS DISTRIBUIDORES AUTORIZADOS DE EIZO RESPONSABLES DE NINGÚN DAÑO EMERGENTE, INDIRECTO, ESPECIAL, INHERENTE O CUALQUIERA QUE SEA (INCLUYENDO, SIN LIMITACIÓN, DAÑOS POR LUCRO CESANTE, INTERRUPCIÓN DE LA ACTIVIDAD COMERCIAL, PÉRDIDA DE INFORMACIÓN COMERCIAL O CUALQUIER OTRA PÉRDIDA PECUNIARIA) QUE SE DERIVE DEL USO O IMPOSIBILIDAD DE USO DEL PRODUCTO O EN RELACIÓN CON EL PRODUCTO, YA SEA BASADO EN CONTRATO, POR AGRAVIO, NEGLIGENCIA, ESTRICTA RESPONSABILIDAD O CUALQUIERA QUE SEA, AUN CUANDO SE HAYA ADVERTIDO A EIZO O A LOS DISTRIBUIDORES DE EIZO DE LA POSIBILIDAD DE TALES DAÑOS. ESTA EXCLUSIÓN TAMBIÉN ABARCA CUALQUIER RESPONSABILIDAD QUE PUEDA DERIVARSE DE RECLAMACIONES HECHAS POR UN TERCERO CONTRA EL COMPRADOR ORIGINAL. LA ESENCIA DE ESTA ESTIPULACIÓN ES LIMITAR LA RESPONSABILIDAD POTENCIAL DE EIZO Y LOS DISTRIBUIDORES QUE PUDIERA DERIVARSE DE ESTA GARANTÍA LIMITADA Y/O VENTAS.

GARANZIA LIMITATA

EIZO Corporation (a cui si farà riferimento da qui in poi con “**EIZO**”) ed i Distributori autorizzati da EIZO (a cui si farà riferimento da qui in poi con “**Distributori**”) garantiscono, secondo i termini di questa garanzia limitata (a cui si farà riferimento da qui in poi con “**Garanzia**”) all’acquirente originale (a cui si farà riferimento da qui in poi con “**Acquirente originale**”) che ha acquistato il prodotto specificato in questo documento (a cui si farà riferimento da qui in poi con “**Prodotto**”) da EIZO o dai suoi Distributori, che EIZO e i distributori, a loro discrezione, ripareranno o sostituiranno il Prodotto senza addebito se l’Acquirente originale trova, entro il periodo della Garanzia (definito sotto), che il Prodotto malfunziona e si è danneggiato nel corso del suo normale utilizzo osservando le indicazioni del manuale di istruzioni allegato al Prodotto (a cui si farà riferimento da qui in poi con “**Manuale utente**”).

Il periodo di questa Garanzia è di due (2) anni dalla data di acquisto del Prodotto (a cui si farà riferimento da qui in poi con “Periodo di Garanzia”). EIZO e i suoi Distributori non si assumono alcuna responsabilità e non hanno alcun obbligo riguardo al Prodotto verso l’Acquirente originale o terzi diversi da quelli relativi a questa Garanzia.

EIZO e i suoi Distributori cesseranno di tenere o di conservare qualsiasi ricambio del Prodotto allo scadere di sette (7) anni dopo che la produzione di tali ricambi è stata terminata. Per la riparazione del monitor, EIZO e i Distributori utilizzeranno parti di ricambio conformi ai nostri standard di controllo della qualità.

La Garanzia è valida soltanto nei paesi dove ci sono i Distributori EIZO. La Garanzia non limita alcun diritto legale dell’Acquirente originale.

Indipendentemente da qualsiasi altra condizione di questa Garanzia, EIZO e i suoi Distributori non avranno alcun obbligo derivante da questa Garanzia in ognuno dei casi elencati di seguito:

- (a) Qualsiasi difetto del Prodotto causato da danni di trasporto, modifiche, alterazioni, abusi, usi impropri, incidenti, installazione errata, calamità, manutenzione errata e/o riparazioni improprie eseguite da terze parti che non siano EIZO o i suoi Distributori.
- (b) Qualsiasi incompatibilità del Prodotto dovuta a possibili innovazioni tecniche e/o normative.
- (c) Qualsiasi deterioramento del sensore.
- (d) Qualsiasi deterioramento delle prestazioni dello schermo causato dal deterioramento delle parti consumabili, come il pannello LCD e/o la retroilluminazione, ecc. (per esempio: i cambiamenti di luminosità, cambiamenti di uniformità della luminosità, i cambiamenti di colore, i cambiamenti di uniformità del colore, i difetti dei pixel, inclusi i pixel bruciati, ecc.).
- (e) Qualsiasi difetto del Prodotto causato da apparecchiature esterne.
- (f) Qualsiasi difetto del Prodotto in cui il numero di serie originale sia stato alterato o rimosso.
- (g) Qualsiasi difetto del Prodotto causato dalla fuoriuscita di liquido dalle pile.
- (h) Qualsiasi normale deterioramento del Prodotto, in particolar modo nelle sue parti di consumo, accessori, e/o attacchi (per esempio: pile, tasti, parti rotanti, telecomando, cavi, Manuale dell’utente, ecc.).
- (i) Qualsiasi tipo di deformazione, scolorimento, e/o di involucro esterno del Prodotto inclusa la superficie del pannello LCD.

Per ricevere assistenza tecnica con questa Garanzia, l’Acquirente originale deve inviare il Prodotto, con trasporto pre-pagato, nella sua confezione originale o altra confezione adeguata che fornisce un livello analogo di protezione, assumendosi il rischio di danni e/o perdita in transito, al Distributore locale. L’Acquirente originale deve presentare la prova di acquisto che stabilisce la data di acquisto del Prodotto quando richiede servizio sotto Garanzia.

Il Periodo di garanzia per qualsiasi Prodotto sostituito e/o riparato sotto questa Garanzia scade alla fine del Periodo di garanzia originale.

EIZO O I SUOI DISTRIBUTORI NON SONO RESPONSABILI PER QUALSIASI DANNO O PERDITA DI DATI O ALTRE INFORMAZIONI MEMORIZZATI SU QUALSIASI SUPPORTO O QUALSIASI PARTE DI QUALSIASI PRODOTTO INVIATO A EIZO O I SUOI DISTRIBUTORI PER RIPARAZIONI.

EIZO E I SUOI DISTRIBUTORI NON OFFRONO ALCUNA GARANZIA ADDIZIONALE, IMPLICITA O ESPLICITA, RIGUARDO IL PRODOTTO E LA SUA QUALITÀ, PRESTAZIONI, VENDIBILITÀ O APPROPRIATEZZA PER QUALSIASI USO PARTICOLARE. IN NESSUN CASO EIZO O I DISTRIBUTORI EIZO AUTORIZZATI SARANNO RESPONSABILI PER QUALSIASI DANNO ACCIDENTALE, INDIRECTO, SPECIALE, CONSEGUENTE O DI QUALSIASI ALTRA NATURA (INCLUSI, SENZA LIMITI, DANNI PER PERDITA DI PROFITTI, INTERRUZIONE DELLE ATTIVITÀ, PERDITA DI INFORMAZIONI D’AFFARI O QUALSIASI ALTRA PERDITA PECUNIARIA) DERIVANTI DALL’USO O DALL’IMPOSSIBILITÀ DI USARE IL PRODOTTO O IN QUALSIASI RELAZIONE AL PRODOTTO, SIA SU BASE DI CONTRATTO, TORTO, NEGLIGENZA, STRETTA RESPONSABILITÀ O ALTRIMENTI, ANCHE SE EIZO O I DISTRIBUTORI EIZO AUTORIZZATI SONO STATI AVVERTITI DELLA POSSIBILITÀ DI TALI DANNI. QUESTA ESCLUSIONE INCLUDE ANCHE QUALSIASI RESPONSABILITÀ CHE POSSA INSORGERE DA RECLAMI DI TERZI CONTRO L’ACQUIRENTE ORIGINALE. L’ESSENZA DI QUESTO PROVVEDIMENTO È LIMITARE LA RESPONSABILITÀ POTENZIALE DI EIZO E DEI DISTRIBUTORI DERIVANTE DA QUESTA GARANZIA LIMITATA E/O DALLE VENDITE.

BEGRÄNSAD GARANTI

EIZO Corporation (nedan kallat "**EIZO**") och EIZOs auktoriserade distributörer (nedan kallade "**Distributörer**") garanterar i enlighet med villkoren i denna begränsade garanti (nedan kallad "**Garantin**") den ursprunglige köparen (nedan kallad den "**Ursprunglige köparen**") som köpte den i dokumentet specificerade produkten (nedan kallad "**Produkten**") från EIZO eller Distributörer, att EIZO eller Distributörer enligt eget gottfinnande kostnadsfritt antingen reparera eller byta ut den defekta Produkten om den Ursprunglige köparen inom Garantiperioden (definieras nedan) upptäcker att Produkten fungerar felaktigt eller skadas under normal användning av Produkten i enlighet med beskrivningen i bruksanvisningen (nedan kallad "**Bruksanvisning**").

Garantiperioden är begränsad till två (2) år från datumet för Produktens inköp (här kallad "Garantiperioden"). EIZO och Distributörer ska inte under några villkor ha något annat ansvar än vad som anges i denna garanti gällande Produkten i relation till den Ursprunglige köparen eller tredje part.

EIZO och Distributörer kommer att upphöra med lagerhållning av Produktens delar efter sju (7) år efter att produktionen av dessa delar upphört. När skärmen repareras använder EIZO och distributörer reservdelar som uppfyller våra kvalitetsstandarder.

Garantin är endast giltig i de länder där det finns Distributörer. Garantin begränsar inte några av den Ursprunglige köparens lagstadgade rättigheter.

Oavsett andra villkor i denna garanti ska inte EIZO Distributörer under några villkor ha något ansvar i något av de fall som beskrivs nedan:

- (a) När någon bristfällighet hos Produkten kan härledas till att ha uppstått vid frakt, modifiering, ändring, felaktigt handhavande, olycka, felaktig installation, katastrof, felaktigt underhåll och/eller felaktig reparation utförd av tredje part annan än EIZO och Distributörer.
- (b) Alla former av inkompatibilitet hos Produkten på grund av möjliga tekniska innovationer och/eller bestämmelser.
- (c) Alla försämringar av sensorn.
- (d) Alla försämringar av bildens prestanda beroende på förbrukningsdelar så som LCD-panel och/eller bakgrundsbelysning etc. (t.ex. ändringar i ljusstyrka, jämnhet i ljusstyrka, färg, färgjämnhet, defekta pixlar och/eller fast lysande pixlar etc.).
- (e) Alla defekter hos Produkten som orsakats av extern utrustning.
- (f) Alla defekter hos Produkten på vilken det ursprungliga serienumret har ändrats eller avlägsnats.
- (g) Alla produktfel som orsakas av vätska som läcker från batteriet.
- (h) All normal försämring av Produkten, speciellt förbrukningsartiklar, tillbehör och/eller yttre delar (t.ex. batterier, knappar, roterande delar, fjärrkontroll, kablar, Bruksanvisningen etc.).
- (i) Varje deformation, missfärgning och/eller skevhet av Produktens yttre inklusive ytan på LCD-panelen.

För att erhålla service under denna garanti måste den Ursprunglige köparen (med hänseende till risken för skada och/eller förlust under transport) leverera Produkten till närmaste Distributör med förebetalad frakt, i dess ursprungliga förpackning eller annan fullgod förpackning som ger likvärdigt skydd. Den Ursprunglige köparen måste kunna visa inköpsbevis för Produkten som klagör Produktens inköpsdatum vid begäran av garantiservice.

Garantiperioden för alla utbytta och/eller reparerade produkter under denna garanti skall upphöra vid utgången av den ursprungliga Garantiperioden.

EIZO ELLER DISTRIBUTÖRER ÄR INTE ANSVARIGA FÖR NÅGON FORM AV SKADA ELLER FÖRLUST AV DATA ELLER ANNAN INFORMATION SOM HAR LAGRATS I NÅGON FORM AV MEDIA ELLER ANNAN DEL AV NÅGON PRODUKT SOM HAR RETURNERATS TILL EIZO ELLER DISTRIBUTÖRER FÖR REPARATION.

EIZO OCH DISTRIBUTÖRERNA GARANTERAR INGET, UTTRYCKLIGEN ELLER UNDERFÖRSTÅTT, VAD BETRÄFFAR PRODUKTEN OCH DESS KVALITET, PRESTANDA, SÄLJBARHET ELLER LÄMPLIGHET FÖR NÅGON FORM AV SPECIELL ANVÄNDNING. UNDER INGA OMSTÄNDIGHETER SKALL EIZO ELLER DISTRIBUTÖRERNA HÅLLAS ANSVARIGA FÖR NÅGRA SOM HELST UNDERORDNADE, INDIREKTA, SPECIELLA, DÄRAV FÖLJANDE ELLER ÖVRIGA SKADOR (INKLUSIVE, UTAN BEGRÄNSNING TILL, SKADOR FÖR FÖRLUST AV INKOMST, AVBRUTEN AFFÄRSRÖRELSE, FÖRLUST AV AFFÄRSINFORMATION ELLER ANNAN SÄRSKILD FÖRLUST) SOM UPPSTÅTT SOM ETT RESULTAT AV ANVÄNDNING ELLER OFÖRMÅGA ATT ANVÄNDA PRODUKTEN ELLER I NÅGON FORM AV ANSLUTNING TILL PRODUKTERNA, VARE SIG DETTA GRUNDAS PÅ KONTRAKT, ÅTALBAR HANDLING, FÖRSUMLIGHET, ANSVARSSKYLDIGHET ELLER ANNAT, ÄVEN OM EIZO ELLER DISTRIBUTÖRERNA HAR INFORMERATS BETRÄFFANDE MÖJLIGHET ATT SÅDANA SKADOR FÖRELIGGER. DETTA UNDANTAG OMFATTAR ÄVEN ALL FORM AV ANSVARSSKYLDIGHET SOM KAN UPPSTÅ GENOM EN TREDJE PARTS ANSPRÅK GENTEMOT DEN URSPRUNGLIGE KÖPAREN. GRUNDBESTÄNDSDELEN I BESTÄMMELEN ÄR ATT BEGRÄNSA DET EVENTUELLA ANSVARSTAGANDET FÖR EIZO OCH DISTRIBUTÖRERNA SOM KAN UPPSTÅ GENOM DENNA BEGRÄNSADE GARANTI OCH/ELLER FÖRSÄLJNING.

ΠΕΡΙΟΡΙΣΜΕΝΗ ΕΓΓΥΗΣΗ

Η EIZO Corporation (στο εξής «**EIZO**») και οι διανομείς που εξουσιοδοτεί η EIZO (στο εξής «**Διανομείς**») παρέχουν εγγύηση, υποκειμένη και σύμφωνα με τους όρους της παρούσας περιορισμένης εγγύησης (στο εξής «**Εγγύηση**»), στον αρχικό αγοραστή (στο εξής «**Αρχικός Αγοραστής**») ο οποίος αγόρασε το προϊόν που καθορίζεται στο παρόν έγγραφο (στο εξής «**Προϊόν**») από την EIZO ή τους Διανομείς, η οποία εξασφαλίζει ότι η EIZO και οι Διανομείς, σύμφωνα με τη διακριτή ευχέρειά τους, είτε θα επισκευάσουν είτε θα αντικαταστήσουν το Προϊόν χωρίς χρέωση εάν ο Αρχικός Αγοραστής αντιληφθεί εντός της Περιόδου Εγγύησης (ορίζεται κατωτέρω) ότι το Προϊόν δυσλειτουργεί ή έχει υποστεί βλάβη κατά τη διάρκεια κανονικής χρήσης του Προϊόντος σύμφωνα με την περιγραφή στο εγχειρίδιο χρήσης που συνοδεύει το Προϊόν (στο εξής «**Εγχειρίδιο Χρήστη**»).

Η περίοδος της παρούσας Εγγύησης είναι δύο (2) έτη από την ημερομηνία αγοράς του Προϊόντος (στο εξής «Περίοδος Εγγύησης»). Η EIZO και οι Διανομείς δεν φέρουν καμία ευθύνη ή υποχρέωση όσον αφορά το Προϊόν σε σχέση με τον Αρχικό Αγοραστή ή οποιοδήποτε τρίτο μέρος, ούτε άλλη ευθύνη διαφορετική από αυτήν που παρέχεται στην παρούσα Εγγύηση.

Η EIZO και οι Διανομείς θα παύσουν να διατηρούν ή να αποθηκεύουν τυχόν εξαρτήματα του Προϊόντος κατόπιν της λήξης των επτά (7) ετών μετά τη διακοπή της παραγωγής τέτοιων εξαρτημάτων. Κατά την επισκευή της οθόνης, η EIZO και οι Διανομείς θα χρησιμοποιήσουν ανταλλακτικά επισκευής που συμμορφώνονται με τα πρότυπά μας για τη Διασφάλιση Ποιότητας.

Η Εγγύηση ισχύει μόνο σε χώρες ή περιοχές όπου βρίσκονται οι Διανομείς. Η Εγγύηση δεν περιορίζει οποιαδήποτε νόμιμα δικαιώματα του Αρχικού Αγοραστή.

Λαμβανομένης υπόψη κάθε διάταξης της παρούσας Εγγύησης, η EIZO και οι Διανομείς δεν θα έχουν καμία απολύτως υποχρέωση σύμφωνα με την παρούσα Εγγύηση σε οποιαδήποτε από τις περιπτώσεις που διατυπώνονται κατωτέρω:

- (α) Τυχόν ελάττωμα του Προϊόντος που προκαλείται από ζημιά κατά τη μεταφορά, τροποποίηση, αλλαγή, κατάχρηση, λανθασμένη χρήση, ατύχημα, λανθασμένη εγκατάσταση, καταστροφή, εσφαλμένη συντήρηση ή/και λανθασμένη επισκευή από τρίτο μέρος εκτός της EIZO και των Διανομέων,
- (β) Τυχόν ασυμβατότητα του Προϊόντος λόγω πιθανών τεχνικών καινοτομιών ή/και κανονισμών,
- (γ) Τυχόν επιδείνωση του αισθητήρα,
- (δ) Τυχόν επιδείνωση της απόδοσης οθόνης που προκαλείται από τη φθορά αναλώσιμων εξαρτημάτων όπως της οθόνης LCD ή/και του φωτός υποβάθρου, κτλ. (π.χ. αλλαγές στη φωτεινότητα, αλλαγές στην ομοιομορφία φωτεινότητας, αλλαγές στο χρώμα, αλλαγές στην ομοιομορφία χρώματος, ελαττώματα σε pixel περιλαμβανομένων των καμένων pixel, κτλ.),
- (ε) Τυχόν ελάττωμα του Προϊόντος που προκαλείται από εξωτερικό εξοπλισμό,
- (στ) Τυχόν ελάττωμα του Προϊόντος στο οποίο έχει τροποποιηθεί ή αφαιρεθεί ο γνήσιος αριθμός σειράς,
- (ζ) Τυχόν ελάττωμα του Προϊόντος που προκαλείται από διαρροή υγρού από την μπαταρία,
- (η) Τυχόν φυσιολογική φθορά του προϊόντος, ιδιαίτερα αυτής των αναλώσιμων, των αξεσουάρ ή/και των προσαρτημάτων (π.χ. μπαταρίες, κουμπιά, περιστρεφόμενα μέρη, τηλεχειριστήριο, καλώδια, Εγχειρίδιο Χρήστη, κτλ.), και
- (θ) Τυχόν παραμόρφωση, αποχρωματισμό ή/και διαστρέβλωση του εξωτερικού μέρους του προϊόντος, περιλαμβανομένης της επιφάνειας της οθόνης LCD.

Ο Αρχικός Αγοραστής για να δικαιούται υπηρεσίες επισκευής σύμφωνα με την Εγγύηση, θα πρέπει να παραδώσει το Προϊόν, με πληρωμένα τα μεταφορικά έξοδα, στην αρχική του συσκευασία ή σε άλλη επαρκή συσκευασία με ισότιμο βαθμό προστασίας, αναλαμβάνοντας τον κίνδυνο βλάβης ή/και απώλειας κατά τη μεταφορά, στον τοπικό Διανομέα. Ο Αρχικός Αγοραστής όταν ζητά υπηρεσίες επισκευής σύμφωνα με την Εγγύηση, θα πρέπει να προσκομίζει την απόδειξη αγοράς του Προϊόντος και την ημερομηνία της αγοράς.

Η Περίοδος Εγγύησης για οποιοδήποτε αντικατεστημένο ή/και επισκευασμένο προϊόν σύμφωνα με την παρούσα Εγγύηση λήγει στο τέλος της αρχικής Περιόδου Εγγύησης.

Η EIZO Ή ΟΙ ΔΙΑΝΟΜΕΙΣ ΔΕΝ ΕΥΘΥΝΟΝΤΑΙ ΓΙΑ ΟΠΟΙΑΔΗΠΟΤΕ ΒΛΑΒΗ Ή ΑΠΩΛΕΙΑ ΔΕΔΟΜΕΝΩΝ Ή ΑΛΛΩΝ ΠΛΗΡΟΦΟΡΙΩΝ ΠΟΥ ΑΠΟΘΗΚΕΥΟΝΤΑΙ ΣΕ ΟΠΟΙΟΔΗΠΟΤΕ ΜΕΣΟ Ή ΟΠΟΙΟΔΗΠΟΤΕ ΑΛΛΟ ΜΕΡΟΣ ΣΕ ΟΠΟΙΟΔΗΠΟΤΕ ΠΡΟΪΟΝ ΠΟΥ ΕΠΙΣΤΡΕΦΕΤΑΙ ΣΤΗΝ EIZO Ή ΣΕ ΔΙΑΝΟΜΕΑ ΓΙΑ ΕΠΙΣΚΕΥΗ.

Η EIZO ΚΑΙ ΟΙ ΔΙΑΝΟΜΕΙΣ ΔΕΝ ΠΑΡΕΧΟΥΝ ΚΑΜΙΑ ΠΕΡΑΙΤΕΡΩ ΕΓΓΥΗΣΗ, ΡΗΤΗ Ή ΣΥΝΕΠΑΓΟΜΕΝΗ, ΟΣΟΝ ΑΦΟΡΑ ΤΟ ΠΡΟΪΟΝ ΚΑΙ ΤΗΝ ΠΟΙΟΤΗΤΑ, ΤΗΝ ΑΠΟΔΟΣΗ, ΤΗΝ ΕΜΠΟΡΕΥΣΙΜΟΤΗΤΑ Ή ΤΗΝ ΚΑΤΑΛΛΗΛΟΤΗΤΑ ΤΟΥ ΓΙΑ ΟΠΟΙΑΔΗΠΟΤΕ ΣΥΓΚΕΚΡΙΜΕΝΗ ΧΡΗΣΗ. ΣΕ ΚΑΜΙΑ ΠΕΡΙΠΤΩΣΗ Η EIZO Ή ΟΙ ΔΙΑΝΟΜΕΙΣ ΔΕΝ ΘΑ ΕΥΘΥΝΟΝΤΑΙ ΓΙΑ ΚΑΜΙΑ ΑΠΟΛΥΤΩΣ ΤΥΧΑΙΑ, ΕΜΜΕΣΗ, ΕΙΔΙΚΗ, ΣΥΝΕΠΑΓΟΜΕΝΗ Ή ΑΛΛΗ ΒΛΑΒΗ (ΠΕΡΙΛΑΜΒΑΝΟΜΕΝΩΝ, ΜΕΤΑΞΥ ΑΛΛΩΝ, ΒΛΑΒΩΝ Ή ΑΠΩΛΕΙΑΣ ΚΕΡΔΩΝ, ΔΙΑΚΟΠΗΣ ΕΠΙΧΕΙΡΗΜΑΤΙΚΩΝ ΔΡΑΣΤΗΡΙΟΤΗΤΩΝ, ΑΠΩΛΕΙΑΣ ΕΠΙΧΕΙΡΗΜΑΤΙΚΩΝ ΠΛΗΡΟΦΟΡΙΩΝ Ή ΤΥΧΟΝ ΑΛΛΗΣ ΧΡΗΜΑΤΙΚΗΣ ΑΠΩΛΕΙΑΣ) ΠΟΥ ΠΡΟΚΥΠΤΕΙ ΑΠΟ ΤΗ ΧΡΗΣΗ Ή ΤΗΝ ΑΝΙΚΑΝΟΤΗΤΑ ΧΡΗΣΗΣ ΤΟΥ ΠΡΟΪΟΝΤΟΣ Ή ΤΥΧΟΝ ΑΛΛΗΣ ΣΥΝΔΕΣΗΣ ΜΕ ΤΟ ΠΡΟΪΟΝ, ΕΙΤΕ ΒΑΣΙΖΕΤΑΙ ΣΕ ΣΥΜΒΟΛΑΙΟ, ΒΛΑΒΗ, ΑΜΕΛΕΙΑ, ΑΥΣΤΗΡΗ ΕΥΘΥΝΗ Ή ΕΙΔΑΛΛΩΣ, ΑΚΟΜΗ ΚΙ ΕΑΝ Η EIZO Ή ΟΙ ΔΙΑΝΟΜΕΙΣ ΕΝΗΜΕΡΩΘΟΥΝ ΓΙΑ ΤΗΝ ΠΙΘΑΝΟΤΗΤΑ ΤΕΤΟΙΩΝ ΖΗΜΙΩΝ. Η ΕΞΑΙΡΕΣΗ ΑΥΤΗ ΠΕΡΙΛΑΜΒΑΝΕΙ ΕΠΙΣΗΣ ΟΠΟΙΑΔΗΠΟΤΕ ΕΥΘΥΝΗ ΕΝΔΕΧΕΤΑΙ ΝΑ ΠΡΟΚΥΨΕΙ ΑΠΟ ΑΞΙΩΣΕΙΣ ΤΡΙΤΟΥ ΜΕΡΟΥΣ ΚΑΤΑ ΤΟΥ ΑΡΧΙΚΟΥ ΑΓΟΡΑΣΤΗ. Η ΟΥΣΙΑ ΤΟΥ ΟΡΟΥ ΑΥΤΟΥ ΕΙΝΑΙ ΝΑ ΠΕΡΙΟΡΙΣΕΙ ΤΗΝ ΠΙΘΑΝΗ ΕΥΘΥΝΗ ΤΗΣ EIZO ΚΑΙ ΤΩΝ ΔΙΑΝΟΜΕΩΝ ΠΟΥ ΠΡΟΚΥΠΤΕΙ ΑΠΟ ΤΗΝ ΠΑΡΟΥΣΑ ΕΓΓΥΗΣΗ Ή/ΚΑΙ ΤΙΣ ΠΩΛΗΣΕΙΣ.

ОГРАНИЧЕННАЯ ГАРАНТИЯ

EIZO Corporation (называемая в дальнейшем “EIZO”) и авторизованные EIZO дистрибуторы (называемые в дальнейшем “Дистрибуторы”) гарантируют, в соответствии с условиями и пунктами этой ограниченной гарантии (называемой в дальнейшем “Гарантия”), первичному покупателю (называемому в дальнейшем “Первоначальный покупатель”), который приобрел у EIZO или Дистрибуторов продукт, указанный в этом документе (называемый в дальнейшем “Продукт”), что EIZO или Дистрибуторы на свое усмотрение либо бесплатно отремонтируют, либо бесплатно заменят Продукт, если Первоначальный покупатель признает в пределах Гарантийного срока (определенного ниже), что Продукт неисправен или он поврежден процессе нормального использования продукта в соответствии с описанием в инструкции по эксплуатации, прилагаемой к Продукту (называемой в дальнейшем “Руководство пользователя”).

Гарантийный период ограничен сроком два (2) года от даты приобретения Продукта (называемый в дальнейшем “Гарантийный период”). EIZO и Дистрибуторы не несут никакой ответственности и не берут обязательств относительно Продукта по отношению к Первоначальному покупателю или по отношению к любым третьим сторонам, кроме обязательств, оговоренных в этой Гарантии.

EIZO и Дистрибуторы прекратят хранение или складирование любых деталей Продукта по истечении семи (7) лет после прекращения производства таких деталей. В случае ремонта монитора EIZO и Дистрибуторы будут использовать запчасти, которые соответствуют нашим стандартам QC (контроль качества).

Гарантия действительна только в странах или регионах, где расположены Дистрибуторы. Гарантия не ограничивает никакие законные права Первоначального покупателя.

Несмотря на другие условия этой Гарантии EIZO и Дистрибуторы не несут никаких обязательств согласно этой Гарантии в любом из перечисленных ниже случаев:

- (а) Любые дефекты Продукта, вызванные повреждениями при перевозке, модификацией, изменением, неправильным обращением, неправильным использованием, авариями, неправильной установкой, стихийными бедствиями, неправильным уходом и/или неправильным ремонтом третьей стороной, отличной от EIZO или Дистрибуторов;
- (б) Любые несовместимости Продукта из-за технических усовершенствований и/или изменения технических норм;
- (в) Любое повреждение датчика;
- (г) Любые ухудшения работы дисплея, вызванные изнашиванием невосстановимых частей, таких как панель ЖКД и/или подсветка и т.д. (например, изменение в яркости, изменение в равномерности яркости, изменение в цветности, изменение в равномерности цветности, изменение в пикселях, включая выгоревшие пиксели и т.д.);
- (д) Любые дефекты Продукта, вызванные внешним оборудованием;
- (е) Любые дефекты Продукта, при которых оригинальный серийный номер был изменен или удален;
- (ж) Любые дефекты Продукта, вызванные протеканием батареек;
- (з) Любые естественные ухудшения продукта, в частности, вызванные износом расходных частей, принадлежностей и/или приспособлений (например, батареек, кнопок, вращающихся частей, пульта дистанционного управления, кабелей, Руководства пользователя и т.д.); и
- (и) Любые деформации, изменения цвета и/или коробления внешней поверхности продукта, включая поверхность панели ЖКД.

Чтобы получить техническое обслуживание в рамках Гарантии, Первоначальный покупатель должен доставить Продукт местному Дистрибутору, оплатив перевозку, в его оригинальной упаковке или в другой соответствующей упаковке, обеспечивающей равномерную степень защиты, принимая во внимание риск повреждения и/или утерю при транспортировке. При запросе технического обслуживания в рамках Гарантии Первоначальный покупатель должен предоставить свидетельство покупки продукта и даты покупки.

Гарантийный период для любого замененного и/или отремонтированного продукта в рамках Гарантии истекает в конце завершения срока действия оригинального Гарантийного периода.

EIZO ИЛИ ДИСТРИБУТОРЫ НЕ НЕСУТ ОТВЕТСТВЕННОСТИ ЗА ЛЮБЫЕ ПОВРЕЖДЕНИЯ ИЛИ УТЕРЮ ДАННЫХ ИЛИ ДРУГОЙ ИНФОРМАЦИИ, ХРАНЯЩИХСЯ НА КАКИХ-ЛИБО НОСИТЕЛЯХ ИНФОРМАЦИИ ИЛИ НА ЛЮБЫХ ДРУГИХ ЧАСТЯХ ПРОДУКТА, КОТОРЫЙ ВОЗВРАЩЕН EIZO ИЛИ ДИСТРИБУТОРАМ ДЛЯ РЕМОНТА.

EIZO и ДИСТРИБУТОРЫ НЕ ДАЮТ НИКАКОЙ ДАЛЬНЕЙШЕЙ ГАРАНТИИ, ВЫРАЖЕННОЙ ИЛИ ПОДРАЗУМЕВАЕМОЙ, ОТНОСИТЕЛЬНО ПРОДУКТА И ЕГО КАЧЕСТВА, ТЕХНИЧЕСКИХ ХАРАКТЕРИСТИК, ТОВАРНОСТИ ИЛИ СООТВЕТСТВИЯ ДЛЯ КАКОГО-ЛИБО ОПРЕДЕЛЕННОГО ИСПОЛЬЗОВАНИЯ. НИ ПРИ КАКИХ УСЛОВИЯХ EIZO ИЛИ ДИСТРИБУТОРЫ НЕ НЕСУТ ОТВЕТСТВЕННОСТИ ЗА ЛЮБОЙ СЛУЧАЙНЫЙ, КОСВЕННЫЙ, СПЕЦИАЛЬНЫЙ, ПОБОЧНЫЙ ИЛИ ИНОЙ УЩЕРБ (ВКЛЮЧАЯ, БЕЗ ОГРАНИЧЕНИЙ, УЩЕРБ ИЗ-ЗА НЕПОЛУЧЕННОЙ ПРИБЫЛИ, ПРЕРЫВАНИЯ БИЗНЕСА, ПОТЕРИ КОММЕРЧЕСКОЙ ИНФОРМАЦИИ ИЛИ ЛЮБЫЕ ДРУГИЕ ФИНАНСОВЫЕ ПОТЕРИ), ВОЗНИКШИЙ ИЗ-ЗА ИСПОЛЬЗОВАНИЯ ИЛИ НЕВОЗМОЖНОСТИ ИСПОЛЬЗОВАТЬ ПРОДУКТ ИЛИ В ЛЮБОЙ ДРУГОЙ СВЯЗИ С ПРОДУКТОМ, ЛИБО ОСНОВАННЫЙ НА КОНТРАКТНЫХ ОТНОШЕНИЯХ, ГРАЖДАНСКИХ ПРАВОНАРУШЕНИЯХ, НЕБРЕЖНОСТИ, ПРИЧИНЕНИЯ УЩЕРБА ТРЕТЬЕЙ СТОРОНЕ ИЛИ ЧЕМ-ЛИБО ЕЩЕ, ДАЖЕ ЕСЛИ EIZO ИЛИ ДИСТРИБУТОРЫ БЫЛИ УВЕДОМЛЕННЫ О ВОЗМОЖНОСТИ ТАКОГО УЩЕРБА. ЭТО ИСКЛЮЧЕНИЕ ТАКЖЕ ВКЛЮЧАЕТ ЛЮБЫЕ ОБЯЗАТЕЛЬСТВА, КОТОРЫЕ МОГУТ ВОЗНИКНУТЬ В РЕЗУЛЬТАТЕ ТРЕБОВАНИЙ ТРЕТЬЕЙ СТОРОНЫ В ОТНОШЕНИИ ПЕРВОНАЧАЛЬНОГО ПОКУПАТЕЛЯ. СУЩЕСТВОМ ЭТОГО ПОЛОЖЕНИЯ ЯВЛЯЕТСЯ ОГРАНИЧЕНИЕ ПОТЕНЦИАЛЬНОЙ ОТВЕТСТВЕННОСТИ EIZO И ДИСТРИБУТОРОВ, ВОЗНИКАЮЩЕЙ ИЗ-ЗА ЭТОЙ ОГРАНИЧЕННОЙ ГАРАНТИИ И/ЛИ ПРОДАЖ.

有限责任保证书

EIZO Corporation (以下简称“EIZO”)和EIZO授权的经销商(以下简称“经销商”),接受并依照本有限责任保证书(以下简称“保证书”)之条款,向从EIZO和经销商购买本文中规定产品(以下简称“产品”)的原买方(以下称“原买方”)提供保证:在保证期内(规定如下),如果原买方发现按本产品所附使用说明书(以下简称“用户手册”)所述方式正常使用本产品过程中,本产品出现故障或损坏,EIZO和经销商根据其独自的判断免费修理或更换该产品。

本保证期限定为本产品自购买本产品之日起的二(2)年(以下简称“保证期限”)。EIZO和经销商将不向原买方或任何第三方承担本保证书所规定之外的与本产品有关任何责任或义务。

本产品的任何部件停产七(7)年后,EIZO和经销商将不再保留或保管任何这类部件。维修显示器时,EIZO与经销商将使用符合我方质量控制标准的替换零件。

本保证书仅对于设有经销商的国家或地区有效。本保证书并不限定原买方的任何法律权利。

无论本保证书的任何其他条款如何规定,对于任何下列情况之一,EIZO和经销商将不承担本保证书规定责任:

- (a) 由于运输损害、改装、改动、滥用、误用、意外事故、错误安装、灾害、维护不善和/或由除EIZO和经销商以外的第三方进行不适当的修理造成本产品的任何故障。
- (b) 由于可能发生的技术变更和/或调整造成本产品的任何不兼容性。
- (c) 传感器的任何劣化。
- (d) 由于诸如液晶显示屏(LCD)和/或背灯等消耗品部件的老化造成的任何显示性能低劣(如亮度变化、亮度均一性变化、色彩变化、色彩均一性变化、如烧伤像素等像素缺陷)。
- (e) 因外部设备造成本产品的任何故障。
- (f) 因本产品的原序号被改变或消除造成本产品的任何故障。
- (g) 因电池液体泄漏造成本产品的任何故障。
- (h) 本产品的任何正常老化,尤其是消耗品、附件和/或附加装置(如电池、按钮、旋转部件、遥控器、电缆、用户手册等)、以及
- (i) 本产品表面包括液晶显示屏(LCD)表面的任何变形、变色和/或翘曲。

为了获得本保证书规定的服务,原买方必须使用原包装或其他具有同等保护程度的适当包装将本产品运送到当地的经销商,并且预付运费,承担运输中的损坏和/或损失的风险。要求提供本保证书规定的服务时,原买方必须提交购买本产品和标明此购买日期的证明。

按本保证书规定进行了更换和/或修理的任何产品的保证期限,将在原保证期限结束时终止。

在返回给EIZO和经销商进行修理后,任何产品的任何媒体或任何部件中储存的数据或其他信息发生任何损坏或损失,对此EIZO和经销商将不承担责任。

对于本产品及其质量、性能、可销售性以及对于特殊用途的适合性,EIZO和经销商不提供其他任何明示或暗示的保证。因使用本产品或无法使用本产品或因与本产品有任何关系(无论是否根据合同)而造成:任何附带的、间接的、特殊的、随之发生的或其他的损害(包括但不限于利润损失、业务中断、业务信息丢失或其他任何金钱损失)以及侵权行为、过失、严格赔偿责任或其他责任,即使已经向EIZO和经销商提出了发生这些损害的可能性,对此EIZO和经销商概不承担责任。本免责条款还包括因第三方向原买方提出索赔而可能发生的任何责任。本条款的本质是限定由于本有限责任保证书和/或销售本产品所发生的EIZO和经销商的潜在责任。

Recycling Information

Recycling Information

This product, when disposed of, is supposed to be collected and recycled according to your country's legislation to reduce environmental burden. When you dispose of this product, please contact a distributor or an affiliate in your country.

The contact addressees are listed on the EIZO website below.

<http://www.eizo.com>

For recycling information for customers in Switzerland, please refer to the following website.

<http://www.swico.ch>

Informationen zum Thema Recycling

Dieses Produkt muss gemäß den Vorschriften Ihres Landes zur Entlastung der Umwelt recyclet werden. Wenden Sie sich bei der Entsorgung dieses Produkts an einen Verteiler oder eine Tochtergesellschaft in Ihrem Land.

Die Adressen zur Kontaktaufnahme sind auf der unten angegebenen Website von EIZO aufgeführt.

<http://www.eizo.com>

Kunden in der Schweiz entnehmen Informationen zum Recycling der folgenden Website:

<http://www.swico.ch>

Informations sur le recyclage

Ce produit doit être jeté aux points de collecte prévus à cet effet et recyclé conformément à la législation de votre pays, afin de réduire l'impact sur l'environnement. Lorsque vous jetez ce produit, veuillez contacter un distributeur ou une société affiliée de votre pays.

Les adresses des distributeurs sont répertoriées sur le site Web EIZO ci-dessous.

<http://www.eizo.com>

Pour les clients en Suisse, veuillez consulter le site Web suivant afin d'obtenir des informations sur le recyclage.

<http://www.swico.ch>

Información sobre reciclaje

Este producto debe desecharse y reciclarse según la legislación del país para reducir el impacto medioambiental. Cuando desee deshacerse de este producto, póngase en contacto con un distribuidor o una filial de su país.

Encontrará las direcciones de contacto en el sitio web de EIZO que se indica a continuación.

<http://www.eizo.com>

Informazioni sul riciclaggio

Per lo smaltimento e il riciclaggio del presente prodotto, attenersi alle normative vigenti nel proprio paese per ridurre l'impatto ambientale. Per lo smaltimento, rivolgersi ad un distributore o un affiliato presenti nel proprio paese.

Gli indirizzi sono elencati nel sito Web EIZO riportato di seguito.

<http://www.eizo.com>

Per informazioni sul riciclaggio per i clienti in Svizzera, consultare il sito Web riportato di seguito.

<http://www.swico.ch>

Återvinningsinformation

När denna produkt kasseras ska den hanteras och återvinnas enligt landets föreskrifter för att reducera miljöpåverkan. När du kasserar produkten ska du kontakta en distributör eller representant i ditt land.

Kontaktadresserna listas på EIZO-webbplatsen nedan.

<http://www.eizo.com>

Πληροφορίες ανακύκλωσης

Το προϊόν αυτό, όταν απορρίπτεται, πρέπει να συλλέγεται και να ανακυκλώνεται σύμφωνα με τη νομοθεσία της χώρας σας έτσι ώστε να μην επιβαρύνει το περιβάλλον. Για να απορρίψετε το προϊόν, επικοινωνήστε με έναν αντιπρόσωπο ή μια θυγατρική εταιρεία στη χώρα σας.

Οι διευθύνσεις επικοινωνίας αναγράφονται στην τοποθεσία web της EIZO παρακάτω.

<http://www.eizo.com>

Сведения по утилизации

По истечении срока службы данного продукта его следует принести на сборный пункт и утилизировать в соответствии с действующими предписаниями в вашей стране, чтобы уменьшить вредное воздействие на окружающую среду. Прежде чем выбросить данный продукт, обратитесь к дистрибьютору или в местное представительство компании в вашей стране.

Контактные адреса можно найти на веб-узле EIZO.

<http://www.eizo.com>

Informatie over recycling

Wanneer u dit product wilt weggooien, moet het uit milieu-overwegingen worden verzameld en gerecycled volgens de betreffende wetgeving van uw land. Wanneer u dit product wilt weggooien, moet u contact opnemen met een distributeur of een partner in uw land.

De contactadressen worden vermeld op de volgende EIZO-website.

<http://www.eizo.com>

Informação sobre reciclagem

Este produto, quando o deitar fora, deve ser recolhido e reciclado de acordo com a legislação do seu país para reduzir a poluição. Quando deitar fora este produto, contacte um distribuidor ou uma filial no seu país.

Os endereços de contacto estão listados no website do EIZO, abaixo.

<http://www.eizo.com>

Oplysninger om genbrug

Denne produkt forventes ved bortskaffelse at blive indsamlet og genbrugt i overensstemmelse med lovgivningen i dit land for at reducere belastningen af miljøet. Når du bortskaffer denne produkt, skal du kontakte en distributør eller et tilknyttet selskab i dit land.

Adresserne på kontaktpersonerne er angivet på EIZO's websted nedenfor.

<http://www.eizo.com>

Kierrätystä koskevia tietoja

Tuote tulee hävittää kierrättämällä maan lainsäädännön mukaisesti ympäristön kuormittumisen vähentämiseksi. Kun hävität tuotteen, ota yhteyttä jälleenmyyjään tai tytäryhtiöön maassasi.

Yhteystiedot löytyvät EIZOn Internet-sivustolta.

<http://www.eizo.com>

Wykorzystanie surowców wtórnych

Ten produkt po zużyciu powinien być zbierany i przetwarzany zgodnie z krajowymi przepisami dotyczącymi ochrony środowiska. Wyrzucając ten produkt, należy skontaktować się z lokalnym dystrybutorem lub partnerem. Adresy kontaktowe można znaleźć we wskazanej poniżej witrynie internetowej firmy EIZO.

<http://www.eizo.com>

Informace o recyklaci

Při likvidaci produktu musí být produkt vyzvednut a recyklován podle zákonů příslušné země, aby nedocházelo k zatěžování životního prostředí. Zbavujete-li se produktu, kontaktujte distributora nebo pobočku ve své zemi. Kontaktní adresy jsou uvedeny na následující webové stránce společnosti EIZO.
<http://www.eizo.com>

Ringlussevõtu alane teave

Keskkonnakoormuse vähendamiseks tuleks kasutatud tooted kokku koguda ja võtta ringlusse vastavalt teie riigi seadustele. Kui kõrvaldate käesoleva toote, võtke palun ühendust turustaja või filiaaliga oma riigis. Kontaktisikud on toodud EIZO veebilehel järgmisel aadressil:
<http://www.eizo.com>

Újrahasznosítási információ

Jelen terméket, amikor eldobjuk, az illető ország törvényei alapján kell összegyűjteni és újrahasznosítani, hogy csökkentsük a környezet terhelését. Amikor ezt a terméket eldobja, kérjük lépjen kapcsolatba egy országon belüli forgalmazóval vagy társvállalkozással.
A kapcsolat címei az EIZO alábbi weboldalán találhatók felsorolva:
<http://www.eizo.com>

Podatki o recikliranju

Ob koncu uporabe odslužen izdelek izročite na zbirno mesto za recikliranje v skladu z okoljevarstveno zakonodajo vaše države. Prosim, da se pri odstranjevanju izdelka obrnete na lokalnega distributerja ali podružnico.
Kontaktne naslovi so objavljeni na spodaj navedenih spletnih straneh EIZO:
<http://www.eizo.com>

Informácie o recyklácii

Pri likvidácii musí byť tento výrobok recyklovaný v súlade s legislatívou vašej krajiny, aby sa znížilo zaťaženie životného prostredia. Keď sa chcete zbaviť tohto výrobku, kontaktujte prosím distribútora alebo pobočku vo vašej krajine.
Zoznam kontaktných adries je uvedený na nasledovnej webovej stránke firmy EIZO:
<http://www.eizo.com>

Pārstrādes informācija

Utilizējot šo produktu, tā savākšana un pārstrāde veicama atbilstoši jūsu valsts likumdošanas prasībām attiecībā uz slodzes uz vidi samazināšanu. Lai veiktu šī produkta utilizāciju, sazinieties ar izplatītāju vai pārstāvniecību jūsu valstī.
Kontaktadrese ir norādītas zemāk minētajā EIZO tīmekļa vietnē.
<http://www.eizo.com>

Informacja apie gražinamąjį perdirbimą

Šalinant (išmetant) šiuos gaminius juos reikia surinkti ir perdirbti gražinamuoju būdu pagal jūsų šalies teisės aktus, siekiant sumažinti aplinkos teršimą. Kai reikia išmesti šį gaminį, kreipkitės į jūsų šalyje veikiančią gaminių pardavimo atstovybę arba jos filiaalą.
Kontaktiniai adresatai nurodyti EIZO interneto svetainėje.
<http://www.eizo.com>

Информация относно рециклиране

При изхвърлянето на този продукт се предлага събирането и рециклирането му съобразно законите на вашата страна за да се намали замърсяването на околната среда. Когато искате да се освободите от този продукт, моля свържете се с търговския му представител или със съответните органи отговарящи за това във вашата страна.

Данните за връзка с нас са описани на следния Интернет сайт на EIZO:
<http://www.eizo.com>

Informație referitoare la reciclare

Acest produs, când debarasat, trebuie colectat și reciclat conform legislației țării respective ca să reducem sarcina mediului. Când se debarasează de acest produs, vă rugăm să contactați un distribuitor sau un afiliat al țării respective.

Adresele de contact le găsiți pe pagina de web al EIZO:
<http://www.eizo.com>

معلومات عن إعادة التدوير

عند التخلص من هذا المنتج، من الضروري تجميعه وإعادة تدويره وفقاً للقوانين المتبعة في بلدك لتقليل العبء المسلط على البيئة. عندما تتخلص من هذا المنتج، يرجى الاتصال بموزع أو طرف متنسب إليه في بلدك. عناوين الاتصال مدرجة في موقع ايزو EIZO ادناه على شبكة الانترنت.

<http://www.eizo.com>

Geri Dönüşüm Bilgisi

Bu ürünün, atılacağı zaman, ülkenizin çevre kirliliğinin azaltılması konusundaki mevzuatına göre toplanması ve yeniden değerlendirilmesi gerekmektedir. Ürünü atacağınız zaman lütfen ülkenizdeki bir distribütör veya ilgili kuruluşla temasa geçiniz.

İrtibat adresleri aşağıdaki EIZO web sitesinde verilmiştir.
<http://www.eizo.com>

China Measures for RoHS Compliance in ChinaRoHS

关于电子信息产品污染控制标识



本标识根据「电子信息产品污染控制管理办法」，适用于在中华人民共和国销售的电子信息产品。标识中央的数字为环保使用期限的年数。只要您遵守该产品相关的安全及使用注意事项，在自制造日起算的年限内，不会产生对环境污染或人体及财产的影响。上述标识粘贴在机器背面。

• 有毒有害物质或元素的名称及含量

部件名称	有毒有害物质或元素					
	铅 (Pb)	汞 (Hg)	镉 (Cd)	六价铬 (Cr(VI))	多溴联苯 (PBB)	多溴二苯醚 (PBDE)
印刷电路板	×	○	○	○	○	○
机箱	○	○	○	○	○	○
液晶显示器	×	○	○	○	○	○
其他	×	○	○	○	○	○

○：表示该有毒有害物质在该部件所有均质材料中的含量均在 SJ/T 11363-2006 规定的限量要求以下。
×：表示该有毒有害物质至少在该部件的某一均质材料中的含量超出 SJ/T 11363-2006 规定的限量要求。
(企业可在此处，根据实际情况对上表中打“×”的技术原因进行进一步说明)

