

# Panasonic®

## Operating Instructions

SD Video Camera

Model No. **SDR-S70**  
**SDR-T70**

SD/HDD Video Camera

Model No. **SDR-H100**

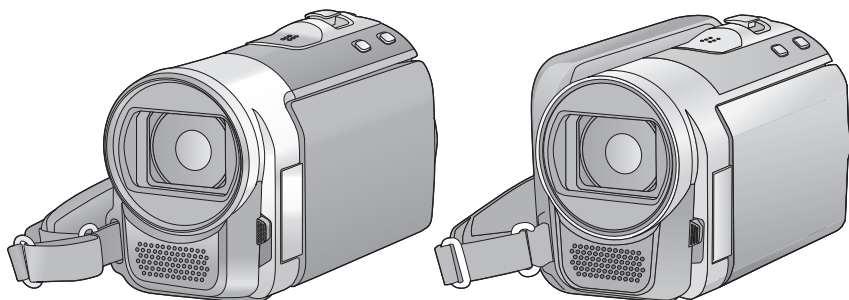

Before use, please read these instructions completely.



Web Site: <http://www.panasonic-europe.com>

VQT3H99

# Information for Your Safety

## WARNING:

TO REDUCE THE RISK OF FIRE, ELECTRIC SHOCK OR PRODUCT DAMAGE,

- DO NOT EXPOSE THIS APPARATUS TO RAIN, MOISTURE, DRIPPING OR SPLASHING AND THAT NO OBJECTS FILLED WITH LIQUIDS, SUCH AS VASES, SHALL BE PLACED ON THE APPARATUS.
- USE ONLY THE RECOMMENDED ACCESSORIES.
- DO NOT REMOVE THE COVER (OR BACK); THERE ARE NO USER SERVICEABLE PARTS INSIDE. REFER SERVICING TO QUALIFIED SERVICE PERSONNEL.

## CAUTION!

- DO NOT INSTALL OR PLACE THIS UNIT IN A BOOKCASE, BUILT-IN CABINET OR IN ANOTHER CONFINED SPACE. ENSURE THE UNIT IS WELL VENTILATED. TO PREVENT RISK OF ELECTRIC SHOCK OR FIRE HAZARD DUE TO OVERHEATING, ENSURE THAT CURTAINS AND ANY OTHER MATERIALS DO NOT OBSTRUCT THE VENTILATION VENTS.
- DO NOT OBSTRUCT THE UNIT'S VENTILATION OPENINGS WITH NEWSPAPERS, TABLECLOTHS, CURTAINS, AND SIMILAR ITEMS.
- DO NOT PLACE SOURCES OF NAKED FLAMES, SUCH AS LIGHTED CANDLES, ON THE UNIT.
- DISPOSE OF BATTERIES IN AN ENVIRONMENTALLY FRIENDLY MANNER.

The socket outlet shall be installed near the equipment and easily accessible. The mains plug of the power supply cord shall remain readily operable. To completely disconnect this apparatus from the AC Mains, disconnect the power supply cord plug from AC receptacle.

## Warning

Risk of fire, explosion and burns. Do not disassemble, heat above 60 °C or incinerate.

## ■ EMC Electric and magnetic compatibility

This symbol (CE) is located on the rating plate.

**Use only the recommended accessories.**

- Do not use any other AV cables and USB cables except the supplied one.
- Keep the Memory Card out of reach of children to prevent swallowing.

## ■ Product identification marking

Product	Location
SD Video Camera	Bottom
SD/HDD Video Camera	Bottom
AC adaptor	Bottom

## ■ Information for Users on Collection and Disposal of Old Equipment and used Batteries



These symbols on the products, packaging, and/or accompanying documents mean that used electrical and electronic products and batteries should not be mixed with general household waste.

For proper treatment, recovery and recycling of old products and used batteries, please take them to applicable collection points, in accordance with your national legislation and the Directives 2002/96/EC and 2006/66/EC.

By disposing of these products and batteries correctly, you will help to save valuable resources and prevent any potential negative effects on human health and the environment which could otherwise arise from inappropriate waste handling.

For more information about collection and recycling of old products and batteries, please contact your local municipality, your waste disposal service or the point of sale where you purchased the items.

Penalties may be applicable for incorrect disposal of this waste, in accordance with national legislation.



### For business users in the European Union

If you wish to discard electrical and electronic equipment, please contact your dealer or supplier for further information.

### [Information on Disposal in other Countries outside the European Union]

These symbols are only valid in the European Union. If you wish to discard these items, please contact your local authorities or dealer and ask for the correct method of disposal.



### Note for the battery symbol (bottom two symbol examples):

This symbol might be used in combination with a chemical symbol. In this case it complies with the requirement set by the Directive for the chemical involved.

## ■ Indemnity about recorded content

Panasonic does not accept any responsibility for damages directly or indirectly due to any type of problems that result in loss of recording or edited content, and does not guarantee any content if recording or editing does not work properly. Likewise, the above also applies in a case where any type of repair is made to the unit (including any other non-built-in memory/HDD related component).

These operating instructions are designed for use with models **SDR-H100**, **SDR-S70** and **SDR-T70**. Pictures may be slightly different from the original.

- The illustrations used in these operating instructions show model **SDR-S70**, however, parts of the explanation refer to different models.
- Depending on the model, some functions are not available.
- Features may vary, so please read carefully.
- Not all models may be available depending on the region of purchase.

## ■ For the purposes of these operating instructions

- SD Memory Card, SDHC Memory Card and SDXC Memory Card are referred to as the “SD card”.
- Functions that can be used for motion picture recording/motion picture playback are indicated by **VIDEO** in these operating instructions.
- Functions that can be used for still picture recording/still picture playback are indicated by **PHOTO** in these operating instructions.
- Pages for reference are indicated by an arrow, for example: → 00

## ■ Handling of built-in memory [SDR-T70]

This unit is equipped with the built-in 4 GB memory. When using this component, pay attention to the following points.

### Back up data periodically.

The built-in memory is temporary storage. In order to avoid erasing data due to static electricity, electromagnetic waves, breakage, and failures, back up the data to a PC or DVD disc. (→ 77, 84)

- Access lamp [ACCESS] (→ 9) illuminates while the SD card or built-in memory is being accessed (initialization, recording, playback, deleting etc.). Do not perform the following operations when the lamp illuminates. It may damage the built-in memory or cause a malfunction in the unit.
  - Turn off the power (remove the battery)
  - Insert and remove the USB cable
  - Expose the unit to vibrations or shock
- About disposing of or giving away this unit. (→ 108)

## ■ Handling of HDD [SDR-H100]

This unit is equipped with the built-in 80 GB HDD. While the HDD is capable of storing a large amount of data, there are a few things to look out for. When using this component, pay attention to the following points.

### Do not expose the HDD to vibrations and shocks.

Due to the environment and handling conditions, the HDD may be subject to partial damages or may not be able to read, record, and play back data. Do not expose the unit to vibrations or shock, and do not turn off the power during recording or playback.

**If the unit is used in a place with loud sounds, such as a club or venue, the recording may stop due to sound vibrations. Recording data on an SD card is recommended in these places.**

### Back up data periodically.

The HDD is temporary storage. In order to avoid erasing data due to static electricity, electromagnetic waves, breakage, and failures, back up the data to a PC or DVD disc. (→ 77, 84)

### If the HDD experiences any abnormality, back up data immediately.

Failure in the HDD may produce continuous noise or choppy sound during recording or playing back. Continuous use will cause further deterioration, and may eventually disable the HDD. If these phenomena are observed, copy the data on the HDD to a PC, a DVD disc etc. immediately and contact your dealer.

Once the HDD is out of order, data cannot be restored.

### Operation may stop in hot or cold environments.

The unit is disabled in order to protect the HDD.

## **Do not use the unit in low atmospheric pressures.**

The HDD may fail if it is used at altitudes of 3000 m or higher above sea level.

## **Transportation**

When the unit is transported, turn off the power and be careful not to shake, fall, or impact the unit.

## **Falling detection**

[  ] is indicated on the screen when it detects a falling state (a weightless state). If the falling state is detected repeatedly, the unit may stop the recording or playback operation in order to protect the HDD.

- HDD access lamp [ACCESS HDD] (→ 11) illuminates while the HDD is being accessed (initialization, recording, playback, deleting etc.). Do not perform the following operations when the lamp illuminates. It may damage the HDD or cause a malfunction in the unit.
  - Turn off the power (remove the battery)
  - Insert and remove the USB cable
  - Expose the unit to vibrations or shock
- About disposing of or giving away this unit. (→ 108)

## **■ Carefully observe copyright laws**

**Recording of pre-recorded tapes or discs or other published or broadcast material for purposes other than your own private use may infringe copyright laws. Even for the purpose of private use, recording of certain material may be restricted.**

## **■ Cards that you can use with this unit**

### **SD Memory Card, SDHC Memory Card and SDXC Memory Card**

- 4 GB (or more) Memory Cards that do not have the SDHC logo or 48 GB (or more) Memory Cards that do not have the SDXC logo are not based on SD Memory Card Specifications.
- Refer to page 18 for more details on SD cards.

## **■ Licenses**

- SDXC Logo is a trademark of SD-3C, LLC.
- Microsoft<sup>®</sup>, Windows<sup>®</sup> and Windows Vista<sup>®</sup> are either registered trademarks or trademarks of Microsoft Corporation in the United States and/or other countries.
- Microsoft product screen shot(s) reprinted with permission from Microsoft Corporation.
- IBM and PC/AT are registered trademarks of International Business Machines Corporation of the U.S.
- Intel<sup>®</sup>, Core™, Pentium<sup>®</sup> and Celeron<sup>®</sup> are the registered trademarks or trademarks of Intel Corporation in the United States and other countries.
- iMovie and Mac are trademarks of Apple Inc., registered in the U.S. and other countries.
- PowerPC is a trademark of International Business Machines Corporation.
- Other names of systems and products mentioned in these instructions are usually the registered trademarks or trademarks of the manufacturers who developed the system or product concerned.

This product is licensed under the AVC patent portfolio license for the personal and non-commercial use of a consumer to (i) encode video in compliance with the AVC Standard ("AVC Video") and/or (ii) decode AVC Video that was encoded by a consumer engaged in a personal and non-commercial activity and/or was obtained from a video provider licensed to provide AVC Video. No license is granted or shall be implied for any other use. Additional information may be obtained from MPEG LA, LLC. See <http://www.mpegla.com>.

# Contents

Information for Your Safety.....	2
Accessories.....	8

## Preparation

Before using	
<b>1</b> Parts identification and handling.....	9
Setup	
<b>1</b> Power supply.....	12
Inserting the battery .....	13
Charging the battery .....	14
Charging and recording time.....	16
<b>2</b> Recording to a card .....	18
Cards that you can use with this unit.....	18
Inserting/removing an SD card ....	20
<b>3</b> Turning the unit on/off .....	21
Turning the power on and off with the power button.....	21
Turning the power on and off with the LCD monitor .....	21
<b>4</b> Selecting a mode .....	22
<b>5</b> Using the menu screen .....	23
Language selection.....	24
Menu list.....	24
<b>6</b> Setting date and time.....	28
World time setting (Displaying the time of the travel destination).....	29
<b>7</b> Adjusting LCD monitor.....	31
LCD monitor adjustment .....	31
Recording Yourself.....	32

## Recording

Recording (Basic)	
<b>1</b> Before recording.....	33
Intelligent auto mode .....	34
Quick start.....	36
Quick power on .....	37
<b>2</b> Recording motion pictures .....	38
Selecting a media to record [SDR-T70]/[SDR-H100] .....	39
Recording modes/approximate recordable time .....	40
Shooting guide.....	41
<b>3</b> Recording still pictures .....	42
Picture size .....	43
Simultaneous recording (recording still pictures while recording motion pictures) .....	43
Approximate number of recordable pictures .....	43
<b>4</b> Recording functions .....	44
Enhanced optical zoom .....	44
Digital zoom function .....	44
Image stabilizer function .....	45
<b>5</b> AF/AE tracking.....	46
Recording (Advanced)	
<b>1</b> Recording functions of operation icons .....	47
Operation icons.....	47
<b>2</b> Recording functions of menus .....	51
<b>3</b> Manual recording functions.....	55
White balance .....	56
Manual shutter speed/iris adjustment.....	57
Recording with manual focus.....	58

## Playback

### Playback

- 1 Motion picture playback** ..... 59
  - Creating still picture from motion picture ..... 62
  - Time frame index ..... 62
  - Playing back motion pictures by date ..... 63
  - Repeat playback ..... 64
  - Resuming the previous playback ..... 64
- 2 Still picture playback** ..... 65
  - Playing back still pictures by date ..... 66
  - Changing the playback setting and playing back the slide show ..... 67

### Editing

- 1 Deleting scenes/still pictures** ... 68
  - Protecting scenes/still pictures..... 69
- 2 Dividing a scene to partially delete [SDR-T70]/[SDR-H100]**.... 70
- 3 DPOF setting** ..... 71
- 4 Copying between SD card and Built-in Memory/HDD [SDR-T70]/[SDR-H100]** ..... 72
  - Copying ..... 73
- 5 Formatting** ..... 74

### With a TV

- 1 Watching Video/Pictures on your TV**.....75

## Backup

### With other products

- 1 Connecting a DVD burner to copy to/play back a disc**..... 77
  - Preparing for copying/playing back ..... 77
  - Copying to discs ..... 79
  - Playing back the copied disc ..... 81
  - Managing the copied disc ..... 82
- 2 Dubbing images onto other video device** ..... 83

## With a PC

### Before using

- 1 What you can do with a PC**..... 84
  - End User License Agreement..... 86
- 2 Operating environment** ..... 87

### Setup

- 1 Installation** ..... 90
- 2 Connecting to a PC**..... 92
  - About the PC display ..... 95

### Using with a PC

- 1 Starting VideoCam Suite 3.5** .... 96
  - Reading the operating instructions of the software applications ..... 96
- 2 If using Mac** ..... 97

## Others

### Indications

- 1 Indications**..... 98
- 2 Messages**..... 100
  - About recovery..... 101

### Helpful hints

- 1 Functions that cannot be used simultaneously**.....102
  - 2 Troubleshooting**..... 103
- Cautions for use** ..... 107

# Accessories

Check the accessories before using this unit.

Keep the accessories out of reach of children to prevent swallowing.

Product numbers correct as of December 2010. These may be subject to change.

## Battery pack

VW-VBL090  
(SDR-S70)  
(SDR-T70)



## Battery pack

VW-VBK180  
(SDR-H100)



## AC adaptor

VSK0712

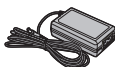

## AC cable

K2CQ29A00002



## AV cable

K2KC4CB00027



## USB cable

K1HA05AD0007



## CD-ROM

Software



## CD-ROM

Operating Instructions  
VFF0741



## Optional accessories

Some optional accessories may not be available in some countries.

Battery charger (VW-BC10E)
Battery pack (lithium/VW-VBL090) (SDR-S70) (SDR-T70)
Battery pack (lithium/VW-VBK180)
Battery pack (lithium/VW-VBK360)
Video DC light (VW-LDC103E)*
Light bulb for video DC light (VZ-LL10E)
Shoe adaptor (VW-SK12E)
DVD burner (VW-BN01)
Accessory kit (VW-ACK180E)

\* The shoe adaptor VW-SK12E and battery pack VW-VBG130/VW-VBG260 are required to use the VW-LDC103E. The AC adaptor VW-AD21E-K/VW-AD20E-K is required to charge the battery pack VW-VBG130/VW-VBG260.

## 1

## Parts identification and handling

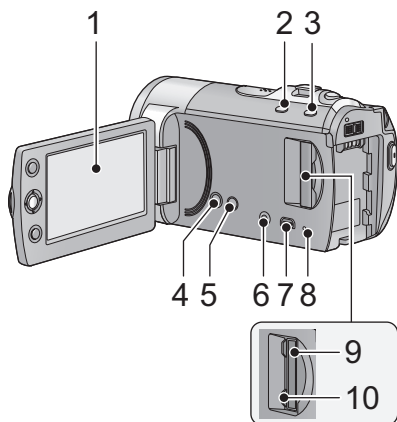

## 1 LCD monitor

- Pull the LCD monitor out in the direction of the arrow with your fingers.



- It can open up to 90°.

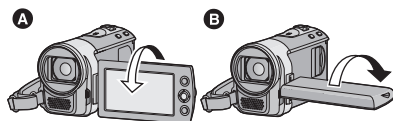

- It can rotate up to 180° **A** towards the lens or 90° **B** towards the opposite direction.
- The brightness and colour level of the LCD monitor can be adjusted. (→ 31)

Due to limitations in LCD production technology, there may be some tiny bright or dark spots on the LCD monitor screen. However, this is not a malfunction and does not affect the recorded picture.

## 2 Intelligent auto/Manual button [iA/MANUAL] (→ 34)

## 3 Optical image stabilizer button [O.I.S.] (→ 45)

## 4 Power button [ON/OFF] (→ 21)

## 5 Delete button [DELETE] (→ 68)

## 6 Audio-video output terminal [A/V] (→ 75, 83)

- Use the AV cable (only the supplied cable).

## 7 USB terminal [USB] (→ 78, 92)

## 8 Access lamp [ACCESS] (→ 20)

## 9 SD card slot (→ 20)

## 10 SD card cover [SD CARD] (→ 20)

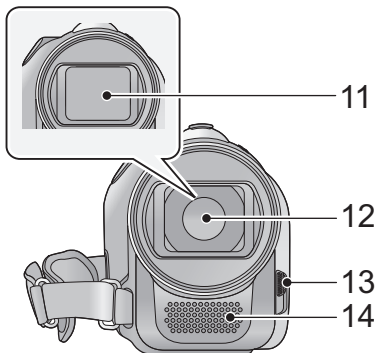

**11 Lens cover**

**12 Lens**

**13 Open/close switch for the lens cover**

For the lens protection, be sure to close the lens cover when not in use.

**Slide open/close switch for the lens cover.**

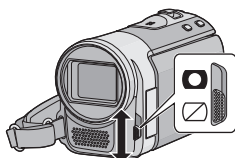

**14 Microphone (built-in, stereo)**

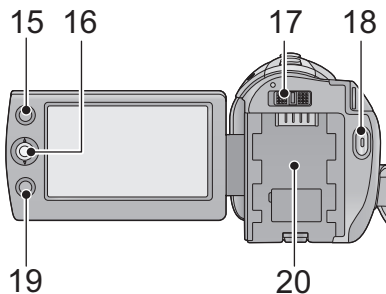

**15 AF/AE button [AF/AE] (→ 46)**

**16 Joystick**

Use the joystick to select the recording functions and playback operations, and to operate the menu screen.

**Move the joystick up, down, left, or right to select a setting or scene and then press the joystick to set it.**

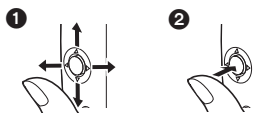

**1** Select by moving up, down, left or right.

**2** Set by pressing the centre.

- Menu screen operations (→ 23)

- To select the recording functions (→ 47)

- To adjust manually (→ 55)

- Playback operations (→ 59, 65)

**17 Mode switch (→ 22)**

**18 Recording start/stop button (→ 38)**

**19 Menu button [MENU] (→ 23)**

**20 Battery holder (→ 13)**

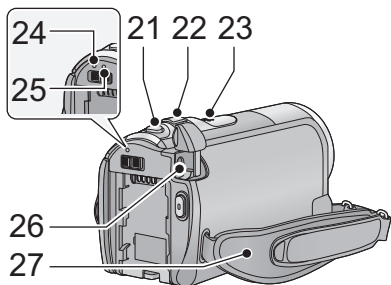

- 21 Photoshot button [  ] (→ 42)
- 22 When recording: Zoom lever [W/T] (→ 44)

When playing back: Thumbnail display switch [  /  ] (→ 60)/ Volume lever [-VOL+] (→ 61)

- 23 Speaker
  - 24 Status indicator (→ 21)
  - 25 HDD access lamp [ACCESS HDD] (SDR-H100) (→ 5)
  - 26 DC input terminal [DC IN] (→ 14)
    - Do not use any other AC adaptors except the supplied one.
  - 27 Grip belt
- Adjust the belt length and the pad position.

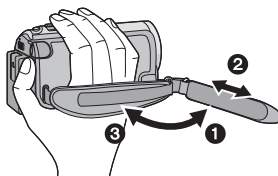

- ❶ Flip the belt.
- ❷ Adjust the length.
- ❸ Replace the belt.

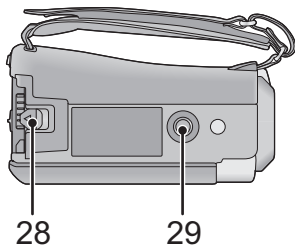

- 28 Battery release lever [BATTERY] (→ 13)
- 29 Tripod receptacle

**■ About batteries that you can use with this unit**

SDR-S70 / SDR-T70

The battery that can be used with this unit is VW-VBL090/VW-VBK180/VW-VBK360.

SDR-H100

The battery that can be used with this unit is VW-VBK180/VW-VBK360.

- **SDR-H100** The unit has a function for distinguishing batteries which can be used safely. The dedicated battery (VW-VBK180/VW-VBK360) supports this function. The only batteries suitable for use with this unit are genuine Panasonic products and batteries manufactured by other companies and certified by Panasonic. (Batteries which do not support this function cannot be used). Panasonic cannot in any way guarantee the quality, performance or safety of batteries which have been manufactured by other companies and are not genuine Panasonic products.

It has been found that counterfeit battery packs which look very similar to the genuine product are made available to purchase in some markets. Some of these battery packs are not adequately protected with internal protection to meet the requirements of appropriate safety standards. There is a possibility that these battery packs may lead to fire or explosion. Please be advised that we are not liable for any accident or failure occurring as a result of use of a counterfeit battery pack. To ensure that safe products are used we would recommend that a genuine Panasonic battery pack is used.

## Inserting the battery

- Press the power button to turn off the power. (→ 21)

Install the battery by inserting it in the direction shown in the figure.

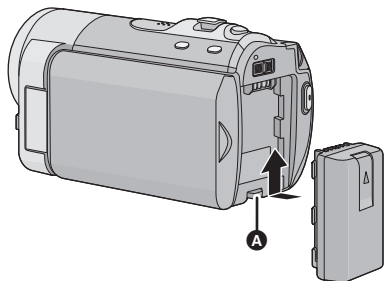

- A** Insert the battery until it clicks and locks.

## Removing the battery

Be sure to hold down the power button until the status indicator goes off. Then remove the battery while supporting the unit to prevent it from dropping.

**Move the battery release lever in the direction indicated by the arrow and remove the battery when unlocked.**

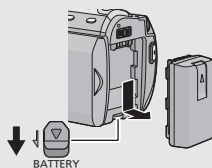

## Charging the battery

**When this unit is purchased, the battery is not charged. Charge the battery before using this unit.**

The unit is in the standby condition when the AC adaptor is connected. The primary circuit is always “live” as long as the AC adaptor is connected to an electrical outlet.

- The battery will not be charged if the power is turned on.
- It is recommended to charge the battery in a temperature between 10 °C to 30 °C. (The battery temperature should also be the same.)

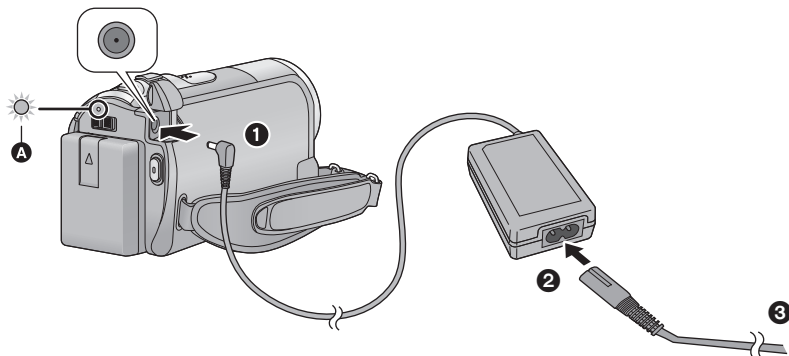

**1** Connect the AC adaptor to this unit's DC input terminal.

**2** Connect the AC cable to the AC adaptor, then the AC outlet.

- For the AC cable, plug in **2** and then **3**.
- The status indicator **A** will flash red at an interval of 2 seconds, indicating that charging has begun.

## ■ Connecting to the AC outlet

If you turn on this unit while charging the battery using the AC adaptor, you can use the power supplied from the AC outlet to power the unit for use.

---

- Refer to page 110 when the status indicator flashes either rapidly or slowly.
- We recommend using Panasonic batteries (→ 8, 16).
- If you use other batteries, we cannot guarantee the quality of this product.
- Do not heat or expose to flame.
- Do not leave the battery(ies) in an automobile exposed to direct sunlight for a long period of time with doors and windows closed.

### **CAUTION**

Danger of explosion if battery is incorrectly replaced. Replace only with the same or equivalent type recommended by the manufacturer. Dispose of used batteries according to the manufacturer's instructions.

## Charging and recording time

### ■ Charging/Recording time

- Temperature: 25 °C/humidity: 60%RH (When using AC adaptor)

SDR-S70/SDR-T70			
Battery model number [Voltage/Capacity (minimum)]	Charging time	Maximum continuously recordable time	Actual recordable time
Supplied battery/ VW-VBL090 (optional) [3.6 V/895 mAh]	2 h 20 min	1 h 20 min	40 min
VW-VBK180 (optional) [3.6 V/1790 mAh]	2 h 25 min	2 h 55 min	1 h 30 min
VW-VBK360 (optional) [3.6 V/3580 mAh]	4 h 20 min	6 h	3 h 10 min

SDR-H100					
Battery model number [Voltage/ Capacity (minimum)]	Charging time	Recording destination	Recording mode	Maximum continuously recordable time	Actual recordable time
Supplied battery/ VW-VBK180 (optional) [3.6 V/1790 mAh]	2 h 25 min	HDD	XP	2 h 30 min	1 h 15 min
			SP/LP	2 h 30 min	1 h 20 min
		SD	XP/SP	2 h 35 min	1 h 20 min
LP	2 h 40 min		1 h 25 min		
VW-VBK360 (optional) [3.6 V/3580 mAh]	4 h 20 min	HDD	XP	5 h	2 h 40 min
			SP	5 h 5 min	2 h 40 min
			LP	5 h 10 min	2 h 45 min
		SD	XP	5 h 15 min	2 h 45 min
			SP	5 h 20 min	2 h 50 min
			LP	5 h 25 min	2 h 50 min



- These times are approximations.
- **The indicated charging time is for when the battery has been discharged completely. Charging time and recordable time vary depending on the usage conditions such as high/low temperature.**
- VW-VBL090 is not available for **SDR-H100**.

- 
- The actual recordable time refers to the recordable time when repeatedly starting/stopping recording, turning the unit on/off, moving the zoom lever etc.
  - The batteries heat up after use or charging. This is not a malfunction.

### Battery capacity indication

- The display changes as the battery capacity reduces.



If the indication becomes , the icon will become red. If the battery discharges, then () will flash.

#### **SDR-H100**

- The remaining battery capacity is displayed when using the Panasonic battery that you can use for this unit. It may take time to display the remaining battery capacity. The actual time can vary depending on your actual use.
- When using the AC adaptor or batteries made by other companies, the remaining battery capacity will not be shown.

# Recording to a card

The unit can record still pictures or motion pictures to an SD card, built-in memory, or HDD. To record to an SD card, read the following.

This unit (an SDXC compatible device) is compatible with SD Memory Cards, SDHC Memory Cards and SDXC Memory Cards. When using an SDHC memory card/SDXC memory card with other equipment, check the equipment is compatible with these memory cards.

## Cards that you can use with this unit

Use SD cards conforming to Class 2 or higher of the SD Speed Class Rating\* for motion picture recording.

Card type	Capacity	Motion picture recording	Still picture recording
SD Memory Card	8 MB/16 MB/32 MB	Cannot be used.	Can be used.
	64 MB/128 MB/256 MB	Cannot be guaranteed in operation. The recording may suddenly stop during motion picture recording depending on the SD card you use. (→ 104)	
	512 MB/1 GB/2 GB	Can be used.	
SDHC Memory Card	4 GB/6 GB/8 GB/12 GB/16 GB/24 GB/32 GB		
SDXC Memory Card	48 GB/64 GB		

\* The SD Speed Class Rating is the speed standard for successive writes. Check via the label on the card, etc.

Example:



- 
- Please confirm the latest information about SD Memory Cards/SDHC Memory Cards/SDXC Memory Cards that can be used for motion picture recording on the following website.

**[http://panasonic.jp/support/global/cs/e\\_cam](http://panasonic.jp/support/global/cs/e_cam)**

(This website is in English only.)

- 4 GB or more Memory Cards that do not have the SDHC logo or 48 GB or more Memory Cards that do not have the SDXC logo are not based on SD Memory Card Specifications.
- When the write-protect switch **A** on SD card is locked, no recording, deletion or editing will be possible on the card.
- Keep the Memory Card out of reach of children to prevent swallowing.



## Inserting/removing an SD card

When using an SD card not from Panasonic, or one previously used on other equipment, for the first time on this unit, format the SD card. (→ 74) When the SD card is formatted, all of the recorded data is deleted. Once the data is deleted, it cannot be restored.

### Caution:

Check that the access lamp has gone off.

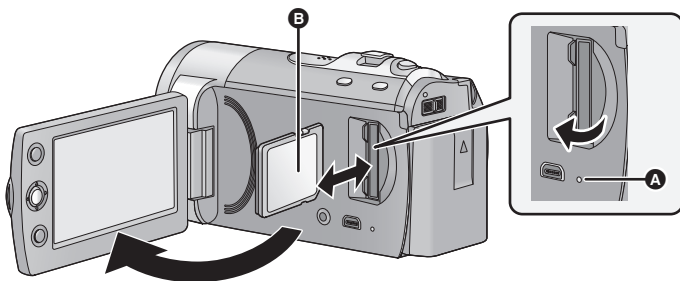

### Access lamp [ACCESS] **A**

- When this unit is accessing the SD card or built-in memory, the access lamp lights up.

**1** Open the LCD monitor.

**2** Open the SD card cover and insert (remove) the SD card into (from) the card slot.

- Face the label side **B** in the direction shown in the illustration and press it straight in as far as it will go.
- Press the centre of the SD card and then pull it straight out.

**3** Securely close the SD card cover.

- 
- Do not touch the terminals on the back of the SD card.
  - See page 110 for details on handling the SD card.

# Turning the unit on/off

You can turn the power on and off using the power button or by opening and closing the LCD monitor.

## Turning the power on and off with the power button

Press the power button to turn on the power.

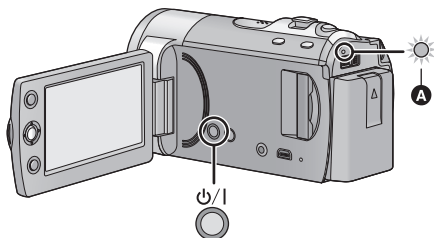

### To turn off the power

Hold down the power button until the status indicator goes off.

**A** The status indicator lights.

## Turning the power on and off with the LCD monitor

Power is turned on when the LCD monitor is opened, and power is turned off when it is closed.

**During normal use, opening and closing of the LCD monitor can be conveniently used to turn the power on/off.**

### ■ To turn on the power

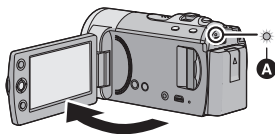

**A** The status indicator lights.

### ■ To turn off the power

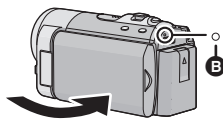



**B** The status indicator goes off.

- In the following cases, opening the LCD monitor does not turn on the power. Press the power button to turn on the power.
  - When the unit is purchased
  - When you have turned off the power using the power button
- The power will not turn off while recording motion pictures even if the LCD monitor is closed.



## 4

## Selecting a mode

Change the mode to recording or playback.

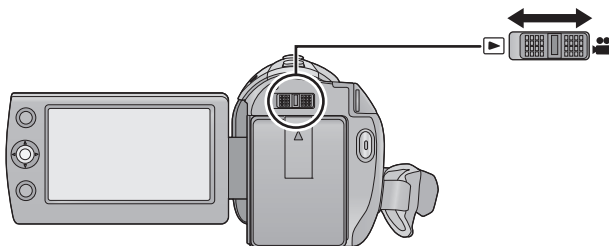
**Operate the mode switch to change the mode to  or .**



	Recording mode (→ 38, 42)
	Playback mode (→ 59, 65)

## Using the menu screen

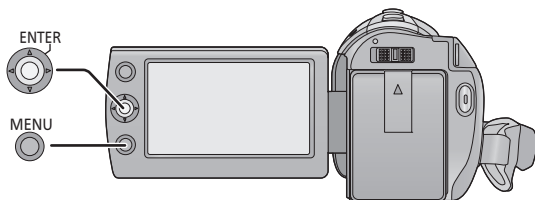

- 1 Press the MENU button.
- 2 Select the desired top menu **A**, then move the joystick right or press the joystick.

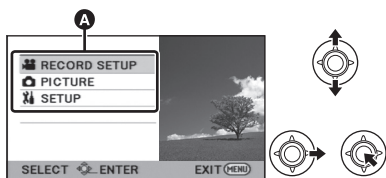

- 3 Select the submenu item **B**, then move the joystick right or press the joystick.

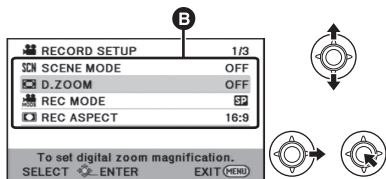

- Descriptions of submenus and current settings on menus are displayed scrolling at the bottom of the screen.

- 4 Select the desired setting, then press the joystick to enter the selection.

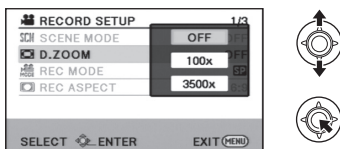

*To get back to the previous screen*  
Move the joystick left.

*To exit the menu screen*  
Press the MENU button.

## Language selection

You can select the language on the screen display and the menu screen.

- 1 Press the MENU button, then select [SETUP] → [LANGUAGE] and press the joystick.**
- 2 Select [English] and press the joystick.**

## Menu list

Part of the menu will not be used depending on the used functions. (→ 102)

### Recording mode

- \*1 It is not displayed when the Intelligent auto mode is on.
- \*2 It is displayed only when the Intelligent auto mode is on.
- \*3 These menus are only for .
- \*4 These menus are only for .
- \*5 These menus are only for .
- \*6  It will be displayed only when the [MEDIA SELECT] is set to [Built-inMemory].

### RECORD SETUP

[SCENE MODE]	(→ 51)
[D.ZOOM]	(→ 44)
[REC MODE]	(→ 40)
[RELAY REC] <sup>*6</sup>	(→ 52)
[REC ASPECT]	(→ 52)
[FACE FRAMING] <sup>*2</sup>	(→ 52)
[GUIDE LINES]	(→ 49)
[WEB MODE]	(→ 48)
[FADE]	(→ 48)
[FADE COLOUR]	(→ 48)
[AUTO SLOW SHTR] <sup>*1</sup>	(→ 52)

[BACKLIGHT COMPENS.]	(→ 48)
[INTELLIGENT CONTRAST] <sup>*1</sup>	(→ 49)
[SOFT SKIN MODE] <sup>*1</sup>	(→ 49)
[COLOUR NIGHT VIEW] <sup>*1</sup>	(→ 49)
[SHOOTING GUIDE]	(→ 41)
[WIND NOISE CANCELLER] <sup>*1</sup>	(→ 53)
[ZOOM MIC] <sup>*1</sup>	(→ 53)
[WB ADJUST] <sup>*1</sup>	(→ 53)
[MF ASSIST] <sup>*1</sup>	(→ 58)

## PICTURE

[SELF TIMER] (→ 53)

[SHTR SOUND] (→ 54)

## MEDIA SELECT<sup>\*3\*4</sup>

Recording media may be set independently for both still pictures and motion pictures.

### SDR-T70

When recording to the SD card, select [SD CARD]. When recording to the built-in memory, select [Built-inMemory]. (→ 39, 59, 65)

### SDR-H100

When recording to the SD card, select [SD CARD]. When recording to the HDD, select [HDD]. (→ 39, 59, 65)

## SETUP

[DISPLAY]

The screen display can be changed to [OFF] (a portion of information displayed) or [ON] (all information displayed).

[EXT. DISPLAY] (→ 76)

[CLOCK SET] (→ 28)

[SET WORLD TIME] (→ 29)

[DATE/TIME] (→ 28)

[DATE FORMAT] (→ 28)

[ECONOMY]

**[OFF]:**

The power saving function is not activated.

**[5 MINUTES]:**

When about 5 minutes have passed without any operation, this unit automatically turns off to save battery life.

- The power save function will not activate when:
  - connected to AC adaptor
  - using the USB cable for PC, DVD burner etc.
  - PRE-REC is used

[QUICK POWER ON] (→ 37)

[QUICK START] (→ 36)

---

## [ALERT SOUND]

Starting and stopping of recording and power on/off can be confirmed with this sound.

### **2 Beeps for 4 times**

When an error occurs. Check the sentence displayed on the screen.  
(→ 100)

---

[POWER LCD] (→ 31)

---

[LCD SET] (→ 31)

---

[TV ASPECT] (→ 76)

---

## [INITIAL SET]

Set to [YES] for changing the menu settings back to the default condition.

(Settings for [MEDIA SELECT]<sup>\*3\*4</sup>, [CLOCK SET] and [LANGUAGE] will not be changed.)

---

[FORMAT MEDIA]<sup>\*3\*4</sup> (→ 74)

---

[FORMAT CARD]<sup>\*5</sup> (→ 74)

---

[MEDIA STATUS]<sup>\*3\*4</sup> (→ 72)

---

## [CARD STATUS]<sup>\*5</sup>

The amount of time left on the SD card can be checked.

- Press the MENU button to end.

---

## [DEMO MODE]

This item is used to start the unit demonstration.

(Only when the mode is at the  position)

If [DEMO MODE] is switched to [ON] and you press the MENU button when there is no SD card inserted and while this unit is connected to the AC adaptor, the demonstration automatically starts.

If any operation takes place, the demonstration is cancelled. However if no operations take place for approx. 10 minutes, the demonstration automatically starts again. To stop the demonstration, set [DEMO MODE] to [OFF] or insert an SD card.

---

[LANGUAGE] (→ 24)

You can select the language on the screen display and the menu screen.

---

## ▶ Playback mode

- \*1 Only when the disc playback is selected while a DVD burner (optional) is connected, this does not appear.
- \*2 Only when the disc playback is selected while a DVD burner (optional) is connected, this appears.
- \*3 These menus are only for **SDR-T70**.
- \*4 These menus are only for **SDR-H100**.
- \*5 This appears only when the [SD CARD]/[PICTURE] is selected.
- \*6 **SDR-T70** This appears only when the [Built-inMemory]/[VIDEO] is selected.
- \*7 **SDR-H100** This appears only when the [HDD]/[VIDEO] is selected.









### VIDEO SETUP

[REPEAT PLAY]	(→ 64)
[RESUME PLAY]	(→ 64)
[SCENE PROTECT] <sup>*1</sup>	(→ 69)
[GUIDE LINES]	(→ 49)

### EDIT SCENE<sup>\*1</sup>

[SPLIT&DELETE] <sup>*6*7</sup>	(→ 70)
[DELETE]	(→ 68)

### COPY<sup>\*1\*3\*4</sup>

 →  <sup>*3</sup>	(→ 73)
 →  <sup>*3</sup>	(→ 73)
 →  <sup>*4</sup>	(→ 73)
 →  <sup>*4</sup>	(→ 73)

### DISC SETUP<sup>\*2</sup>

[FORMAT DISC]	(→ 82)
[AUTO PROTECT]	(→ 82)
[CANCEL PROTECT]	(→ 82)
[DISC STATUS]	(→ 82)

### PHOTO SETUP

[DPOF SET] <sup>*5</sup>	(→ 71)
--------------------------	--------

- For any other menus that are not described above, refer to menus with the same names for the recording mode and motion picture playback.

# Setting date and time

When the unit is turned on for the first time, a message asking you to set the date and time will appear.

Select [YES] and perform steps 2 to 3 below to set the date and time.

◇ Change the mode to  .

## 1 Select the menu. (→ 23)

[SETUP] → [CLOCK SET]

## 2 Select the date or time, then adjust the desired value with the joystick.

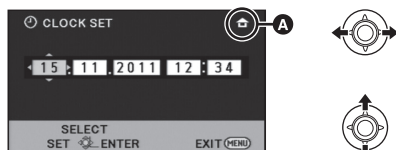

### A Displaying the World time setting (→ 29):

 [HOME]/  [DESTINATION]

- The year can be set between 2000 and 2039.
- The 24-hour system is used to display the time.

## 3 Press the joystick to enter the selection.

- The clock function starts at [00] seconds.
- A message may be displayed prompting you to set the world time. (→ 29)
- Press the MENU button to complete the setting.

### Changing the date format

Select the menu. (→ 23)

[SETUP] → [DATE FORMAT] → [Y/M/D]/  
[M/D/Y]/[D/M/Y]

- The date and time function is driven by a built-in lithium battery.
- When this unit is purchased, the clock is set. If the time display becomes [- -], the built-in lithium battery needs to be charged. To recharge the built-in lithium battery, connect the AC adaptor or attach the battery to this unit. Leave the unit as it is for approx. 24 hours and the battery will maintain the date and time for approx. 4 months. (The battery is still being recharged even if the power is off.)

### Changing the date and time display mode

Select the menu. (→ 23)

[SETUP] → [DATE/TIME] → [OFF]/[D/T]/  
[DATE]

## World time setting (Displaying the time of the travel destination)

It is possible to display and record the time at the travel destination by selecting your home region and the travel destination.

### 1 Select the menu. (→ 23)

[SETUP] → [SET WORLD TIME]

- If the clock is not set, adjust the clock to the current time. (→ 28)
- When the [HOME] (your home region) is not set, the message appears. Press the joystick to move to Step 3.

### 2 (Only when setting your home region) Select [HOME] and press the joystick.

### 3 (Only when setting your home region) Select your home region and enter the selection with the joystick.



- A** The current time
- B** The time difference from GMT (Greenwich Mean Time)

- To set to daylight savings time, press the joystick forward. appears and the summer time setting is turned on; the time difference from GMT is set forward by one hour. Press the joystick forward again to return to standard time.

### 4 (Only when setting the region of your travel destination)

Select [DESTINATION] and press the joystick.



- When the home region is set for the first time, the screen for selecting home/travel destination appears after setting the home region successively. If the home region has already been set once, execute the menu operation for Step 1.

### 5 (Only when setting the region of your travel destination)

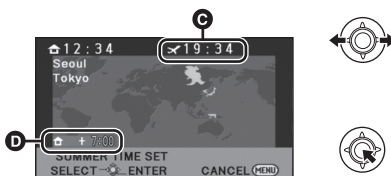
Select your travel destination and enter the selection with the joystick.



- C** The local time at the selected travel destination
- D** The time difference between the travel destination and the home region

- To set to daylight savings time, press the joystick forward.  appears and the summer time setting is turned on. The clock and time difference from the home region time are set forward by one hour. Press the joystick forward again to return to standard time.
  - Close the setting by pressing the MENU button.  appears and the time of the travel destination is indicated.
- 

### ***To return the display to the home setting***

Set the home region using Step 1 to 3, and close the setting by pressing the MENU button.

---

- If you cannot find your travel destination in the area shown on the screen, set it by using the time difference from your home region.

## LCD monitor adjustment

- These settings will not affect the images actually recorded.

### ■ Adjusting the brightness and colour level of the LCD monitor

It adjusts brightness and colour density on the LCD monitor.

Select the menu. (→ 23)

[SETUP] → [LCD SET]

#### 1 Use the joystick to select the item, then press the centre of the joystick.

[BRIGHTNESS]:

Brightness of the LCD monitor

[COLOUR]:

Colour level of the LCD monitor

- Select  and press the centre of the joystick to return to the previous screen.

#### 2 Make adjustments



- Close the setting by pressing the MENU button.

### ■ POWER LCD

This makes it easier to view the LCD monitor in bright places including outdoors.

Select the menu. (→ 23)

[SETUP] → [POWER LCD]

[+2]\*: Makes even brighter / [+1]\*: Makes brighter / [0]\*: No setting (normal) / [-1]\*: Makes darker / [A]\*: Auto\*

\* It is not displayed in the manual mode or in the playback mode.

- If you use the AC adaptor, the [+1]\* indication appears and the screen becomes brighter automatically when the power is turned on.
- 
- The recordable time using the battery will become shorter when you use this unit with the LCD monitor lit up.

## Recording Yourself

◇ Change the mode to  .

**Rotate the LCD monitor towards the lens side.**

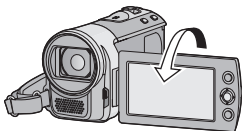

- The image is horizontally flipped as if you see a mirror image. (However the image recorded is the same as a normal recording.)
- 
- When the LCD monitor is rotated towards the lens side, the icon will not be displayed even if you press the joystick.
  - Only some indications will appear on the screen. When  appears, return the direction of the LCD monitor to normal position and check the warning/alarm indication. (→ 100)

# Before recording

## ■ Basic camera positioning

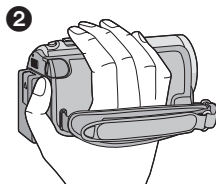
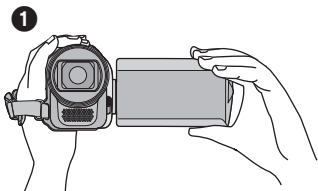

- ❶ Hold the unit with both hands.
- ❷ Put your hand through the grip belt.
  - When recording, make sure your footing is stable and there is no danger of colliding with another person or object.
  - When you are outdoors, record pictures with the sunlight behind you. If the subject is backlit, it will become dark in the recording.
  - Keep your arms near your body and separate your legs for better balance.
  - Do not cover the microphones with your hand.

## ■ Basic motion picture recording

- The unit should normally be held steady when recording.
- If you move the unit when recording, do so slowly, maintaining a constant speed.
- The zoom operation is useful for recording subjects you cannot get close to, but overuse of zoom in and zoom out can make the resulting motion picture less enjoyable to watch.

## Intelligent auto mode

The following modes appropriate for the condition are set just by pointing the unit to what you want to record.

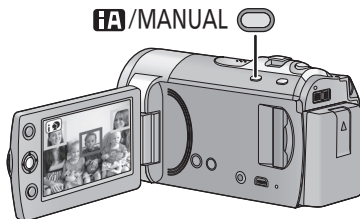

### Intelligent auto/Manual button [iA/MANUAL]

Press this button to change the mode to **Intelligent auto mode** or **manual mode**.

- Please refer to page 55 about manual mode.

Mode	Scene	Effect
<b>Portrait</b>	<b>When the object is a person</b>	Faces are detected and focused automatically, and the brightness is adjusted so it is recorded clearly.
<b>Scenery</b>	<b>Recording outdoors</b>	The whole landscape will be recorded vividly without whitening out the background sky, which may be very bright.
<b>Spotlight</b>	<b>Under a spotlight</b>	Very bright object is recorded clearly.
<b>Low light</b>	<b>Dark room or twilight</b>	It can record very clearly even in a dark room or twilight.
<b>Normal</b>	<b>Other situations</b>	Contrast is adjusted automatically for clear image.

- Depending on the recording conditions, the unit may not enter the desired mode.
- In the portrait, spotlight or low light mode, detected faces appear with white frames. In the portrait mode, one that is bigger and close to centre of the screen will be surrounded by an orange frame. (→ 52)
- Faces may not be detected depending on the recording conditions, such as when faces are of certain sizes or at certain tilts or when digital zoom is used.

## ■ About Intelligent auto mode

When the Intelligent auto mode is set to on, the auto white balance and auto focus operate and automatically adjust the colour balance and focusing.

Depending on the brightness of the subject etc., the aperture and shutter speed are automatically adjusted for an optimum brightness.

- Colour balance and focus may not be adjusted automatically depending on light sources or scenes. If so, manually adjust these settings. (→ 56, 58)

## Automatic white balance

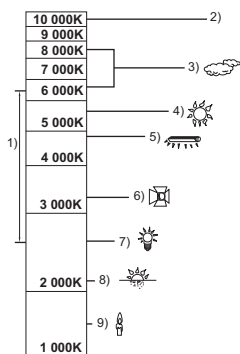

The illustration above shows the range over which the auto white balance functions.

- 1) The effective range of automatic white balance adjustment on this unit
- 2) Blue sky
- 3) Cloudy sky (rain)
- 4) Sunlight
- 5) White fluorescent lamp
- 6) Halogen light bulb
- 7) Incandescent light bulb
- 8) Sunrise or sunset
- 9) Candlelight

If the automatic white balance is not functioning normally, adjust the white balance manually. (→ 53, 56)

## Auto focus

The unit focuses automatically.

- Auto focus does not work correctly in the following situations. Record pictures in the manual focus mode. (→ 58)
  - Recording distant and close-up objects at the same time
  - Recording a subject behind dirty or dusty window
  - Recording a subject that is surrounded by objects with glossy surfaces or by highly reflective objects

For details on Scene mode, refer to page 51. For how to set Manual focus/white balance manually, refer to page 55-58.

## Quick start

This unit will resume recording pause mode about 0.8 seconds after the LCD monitor is reopened.

◇ Change the mode to  .

### 1 Select the menu. (→ 23)

[SETUP] → [QUICK START] → [ON]

### 2 Close the LCD monitor while the mode is set to .

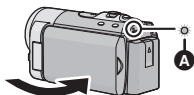

The status indicator **A** flashes green and the unit goes into quick start standby mode.

### 3 Open the LCD monitor.



The status indicator **A** lights red and the unit is put into recording pause.

- When in quick start standby mode about 70% of the power used in recording pause mode is being consumed, so the recording time will be reduced.
- Quick start standby mode is cancelled if
  - about 5 minutes elapsed
  - mode is set to 
- It may take some time for automatic white balance to adjust.
- In the quick start mode, the zoom magnification becomes 1×.
- If [ECONOMY] (→ 25) is set to [5 MINUTES] and the unit automatically goes into quick start standby mode, close the LCD monitor and then open it again.
- Turn the unit off using the power button.

## Quick power on

When the power is turned on with the mode set to , the unit will enter the recording pause mode after about 1.9 seconds.

**Select the menu. (→ 23)**

[SETUP] → [QUICK POWER ON] →  
[ON]

- In the quick power on mode, the zoom magnification becomes 1×.

# Recording motion pictures

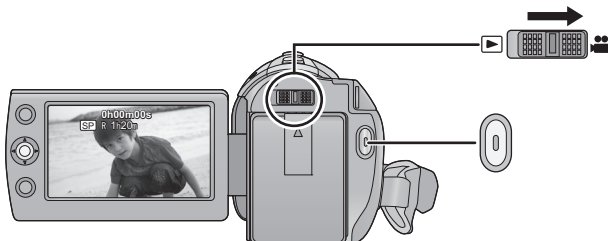

VIDEO

- Open the lens cover before turning the unit on. (→ 10)



**1** Change the mode to  and open the LCD monitor.

**2** Press the recording start/stop button to start recording.

- When you begin recording,  changes to .
- While recording is in progress, the recording will not stop even if the LCD monitor is closed.

**3** Press the recording start/stop button again to pause recording.

■ **Screen indications in the motion picture recording mode**



- A** Recording mode
- B** Remaining time left for recording  
(When the remaining time is less than 1 minute, [R 0h00m] flashes red.)
- C** Recording time elapsed  
Each time the unit is put into recording pause, the counter display will be reset to "0h00m00s".  
(“h” is an abbreviation for hour, “m” for minute and “s” for second.)

- Still pictures can be recorded while recording the motion picture. (→ 43)
- The images recorded between pressing the recording start/stop button to start recording and pressing it again to pause recording become one scene. The scene is automatically divided when the recorded data exceeds 1.9 GB. (The recording will continue.)

#### SD CARD

Maximum number of recordable scenes: 9801

Maximum number of different dates: 99

(→ 63)

(In the case of SD cards it is the maximum number of recordable scenes per card.)

#### Built-in Memory/HDD

 / 

Maximum number of recordable scenes: 98901

Maximum number of different dates: 999

(→ 63)

When either of them reaches to the maximum limit, additional scenes cannot be recorded.

## Selecting a media to record [SDR-T70]/[SDR-H100]

VIDEO PHOTO

Media for recording both still pictures and motion pictures may be set on the SD Card, the built-in memory or the HDD.

Select the menu. (→ 23)

[MEDIA SELECT]

Select the media to record motion pictures or still pictures, then press the centre of the joystick.

SDR-T70

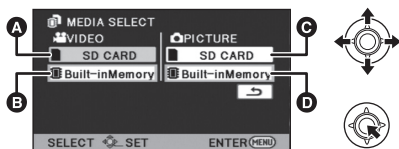

- A VIDEO/SD CARD
- B VIDEO/Built-inMemory
- C PICTURE/SD CARD
- D PICTURE/Built-inMemory

SDR-H100

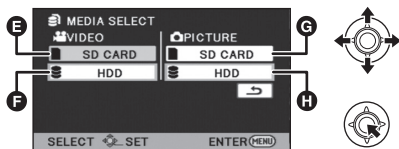

- E VIDEO/SD CARD
- F VIDEO/HDD
- G PICTURE/SD CARD
- H PICTURE/HDD

- Media set for still pictures and motion pictures will be outlined in a yellow frame.
- Press the MENU button to end.

## Recording modes/approximate recordable time

Switch the picture quality of the motion pictures to be recorded.

**Select the menu. (→ 23)**

[RECORD SETUP] → [REC MODE] → **desired setting**

- SD cards are only mentioned with their main memory size. The stated times are the approximate recordable times for continuous recording.

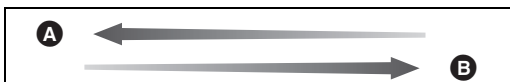

Recording mode		XP	SP	LP
SD card	4 GB	50 min	1 h 40 min	3 h 20 min
	8 GB	1 h 45 min	3 h 30 min	7 h
	16 GB	3 h 30 min	7 h	14 h
	32 GB	7 h 30 min	15 h	30 h
	48 GB	11 h	22 h 10 min	44 h 50 min
	64 GB	15 h	30 h	60 h 30 min
SDR-T70 Built-in memory	4 GB	50 min	1 h 40 min	3 h 20 min
SDR-H100 HDD	80 GB	18 h 30 min	37 h	74 h 30 min

- Ⓐ Favors image quality
- Ⓑ Favors recording time
- If recording for long periods, prepare batteries for 3 or 4 times the period you wish to record for. (→ 16)
- The given recording times are standard recordable times for continuous recording.
- If a recording with a lot of movements is recorded, the recording time is reduced.
- The recordable time may be reduced if recording of short scenes is repeated.
- Remaining time left for recording may increase after changing the mode or restarting the unit by turning it off and on.
- Use time in the row of 4 GB in the above table as a guideline for the time that can be copied onto one DVD disc (4.7 GB).

### • Recordable time using the battery (→ 16)

- When the unit is moved a lot or moved quickly, or when a fast-moving subject is recorded (particularly when recording in LP mode), mosaic-type noise may appear at playback.

## Shooting guide

Message is displayed when this unit is moved rapidly.

**Select the menu. (→ 23)**

[RECORD SETUP] → [SHOOTING GUIDE] → [ON]

When "CAMERA PANNING IS TOO FAST." appears, move the unit slowly while recording.

- Message will not appear while pausing the recording. (Message will appear even if it is pausing the recording if [DEMO MODE] is set to [ON])
- In some recording conditions, messages may not appear.

## Recording still pictures

PHOTO

- Open the lens cover before turning on the power. (→ 10)  
Still pictures can also be recorded while recording motion pictures.
- Refer to page 39 for methods for selecting recording media.

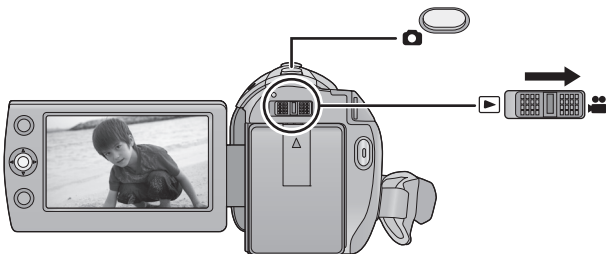

**1** Change the mode to  and open the LCD monitor.

**2** Press the  button.



- Because of slower shutter speeds, it is recommended that you use a tripod when recording in low light.

■ About the screen indications in still picture recording

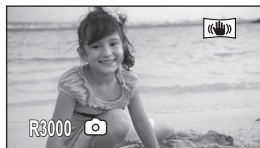

- R3000: Remaining number of still pictures  
(Flashes in red when [0] appears.)

## Picture size

Records at the number of recording pixels set under [REC ASPECT]. (→ 52)

Aspect	Number of pixels
4:3	640×480
16:9	640×360

- The edges of still pictures recorded on this unit with a 16:9 aspect ratio may be cut at printing. Check the printer or photo studio before printing.

## Simultaneous recording (recording still pictures while recording motion pictures)

You can record still pictures even while recording motion pictures.

◇ Change the mode to  .

**While recording motion pictures, press the  button to take the picture.**



- While recording motion pictures or during the PRE-REC operation, the following arrangements are applied so that motion picture recording takes preference over still picture recording.
  - Image quality is different from ordinary still pictures.
  - The remaining usable capacity (number of pictures that can be taken) indication does not appear.
- For vivid still pictures, we recommend pausing motion picture recording and taking still pictures after releasing the PRE-REC mode.

- Remaining time left for recording will become shorter when you record still pictures while recording motion pictures.

## Approximate number of recordable pictures

- SD cards are only mentioned with their main memory size. The stated number is the approximate number of recordable pictures.

Picture size		640×480 640×360
SD card	4 GB	30000
	8 GB	60500
	16 GB	99999*
	32 GB	99999*
	48 GB	99999*
	64 GB	99999*
SDR-T70 Built-in memory	4 GB	30000
SDR-H100 HDD	80 GB	99999*

- \* Maximum number of recordable pictures that can be displayed is 99999. If the number of recordable pictures exceeds 99999, the number will not change when the picture is taken until the number of recordable pictures gets less than 99999.

◇ Change the mode to  .

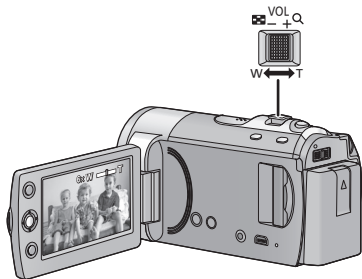

### Zoom lever

#### T side:

Close-up recording (zoom in)

#### W side:

Wide-angle recording (zoom out)

- The zoom speed varies depending on the range over which the zoom lever is moved.

## Enhanced optical zoom

It is possible to enhance the zoom magnification up to 78× without degrading the image quality when recording.

## Digital zoom function

If the zoom magnification exceeds 78×, then the digital zoom function will be activated. The maximum magnification provided by the digital zoom can be switched.

### Select the menu. (→ 23)

[RECORD SETUP] → [D.ZOOM] →  
desired setting

**[OFF]:** Enhanced optical zoom only  
(Up to 78×)

**[100×]:** Up to 100×

**[3500×]:** Up to 3500×

- If [100×] or [3500×] is selected, the digital zoom range is displayed in blue while zooming.

- The larger the digital zoom magnification, the more the image quality is degraded.

- If you take your finger off the zoom lever during zoom operation, the operation sound may be recorded. When returning the zoom lever to the original position, move it quietly.
- When distant subjects are brought closer, they are focused at about 1.5 m or more.
- When the zoom magnification is 1×, this unit can focus on a subject approx. 2 cm away from the lens.

## Image stabilizer function

Reduces the image shaking (jitter) due to hand movement when recording.

◇ **Change the mode to**  .

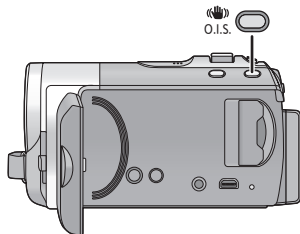

### Optical image stabilizer button

Pressing the button changes the optical image stabilizer setting.



 : **Active mode**

This setting gives more stabilization and is suitable for recording when walking.

 : **ON**

This setting is suitable for recording in a stable state such as scenery.

- Stabilization may not be possible under strong shaking.
- When a tripod is used, we recommend that you turn the image stabilizer off.

- Open the lens cover before turning on the power. (→ 10)

It is possible to set the focus and exposure to the locked target.

The focus and exposure will keep following the subject automatically even if it moves. (Dynamic tracking)



- ◇ Change the mode to  .

## 1 Press the AF/AE button.



- When intelligent auto mode is set to  (Portrait), the prioritised face frame (in orange) will change to the target frame, and the subject's face will be tracked.

## 2 Align the subject with the target frame and press the AF/AE button to lock on to the target.

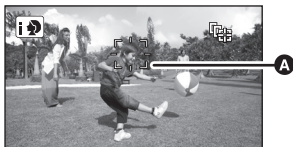

### A Target frame

- To change the target, press the AF/AE button and align the target frame with the new subject and press the AF/AE button once again.

## 3 Start recording.

- Pressing and holding the AF/AE button releases the AF/AE tracking.

### ■ About target frame

- In the event of failure to achieve target lock, the target frame will blink red and then disappear. Realign the subject with the target frame and repress the AF/AE button to regain target lock.
- 
- This function cannot be used in manual mode.
  - It may track different objects or may not lock the target depending on the recording conditions such as the following:
    - When the object is too large or too small
    - When colour of the object is similar to the background
    - When the scene is dark
  - AF/AE tracking will be cancelled in the following cases.
    - When the mode is changed
    - When the power is turned off
    - When the scene mode is set
    - When the unit is switched to Intelligent auto mode/manual mode
    - When the unit is switched to face-to-face recording.

# Recording functions of operation icons

Select the operation icons to add different effects to the images to be recorded.

◇ Change the mode to  .

**1** Press the joystick, and icons will be displayed on the screen.











- The indication changes each time the joystick is moved down.
- The indication disappears when the centre of the joystick is pressed again.

**2** (e.g. Backlight compensation)  
**Select an icon with the joystick.**











- To release, reselect the operation icon.









## Operation icons

	Backlight compensation
	Fade
	Help mode
	Web mode
	Guide line
	PRE-REC
	Intelligent contrast control*
	Soft skin mode*
	Colour night view*

\* Not displayed when the Intelligent Auto Mode is on.

- The shaded operation icons are not displayed while recording.
- If you turn off the power or change the mode to  , colour night view, PRE-REC and backlight compensation functions are cancelled and if you turn off the power, the fade function is cancelled.

Function	Effect
<p> <b>Backlight compensation</b></p> <p style="text-align: right;">VIDEO PHOTO</p>	<p>This makes the image brighter to prevent darkening of a backlit subject.</p>
<p> <b>Fade</b></p> <p style="text-align: right;">VIDEO</p> <p>(Fade in)</p>  <p>(Fade out)</p> 	<p>When you start recording, the image/audio gradually appears. (Fade in)</p> <p>When you pause recording, the image/audio gradually disappears. (Fade out)</p> <ul style="list-style-type: none"> <li>• The fade setting is cancelled when the recording stops.</li> </ul> <p>■ To select the colour for fade in/out</p> <p><b>Select the menu. (→ 23)</b></p> <p>[RECORD SETUP] → [FADE COLOUR] → [WHITE] or [BLACK]</p>
<p> <b>Help mode</b></p> <p style="text-align: right;">VIDEO PHOTO</p> 	<p>Select the desired icon with the joystick to display an explanation on the screen.</p> <p><i>To exit the help mode</i></p> <p>Press the MENU button.</p>
<p> <b>Web mode</b></p> <p style="text-align: right;">VIDEO</p>	<p>You can record motion pictures of under 10 minutes, suitable for uploading to web site.</p> <ul style="list-style-type: none"> <li>• The web mode icon [  ] appears.</li> </ul> <p><b>Press the recording start/stop button to start recording.</b></p> <ul style="list-style-type: none"> <li>• Countdown of remaining time will start from "9m59s".</li> <li>• Recording will pause automatically after 10 minutes from start of the recording.</li> <li>• Web mode is cancelled if you turn the unit off.</li> </ul>

Function	Effect
<p> <b>Guide line</b></p> <p>VIDEO PHOTO</p> 	<p>You can check if the image is level while recording or playing back motion pictures and still pictures. The function can also be used to estimate the balance of the composition.</p> <ul style="list-style-type: none"> <li>• The guide lines do not appear on the images actually recorded.</li> </ul> <p>■ <b>Selecting the type of guide line</b></p> <p><b>Select the menu. (→ 23)</b></p> <p>[RECORD SETUP] → [GUIDE LINES] → desired setting</p> <p>■ <b>Displaying guide lines at playback</b></p> <ul style="list-style-type: none"> <li>• Change the mode to .</li> </ul> <p>[VIDEO SETUP] → [GUIDE LINES] → desired setting</p> <ul style="list-style-type: none"> <li>• Set to [OFF] to cancel the guide line.</li> </ul>
<p> <b>PRE-REC</b></p> <p>VIDEO</p>	<p>This allows recording of the pictures and sound to start approximately 3 seconds before the recording start/stop button is pressed.</p> <p> appears on the screen.</p> <ul style="list-style-type: none"> <li>• Aim this unit at the subject and position it securely. Press the recording start/stop button to start recording.</li> <li>• There is no beep sound.</li> </ul>
<p> <b>Intelligent contrast control</b></p> <p>VIDEO</p>	<p>This brightens parts that are in shadow and difficult to see and suppresses white saturation in bright parts at the same time. Both bright and dark parts can be recorded clearly.</p>
<p> <b>Soft skin mode</b></p> <p>VIDEO PHOTO</p>	<p>This makes skin colours appear softer for a more attractive appearance.</p> <p>This is more effective if you record a person closely from the torso up.</p>
<p> <b>Colour night view</b></p> <p>VIDEO PHOTO</p>	<p>This function allows you to record colour images in very low light situations. (Minimum required illumination: approx. 2 lx)</p>

### **Fade:**

- The thumbnails of scenes recorded using fade in become black (or white).

### **Help mode:**

- Recording and function settings cannot be performed while in help mode.

### **Web mode:**

- You cannot switch to web mode while recording.

### **PRE-REC:**

- PRE-REC is cancelled in the following cases.
  - If you change the mode.
  - If you press the MENU button.
  - If you turn the unit off.
  - If you start recording.
  - 3 hours have elapsed
- After setting PRE-REC, if recording starts in less than 3 seconds, or while the PRE-REC indication flashes within about 3 seconds after initiating the quick start operation, motion pictures taken 3 seconds before pressing the recording start/stop button cannot be recorded.
- The thumbnail displays for recorded scenes will be the initial images from recorded scenes.
- The date indication for scenes recorded using the PRE-REC function will be the date when the start/stop button is pressed. Therefore, the date indication when displaying thumbnails or during playback may be different from the date when the recording actually started.

### **Intelligent contrast control:**

- If there are extremely dark or bright parts or the brightness is insufficient, the effect may not be clear.











### **Soft skin mode:**





- If the background or anything else in the scene has colours similar to the skin colour, they will also be smoothed.
- If the brightness is insufficient, the effect may not be clear.
- If you record a person in the distance, the face may not be recorded clearly. In this case, cancel soft skin mode or zoom in on the face (close-up) to record.





### **Colour night view:**



- **Recorded scene is seen as if frames were missed.**
- If set in a bright place, the screen may become washed out for a while.
- Bright dots that are usually invisible may be seen, but this is not a malfunction.
- Using a tripod is recommended.
- In darker areas, auto focus may focus a bit slower. This is normal.

Recording functions of  
menus

Function	Effect/Setting method
<p><b>SCENE MODE</b></p> <p><b>VIDEO</b> <b>PHOTO</b></p>	<p>When you record images in different situations, this mode automatically sets optimum shutter speeds and apertures.</p> <hr/> <ul style="list-style-type: none"> <li>• Change the mode to  .</li> </ul> <p><b>Select the menu. (→ 23)</b>  <b>[RECORD SETUP] → [SCENE MODE] → desired setting</b></p> <ul style="list-style-type: none"> <li>• Set [SCENE MODE] to [OFF] to cancel the function.</li> </ul> <p> <b>Sports:</b>  To make fast moving scenes less shaky with slow playback and pause of playback</p> <p> <b>Portrait:</b>  To make people stand out against the background</p> <p> <b>Low light:</b>  For dark scenes, such as at dusk</p> <p> <b>Spotlight:</b>  Improved quality when subject is brightly illuminated.</p> <p> <b>Snow:</b>  Improved image quality when shooting on snowy locations.</p> <p> <b>Beach:</b>  To make blue in the sea or sky vibrant</p> <p> <b>Sunset:</b>  To make red in the sunrise or sunset vibrant</p> <p> <b>Fireworks:</b>  To capture the fireworks in the night sky beautifully</p> <p> <b>Scenery:</b>  For spatial scenery</p> <p> <b>Night scenery:</b>  To capture the evening or night scenery beautifully.</p>

Function	Effect/Setting method
<p>SDR-T70</p> <p><b>RELAY REC</b></p> <p>VIDEO</p>	<p>It is possible to continuously record motion picture to an SD card when there is no space available in the built-in memory. (It allows you to record only to SD card from built-in memory.)</p> <hr/> <ul style="list-style-type: none"> <li>Change the mode to .</li> </ul> <p><b>Select the menu. (→ 23)</b>  <b>[RECORD SETUP] → [RELAY REC] → [ON]</b></p> <ul style="list-style-type: none"> <li>⇨ □ is displayed on the screen. ⇨ □ will disappear when space in the built-in memory is gone and the recording to the SD card starts.</li> </ul>
<p><b>REC ASPECT</b></p> <p>VIDEO PHOTO</p>	<p>This allows you to record images compatible with wide-screen TVs (16:9) and regular TVs (4:3).</p> <hr/> <ul style="list-style-type: none"> <li>Change the mode to .</li> </ul> <p><b>Select the menu. (→ 23)</b>  <b>[RECORD SETUP] → [REC ASPECT] → [16:9] or [4:3]</b></p>
<p><b>FACE FRAMING</b></p> <p>VIDEO PHOTO</p> <p><b>[OFF]:</b> Cancel the setting</p> <p><b>[PRIMARY]:</b> Only the prioritised face framing is displayed.</p> <p><b>[ALL]:</b> All face detection framings are displayed.</p> 	<p>In the intelligent auto mode, detected faces appear with frames.</p> <hr/> <ul style="list-style-type: none"> <li>Change the mode to .</li> </ul> <p><b>Select the menu. (→ 23)</b>  <b>[RECORD SETUP] → [FACE FRAMING] → desired setting</b></p> <ul style="list-style-type: none"> <li>Up to 5 frames are indicated. Larger faces and faces nearer to the centre of the screen take preference over others.</li> </ul> <p><b>■ Prioritised face framing</b></p> <p>Prioritised face framing is displayed in orange. Focus and adjustment of brightness will be performed against the prioritised face framing.</p> <ul style="list-style-type: none"> <li>In the portrait mode of the intelligent auto mode, focus and adjustment of brightness will be performed against the prioritised face framing. In the spotlight or lowlight mode of the intelligent auto mode, focus will be performed against the prioritised face framing.</li> </ul>
<p><b>AUTO SLOW SHTR</b></p> <p>VIDEO PHOTO</p>	<p>You can record bright pictures even in dark places by slowing the shutter speed.</p> <hr/> <ul style="list-style-type: none"> <li>Change the mode to .</li> <li>Select the manual mode. (→ 55)</li> </ul> <p><b>Select the menu. (→ 23)</b>  <b>[RECORD SETUP] → [AUTO SLOW SHTR] → [ON]</b></p> <ul style="list-style-type: none"> <li>The shutter speed is set to 1/25 or more depending on the surrounding brightness.</li> </ul>

Function	Effect/Setting method
<b>WIND NOISE CANCELLER</b> <div style="text-align: right; border: 1px solid black; padding: 2px;">VIDEO</div>	<p>This will reduce the wind noise coming into the built-in microphones while maintaining the realism.</p> <hr/> <ul style="list-style-type: none"> <li>• Change the mode to .</li> <li>• Select the manual mode. (→ 55)</li> </ul> <p><b>Select the menu. (→ 23)</b>  [RECORD SETUP] → [WIND NOISE CANCELLER] → [ON]</p>
<b>ZOOM MIC</b> <div style="text-align: right; border: 1px solid black; padding: 2px;">VIDEO</div>	<p>The zoom microphone is linked to the zooming operation so that far-away sounds with a tele-shot and close-up sounds with a wide-angle shot are recorded more clearly.</p> <hr/> <ul style="list-style-type: none"> <li>• Change the mode to .</li> <li>• Select the manual mode. (→ 55)</li> </ul> <p><b>Select the menu. (→ 23)</b>  [RECORD SETUP] → [ZOOM MIC] → [ON]</p>
<b>WB ADJUST</b> <div style="display: flex; justify-content: flex-end; gap: 5px;"> <div style="border: 1px solid black; padding: 2px;">VIDEO</div> <div style="border: 1px solid black; padding: 2px;">PHOTO</div> </div>	<p>You can finely adjust the white balance when you cannot acquire the desired hue by setting the white balance. (→ 56)</p> <hr/> <ul style="list-style-type: none"> <li>• Change the mode to .</li> <li>• Select the manual mode. (→ 55)</li> </ul> <p><b>Select the menu. (→ 23)</b>  [RECORD SETUP] → [WB ADJUST]</p> <ul style="list-style-type: none"> <li>• The currently-set white balance icon will be displayed.</li> </ul> <p><b>Adjust by moving the joystick left and right, then press the MENU button or the centre of the joystick to set.</b>  R : Move when the hue is bluish.  B : Move when the hue is reddish.</p>
<b>SELF TIMER</b> <div style="text-align: right; border: 1px solid black; padding: 2px;">PHOTO</div>	<p>This is for recording still pictures using the timer.</p> <hr/> <ul style="list-style-type: none"> <li>• Change the mode to .</li> </ul> <p><b>Select the menu. (→ 23)</b>  [PICTURE] → [SELF TIMER] → desired setting</p> <p>⌚10 (Records after 10 seconds)  ⌚2 (Records after 2 seconds)</p> <ul style="list-style-type: none"> <li>• When the  button is pressed, a still picture is recorded after the ⌚10 or ⌚2 display flashes for the time which has been set.</li> <li>• After recording, the self-timer is cancelled.</li> </ul> <hr/> <p><b>To stop the timer midway through</b>  Press the MENU button.</p>

Function	Effect/Setting method
<b>SHTR SOUND</b> <div style="border: 1px solid black; padding: 2px; display: inline-block;">PHOTO</div>	<p>You can add a shutter sound when recording still pictures.</p> <hr/> <ul style="list-style-type: none"> <li>Change the mode to  .</li> </ul> <p><b>Select the menu. (→ 23)</b>  <b>[PICTURE] → [SHTR SOUND] → [OFF]/[  ]/[  ]</b></p>

#### SCENE MODE:

- **(Low light/Sunset)**
  - The shutter speed is 1/25 or more .
- **(Sunset/Fireworks/Scenery/Night scenery)**
  - Image may get blurry when a close object is recorded.
- **(Sports)**
  - During normal playback, the image movement may not look smooth.
  - Colour and screen brightness may change under indoor lighting.
  - If the brightness is insufficient, the sports mode does not function. The  display flashes.
- **(Portrait)**
  - Colour and screen brightness may change under indoor lighting.
- **(Fireworks)**
  - Image may get washed out when recorded in bright surrounding.
- **(Night scenery)**
  - Using a tripod is recommended.

#### RELAY REC:

- In the Relay recording, still pictures are also recorded onto the SD card.

#### AUTO SLOW SHTR:



- When the shutter speed becomes 1/25, the screen may be seen as if frames are missed and afterimages may appear.
- If the scene is low in brightness or contrast, the subject may not be focused on.

#### WIND NOISE CANCELLER:

- When the Intelligent auto mode is set to on, [WIND NOISE CANCELLER] is set to [ON], and the setting cannot be changed.

- The sound quality may be changed if this function is activated in strong winds.

#### SELF TIMER:

- The self-timer standby mode is cancelled when you press the recording start/stop button to start motion picture recording.
- Setting the self-timer to 2 is a good way to prevent image shake when the  button is pressed while using a tripod etc.

#### SHTR SOUND:

- There will be no shutter noise when taking still pictures during motion picture recording.

## 3

Manual recording  
functions

◇ Change the mode to  .

Press the **iA/MANUAL** button to switch to manual mode.

- **MNL** appears on the screen.

**iA/MANUAL**

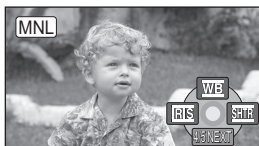
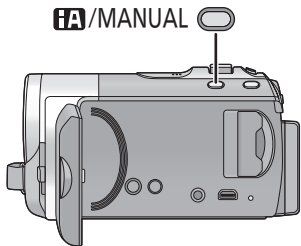

**WB** White balance (→ 56)

**IRIS** Iris adjustment (→ 57)

**SHTR** Shutter speed (→ 57)

### ■ To change to manual focus mode

Switch the operation icon by pressing the joystick down while in the screen above.

Press the joystick forward

- This will allow you to switch between manual mode and manual focus mode.

1



2



- 1 Manual mode
- 2 Manual focus mode

[MF] icon shown in the illustration appears.

**MF** **MF** Manual focus adjustment (→ 58)

### ■ To release the manual mode

- Press the **iA/MANUAL** button again.

# White balance

VIDEO PHOTO

The automatic white balance function may not reproduce natural colours depending on the scenes or lighting conditions. If so, you can adjust the white balance manually.

- Press the **iA/MANUAL** button to switch to manual mode (→ 55)

**1** Select [**WB**] with the joystick.

**2** Select the white balance mode with the joystick.



- Select the optimal mode by confirming the colour on the screen.

Icon	Mode/Recording conditions
<b>AWB</b>	<b>Auto white balance adjustment</b>
	<b>Sunny mode</b> Outdoors under a clear sky
	<b>Cloudy mode</b> Outdoors under cloudy sky
	<b>Indoor mode 1</b> Incandescent light, video lights like in the studio, etc.
	<b>Indoor mode 2</b> Colour fluorescent lamps, sodium lamps in gymnasiums etc.
	<b>Manual adjustment mode</b> <ul style="list-style-type: none"> <li>• Mercury-vapor lamps, sodium lamps, some fluorescent lights</li> <li>• Lights used for wedding receptions at hotels, stage spotlights in theaters</li> <li>• Sunrise, sunset, etc.</li> </ul>

- To return to automatic settings, either switch to auto mode **AWB**, or press the **iA/MANUAL** button again.

## ■ To set the white balance manually

- 1) Select [] with the joystick, and fill the screen with a white subject.
- 2) Select [] with the joystick.

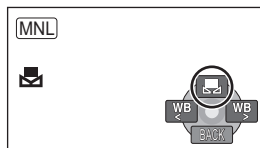

- When the display stops flashing and then lights constantly, the setting is complete.
  - If the display continues flashing, the white balance cannot be set. In this case, use other white balance modes.
- 
- When the unit is turned on with the lens cover closed, the automatic white balance adjustment may not function properly. Please turn the unit on after opening the lens cover.
  - When the display flashes, the manual white balance previously adjusted is stored. Whenever recording conditions change, re-set the white balance.
  - When setting both the white balance and the iris/gain, set the white balance first.
  - **AWB** is not displayed on the screen when **AWB** is being set.

## Shutter Speed:

Adjust it when recording fast-moving subjects.

## Iris:

Adjust it when the screen is too bright or too dark.

- Press the **iA/MANUAL** button to switch to manual mode (→ 55)

**1** Select **[IRIS]** or **[SHTR]** with the joystick.

**2** Adjust the settings with the joystick.



**A** **[SHTR]**: Shutter speed:

**1/50 to 1/8000**

- If **[AUTO SLOW SHTR]** is set to **[ON]**, the shutter speed will be set between 1/25 and 1/8000.
- The shutter speed closer to 1/8000 is faster.

**B** **[IRIS]**: Iris/Gain value:

**CLOSE** ↔ (**F16 to F2.2**) ↔ **OPEN** ↔ (**0dB to 18dB**)

- When the iris value is adjusted to brighter than **[OPEN]**, it changes to the gain value.
- To return to automatic settings, press the **iA/MANUAL** button.

- 
- When setting both the shutter speed and the iris/gain value, set the shutter speed and then set the iris/gain value.

## Manual shutter speed adjustment

- You may see a band of light around the object that is shining very bright, or having very high reflection.
- During normal playback, image movement may not look smooth.

- If you record an extremely bright object or record under indoor lighting, colour and screen brightness may change or a horizontal line may appear on the screen. In this case, record in auto mode or set the shutter speed to 1/100 in areas where the power supply frequency is 50 Hz, or 1/125 in areas of 60 Hz.

## Manual iris/gain adjustment

- If the gain value is increased, the noise on the screen increases.
- Depending on the zoom magnification, there are iris values that are not displayed.

## Recording with manual focus

VIDEO PHOTO

If auto focusing is difficult due to the conditions, then use manual focus.



◇ Change the mode to  .

● Press the iA/MANUAL button to switch to manual mode (→ 55)

**1** (When MF assist function is used)  
Select the menu. (→ 23)

[RECORD SETUP] → [MF ASSIST] →  
[ON]

**2** Use the joystick to select [MF]

**3** Adjust the focus by selecting  
 or  with the joystick.

 :To focus on a close subject

 :To focus on a faraway subject

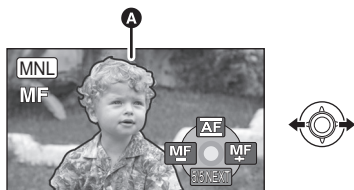

**A** Part displayed in blue

The in-focus area is displayed in blue. The normal screen returns approximately 2 seconds after you finish bringing the subject into focus.

- When [MF ASSIST] is set to [OFF], the blue area is not displayed.
- To return to auto focus, either switch to [AF] as in step 2, or repress the iA/MANUAL button.

- 
- The blue display does not appear in the motion picture that is actually recorded.

## Motion picture playback

VIDEO

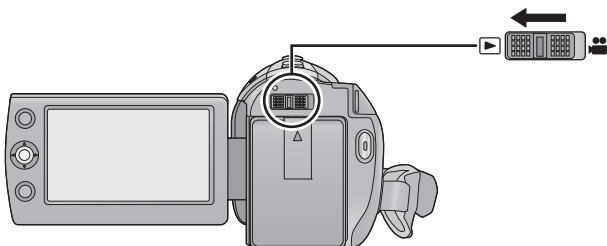

- 1 Change the mode to .
- 2 Use the joystick to select the play mode select icon , then press the centre of the joystick.



- 3 **SDR-S70**  
Select [VIDEO], then press the centre of the joystick.

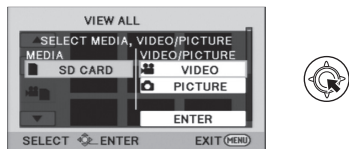

- SDR-T70**  
Select [SD CARD]/[Built-inMemory] and [VIDEO], then press the centre of the joystick.

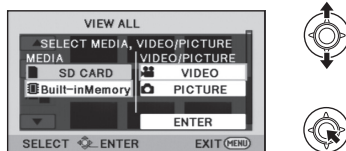

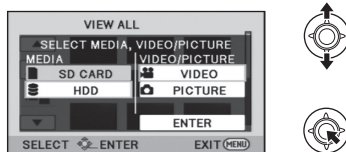

- SDR-H100**  
Select [SD CARD]/[HDD] and [VIDEO], then press the centre of the joystick.



- Select [ENTER], then press the centre of the joystick.
- Press the MENU button to cancel the setting.

#### 4 Select the scene to be played back, then press the joystick.

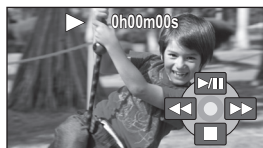

- The operation icon will be displayed or hidden each time the centre of the joystick is pressed.
- Next (previous) page can be displayed by selecting /.

#### 5 Select the playback operation with the joystick.



- ▶/||: Playback/Pause
- ◀◀: Rewind playback
- ▶▶: Fast forward playback
- : Stops the playback and shows the thumbnails.

#### ■ Change the thumbnail display

Pressing the zoom lever to the  or  side as in step 4 will cause the thumbnail display to change in the order shown below.  
20 scenes ↔ 9 scenes ↔ 1 scene  
↔ Time frame index (→ 62)

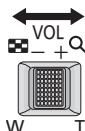

- 9 scenes display returns if the power is turned off or the mode is changed.

## ■ Speaker volume adjustment

Move the volume lever to adjust the speaker volume during playback.

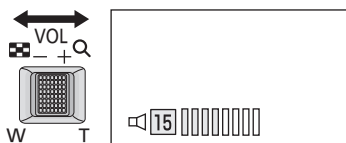

**Towards “+”:**

Increases the volume

**Towards “-”:**

Decreases the volume

## ■ Fast forward/rewind playback

Move the joystick left or right during playback.

- Move the joystick again to increase the speed. (The display on the screen changes from ►► to ►►►.)
- Normal playback is restored when you select ►/||.

## ■ Slow-motion playback

1 **Pause the playback.**

2 **Move and hold the joystick left or right.**

(◀|| is for reverse slow-motion playback)

Press and hold the joystick to one side for slow-motion playback.

- Normal playback is restored when you select ►/||.
- When slow-motion pictures are played back in reverse, they will be shown continuously at approximately 2/3<sup>rd</sup> the speed of normal playback (intervals of 0.5 seconds).

## ■ Frame-by-frame playback

The motion picture is advanced one frame at a time.

1 **Pause the playback.**

2 **Move the joystick left or right.**

(◀|| is for reverse frame-by-frame playback)

- Normal playback is restored when you select ►/||.
  - When the frames are advanced one at a time in the reverse direction, they will be shown in intervals of 0.5 seconds.
- 
- Sound will be heard only during normal playback.
  - If pause play is continued for 5 minutes, the screen returns to the thumbnails.
  - The elapsed time for playback indication will be reset to “0h00m00s” each scene.

## Creating still picture from motion picture

### PHOTO

A single frame from the recorded motion picture can be saved as a still picture. Picture size of the still picture to be recorded is (640×360) or (640×480).

### 1 Pause at the scene you want to save as a still picture during playback.

- It is convenient to use slow-motion playback and frame-by-frame playback.

### 2 Press the button.

- Date the motion picture was recorded will be registered as date of the still picture.
- Still pictures will be saved with the aspect ratio of the motion picture. (→ 52)
- Quality will be different from the normal still picture.



## Time frame index

One-scene images will be displayed as thumbnails under the set search conditions. It is possible to playback the scene from any desired point.

- Move the zoom lever to  side and change over the thumbnail display to Time frame index. (→ 60)

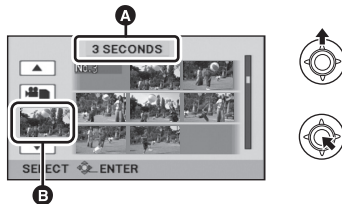
### 1 Use the joystick to select search conditions, then press the centre of the joystick.



- A** Set time selection
- B** Scene selection
- Next (previous) scene can be displayed by selecting /.

### 2 Choose the desired search item in units of [3 SECONDS], [6 SECONDS], [12 SECONDS] or [MINUTES].

- 3** (Only when [MINUTES] has been selected under step 2)  
**Set the time and then press the center of the joystick.**

- It can be set up to a maximum of 60 minutes.

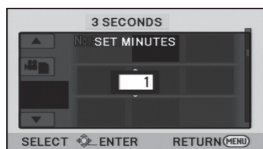

- 4** Choose the thumbnail from which you wish to begin playback, then press the center of the joystick.

- Next (previous) thumbnail can be displayed by selecting [◀]/[▶].

## Playing back motion pictures by date

Scenes recorded on the same day can be played back in succession.

- 1** Select the date select icon and press the joystick.



- A** Date select icon

- 2** Select the playback date, then press the joystick.

The scenes recorded on the date selected are displayed as thumbnails.

- 3** Select the scene to be played back, then press the joystick.

- Playing back of all the scenes returns if the power is turned off or the mode is switched.
- Even if scenes are recorded on the same day, they are grouped separately in the following cases.
  - When the number of scenes exceeds 99
  - When the world time setting is changed

## Repeat playback

Playback of the first scene starts after playback of the last scene finishes.

**Select the menu. (→ 23)**

[VIDEO SETUP] → [REPEAT PLAY] → [ON]

The  indication appears on the full screen views.

- All the scenes are played back repeatedly.  
(When playing back motion pictures by date, all the scenes on the selected date are played back repeatedly.)

## Resuming the previous playback

If playback of a scene was stopped halfway, the playback can be resumed from where it was stopped.

**Select the menu. (→ 23)**

[VIDEO SETUP] → [RESUME PLAY] → [ON]

If playback of a motion picture is stopped,  appears on the thumbnail view of the stopped scene.

- The memorised resume position is cleared if you turn off the power or change the mode.  
(The setting of [RESUME PLAY] does not change.)

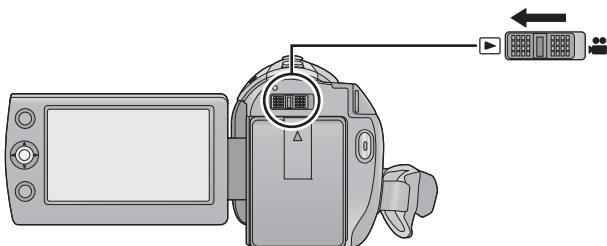

- 1 Change the mode to .
- 2 Use the joystick to select the play mode select icon , then press the centre of the joystick.

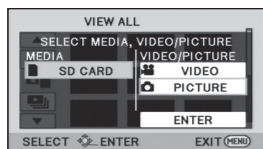

- 3 **SDR-S70**  
Select [PICTURE], then press the centre of the joystick.

**SDR-T70**

Select [SD CARD]/[Built-inMemory] and [PICTURE], then press the centre of the joystick.

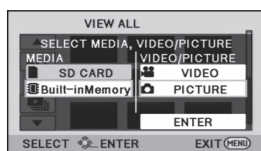
**SDR-H100**

Select [SD CARD]/[HDD] and [PICTURE], then press the centre of the joystick.

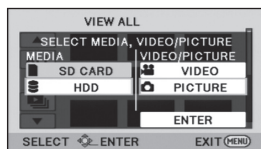

- Select [ENTER], then press the centre of the joystick.
- Press the MENU button to cancel the setting.

## 4 Select the still picture to be played back, then press the joystick.

- The operation icon will be displayed or hidden each time the centre of the joystick is pressed.
- Next (previous) page can be displayed by selecting /.

## 5 Select the playback operation with the joystick.



- ▶/||: Slide show (playback of the still pictures in numerical order) start/pause.
- ◀||: Plays back the previous picture.
- ||▶: Plays back the next picture.
- : Stops the playback and shows the thumbnails.

### ■ Change the thumbnail display

During step 4, the thumbnail display changes in the following order if the zoom lever is operated to side or side.  
20 still pictures ↔ 9 still pictures ↔ 1 still picture

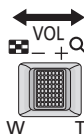

- 9 still pictures display returns if the power is turned off or the mode is switched.

### Still picture compatibility

- This unit is compliant with the unified standard DCF (Design rule for Camera File system) established by JEITA (Japan Electronics and Information Technology Industries Association).
- The file format of still pictures supported by this unit is JPEG. (Not all JPEG formatted files will be played back.)
- This unit may degrade or not play back still pictures recorded or created on other products and other products may degrade or not play back still pictures recorded on this unit.

## Playing back still pictures by date

Still pictures recorded on the same day can be played back in succession.

## 1 Select the date select icon and press the joystick.



- **A** Date select icon

## 2 Select the playback date, then press the joystick.

- The still pictures recorded on the date selected are displayed as thumbnails.

## 3 Select the still picture to be played back and press the joystick.

- Playing back of all the still pictures returns if the power is turned off or the mode is changed.
- Even if still pictures are recorded on the same day, they are grouped separately in the following cases.
  - When the number of still pictures exceeds 999
- is displayed after the date in the list by date for the still pictures created from the motion picture. (→ 62)

## Changing the playback setting and playing back the slide show

- 1 Select  and press the joystick.



- 2 Select the desired item and press the joystick.

### [DATE SETUP]:

Select the desired playback date.

### [SLIDES INTERVAL]:

Select the playback time display interval.

(When [DATE SETUP] has been selected)

**Select the desired playback date, then press the centre of the joystick.**

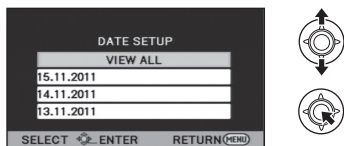

(When [SLIDES INTERVAL] has been selected)

**Select the playback interval, then press the centre of the joystick.**

### [SHORT]:

Approx. 1 second

### [NORMAL]:

Approx. 5 seconds

### [LONG]:

Approx. 15 seconds

- 3 Select [START], then press the centre of the joystick.

# Deleting scenes/still pictures

VIDEO PHOTO

Deleted scenes/still pictures cannot be restored, so perform appropriate confirmation of the contents before proceeding with deletion.

- ◇ Change the mode to  .

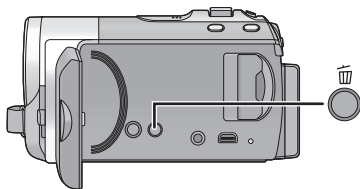

## To delete by confirming images being played back

Press the  button while scenes or still pictures to be deleted are being played back.

## ■ Deleting multiple scenes/still pictures from the thumbnail display

- 1 Press the  button while the thumbnail view screen is displayed.
- 2 Select [SELECT] or [ALL SCENES] and press the joystick.

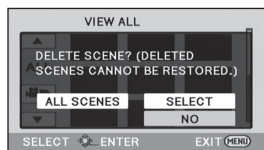

- When [ALL SCENES] is selected, all the scenes or still pictures on the selected media will be deleted.  
(In case of playing back scenes or still pictures by date, all the scenes or still pictures on the selected date will be deleted.)
- Protected scenes/still pictures cannot be deleted.

- 3 (Only when [SELECT] is selected in step 2)

## Select the scene/still picture to be deleted, then press the joystick.

- A scene or still picture will be selected, and  will be displayed. Press the centre of the joystick again to deselect.
- Up to 99 scenes can be selected to be deleted.

- 4 (Only when [SELECT] is selected in step 2)

## Select [Delete] and press the joystick or press the button.

- To continuously delete other scenes/still pictures, repeat steps 3-4.

---

### When you stop deleting halfway

Press the MENU button while deleting.

- The scenes or still pictures that have already been deleted when the deletion is cancelled cannot be restored.

### To complete editing

Press the MENU button.

---

- You can also delete scenes by pressing the MENU button, selecting [EDIT SCENE] → [DELETE] → [ALL SCENES] or [SELECT].
- You can also delete still pictures by pressing the MENU button, selecting [PHOTO SETUP] → [DELETE] → [ALL SCENES] or [SELECT].
- Scenes/still pictures which cannot be played back (the thumbnails are displayed as ) cannot be deleted.
- In case of [ALL SCENES], the deletion may take time if there are many scenes or still pictures.
- If you delete scenes recorded on other products or still pictures conforming to DCF standard with this unit, all the data related to the scenes/still pictures may be deleted.
- When still pictures recorded on an SD card by other products are deleted, a still picture (other than JPEG) that cannot be played back on this unit may be erased.

## Protecting scenes/still pictures

Scenes/still pictures can be protected so that they are not deleted by mistake.

**(Even if you protect some scenes/still pictures, formatting the media will delete them.)**

◇ Change the mode to  .

### 1 Select the menu. (→ 23)

[VIDEO SETUP] or [PHOTO SETUP] →  
[SCENE PROTECT]

### 2 Select the scene/still picture to be protected and press the joystick.

-  will be displayed, and the selected scene/still picture will be protected. Press the joystick again to deselect.
  - Press the MENU button to complete the settings.
- 
- When the disc playback is selected while a DVD burner (optional) is connected, scenes cannot be protected.

## Dividing a scene to partially delete [SDR-T70]/[SDR-H100]

VIDEO

This divides the recorded scenes in two and deletes the front half or back half.

[SDR-T70]

- ◆ Change the mode to , and switch play mode selection to [Built-inMemory]/[VIDEO] (→ 59)

[SDR-H100]

- ◆ Change the mode to , and switch play mode selection to [HDD]/[VIDEO] (→ 59)

### 1 Select the menu. (→ 23)

[EDIT SCENE] → [SPLIT&DELETE]

### 2 Select the scene to be divided, then press the joystick.

### 3 When you reach the point where you want to divide the scene Select [] with the joystick.



- Move the joystick left or right to fast forward/rewind playback.
- Using slow-motion playback or frame-by-frame playback makes it easy to search for the point where you want to divide the scene. (→ 61)

### 4 Select the half that you want to delete and press the joystick.

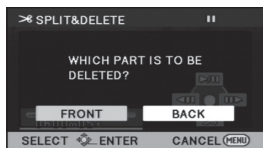

### 5 Select [YES], then press the joystick to play back the part to be deleted.

- When [NO] is selected, the confirmation message appears. Proceed to step 7.

### 6 When you stop the playback, the confirmation message appears.

### 7 Select [YES], then press the joystick.

#### To continue dividing and deleting other scenes

Repeat steps 2 to 7.

#### To complete editing

Press the MENU button.

- It is impossible to divide and delete scenes with a short recording time. The length of the remaining scenes must be 3 seconds or longer.
- It is impossible to set the dividing point at the beginning or the end of the scene.
- When a scene that was divided and deleted using the SPLIT&DELETE function is copied to a disc using the DVD burner or the supplied software and played back on another device, a maximum of about 1 second of the deleted part may be played back.
- The actual division may slightly slip off the previously designated dividing point.

PHOTO

You can write the data selecting still pictures to be printed and the number of prints (DPOF data) onto the SD card.

- ◇ Change the mode to , and switch play mode selection to [SD CARD]/[PICTURE] (→ 65)

### 1 Select the menu. (→ 23)

[PHOTO SETUP] → [DPOF SET] → [SET]

### 2 Select the still picture to be set, then press the joystick.

### 3 Select the number of prints, then press the joystick.



- Up to 999 prints can be selected. (Prints for set number can be printed with a printer that supports DPOF.)
- To cancel the setting, set the number of prints to [0].
- To continuously set other still pictures, repeat steps 2-3.
- Press the MENU button to complete the settings.

To cancel all DPOF settings

[DPOF SET] → [CANCEL ALL]

### ■ What is DPOF?

DPOF (Digital Print Order Format) is a format which allows the user of a digital camera to define which captured images on the SD card are to be printed, together with information on the number of copies they wish to print. (Please note: Not all commercial printing services support this feature at this time.)

- DPOF setting is not possible during disc playback while connected to a DVD burner.
- You cannot add the recording date to pictures to be printed with the DPOF settings.

SDR-T70 / SDR-H100

- Copy still pictures saved in the built-in memory or HDD to an SD card before setting DPOF.

PHOTO

Still pictures recorded with this unit can be copied between an SD card inserted in this unit and a built-in memory/HDD.

- **Motion pictures cannot be copied to SD card directly, can only be copied to PC.**

### ■ Confirming remaining capacity on the copy destination



The amount of space left on the SD card, the built-in memory and HDD can be checked.

- Depending on the media condition, some remaining capacity of the SD card, built-in memory or HDD may not be used.
- If the remaining capacity on a single SD card is not enough, you can copy to multiple SD cards following the instruction on the screen.

◇ Change the mode to  .

Select the menu. (→ 23)

[SETUP] → [MEDIA STATUS]

- Current media information will be displayed.
  -  Press the centre of the joystick to switch display between SD card and built-in memory.
  -  Press the centre of the joystick to switch display between SD card and HDD.
  - Press the MENU button to end.
- 
- The SD card, built-in memory or built-in HDD requires some space to store information and manage system files, so the actual usable space is slightly less than the indicated value. The usable built-in memory/HDD space is generally calculated as 1 GB=1,000,000,000 bytes. The capacities of this unit, PCs and software are expressed as 1 GB=1,024×1,024×1,024=1,073,741,824 bytes. Therefore, the indicated value of the capacity appears to be smaller.

## Copying

- If there is not much remaining capacity in the SD card, a confirmation message asking to copy after deleting all data on the SD card is displayed. Be aware that deleted data cannot be restored.

1

SDR-T70

Change the mode to , and switch play mode selection to [SD CARD]/[PICTURE] or [Built-inMemory]/[PICTURE] (→ 65)

SDR-H100





Change the mode to , and switch play mode selection to [SD CARD]/[PICTURE] or [HDD]/[PICTURE] (→ 65)

- Use a sufficiently charged battery or the AC adaptor.





2 Select the menu. (→ 23)

[COPY]

SDR-T70

- Select  →  to copy information from the built-in memory to the SD card, or select  →  to copy information from the SD card to the built-in memory, then press the centre of the joystick to confirm.

SDR-H100

- Select  →  to copy information from the HDD to the SD card, or select  →  to copy information from the SD card to the HDD, then press the centre of the joystick to confirm.

3 Follow the screen display, use the joystick to select the desired item then press the centre of the joystick.

- (When [SELECT SCENES] is selected) Press the centre of the joystick to select the scene, after which  will be displayed. Press the centre of the joystick again to deselect.
- (When [SELECT DATE] is selected) Press the centre of the joystick to select the date, which will be outlined in red. Press the centre of the joystick again to deselect.

- Up to 99 still pictures or 99 dates can be set in succession.
- If 2 or more SD cards are necessary to copy, change the card following the instructions on the screen.

4 Press the MENU button after the copying complete message appears.

- The thumbnail view of the copy destination is indicated.

*When you stop copying halfway*

Press the MENU button while copying

**If you will delete the still pictures after copying is complete, be sure to play back the still pictures to check that they have been copied to correctly before deleting.**

- When the disc playback is selected while a DVD burner (optional) is connected, menus are not displayed.
- Depending on the following conditions, the time it takes for copying may be longer.
  - The number of recorded scenes is large.
  - The temperature of the unit is high.
- If some still pictures have already been recorded to the copy destination, then the same date may be assigned or images may not display by date when the list by date is selected.
- It may not be possible to copy some still pictures recorded on other devices.
- Protection and DPOF settings will be cleared on the copied still pictures when copying still pictures with protection and DPOF settings.
- The order in which the still pictures were copied cannot be changed.

Please be aware that if a medium is formatted, then all the data recorded on the medium will be erased and cannot be restored. Back up important data on a PC, DVD disc etc. (→ 77, 84)

Select the menu. (→ 23)

SDR-S70

[SETUP] → [FORMAT CARD]

Select [YES], then press the joystick.

- After formatting is complete, press the MENU button to close the message screen.
- Perform a physical formatting of the SD card when the SD card is to be disposed/transferred. (→ 110)

SDR-T70

SDR-H100

[SETUP] → [FORMAT MEDIA]

**1** Select [SD CARD], [Built-inMemory] or [HDD] and press the joystick.

**2** Select [YES], then press the joystick.

- After formatting is complete, press the MENU button to close the message screen.
- Perform a physical formatting of the SD card when the SD card is to be disposed/transferred. (→ 110)
- Perform a physical formatting of the built-in memory/HDD when this unit is to be disposed/transferred. (→ 108)

- 
- Do not turn this unit off or remove the SD card, while formatting. Do not expose the unit to vibrations or shock.

**Use this unit to format media.**

**Formatting built-in memory or HDD is only available with this unit.**

**Do not format an SD card using any other equipment such as a PC. The card may not be used on this unit.**

## 1

## Watching Video/Pictures on your TV

VIDEO PHOTO

The motion pictures and still pictures recorded by this unit can be played back on a TV.

- Use the AC adaptor to free you from worrying about the battery running down.
- If you have a TV with an SD card slot, the motion pictures and still pictures recorded on an SD card may be played back on the TV. (Refer to the operating instructions of the TV for details about TV compatibility.)

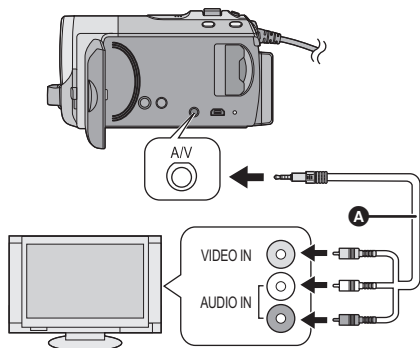

- A** AV cable (supplied)
- Insert the plugs as far as they will go.
  - Do not use any other AV cables except the supplied one.
  - Select the video input on the TV that this unit is connected to.

- 1** Connect this unit and a TV.
- 2** Turn on this unit, and change the mode to .
- 3** Start playback on this unit.

■ If the image or audio from this unit does not appear on the TV

- Check the connections.
- Check that the plugs are inserted as far as they go.
- Check the TV's input setting (input switch). (For more information, please read the operating instructions for the TV.)



■ **To watch images on a regular TV (4:3) or when both sides of the images do not appear on the screen**

Change the menu setting to display the images correctly. (Check the TV setting.)

**Select the menu. (→ 23)**

[SETUP] → [TV ASPECT] → [4:3]

**Example of images with a 16:9 aspect ratio on a regular TV (4:3)**

[TV ASPECT] setting	
[16:9]	[4:3]
	

- If a wide-screen TV is connected, adjust the aspect setting on the TV. (Refer to the operating instructions of the TV for details.)

**Refer to the following support site for information about the Panasonic TVs that you can directly insert an SD card into the SD card slot on the TV and then play it back.**  
<http://panasonic.net/>

- For details on how to play back, please read the operating instructions for the TV.

■ **To display the on-screen information on the TV**

The information displayed on the screen (operation icon and time code etc.) can be displayed on the TV.

**Select the menu. (→ 23)**

[SETUP] → [EXT. DISPLAY] → [ON]

- Select [OFF] to erase the information.
- The screen on this unit will not change.

# Connecting a DVD burner to copy to/play back a disc

VIDEO PHOTO

Motion pictures or still pictures recorded with this unit can be copied to a DVD disc by connecting a DVD burner (optional) to this unit using a USB Connection Cable (supplied with DVD burner). The copied DVD disc can also be played back.

- Please read the operating instructions of the DVD burner for how to use it.

## Preparing for copying/playing back

**We recommend using Panasonic DVD burner VW-BN01.**

### ■ About discs that can be used for copying

Disc type	DVD-RAM	DVD-RW/+RW	DVD-R/DVD-R DL/ +R/+R DL
Copy <sup>*1</sup>	○	○	○
Additional copy <sup>*2</sup>	○	—	—
Format <sup>*3</sup>	○	○	—

\*1 Use a new disc. You can additionally copy only to a DVD-RAM. When you copy to DVD-RW, DVD-R, DVD-R DL, +RW, +R or +R DL the disc is automatically finalised to allow playback on other devices and additional copying will not be possible.

\*2 Only DVD-RAM copied with the DVD burner or VideoCam Suite 3.5 can additionally copy.

\*3 Connect this unit and a DVD burner before formatting. If you format a used disc, you can copy on that disc. Please be aware that if a disc is formatted, then all the data recorded on the disc will be erased. (→ 82)

- We recommend using the discs that have been recommended in the operating instructions of the DVD burner. Refer to the operating instructions of the DVD burner for details about recommended discs, disc handling etc.

# 1 Connect the AC adaptor (supplied with DVD burner) to the DVD burner.

- You cannot supply power to the DVD burner from this unit.

# 2 Connect this unit to the AC adaptor and change the mode to .

# 3 Connect this unit to the DVD burner with the USB Connection Cable (supplied with DVD burner).

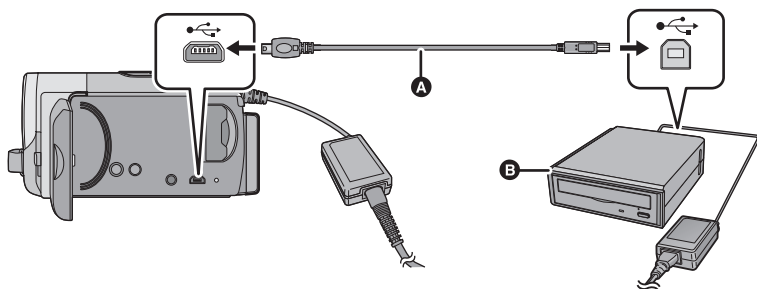

**A** USB Connection Cable (supplied with DVD burner)

**B** DVD burner (optional)

- Insert the plugs as far as they will go.

# 4 Insert the disc in the DVD burner.

- Insert the DVD disc with the recording side down when using the DVD burner.

# 5 Select the desired item and press the joystick.

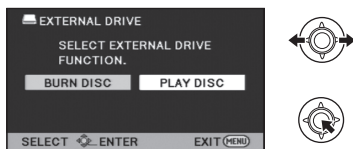

## [BURN DISC]:

Refer to page 79 for how to copy discs.

## [PLAY DISC]:

Refer to page 81 for how to play back the copied discs.

---

## *To terminate the connection with the DVD burner*

Press the MENU button.



- Disconnect the USB Connection Cable from this unit.

## Copying to discs

- You cannot copy from multiple SD cards to 1 disc. (You can additionally copy only to a DVD-RAM.)
- Motion pictures and still pictures cannot both be copied to a single disc.
- Refer to page 80 for Approximate time for copying to a disc.

### **1** Connect this unit to the DVD burner to prepare for copying. (→ 78)

### **2** Follow the screen display, use the joystick to select the desired item then press the centre of the joystick.

- Select  and press the centre of the joystick to return to the previous step.
- (When [SELECT SCENES] is selected) Press the centre of the joystick to select the scene, which  will then be displayed. Press the centre of the joystick again to deselect.
- (When [SELECT DATE] is selected) Press the centre of the joystick to select the date, which will be outlined in red. Press the centre of the joystick again to deselect.
- Up to 99 scenes/99 dates can be selected in succession.

### **3** Select [START], then press the centre of the joystick.

- When 2 or more discs are necessary for copying, follow the on-screen instructions to switch discs.
- You may need more discs than displayed number of discs when you are copying additionally to a used DVD-RAM.
- Eject the disc after copying is completed.
- When the copied disc is played back on another device and the list of scenes is displayed, they are ordered by date.

**Before you delete the data on the media after copying is complete, be sure to play back the discs to check that they have been copied to correctly. (→ 81)**

## Important Notice

- When inserting a disc containing recorded motion/still pictures into other devices, a message prompting you to format the disc may be displayed. Do not format the disc, since deleted data cannot be restored later.

## Approximate time for copying to a disc

To copy motion pictures to the full capacity of a disc

Disc type	Copy time
DVD-RAM	Approx. 40 min to 1 h 30 min
DVD-RW <sup>+</sup> /+RW <sup>+</sup>	Approx. 30 min to 1 h
DVD-R <sup>+</sup> /+R <sup>+</sup>	Approx. 15 min to 1 h

\* Even if the data capacity to be copied is small, the time it takes for copying may be about the same as the time shown in the table.

To copy approx. 600 MB still pictures

Disc type	Copy time
DVD-RAM/DVD-RW/DVD-R/ +RW/+R	Approx. 30 min to 40 min

- Copy time of DVD-R DL/+R DL is approximately 2 to 3 times that of DVD-R/+R.
- Depending on the following conditions, the time it takes for copying may be longer than the above times.
  - When the number of recorded scenes is large
  - When the temperature of the DVD burner has become high

- **The disc that was copied to can be played back by connecting this unit and a DVD burner. (→ 81)**
- Do not turn off this unit or the DVD burner or disconnect the USB Connection Cable while copying. Also, do not shake this unit or the DVD burner.
- It is impossible to stop copying halfway.
- The order in which the scenes were copied cannot be changed.
- Data that has been recorded on another device may not be copied.
- Because copying is carried out in units of scenes, unused disc space may arise when copying to two or more discs.
- There is no guarantee that a disc created by connecting this unit and the DVD burner will play back on any playable device.

## Playing back the copied disc

- Only discs that have been copied by connecting this unit to the DVD burner or created with VideoCam Suite 3.5 can be played back.

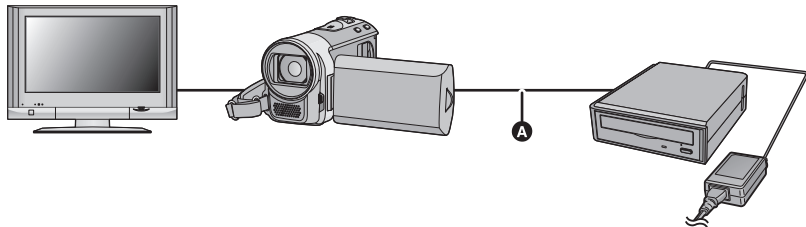

- **A** USB Connection Cable (supplied with DVD burner)

### **1** Connect this unit to the DVD burner to prepare for playback. (→ 78)

- When playing back on a TV, connect this unit to the TV. (→ 75)

### **2** Use the joystick to select a scene or a still picture, then press the centre of the joystick for playback.

- The playback operation is performed the same as when playing back motion pictures or still pictures. (→ 59, 65)
  - It will return to step 5 on page 78 when [Return] is selected in the thumbnail screen.
- 
- It is also possible to switch the media to play back by selecting the play mode select icon. It is possible to select [DISC]/[VIDEO] or [DISC]/[PICTURE] when the DVD burner is connected.

## Managing the copied disc

- Connect this unit to a DVD burner, use the joystick to select [PLAY DISC], then press the centre of the joystick (→ 78)

### ■ Formatting discs

This is for initializing DVD-RAM and DVD-RW/+RW discs.

**Please be aware that if a disc is formatted, then all the data recorded on the disc will be erased. Back up important data on a PC etc.**

**Select the menu. (→ 23)**

[DISC SETUP] → [FORMAT DISC]

- After formatting is complete, press the MENU button to close the message screen.
- Connect this unit and the DVD burner to format discs. You may no longer be able to use the discs if you format them on another device such as a PC etc.

### ■ Auto protect

You can protect (write protect) a DVD-RW disc when copying still pictures.

**1 Select the menu. (→ 23)**

[DISC SETUP] → [AUTO PROTECT] → [ON]

- If a disc that you copied to is inserted in another device without protecting it, a message may be displayed prompting you to format the disc. We recommend setting [AUTO PROTECT] to [ON] in order to prevent accidental deletion.

**2 Copy to the disc. (→ 79)**

- After copying, the disc is write protected.

*To release the disc protection*

**Select the menu. (→ 23)**

[DISC SETUP] → [CANCEL PROTECT]

- After successfully releasing [AUTO PROTECT], press the MENU button to close the message screen.

### ■ Displaying disc information

Information such as the type of recorded disc, the number of recorded scenes and whether or not the disc is finalized is displayed.

**Select the menu. (→ 23)**

[DISC SETUP] → [DISC STATUS]

- Press the MENU button to exit the information screen.

# Dubbing images onto other video device

VIDEO

Images played back on this unit can be dubbed onto a DVD recorder or video device.

- Use the AC adaptor to free you from worrying about the battery running down.

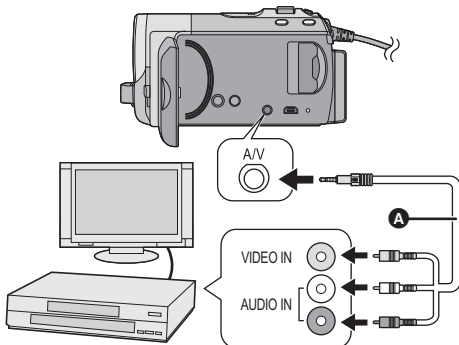

- A** AV cable (supplied)
- Insert the plugs as far as they will go.
  - Do not use any other AV cables except the supplied one.
  - Select the video input on the video device and TV that this unit and the video device are connected to.

**1** Connect this unit to a video device and then change the mode to .

**2** Start playback on this unit.

**3** Start recording on the connected device.

- To stop recording (dubbing), stop playback on this unit after stopping recording on the recorder.
- If the date and time display and function indication are not wanted, cancel them before dubbing. (→ 28, 76)

If the dubbed images are played back on a wide-screen TV, the images may be stretched vertically.

In this case, refer to the operating instruction of the device you are connecting to or read the operating instructions of the wide-screen TV and set the aspect ratio to 16:9.

## ■ Using SD card slot or USB terminal of other video devices

If you have a DVD recorder with an SD card slot or a USB terminal, images recorded by this unit can be copied (dubbed) onto the hard disk or a DVD disc.

Refer to the operating instructions of your DVD recorder for information about whether or not it supports copying (dubbing) from an SD card or a USB terminal.

### When using a USB terminal

Connect this unit to a DVD recorder with the USB cable (supplied), then select [PC/RECORDER] on the USB function selection screen.

# What you can do with a PC

## VideoCam Suite 3.5

You can copy the motion/still picture data to the HDD of PCs or write to media like DVD discs or SD card using VideoCam Suite 3.5, the software installed in the supplied CD-ROM.

Refer to the operating instructions of VideoCam Suite 3.5 (PDF file) for details on how to use it.

### ■ Smart wizard

The Smart wizard screen is automatically displayed when you connect this unit to a PC with VideoCam Suite 3.5 installed. (→ 92)

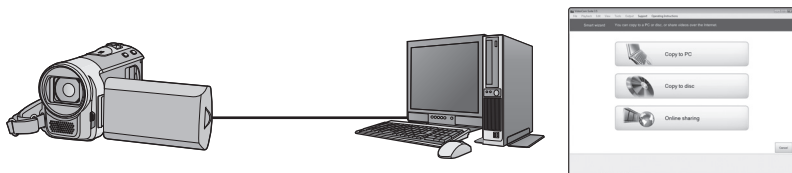

### Copy to PC:

You can copy motion/still picture data to the HDD of PCs.

### Copy to disc:

You can copy to disc in conventional standard picture quality (MPEG2 format).

- Select the function you wish to use and follow the on-screen instructions for easy copying.

Available function	Data type	Software required
<b>Copying data to a PC</b>	Motion picture and still picture	<b>CD-ROM (supplied):</b> VideoCam Suite 3.5
<b>Editing:</b> Editing motion picture data copied on an HDD of a PC <ul style="list-style-type: none"> <li>• Title, Transition, Delete partially, Divide Scene</li> <li>• Converting part of motion picture into still picture</li> </ul>	Motion picture	
<b>Online sharing:</b> You can upload motion pictures on the Internet and share them with your family and friends.		
<b>Playing back on a PC</b>		
Refer to page 97 if using a Mac.		

- 
- **When Windows is used as the PC operating system, a message prompting to format may display when a SDXC card is read. (Please be aware that if a media is formatted, then all the data recorded on the media will be erased.)**  
**<http://panasonic.net/avc/sdcard/information/SDXC.html>**
  - VideoCam Suite 3.5 can handle images recorded with this unit or by using VideoCam Suite 3.5. Images created with other video cameras, DVD recorders, software and commercial DVD-Videos are not supported.
  - We cannot guarantee proper operation of this unit if you use software other than that supplied.
  - Do not copy images recorded on this unit using any software other than the supplied software.

# End User License Agreement

Before opening the CD-ROM package, please read the following.

You ("Licensee") are granted a license for the Software defined in this End User License Agreement ("Agreement") on condition that you agree to the terms and conditions of this Agreement. If Licensee does not agree to the terms and conditions of this Agreement, promptly return the Software to Panasonic Corporation ("Panasonic"), its distributors or dealers from which you made the purchase.

## Article 1 License

Licensee is granted the right to use the software, including the information recorded or described on the CD-ROM, instruction manuals, and any other media provided to Licensee (collectively "Software"), but all applicable rights to patents, copyrights, trademarks and trade secrets in the Software are not transferred to Licensee.

## Article 2 Use by a Third Party

Licensee may not use, copy, modify, transfer or allow any third party, whether free of charge or not, to use, copy or modify the Software, except as expressly provided for in this Agreement.

## Article 3 Restrictions on Copying the Software

Licensee may make a single copy of the Software in whole or a part solely for back-up purpose.

## Article 4 Computer

Licensee may use the Software only on one computer, and may not use it on more than one computer.

**Article 5 Reverse Engineering, Decompiling or Disassembly**  
Licensee may not reverse engineer, decompile, or disassemble the Software, except to the extent either of them is permitted under law or regulation of the country where Licensee resides. Panasonic, or its distributors will not be responsible for any defects in the Software or damage to Licensee caused by Licensee's reverse engineering, decompiling, or disassembly of the Software.

## Article 6 Indemnification

The Software is provided "AS-IS" without warranty of any kind, either expressed or implied, including, but not limited to, warranties of non-infringement, merchantability and/or fitness for a particular purpose. Further, Panasonic does not warrant that the operation of the Software will be uninterrupted or error free. Panasonic or any of its distributors will not be liable for any damage suffered by Licensee arising from or in connection with Licensee's use of the Software.

## Article 7 Export Control

Licensee agrees not to export or re-export to any country the Software in any form without the appropriate export licenses under regulations of the country where Licensee resides, if necessary.

## Article 8 Termination of License

The right granted to Licensee hereunder will be automatically terminated if Licensee contravenes any of the terms and conditions of this Agreement. In this event, Licensee must destroy the Software and related documentation together with all the copies thereof at Licensee's own expense.

- Even if the system requirements mentioned in these operating instructions are fulfilled, some PCs cannot be used.
- A CD-ROM drive is necessary to install the supplied software applications. (A compatible DVD writer drive and media are necessary for writing to a DVD.)
- Operation is not guaranteed in the following cases.
  - When 2 or more USB devices are connected to a PC, or when devices are connected through USB hubs or by using extension cables.
  - Operation on an upgraded OS.
  - Operation on an OS other than the one pre-installed.
- Do not use any other USB cables except the supplied one. (Operation is not guaranteed with any other USB cables.)
- This software is not compatible with Microsoft Windows 3.1, Windows 95, Windows 98, Windows 98SE, Windows Me, Windows 2000 and Windows NT.

### ■ Operating environment for VideoCam Suite 3.5

<b>PC</b>	IBM PC/AT compatible PC
<b>OS</b>	Windows 7 (32 bit) Starter Windows 7 (32 bit/64 bit) Home Basic/Home Premium/Ultimate/ Professional Windows Vista (32 bit) Home Basic/Home Premium/Business/ Ultimate SP1/SP2 Windows XP (32 bit) SP3
<b>CPU</b>	Intel Pentium 4 2.0 GHz or higher (including compatible CPU) <ul style="list-style-type: none"> <li>• Intel Core 2 Duo 1.8 GHz or higher is recommended when a playback function or MPEG2 output function is used.</li> </ul>
<b>RAM</b>	Windows 7: 1 GB or more (32 bit)/2 GB or more (64 bit) Windows Vista: 1 GB or more Windows XP: 512 MB or more (1 GB or more recommended)
<b>Display</b>	High Colour (16 bit) or more (32 bit or more recommended) Desktop resolution of 1024×768 pixels or more (1280×1024 pixels or more recommended) Video card supporting DirectX 9.0c (supports overlay of DirectDraw) PCI Express™ ×16 compatible recommended

<b>Free hard disk space</b>	Ultra DMA — 33 or more 450 MB or more (for installing software) <ul style="list-style-type: none"> <li>When writing to a DVD/SD, more than double the amount of free space as the disc being created is necessary.</li> </ul>
<b>Sound</b>	DirectSound support
<b>Interface</b>	USB port [Hi-Speed USB (USB 2.0)]
<b>Other requirements</b>	Mouse or equivalent pointing device SD card reader/writer Internet connection

- Supplied CD-ROM is available for Windows only.
- Input is not supported in languages other than English, German, French and Simplified Chinese.
- Operation cannot be guaranteed on all DVD drives.
- Operation is not guaranteed on Microsoft Windows Vista Enterprise, Windows 7 Enterprise, Windows XP Media Center Edition or Tablet PC Edition.
- This software is not compatible with a multi-boot environment.
- This software is not compatible with a multi-monitor environment.
- If using Windows XP, an administrative account user only can use this software. If using Windows Vista/Windows 7, administrative account and standard account users only can use this software. (An administrative account user should install and uninstall this software.)
- DVD discs authored with this software are not guaranteed to play in all DVD players.

## ■ Operating environment for the card reader function (mass storage)

<b>PC</b>	IBM PC/AT compatible PC
<b>OS</b>	Windows 7 (32 bit/64 bit) Windows Vista (32 bit) SP1/SP2 Windows XP (32 bit) SP3
<b>CPU</b>	Windows 7/Windows Vista: 1.0 GHz or higher Windows XP: Intel Pentium III 450 MHz or higher or Intel Celeron 400 MHz or higher
<b>RAM</b>	Windows 7: 1 GB or more (32 bit)/2 GB or more (64 bit) Windows Vista Home Basic: 512 MB or more Windows Vista Home Premium/Business/Ultimate/Enterprise: 1 GB or more Windows XP: 128 MB or more (256 MB or more recommended)
<b>Interface</b>	USB port
<b>Other requirements</b>	Mouse or equivalent pointing device

- The USB equipment operates with the driver installed as standard in the OS.

When installing the software, log on to your computer as the Administrator or with a user name with equivalent authorization. (If you do not have authorization to do this, consult your manager.)

- Before starting the installation, close all applications that are running.
- Do not perform any other operations on your PC while the software is being installed.
- Explanation of operations and screens is based on Windows Vista.

## 1 Insert the CD-ROM into the PC.

- Click [Run setup.exe] → [Continue].
- When using Windows 7 or the following screen is not displayed automatically, select [Start] → [Computer] (or double-click on [Computer] on the desktop), and then double-click [Panasonic].

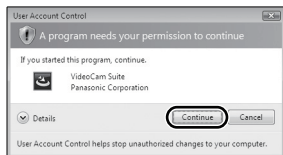
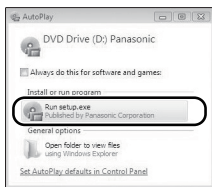

## 2 Click [Next].

## 3 Select [I accept the terms of the license agreement], then click [Next].

## 4 Select the country or region where you live, then click [Next].

- If the country or region cannot be selected, select [PAL Area].

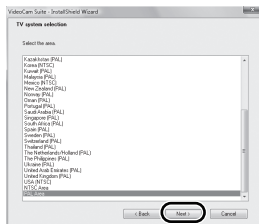

- When the confirmation message appears, click [Yes].

## 5 Select where the application is to be installed, then click [Next].

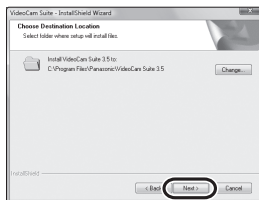

## 6 Select [Yes] or [No] to create shortcut.

- A message regarding the playback in the environment used may be displayed depending on the performance of the PC used. Click [OK] after confirming.

**7** When installation is complete, some notes will appear. **Check the contents, then close the window.**

**8** Select **[Yes, I want to restart my computer now.]**, then click **[Finish]**.



The PC must be rebooted for the application to work.

## ■ Uninstalling VideoCam Suite 3.5

Follow the steps below to uninstall any software applications that you no longer require.

**1** Select **[start] → [Control Panel] → [Uninstall a program]**.

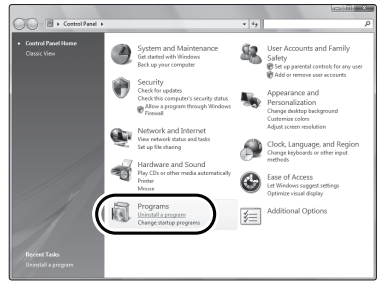

**2** Select **[VideoCam Suite 3.5]**, then click **[Uninstall]**.

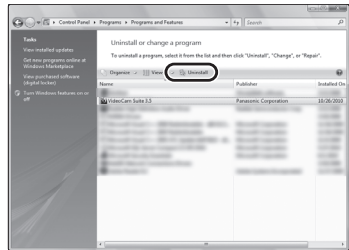

- Proceed with the uninstallation by following the on-screen instructions.
- After uninstalling the software, be sure to reboot the PC.

- Connect this unit to the PC after the software applications are installed.
- Remove the supplied CD-ROM from your PC.

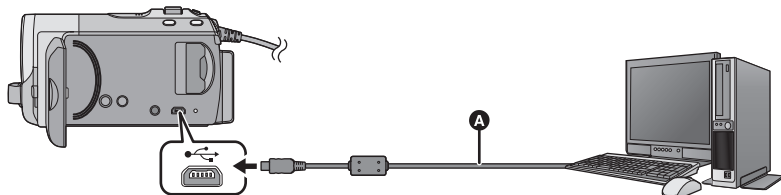

- A** USB cable (supplied)

### 1 Connect this unit to the AC adaptor.

- It is possible to use it connected to the PC with the batteries only.
- Use the AC adaptor to free you from worrying about the battery running down.



### 2 Turn on the unit.

- This function is available in all modes.
- When using the battery, the LCD monitor will be turned off after about 5 seconds. Operating the joystick will cause the LCD monitor to turn on again.

### 3 Connect this unit to a PC.

- Insert the USB connectors as far as they will go.
- Do not use any other USB cables except the supplied one. (Operation is not guaranteed with any other USB cables.)
- The Smart wizard screen is automatically displayed when VideoCam Suite 3.5 is installed.
- This unit is automatically recognised as an external drive of the PC. (→ 95)
- A USB function selection screen will be displayed if VideoCam Suite 3.5 has not been installed. Use the joystick to select [PC], then press the centre of the joystick. When you select an option other than [PC], reconnect the USB cable.

- When Windows is used as the PC operating system, a message prompting to format may display when a SDXC card is read. (Please be aware that if a media is formatted, then all the data recorded on the media will be erased.)  
<http://panasonic.net/avc/sdcard/information/SDXC.html>

- 
- **When the unit is connected to a PC its power cannot be turned off. Disconnect the USB cable, before turning this unit off.**
  - Do not disconnect the USB cable or the AC adaptor while the access lamp is on or card access icon (  ) appears on the unit screen.
  - **SDR-T70**  
Do not disconnect the USB cable or the AC adaptor while the access lamp is on or Built-in memory access icon (  ) appears on the unit screen.
  - **SDR-H100**  
Do not disconnect the USB cable or the AC adaptor while the HDD access lamp is on or HDD access icon (  ) appears on the unit screen.
  - When performing reading/writing between a PC and an SD card, be aware that some SD card slots built into PCs and some SD card readers are not compatible with the SDHC memory card or SDXC memory card.

## ■ To disconnect USB cable safely

- 1 Double click the  icon in task tray displayed on the PC.
  - Depending on your PC's settings, this icon may not be displayed.
- 2 **Select [USB Mass Storage Device] and click [Stop].**
- 3 **SDR-S70**  
**Verify [MATSHITA SDR-S70/SD USB Device] is selected and click [OK].**  
**SDR-T70**  
**Verify [MATSHITA SDR-T70/SD USB Device] or [MATSHITA SDR-T70/MEM USB Device] is selected and click [OK].**  
**SDR-H100**  
**Verify [MATSHITA SDR-H100/SD USB Device] or [MATSHITA SDR-H100/HDD USB Device] is selected and click [OK].**

## Charging the battery by connecting it to different devices

When using the battery, if you turn off the unit and connect it to a PC, Panasonic Blu-ray disc recorder or Panasonic DVD recorder, the battery will charge.

- **When connecting this unit to a PC for the first time, make sure to connect this unit to the PC with this unit turned on.**
- Insert the USB cable securely all the way. It will not operate properly if it is not inserted all the way.
- Do not use any other USB cables except the supplied one. (Operation is not guaranteed with any other USB cables.)
- Be sure to connect the unit directly to the PC, Blu-ray disc recorder or DVD recorder.
- During charging, the status indicator flashes.
- You cannot charge when the status indicator flashes rapidly for approx. 1 minute, or when it does not light at all. Charge using the AC adaptor. (→ 14)
- It will take 2 or 3 times longer to charge compared to when using the AC adaptor.
- If the status indicator flashes at a particularly fast or slow rate, refer to page 110.
- When this unit is connected to a PC, Blu-ray disc recorder or DVD recorder using a USB cable while the unit is turned on, power is also supplied from the connected equipment to this unit.

## About the PC display

When the unit is connected to a PC, it is recognised as an external drive.

- Removable disk (Example:  CAM\_SD (L)) is displayed in [Computer].

We recommend using VideoCam Suite 3.5 to copy motion picture data. Using Windows Explorer or other programmes on the PC to copy, move or rename files and folders recorded with this unit will result in them being unusable with VideoCam Suite 3.5.

It is impossible to write data to the built-in memory or HDD on this unit from a PC.

**Example folder structure of an SD card:**

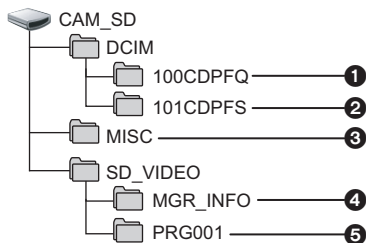

SDR-T70

SDR-H100

**Example folder structure of built-in memory or HDD:**

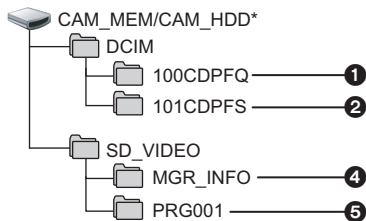

SDR-T70

- \* [CAM\_MEM] is displayed

SDR-H100

- \* [CAM\_HDD] is displayed.

The following data will be recorded.

- 1 Up to 999 still pictures in JPEG format (S1000001.JPG etc.)
- 2 JPEG format still pictures created from the motion picture
- 3 The DPOF setting files
- 4 SD-Video standard control data
- 5 SD-Video standard video data (maximum of 99 files)

### Copying your still pictures to your PC

#### Card reader function (mass storage)

Still pictures recorded with this unit can be copied to the PC with Explorer or other programmes.

- 1 Double click the folder that contains the still pictures. ([DCIM] → [100CDPFQ] etc.)
- 2 Drag and drop the still pictures onto the destination folder (on the PC's HDD).

- Do not delete the SD card's folders. Doing so may make the SD card unusable in this unit.
- When data not supported by this unit has been recorded on a PC, it will not be recognised by this unit.
- Always use this unit to format SD cards.

# Starting VideoCam Suite 3.5

- When using VideoCam Suite 3.5 on Windows XP, log on to your computer as Administrator (or with a login name equally authorized). If you log on with a login name other than Administrator, you cannot use the applications.
- When using VideoCam Suite 3.5 on Windows Vista/Windows 7, log on to your computer as Administrator (or with a login name equally authorized) or with the user name for a standard user account. If you log on with a user name for a guest user account, the software cannot be used.

(On the PC)

**Select [start] → [All Programs (Programs)] → [Panasonic] → [VideoCam Suite 3.5] → [VideoCam Suite].**

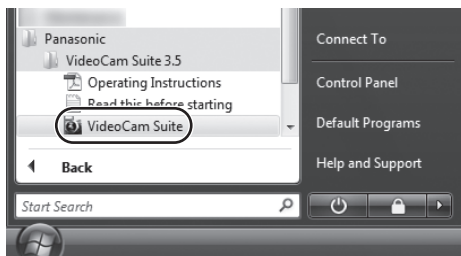

- For details on how to use the software applications, read the PDF operating instructions of the software.

## Reading the operating instructions of the software applications

- You will need Adobe Acrobat Reader 5.0 or later or Adobe Reader 7.0 or later to read the PDF operating instructions.

**Select [start] → [All Programs (Programs)] → [Panasonic] → [VideoCam Suite 3.5] → [Operating Instructions].**

- VideoCam Suite 3.5 is not available for Mac.
- SDXC memory cards cannot be used on Mac.
- iMovie'11 supported. For details about iMovie'11, please contact Apple Inc.

### ■ Operating environment

PC	Mac
OS	Mac OS X 10.6.3
CPU	Intel Core Duo or better
RAM	1 GB or more
Interface	USB port

- Even if the system requirements mentioned in these operating instructions are fulfilled, some PCs cannot be used.
- The USB equipment operates with the driver installed as standard in the OS.
- Supplied CD-ROM is available for Windows only.

### ■ Copying still pictures on PC

#### 1 Connect this unit to a PC via the supplied USB cable.

- The USB function selection screen will appear.

#### 2 Use the joystick to select [PC], then press the centre of the joystick.

- This unit is automatically recognised as an external drive of Mac.
- When you select an option other than [PC], reconnect the USB cable.
- When using the battery, the LCD monitor will be turned off after about 5 seconds. Operating the joystick will cause the LCD monitor to turn on again.

#### 3 Double-click [CAM\_SD] displayed on the desktop.

- [CAM\_SD] and [CAM\_MEM] are displayed on the desktop.
- [CAM\_SD] and [CAM\_HDD] are displayed on the desktop.
- Files are stored in [100CDPFQ]/[101CDPFS] folder etc. in the [DCIM] folder.

#### 4 Using a drag-and-drop operation, move the pictures you want to acquire or the folder storing those pictures to any different folder on the PC.

### ■ To disconnect USB cable safely

Drag [CAM\_SD] disk icon to the [Trash], and then disconnect the USB cable.

- [CAM\_SD] and [CAM\_MEM] are displayed on the desktop.
- [CAM\_SD] and [CAM\_HDD] are displayed on the desktop.

## 1

## Indications

## ■ Recording indications

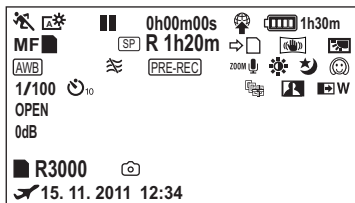
\*1  only\*2  only

Remaining battery power  
(→ 17)

1h30m

Remaining battery time  
(→ 17)<sup>2</sup>

R 1h20m

Remaining time for motion  
picture recording (→ 38)

0h00m00s

Elapsed recording time  
(→ 38)

("h" is an abbreviation for hour, "m" for  
minute and "s" for second.)

15.11.2011 Date/time indication (→ 28)  
12:34



World time setting (→ 29)

 /  / 

Motion picture recording mode (→ 40)



Built-in memory recording  
possible status<sup>1</sup>



HDD recording possible  
status<sup>2</sup>



(White) Card recording possible  
status



(Green) Recognising the card



(Red) Recording



(Green) Recording pause

 PRE-REC (→ 49)



Manual mode (→ 55)



Intelligent auto mode (→ 34)

MF

Manual focus (→ 58)



White balance (→ 56)

1/100

Shutter speed (→ 57)

OPEN/F2.2

Iris value (→ 57)

0dB

Gain value (→ 57)



Scene mode (→ 51)



Power LCD (→ 31)



Image stabilizer (→ 45)



AF/AE tracking (→ 46)



Relay recording (→ 52)<sup>1</sup>



Zoom microphone (→ 53)



WB ADJUST (→ 53)



Wind noise canceller (→ 53)



Backlight compensation  
(→ 48)



Soft skin mode (→ 49)



W / B Fade (White), Fade (Black)  
(→ 48)



Colour night view function  
(→ 49)



Intelligent contrast control  
(→ 49)





Web mode (→ 48)



Self-Timer recording (→ 53)

R3000

Remaining number of still  
pictures (→ 42)

 (White)	Still picture recording possible status
 (Red)	Recording still picture
	HDD Falling detection (→ 5) <sup>*2</sup>

## ■ Playback indications

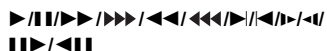

Display during playback (→ 59, 65)

**0h00m00s** Playback time (→ 60)

**No.10** Scene number

 Repeat playback (→ 64)

**100-0001** Still picture folder/file name



 **1** DPOF already set (to more than 1) (→ 71)

 Resume playback (→ 64)

 Protected motion pictures/still pictures (→ 69)

 Scenes recorded in the web mode (→ 48)

## ■ Indication of connection to other devices

	Accessing the card (→ 93)
	Accessing the built-in memory (→ 93) <sup>*1</sup>
	Accessing the HDD (→ 93) <sup>*2</sup>

## ■ Confirmatory indications

**-- (Time display)** The built-in battery is low. (→ 28)

 Warning for face-to-face recording (→ 32)

 SD card is not inserted or is non-compatible.

 The HDD cannot be accessed as the drop detection function has detected that the unit was dropped. If it detects that the unit is being continuously dropped, recording may stop.<sup>\*2</sup>

## ■ Confirmatory indications when a DVD burner is connected

 Disc playback (→ 81)

 Disc type (→ 77)

 Unusable disc

Major confirmation/error messages to be indicated on the screen in text.

\*1  only

\*2  only

#### **RECOMMEND DATA BACK UP PERIODICALLY.\*1\*2**

We recommend backing up important recorded motion pictures and still pictures periodically to a PC, DVD disc etc. to protect it. This message does not indicate that there is a problem with this unit.

#### **HDD BACKUP RECOMMENDED.\*2**

There is a possible problem with the HDD. Copy the motion pictures and still pictures stored on the HDD to a PC or a DVD disc immediately (→ 77, 84), and detach the power and contact your dealer.

#### **HDD ERROR OCCURRED. PLEASE TURN UNIT OFF, THEN TURN ON AGAIN.\*2**

Access to HDD failed. Turn on the power again. Make sure not to give a strong shock or impact to the unit.

#### **CANNOT OPERATE DUE TO LOW TEMPERATURE.\*2**

The internal temperature of this unit is extremely low so it cannot be operated. If "Please Wait." appears after this message, wait a while without turning the unit off. It may take time until the unit can be used.

#### **CHECK CARD.**

This card is not compatible or it cannot be recognised by the unit. If this message appears even though motion pictures and still pictures are recorded on an SD card, the card may be unstable. Reinsert the SD card, then turn the power off and then on again.

#### **THIS BATTERY CANNOT BE USED.**

- Use a battery that is compatible with this unit. (→ 12)  
If using a Panasonic battery compatible with this unit, remove the battery and then insert it again. If the message appears even after repeating this several times, this unit needs repair. Detach the power and consult the dealer who you purchased this unit from. Do not attempt to repair it by yourself.
- You are attempting to connect an AC adaptor not compatible with this unit. Use the supplied AC adaptor. (→ 14)



#### **PLEASE CHECK EXTERNAL DRIVE OR DISC.**

A disc that cannot be used when connecting the unit to the DVD burner has been inserted, or the DVD burner is not recognised properly. Connect the USB Connection Cable again and insert a disc to copy the data. (→ 77)

## About recovery

If faulty management information is found, the messages may appear. Be sure to follow the messages. (Repairing may take time depending on the error.)

**SOME SCENES NEED REPAIRING. PLAY SCENES TO BE REPAIRED.  
(IRREPARABLE SCENES WILL BE DELETED.)**

- The above message is displayed when abnormal management information is detected when the scenes are displayed in thumbnail. To perform the repair, select the scene with  in the thumbnail, and start the playback. Please be aware that if the repair fails, scenes with  will be deleted.

---

- Use a sufficiently charged battery or the AC adaptor.
- Depending on the condition of the data, it may not be possible to completely repair the data.
- If recovery fails, recorded scene playback will be impossible before power is turned OFF.
- When data recorded on another device is recovered, it may not be possible to play back the data on this unit or the other device.
- If recovery fails, turn the power of the unit off and on again after waiting a while. If recovery fails repeatedly, format a media on the unit. Please be aware that if a media is formatted, then all the data recorded on the media will be erased.
- If the thumbnail information is recovered, displaying the thumbnails may become slower.

## 1

# Functions that cannot be used simultaneously

Some functions in this unit are disabled or cannot be selected due to the unit's specifications.

Functions	Conditions which disable the functions
Intelligent auto mode	<ul style="list-style-type: none"> <li>• In manual mode</li> <li>• When the colour night view function is used</li> </ul>
AF/AE tracking	<ul style="list-style-type: none"> <li>• In manual mode</li> <li>• When the colour night view function is used</li> </ul>
Fade	<ul style="list-style-type: none"> <li>• When PRE-REC is used</li> </ul>
Auto slow shutter	<ul style="list-style-type: none"> <li>• When the scene mode is used</li> </ul>
Backlight compensation	<ul style="list-style-type: none"> <li>• When the colour night view function is used</li> <li>• When the iris/gain is set</li> </ul>
Intelligent contrast control	<ul style="list-style-type: none"> <li>• When the colour night view function is used</li> <li>• When the iris/gain is set</li> </ul>
Colour night view	<ul style="list-style-type: none"> <li>• When the AF/AE tracking is used</li> </ul>
Shutter sound	<ul style="list-style-type: none"> <li>• While recording motion picture</li> <li>• When PRE-REC is used</li> </ul>
Shooting guide	<ul style="list-style-type: none"> <li>• When the AF/AE tracking is used</li> </ul>
Zoom microphone	<ul style="list-style-type: none"> <li>• When the Intelligent auto mode is on</li> </ul>
Soft skin mode (Set and cancel)	<ul style="list-style-type: none"> <li>• While recording</li> </ul>
Colour night view (Set and cancel)	<ul style="list-style-type: none"> <li>• When PRE-REC is used</li> </ul>
Change of white balance	<ul style="list-style-type: none"> <li>• When digital zoom (78× or higher) is used</li> <li>• When the colour night view function is used</li> <li>• When the beach, sunset, fireworks or night scenery mode of scene mode is used</li> </ul>
Adjusting the shutter speed, iris/gain	<ul style="list-style-type: none"> <li>• When the colour night view function is used</li> <li>• When the scene mode is used</li> </ul>
Web mode	<ul style="list-style-type: none"> <li>• When PRE-REC is used</li> </ul>

# Troubleshooting

## Problem

**This unit cannot be turned on.**

**This unit does not stay on long enough.**

**Battery runs down quickly.**

**This unit is turned off automatically.**

**A clicking sound is heard when the unit is shaken about.**

**SDR-H100**  
**Remaining battery indication is not displayed properly.**

## Check points

- Charge the battery again to ensure it is sufficiently charged. (→ 14)
- In cold places, the battery using time becomes shorter.
- The battery has a limited life. If the operating time is still too short even after the battery is fully charged, the battery has worn out and needs to be replaced.

- If you do not use the unit for approximately 5 minutes, the power is automatically turned off to conserve battery life. To resume recording, turn the power back on.  
The power will not turn off automatically when the economy function (→ 25) is set to [OFF].
- When this unit is connected to a DVD burner to copy or play back images (a disc is being accessed), the power turns off automatically if the USB Connection Cable is removed.

- This is the sound of the lens moving and is not a defect.  
This sound will no longer be heard when the unit's power is turned on.

- The remaining battery capacity indication is an approximation.  
If you think the remaining battery capacity indication is not displayed correctly, fully charge the battery, discharge it and then charge it again. (Even if this operation is performed, it may not be possible to display the remaining battery capacity correctly if the battery was used for a long period of time where the temperature was low or high or if the battery was repeatedly charged.)

## Problem

**This unit cannot be operated though it is turned on.**

**This unit does not operate normally.**



**The remaining time indication or the elapsed time indication is not shown.**



**The unit arbitrarily stops recording.**



**Auto focus function does not work.**



**Colour balance of images is strange when recording in a place such as a gymnasium.**



## Check points

- Remove the battery or AC adaptor, wait about 1 minute and then reconnect the battery or AC adaptor. Then about 1 minute later, turn on the power again. (Conducting the above operation while the media is being accessed may damage the data on the media.)
- If normal operation is still not restored, detach the power connected, and consult the dealer who you purchased this unit from.



- If you set [SETUP] → [DISPLAY] → [OFF], indications other than warnings and date etc. are not displayed. (→ 25)

- Use an SD card that can be used for motion picture recording. (→ 18)
- The recordable time may have shortened due to the deterioration of the data writing speed or repeated recording and deletion. Using the unit, format the SD card, built-in memory or HDD (→ 74)

### **SDR-H100**

- If the unit is exposed to strong vibrations or shocks while recording on HDD, recording may stop to protect the HDD. If the unit is used in a place with loud sounds, the recording may stop due to sound vibrations. Recording data on an SD card is recommended in these places.

- Set to Intelligent auto mode to on.
- If you are trying to record a scene which is hard to bring into focus in auto focus mode, use the manual focus mode to adjust the focus. (→ 34, 58)

- In a place with multiple light sources, such as a gymnasium or a hall, set the white balance setting to  (Indoor mode 2). If you cannot record clearly with the  (Indoor mode 2), set it to  (Manual adjustment mode). (→ 56)

## Problem

## Check points

Any scenes/still pictures cannot play back.



- Any scenes/still pictures where the thumbnails are displayed as  cannot be played back.

Although this unit is correctly connected to a TV, images cannot be seen.



- Please read the operating instructions of your TV and select the channel that matches the input used for the connection.
- Change the [TV ASPECT] setting to match the aspect ratio of the TV. (→ 76)

The images are squeezed horizontally.

Scenes cannot be deleted.



- Release the protect setting. (→ 69)
- Any scenes/still pictures where the thumbnails are displayed as  cannot be deleted. If the scenes/still pictures are unnecessary, format the media to erase the data. (→ 74) Please be aware that if a media is formatted then all the data recorded on the media is erased and cannot be recovered. Back up important data on a PC, disc etc.

If the SD card is inserted in this unit, it is not recognised.



- If the SD card is formatted on a PC, it may not be recognised by this unit. Use this unit to format SD cards. (→ 74)

If the SD card is inserted in another device, it is not recognised.



- Check that the device is compatible with the capacity or type of SD card (SD Memory Card/SDHC Memory Card/SDXC Memory Card) that you inserted. Refer to the operating instructions of the device for details.

“ERROR OCCURRED. PLEASE TURN UNIT OFF, THEN TURN ON AGAIN.” is displayed.



- The unit has automatically detected an error. Restart the unit by turning off and on the power.
- The power will be turned off in about 1 minute if the power is not turned off and on.
- Repair is needed if it is repeatedly displayed even if it is restarted. Detach the power connected, and consult the dealer who you purchased this unit from. Do not attempt to repair the unit by yourself.

**Problem****Check points**

**When connected by the USB cable, this unit is not detected by the PC.**



- After re-inserting the SD card into the unit, reconnect the supplied USB cable.
- Select another USB terminal on the PC.
- Check the operating environment. (→ 87, 97)
- Connect the supplied USB cable again after restarting the PC and turning on this unit again.

**When connected by the USB cable, this unit is not detected by the other devices.**



- When connected to other devices using only the battery, reconnect using the AC adaptor.

**When the USB cable is disconnected, an error message will appear on the PC.**



- To disconnect the USB cable safely, double-click the  icon in the task tray and follow the instructions on the screen.

**The power of the DVD burner cannot be turned on.**



- When the unit is connected to the DVD burner, use the respective AC adaptors for both this unit and the DVD burner.

**The sound does not play back properly when a DVD disc that has been copied using the DVD burner is played back.**



- When the scenes are copied to a DVD disc using the DVD burner and then played back with any other devices, sound may not play back properly. In this case, use the software supplied with this unit to copy the scenes.

**Cannot see the PDF operating instructions for VideoCam Suite 3.5.**



- You will need Adobe Acrobat Reader 5.0 or later or Adobe Reader 7.0 or later to read the PDF operating instructions for VideoCam Suite 3.5.

# Cautions for use

## About this unit

The unit and the SD card become warm during use. This is not a malfunction.

**Keep this unit as far away as possible from electromagnetic equipment (such as microwave ovens, TVs, video games etc.).**

- If you use this unit on top of or near a TV, the pictures and/or sound on this unit may be disrupted by electromagnetic wave radiation.
- Do not use this unit near cell phones because doing so may result in noise adversely affecting the pictures and/or sound.
- Recorded data may be damaged, or pictures may be distorted, by strong magnetic fields created by speakers or large motors.
- Electromagnetic wave radiation generated by microprocessors may adversely affect this unit, disturbing the pictures and/or sound.
- If this unit is adversely affected by electromagnetic equipment and stops functioning properly, turn this unit off and remove the battery or disconnect AC adaptor. Then reinsert the battery or reconnect AC adaptor and turn this unit on.

**Do not use this unit near radio transmitters or high-voltage lines.**

- If you record near radio transmitters or high-voltage lines, the recorded pictures and/or sound may be adversely affected.

**Make sure to use the supplied cords and cables. If you use optional accessories, use the cords and the cables supplied with them.**

**Do not extend the cords and the cables.**

**Do not spray insecticides or volatile chemicals onto the unit.**

- If the unit is sprayed with such chemicals, its body may be marred and the surface finish may peel off.
- Do not leave rubber or plastic products in contact with the unit for a long time.

**When you use the unit in a sandy or dusty place such as a beach, do not let sand or fine dust get into the body and terminals of the unit.**

**Also, keep the unit away from sea water.**

- Sand or dust may damage the unit. (Care should be taken when inserting and removing a card.)
- If sea water splashes onto the unit, wipe off the water with a well wrung cloth. Then wipe the unit again with a dry cloth.

**When carrying the unit, do not drop or bump it.**

- A strong impact can break the unit's casing, causing it to malfunction.

## Cleaning

- Before cleaning, detach the battery or pull the AC cable from the AC outlet, and then wipe the unit with a soft, dry cloth.
- If the unit is very dirty, dip a cloth in water and squeeze firmly, and then wipe the unit with the damp cloth. Next, dry the unit with a dry cloth.
- Use of benzine, paint thinner, alcohol, or dishwashing liquid may alter the camera body or peel the surface finish. Do not use these solvents.
- When using a chemical dust cloth, follow the instructions that came with the cloth.

**Do not use the unit for surveillance purposes or other business uses.**

- This unit was designed for consumer intermittent use. It was not intended for continuous use, or for any industrial or commercial application resulting in prolonged use.
- In certain situations, continuous use could cause the unit to overheat and cause a malfunction. Such use is strongly discouraged.

**When you are not going to use the unit for an extended time**

- When storing the unit in a cupboard or cabinet, it is recommended that you place a desiccant (silica gel) in with it.

SDR-T70 / SDR-H100

**When disposing of or giving away this unit, note that:**

- Formatting and deletion simply change the file management information and cannot be used to completely erase the data in built-in memory or HDD of this unit. The data can be recovered using commercially available software or the like.
- We recommend that you physically format the built-in memory or HDD before disposing of or giving away this unit.

SDR-T70

To physically format the built-in memory, connect the unit via the AC adaptor, select [SETUP] → [FORMAT MEDIA] → [Built-inMemory] from the menu, and then press and hold the delete button on the screen below for about 3 seconds. When the built-in memory data deletion screen appears, select [YES], and then follow the on-screen instructions.

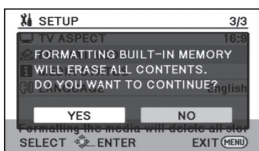

SDR-H100

To physically format the HDD, connect the unit via the AC adaptor, select [SETUP] → [FORMAT MEDIA] → [HDD] from the menu, and then press and hold the delete button on the screen below for about 3 seconds. When the HDD data deletion screen appears, select [YES], and then follow the on-screen instructions.

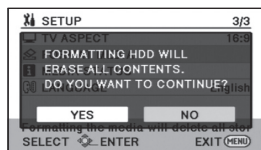

- Please look after the data in your built-in memory or HDD carefully. Panasonic will not be held responsible in the unlikely case that private data is divulged.

## About the battery

The battery used in this unit is a rechargeable lithium-ion battery. It is susceptible to humidity and temperature and the effect increases the more the temperature rises or falls. In cold areas, the full charge indication may not appear or the low battery indication may appear about 5 minutes after starting use. At high temperatures, the protection function may be triggered, making it impossible to use the unit.

### Be sure to detach the battery after use.

- If the battery is left attached, a minute amount of current continues to flow even if the unit's power is off. Keeping the unit in this state may result in over discharge of the battery. This may result in you not being able to use the battery even after it is charged.
- The battery should be stored in the vinyl bag so metal does not come into contact with the terminals.
- The battery should be stored in a cool place free from humidity, with as constant temperature as possible. (Recommended temperature: 15 °C to 25 °C, Recommended humidity: 40%RH to 60%RH)
- Extremely high temperatures or low temperatures will shorten the life of the battery.
- If the battery is kept in high-temperature, high-humidity, or oily-smoky places, the terminals may rust and cause malfunctions.
- To store the battery for a long period of time, we recommend you charge it once every year and store it again after you have completely used up the charged capacity.
- Dust and other matter attached to the battery terminals should be removed.

### Prepare spare batteries when going out for recording.

- Prepare batteries appropriate to 3 to 4 times the period you are planning to record for. Cold places such as a ski resort can shorten the period which you can record for.

### If you drop the battery accidentally, check to see if the terminals are damaged.

- Inserting a battery with damaged terminals can damage the unit.

### Do not throw old battery into fire.

- Heating a battery or throwing it into a fire may result in an explosion.

### If the operating time is very short even after the battery has been recharged, the battery has worn out. Please purchase a new battery.

## About the AC adaptor

- If the temperature of the battery is extremely high or extremely low, charging may take time or the battery may not be charged.
- If you use the AC adaptor near a radio, radio reception may be disturbed. Keep the AC adaptor 1 m or more away from the radio.
- When using the AC adaptor, it may generate whirring sounds. However, this is normal.
- After use, be sure to disconnect the AC adaptor. (If it is left connected, a minute amount of current is consumed.)
- Always keep the electrodes of the AC adaptor and battery clean.

## About charging errors

**When the status indicator is flashing at a particularly fast or slow rate, the following should be considered.**

**Flashing with approx. 4 second period (off for approx. 2 seconds, on for approx. 2 seconds):**

- The battery may be over-discharged, or the battery temperature may be high or low. The battery will charge, but it may take several hours for normal charging to begin.

**Flashing with approx. 0.5 second period (off for approx. 0.25 second, on for approx. 0.25 second):**

- The battery is not charged. Remove the battery from the unit, and try charging again.
- Check that the terminals of the unit or battery are not dirty or covered in a foreign object, and connect the battery correctly once again. If a foreign object or dirt is present, turn off the unit before removing.
- The battery or environment is at an extremely high or low temperature. Wait until the temperature has returned to an appropriate level and try charging again. If you are still unable to charge, there may be a fault in the unit, battery or AC adaptor.

**Lamp turns off:**

- Charging has finished.
- If the status indicator stays off despite the charging being unfinished, there may be a fault in the unit, battery or AC adaptor. Refer to page 109 for details on the battery.

## About SD cards

- The memory capacity indicated on the label of an SD card is the total of the capacity for copyright protection and management and the capacity which can be used on the unit, a PC etc.
- Do not apply strong shocks, bend, or drop the SD card.
- Electrical noise, static electricity or the failure of this unit or the SD card may damage or erase the data stored on the SD card.
- During long periods of use, it is normal for this unit and the SD card to become slightly warm and is not a malfunction.

**When the card access lamp is lit, do not:**

- Remove the SD card
- Turn the unit off
- Insert and remove the USB cable
- Expose the unit to vibrations or shock

**Cautionary points when handling**

- Do not expose the terminals of the SD card to water, garbage or dust.
- Do not place SD cards in the following areas:
  - Areas exposed to direct sunlight, or in high-temperature areas such near heating equipment.
  - In very dusty or humid areas.
  - Locations susceptible to significant difference in temperature (condensation can occur).
  - Where static electricity or electromagnetic waves occur.
- To protect SD cards, return them to their cases when you are not using them.

**When disposing of or giving away an SD card, note that:**

- Formatting and deletion simply change the file management information and cannot be used to completely erase the data in an SD card.
- We recommend that you physically format an SD card before disposing of or giving away the SD card.

#### ● SDR-S70

To physically format an SD card, connect the unit via the AC adaptor, select [SETUP] → [FORMAT CARD] from the menu, and then press and hold the delete button on the screen below for about 3 seconds. When an SD card data deletion screen appears, select [YES], and then follow the on-screen instructions.

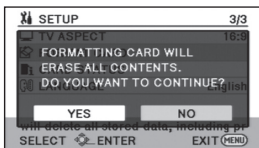

#### ● SDR-T70 / SDR-H100

To physically format an SD card, connect the unit via the AC adaptor, select [SETUP] → [FORMAT MEDIA] → [SD CARD] from the menu, and then press and hold the delete button on the screen below for about 3 seconds. When an SD card data deletion screen appears, select [YES], and then follow the on-screen instructions.

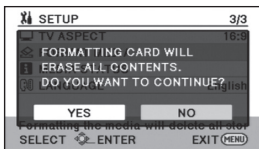

- Please look after the data in an SD card carefully.

### LCD monitor

- When the LCD monitor gets dirty, wipe it with a soft cloth, such as eye glass cleaner.
- In a place with drastic temperature changes, condensation may form on the LCD monitor. Wipe it with a soft cloth, such as eye glass cleaner.
- When the unit has become very cold, for example due to storage in a cold area, its LCD monitor will be slightly darker than

usual immediately after the power is turned on. The normal brightness will be restored when the unit's internal temperature rises.

Extremely high precision technology is employed to produce the LCD Monitor screen featuring a total of approximately 123,000 dots. The result is more than 99.99% effective dots with a mere 0.01% of the dots inactive or always lit. However, this is not a malfunction and does not affect the recorded picture.

### About condensation

When condensation forms on the unit, the lens will cloud up and the unit may not work properly. Make every effort to ensure that condensation does not form. If it does form, take the actions described below.

#### Causes of condensation

**Condensation takes place when the ambient temperature or humidity is changed as follows.**

- When this unit is brought inside from the cold (e.g. a ski slope) to a warm room.
- When this unit is moved from an air-conditioned car to outside.
- When a cold room has been warmed up quickly.
- When cool wind from an air conditioner is directly blown onto this unit.
- After summer afternoon showers of rain.
- When this unit is in a very humid place where the air is thick with steam. (e.g. a heated swimming pool)

#### Helpful hint

If, for example, you have used this unit for recording on a ski slope and are taking it into a heated room, place the unit inside a plastic bag, remove as much of the air from inside the bag as possible, then seal the bag. Leave the unit for about an hour in the room so the temperature of the unit is close to the ambient temperature of the room, then use it.

EU



Pursuant to at the directive 2004/108/EC, article 9(2)  
Panasonic Testing Centre  
Panasonic Marketing Europe GmbH  
Winsbergring 15, 22525 Hamburg, Germany

---

**Panasonic Corporation**  
Web site: <http://panasonic.net>

© Panasonic Corporation 2010