



S300 Series User's Guide

April 2009

www.lexmark.com

Machine type(s):

4443

Model(s):

101, 10E

Contents

Safety information.....	5
About your printer.....	6
Thank you for choosing this printer!.....	6
Minimizing your printer's environmental impact.....	6
Finding information about the printer.....	7
Understanding the parts of the printer.....	9
Ordering and replacing supplies.....	11
Ordering ink cartridges.....	11
Using genuine Lexmark ink cartridges.....	11
Replacing ink cartridges.....	12
Ordering paper and other supplies.....	13
Recycling Lexmark products.....	13
Using the printer control panel buttons and menus.....	14
Using the printer control panel.....	14
Changing temporary settings into new default settings.....	15
Changing the Power Saver timeout.....	16
Saving energy with Eco-Mode.....	17
Resetting to factory settings.....	17
Using the printer software.....	19
Minimum system requirements.....	19
Using the Windows printer software.....	19
Using the Macintosh printer software.....	21
Finding and installing optional software.....	22
Updating the printer software (Windows only).....	23
Reinstalling the printer software.....	23
Loading paper and original documents.....	25
Loading paper.....	25
Saving paper default settings.....	27
Loading original documents on the scanner glass.....	28

Printing	29
Tips for printing.....	29
Printing basic documents.....	29
Printing specialty documents.....	33
Printing on both sides of the paper (duplexing) manually.....	35
Working with photos.....	37
Printing from a Bluetooth-enabled device.....	42
Managing print jobs.....	45
Copying	49
Tips for copying.....	49
Making copies.....	49
Copying photos.....	49
Enlarging or reducing images.....	50
Adjusting copy quality.....	50
Making a copy lighter or darker.....	50
Collating copies using the printer control panel.....	51
Repeating an image on one page.....	51
Copying multiple pages on one sheet.....	52
Making a duplex copy manually.....	52
Canceling copy jobs.....	53
Scanning	54
Tips for scanning.....	54
Scanning to a local or network computer.....	54
Scanning to a flash drive or memory card.....	55
Scanning photos into an editing application.....	55
Scanning documents into an editing application.....	57
Scanning directly to e-mail using the printer software.....	57
Scanning to a PDF.....	58
Scanning FAQ.....	59
Canceling scan jobs.....	60
Networking	61
Installing the printer on a wireless network.....	61
Advanced wireless setup.....	66

Networking FAQ.....	73
Maintaining the printer.....	84
Maintaining ink cartridges.....	84
Cleaning the exterior of the printer.....	86
Cleaning the scanner glass.....	86
Troubleshooting.....	87
Before you troubleshoot.....	87
Using the Service Center to solve printer problems.....	87
If Troubleshooting does not solve your problem.....	87
Setup troubleshooting.....	87
Jams and misfeeds troubleshooting.....	93
Print troubleshooting.....	94
Copy and scan troubleshooting.....	96
Memory card troubleshooting.....	98
Wireless troubleshooting.....	99
Notices.....	118
Product information.....	118
Edition notice.....	118
Power consumption.....	122
Index.....	135

Safety information

Connect the power cord to an electrical outlet that is near the product and easily accessible.

Do not place or use this product near water or wet locations.

Use only the power supply and power cord provided with this product or the manufacturer's authorized replacements.

This product is designed, tested, and approved to meet strict global safety standards with the use of specific manufacturer's components. The safety features of some parts may not always be obvious. The manufacturer is not responsible for the use of other replacement parts.

 **CAUTION—POTENTIAL INJURY:** The area behind the duplex cover has protruding ribs as part of the paper path. To avoid injury, use caution when accessing this area for clearing a paper jam.

 **CAUTION—POTENTIAL INJURY:** Do not cut, twist, bind, crush, or place heavy objects on the power cord. Do not subject the power cord to abrasion or stress. Do not pinch the power cord between objects such as furniture and walls. If any of these things happen, a risk of fire or electrical shock results. Inspect the power cord regularly for signs of such problems. Remove the power cord from the electrical outlet before inspecting it.

Refer service or repairs, other than those described in the user documentation, to a professional service person.

 **CAUTION—SHOCK HAZARD:** To avoid the risk of electric shock when cleaning the exterior of the printer, unplug the power cord from the wall outlet and disconnect all cables from the printer before proceeding.

 **CAUTION—SHOCK HAZARD:** Do not use the fax feature during a lightning storm. Do not set up this product or make any electrical or cabling connections, such as the fax feature, power cord, or telephone, during a lightning storm.

SAVE THESE INSTRUCTIONS.

About your printer

Thank you for choosing this printer!

We've worked hard to make sure it will meet your needs.

To start using your new printer right away, use the setup materials that came with the printer, and then skim the *User's Guide* to learn how to perform basic tasks. To get the most out of your printer, read the *User's Guide* carefully, and make sure you check the latest updates on our Web site.

We're committed to delivering performance and value with our printers, and we want to make sure you're satisfied. If you do encounter any problems along the way, one of our knowledgeable support representatives will be delighted to help you get back on track fast. And if you find something we could do better, please let us know. After all, you are the reason we do what we do, and your suggestions help us do it better.

Minimizing your printer's environmental impact

We are committed to protecting the environment and are continually improving our printers to reduce their environmental impact. By selecting certain printer settings or tasks, you may be able to reduce your printer's environmental impact even further.

Conserving energy

- **Eco-Mode.** This feature sets the screen brightness to low and sets the printer to change to Power Saver mode after the printer is left idle for 10 minutes. Eco-Mode is enabled by default in your printer.
- **Select the lowest Power Saver timeout.** The Power Saver feature puts the printer in a minimum-power standby mode after the printer has been idle for a set amount of time (the Power Saver timeout).
- **Share your printer.** Wireless/network printers allow you to share a single printer among multiple computers, thus conserving energy and other resources.

Conserving paper

- **Print more than one page image on one side of the paper.** The "Pages per sheet" feature allows you to print multiple pages on one sheet. You can print up to 8 page images on one side of a sheet of paper.
- **Print on both sides of the paper.** Duplexing lets you print on both sides of the paper manually or automatically (depending on your printer model).
- **Preview print jobs before printing.** Use the preview features found in Toolbars, the Print or Print Preview dialog, or the printer display (depending on your printer model).
- **Scan and save.** To avoid printing multiple copies, you can scan documents or photographs and save them to a computer program, application, or flash drive for presentation.
- **Use recycled paper.**

Conserving ink

- **Use Quick Print or Draft Mode.** These modes can be used to print documents using less ink than normal and are ideal for printing documents that are mostly text.
- **Use High Yield cartridges.** Inks in High-Yield cartridges allow you to print more pages with fewer cartridges.

- **Clean the printhead.** Before replacing and recycling your ink cartridges, try using the “Clean Printhead” and “Deep Clean Printhead” features. These features clean the printhead nozzles to improve the quality of your prints.



Recycling

- **Return ink cartridges for reuse or recycling through the Lexmark Cartridge Collection Program.** To return an ink cartridge, go to www.lexmark.com/recycle. Follow the instructions to request a postage-paid bag.
- **Recycle the product packaging.**
- **Recycle your old printer instead of throwing it away.**
- **Recycle paper from discarded print jobs.**
- **Use recycled paper.**

To read the Lexmark Environmental Sustainability Report, see www.lexmark.com/environment.

Finding information about the printer

Publications

What are you looking for?	Find it here
<p>Initial setup instructions:</p> <ul style="list-style-type: none"> • Connecting the printer • Installing the printer software 	<p>Setup documentation</p> <p>The setup documentation came with the printer and is also available on the Lexmark Web site at www.lexmark.com/publications/.</p> 
<p>Additional setup and instructions for using the printer:</p> <ul style="list-style-type: none"> • Selecting and storing paper and specialty media • Loading paper • Performing printing, copying, scanning, and faxing tasks, depending on your printer model • Configuring printer settings • Viewing and printing documents and photos • Setting up and using printer software • Setting up and configuring the printer on a network, depending on your printer model • Caring for and maintaining the printer • Troubleshooting and solving problems 	<p><i>User's Guide</i></p> <p>The <i>User's Guide</i> is available on the installation software CD.</p>  <p>For updates, check our Web site at www.lexmark.com/publications/.</p>

What are you looking for?	Find it here
<p>Help using the printer software</p>	<p>Windows or Mac Help</p> <p>Open a printer software program or application, and then click Help.</p> <p>Click  to view context-sensitive information.</p> <p>Notes:</p> <ul style="list-style-type: none"> • The Help installs automatically with the printer software. • The printer software is located in the printer Program folder or on the desktop, depending on your operating system.
<p>The latest supplemental information, updates, and online technical support:</p> <ul style="list-style-type: none"> • Troubleshooting hints and tips • Frequently asked questions • Documentation • Driver downloads • Live chat support • E-mail support 	<p>Lexmark Support Web site—support.lexmark.com</p> <p>Note: Select your region, and then select your product to view the appropriate support site.</p> <p>Record the following information (located on the store receipt and the back of the printer), and have it ready when you contact support so that they may serve you faster:</p> <ul style="list-style-type: none"> • Machine Type number • Serial number • Date purchased • Store where purchased
<p>Telephone support</p>	<p>In the US, call us at:</p> <p>1-800-332-4120</p> <p>Monday–Friday (8:00 AM–11:00 PM ET), Saturday (Noon–6:00 PM ET)</p> <p>Support telephone numbers and hours of operation for your region or country can be found on the Support Web site (support.lexmark.com) or on the printed warranty that came with your printer.</p>
<p>Warranty information</p>	<p>Warranty information varies by country or region:</p> <ul style="list-style-type: none"> • In the US—See the Statement of Limited Warranty included with this printer, or at support.lexmark.com. • Rest of the world—See the printed warranty that came with your printer.

Understanding the parts of the printer

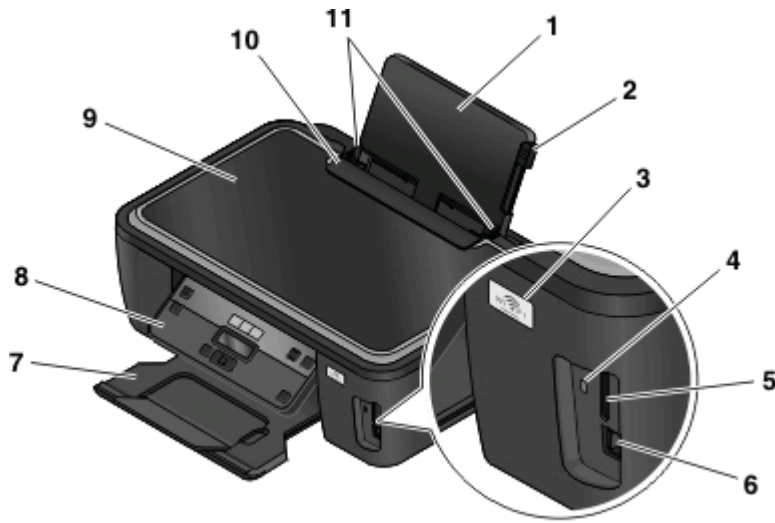

	Use the	To
1	Paper support	Load paper.
2	Paper guide adjustment lever	Adjust the paper guides.
3	Wi-Fi indicator	Check wireless status.
4	Card reader light	Check card reader status. The light blinks to indicate that a memory card is being accessed.
5	Memory card slots	Insert a memory card.
6	PictBridge and USB port	Connect a PictBridge-enabled digital camera, USB Bluetooth adapter or a flash drive to the printer.
7	Paper exit tray	Hold paper as it exits.
8	Printer control panel	Operate the printer.
9	Scanner lid	Access the scanner glass.
10	Paper feed guard	Prevent items from falling into the paper slot.
11	Paper guides	Keep paper straight when feeding.



	Use the	To
1	Scanner glass	Scan and copy photos and documents.
2	Power supply with port	Connect the printer to a power source.
3	USB port	Connect the printer to a computer using a USB cable. Warning—Potential Damage: Do not touch the USB port except when plugging in or removing a USB cable or installation cable.
4	Printhead access	Install the printhead. Note: The carrier moves to the printhead access area when no printhead is installed in the printer.
5	Ink cartridge access	Install, replace, or remove ink cartridges.
6	Scanner unit	<ul style="list-style-type: none"> • Access the ink cartridges and printhead. • Remove paper jams.

Ordering and replacing supplies

Ordering ink cartridges

Page yields available at www.lexmark.com/pageyields. For best results, use only Lexmark ink cartridges.

Lexmark S300 Series models (except Lexmark S308)

Item	Return Program Cartridge ¹	Regular cartridge ²
Black cartridge	100	100A
High yield black cartridge	100XL	100XLA
Yellow color cartridge	100	100A
High yield yellow color cartridge	100XL	100XLA
Cyan color cartridge	100	100A
High yield cyan color cartridge	100XL	100XLA
Magenta color cartridge	100	100A
High yield magenta color cartridge	100XL	100XLA

¹ Licensed for a single use only. After use, return this cartridge to Lexmark for remanufacturing, refilling, or recycling.
² Available only on the Lexmark Web site at www.lexmark.com.

Lexmark S308 models

Item	Return Program Cartridge ¹	Regular cartridge ²
Black cartridge	108	108A
High yield black cartridge	108XL	108XLA
Yellow color cartridge	108	108A
High yield yellow color cartridge	108XL	108XLA
Cyan color cartridge	108	108A
High yield cyan color cartridge	108XL	108XLA
Magenta color cartridge	108	108A
High yield magenta color cartridge	108XL	108XLA

¹ Licensed for a single use only. After use, return this cartridge to Lexmark for remanufacturing, refilling, or recycling.
² Available only on the Lexmark Web site at www.lexmark.com.

Using genuine Lexmark ink cartridges

Lexmark printers, ink cartridges, and photo paper are designed to perform together for superior print quality, and our inks are formulated to work with your printer and help extend the life of your product. We recommend that you use only genuine Lexmark ink cartridges.

Lexmark's warranty does not cover damage caused by non-Lexmark ink or ink cartridges.

Replacing ink cartridges

Make sure you have a new ink cartridge or cartridges before you begin. You must install new cartridges immediately after removing the old ones or the ink remaining in the printhead nozzles may dry out.

- 1 Turn on your printer.
- 2 Open the printer.



Note: The printhead moves to the cartridge installation position.

- 3 Press the release tab, and then remove the used ink cartridge or cartridges.

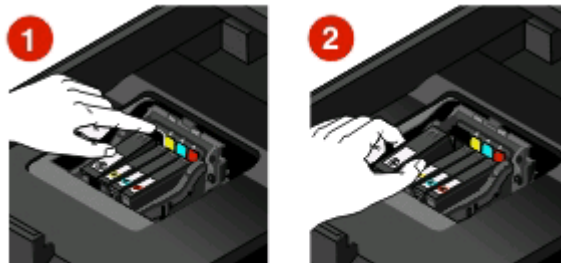

- 4 Install each ink cartridge. Use two hands to install the black cartridge.

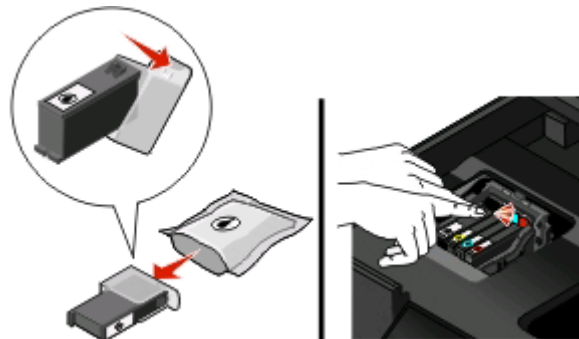

Note: Install the new ink cartridges immediately after removing the protective cap to avoid exposing the ink to air.

- 5 Close the printer.

Ordering paper and other supplies

To order supplies or to locate a dealer near you, visit our Web site at www.lexmark.com.

Item	Part Number
USB cable	1021294
For more information, go to www.lexmark.com .	

Paper	Paper size
Lexmark Photo Paper	<ul style="list-style-type: none">• Letter• A4• 4 x 6 in.• L
Lexmark PerfectFinish Photo Paper	<ul style="list-style-type: none">• Letter• A4• 4 x 6 in.• L
Notes: <ul style="list-style-type: none">• Availability may vary by country or region.• For best results when printing photos or other high-quality images, use Lexmark Photo Paper or Lexmark PerfectFinish™ Photo Paper.• For more information, go to www.lexmark.com	

Recycling Lexmark products

To return Lexmark products to Lexmark for recycling:







- 1 Visit our Web site at www.lexmark.com/recycle.
- 2 Find the product type you want to recycle, and then select your country from the list.
- 3 Follow the instructions on the computer screen.

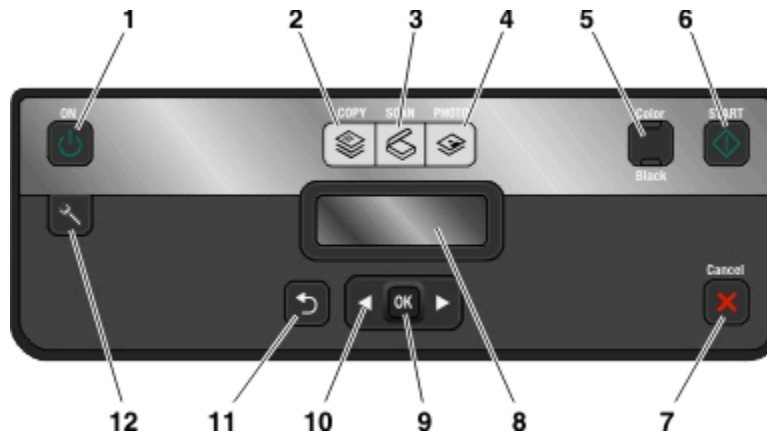



Using the printer control panel buttons and menus

Using the printer control panel

The following diagrams explain the sections of the printer control panel:



	Use the:	To
1	Power button 	<ul style="list-style-type: none"> Turn the printer on and off. Switch to Power Saver mode. <p>Note: When the printer is on, press  to switch to Power Saver mode. Press and hold  for three seconds to turn off the printer.</p>
2	Copy button 	Access the copy menu and make copies.
3	Scan button 	Access the scan menu and scan documents.
4	Photo button 	Access the photo menu and print photos.
5	Color/Black	Switch to color mode or black-and-white mode.
6	Start button 	Start a print, scan, or copy job, depending on which mode is selected.

	Use the:	To
7	Cancel button 	<ul style="list-style-type: none"> • Cancel a print, copy, or scan job in progress. • Exit from a menu level of the Copy, Scan, Photo, or File Print menu to the top level of a menu. • Exit from a menu level of the Setup menu to the top level of the previous mode. • Clear current settings or error messages, and return to default settings.
8	Display Note: The display is turned off in Power Saver mode.	View: <ul style="list-style-type: none"> • Printer status • Messages • Menus
9	Select button 	<ul style="list-style-type: none"> • Select menu options. • Save settings. • Feed or eject paper. Press and hold for 3 seconds to feed or eject paper from the printer.
10	Arrow buttons	<ul style="list-style-type: none"> • Choose a menu or submenu item that appears on the display.
11	Back button 	<ul style="list-style-type: none"> • Return to the previous screen. • Exit from one menu level to a higher one.
12	Setup button 	Access the setup menu and change printer settings. Note: The Copy, Scan and Photo button lights are off when this button is selected.





Changing temporary settings into new default settings

The following menus revert to default settings after two minutes of inactivity or after the printer is turned off:

Copy menu	<ul style="list-style-type: none"> • Copies • Quality • Lighter/Darker • Resize • Original Size • Pages per Sheet • Copies per Sheet • Content Type
Scan menu	<ul style="list-style-type: none"> • Quality • Original Size
Fax menu (selected models only)	<ul style="list-style-type: none"> • Lighter/Darker • Quality





Photo menu	<p>The following Photo options will not time out after two minutes of inactivity or after you turn off the printer, but they will return to the factory default settings when a memory card or flash drive is removed.</p> <ul style="list-style-type: none"> • Photo Effects • Photo Size • Layout • Quality
------------	---

To change the temporary settings into new default settings

- 1 From the printer control panel, press .
- 2 Press the arrow buttons to scroll to **Defaults**, and then press .
- 3 Press the arrow buttons to scroll to **Set Defaults**, and then press . **Use Current** appears on the display.
- 4 Press  again to select **Use Current**.
- 5 Press  until you exit Setup, or press another mode button.





To disable the settings timeout feature

You can disable the settings timeout feature if you do not want the printer to revert to the default settings after two minutes of inactivity or after the printer is turned off.

- 1 From the printer control panel, press .
- 2 Press the arrow buttons to scroll to **Device Setup**, and then press .
- 3 Press the arrow buttons to scroll to **Clear Settings Timeout**, and then press .
- 4 Press the arrow buttons to scroll to **Never**, and then press .
- 5 Press  until you exit Setup, or press another mode button.

Changing the Power Saver timeout

The Power Saver timeout is the time it takes for the printer to switch to Power Saver mode when the printer is left idle. The Power Saver feature optimizes energy efficiency by reducing the printer power consumption (as much as 28 percent on some printer models) compared to the default printer settings. To save the most energy, select the lowest Power Saver timeout.

- 1 From the printer control panel, press .
- 2 Press the arrow buttons to scroll to **Device Setup**, and then press .
- 3 Press the arrow buttons to scroll to **Power Saver**, and then press .
- 4 Press the arrow buttons to select a Power Saver timeout, and then press .
- 5 Press  until you exit Setup, or press another mode button.

Saving energy with Eco-Mode

The Eco-Mode feature optimizes energy efficiency and saves money.





When Eco-Mode is enabled, the printer automatically switches to the following settings:

- The printer display is dimmed.
- The printer changes to Power Saver mode after ten minutes.

Notes:

- If you are using Eco-Mode, then the Eco-Mode settings override any changes you may make to individual settings that are part of Eco-Mode.
- Eco-Mode is enabled by default.





To change the Eco-Mode setting:

- 1 From the printer control panel, press .
- 2 Press the arrow buttons to scroll to **Device Setup**, and then press .
- 3 Press the arrow buttons to scroll to **Eco-Mode**.
- 4 Select the Eco-Mode setting, and then press .
- 5 Press  until you exit Setup, or press another mode button.

Resetting to factory settings

Resetting to factory default settings will delete all the printer settings you have previously selected.

Using the printer control panel menus



- 1 From the printer control panel, press .
- 2 Press the arrow buttons to scroll to **Defaults**, and then press .
- 3 Press the arrow buttons to scroll to **Set Defaults**, and then press .
- 4 Press the arrow buttons to scroll to **Use Factory**, and then press .
- 5 When prompted to set the initial settings of your printer, make your selections using the printer control panel buttons.
Initial Setup Complete appears on the display.

Using a button combination (if you cannot read the current language)

1 Turn off the printer.

Note: If you have set the Power Saver timeout in the Setup menu, then press and hold  for three seconds to turn off the printer.

2 From the printer control panel, press and hold  and  and then press and release  to turn the printer on.

Note: Do not release  and  until **Language** appears on the display, indicating that the printer has been reset.

3 When prompted to set the initial settings of your printer, make your selections using the printer control panel buttons.

Initial Setup Complete appears on the display.

Using the printer software

Minimum system requirements

The printer software requires up to 500 MB of free disk space.

Supported operating systems

- Microsoft Windows 7 (Web only)¹
- Microsoft Windows Vista (SP1)
- Microsoft Windows XP (SP3)
- Microsoft Windows 2000 (SP4 or greater)
- Macintosh PowerPC OS X v10.3.9 or later
- Macintosh Intel OS X v10.4.4 or later
- Linux Ubuntu 8.04 LTS and 8.10 (Web only)¹
- Linux OpenSUSE 11.0 and 11.1 (Web only)¹
- Linux Fedora 10 (Web only)¹

¹ The printer driver for this operating system is available only at support.lexmark.com.

Using the Windows printer software

Software installed during printer installation

When you set up the printer using the installation software CD, all the necessary software was installed. You may have chosen to install some additional programs. The following table provides an overview of various software programs and what they can help you do.

If you did not install these additional programs during initial installation, then reinsert the installation software CD, run the installation software, and then select **Install Additional Software** from the Software Already Installed screen.

Printer software

Use the	To
Lexmark™ Printer Home (referred to as Printer Home)	<ul style="list-style-type: none"> • Launch applications or programs. • Access the Fax Solutions software. • Scan or e-mail a photo or document. • Edit scanned documents. • Scan documents to PDF. • Adjust settings for the printer. • Order supplies. • Maintain ink cartridges. • Print a test page. • Register the printer. • Contact technical support.
Lexmark Fast Pics (referred to as Fast Pics)	Manage, edit, transfer, and print photos and documents.
Lexmark Toolbar (referred to as Toolbar)	<ul style="list-style-type: none"> • Print black or text-only Web pages to save ink. • Schedule automatic printing of Web pages. • Access Picnik and edit photos online. • Print, scan, or convert local files from Windows.
Lexmark Tools for Office (referred to as Tools for Office)	Access your favorite settings in Microsoft Office 2007.
Lexmark Fax Solutions (referred to as Fax Solutions)	<ul style="list-style-type: none"> • Send a fax. • Receive a fax in three-in-one printers. • Add, edit, or delete contacts in the built-in phone book. • Access the Lexmark Fax Setup Utility in four-in-one printers. Use the Fax Setup Utility to set the Speed Dial and Group Dial numbers, set Ringing and Answering, and print fax history and status reports.
Abbyy Sprint OCR	Scan a document and produce text that you can edit with a word-processing program.
Lexmark Wireless Setup Utility (referred to as Wireless Setup Utility)	<ul style="list-style-type: none"> • Set up the wireless printer on a wireless network. • Change the wireless settings of the printer. <p>Note: This program is installed automatically with the printer software if the printer has wireless capability.</p>
Lexmark Service Center (referred to as Service Center)	<ul style="list-style-type: none"> • Troubleshoot the printer. • Access the printer maintenance functions. • Contact technical support. <p>Notes:</p> <ul style="list-style-type: none"> • This program is installed automatically with the printer software. • You may be prompted to install this program from the Web, depending on your printer model.

Use the	To
Printing Preferences	<p>When you select File → Print with a document open and then click Properties, a Printing Preferences dialog appears. The dialog lets you select options for the print job, such as the following:</p> <ul style="list-style-type: none"> • Select the number of copies to print. • Print two-sided copies. • Select the paper type. • Add a watermark. • Enhance images. • Save settings. <p>Note: Printing Preferences is installed automatically with the printer software.</p>

Note: Your printer may not come with some of these programs or some of the functions of these programs, depending on the features of the printer that you purchased.

Using the Macintosh printer software

Software installed during printer installation

Software resident in the Macintosh OS

Use the	To
Print dialog	Adjust the print settings and schedule print jobs.
Printer Services dialog (not available in Mac OS X v10.5 or later)	<ul style="list-style-type: none"> • Access the printer utility. • Troubleshoot. • Order ink or supplies. • Contact Lexmark. • Check the printer software version installed on the computer.

Printer software

Applications are installed along with the printer software during installation. These applications are saved in the printer folder that appears on the Finder desktop after installation.

- 1 From the Finder desktop, double-click the printer folder.
- 2 Double-click the icon of the application that you want to use.

Use the	To
Lexmark All-In-One Center (referred to as All-In-One Center)	<ul style="list-style-type: none"> • Scan photos and documents. • Customize settings for scan jobs.
Lexmark Fax Setup Utility (referred to as Fax Setup Utility)	<ul style="list-style-type: none"> • Customize settings for fax jobs. • Create and edit the Speed Dial list.

Use the	To
Lexmark Network Card Reader (referred to as Network Card Reader)	<ul style="list-style-type: none"> • View the contents of a memory device inserted into a network printer. • Transfer photos and PDF documents from a memory device to the computer over a network.
Lexmark Printer Utility (referred to as Printer Utility)	<ul style="list-style-type: none"> • Get help with cartridge installation. • Print a test page. • Print an alignment page. • Clean the printhead nozzles. • Order ink or supplies. • Register the printer. • Contact technical support.
Lexmark Wireless Setup Assistant (referred to as Wireless Setup Assistant)	Set up the printer on a wireless network.

Note: Your printer may not come with these applications, depending on the features of the printer that you purchased.

Finding and installing optional software

For Windows users

- 1 Click  or Start.
- 2 Click **All Programs** or **Programs**, and then select the printer program folder from the list.
- 3 Select **Printer Home**.
- 4 Choose your printer from the printer drop-down list.
- 5 From the Support tab, click **On-line support**.
- 6 From the Web site, select your printer and download the driver.
- 7 Install additional or optional software.

For Macintosh users

- 1 From the Finder desktop, double-click the printer folder.
- 2 Double-click the **Printer Utility** icon.
- 3 From the Web Links tab, click **Customer Support**.
- 4 From the Web site, select your printer and download the driver.
- 5 Install additional or optional software.

Updating the printer software (Windows only)

Checking for software updates

- 1 Click  or **Start**.
- 2 Click **All Programs** or **Programs**, and then select the printer program folder from the list.
- 3 Select **Printer Home**.
- 4 Choose your printer from the printer drop-down list.
- 5 From the Support tab, select **Check for updates**.
- 6 Follow the instructions on the computer screen.

Enabling automatic software updates

- 1 With a document open, click **File → Print**.
- 2 Click **Properties, Preferences, Options, or Setup**.
- 3 From the Advanced tab, click **More Options**.
- 4 In the Software Updates section, select **Allow automatic updates from the web for my software**.
- 5 Click **OK**.

Reinstalling the printer software

When you set up the printer using the installation software CD, all the necessary software was installed. If you encountered problems while installing, or if your printer does not appear in the Printers folder or as a printer option when you send a print job, then try removing and reinstalling the printer software.

Uninstalling the printer software

For Windows users

- 1 Click  or **Start**.
- 2 Click **All Programs** or **Programs**, and then select the printer program folder from the list.
- 3 Select the uninstall option.
- 4 Follow the instructions on the computer screen to remove the software.
- 5 Once the uninstall process is complete, restart your computer.

For Macintosh users

- 1 From the Finder desktop, double-click the printer folder.
- 2 Double-click the **Uninstaller** icon.
- 3 Follow the instructions on the computer screen to remove the software.

Installing the printer software

Note: If you installed the printer software on this computer before but need to reinstall the software, then uninstall the current software first.

For Windows users

- 1 Close all open software programs.
- 2 Insert the installation software CD.
If the Welcome screen does not appear after a minute, then launch the CD manually:
 - a Click , or click **Start** and then click **Run**.
 - b In the Start Search or Run box, type `D:\setup.exe`, where **D** is the letter of your CD or DVD drive.
- 3 Follow the instructions on the Welcome screen.

For Macintosh users

- 1 Close all open software applications.
- 2 Insert the installation software CD.
If the installation dialog does not appear after a minute, then click the CD icon on the desktop.
- 3 Double-click **Install**.
- 4 Follow the instructions on the installation dialog.

Using the World Wide Web

- 1 Go to the Lexmark Web site at www.lexmark.com.
- 2 From the Drivers & Downloads menu, click **Driver Finder**.
- 3 Select your printer, and then select your operating system.
- 4 Download the driver and install the printer software.

Loading paper and original documents

Loading paper

- 1 Fan the paper.



- 2 Center the paper on the paper support.
- 3 Adjust the paper guides so they rest against the edges of the paper.





Note: Do not force paper into the printer. The paper should be flat against the paper support, and the edges should be flush against both paper guides.

- 4 From the printer control panel, select or confirm your paper settings.

Paper and specialty media guidelines

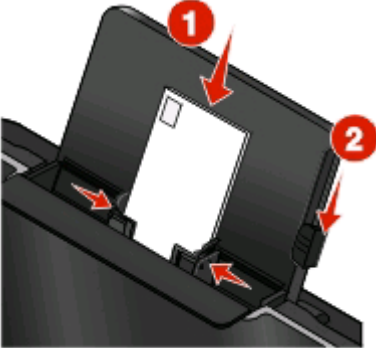
Load up to:	Make sure that:
100 sheets of plain paper 	<ul style="list-style-type: none">• The paper guides rest against the edges of the paper.• You load letterhead paper with the print side faceup and the top of the letterhead going into the printer first.



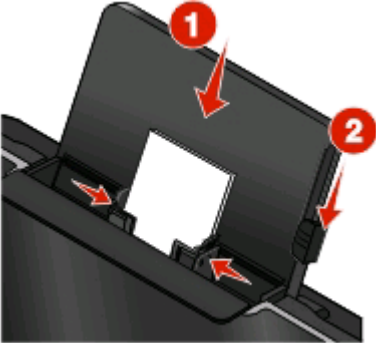



Load up to:	Make sure that:
25 sheets of heavyweight matte paper	<ul style="list-style-type: none"> The print side of the paper is faceup. The paper guides rest against the edges of the paper. You select Automatic, Normal, or Photo print quality. <p>Note: Draft mode is available but is not recommended for use with expensive paper such as heavyweight matte, labels, photo cards and glossy paper.</p>
20 sheets of banner paper 	<ul style="list-style-type: none"> You remove all paper from the paper support before inserting banner paper. You use banner paper designed for inkjet printers. You place a stack of banner paper on or behind the printer, and feed in the first sheet. The paper guides rest against the edges of the paper. You select A4 Banner or Letter Banner paper size.
10 envelopes 	<ul style="list-style-type: none"> The print side of the envelope is faceup. The paper guides rest against the edges of the envelopes. You print the envelopes with Landscape orientation. <p>Note: If you are mailing within Japan, then the envelope can be printed in Portrait orientation with the stamp in the lower right corner or in Landscape orientation with the stamp in the lower left corner. If you are mailing internationally, then print in Landscape orientation with the stamp in the upper left corner.</p>  <ul style="list-style-type: none"> You select the correct envelope size. Select the next biggest size if the exact envelope size is not listed, and set the left and right margins so your envelope is correctly positioned.
25 sheets of labels	<ul style="list-style-type: none"> The print side of the label is faceup. The paper guides rest against the edges of the paper. You select Automatic, Normal, or Photo print quality. <p>Note: Draft mode is available but is not recommended for use with expensive paper such as heavyweight matte, labels, photo cards and glossy paper.</p>

Load up to:	Make sure that:
25 greeting cards, index cards, postcards, or photo cards 	<ul style="list-style-type: none"> The print side of the card is faceup. The paper guides rest against the edges of the cards. You select Automatic, Normal, or Photo print quality. <p>Note: Draft mode is available but is not recommended for use with expensive paper such as heavyweight matte, labels, photo cards and glossy paper.</p>
25 sheets of photo/glossy paper	<ul style="list-style-type: none"> The print side of the paper is faceup. The paper guides rest against the edges of the paper. You select Automatic, Normal, or Photo print quality. <p>Note: Draft mode is available but is not recommended for use with expensive paper such as heavyweight matte, labels, photo cards and glossy paper.</p>
10 iron-on transfers	<ul style="list-style-type: none"> You follow the loading instructions on the iron-on transfer packaging. The print side of the transfer is faceup. The paper guides rest against the edges of the transfer. You select Automatic, Normal, or Photo print quality.
50 transparencies	<ul style="list-style-type: none"> The rough side of the transparencies is faceup. The paper guides rest against the edges of the transparencies.

Saving paper default settings

You can set the default paper size, paper type, and photo print size for the documents and photos that you print.

Note: These default settings apply only to print, copy, and scan jobs that you initiate from the printer.

- 1 From the printer control panel, press .
- 2 Choose the default settings:
 - If you want to set the default paper size:
 - a Press  to select **Paper Setup**.
 - b Press the arrow buttons to scroll to **Paper Size**, and then press .
 - c Press the arrow buttons to select the default paper size for the printer, and then press .
 - If you want to set the default paper type:
 - a Press  to select **Paper Setup**.
 - b Press the arrow buttons to scroll to **Paper Type**, and then press .
 - c Press the arrow buttons to select the default paper type for the printer, and then press .

- If you want to set the default photo print size:
 - a Press the arrow buttons to scroll to **Defaults**, and then press **OK**.
 - b Press **OK** to select **Photo Print Size**.
 - c Press the arrow buttons to select the default photo print size for the printer, and then press **OK**.

3 Press **⏪** until you exit Setup, or press another mode button.

Loading original documents on the scanner glass

- 1 Open the scanner lid and place the document facedown on the scanner glass.
- 2 Close the scanner lid.



Printing

Tips for printing

- Use the appropriate paper for your print job.
- Select a higher print quality for better prints.
- Make sure there is enough ink in the ink cartridges.
- Remove each sheet as it is printed when printing photos or when working with specialty media.
- Select the borderless setting when printing photos.

Printing basic documents

Printing a document

- 1 Load the paper in the printer.
- 2 Send the print job:

For Windows users

- a With a document open, click **File → Print**.
- b Click **Properties, Preferences, Options, or Setup**.
- c Select the print quality, the number of copies to print, the type of paper to use, and how the pages should print.
- d Click **OK** to close any printer software dialogs.
- e Click **OK** or **Print**.

For Macintosh users

- a With a document open, choose **File > Print**.
- b From the Printer pop-up menu, choose the printer.
- c If necessary, click the disclosure triangle.
- d From the print options pop-up menu, choose the print quality, the number of copies to print, the type of paper to use, and how the pages should print.
- e Click **Print**.

Collating printed copies

If you print multiple copies of a document, then you can choose to print each copy as a set (collated) or to print the copies as groups of pages (not collated).

Collated



Not collated



Notes:

- The collate option is available only when you are printing multiple copies.
- To prevent smudging when printing photos, remove each photo as it exits the printer, and then let it dry before stacking.

For Windows users

- 1 With a document open, click **File → Print**.
- 2 Click **Properties, Preferences, Options, or Setup**.
- 3 From the Copies section of the Print Setup tab, enter the number of copies that you want to print, and then select **Collate Copies**.
- 4 Click **OK** to close any printer software dialogs.
- 5 Click **OK** or **Print**.

For Macintosh users

- 1 With a document open, choose **File > Print**.
- 2 From the Printer pop-up menu, choose the printer.
- 3 If necessary click the disclosure triangle.
- 4 In the Copies field, enter the number of copies that you want to print, and then select **Collated**.
- 5 Click **Print**.

Printing pages in reverse order

By default, the first page is printed first. If you want to reverse the order in which pages print to make documents ready to read with the first page on top, then do the following:

For Windows users

- 1 With a document open, click **File → Print**.
- 2 Click **Properties, Preferences, Options, or Setup**.

- 3 From the Copies section of the Print Setup tab, select a page order:
 - To print the last page first, select **Print Last Page First**.
 - To print the first page first, clear the **Print Last Page First** check box.

Note: If two-sided printing is enabled, then you cannot print the last page first. To change the print order, you must first disable two-sided printing.
- 4 Click **OK** to close any printer software dialogs.
- 5 Click **OK** or **Print**.

For Macintosh users

- 1 With a document open, choose **File > Print**.
- 2 From the Printer pop-up menu, choose the printer.
- 3 If necessary, click the disclosure triangle.
- 4 From the print options pop-up menu, choose **Paper Handling**.
- 5 From the Paper Handling menu, or from the Page Order pop-up menu, select a page order:
 - To print the last page first, select **Reverse page order** or **Reverse**.
 - To print the first page first, clear the **Reverse page order** or **Reverse** option.
- 6 Click **Print**.

Printing multiple pages on one sheet

For Windows users

- 1 With a document open, click **File → Print**.
- 2 Click **Properties, Preferences, Options, or Setup**.
- 3 From the Layout list of the Advanced tab, select **Pages per sheet**.
- 4 Select the number of page images to print on each page.

If you want each page image to be surrounded by a border, then select **Print Page Borders**.
- 5 Click **OK** to close any printer software dialogs.
- 6 Click **OK** or **Print**.

For Macintosh users

- 1 With a document open, choose **File > Print**.
- 2 From the Printer pop-up menu, choose the printer.
- 3 If necessary, click the disclosure triangle.
- 4 From the print options pop-up menu, choose **Copies & Pages**, and then click **Page Setup**.
- 5 From the Paper Size pop-up menu, choose a paper size.
- 6 Choose an orientation, and then click **OK**.

7 From the print options pop-up menu, choose **Layout**.

- From the Pages per Sheet pop-up menu, choose the number of page images that you want to print on one sheet.
- From the Layout Direction menu, choose a layout direction.
- If you want to print a border around each page image, then choose an option from the Border pop-up menu.

8 Click **Print**.

Printing documents from a memory card or flash drive (Windows only)

To enable the File Print function:

- The printer must be connected to a computer through a USB cable or through a network.
- The printer and the computer must be on.
- The memory card or flash drive must contain document files that are supported by the printer. For more information, see “Supported memory cards and file types” on page 38.
- The computer must contain applications that support the file types in the memory device.

1 Insert a memory card or flash drive.

When the printer detects the memory device, **Memory Card Detected** or **Storage Device Detected** appears on the display.

2 If only document files are stored on the memory device, then the printer automatically switches to File Print mode. If document files and image files are stored on the memory device, then press **OK** to select **Documents**.

3 Select and print the document:

If the printer is using a USB connection

- a** Press the arrow buttons to select the file name of the document that you want to print or the folder where the document is saved in the memory device.
- b** Press **OK**, and then press **⏏** to start printing the document.

If the printer is using a Wireless connection (selected models only)

- a** Press the arrow buttons to select the file name of the document that you want to print.
- b** Press **OK**, and then wait for the printer to connect to the network computer or to finish searching the network for available computers.
- c** When prompted, press the arrow buttons to select the name of the network computer, and then press **OK** to start printing the document.

Notes:

- You may be prompted to enter a PIN if the computer requires it. Press the arrow buttons to enter the PIN. Press **OK** each time you enter a number.
- To assign a computer name and a PIN to the computer, see the Help for the printer software associated with your operating system.

Printing specialty documents

Printing envelopes

- 1 Load the envelopes in the printer.
- 2 Send the print job:

For Windows users

- a With a document open, click **File → Print**.
- b Click **Properties, Preferences, Options, or Setup**.
- c From the Paper Type list of the Print Setup tab, select **Plain Paper**.
- d From the Paper Size list, select the envelope size.

Note: To print on a custom-size envelope, select **Custom Size**, and then specify the height and width of the envelope.

- e Select an orientation.
- f Click **OK** to close any printer software dialogs.
- g Click **OK** or **Print**.

For Macintosh users

- a With a document open, choose **File > Print**.
- b From the Printer pop-up menu, choose the printer.
- c If necessary, click the disclosure triangle.
- d From the print options pop-up menu, choose **Copies & Pages**, and then click **Page Setup**.
- e From the Paper Size pop-up menu, choose the envelope size. If no size matches the size of the envelope, then set a custom size.
- f Select an orientation, and then click **OK**.
- g Click **Print**.

Notes:

- Most envelopes use landscape orientation.
- Make sure the same orientation is also selected in the software application.

Printing labels

- 1 Load the label sheets in the printer.
- 2 Send the print job:

For Windows users

- a With a document open, click **File → Print**.
- b Click **Properties, Preferences, Options, or Setup**.

- c** From the Paper Size list of the Print Setup tab, choose a paper size that matches the size of the label sheet. If no paper size matches the label sheet size, then set a custom size.
If necessary, choose the appropriate type of paper from the Paper Type list.
- d** Click **OK** to close any printer software dialogs.
- e** Click **OK** or **Print**.

For Macintosh users

- a** With a document open, choose **File > Print**.
- b** From the Printer pop-up menu, choose the printer.
- c** If necessary, click the disclosure triangle.
- d** From the print options pop-up menu, choose **Copies & Pages**, and then click **Page Setup**.
- e** From the Paper Size pop-up menu, choose a size that matches the size of the label sheet. If no paper size matches the label sheet size, then set a custom size.
- f** Select an orientation, and then click **OK**.
- g** From the print options pop-up menu, choose **Quality & Media**.
 - From the Paper Type pop-up menu, choose **Card Stock**.
 - From the Print Quality menu, choose a print quality other than Quick Print.
- h** Click **Print**.

Tips on loading label sheets

- Make sure the top of the label sheet feeds into the printer first.
- Make sure the adhesive on the labels does not extend to within 1 mm of the edge of the label sheet.
- Make sure the paper guide or paper guides rest against the edges of the label sheet.
- Use full label sheets. Partial sheets (with areas exposed by missing labels) may cause labels to peel off during printing, resulting in a paper jam.

Printing on custom-size paper

Before beginning these instructions, load the custom-size paper in the printer.

For Windows users

- 1** With a document open, click **File → Print**.
- 2** Click **Properties, Preferences, Options, or Setup**.
- 3** From the Paper Size list of the Print Setup tab, select **Custom Size**.
The Define Custom Paper Size dialog appears.
- 4** Set the paper size.
- 5** Select the measurement units to use (inches or millimeters).
- 6** Click **OK** to close any printer software dialogs.
- 7** Click **OK** or **Print**.

For Macintosh users

- 1 With a document open, choose **File > Print**.
- 2 From the printer pop-up menu, choose the printer.
- 3 If necessary, click the disclosure triangle.
- 4 From the print options pop-up menu, choose **Copies & Pages** and then click **Page Setup**.
- 5 From the Settings pop-up menu, choose **Custom Paper Size**.
- 6 Create a custom size:
 - a Select **Use custom page size**.
 - b Type the Width and Height of the paper.
 - c Choose a Feed Method.
 - d Click **OK**.
- 7 Click **Print**.

Printing on both sides of the paper (duplexing) manually

For Windows users

- 1 With a document open, click **File → Print**.
- 2 Click **Properties, Preferences, Options, or Setup**.
- 3 Click the **Advanced** tab.
- 4 From the 2-Sided Printing section, select **Manual**.

Note: The Print Instruction Page to Assist in Reloading item is selected automatically.
- 5 Click **OK**. The printer prints the odd-numbered pages and the instruction sheet.

6 Flip and reload the paper, following the directions on the instruction sheet to complete the print job.

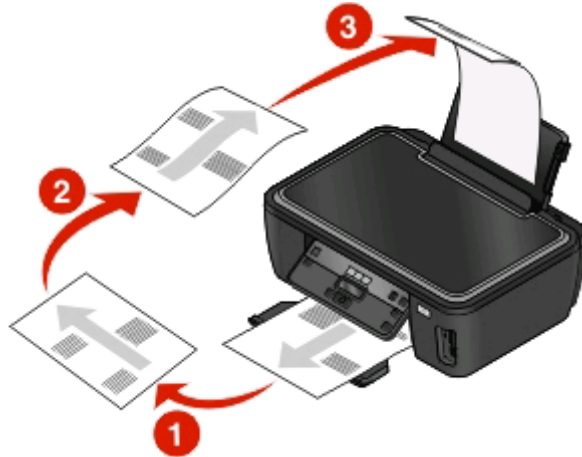

Note: To return to single-sided printing, return to the Advanced tab. From the 2-Sided Printing section, select **Off** from the drop-down menu.

For Macintosh users

- 1 With a document open, choose **File > Print**.
- 2 From the print options pop-up menu, choose **Paper Handling**.
- 3 From the Print or “Pages to print” pop-up menu, select to print the odd numbered pages.
- 4 After printing the first set of pages, flip and reload the paper.

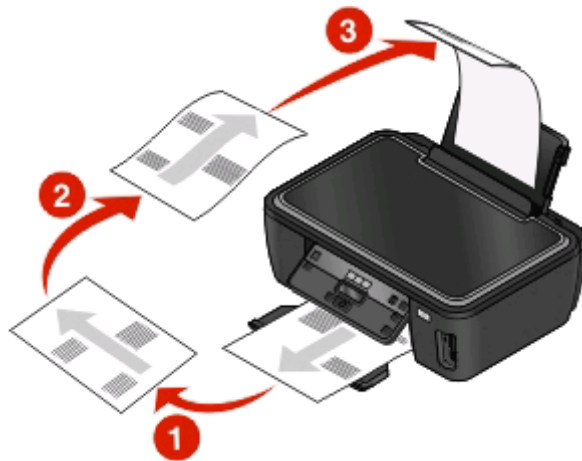

- 5 Repeat steps 1 and 2.
- 6 From the Print or “Pages to print” pop-up menu, select to print the even numbered pages.
- 7 Click **Print**.

Working with photos

Using a memory card or flash drive with the printer

Memory cards and flash drives are storage devices frequently used with cameras and computers. You can remove the memory card from the camera or the flash drive from the computer and insert it directly into the printer.

- 1 Insert a memory card into the card slot or a flash drive into the USB port.

Inserting a memory card



Notes:

- Insert the card with the brand name label facing right.
- Make sure any arrows on the card point toward the printer.
- If necessary, connect the memory card to the adapter that came with it.
- Make sure that the memory card inserted is supported by the printer. For more information, see “Supported memory cards and file types” on page 38.

Inserting a flash drive



Notes:

- The flash drive uses the same port that is used for a PictBridge camera cable.
- An adapter may be necessary if your flash drive does not fit directly into the port.



Warning—Potential Damage: Do not touch any cables, any network adapter, any connector, the memory device, or the printer in the areas shown while actively printing, reading, or writing from the memory device. A loss of data can occur.

- 2 Look for **Memory Card Detected** or **Storage Device Detected** on the display.

Notes:

- If the printer does not recognize the memory device, then remove and reinsert it.
- If a flash drive or a digital camera set to mass storage mode is inserted into the USB port while a memory card is in the card slot, then a message appears on the display prompting you to choose which memory device to use.

Supported memory cards and file types

Memory Card	File Type
<ul style="list-style-type: none"> • Secure Digital (SD) • Micro Secure Digital (with adapter) (Micro SD) • Mini Secure Digital (with adapter) (Mini SD) • MultiMedia Card (MMC) • Reduced Size MultiMedia Card (with adapter) (RS-MMC) • MultiMedia Card mobile (with adapter) (MMCmobile) • Memory Stick • Memory Stick PRO • Memory Stick Duo (with adapter) • Memory Stick PRO Duo (with adapter) • xD-Picture Card • xD-Picture Card (Type H) • xD-Picture Card (Type M) • Secure Digital High Capacity (SDHC) 	<p>Documents:</p> <ul style="list-style-type: none"> • .doc (Microsoft Word) • .xls (Microsoft Excel) • .ppt (Microsoft PowerPoint) • .pdf (Adobe Portable Document Format) • .rtf (Rich Text Format) • .docx (Microsoft Word Open Document Format) • .xlsx (Microsoft Excel Open Document Format) • .pptx (Microsoft PowerPoint Open Document Format) • .wpd (WordPerfect) <p>Images:</p> <ul style="list-style-type: none"> • JPEG • TIFF

Printing photos using the printer control panel



- 1 Load photo paper.
- 2 From the printer control panel, press .
- 3 Insert a memory card, flash drive, or digital camera set to mass storage mode.
If document files and image files are stored in the memory device, then press the arrow buttons to select **Photos**, and then press .
- 4 Press the arrow buttons to scroll to **Easy Photo** or **Print Photos**, and then press .

Notes:

- Select **Easy Photo** if you want to print photos quickly.
- Select **Print Photos** if you want to customize the photos before printing them.

- 5 Press the arrow buttons to select a photo printing option, and then press .

Note: You can choose to print the most recent photo, print all the photos, print photos that fall within a date range, print photos by selecting the photo numbers on a proof sheet, or print pre-selected photos from a digital camera using Digital Print Order Format (DPOF). The DPOF option appears only when there is a valid DPOF file in your memory device.

- 6 Adjust the print settings:
 - If you are in the Easy Photo menu, then press the arrow buttons to select the paper size and photo size. Press  each time you make a selection.
 - If you are in the Print Photos menu, then press the arrow buttons to select the photo size, paper size, paper type, layout, photo effects, and quality of the photos, and to adjust the brightness and color effects of the photos. Press  each time you make a selection.

7 Press the **Color/Black** button to set a color or black-and-white print.

When you select color or black-only printing, the light near your choice comes on.

8 Press .

Note: For best results, allow the prints to dry at least 24 hours before stacking, displaying, or storing.

Printing photos from a memory device using the printer software

1 Load photo paper with the glossy or printable side faceup. (If you are not sure which side is the printable side, then see the instructions that came with the paper.)

2 From the printer control panel, press .

3 Insert a memory card, flash drive, or digital camera set to mass storage mode.

If document files and image files are stored on the memory device, then press  to select **Photos**.

4 Transfer or print the photos:

If the printer is using a USB connection

- **For Windows users**

Fast Pics launches automatically when you insert the memory device. Follow the instructions on the computer screen to transfer the photos to the computer or to print.

- **For Macintosh users**

If you have set an application to launch when a memory device is connected to the computer, then the application automatically launches. Follow the instructions on the computer screen to transfer the photos to the computer or to print.

If the printer is using a Wireless connection (selected models only)

a Press the arrow buttons to scroll to **Select Computer**, and then press .

b Press the arrow buttons to select the network computer where you want to save the photos, and then press .

c Transfer or print the photos:

- **For Windows users**

Fast Pics launches automatically when you insert the memory device. Follow the instructions on the computer screen to transfer the photos to the computer or to print.

- **For Macintosh users**

Select **Yes** to view images from the memory device. The Network Card Reader launches on the computer. Follow the instructions on the computer screen to transfer the photos to the computer or to print.

Printing photos from a PictBridge-enabled digital camera

PictBridge is a technology available in most digital cameras that lets you print directly from your digital camera without using a computer.

1 Insert one end of the USB cable into the camera.

Note: Use only the USB cable that came with the camera.

2 Insert the other end of the cable into the PictBridge port on the front of the printer.



Notes:

- Make sure that the PictBridge-enabled digital camera is set to the correct USB mode. If the camera USB selection is incorrect, then the camera is detected as a flash drive, or an error message will be displayed on the printer control panel. For more information, see the camera documentation.
- The printer reads only one memory device at a time.



Warning—Potential Damage: Do not touch the USB cable, any network adapter, any connector, the memory device, or the printer in the areas shown while actively printing, reading, or writing from the memory device. A loss of data can occur.

3 If the PictBridge connection is successful, then the following message appears on the display: **PictBridge Camera detected. Press OK to change settings.**

4 Press **OK** to access the PictBridge menu.

5 Press the arrow buttons to select the paper size, paper type, photo size, and layout of the photos that you want to print. Press **OK** each time you make a selection.

6 See the documentation for your camera to begin printing.

Note: If you insert the camera while the printer is performing another job, then wait for the job to finish before printing from the camera.

Printing photos from a memory device using the proof sheet

1 Load letter- or A4-size plain paper.

2 From the printer control panel, press .

3 Insert a memory card or flash drive.

If document files and image files are stored in the memory device, then press the arrow buttons to select **Photos**, and then press .

4 Press the arrow buttons to scroll to **Proof Sheet**, and then press .

5 Press the arrow buttons to select an option to print a proof sheet.

You can print a proof sheet:

- For all photos on the memory device.
- For the 20 most recent photos, if there are 20 or more photos on the memory device.
- By date, if the photos on the card were taken on different dates. If you choose this option, then select the date.

6 Press .

The proof sheet prints.

7 Follow the instructions on the proof sheet to select which photos to print, the number of copies per photo, red-eye reduction, page layout, print options, and paper size.

Note: When making selections, make sure to fill in the circles completely.

8 When **Scan Proof Sheet** appears on the display, press , and then load the proof sheet facedown on the scanner glass.

Note: If **Scan Proof Sheet** does not appear on the display, then press the arrow buttons until it appears on the display.

9 Press .

The printer scans the proof sheet.

10 Load photo paper with the glossy or printable side faceup. (If you are not sure which side is the printable side, then see the instructions that came with the paper.)

Note: Make sure that the paper matches the size that you selected on the proof sheet.

11 Press the **Color/Black** button to set a color or black-and-white print.

When you select color or black-only printing, the light near your choice comes on.

12 Press  to print the photos.

Note: For best results, allow the prints to dry at least 24 hours before stacking, displaying, or storing.



Printing photos from a digital camera using DPOF

If your camera supports Digital Print Order Format (DPOF), then you can specify which photos to print, how many of each, and the print settings while the memory card is still in the camera. The printer recognizes these settings when you insert the memory card into the printer or connect the camera to the printer.

Note: If you specify a photo size while the memory card is still in the camera, then make sure that the size of the paper loaded in the printer is not smaller than the size you specify in the DPOF selection.

- 1 Load photo paper with the glossy or printable side faceup. (If you are not sure which side is the printable side, then see the instructions that came with the paper.)
- 2 From the printer control panel, press .
- 3 Insert a memory card.

Memory Card Detected appears on the display.

- 4 Press the arrow buttons to scroll to **Print Photos**, and then press .
- 5 Press the arrow buttons to scroll to **Print DPOF**, and then press  to print the photos.

Note: This option appears only if a DPOF file is detected in the memory card.

Note: For best results, allow the prints to dry at least 24 hours before stacking, displaying, or storing.

Printing from a Bluetooth-enabled device

- This printer is compliant with Bluetooth Specification 2.0. It supports the following profiles: Object Push Profile (OPP) and Serial Port Profile (SPP). Check with your Bluetooth-enabled device manufacturers (cellular phone or PDA) to determine their hardware compatibility and interoperability. It is recommended that you use the latest firmware on your Bluetooth-enabled device.
- To print Microsoft documents from your Windows Mobile/Pocket PC PDA, additional third-party software and drivers are required. For more information about the required software, see the documentation for your PDA.

Setting up a connection between your printer and a Bluetooth-enabled device

Note: The printer does not support printing files from your computer using a Bluetooth connection.

You need to set up a connection between a Bluetooth-enabled device and your printer if you are sending a print job from the Bluetooth device for the first time. You will need to repeat the setup if:

- You reset the printer to its factory default settings.
- You change the Bluetooth security level or the Bluetooth pass key.
- The Bluetooth-enabled device you are using requires users to set up a Bluetooth connection on every print job. For more information, see the documentation for your Bluetooth device.
- The name of the Bluetooth device you are using is automatically deleted from the Bluetooth device list.

When the Bluetooth security level is set to High, the printer saves a list of up to eight Bluetooth devices that have previously set up a connection with the printer. When the printer detects more than eight devices, the least recently used device is removed from the list. You need to repeat the setup of the deleted device to be able to send a print job to the printer.

Note: You need to set up a connection for each Bluetooth device that you use to send a print job to the printer.





To set up a connection between the printer and a Bluetooth-enabled device:

- 1 Insert a USB Bluetooth adapter into the USB port located on the front of the printer.



Bluetooth Dongle Connected appears on the display.

Note: A Bluetooth adapter is not included with the printer.

- 2 From the printer control panel, press .
 - 3 Press the arrow buttons to scroll to **Bluetooth Setup**, and then press .
 - 4 Press the arrow buttons to scroll to **Discovery**, and then press .
 - 5 Make sure **Discovery** is set to **On**. If necessary, press the arrow buttons to scroll to **On**, and then press .
- The printer is now ready to accept a connection from a Bluetooth-enabled device.
- 6 Configure the Bluetooth-enabled device to set up a connection to the printer. For more information, see the documentation for your Bluetooth device.

Note: If the Bluetooth Security Level on the printer is set to High, then you must enter a pass key.





Setting the Bluetooth security level

- 1 Insert a Bluetooth USB adapter into the USB port.



Bluetooth Dongle Connected appears on the display.

Note: A Bluetooth adapter is not included with the printer.

- 2 From the printer control panel, press .
- 3 Press the arrow buttons to scroll to **Bluetooth Setup**, and then press button .
- 4 Press the arrow buttons to scroll to **Security Level**, and then press .
- 5 Press the arrow buttons to select the security level, and then press 
 - Select **Low** to allow Bluetooth devices to connect and send print jobs to your printer without requiring users to enter a pass key.
 - Select **High** to require users to enter a four-digit numeric pass key on the Bluetooth device before connecting and sending print jobs to the printer.
- 6 The Bluetooth Pass Key menu appears on the display if you set the security level to High. Press the arrow buttons to enter the four-digit pass key. Press  each time you enter a number.

Printing from a Bluetooth-enabled device

Note: The printer does not support printing files from your computer using a Bluetooth connection.

- 1 Insert a USB Bluetooth adapter into the USB port.



Bluetooth Dongle Connected appears on the display.

Warning—Potential Damage: Do not touch cables, any network adapter, any connector, the USB Bluetooth adapter, or the printer in the areas shown while actively printing, reading, or writing from a Bluetooth-enabled device. A loss of data can occur.

Notes:

- A Bluetooth adapter is not included with the printer.
 - Your printer automatically switches to Bluetooth mode when you insert a USB Bluetooth adapter.
- 2 Make sure the printer is set up to receive Bluetooth connections. For more information, see “Setting up a connection between your printer and a Bluetooth-enabled device” on page 42.
 - 3 Set up the Bluetooth device to print to the printer. For more information, see the documentation for your Bluetooth device.
 - 4 See the documentation for your Bluetooth device to begin printing.

Note: If the Bluetooth Security Level on the printer is set to High, you must enter a pass key.

Managing print jobs

Setting your printer as the default printer

Your printer should be selected automatically from the Print dialog when you send a print job. If you have to manually select your printer, then it is not the default printer.

To set the default printer:

For Windows users

- 1 Click , or click **Start** and then click **Run**.
- 2 In the Start Search or Run box, type `control printers`.
- 3 Press **Enter**, or click **OK**.
The printer folder opens.
- 4 Right-click the printer, and then select **Set as Default Printer**.

For Macintosh users

- 1 From the Apple menu, choose **System Preferences**.
- 2 Click **Print & Fax**.
- 3 Select the printer from the Default Printer pop-up menu, or select the printer and click **Make Default**, depending on your operating system.

Changing the printing mode

To conserve ink, you can change the default printing mode for all print jobs to Quick Print. It uses less ink and is ideal for printing text-only documents. If you need to change to a different print mode to print photos or other high-quality documents, then you can select a different mode from the Print dialog before sending the print job.

To change the default print mode:

For Windows users

- 1 Click , or click **Start** and then click **Run**.
- 2 In the Start Search or Run box, type `control printers`.
- 3 Press **Enter**, or click **OK**.
The printer folder opens.
- 4 Right-click the printer, and then select **Printing Preferences**.
- 5 Select **Quick Print** as the printing mode.

For Macintosh users

- 1 With a document open, choose **File > Print**.
- 2 From the printer pop-up menu, choose the printer.

- 3 From the print options pop-up menu, choose **Print Settings** or **Quality & Media**, depending on your operating system.
- 4 From the Print Quality pop-up menu, choose **Quick Print** as the printing mode.
- 5 From the Presets pop-up menu, choose **Save as**, and then type a name for your setting configuration.
You must choose this configuration name from the Presets pop-up menu for each print job.

Changing the printing mode for a single print job

For Windows users

- 1 With a document open, click **File → Print**.
- 2 Click **Properties, Preferences, Options, or Setup**.
- 3 Select **Automatic, Quick Print, Normal, or Best**.

Note: Printing in Draft or Quick Print mode uses less ink and is ideal for printing text documents.

For Macintosh users

- 1 With a document open, choose **File > Print**.
- 2 From the printer pop-up menu, choose the printer.
- 3 From the print options pop-up menu, choose **Print Settings** or **Quality & Media**, depending on your operating system.
- 4 From the Print Quality pop-up menu, choose **Automatic, Quick Print, Normal, or Best**.

Note: Printing using Quick Print uses less ink and is ideal for printing text documents.

Pausing print jobs

For Windows users

- 1 Click , or click **Start** and then click **Run**.
- 2 In the Start Search or Run box, type `control printers`.
- 3 Press **Enter**, or click **OK**.
The printer folder opens.
- 4 Right-click the printer, and then select **Pause Printing**.

For Macintosh users

- 1 Click the printer icon on the Dock.
The print queue dialog appears.
- 2 Pause the print job:
 - If you want to pause a particular print job, then choose the document name, and then click **Hold**.
 - If you want to pause all print jobs in the queue, then click **Pause Printer** or **Stop Jobs**, depending on your operating system.

Resuming print jobs

For Windows users

- 1 Click , or click **Start** and then click **Run**.
- 2 In the Start Search or Run box, type `control printers`.
- 3 Press **Enter**, or click **OK**.
The printer folder opens.
- 4 Right-click the printer, and then select **Open**.
- 5 Resume the print job:
 - If you want to resume a particular print job, then right-click the document name, and then select **Resume** or **Restart**.
 - If you want to resume all print jobs in the queue, then click **Printer**, and then clear the selection for Pause Printing.

For Macintosh users

- 1 From the Apple menu, choose **System Preferences**.
- 2 Click **Print & Fax**.
- 3 From the Printers list or pop-up menu, choose the printer.
- 4 Click **Open Print Queue** or **Set Up Printers** depending on your operating system.
The print queue dialog appears.
- 5 Resume the print job:
 - If you want to resume a particular print job, then choose the document name, and then click **Resume**.
 - If you want to resume all print jobs in the queue, then click **Resume Printer** or **Start Jobs**.

Canceling print jobs

To cancel a print job from the printer control panel, press . To cancel a print job from the computer, do the following:

For Windows users

- 1 Click , or click **Start** and then click **Run**.
- 2 In the Start Search or Run box, type `control printers`.
- 3 Press **Enter**, or click **OK**.
The printer folder opens.
- 4 Right-click the printer, and then select **Open**.
- 5 Cancel the print job:
 - If you want to cancel a particular print job, then right-click the document name, and then select **Cancel**.
 - If you want to cancel all print jobs in the queue, then click **Printer** → **Cancel All Documents**.

For Macintosh users

- 1 Click the printer icon on the Dock.
- 2 From the print queue dialog, choose the job you want to cancel, and then click **Delete**.



Copying

Automatic Document Feeder (ADF)	Scanner glass
<p>Use the ADF for multiple-page documents.</p> <p>Note: The ADF is available only on selected models. If you purchased a printer without an ADF, then load original documents or photos on the scanner glass.</p>	 <p>Use the scanner glass for single pages, small items (such as postcards or photos), transparencies, photo paper, or thin media (such as magazine clippings).</p>

Tips for copying

- When using the ADF, adjust the paper guide on the ADF to the width of the original document.
- When using the scanner glass, close the scanner lid to avoid dark edges on the scanned image.
- Do *not* load postcards, photos, small items, transparencies, photo paper, or thin media (such as magazine clippings) into the ADF. Place these items on the scanner glass.

Making copies

- 1 Load paper.
- 2 Load an original document faceup into the ADF or facedown on the scanner glass.
- 3 From the printer control panel, press .
- 4 Press the arrow buttons to select the number of copies, and then press the **Color/Black** button to set a color or black-and-white copy.
When you select color or black-only printing, the light near your choice comes on.
- 5 Press .

Copying photos

- 1 Load photo paper.
- 2 Place a photo facedown on the scanner glass.
- 3 From the printer control panel, press .

- 4 Press **OK** until **Photo Reprint** appears.
- 5 Press the arrow buttons to scroll to **Yes**, and then press **OK**.
- 6 Press the arrow buttons to select the desired photo size, and then press **OK**.
- 7 Press .

Note: For best results, allow the prints to dry at least 24 hours before stacking, displaying, or storing.

Enlarging or reducing images

- 1 Load paper.
- 2 Load an original document facedown on the scanner glass.
- 3 From the printer control panel, press .
- 4 Press **OK** until **Resize** appears.
- 5 Press the arrow buttons until the setting that you want appears.



Notes:

- If you select Custom %, then press **OK**, and then press the arrow buttons to select the desired custom percent value. Press **OK** to save the setting.
- If you select Borderless, then the printer will reduce or enlarge the document or photo as necessary to print a borderless copy on the paper size that you selected. For best results with this resize setting, use photo paper and set the paper type to Photo, or let the printer automatically detect the paper type.

- 6 Press .

Note: After the copy job is finished, press  to reset the settings to the default. The resize setting also switches to 100% after two minutes of printer inactivity.

Adjusting copy quality

- 1 Load paper.
- 2 Load an original document faceup into the ADF or facedown on the scanner glass.
- 3 From the printer control panel, press .
- 4 Press **OK** until **Quality** appears.
- 5 Press the arrow buttons to set the copy quality to Automatic, Draft, Normal, or Photo.
- 6 Press .

Making a copy lighter or darker

- 1 Load paper.
- 2 Load an original document faceup into the ADF or facedown on the scanner glass.
- 3 From the printer control panel, press .

4 Press **OK** until **Lighter/Darker** appears.

5 Press the arrow buttons to adjust the slider.

Note: Pressing the left arrow button makes the copy lighter, and pressing the right arrow button makes the copy darker.

6 Press .

Collating copies using the printer control panel

If you print multiple copies of a document, then you can choose to print each copy as a set (collated) or to print the copies as groups of pages (not collated).

Collated



Not collated



1 Load paper.

2 Load an original document faceup into the ADF or facedown on the scanner glass.

3 From the printer control panel, press .

4 Press the arrow buttons to select the number of copies, and then press **OK**.

5 Press **OK** until **Collate** appears.

6 Press the arrow buttons to scroll to **On**.

7 Press .

Repeating an image on one page

You can print the same page image multiple times on one sheet of paper. This option is helpful when creating items such as labels, decals, flyers, and handouts.

1 Load paper.

2 Load an original document faceup into the ADF or facedown on the scanner glass.

3 From the printer control panel, press .



4 Press **OK** until **Copies per Sheet** appears.

5 Press the arrow buttons to select the number of times that an image is repeated on a page: once, four times, nine times, or 16 times.

6 Press .

Copying multiple pages on one sheet

The Pages per Sheet setting lets you copy multiple pages on one sheet by printing smaller images of each page. For example, you can condense a 20-page document into five pages if you use this setting to print four page images per sheet.

- 1 Load paper.
- 2 Load an original document faceup into the ADF or facedown on the scanner glass.
- 3 From the printer control panel, press .
- 4 Press  until **Pages per Sheet** appears.
- 5 Press the arrow buttons to select the number of pages that you want to copy on a sheet of paper. You may choose to copy one, two, or four page images on a sheet.

Note: If you are copying four pages in landscape format, scan pages 3 and 4 first, and then scan pages 1 and 2.

- 6 Press .

Making a duplex copy manually

- 1 Load paper.
- 2 Load an original document faceup into the ADF or facedown on the scanner glass.
- 3 From the printer control panel, press .
- 4 Press the arrow buttons to select the number of copies, and then press the **Color/Black** button to set a color or black-and-white copy.

When you select color or black-only printing, the light near your choice comes on.

- 5 Press  to print on one side of the paper.
- 6 Load the next page of the document.
 - If you are copying a one-sided document, then load the next page faceup into the ADF or facedown on the scanner glass.
 - If you are copying a two-sided document, then flip the original document, and then reload it faceup into the ADF or facedown on the scanner glass.

7 Remove the paper from the paper exit tray, and then reload the paper to print the other side of the document.

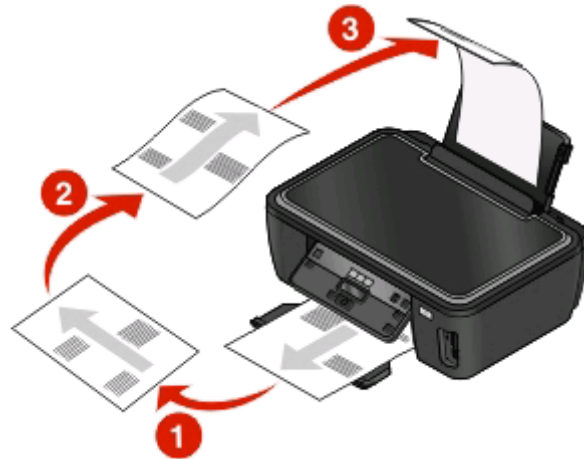

8 Press .

Canceling copy jobs

To cancel a copy job, press .

Scanning stops and the printer returns to the previous menu.



Scanning

Automatic Document Feeder (ADF)	Scanner glass
<p>Use the ADF for multiple-page documents.</p> <p>Note: The ADF is available only on selected models. If you purchased a printer without an ADF, then load original documents or photos on the scanner glass.</p>	 <p>Use the scanner glass for single pages, small items (such as postcards or photos), transparencies, photo paper, or thin media (such as magazine clippings).</p>

Tips for scanning

- When using the ADF, adjust the ADF paper guide to the width of the original document.
- When using the scanner glass, close the scanner lid to avoid dark edges on the scanned image.
- Do *not* load postcards, photos, small items, transparencies, photo paper, or thin media (such as magazine clippings) into the ADF. Place these items on the scanner glass.
- Select the PDF file type if you want to scan multiple pages and save them as one file.



Scanning to a local or network computer

- 1 Load an original document faceup into the ADF or facedown on the scanner glass.
- 2 From the printer control panel, press .
- 3 Press the arrow buttons to scroll to **Computer** or **Network**, and then press .
- 4 Press the arrow buttons to select the name of a local or network computer, and then press .

The local or network computer is the destination that will receive the scan.

Notes:



- If the printer is connected only to a local computer, then the printer will automatically download a list of the scan applications.
- You may be prompted to enter a PIN if the computer requires it. Press the arrow buttons to enter the PIN. Press  each time you enter a number.
- To assign a computer name and a PIN to the computer, see the Help for the printer software associated with your operating system.

- 5 Wait until the printer has finished downloading a list of the scan applications available on the selected computer.
- 6 Press the arrow buttons to select an application, and then press .
- 7 Press the arrow buttons to select the resolution quality and the original image size. Press  each time you make a selection.
- 8 Press  to start scanning.

The scan is complete when the application you selected in step 6 opens on the destination computer, and the scan appears within the application as a new file.

Scanning to a flash drive or memory card

Before you begin, make sure your flash drive or memory card is not write protected.

- 1 Load an original document faceup into the ADF or facedown on the scanner glass.
- 2 From the printer control panel, press .
- 3 When **Scan to** appears on the display, insert the flash drive or memory card.
- 4 Press the arrow buttons to scroll to **USB Flash Drive** or **Memory Card**, and then press .
- 5 Press the arrow buttons to select the resolution quality, the type of output you want to create, and the original image size. Press  each time you make a selection.



Note: Select the PDF file type if you want to scan multiple pages and save them as one file.

- 6 Press  to start scanning.

The scan is complete when a message appears on the printer control panel indicating that the file you scanned has been saved.

Scanning photos into an editing application

Using the printer control panel

- 1 Load the photo or photos facedown on the scanner glass.
- 2 From the printer control panel, press .
- 3 Press the arrow buttons to scroll to **Computer** or **Network**, and then press .
- 4 Press the arrow buttons to select the name of a local or network computer, and then press .

The local or network computer is the destination that will receive the scan.

Notes:

- If the printer is connected only to a local computer, then the printer will automatically download a list of the scan applications.
- You may be prompted to enter a PIN if the computer requires it. Press the arrow buttons to enter the PIN. Press  each time you enter a number.
- To assign a computer name and a PIN to the computer, see the Help for the printer software associated with your operating system.

- 5 Wait until the printer has finished downloading the list of scan applications available on the selected computer.
- 6 Press the arrow buttons to select a photo editing application, and then press **OK**.
- 7 Press the arrow buttons to select the resolution quality, the type of output you want to create, and the original image size. Press **OK** each time you make a selection.
- 8 Press **⏏**.

The scan is complete when the photo editing application you selected in step 6 opens on the destination computer, and the scan appears within the application as a new file.

Using the printer software

For Windows users

- 1 Load a photo or photos facedown on the scanner glass.
- 2 Click **Start** or **Start**.
- 3 Click **All Programs** or **Programs**, and then select the printer program folder from the list.
- 4 Select **Printer Home**.
- 5 Choose your printer from the printer drop-down list.
- 6 Click **Photo**.
 - If you want to scan a single photo, or multiple photos as a single image, then select **Single photo**.
 - If you want to scan multiple photos at once and save them as separate images, then select **Split into individual photos**.

Scanning starts and the scan progress dialog appears.

- 7 Save the photo or photos and open in a photo editing application to edit.

For Macintosh users

- 1 Load a photo or photos facedown on the scanner glass.
- 2 From the Finder desktop, double-click the printer program folder.
- 3 Double-click the printer Center to open the All-In-One Center.
- 4 From the “What is being scanned?” menu on the main screen, select **Photo**.
- 5 From the “How will the scanned image be used?” pop-up menu, choose **To be printed** or **To be viewed on monitor/Web page**.
- 6 From the “Send scanned image to” menu, choose a destination folder or application for the scanned image.
- 7 If you have several images to scan, then select **Prompt for multiple pages**.
- 8 Click **Preview/Edit**.

The Scan dialog appears.
- 9 Adjust the image and scan settings as needed.
- 10 Click **Scan**.

Scanning documents into an editing application

An Optical Character Recognition (OCR) application allows you to edit an original text document that has been scanned. In order for this to work, you must have an OCR application stored on a local or network computer and you must be able to choose it from the list of applications when you set up the scan.

When selecting settings for the scan:

- Select to scan to the local computer or network computer where the OCR is installed.
- Select to scan to the highest resolution.

For Windows users

- 1 Load an original document faceup into the ADF or facedown on the scanner glass.
- 2 Click  or **Start**.
- 3 Click **All Programs** or **Programs**, and then select the printer program folder from the list.
- 4 Select **Printer Home**.
- 5 Choose your printer from the printer drop-down list.
- 6 Click **Document**.
Scanning starts and the scan progress dialog appears.
- 7 When the scan is finished, save the document in a word-processing application.
- 8 Open the document in the selected application to edit it.

For Macintosh users

- 1 Load an original document faceup into the ADF or facedown on the scanner glass.
- 2 From the Finder desktop, double-click the printer program folder.
- 3 Double-click the printer Center to open the All-In-One Center.
- 4 From the “What is being scanned?” menu on the main screen, select a document type other than Photo.
- 5 From the “How will the scanned image be used?” pop-up menu, choose **To be edited (OCR)**.
- 6 From the “Send scanned image to” menu, choose a word-processing application to use for editing.
- 7 Click **Scan**.
- 8 Open the scanned document from a word-processing application to edit it.

Scanning directly to e-mail using the printer software

For Windows users

- 1 Load an original document faceup into the ADF or facedown on the scanner glass.
- 2 Click  or **Start**.

3 Click **All Programs** or **Programs**, and then select the printer program folder from the list.

4 Select **Printer Home**.

5 Choose your printer from the printer drop-down list.

6 Click **Email**, and then select **Photo**, **Document** or **PDF**.

Note: You can select Document only if an OCR application is stored on your computer.

Scanning starts and the scan progress dialog appears.

7 When the scan is finished, a new e-mail message is created with the scanned document automatically attached.

8 Compose your e-mail message.

Note: If your e-mail program does not open automatically, then you can scan the document to the computer and then send it through e-mail as an attachment.

For Macintosh users

1 Load an original document faceup into the ADF or facedown on the scanner glass.

2 From the Finder desktop, double-click the printer program folder.

3 Double-click the printer Center to open the All-In-One Center.

4 From the "What is being scanned?" menu on the main screen, select a document type.

5 From the "How will the scanned image be used?" menu, choose **To be viewed on monitor/web page**.

6 From the "Send scanned image to" menu, choose an application.

7 Click **Scan**.

8 Retrieve the scanned image from the application, and then send it through e-mail as an attachment.

Scanning to a PDF

For Windows users

1 Load an original document faceup into the ADF or facedown on the scanner glass.

2 Click  or **Start**.

3 Click **All Programs** or **Programs**, and then select the printer program folder from the list.

4 Select **Printer Home**.

5 Choose your printer from the printer drop-down list.

6 Click **PDF**.

Scanning starts and the scan progress dialog appears.

7 Save the document as a PDF.

For Macintosh users

- 1 Load an original document faceup into the ADF or facedown on the scanner glass.
- 2 From the Finder desktop, double-click the printer program folder.
- 3 Double-click the printer Center to open the All-In-One Center.
- 4 From the “What is being scanned?” menu on the main screen, choose a document type.
- 5 Customize the settings as needed.
- 6 Click **Scan**.
- 7 Save the document as a PDF.

Scanning FAQ

How can I improve the quality of a scan?

- Make sure your original documents are in good condition.
- Make sure the application that receives the scanned document is appropriate. For example, if you are scanning a photo to edit it, then make sure you choose a photo editing application to receive the scan. If you are scanning a document to edit the text, then make sure you choose an OCR application.
- Use a high resolution.

How do I scan in black and white?

Color is the default for all scans. To scan in black and white, press the **Color/Black** button on the printer control panel to switch from color to black and white.

Why am I being asked for a PIN?

PINs are a security measure used to restrict the scanned information from going into certain locations, or to keep what is being scanned from being seen or used by others. You may be prompted to enter a PIN if the network computer you are scanning to requires one.

To learn how PINs get assigned to network computers, see the Help for the printer software associated with your operating system.

What is an application list, and how do I update it?

When you scan a file, you can choose which application to use to open it on your computer. The printer downloads this application list from your computer when scanning for the first time. If you do not see the application you want on the list, or if you install new applications on your computer, then update the application list in the printer.

Updating the application list

- 1 From the printer control panel, press .
- 2 Press the arrow buttons to scroll to **Computer** or **Network**.

- 3 Select a local or network computer to receive the scan and then press **OK**.
- 4 Select **REFRESH** from the list of scan applications.
This updates the application list in the printer.

Canceling scan jobs

Press **X** on the printer control panel, or click **Cancel** on the computer screen.

Networking

Installing the printer on a wireless network

Wireless network compatibility

Your printer contains an IEEE 802.11g wireless print server. Your printer is compatible with IEEE 802.11 b/g/n routers that are Wi-Fi certified. If you are having issues with an n router, verify with your router manufacturer that the current mode setting is compatible with g devices, as this setting varies depending on the router brand/model.

Supported network security options

The printer supports three wireless security options: no security, WEP, and WPA/WPA2.

No Security

It is not recommended to use no security at all on a home wireless network. Using no security means that anyone within range of your wireless network can use your network resources—including Internet access, if your wireless network is connected to the Internet. The range of your wireless network may extend far beyond the walls of your home, allowing access to your network from the street or from your neighbors' homes.

WEP

WEP (Wired Equivalent Privacy) is the most basic and the weakest type of wireless security. WEP security relies on a series of characters called the WEP key.

Every device on the wireless network must use the same WEP key. WEP security can be used on both ad hoc and infrastructure networks.

A valid WEP key has:

- Exactly 10 or 26 hexadecimal characters. Hexadecimal characters are A–F, a–f, and 0–9
- or*
- Exactly 5 or 13 ASCII characters. ASCII characters are letters, numbers, punctuation, and symbols found on a keyboard.

WPA/WPA2

WPA (Wi-Fi Protected Access) and WPA2 (Wi-Fi Protected Access 2) offer stronger wireless network security than WEP. WPA and WPA2 are similar types of security. WPA2 uses a more complex encryption method and is more secure than WPA. Both WPA and WPA2 use a series of characters, called the WPA pre-shared key or passphrase, to protect wireless networks from unauthorized access.

A valid WPA passphrase has:



- From 8 to 63 ASCII characters. ASCII characters in a WPA passphrase are case-sensitive.
- or*
- Exactly 64 hexadecimal characters. Hexadecimal characters are A–F, a–f, and 0–9.

Every device on the wireless network must use the same WPA passphrase. WPA security is an option only on infrastructure networks with wireless access points and network cards that support WPA. Most newer wireless network equipment also offers WPA2 security as an option.

Note: If your network uses WPA or WPA2 security, then select **WPA Personal** when you are prompted to select the type of security your network uses.

Printing a network setup page

A *network setup page* lists the configuration settings of the printer, including the IP address and MAC address of the printer.

- 1 Load plain paper.
- 2 From the printer control panel, press .
- 3 Press the arrow buttons to scroll to **Network Setup**, and then press .
- 4 Press  to select **Print Setup Page**.
The network setup page prints.

Information you will need to set up the printer on a wireless network

To set up the printer for wireless printing, you need to know:

- The name of your wireless network. This is also known as the *Service Set Identifier (SSID)*.
- If encryption was used to secure your network.
- The security key (either a WEP key or WPA passphrase) that allows other devices to communicate on the network if encryption was used to secure your network.

You can locate your network WEP key or WPA passphrase by accessing your wireless access point or router and checking the security information.

If your wireless access point (wireless router) is using *Wired Equivalent Privacy (WEP)* security, the WEP key should be:

- Exactly 10 or 26 hexadecimal characters. Hexadecimal characters are A–F, a–f, and 0–9.
or
- Exactly 5 or 13 ASCII characters. ASCII characters are letters, numbers, punctuation, and symbols found on a keyboard.

If your wireless access point is using *Wi-Fi Protected Access (WPA)* security, the WPA passphrase should be:

- From 8 to 63 ASCII characters. ASCII characters in a WPA passphrase are case-sensitive.
or
- Exactly 64 hexadecimal characters. Hexadecimal characters are A–F, a–f, and 0–9.

If your wireless network is not using security, then you will not have a security key.

Note: If you do not know the SSID of the network that your computer is connected to, launch the wireless utility of the computer network adapter and look for the network name. If you cannot find the SSID or the security information for your network, see the documentation that came with the wireless access point, or contact your system support person.

Installing the printer on a wireless network

Before you install the printer on a wireless network, make sure that:

- Your wireless network is set up and working properly.
- The computer you are using is connected to the same wireless network where you want to set up the printer.

For Windows users

1 Close all open software programs.

2 Insert the installation software CD.

If the Welcome screen does not appear after a minute, then launch the CD manually:

a Click , or click **Start** and then click **Run**.

b In the Start Search or Run box, type `D:\setup.exe`, where **D** is the letter of your CD or DVD drive.

3 Follow the instructions on the Welcome screen to set up the printer.

For Macintosh users

1 Close all open software applications.

2 Insert the installation software CD.

If the installation dialog does not appear after a minute, then click the CD icon on the desktop.

3 Double-click **Install**.

4 Follow the instructions on the installation dialog to set up the printer.

Installing the printer on other computers

Once the printer is set up on the wireless network, it can be accessed wirelessly by any other computer on the network. However, you will need to install the printer driver on every computer that will access it. You do not need to configure the printer again, although you will need to run the setup software on each computer to install the driver.

For Windows users

1 Close all open software programs.

2 Insert the installation software CD.

If the Welcome screen does not appear after a minute, then launch the CD manually:

a Click , or click **Start** and then click **Run**.

b In the Start Search or Run box, type `D:\setup.exe`, where **D** is the letter of your CD or DVD drive.

3 Follow the instructions on the computer screen for installing a configured printer on a new computer.

For Macintosh users

1 Close all open software applications.

2 Insert the installation software CD.

If the installation dialog does not appear after a minute, then click the CD icon on the desktop.

3 Double-click **Install**.

4 Select **My printer is already set up. I am installing it on a new computer.**

5 Click **Continue**, and then follow the instructions on the computer screen for installing a configured printer on a new computer.

Interpreting the colors of the Wi-Fi indicator light

The colors of the Wi-Fi indicator light show the network status of the printer.

- **Off** means one of the following:
 - The printer is turned off or is powering up.
 - The printer is not connected to a wireless network and is in Power Saver mode. In Power Saver mode, the power light pulses on and off.
- **Solid orange** means one of the following:
 - The printer has not yet been configured for a wireless network.
 - The printer is configured for an ad hoc connection, but it is not currently communicating with another ad hoc device.
- **Blinking orange** means one of the following:
 - The printer is out of the range of the wireless access point (wireless router).
 - The printer is trying to communicate with the wireless access point, but the wireless access point is turned off or not working properly.
 - Either the configured printer or the wireless access point has been turned off and back on, and the printer is trying to establish communications with the network.
 - The wireless settings of the printer may no longer be valid.
- **Green** means that the printer is connected to a wireless network and is ready for use.

Special wireless installation instructions

The following instructions apply to customers outside of North America who are using a wireless broadband box. Some examples of these boxes include LiveBox, AliceBox, N9UF Box, FreeBox, and Club Internet.

Before you begin

- Make sure your box is wireless-enabled and activated to work on a wireless network. For more information about configuring the box to work wirelessly, see the documentation that came with your box.
- Make sure your box is turned on and that your computer is on and connected to your wireless network.

Adding the printer to your wireless network

1 Set up your printer for wireless networking using the setup instructions provided.

Stop when you are prompted to select a network.

2 If there is an association/registration button on the back of your box, press it before selecting a network.

Note: After pressing the association/registration button, you have five minutes to complete the printer installation.

3 Return to the computer screen.

From the wireless networks list that appears, select your network, and then click **Continue**.

If your wireless network does not appear in the list:

- a Connect to another wireless network.

For Windows users

Click **Unlisted Network**.

For Macintosh users

Select **Other Wireless Network**, and then click **Continue**.

- b Enter the details about your wireless network.

Note: Your WEP, WPA, or WPA2 key may be obtained from the bottom of the box, the user's guide that came with the box, or from the box Web page. If you have already changed the key for your wireless network, use the key you created.

- 4 Follow the instructions on your screen to complete installation.

Assigning a static IP address

The printer will be assigned an IP address automatically through DHCP on most wireless networks.

- 1 Complete the wireless setup, allowing the printer to receive a DHCP address from a DHCP server on the network.
- 2 Print a network setup page to see what IP address is currently assigned to the printer.
- 3 Open a Web browser and then type the printer IP address in the address field. Press **Enter**.
The printer Web page loads.

Note: If you are using a proxy server, then temporarily disable it to load the printer Web page correctly.

- 4 Click the **Configuration** link.
- 5 Click the **TCP/IP** link.
- 6 Click the **Set static IP address** link.
- 7 Type the IP address you want to assign to the printer in the **IP Address** field.
- 8 Click the **Submit** button.

The Submitting selection message appears.

To confirm that the address was successfully assigned, type the static IP address in the Web browser address field and then press **Enter**. The printer Web page loads if the address was successfully assigned.

For more information, contact your system support person.

Changing wireless settings after installation

To change wireless settings on the printer, such as the configured network, the security key, or other settings, do the following:

For Windows users

- 1 Click  or **Start**.
- 2 Click **All Programs** or **Programs**, and then select the printer program folder from the list.
- 3 Select **Printer Home**.

- 4 Click the **Settings** tab.
- 5 Click the **Wireless setup utility** link.
- 6 Follow the instructions on the computer screen to configure the printer for wireless access with the new settings.

For Macintosh users

- 1 From the Finder desktop, double-click the printer folder.
- 2 Double-click **Wireless Setup Assistant**.
- 3 Follow the instructions on the computer screen.

Advanced wireless setup

Creating an ad hoc wireless network

The recommended way to set up your wireless network is to use a wireless access point (wireless router). A network set up this way is called an *infrastructure network*. If you have an infrastructure network, you should configure the printer for use on that network.

Note: The printer can communicate on only one wireless network at a time. Configuring the printer for an ad hoc wireless network will keep it from working on any other wireless network, either ad hoc or infrastructure.

You can set up an ad hoc network if you:

- Do not have an access point or wireless router
- Do not already have a wireless network (but do have a wireless adapter for your computer)
- Want to set up a standalone network between the printer and a computer with a wireless network adapter

In Windows Vista

- 1 Click .
- 2 Click **Control Panel**.
- 3 Click **Network and Internet**.
- 4 Under Network and Sharing Center, click **Connect to a network**.
- 5 Click **Set up a connection or network** when you are prompted to select a network to connect to.
- 6 Click **Set up a wireless ad-hoc (computer-to-computer) network**, when you are prompted to choose a connection option, and then click **Next**.
- 7 Follow the instructions in the "Set up a wireless ad hoc network" wizard. As part of the setup:
 - a Create a network name or SSID for the network between the computer and your printer.
 - b Write down the name of your network. Be sure to use the exact spelling and capitalization.
 - c Go to the Security Type list, select **WEP**, and then create a WEP key.

WEP keys must be:

- Exactly 10 or 26 hexadecimal characters. Hexadecimal characters are A-F, a-f, and 0-9.
or
- Exactly 5 or 13 ASCII characters. ASCII characters are letters, numbers, and symbols found on a keyboard

d Write down the password for your network. Be sure to use the exact spelling and capitalization.

Windows Vista will enable the ad hoc network for you. It will appear in the “Connect to a network” dialog under “Available networks,” indicating that the computer is configured for the ad hoc network.

8 Close the Windows Control Panel and any remaining windows.

9 Insert the installation software CD, and follow the directions for wireless installation.

Note: Do not connect the installation or network cables until instructed to do so by the setup software.

10 When the available networks are displayed, provide the network name and the security information you created in step 6. The installer will configure the printer for use with your computer.

11 Store a copy of your network name and security information in a safe place for future reference.

Note: You may need to reconnect Windows Vista computers to the ad hoc network after restarting.

In Windows XP

1 Click **Start**.

2 Click **Control Panel**.

3 Click **Network and Internet Connections**.

4 Click **Network Connections**.

5 Right-click the icon for your wireless network connection.

6 Click **Enable**, if it appears in the pop-up menu.

Note: If Disable appears, your wireless connection is already enabled.

7 Right-click the **Wireless Network Connection** icon.

8 Click **Properties**.

9 Click the **Wireless Networks** tab.

Note: If the Wireless Networks tab does not appear, your computer has third-party software that controls your wireless settings. You must use that software to set up the ad hoc wireless network. For more information, see the documentation for the third-party software to learn how to create an ad hoc network.

10 Select the **Use Windows to configure my wireless network settings** check box.

11 Under Preferred Networks, delete any existing networks.

a Select the network to be removed.

b Click **Remove** to delete the network from the list.

12 Click **Add** to create an ad hoc network.

13 In the Network Name (SSID) box, type the name you want to give your wireless network.

14 Write down the network name you chose so you can refer to it when running the wireless setup. Be sure to use the exact spelling and capitalization.

- 15** If Network Authentication appears in the list, select **Open**.
- 16** In the “Data encryption” list, select **WEP**.
- 17** If necessary, clear the “The key is provided for me automatically” check box.
- 18** In the Network Key box, type in a WEP key.
- 19** Write down the WEP key you chose so you can refer to it when running the wireless setup. Make sure you copy it down exactly, including any capital letters.
- 20** In the “Confirm network key” box, type the same WEP key.
- 21** Select **This is a computer-to-computer (ad hoc) network; wireless access points are not used**.
- 22** Click **OK** twice to close the two open windows.
- 23** It may take a few minutes for your computer to recognize the new settings. To check on the status of your network:
 - a** Right-click the **Wireless Network Connections** icon.
 - b** Select **View Available Wireless Networks**.
 - If the network is listed but the computer is not connected, select the ad hoc network and then click **Connect**.
 - If the network does not appear, wait a minute and then click **Refresh network list**.
- 24** Insert the installation software CD, and follow the directions for wireless installation.

Note: Do not connect the installation or network cables until instructed to do so by the setup software.
- 25** When the available networks are displayed, provide the network name and the security information you created beginning in step 13. The installer will configure the printer for use with your computer.
- 26** Store a copy of your network name and security information in a safe place for future reference.

In Windows 2000

- Refer to the documentation that came with your wireless network adapter for information on configuring an ad hoc network with Windows 2000.

For Macintosh users

- 1** Access the Airport settings:

In Mac OS X version 10.5

- a** From the Apple menu, choose **System Preferences**.
- b** Click **Network**.
- c** Click **AirPort**.

In Mac OS X version 10.4 and earlier

- a** From the Finder desktop, choose **Go > Applications**.
- b** From the Applications folder, double-click **Internet Connect**.
- c** From the toolbar, click **AirPort**.

- 2** From the Network menu, click **Create Network**.

3 Create a name for the ad hoc network, and then click **OK**.

Note: Store the network name and password in a safe place for future reference.

Adding a printer to an existing ad hoc wireless network

Note: The printer can communicate on only one wireless network at a time. Configuring the printer for an ad hoc wireless network will remove it from any other wireless network, either ad hoc or infrastructure, for which it is configured.

For Windows users

- 1** Click  or **Start**.
- 2** Click **All Programs** or **Programs**, and then select the printer program folder from the list.
- 3** Select **Printer Home**.
- 4** Click the **Settings** tab.
- 5** Click **Wireless setup utility** link.
- 6** Follow the instructions on the computer screen.

Note: Windows Vista computers may need to be reconnected to the ad hoc network after restarting.

For Macintosh users

- 1** From the Finder desktop, double-click the printer folder.
- 2** Double-click **Wireless Setup Assistant**.
- 3** Follow the instructions on the computer screen.

Configuring the printer wirelessly using WPS (Wi-Fi Protected Setup)

Wi-Fi Protected Setup (WPS) is a method of configuring computers and printers on a secure wireless network. WPS is faster than manual configuration, and it reduces typing errors when new devices are added to a wireless network. The SSID and WPA passphrase are automatically detected and configured for you. The printer supports WPS and can be configured for wireless access using WPS. In order to use WPS to configure the printer, the wireless router must also support WPS.

If you want to use WPS to set up your printer, then insert the CD and follow the instructions on the computer screen.

Notes:

- To use WPS to configure the printer wirelessly, all of the devices on your wireless network must support WPS. If any device on your network does not support WPS, then you must type the SSID and security information when prompted.
- If you are using the PIN method to add your printer using WPS, make sure you type all eight digits when you are asked to enter your PIN.

Switching between USB and wireless connections (Windows only)

You can change the way you access your printer, depending on your needs. The following procedures assume that you have configured your printer for one type of connection and that the printer drivers are installed on the computer. See related topics on troubleshooting specific connection types if you encounter difficulties during configuration.

Using the printer wirelessly

- 1 Click  or **Start**.
- 2 Click **All Programs** or **Programs**, and then select the printer program folder from the list.
- 3 Select **Printer Home**.
- 4 Click the **Settings** tab.
- 5 Click the **Wireless setup utility** link.
- 6 Follow the instructions on the computer screen to set up the printer wirelessly.

Note: There is no need to remove the USB cable connecting the printer to the computer during wireless configuration.

Using the printer locally (USB)

- 1 Attach a USB cable to the computer and to the printer.
- 2 Wait a moment for Windows to locate the driver and finish setting up the printer.

Note: You can continue to use the printer wirelessly.

Switching between USB and wireless connections (Macintosh only)

You can change the way you access your printer depending on your needs. The procedures below assume that you have configured your printer for one type of connection. See related topics on troubleshooting specific connection types if you encounter difficulties during configuration.

Using the printer wirelessly

If the printer is currently set up locally (using USB connection)

- 1 Close all open software applications.
- 2 Insert the installation software CD.
If the installation dialog does not appear after a minute, then click the CD icon on the desktop.
- 3 Double-click the **Lexmark Extras** folder.
- 4 Double-click **Lexmark Setup Assistant**.
- 5 Follow the instructions on the computer screen for configuring the printer wirelessly.

Note: There is no need to remove the USB cable connecting the printer to the computer during wireless configuration.

Using the printer locally (USB)

If the printer is currently set up for wireless

- 1 Attach one end of a USB cable to the USB port on the back of the printer. Attach the other end to a USB port on the computer.
- 2 Check if a second print queue is automatically created.

In Mac OS X version 10.5

- a From the Apple menu, choose **System Preferences**.
- b Click **Print & Fax** under the Hardware section.

In Mac OS X version 10.4 or earlier

- a From the Finder desktop, choose **Go > Utilities**.
- b Double-click **Print Center** or **Printer Setup Utility**, depending on the operating system version you are using. The Printer List dialog appears.
- c Choose the printer you want to use.

- 3 If a second print queue is not created, manually add the printer.

In Mac OS X version 10.5

- a Click **+**.
- b Select the printer from the list, and then click **Add**.

In Mac OS X version 10.4 or earlier

- a Click **Add**.
The Printer Browser appears.
- b Select your printer.
- c Click **Add**.

- 4 Remove the wireless queue if you do not want to switch back to accessing the printer over a wireless connection.

Sharing a printer in a Windows environment

- 1 Prepare the computers to share the printer:
 - a Make all computers printing to the printer accessible through Network Neighborhood by enabling File and Print Sharing. See the Windows documentation for instructions on enabling File and Print Sharing.
 - b Install the printer software on all computers that will print to the printer.
- 2 Identify the printer:
 - a On the computer that is attached to the printer, do one of the following:
 - 1 Click , or click **Start** and then click **Run**.
 - 2 In the Start Search or Run box, type **control printers**.
 - 3 Press **Enter**, or click **OK**.
The printer folder opens.
 - b Right-click the name of your printer.
 - c Click **Sharing**.

- d** From the Sharing tab, select **Share this printer** or **Shared as**, and then assign a distinctive name.
 - e** Click **OK**.
- 3** Locate the printer from the remote computer:
- Note:** The remote computer is the one that is not attached to the printer.
- a** Do one of the following:
 - 1** Click , or click **Start** and then click **Run**.
 - 2** In the Start Search or Run box, type `control printers`.
 - 3** Press **Enter**, or click **OK**.
The printer folder opens.
 - b** Right-click the name of your printer.
 - c** Click **Properties**.
 - d** Click the **Ports** tab, and then click **Add Port**.
 - e** Select **Local Port**, and then click **New Port**.
 - f** Type the **Universal Naming Convention (UNC) Port name**, which consists of the server name and the distinctive printer name that was specified in step 2 on page 71. The name should be in the form `\\server\printer`.
 - g** Click **OK**.
 - h** Click **Close** on the Printer Ports dialog.
 - i** Make sure the new port is selected on the Ports tab, and then click **Apply**.
The new port is listed with the printer name.
 - j** Click **OK**.

Sharing a printer in a Macintosh environment

- 1** From the Apple menu, choose **System Preferences**.
- 2** From the menu bar, click **Help → System Preferences Help**.
- 3** In the Search field, type `sharing the printer on a network`, and then press **return**.
- 4** To let other Macintosh computers on the network that use Mac OS X version 10.3 or later use any printer connected to your Macintosh computer, double-click **Sharing your printer with Mac OS X users**.
or
To let Windows computers on the network use any printer connected to your Macintosh computer, double-click **Sharing your printers with Windows users**.
- 5** Follow the instructions on the computer screen.

Note: Windows users should see the Windows documentation for information on adding a network printer connected to a Macintosh computer.

Networking FAQ

What is Wi-Fi Protected Setup?

Wi-Fi Protected Setup (WPS) is a simple and secure configuration that allows you to establish a wireless home network and enable network security without requiring prior knowledge of Wi-Fi technology. It is no longer necessary to configure the network name (SSID) and WEP key or WPA passphrase for network devices.

Note: WPS only supports networks that communicate through wireless access points (wireless routers).

The printer supports the following methods in connecting to a wireless network:

- *Personal Identification Number (PIN)*—A PIN on the printer is entered into the wireless settings of the wireless access point.
- *Push Button Configuration (PBC)*—Buttons on both the printer and the wireless access point are pushed within a given period of time.

Look for any of these identifier marks to check if your wireless access point is WPS certified:



You can find these WPS logos on the side, back, or top of your wireless access point.

For more information on accessing the wireless settings and determining the WPS capability of your wireless access point, see the documentation that came with the wireless access point or contact your system support person.

Where do I find my WEP key or WPA passphrase?

To find the WEP key or WPA passphrase for the wireless network, view the security settings on the access point or wireless router. Most access points have a Web page that can be accessed using a Web browser.

You can also check the manual that came with your access point or router. If your access point or router is using the default settings, you can find the information in the manual. If someone else set up your network for you, that person or company may have included the information in the manual.

If you do not know how to access the Web page, or if you do not have administrator access to the wireless access point on your network, and are unable to locate the information in the manual, contact your system support person.

What is an SSID?

A Service Set Identifier (SSID) is the name that identifies a wireless network. All devices on the network must know the SSID of the wireless network or they will not be able to communicate with each other. Usually, the wireless network broadcasts the SSID to allow wireless devices in the area to connect to it. Sometimes, the SSID is not broadcast for security reasons.

If the SSID of your wireless network is not broadcast, it cannot be detected automatically and will not show up in the list of available wireless networks. You must enter the network information manually in this situation.

An SSID can contain up to 32 alphanumeric characters.

Where do I find my SSID?

You can find the SSID for the wireless network by viewing the settings on the access point or wireless router. Most access points have a built-in Web server that can be accessed using a Web browser.

Many network adapters provide a software application that allows you to view the wireless settings of your computer, including your SSID. Check your computer to see if a program was installed with your network adapter.

If you are unable to locate your SSID using either of these methods, contact your system support person.

What is a network?

A network is a collection of devices such as computers, printers, Ethernet hubs, wireless access points, and routers connected together for communication through cables or through a wireless connection. A network can be wired, wireless, or designed to have both wired and wireless devices.

Devices on a wired network use cables to communicate with each other.

Devices on a wireless network use radio waves instead of cables to communicate with each other. For a device to be able to communicate wirelessly, it must have a wireless network adapter attached or installed that lets it receive and transmit radio waves.

How do I find out what type of security my network is using?

You must know the WEP key or WPA passphrase and the type of security (WEP, WPA, or WPA2) used on the wireless network. To obtain this information, see the documentation that came with your wireless access point (wireless router), see the Web page associated with the wireless access point, or consult your system support person.

Note: The WEP key or WPA passphrase is not the same as the password for the wireless access point. The password allows you to access the wireless access point settings. The WEP key or WPA passphrase allows printers and computers to join your wireless network.

How are home networks configured?

For desktop computers, laptops, and printers to communicate with each other over a network, they must be connected by cables and/or have wireless network adapters built in or installed in them.

There are many different ways a network can be set up. Four common examples appear below.

Note: The printers in the following diagrams represent printers with internal print servers built into them so that they can communicate over a network.

Wireless network examples

Scenario 1: Mixed wired and wireless connections on a network with Internet access

- All computers and printers connect to the network through a router with Ethernet and wireless capabilities.
- Some computers and printers connect wirelessly to the router; others connect over a wired connection.

- The network is connected to the Internet through a DSL or cable modem.

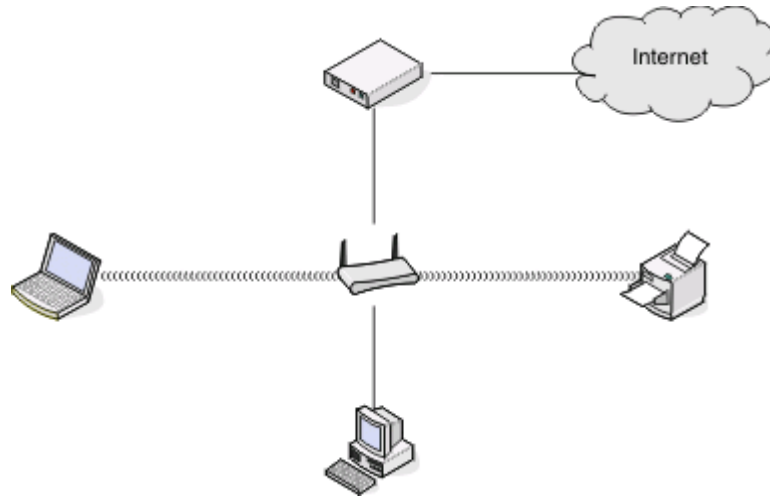

Scenario 2: Wireless network with Internet access

- All computers and printers connect to the network using a wireless access point or wireless router.
- The wireless access point connects the network to the Internet through a DSL or cable modem.

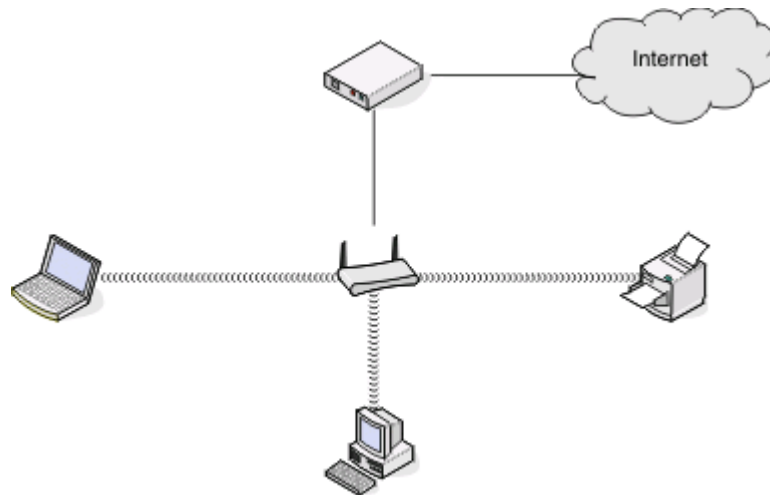

Scenario 3: Wireless network with no Internet access

- Computers and printers connect to the network using a wireless access point.
- The network has no connection to the Internet.

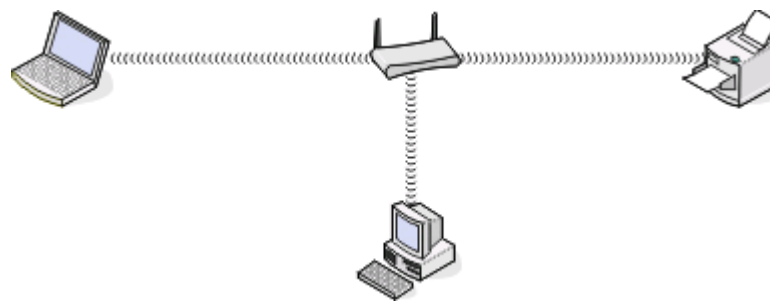

Scenario 4: Computer connected wirelessly to a printer without Internet access

- A computer is directly connected to a printer without going through a wireless router.
- This configuration is referred to as an *ad hoc network*.
- The network has no connection to the Internet.

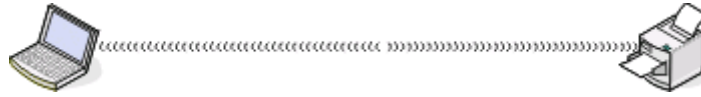

Note: Most computers can connect to only one wireless network at a time. If you access the Internet over a wireless connection, you will lose Internet access if you are connected to an ad hoc network.

Why do I need an installation cable?

When setting up the printer on your wireless network, the printer will need to temporarily connect to a computer using the installation cable. This temporary connection is used to set up the wireless settings of the printer.

The installation cable connects to a rectangular USB port on the installing computer and the square USB port on the printer.

How do I attach the installation cable?

The installation cable attaches to a USB port on the computer and to the square connector on the back of the printer. This connection allows you to configure the printer for a networked or locally attached installation.

- 1** Attach the large, rectangular connector to any USB port on your computer. USB ports may be on the front or the back of the computer, and may be horizontal or vertical.

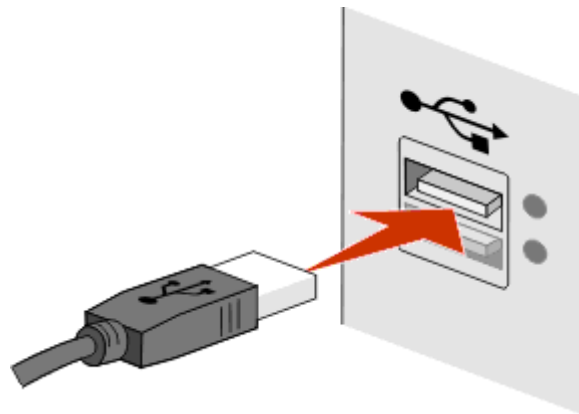

2 Attach the small, square connector to the printer.

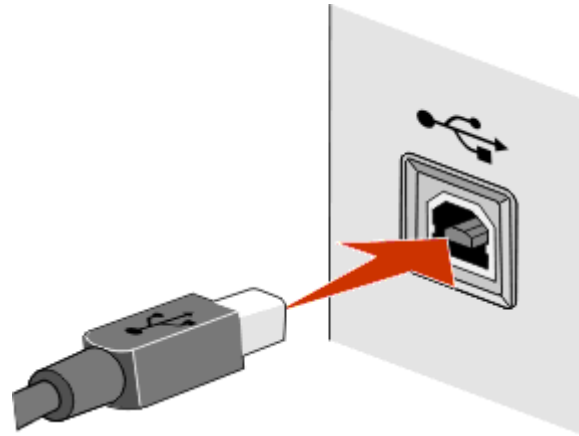

3 Continue following the on-screen instructions.

How are infrastructure and ad hoc networks different?

Wireless networks can operate in one of two modes: infrastructure or ad hoc.

In *infrastructure* mode, all devices on a wireless network communicate with each other through a wireless router (wireless access point). Devices on the wireless network must have valid IP addresses for the current network and share the same SSID and channel as the wireless access point.

In *ad hoc* mode, a computer with a wireless network adapter communicates directly with a printer equipped with a wireless print server. The computer must have a valid IP address for the current network and be set to ad hoc mode. The wireless print server must be configured to use the same SSID and channel that the computer is using.

The following table compares the characteristics and requirements of the two types of wireless networks.

	Infrastructure	Ad hoc
Characteristics		
Communication	Through wireless access point	Directly between devices
Security	More security options	WEP or no security
Range	Determined by range and number of wireless access points	Restricted to range of individual devices on network
Speed	Usually faster	Usually slower
Requirements for all devices		
Unique IP address for each device	Yes	Yes
Mode set to	Infrastructure mode	Ad hoc mode
Same SSID	Yes, including the wireless access point	Yes
Same channel	Yes, including the wireless access point	Yes

We recommend setting up a network in infrastructure mode using the installation CD that came with the printer.

Infrastructure mode is the recommended setup method because it provides:

- Increased network security
- Increased reliability
- Faster performance
- Easier setup

Finding the signal strength

Wireless devices have built-in antennas that transmit and receive radio signals. The signal strength listed on the printer network setup page indicates how strongly a transmitted signal is being received. Many factors can affect the signal strength. One factor is interference from other wireless devices or other devices such as microwave ovens. Another factor is distance. The farther two wireless devices are from each other, the more likely it is that the communication signal will be weaker.

The strength of the signal received by your computer can also affect the connectivity of the printer with the network during configuration. When you installed the wireless adapter in your computer, the adapter software probably placed an icon in your system tray. Try double-clicking this icon, and it will tell you how strongly the computer is receiving the wireless signal from the network.

To improve signal quality, remove sources of interference and/or move wireless devices closer to the wireless access point (wireless router).

How can I improve wireless signal strength?

A common reason wireless printers fail to communicate over a network is poor wireless signal quality. If the signal is too weak, too distorted, or blocked by an object, it cannot carry information between the access point and the printer. To determine if the printer is receiving a strong signal from the access point, print a network setup page. The Quality field indicates the relative strength of the wireless signal the printer is receiving. Drops in signal strength can be intermittent, however, and although the signal quality appears high, it may drop during certain conditions.

If you think signal strength is a problem between your access point and the printer, try one or more of the following:

Notes:

- The solutions below are for infrastructure networks. If you are using an ad hoc network, adjust the computer when the solution suggests adjusting the access point.
- Ad hoc networks have a much shorter range than infrastructure networks. Try moving the printer closer to the computer if they seem to have trouble communicating.

MOVE THE PRINTER CLOSER TO THE WIRELESS ACCESS POINT/WIRELESS ROUTER

If the printer is too far away from the access point, it will not be able to communicate with other devices on the network. For most indoor wireless networks, the maximum distance between the access point and the printer is approximately 100 feet (30 meters). This distance could be longer or shorter, depending upon the layout of the network and the limitations of the access point.

REMOVE OBSTACLES BETWEEN THE ACCESS POINT AND THE PRINTER

The wireless signal from your access point will pass through most objects. Most walls, floors, furniture and other objects will not block the wireless signal. However, there are materials that are too dense for the signal to pass through. Objects containing metal and concrete can block the signal. Arrange your printer and access point so that the signal is not blocked by such objects.

REMOVE SOURCES OF INTERFERENCE

Other types of radio frequencies can cause problems with the wireless signal on your network. These sources of interference can cause printing issues that seem to come and go. Turn off potential sources of interference where possible. Avoid using microwaves and cordless phones when printing over your wireless network.

If another wireless network is operating in the vicinity, change the wireless channel on the access point.

Do not place your access point on a printer or other electronic device. Such devices can also interfere with the wireless signal.

ARRANGE THE NETWORK TO REDUCE SIGNAL ABSORPTION

Even when the wireless signal is able to pass through an object, it is slightly weakened. If it passes through too many objects, it can be significantly weakened. All objects absorb part of the wireless signal when it passes through them, and certain types of objects absorb enough to cause communications problems. Place your access point as high in the room as possible to avoid signal absorption.

How can I make sure my computer and printer are connected to the same wireless network?

If the printer is not on the same wireless network as the computer, you will not be able to print wirelessly. The SSID of the printer must match the SSID of the computer, if the computer is already connected to the wireless network.

For Windows users

- 1** Obtain the SSID of the network that the computer is connected to:
 - a** Type the IP address of your wireless access point (wireless router) into the address field of your Web browser.

If you do not know the IP address of the wireless access point:

 - 1** Click , or click **Start** and then click **Run**.
 - 2** In the Start Search or Run box, type `cmd`.
 - 3** Press **Enter**, or click **OK**.

The Command Prompt window opens.
 - 4** Type `ipconfig`, and then press **Enter**. Check the Wireless Network Connection section:
 - The “Default Gateway” entry is typically the wireless access point.
 - The IP address appears as four sets of numbers separated by periods, such as 192.168.2.134.
 - b** Type the user name and password of the router when prompted.
 - c** Click **OK**.
 - d** On the main page, click **Wireless** or any other selection where settings are stored. The SSID will be displayed.
 - e** Write down the SSID.

Note: Make sure you copy it exactly, including any capital letters.
- 2** Print the printer network setup page.

In the Wireless section, look for **SSID**.

- 3 Compare the SSID of the computer and SSID of the printer.

If the SSIDs are the same, then the computer and the printer are connected to the same wireless network.

If the SSIDs are not the same, then run the utility again to set up the printer on the wireless network used by the computer.

For Macintosh users with an AirPort base station

In Mac OS X version 10.5

- 1 From the Apple menu, choose **System Preferences**.
- 2 Click **Network**.
- 3 Click **AirPort**.

The SSID of the network the computer is connected to is displayed in the Network Name pop-up menu.

- 4 Write down the SSID.

In Mac OS X version 10.4 and earlier

- 1 From the Finder desktop, choose **Go > Applications**.
- 2 From the Applications folder, double-click **Internet Connect**.
- 3 From the toolbar, click **AirPort**.

The SSID of the network the computer is connected to is displayed in the Network pop-up menu.

- 4 Write down the SSID.

For Macintosh users with a wireless access point

- 1 Type the IP address of the wireless access point in the address field of your Web browser and continue to step 2.

If you do not know the IP address of the wireless access point, then do the following:

- a From the Apple menu, choose **System Preferences**.
- b Click **Network**.
- c Click **AirPort**.
- d Click **TCP/IP**, or click **Advanced**, and then click **TCP/IP**.

- 2 Type your user name and password when prompted.
- 3 Click **OK**.
- 4 On the main page, click **Wireless** or another selection where settings are stored. The SSID will be displayed.
- 5 Write down the SSID, security type and the WEP key/WPA passphrase (if shown).

Notes:

- Make sure you copy the network information down exactly, including any capital letters.
- Store the SSID and the WEP key or WPA passphrase in a safe place for future reference.

Can I use my printer on a USB and a network connection at the same time?

Yes, the printer supports a simultaneous USB and network connection. The printer can be configured in the following ways:

- Locally attached (connected to a computer using a USB cable)
- Wireless network
- Wireless network and locally attached simultaneously

What is a MAC address?

A Media Access Control (MAC) address is a 48-bit identifier associated with the hardware of network equipment. The MAC address may also be called the physical address because it is connected to the hardware of a device instead of its software. The MAC address is displayed as a hexadecimal number in this format: 01-23-45-67-89-AB.

Every device capable of communicating on a network has a MAC address. Network printers, computers, and routers, whether Ethernet or wireless, all have MAC addresses.

While it is possible to change the MAC address of a network device, it is not common practice to do so. For this reason, MAC addresses are considered permanent. IP addresses are easily changed, so MAC addresses are a more reliable method of identifying a specific device on a network.

Routers with security capabilities may allow filtering of MAC addresses on networks. This allows a managed list of devices to access the network, identified by their MAC addresses. MAC address filtering can help prevent access on the network from unwanted devices, such as from intruders on a wireless network. MAC address filtering can also prevent legitimate access if you forget to add a new device to the router's list of allowed addresses. If your network uses MAC address filtering, be sure to add the MAC address of the printer to the list of allowed devices.

How do I find the MAC address?

Most network equipment has a unique hardware identification number to distinguish it from other devices on the network. This is called the *Media Access Control (MAC)* address.

When installing the printer on a network, make sure you select the printer with the correct MAC address.

The MAC address label is located inside the printer.

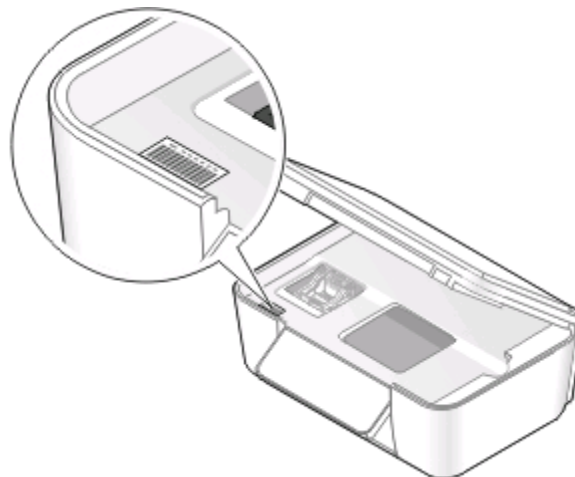

The MAC address of the internal print server is a series of letters and numbers. Other devices sometimes use a type of MAC address called *Universally Administered Address (UAA)*.



Note: A list of MAC addresses can be set on an access point (router) so that only devices with matching MAC addresses are allowed to operate on the network. This is called *MAC filtering*. If MAC filtering is enabled in your access point and you want to add a printer to your network, then the MAC address of the printer must be included in the MAC filter list.

What is an IP address?

An IP address is a unique number used by devices (such as a wireless printer, computer, or wireless access point) on an IP network to locate and communicate with each other. Devices on an IP network can communicate with each other only if they have unique and valid IP addresses. A unique IP address means no two devices on the same network have the same IP address.

An IP address is a group of four numbers separated by periods. An example of an IP address is 192.168.100.110.

What is TCP/IP?

Networks are able to function because computers, printers, and other devices are able to send data to each other, either through cables or by using wireless signals. This transfer of data is made possible by sets of data transmission rules called *protocols*. A protocol can be thought of as a language, and like a language, it has rules allowing participants to communicate with each other.

Different types of networks use different protocols, but *Transmission Control Protocol/Internet Protocol (TCP/IP)* is the most popular. TCP/IP is used to send data over the Internet as well as over most corporate and home networks.

Because computers do not understand words and instead rely upon numbers for communication, TCP/IP requires that every device on a network using TCP/IP to communicate must have an IP address. IP addresses are essentially unique computer names in a numeric format, used to transfer data around a network. IP addresses allow TCP/IP to confirm requests for and receipt of data by various devices on the network.

How do I locate IP addresses?

For Windows users

- 1 Click , or click **Start** and then click **Run**.
- 2 In the Start Search or Run box, type **cmd**.
- 3 Press **Enter**, or click **OK**.

The Command Prompt window opens.

- 4 Type **ipconfig**, and then press **Enter**.

The IP address appears as four sets of numbers separated by periods, such as 192.168.0.100.

For Macintosh users

- 1 From the Apple menu, choose **About This Mac**.
- 2 Click **More Info**.
- 3 From the Contents pane, choose **Network**.
- 4 If you are connected over a wireless network, choose **AirPort** from the Active Services list.

How to locate a printer IP address

- You can locate the printer IP address by viewing the printer network setup page.

How are IP addresses assigned?

An IP address may be assigned automatically by the network using DHCP. Once the printer is set up on a computer, the computer sends all print jobs across the network to the printer using this address.

If the IP address is not automatically assigned, you will be asked during wireless setup to manually enter an address and other network information after selecting your printer from the available list.

What is a key index?

A wireless access point (wireless router) can be configured with as many as four WEP keys. Only one key is used on the network at a time, however. The keys are numbered, and the number of a key is referred to as its key index. All devices on the wireless network must be configured to use the same key index when multiple WEP keys are configured on the wireless access point.

Select the same key index on your printer as you are using on your wireless access point.



Maintaining the printer

Maintaining ink cartridges

In addition to the following tasks that you can perform, your printer performs an automatic maintenance cycle every week if it is plugged into an electrical outlet. It will briefly come out of Power Saver mode or will temporarily power on if it is turned off.

Checking ink levels

Using the printer control panel

- 1 From the printer control panel, press .
- 2 Press the arrow buttons to scroll to **Maintenance**, and then press .
- 3 Press  again to select **Ink Levels**.
- 4 Press the arrow buttons to check the ink level in each cartridge.

Using the printer software

For Windows users

- 1 Click  or **Start**.
- 2 Click **All Programs** or **Programs**, and then select the printer program folder from the list.
- 3 Select **Printer Home**.
- 4 Choose your printer from the printer drop-down list.
- 5 From the Maintenance tab, click **Check ink levels**.



For Macintosh users



- 1 From the Finder desktop, double-click the printer program folder.
- 2 Select **Printer Utility** from the list.
- 3 Check the ink levels from the Maintenance tab.

Aligning the printhead

If the characters or lines on your printer image appear jagged or wavy, then you may need to align the printhead.

Using the printer control panel

- 1 Load plain paper.
- 2 From the printer control panel, press .
- 3 Press the arrow buttons to scroll to **Maintenance**, and then press .

- 4 Press the arrow buttons to scroll to **Align Printer**, and then press .
- 5 Press  again.
An alignment page prints.

Note: Do not remove the alignment page until printing is finished.

Using the printer software

For Windows users

- 1 Load plain paper.
- 2 Click  or **Start**.
- 3 Click **All Programs** or **Programs**, and then select the printer program folder from the list.
- 4 Select **Printer Home**.
- 5 Choose your printer from the printer drop-down list.
- 6 From the Maintenance tab, click **Align cartridges**.
- 7 Follow the instructions on the computer screen.

For Macintosh users

- 1 Load plain paper.
- 2 From the Finder desktop, double-click the printer program folder.
- 3 Select **Printer Utility** from the list.
- 4 From the Maintenance tab of the Printer Utility dialog, click **Print Alignment Page**.
- 5 Follow the instructions on the computer screen.

If you aligned the cartridges to improve print quality, then print your document again. If print quality has not improved, then clean the printhead nozzles.



Cleaning the printhead nozzles

Poor print quality is sometimes due to clogged printhead nozzles. Clean the printhead nozzles to improve the quality of your prints.

Notes:

- Cleaning the printhead nozzles uses ink, so clean them only when necessary.
- Deep cleaning uses more ink, so try the Clean Printhead option first to save ink.
- If the ink levels are too low, you must replace the ink cartridges before you can clean the printhead nozzles.

Using the printer control panel

- 1 From the printer control panel, press .
- 2 Press the arrow buttons to scroll to **Maintenance**, and then press .

- 3 Press the arrow buttons to scroll to **Clean Printhead** or **Deep Clean Printhead**, and then press **OK**.
- 4 Press **OK** to clean the printhead nozzles.
A cleaning page prints.

Using the printer software

For Windows users

- 1 Click  or **Start**.
- 2 Click **All Programs** or **Programs**, and then select the printer program folder from the list.
- 3 Select **Printer Home**.
- 4 From the Maintenance tab, click **Clean Cartridges**.

For Macintosh users

- 1 From the Finder desktop, double-click the printer program folder.
- 2 Select **Printer Utility** from the list.
- 3 From the Maintenance tab, select **Clean Print Nozzles**.
A cleaning page prints.

Cleaning the exterior of the printer

- 1 Make sure that the printer is turned off and unplugged from the wall outlet.



CAUTION—SHOCK HAZARD: To avoid the risk of electric shock when cleaning the exterior of the printer, unplug the power cord from the wall outlet and disconnect all cables to the printer before proceeding.

- 2 Remove paper from the paper support and paper exit tray.
- 3 Dampen a clean, lint-free cloth with water.

Warning—Potential Damage: Do not use household cleaners or detergents, as they may damage the finish of the printer.

- 4 Wipe only the outside of the printer, making sure to remove any ink residue that has accumulated on the paper exit tray.

Warning—Potential Damage: Using a damp cloth to clean the interior may cause damage to your printer.

- 5 Make sure the paper support and paper exit tray are dry before beginning a new print job.

Cleaning the scanner glass

- 1 Dampen a clean, lint-free cloth with water.
- 2 Gently wipe the scanner glass clean.

Note: Make sure all ink or corrective fluid on a document is dry before placing the document on the scanner glass.

Troubleshooting

Before you troubleshoot

Use this checklist to solve most printer problems:

- Make sure the power cord is plugged into the printer and into a working electrical outlet.
- Make sure the printer is not plugged into any surge protectors, uninterrupted power supplies, or extension cords.
- Make sure the printer is turned on.
- Make sure the printer is securely connected to the host computer, print server, or other network access point.
- Check the printer for error messages, and resolve any errors.
- Check for paper jam messages, and clear any jams.
- Check the ink cartridges, and install new cartridges if necessary.
- Use the Service Center to locate and solve the problem (Windows only).
- Turn the printer off, wait about 10 seconds, and then turn the printer back on.

Using the Service Center to solve printer problems

The Service Center provides step-by-step troubleshooting help and contains links to printer maintenance tasks and customer support.

To open the Service Center, use one of these methods:

Method 1	Method 2
If it appears on an error message dialog, click the For additional assistance, use the Service Center link.	<ol style="list-style-type: none">1 Click  or Start.2 Click All Programs or Programs, and then select the printer program folder from the list.3 Select Printer Home.4 From the Support tab, select Service Center.

If Troubleshooting does not solve your problem

Visit our Web site at support.lexmark.com to find the following:

- Knowledgebase articles with the latest information and troubleshooting for your printer
- Live online technical support
- Contact numbers for telephone technical support

Setup troubleshooting





- "Incorrect language appears on the display" on page 88
- "Printhead errors" on page 88
- "Software did not install" on page 90

- “Print job does not print or is missing pages” on page 90
- “Printer is printing blank pages” on page 91
- “Printer is busy or does not respond” on page 91
- “Cannot delete documents from the print queue” on page 92
- “Cannot print through USB” on page 92

Incorrect language appears on the display





If the "Before you troubleshoot" checklist does not solve the problem, then try one or more of the following:



CHANGE THE LANGUAGE USING THE PRINTER MENUS

- 1 From the printer control panel, press .
- 2 Press the arrow buttons to scroll to **Default**s, and then press .
- 3 Press the arrow buttons to scroll to **Set Default**s, and then press .
- 4 Press the arrow buttons to scroll to **Use Factory**, and then press .
- 5 Complete the initial printer setup.

CHANGE THE LANGUAGE USING A BUTTON COMBINATION (IF YOU CANNOT READ THE CURRENT LANGUAGE)

- 1 Turn the printer off.

Note: If you have set the Power Saver timeout in the Setup menu, then press and hold  for three seconds to turn off the printer.
- 2 Press and hold down  and , and then press and release  to turn the printer on.

Note: Do not release  and  until **Language** appears on the display, indicating that the printer has been reset.
- 3 Complete the initial printer setup.

Printhead errors

If the "Before you troubleshoot" checklist does not solve the problem, then try the following:

REMOVE AND REINSERT THE PRINthead

- 1 Open the printer and lift the latch.



- 2 Remove the printhead.

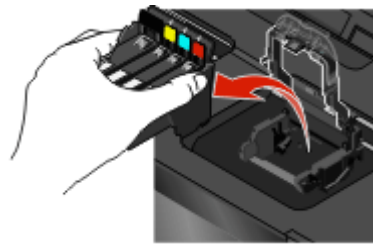

- 3 Wipe the printhead contacts using a clean, lint-free cloth.

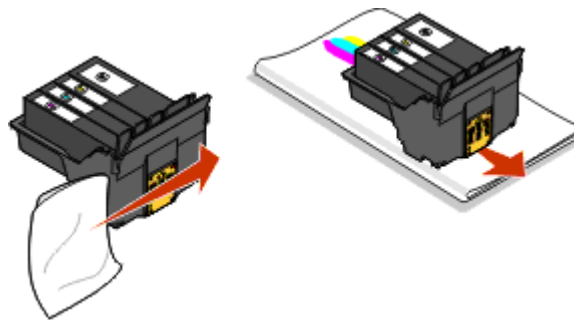

- 4 Reinsert the printhead.

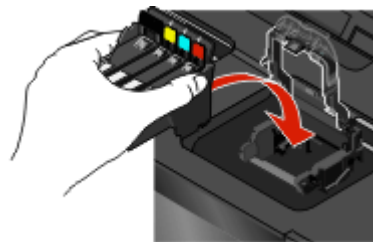

Note: If removing and reinserting the printhead does not resolve the error, then contact technical support.

Software did not install

If you encountered problems while installing, or if your printer does not appear in the list in the Printers folder or as a printer option when sending a print job, then try removing and reinstalling the software.

Before you reinstall the software, do the following:

MAKE SURE THAT YOUR COMPUTER MEETS THE MINIMUM SYSTEM REQUIREMENTS LISTED ON THE PRINTER BOX

TEMPORARILY DISABLE SECURITY PROGRAMS IN WINDOWS BEFORE INSTALLING THE SOFTWARE

CHECK THE USB CONNECTION

- 1 Check the USB cable for any obvious damage. If the cable is damaged, then use a new one.
- 2 Firmly plug the square end of the USB cable into the back of the printer.
- 3 Firmly plug the rectangular end of the USB cable into the USB port of the computer.
The USB port is marked with a  USB symbol.

RECONNECT THE PRINTER POWER SUPPLY

- 1 Turn off the printer, and then unplug the power cord from the wall outlet.
- 2 Gently remove the power supply from the printer, and then reinsert it.
- 3 Plug the power cord into the wall outlet, and then turn on the printer.

Print job does not print or is missing pages

If the "Before you troubleshoot" checklist does not solve the problem, then try one or more of the following:

MAKE SURE THE INK CARTRIDGES ARE INSERTED CORRECTLY

- 1 Turn the printer on, and then open the printer.
- 2 Make sure the cartridges are inserted correctly.
The cartridges should *click* firmly into the matching color slot of the printhead.
- 3 Close the printer.

SELECT YOUR PRINTER FROM THE PRINT DIALOG BEFORE SENDING THE PRINT JOB

MAKE SURE THE PRINT JOB IS NOT PAUSED

MAKE SURE YOUR PRINTER IS SET AS THE DEFAULT PRINTER

RECONNECT THE PRINTER POWER SUPPLY

- 1 Turn off the printer, and then unplug the power cord from the wall outlet.
- 2 Gently remove the power supply from the printer, and then reinsert it.
- 3 Plug the power cord into the wall outlet, and then turn on the printer.

REMOVE AND RECONNECT THE USB CABLE CONNECTED TO YOUR PRINTER

CHECK THE USB CONNECTION





- 1 Check the USB cable for any obvious damage. If the cable is damaged, then use a new one.
- 2 Firmly plug the square end of the USB cable into the back of the printer.
- 3 Firmly plug the rectangular end of the USB cable into the USB port of the computer.
The USB port is marked with a  USB symbol.

REMOVE AND REINSTALL THE PRINTER SOFTWARE

Printer is printing blank pages

Blank pages may be caused by improperly installed ink cartridges.

REINSTALL THE INK CARTRIDGES AND DEEP CLEAN AND ALIGN THE PRINTHEAD

- 1 Reinstall the ink cartridges, see “Replacing ink cartridges” on page 12 for more information.
If the cartridges do not seem to fit, make sure the printhead is properly seated, and then try installing the cartridges again.
- 2 Load plain paper.
- 3 From the printer control panel, press .
- 4 Press the arrow buttons to scroll to **Maintenance**, and then press .
- 5 Press the arrow buttons to scroll to **Deep Clean Printhead**, and then press .
A cleaning page prints.
- 6 Press the arrow buttons to scroll to **Align Printer**, and then press .
An alignment page prints.

Note: Do not remove the alignment page until printing is finished.

Printer is busy or does not respond

If the "Before you troubleshoot" checklist does not solve the problem, then try one or more of the following:

MAKE SURE THE PRINTER IS NOT IN POWER SAVER MODE

If the power light is blinking on and off slowly, then the printer is in Power Saver mode. Press  to wake up the printer.

If the printer will not come out of Power Saver mode, then reset the power:

- 1 Unplug the power cord from the wall outlet, and then wait 10 seconds.
- 2 Insert the power cord into the wall outlet, and then turn on the printer.

If this problem persists, then check our Web site for updates for your printer software or firmware.

RECONNECT THE PRINTER POWER SUPPLY

- 1 Turn off the printer, and then unplug the power cord from the wall outlet.
- 2 Gently remove the power supply from the printer, and then reinsert it.
- 3 Plug the power cord into the wall outlet, and then turn on the printer.

Cannot delete documents from the print queue

If you have jobs stuck in the print queue and cannot delete them to get other jobs to print, then the computer and printer may not be communicating.

RESTART THE COMPUTER AND TRY AGAIN

Cannot print through USB

If the "Before you troubleshoot" checklist does not solve the problem, then try one or more of the following:

CHECK THE USB CONNECTION

- 1 Check the USB cable for any obvious damage. If the cable is damaged, then use a new one.
- 2 Firmly plug the square end of the USB cable into the back of the printer.
- 3 Firmly plug the rectangular end of the USB cable into the USB port of the computer.

The USB port is marked with a  USB symbol.

MAKE SURE THE USB PORT IS ENABLED IN WINDOWS

- 1 Click , or click **Start** and then click **Run**.
- 2 In the Start Search or Run box, type `devmgmt.msc`.
- 3 Press **Enter**, or click **OK**.
The Device Manager opens.
- 4 Click the plus sign (+) beside Universal Serial Bus controllers.
If USB Host Controller and USB Root Hub are listed, then the USB port is enabled.

For more information, see the computer documentation.

REMOVE AND REINSTALL THE PRINTER SOFTWARE

Jams and misfeeds troubleshooting

- “Paper jam in the printer” on page 93
- “Paper jam in the paper support” on page 93
- “Paper or specialty media misfeeds” on page 93

Paper jam in the printer

Note: The parts inside the printer are sensitive. Avoid unnecessarily touching these parts while clearing jams.



- 1 Press  to turn off the printer.
- 2 Check the paper tray or lift the scanner unit to check for jammed paper.



- 3 Firmly grasp the paper, and then gently pull it out.
Note: Be careful not to tear the paper while removing it.
- 4 Press  to turn the printer back on.

Paper jam in the paper support

Note: The parts inside the printer are sensitive. Avoid unnecessarily touching these parts while clearing jams.

- 1 Press  to turn off the printer.
- 2 Firmly grasp the paper, and then gently pull it out.
Note: Be careful not to tear the paper while removing it.
- 3 Press  to turn the printer back on.

Paper or specialty media misfeeds

These are possible solutions if paper or specialty media misfeeds or skews, or if multiple sheets feed or stick together. Try one or more of the following:

CHECK PAPER CONDITION

Use only new, unwrinkled paper.

CHECK PAPER LOADING

- Load a smaller amount of paper into the printer.
- Load paper with the print side faceup. (If you are not sure which side is the printable side, see the instructions that came with the paper.)
- Check the loading instructions for your paper or specialty media.

REMOVE EACH PAGE AS IT IS PRINTED

ADJUST THE PAPER GUIDES TO FIT THE LOADED PAPER

Print troubleshooting

- “Poor quality at the edges of the page” on page 94
- “Streaks or lines on printed image” on page 95
- “Print speed is slow” on page 95
- “Computer slows down when printing” on page 96

Poor quality at the edges of the page

If the "Before you troubleshoot" checklist does not solve the problem, then try one or more of the following:

CHECK MINIMUM PRINT SETTINGS

Unless you are using the borderless feature, use these minimum print margin settings:

- Left and right margins:
 - 6.35 mm (0.25 in.) for letter-size paper
 - 3.37 mm (0.133 in.) for all paper sizes except letter
- Top margin: 1.7 mm (0.067 in.)
- Bottom margin: 12.7 mm (0.5 in.)

SELECT THE BORDERLESS PRINT FEATURE

For Windows users:

- 1 With a document or photo open, click **File → Print**.
- 2 Click **Properties, Preferences, Options, or Setup**.
- 3 From the Paper Options section of the Print Setup tab, select **Borderless**.

For Macintosh users:

- 1 With a document or photo open, choose **File > Print**.
- 2 From the Printer pop-up menu, choose the printer.
- 3 If necessary, click **Advanced**.
- 4 From the print options pop-up menu, choose **Paper Handling**.

- 5 From the Destination Paper Size section, select **Scale to fit paper size**.
- 6 From the Paper Size pop-up menu, choose a paper size that has "(Borderless)" in the name. For example, if you are printing on a 4 x 6 photo card, then choose **US 4 x 6 in (Borderless)**.

Streaks or lines on printed image

If the "Before you troubleshoot" checklist does not solve the problem, then try one or more of the following:

CHECK THE INK LEVELS

Replace low or empty ink cartridges.

SELECT A HIGHER PRINT QUALITY FROM THE PRINTER SOFTWARE

MAKE SURE THE INK CARTRIDGES ARE PROPERLY INSTALLED

ALIGN THE PRINTHEAD

CLEAN OR DEEP CLEAN THE PRINTHEAD NOZZLES

Note: If these solutions do not remove the streaks or lines on the printed image, then contact technical support.

Print speed is slow

If the "Before you troubleshoot" checklist does not solve the problem, then try one or more of the following:

MAXIMIZE COMPUTER PROCESSING SPEED

- Close all applications not in use.
- Minimize the number and size of graphics and images in the document.
- Remove as many unused fonts as possible from your system.

ADD MEMORY

Consider purchasing more RAM.

SELECT A LOWER PRINT QUALITY FROM THE PRINTER SOFTWARE

MANUALLY SELECT A PAPER TYPE THAT MATCHES THE TYPE OF PAPER YOU ARE USING

REMOVE AND REINSTALL THE PRINTER SOFTWARE

Computer slows down when printing

These are possible solutions. Try one of the following:

IF YOU ARE USING A **USB** CONNECTION, THEN TRY A DIFFERENT **USB** CABLE

IF YOU ARE ON A NETWORK, THEN RESET THE POWER OF THE ACCESS POINT (ROUTER)

- 1 Unplug the power cord from the access point.
- 2 Wait ten seconds, and then insert the power cord.

Copy and scan troubleshooting

- “Copier or scanner does not respond” on page 96
- “Scanner unit does not close” on page 96
- “Poor copy or scanned image quality” on page 96
- “Partial copies or scans of documents or photos” on page 97
- “Scan was not successful” on page 97
- “Scanning takes too long or freezes the computer” on page 97
- “Cannot scan to a computer over a network” on page 97

Copier or scanner does not respond

If the "Before you troubleshoot" checklist does not solve the problem, then try one or more of the following:

SET YOUR PRINTER AS THE DEFAULT PRINTER

REMOVE AND REINSTALL THE PRINTER SOFTWARE

Scanner unit does not close

- 1 Lift the scanner unit.
- 2 Remove any obstruction keeping the scanner unit open.
- 3 Lower the scanner unit.

Poor copy or scanned image quality

If the "Before you troubleshoot" checklist does not solve the problem, then try one or more of the following:

CLEAN THE SCANNER GLASS

ADJUST THE SCAN QUALITY FROM THE PRINTER SOFTWARE

REVIEW THE TIPS FOR COPYING, SCANNING, AND IMPROVING PRINT QUALITY

USE A CLEARER VERSION OF THE ORIGINAL DOCUMENT OR IMAGE

MAKE SURE THE DOCUMENT OR PHOTO IS LOADED FACEDOWN ON THE SCANNER GLASS AND IN THE CORRECT CORNER

Partial copies or scans of documents or photos

If the "Before you troubleshoot" checklist does not solve the problem, then try one or more of the following:

MAKE SURE THE DOCUMENT OR PHOTO IS LOADED FACEDOWN ON THE SCANNER GLASS AND IN THE CORRECT CORNER

SELECT A PAPER SIZE FROM THE PRINTER SOFTWARE THAT MATCHES THE LOADED PAPER

MAKE SURE THE ORIGINAL SIZE SETTING MATCHES THE SIZE OF THE DOCUMENT YOU ARE SCANNING

Scan was not successful

If the "Before you troubleshoot" checklist does not solve the problem, then try one or more of the following:

CHECK THE USB CONNECTION

- 1 Check the USB cable for any obvious damage. If the cable is damaged, then use a new one.
- 2 Firmly plug the square end of the USB cable into the back of the printer.
- 3 Firmly plug the rectangular end of the USB cable into the USB port of the computer.
The USB port is marked with a  USB symbol.

RESTART THE COMPUTER

Scanning takes too long or freezes the computer

If the "Before you troubleshoot" checklist does not solve the problem, then try one or more of the following:

CLOSE OTHER SOFTWARE PROGRAMS THAT ARE NOT BEING USED

USE A LOWER SCANNING RESOLUTION

Cannot scan to a computer over a network

If the "Before you troubleshoot" checklist does not solve the problem, then try one or more of the following:

MAKE SURE THE PRINTER AND THE DESTINATION COMPUTER ARE CONNECTED TO THE SAME NETWORK

MAKE SURE THE PRINTER SOFTWARE IS INSTALLED ON THE DESTINATION COMPUTER

Memory card troubleshooting

- “Memory card troubleshooting checklist” on page 98
- “Nothing happens when a memory card is inserted” on page 98
- “Cannot print documents from a memory card or flash drive” on page 98
- “Photos do not transfer from a memory card across a wireless network” on page 99

Memory card troubleshooting checklist

Before you troubleshoot, use the following checklist to solve most memory card problems:

- Make sure that the memory card you are using can be used in the printer.
- Make sure the memory card is not damaged.
- Make sure memory card contains supported file types.

Nothing happens when a memory card is inserted

If the "Memory card troubleshooting checklist" does not solve the problem, then try one or more of the following:

REINSERT THE MEMORY CARD

The memory card may have been inserted too slowly. Remove and then reinsert the memory card quickly.

CHECK THE USB CONNECTION

- 1 Check the USB cable for any obvious damage. If the cable is damaged, then use a new one.
- 2 Firmly plug the square end of the USB cable into the back of the printer.
- 3 Firmly plug the rectangular end of the USB cable into the USB port of the computer.
The USB port is marked with a  USB symbol.

CHECK THE NETWORK CONNECTION

If the printer and computer are connected over a network, then make sure that the correct host and device are communicating. Select the printer from the computer or the computer from the printer.

Cannot print documents from a memory card or flash drive

If the "Memory card troubleshooting checklist" does not solve the problem, then try the following:

CHECK THE USB CONNECTION

- 1 Check the USB cable for any obvious damage. If the cable is damaged, then use a new one.
- 2 Firmly plug the square end of the USB cable into the back of the printer.
- 3 Firmly plug the rectangular end of the USB cable into the USB port of the computer.
The USB port is marked with a  USB symbol.

CHECK THE NETWORK CONNECTION

If the printer and computer are connected over a network, then make sure that the correct host and device are communicating. Select the printer from the computer or the computer from the printer.

Photos do not transfer from a memory card across a wireless network

If the "Memory card troubleshooting checklist" does not solve the problem, then try one or more of the following:

MAKE SURE THAT BOTH THE PRINTER AND THE DESTINATION COMPUTER ARE TURNED ON AND READY

SELECT THE CORRECT COMPUTER NAME FROM THE LIST ON THE PRINTER

MAKE SURE YOUR WIRELESS NETWORK IS CONNECTED AND ACTIVE

If your wireless connection is down, then use a USB cable to connect your printer to your computer.

Wireless troubleshooting

- "Wireless troubleshooting checklist" on page 99
- "Resetting the wireless settings to factory defaults" on page 100
- "Cannot print over wireless network" on page 100
- "The Continue button is unavailable" on page 104
- "Cannot print and there is a firewall on the computer" on page 105
- "Wi-Fi indicator light is not lit" on page 105
- "Wi-Fi indicator light is green but the printer does not print (Windows only)" on page 106
- "Wi-Fi indicator light is still orange" on page 107
- "Wi-Fi indicator light is blinking orange during installation" on page 108
- "Wireless print server not installed" on page 112
- "'Communication not available' message displays when printing wirelessly" on page 112
- "Communication with printer lost when connected to Virtual Private Network (VPN)" on page 114
- "Resolving intermittent wireless communications issues" on page 115

Wireless troubleshooting checklist

Before beginning to troubleshoot the wireless printer, verify the following:

- The printer, the computer, and the wireless access point are all plugged in and turned on.
- The wireless network is working properly.

Try accessing other computers on your wireless network.

If your network has Internet access, try connecting to the Internet over a wireless connection.

- Your SSID is correct.

Print a network setup page to verify the SSID the printer is using.

If you are not sure if your SSID is correct, then run the wireless setup again.

- Your WEP key or WPA passphrase is correct (if your network is secure).

Log into the wireless access point (wireless router) and check the security settings.

A security key is like a password. All devices on the same wireless network using WEP, WPA, or WPA2 share the same security key.

If you are not sure if your security information is correct, run the wireless setup again.

- The printer and the computer are within the range of the wireless network.

For most networks, the printer and the computer should be within 100 feet (30 meters) of the wireless access point (wireless router).

- The Wi-Fi indicator light is lit and is solid green.

- The printer driver is installed on the computer from which you are performing a task.

- The correct printer port is selected.

- The computer and printer are both connected to the same wireless network.

- The printer is located away from obstacles or electronic devices that could interfere with the wireless signal.

Make sure the printer and wireless access point are not separated by poles, walls, or support columns containing metal or concrete.

Many devices can interfere with the wireless signal, including baby monitors, motors, cordless phones, security system cameras, other wireless networks, and some Bluetooth devices.

Resetting the wireless settings to factory defaults

1 From the printer control panel, press .

2 Press the arrow buttons to scroll to **Network Setup**, and then press .

3 Press the arrow buttons to scroll to **Reset Network Adapter to Factory Defaults**, and then press .

4 Press the arrow buttons to scroll to **Yes**, and then press .

The printer wireless settings are reset to factory default settings. To verify, print a network setup page.

Cannot print over wireless network

If you encountered problems while installing, or if your printer does not appear in the printers folder or as a printer option when sending a print job, then you can try uninstalling and reinstalling the software.

Before you reinstall the software, check the troubleshooting checklist, and then do the following:

TURN THE WIRELESS ACCESS POINT OFF AND THEN BACK ON

Turning the access point off and then back on again can sometimes refresh network connections and resolve connectivity issues.

DISCONNECT FROM VPN SESSION

When you are connected to another network through a VPN connection, you will not be able to access the printer over your wireless network. End your VPN session and try printing again.

MAKE SURE DEMO MODE IS TURNED OFF

Check to see if your printer has a Demo Mode. Selected printer features are not available when Demo Mode is turned on.

From the printer control panel, navigate to **Demo Mode**:

 > **Demo Mode**.

Select **Off**, and then save the setting.

CHECK YOUR WEP KEY OR WPA PASSPHRASE

If your wireless access point is using Wired Equivalent Privacy (WEP) security, then the WEP key should be:

- Exactly 10 or 26 hexadecimal characters. Hexadecimal characters are A–F, a–f, and 0–9.
or
- Exactly 5 or 13 ASCII characters. ASCII characters are letters, numbers, and symbols found on a keyboard. ASCII characters in a WEP key are case-sensitive.

If your wireless access point is using Wi-Fi Protected Access (WPA) security, then the WPA passphrase should be:

- From 8 to 63 ASCII characters. ASCII characters in a WPA passphrase are case-sensitive.
or
- Exactly 64 hexadecimal characters. Hexadecimal characters are A–F, a–f, and 0–9.

Note: If you do not know this information, then see the documentation that came with the wireless network, or contact the person who set up your wireless network.

CHECK IF YOUR WIRELESS ACCESS POINT HAS AN ASSOCIATION/REGISTRATION BUTTON

Wireless broadband boxes in Europe, the Middle East and Africa such as LiveBox, AliceBox, N9UF Box, FreeBox, or Club Internet may require you to press an association/registration button when adding the printer to your wireless network.

If you are using one of these boxes and need more information, see the documentation that came with your box, or contact your *Internet Service Provider* (ISP).

MOVE YOUR ACCESS POINT AWAY FROM OTHER ELECTRONIC DEVICES

There may be temporary interference from electronic devices such as microwave ovens or other appliances, cordless phones, baby monitors, and security system cameras. Make sure your access point is not positioned too closely to these devices.

MOVE THE COMPUTER AND/OR PRINTER CLOSER TO THE WIRELESS ROUTER

The range of your wireless network depends on many factors, including the abilities of your router and network adapters. If you are having trouble printing, try placing the computer and printer no more than 100 feet apart.

CHECK THE WIRELESS SIGNAL QUALITY

Print the network setup page and check the signal quality. If the signal quality is listed as good or excellent, then another factor is causing the problem.

CHECK YOUR ADVANCED SECURITY SETTINGS

- If you are using MAC (Media Access Control) address filtering to limit access to your wireless network, then you must add the printer MAC address to the list of addresses allowed to connect to the wireless access point.
- If you set the wireless access point to issue a limited number of IP addresses, then you must change this so that the printer can be added.

Note: If you do not know how to make these changes, then see the documentation that came with the wireless router, or contact the person who set up your wireless network.

MAKE SURE YOUR COMPUTER IS CONNECTED TO YOUR WIRELESS ACCESS POINT (WIRELESS ROUTER)

- See if you have access to the Internet by opening your Web browser and accessing any site.
- If there are other computers or resources on your wireless network, then check to see if you can access them from your computer.

MAKE SURE THAT YOUR COMPUTER AND PRINTER ARE CONNECTED TO THE SAME WIRELESS NETWORK

If the printer is not on the same wireless network as the computer, then you will not be able to print wirelessly. The SSID of the printer must match the SSID of the computer, if the computer is already connected to the wireless network.

For Windows users

- 1 Obtain the SSID of the network that the computer is connected to.
 - a Type the IP address of your wireless access point (wireless router) into the address field of your Web browser.

If you do not know the IP address of the wireless access point:

 - 1 Click , or click **Start** and then click **Run**.
 - 2 In the Start Search or Run box, type `cmd`.
 - 3 Press **Enter** or click **OK**.

The Command Prompt window opens.
 - 4 Type `ipconfig`, and then press **Enter**. Check the Wireless Network Connection section:
 - The "Default Gateway" entry is typically the wireless access point .
 - The IP address appears as four sets of numbers separated by periods, such as 192.168.2.134.
 - b Type the user name and password of the router when prompted.
 - c Click **OK**.
 - d On the main page, click **Wireless** or any other selection where settings are stored. The SSID will be displayed.
 - e Write down the SSID.

Note: Make sure you copy it exactly, including any capital letters.

- 2 Print the printer network setup page.
In the Wireless section, look for **SSID**.
- 3 Compare the SSID of the computer and SSID of the printer.
If the SSIDs are the same, then the computer and the printer are connected to the same wireless network.
If the SSIDs are not the same, then run the utility again to set up the printer on the wireless network used by the computer.

For Macintosh users with an AirPort base station

In Mac OS X version 10.5

- 1 From the Apple menu, choose **System Preferences**.
- 2 Click **Network**.
- 3 Click **AirPort**.
The SSID of the network the computer is connected to is displayed in the Network Name pop-up menu.
- 4 Write down the SSID.

In Mac OS X version 10.4 and earlier

- 1 From the Finder desktop, choose **Go > Applications**.
- 2 From the Applications folder, double-click **Internet Connect**.
- 3 From the toolbar, click **AirPort**.
The SSID of the network the computer is connected to is displayed in the Network pop-up menu.
- 4 Write down the SSID.

For Macintosh users with a wireless access point

- 1 Type the IP address of the wireless access point in the address field of your Web browser, and then continue to step 2.
If you do not know the IP address of the wireless access point, then do the following:
 - a From the Apple menu, choose **System Preferences**.
 - b Click **Network**.
 - c Click **AirPort**.
 - d Click **Advanced > TCP/IP** or **TCP/IP**.
The "Router" entry is typically the wireless access point.
- 2 Type your user name and password when prompted.
- 3 Click **OK**.
- 4 On the main page, click **Wireless** or another selection where settings are stored. The SSID will be displayed.
- 5 Write down the SSID, security type and the WEP key/WPA passphrase (if shown).

Notes:

- Make sure you copy the network information down exactly, including any capital letters.
- Store the SSID and the WEP key or WPA passphrase in a safe place for future reference.

MAKE SURE YOUR OS IS COMPATIBLE WITH WIRELESS PRINTING THROUGH AIRPORT

The printer only supports wireless printing through AirPort base stations for Mac OS X 10.5 or later.

The Continue button is unavailable

Try the following solutions in the order they appear until the Continue button becomes active and can be clicked:

CHECK IF THE USB CABLE IS SECURELY PLUGGED INTO THE USB PORTS ON BOTH THE COMPUTER AND THE PRINTER

USB ports are marked with the  symbol.

MAKE SURE THAT THE PRINTER IS PLUGGED IN AND TURNED ON

Check to see if the  button is lit. If you have just turned on the printer, then you might need to disconnect the USB cable and reconnect it.

MAKE SURE THAT THE USB PORT ON THE COMPUTER IS WORKING

Test the USB port by connecting other devices to it. If you can successfully use other devices from the port, then the port is working.

If the USB port on the computer is not working, then try using the other USB ports on the computer.

MAKE SURE THAT THE USB CABLE IS WORKING

Try using a different USB cable. If you are using a cable longer than 10 feet, then try using a shorter cable.

MAKE SURE THAT YOU ARE USING THE CORRECT CD FOR YOUR PRINTER MODEL

Compare the printer model on the CD to the printer model on the printer. The numbers should either match exactly or be within the same series.

If you have any doubts, look for an updated version of the printer software on our Web site. For more information, see "Installing the printer software" in the *User's Guide*. You can access the *User's Guide* from the link at the bottom of the installation screen.

RECONNECT THE POWER SUPPLY

- 1** Turn off the printer.
- 2** Unplug the power cord from the power outlet.
- 3** Remove the power supply from the back of the printer and then plug it back in.
- 4** Plug the power cord back into the power outlet.
- 5** Turn on the printer, and then resume the installation on your computer.

TRY RUNNING THE INSTALLER AGAIN

- 1 Close the installer.
- 2 Remove the CD, and then restart the computer.
- 3 Insert the CD and then run the installer again.

Notes:

- When you get to the **Software Already Installed** screen, make sure you select **Install a printer**.
- If you have already set up your printer, select **Additional Computer** when you get to the **Setting up a new printer?** screen to skip the hardware setup wizard.

CHECK THAT YOUR COMPUTER IS ABLE TO ACKNOWLEDGE USB ACTIVITY ON THE USB PORT

Open the Device Manager to check if it has activity whenever a USB device is connected to a USB port:

- 1 Click , or click **Start** and then click **Run**.
- 2 In the Start Search or Run box, type `devmgmt.msc`.
- 3 Press **Enter**, or click **OK**.
The Device Manager opens.
- 4 Watch the Device Manager window while connecting a USB cable or another device to the USB port. The window refreshes when Device Manager recognizes the USB connection.
 - If there is activity on Device Manager but none of the previous solutions worked, call Customer Support.
 - If there is no activity on Device Manager, there may be a problem with your computer and its USB support. The computer must recognize the USB connection in order for installation to work.

Cannot print and there is a firewall on the computer

Third-party (non-Microsoft) firewalls can interfere with wireless printing. If the printer and computer are configured correctly, and the wireless network is working, but the printer will not print wirelessly, then a firewall could be the problem. If there is a firewall (other than the Windows firewall) on the computer, try one or more of the following:

- Update the firewall using the most recent update available from the manufacturer. Refer to the documentation that came with your firewall for instructions on how to do this.
- If programs request firewall access when you install the printer or try to print, make sure you allow those programs to run.
- Temporarily disable the firewall and install the wireless printer on the computer. Re-enable the firewall when you have completed the wireless installation.

Wi-Fi indicator light is not lit

CHECK POWER

If the Wi-Fi indicator light is off, make sure the  light is on. If the  light is not on, check the following:

- Make sure the printer is plugged in and turned on.
- Make sure the printer is plugged into a working outlet.
- If the printer is plugged into a power strip, make sure it is turned on and working.

Wi-Fi indicator light is green but the printer does not print (Windows only)

If you have completed the configuration for wireless printing and all of the settings appear to be correct, but the printer does not print, then try one or more of the following:

ALLOW THE WIRELESS INSTALLATION TO COMPLETE

Do not attempt to print, remove the installation CD, or detach the installation cable until you see the Wireless Setup Successful screen.

ENABLE THE PRINTER

Confirm that the printer is enabled:

- 1 Click , or click **Start** and then click **Run**.
- 2 In the Start Search or Run box, type `control printers`.
- 3 Press **Enter**, or click **OK**.
The printer folder opens.
- 4 Right-click the new printer; from the menu, select **Use Printer Online**.
- 5 Close the Printers or Printers and Faxes window and try printing again.

SELECT THE WIRELESS PRINTER

You may need to select the wireless printer from your computer to use the printer wirelessly.

- 1 Click , or click **Start** and then click **Run**.
- 2 In the Start Search or Run box, type `control printers`.
- 3 Press **Enter**, or click **OK**.
The printer folder opens.
- 4 Right-click the printer in the folder with the matching name and model number followed by "(Network)."
- 5 Select **Use Printer Online** from the menu.
- 6 Close the Printers or Printers and Faxes window and try printing again.

SELECT THE WIRELESS PORT

If you have previously set up your printer as a locally attached printer, then you may need to select the wireless printer to use the printer wirelessly.

- 1 Click , or click **Start** and then click **Run**.
- 2 In the Start Search or Run box, type `control printers`.
- 3 Press **Enter**, or click **OK**.
The printer folder opens.
- 4 Right-click the printer, and then select **Properties** from the menu.

- 5 Click the **Ports** tab.
- 6 Locate the selected port. The selected port has a check beside it in the Port column.
- 7 If the Description column of the selected port indicates that it is a USB port, scroll through the list and select the port with Printer Port in the Description column. Check the printer model in the Printer column to make sure you select the right printer port.
- 8 Click **OK**, and then try to print again.

Wi-Fi indicator light is still orange

When the Wi-Fi indicator light is orange, it may indicate that the printer is:

- Not configured in infrastructure mode
- Waiting to make an ad hoc connection to another wireless device
- Not connected to a wireless network

The printer may be unable to join the network because of interference, its distance from the wireless access point (wireless router), or until its settings are changed.

These are possible solutions. Try one or more of the following:

CHECK NETWORK NAME

Make sure your network does not have the same name as another network near you. For example, if you and your neighbor both use a manufacturer's default network name, your printer could be connecting to your neighbor's network.

If you are not using a unique network name, consult the documentation for your wireless access point (wireless router) to learn how to set a network name.

If you set a new network name, you must reset the printer and computer SSID to the same network name.

CHECK SECURITY KEYS

If you are using WEP security

A valid WEP key is:

- Exactly 10 or 26 hexadecimal characters. Hexadecimal characters are A–F, a–f, and 0–9.
- or*
- Exactly 5 or 13 ASCII characters. ASCII characters are letters, numbers, and symbols found on a keyboard.

If you are using WPA security

A valid WPA passphrase is:

- From 8 to 63 ASCII characters. ASCII characters in a WPA passphrase are case-sensitive.
- or*
- Exactly 64 hexadecimal characters. Hexadecimal characters are A–F, a–f, and 0–9.

If your wireless network is not using security, then you will not have a security key. Using a wireless network with no security is not recommended because it can allow intruders to use your network resources without your consent.

MOVE THE COMPUTER AND/OR PRINTER CLOSER TO THE WIRELESS ACCESS POINT (WIRELESS ROUTER)

The possible distance between devices in 802.11b or 802.11g networks is 300 feet, while the wireless network range potentially doubles in 802.11n networks. The range of your wireless network depends on many factors, including the abilities of your router and network adapters. If you are having trouble printing, try placing the computer and printer no more than 100 feet apart.

You can find the strength of the network signal on the printer network setup page.

CHECK MAC ADDRESS

If your network uses MAC address filtering, make sure that you include the MAC address of the printer in the MAC address filter list. This will allow the printer to operate on the network.

Wi-Fi indicator light is blinking orange during installation

When the Wi-Fi indicator light is blinking orange, it indicates that the printer has been set up for wireless networking but cannot connect to the network for which it has been configured. The printer may be unable to join the network because of interference, its distance from the wireless access point (wireless router), or until its settings are changed.

These are possible solutions. Try one or more of the following:

MAKE SURE THE ACCESS POINT IS ON

Check the access point and, if necessary, turn it on.

MOVE YOUR ACCESS POINT TO MINIMIZE INTERFERENCE

There may be temporary interference from other devices such as microwave ovens or other appliances, cordless phones, baby monitors, and security system cameras. Make sure your access point is not positioned too closely to these devices.

MOVE THE COMPUTER AND/OR PRINTER CLOSER TO THE WIRELESS ACCESS POINT (WIRELESS ROUTER)

The possible distance between devices in 802.11b or 802.11g networks is 300 feet, while the wireless network range potentially doubles in 802.11n networks. The range of your wireless network depends on many factors, including the abilities of your router and network adapters. If you are having trouble printing, try placing the computer and printer no more than 100 feet apart.

You can find the signal strength of the network on the network setup page.

CHECK YOUR WEP KEY OR WPA PASSPHRASE

A WEP key or WPA passphrase is like a password. All devices on a WEP-secured wireless network must share the same WEP key, and all devices on a WPA-secured wireless network must share the same WPA passphrase.

Note: Make sure you copy it exactly, including any capital letters, and store it in a safe place for future reference.

If you are using WEP security

A valid WEP key is:

- Exactly 10 or 26 hexadecimal characters. Hexadecimal characters are A–F, a–f, and 0–9.
or
- Exactly 5 or 13 ASCII characters. ASCII characters are letters, numbers, and symbols found on a keyboard.

If you are using WPA security

A valid WPA passphrase is:

- From 8 to 63 ASCII characters. ASCII characters in a WPA passphrase are case-sensitive.
or
- Exactly 64 hexadecimal characters. Hexadecimal characters are A–F, a–f, and 0–9.



If your wireless network is not using security, then you will not have a security key. Using a wireless network with no security is not recommended because it can allow intruders to use your network resources without your consent.

CHECK MAC ADDRESS

If your network uses MAC address filtering, make sure that you include the MAC address of the printer in the MAC address filter list. This will allow the printer to operate on the network. For more information, see “How do I find the MAC address?” on page 81.

PING THE ACCESS POINT TO MAKE SURE THE NETWORK IS WORKING

For Windows users

- 1 If you do not already know it, find the IP address of the access point:
 - a Click , or click **Start** and then click **Run**.
 - b In the Start Search or Run box, type `cmd`.
 - c Press **Enter**, or click **OK**.
The Command Prompt window opens.
 - d Type `ipconfig`, and then press **Enter**.
 - The “Default Gateway” entry is typically the wireless access point.
 - The IP address appears as four sets of numbers separated by periods, such as 192.168.2.134.
- 2 Ping the access point:
 - a Click , or click **Start** and then click **Run**.
 - b In the Start Search or Run box, type `cmd`.
 - c Press **Enter**, or click **OK**.
The Command Prompt window opens.
 - d Type `ping` followed by a space and the IP address of the wireless access point. For example:
`ping 192.168.1.100`
 - e Press **Enter**.

3 Check to see whether the access point responds:

- If the access point responds, you will see several lines appear that start with “Reply from.”
It is possible that the printer did not connect to the wireless network. Turn off and then restart the printer to try to connect again.
- If the access point does not respond, it will take several seconds and then you will see “Request timed out.”

Try the following:

- a Click , or click **Start** and then click **Run**.
- b In the Start Search or Run box, type `ncpa.cp1`, and then press **Enter**.
- c Press **Enter** or click **OK**.
- d Select the appropriate connection from the ones shown.
- e Right-click the connection, and then click **Repair**.

For Macintosh users

1 Make sure AirPort is turned on:

- a From the Apple menu, choose **System Preferences**.
- b Click **Network**.

The AirPort status indicator should be green.

Notes:

- Yellow means the port is active but not connected.
- Red means the port has not been configured.

2 Obtain the IP address of the wireless access point:

- a From the Apple menu, choose **About This Mac**.
- b Click **More Info**.
- c From the Contents pane, choose **Network**.
- d From the Active Services list, choose **AirPort**.
The bottom pane lists the details of the AirPort connection.
- e Write down the “Router” entry. This is typically the wireless access point.

3 Ping the wireless access point:

- a From the Finder desktop, choose **Go > Utilities**.
- b Double-click **Network Utility**.
- c Click the **Ping** tab.
- d In the network address field, type the IP address of the wireless access point (or router). For example:
`10.168.1.101`
- e Click **Ping**.

4 If the wireless access point responds, you will see several lines that display the number of bytes received from the wireless access point. This ensures that your computer is connected to the wireless access point.

If the wireless access point does not respond, then nothing is displayed. You can use Network Diagnostics to help resolve the problem.

MAKE SURE YOUR COMPUTER CAN COMMUNICATE WITH THE PRINTER

For Windows users

- 1 Obtain the printer IP address by printing a network setup page.
- 2 Click , or click **Start** and then click **Run**.
- 3 In the Start Search or Run box, type `cmd`.
- 4 Press **Enter**, or click **OK**.
The Command Prompt window opens.
- 5 Type `ping` followed by a space and the IP address of the printer. For example:
`ping 192.168.1.100`
- 6 Press **Enter**.
- 7 If the printer responds, you will see several lines that display the number of bytes received from the printer. This ensures that your computer is communicating with your printer.
If the printer does not respond, then “Request timed out” displays.
 - Your computer might not be connected to the network.
 - You may need to change the settings of your printer. Run the Wireless Setup Utility again.

For Macintosh users

- 1 Obtain the printer IP address by printing a network setup page.
In the TCP/IP section, look for **Address**.
- 2 From the Finder desktop, choose **Go > Utilities**.
- 3 Double-click **Network Utility**.
- 4 Click the **Ping** tab.
- 5 Type the IP address of the printer in the network address field. For example:
`10.168.1.101`
- 6 Click **Ping**.
- 7 If the printer responds, you will see several lines that display the number of bytes received from the printer. This ensures that your computer is communicating with your printer.
If the printer does not respond, then nothing is displayed.
 - Your computer might not be connected to the network. You can use Network Diagnostics to help resolve the problem.
 - You may need to change the settings of your printer. Run the Wireless Setup Assistant again.

CONFIGURE THE PRINTER FOR WIRELESS ACCESS AGAIN

If your wireless settings have changed, you must run the printer wireless setup again. Some reasons your settings may have changed include your having manually changed your WEP or WPA keys, channel, or other network settings; or the access point having been reset to factory defaults.

Running the wireless setup again can also resolve issues due to misconfigurations that occurred when configuring the printer for wireless access.

Notes:

- If you change network settings, change them on all the network devices before changing them for the access point.
- If you have already changed the wireless network settings on your access point, then you must change the settings on all the other network devices before you can see them on the network.

For Windows users

- 1 Click  or **Start**.
- 2 Click **All Programs** or **Programs**, and then select the printer program folder from the list.
- 3 Select **Printer Home**.
- 4 Click the **Settings** tab.
- 5 Click the **Wireless setup utility** link.

Note: You may be prompted to connect the printer to the computer again using the installation cable as part of the setup process.

- 6 Follow the instructions on the computer screen.

For Macintosh users

- 1 From the Finder desktop, double-click the printer folder.
- 2 Double-click **Wireless Setup Assistant**.
- 3 Follow the instructions on the computer screen.

Wireless print server not installed

You may see a message during installation indicating that the printer does not have a wireless print server installed. If you are sure the printer is capable of wireless printing, try the following:

CHECK POWER

Make sure the  light is on.

“Communication not available” message displays when printing wirelessly

These are possible solutions. Try one or more of the following:

MAKE SURE YOUR COMPUTER AND PRINTER HAVE VALID IP ADDRESSES FOR THE NETWORK

If you are using a laptop and have power saving settings enabled, you may see the “Communication not available” message on your computer screen when you attempt to print wirelessly. This can occur if the laptop hard drive has powered down.

If you see this message, wait a few seconds and then try to print again. The laptop and printer require a few seconds to power up again and reattach to the wireless network.

If you see this message again after you have waited long enough for the printer and the laptop to attach to the network, there may be a problem with your wireless network.

Make sure that the laptop and printer have both received IP addresses:

For Windows users

- 1 Click , or click **Start** and then click **Run**.
- 2 In the Start Search or Run box, type `cmd`.
- 3 Press **Enter**, or click **OK**.

The Command Prompt window opens.

- 4 Type `ipconfig`, and then press **Enter**.

The IP address appears as four sets of numbers separated by periods, such as 192.168.0.100.

For Macintosh users

- 1 From the Apple menu, choose **About This Mac**.
- 2 Click **More Info**.
- 3 From the Contents pane, choose **Network**.
- 4 If you are connected over a wireless network, choose **AirPort** from the Active Services list.

How to locate a printer IP address

- You can locate the printer IP address by viewing the printer network setup page.

If the printer and/or the laptop does not have an IP address, or if either has an address of 169.254.x.y (where x and y are any two numbers between 0 and 255):

- 1 Turn off the device that does not have a valid IP address (the laptop, the printer, or both).
- 2 Turn on the device(s).
- 3 Check the IP addresses again.

If the laptop and/or printer still does not receive a valid IP address, there is a problem with your wireless network. Try the following:

- Make sure your wireless access point (wireless router) is turned on and is working.
- Remove any objects that could be blocking the signal.
- Temporarily turn off any unnecessary wireless devices on your network and pause any network-intensive activities, like large file transfers or network games. If the network is too busy, it is possible that the printer is not receiving the IP address within the allowed time.
- Make sure your DHCP server, which may also be your wireless router, is working and is configured to assign IP addresses. If you are not sure how to do this, refer to the manual that came with your wireless router for more information.

If the printer and computer have valid IP addresses and the network is operation correctly, continue troubleshooting.

MAKE SURE THE WIRELESS PORT IS SELECTED

Note: This solution applies to Windows users only

- 1 Click , or click **Start** and then click **Run**.
- 2 In the Start Search or Run box, type `control printers`.

- 3 Press **Enter**, or click **OK**.
The printer folder opens.
- 4 Right-click the printer, and then select **Properties** from the menu.
- 5 Click the **Ports** tab.
- 6 Locate the selected port. The selected port has a check beside it in the Port column.
- 7 If the Description column of the selected port indicates that it is a USB port, scroll through the list and select the port with Printer Port in the Description column. Check the printer model in the Printer column to make sure you select the right printer port.
- 8 Click **OK**, and then try to print again.

MAKE SURE BIDIRECTIONAL COMMUNICATION IS ENABLED

Note: This solution applies to Windows users only

- 1 Click , or click **Start** and then click **Run**.
- 2 In the Start Search or Run box, type `control printers`.
- 3 Press **Enter**, or click **OK**.
The printer folder opens.
- 4 Right-click the printer, and then select **Properties** from the menu.
- 5 Click the **Ports** tab.
- 6 Click the box next to **Enable bidirectional support** if it is not already checked.
- 7 Click **Apply**.
- 8 Click **OK**, and then try to print again.

Communication with printer lost when connected to Virtual Private Network (VPN)

You will lose your connection to a wireless printer on your local network when connected to most *Virtual Private Networks* (VPNs). Most VPNs allow users to communicate with only the VPN and no other network at the same time. If you would like to have the ability to connect to your local network and to a VPN at the same time, the system support person for the VPN must enable split tunneling. Be aware that some organizations will not allow split tunneling due to security or technical concerns.

Resolving intermittent wireless communications issues

You may notice that your printer works for a short time and then stops working, although apparently nothing has changed on your wireless network.

Many different issues can interrupt network communications, and sometimes more than one problem exists at the same time. These are possible solutions. Try one or more of the following:

DISCONNECT FROM ALL VPNs WHEN ATTEMPTING TO USE THE WIRELESS NETWORK

Most Virtual Private Networks (VPNs) allow computers to communicate with only the VPN and no other network at the same time. Disconnect from the VPN before installing the driver on the computer or before running the wireless setup on the computer.

To check if the computer is currently connected to a VPN, open your VPN Client software and check your VPN connections. If you do not have a VPN Client software installed, check the connections manually using the Windows VPN Client.

If you would like to have the ability to connect to your local network and to a VPN at the same time, the system support person for the VPN must enable split tunneling. Be aware that some organizations will not allow split tunneling due to security or technical concerns.

TURN OFF THE WIRELESS ACCESS POINT (WIRELESS ROUTER) AND TURN IT BACK ON AGAIN

ELIMINATE NETWORK CONGESTION

If a wireless network is too busy, the computer and printer may have difficulty communicating with each other. Some causes of wireless network congestion can include:

- Transferring large files across the network
- Networked games
- Peer-to-peer file swapping applications
- Streaming video
- Too many computers on the wireless network at once

ELIMINATE SOURCES OF INTERFERENCE

Common household items can potentially disrupt wireless network communications. Cordless phones (but not cellular phones), microwave ovens, baby monitors, almost any kitchen appliance, wireless surveillance equipment, nearby wireless networks, and any appliance containing a motor can disrupt wireless network communications.

Try turning on any potential sources of interference and see if it causes the problem. If it does, separate your wireless network from the device.

CHANGE THE CHANNEL THE WIRELESS ROUTER USES

You can sometimes eliminate interference from unknown sources by changing the channel your wireless router uses to broadcast. There are three distinct channels on a router. Check the documentation that came with your router to determine which three apply. Other channels are offered as options, but these overlap. If the router is configured to use the default settings, change the channel setting to use a different distinct channel. Refer to the manual that came with your wireless router if you are not sure how to change the channel.

CONFIGURE THE WIRELESS ROUTER WITH A UNIQUE SSID

Many wireless networks use the SSID that the router was originally configured by the manufacturer to use. Using the default SSID can cause problems when more than one network is operating in the same area with the same SSID. The printer or computer may attempt to attach to the wrong network, although it will appear to be trying to connect to the correct network.

To avoid this type of interference, change the SSID on your wireless router from the default. Refer to the manual that came with your router if you are not sure how to change the SSID.

Note: You must change the SSID on all of the other devices that access your wireless network if you change the SSID on the router.

ASSIGN STATIC IP ADDRESSES TO ALL DEVICES IN THE NETWORK

Most wireless networks use a DHCP server (dynamic host configuration protocol) built in to the wireless router to assign IP addresses to clients on the wireless network. DHCP addresses are assigned when they are needed, as when a new device is added to the wireless network or when it is powered on. Wireless devices must send a request to the router, and receive an IP address in response so they can function on the network. Because the router performs many other tasks besides assigning addresses, it sometimes does not respond quickly enough with an address. The requesting device sometimes gives up before it receives an address.

Try assigning static IP addresses to the devices in your network to resolve this issue. Static IP addresses cut down on the work your wireless router has to do. Refer to the manual that came with your router and your operating system documentation if you are not sure how to assign static IP addresses.

To assign a static IP address to the printer, do the following:

- 1 Complete the wireless setup, allowing the printer to receive a DHCP address from a DHCP server on the network.
- 2 Print a network setup page to see what IP address is currently assigned to the printer.
- 3 Open a Web browser and then type the printer IP address in the address field. Press **Enter**.
The printer Web page loads.
- 4 Click the **Configuration** link.
- 5 Click the **TCP/IP** link.
- 6 Click the **Set Static IP Address** link.
- 7 Type the IP address you want to assign to the printer in the **IP Address** field.
- 8 Click the **Submit** button.

The Submitting Selection message appears.

Confirm that the IP address is updated by typing the static IP address in the browser address field and checking to see if the printer Web page reloads.

CHECK FOR KNOWN ISSUES WITH THE WIRELESS ROUTER

Some wireless routers have documented defects that were identified and resolved by the manufacturers. Visit the company Web site of the router manufacturer. Check for firmware updates and other advice from the manufacturer. Check the manual that came with your wireless router if you are not sure how to reach the manufacturer Web site.

CHECK FOR WIRELESS ADAPTER UPDATES

If you are having trouble printing from one particular computer, check the Web site of the manufacturer of the network adapter card in that computer. It is possible that there is an updated driver available that could resolve the issue.

CHANGE ALL NETWORK DEVICES TO THE SAME TYPE

While it is possible to successfully mix 802.11b, 802.11g, and 802.11n devices on the same wireless network, the faster devices will sometimes prevent the slower devices from communicating. Wireless devices are designed to wait for a gap in wireless network communications before attempting to send information. If newer, faster devices are constantly using the wireless network, then older, slower devices will not have a chance to send data.

Try only turning on the network devices of the same type and see if network communications improve. If this solves the problem, you may want to upgrade your older devices with newer network adapters.

PURCHASE A NEW ROUTER

If your router is several years old, it may not be fully compatible with the newer wireless devices on your network. Consider purchasing a newer router that is fully compliant with the 802.11 IEEE specifications.

Notices

Product information

Product name:

Lexmark S300 Series

Machine type:

4443

Model(s):

101, 10E

Edition notice

April 2009

The following paragraph does not apply to any country where such provisions are inconsistent with local law: LEXMARK INTERNATIONAL, INC., PROVIDES THIS PUBLICATION "AS IS" WITHOUT WARRANTY OF ANY KIND, EITHER EXPRESS OR IMPLIED, INCLUDING, BUT NOT LIMITED TO, THE IMPLIED WARRANTIES OF MERCHANTABILITY OR FITNESS FOR A PARTICULAR PURPOSE. Some states do not allow disclaimer of express or implied warranties in certain transactions; therefore, this statement may not apply to you.

This publication could include technical inaccuracies or typographical errors. Changes are periodically made to the information herein; these changes will be incorporated in later editions. Improvements or changes in the products or the programs described may be made at any time.

References in this publication to products, programs, or services do not imply that the manufacturer intends to make these available in all countries in which it operates. Any reference to a product, program, or service is not intended to state or imply that only that product, program, or service may be used. Any functionally equivalent product, program, or service that does not infringe any existing intellectual property right may be used instead. Evaluation and verification of operation in conjunction with other products, programs, or services, except those expressly designated by the manufacturer, are the user's responsibility.

For Lexmark technical support, visit support.lexmark.com.

For information on supplies and downloads, visit www.lexmark.com.

If you don't have access to the Internet, you can contact Lexmark by mail:

Lexmark International, Inc.
Bldg 004-2/CSC
740 New Circle Road NW
Lexington, KY 40550
USA

© 2009 Lexmark International, Inc.

All rights reserved.

UNITED STATES GOVERNMENT RIGHTS

This software and any accompanying documentation provided under this agreement are commercial computer software and documentation developed exclusively at private expense.

Trademarks

Lexmark and Lexmark with diamond design are trademarks of Lexmark International, Inc., registered in the United States and/or other countries.

PerfectFinish is a trademark of Lexmark International, Inc.

All other trademarks are the property of their respective owners.

Licensing notices

The following documents can be viewed from the installation software CD.

Directory	File
\Pubs	FW_License.12.08.pdf mDNS.tar.gz
\Install\Licenses	Expat.txt Inst_lib.txt Instgui.txt Instgui.zip

Federal Communications Commission (FCC) compliance information statement

This product has been tested and found to comply with the limits for a Class B digital device, pursuant to Part 15 of the FCC Rules. Operation is subject to the following two conditions: (1) this device may not cause harmful interference, and (2) this device must accept any interference received, including interference that may cause undesired operation.

The FCC Class B limits are designed to provide reasonable protection against harmful interference when the equipment is operated in a residential installation. This equipment generates, uses, and can radiate radio frequency energy and, if not installed and used in accordance with the instructions, may cause harmful interference to radio communications. However, there is no guarantee that interference will not occur in a particular installation. If this equipment does cause harmful interference to radio or television reception, which can be determined by turning the equipment off and on, the user is encouraged to try to correct the interference by one or more of the following measures:

- Reorient or relocate the receiving antenna.
- Increase the separation between the equipment and receiver.
- Connect the equipment into an outlet on a circuit different from that to which the receiver is connected.
- Consult your point of purchase or service representative for additional suggestions.

The manufacturer is not responsible for radio or television interference caused by using other than recommended cables or by unauthorized changes or modifications to this equipment. Unauthorized changes or modifications could void the user's authority to operate this equipment.

Note: To assure compliance with FCC regulations on electromagnetic interference for a Class B computing device, use a properly shielded and grounded cable such as Lexmark part number 1021294 for USB attach. Use of a substitute cable not properly shielded and grounded may result in a violation of FCC regulations.

Any questions regarding this compliance information statement should be directed to:

Director of Lexmark Technology & Services
 Lexmark International, Inc.
 740 West New Circle Road
 Lexington, KY 40550
 (859) 232-3000

Hinweis zum GS-Zeichen

Modell	101, 10E
Gerätetyp	4443
Postanschrift	Lexmark Deutschland GmbH Postfach 1560 63115 Dietzenbach
Adresse	Lexmark Deutschland GmbH Max-Planck-Straße 12 63128 Dietzenbach
Telefon	0180 - 564 56 44 (Produktinformationen)
Telefon	01805- 51 25 11 (Technischer Kundendienst)
E-mail	internet@lexmark.de

Noise emission levels

The following measurements were made in accordance with ISO 7779 and reported in conformance with ISO 9296.

Note: Some modes may not apply to your product.

1-meter average sound pressure, dBA	
Printing	50 dBA
Scanning	35 dBA
Copying	47 dBA
Ready	inaudible

Values are subject to change. See www.lexmark.com for current values.

Temperature information

Ambient temperature	15–32° C (60–90° F)
Shipping temperature	-40–60° C (-40–140° F)
Storage temperature	1–60° C (34–140° F)

Waste from Electrical and Electronic Equipment (WEEE) directive



The WEEE logo signifies specific recycling programs and procedures for electronic products in countries of the European Union. We encourage the recycling of our products. If you have further questions about recycling options, visit the Lexmark Web site at www.lexmark.com for your local sales office phone number.

Product disposal

Do not dispose of the printer or supplies in the same manner as normal household waste. Consult your local authorities for disposal and recycling options.

Battery notice

This product contains Perchlorate material. Special handling may apply. For more information, go to <http://www.dtsc.ca.gov/hazardouswaste/perchlorate/>.

ENERGY STAR

Any Lexmark product bearing the ENERGY STAR emblem on the product or on a start-up screen is certified to comply with Environmental Protection Agency (EPA) ENERGY STAR requirements as configured when shipped by Lexmark.



Power consumption

Product power consumption

The following table documents the power consumption characteristics of the product.

Note: Some modes may not apply to your product.

Mode	Description	Power consumption (Watts)
Printing	The product is generating hard-copy output from electronic inputs.	17.01
Copying	The product is generating hard-copy output from hard-copy original documents.	10.31
Scanning	The product is scanning hard-copy documents.	9.37
Ready	The product is waiting for a print job.	6.95
Power Saver	The product is in energy-saving mode.	3.33
Off	The product is plugged into a wall outlet, but the power switch is turned off.	0.33

The power consumption levels listed in the previous table represent time-averaged measurements. Instantaneous power draws may be substantially higher than the average.

Values are subject to change. See www.lexmark.com for current values.

Power Saver

This product is designed with an energy-saving mode called Power Saver. The Power Saver Mode is equivalent to the Sleep Mode. The Power Saver Mode saves energy by lowering power consumption during extended periods of inactivity. The Power Saver Mode is automatically engaged after this product is not used for a specified period of time, called the Power Saver Timeout.

Factory default Power Saver Timeout for this product (in minutes):	10
--	----

By using the configuration menus, the Power Saver Timeout can be modified between 1 minute and 240 minutes. Setting the Power Saver Timeout to a low value reduces energy consumption, but may increase the response time of the product. Setting the Power Saver Timeout to a high value maintains a fast response, but uses more energy.

Off mode

If this product has an off mode which still consumes a small amount of power, then to completely stop product power consumption, disconnect the power supply cord from the wall outlet.

Total energy usage

It is sometimes helpful to calculate the total product energy usage. Since power consumption claims are provided in power units of Watts, the power consumption should be multiplied by the time the product spends in each mode in order to calculate energy usage. The total product energy usage is the sum of each mode's energy usage.

European Community (EC) directives conformity

This product is in conformity with the protection requirements of EC Council directives 2004/108/EC and 2006/95/EC on the approximation and harmonization of the laws of the Member States relating to electromagnetic compatibility and safety of electrical equipment designed for use within certain voltage limits.

A declaration of conformity with the requirements of the directives has been signed by the Director of Manufacturing and Technical Support, Lexmark International, Inc., S.A., Boigny, France.

This product satisfies the Class B limits of EN 55022 and safety requirements of EN 60950.

Industry Canada compliance statement

This Class B digital apparatus meets all requirements of the Canadian Interference-Causing Equipment Standard ICES-003.

Avis de conformité aux normes de l'industrie du Canada

Cet appareil numérique de classe B est conforme aux exigences de la norme canadienne relative aux équipements pouvant causer des interférences NMB-003.

Regulatory notices for telecommunication terminal equipment

This section contains regulatory information pertaining to products that contain telecommunication terminal equipment such as facsimile.

Notice to users of the US telephone network: FCC requirements

This equipment complies with Part 68 of the FCC rules and the requirements adopted by the Administrative Council for Terminal Attachments (ACTA). On the back of this equipment is a label that contains, among other information, a product identifier in the format US:AAAEQ##TXXXX. If requested, this number must be provided to your telephone company.

This equipment uses the RJ-11C Universal Service Order Code (USOC) jack.

A plug and jack used to connect this equipment to the premises' wiring and telephone network must comply with the applicable FCC Part 68 rules and requirements adopted by the ACTA. A compliant telephone cord and modular plug is provided with this product. It is designed to be connected to a compatible modular jack that is also compliant. See your setup documentation for more information.

The Ringer Equivalence Number (REN) is used to determine the number of devices that may be connected to a telephone line. Excessive RENs on a telephone line may result in the devices not ringing in response to an incoming call. In most but not all areas, the sum of RENs should not exceed five (5.0). To be certain of the number of devices that may be connected to a line, as determined by the total RENs, contact your local telephone company. For products approved after July 23, 2001, the REN for this product is part of the product identifier that has the format US:AAAEQ##TXXXX. The digits represented by ## are the REN without a decimal point (for example, 03 is a REN of 0.3). For earlier products, the REN is shown separately on the label.

If this equipment causes harm to the telephone network, the telephone company will notify you in advance that temporary discontinuance of service may be required. If advance notice is not practical, the telephone company will notify the customer as soon as possible. You will also be advised of your right to file a complaint with the FCC.

The telephone company may make changes in its facilities, equipment, operations or procedures that could affect the operation of this equipment. If this happens, the telephone company will provide advance notice in order for you to make necessary modifications to maintain uninterrupted service.

If you experience trouble with this equipment, for repair or warranty information, contact Lexmark International, Inc. at **www.lexmark.com** or your Lexmark representative. If the equipment is causing harm to the telephone network, the telephone company may request that you disconnect the equipment until the problem is resolved.

This equipment contains no user serviceable parts. For repair and warranty information, contact Lexmark International, Inc. See the previous paragraph for contact information.

Connection to party line service is subject to state tariffs. Contact the state public utility commission, public service commission, or corporation commission for information.

If your home has specially wired alarm equipment connected to the telephone line, ensure the installation of this equipment does not disable your alarm equipment. If you have questions about what will disable alarm equipment, consult your telephone company or a qualified installer.

Telephone companies report that electrical surges, typically lightning transients, are very destructive to customer terminal equipment connected to AC power sources. This has been identified as a major nationwide problem. It is recommended that the customer install an appropriate AC surge arrester in the AC outlet to which this device is connected. An appropriate AC surge arrester is defined as one that is suitably rated, and certified by UL (Underwriter's Laboratories), another NRTL (Nationally Recognized Testing Laboratory), or a recognized safety certification body in the country/region of use. This is to avoid damage to the equipment caused by local lightning strikes and other electrical surges.

The Telephone Consumer Protection Act of 1991 makes it unlawful for any person to use a computer or other electronic device, including fax machines, to send any message unless said message clearly contains in a margin at the top or bottom of each transmitted page or on the first page of the transmission, the date and time it is sent and an identification of the business or other entity, or other individual sending the message, and the telephone number of the sending machine or such business, other entity, or individual. (The telephone number provided may not be a 900 number or any other number for which charges exceed local or long-distance transmission charges.)

See your user documentation in order to program this information into your fax machine.

South Africa telecommunications notice

This modem must be used in conjunction with an approved surge protection device when connected to the PSTN.

Notice to users of the Canadian telephone network

This product meets the applicable Industry Canada technical specifications. The Ringer Equivalence Number (REN) is an indication of the maximum number of terminals allowed to be connected to a telephone interface. The terminus of an interface may consist of any combination of devices, subject only to the requirement that the sum of the RENs of all the devices does not exceed five. The modem REN is located on the rear of the equipment on the product labeling.

Telephone companies report that electrical surges, typically lightning transients, are very destructive to customer terminal equipment connected to AC power sources. This has been identified as a major nationwide problem. It is recommended that the customer install an appropriate AC surge arrester in the AC outlet to which this device is connected. An appropriate AC surge arrester is defined as one that is suitably rated, and certified by UL (Underwriter's Laboratories), another NRTL (Nationally Recognized Testing Laboratory), or a recognized safety certification body in the country/region of use. This is to avoid damage to the equipment caused by local lightning strikes and other electrical surges.

This equipment uses CA11A telephone jacks.

Avis réservé aux utilisateurs du réseau téléphonique du Canada

Ce produit est conforme aux spécifications techniques d'Industrie Canada. Le numéro REN (ringer equivalence number : numéro d'équivalence de sonnerie) fournit une indication du nombre maximum de terminaux pouvant être connectés à l'interface téléphonique. En bout de ligne, le nombre d'appareils qui peuvent être connectés n'est pas directement limité, mais la somme des REN de ces appareils ne doit pas dépasser cinq. Le numéro REN du modem est indiqué sur l'étiquette produit située à l'arrière de l'équipement.

Les compagnies de téléphone constatent que les surtensions électriques, en particulier celles dues à la foudre, entraînent d'importants dégâts sur les terminaux privés connectés à des sources d'alimentation CA. Il s'agit-là d'un problème majeur d'échelle nationale. En conséquence, il vous est recommandé de brancher un parasurtenseur dans la prise de courant à laquelle l'équipement est connecté. Utilisez un parasurtenseur répondant à des caractéristiques nominales satisfaisantes et certifié par le laboratoire d'assureurs UL (Underwriter's Laboratories), un autre laboratoire agréé de type NRTL (Nationally Recognized Testing Laboratory) ou un organisme de certification agréé dans votre région ou pays. Ceci prévient tout endommagement de l'équipement causé par les orages et autres surtensions électriques.

Cet équipement utilise des prises de téléphone CA11A.

Notice to users of the New Zealand telephone network

The following are special conditions for the Facsimile User Instructions. The grant of a telepermit for any item of terminal equipment indicates only that Telecom has accepted that the item complies with minimum conditions for connection to its network. It indicates no endorsement of the product by Telecom, nor does it provide any sort of warranty. Above all, it provides no assurance that any item will work correctly in all respects with another item of telepermitted equipment of a different make or model, nor does it imply that any product is compatible with all of Telecom's network services.

This equipment shall not be set up to make automatic calls to the Telecom's 111 Emergency Service.

This equipment may not provide for the effective hand-over of a call to another device connected to the same line.

This equipment should not be used under any circumstances that may constitute a nuisance to other Telecom customers.

Some parameters required for compliance with Telecom's telepermit requirements are dependent on the equipment associated with this device. The associated equipment shall be set to operate within the following limits for compliance to Telecom's specifications:

- There shall be no more than 10 call attempts to the same number within any 30 minute period for any single manual call initiation, and
- The equipment shall go on-hook for a period of not less than 30 seconds between the end of one attempt and the beginning of the next call attempt.

- The equipment shall be set to ensure that automatic calls to different numbers are spaced such that there is not less than 5 seconds between the end of one call attempt and the beginning of another.

Using this product in Switzerland

This product requires a Swiss billing tone filter (Lexmark part number 14B5109 or 80D1877) to be installed on any line which receives metering pulses in Switzerland. The Lexmark filter must be used, as metering pulses are present on all analog telephone lines in Switzerland.

Utilisation de ce produit en Suisse

Cet appareil nécessite l'utilisation d'un filtre de tonalité de facturation suisse (n° de référence Lexmark : 14B5109 ou 80D1877) devant être installé sur toute ligne recevant des impulsions de comptage en Suisse. Ce filtre doit être utilisé pour toute installation car ces impulsions existent sur toutes les lignes téléphoniques suisses.

Verwendung dieses Produkts in der Schweiz

Für dieses Produkt muss ein schweizerischer Billing Tone Filter zur Zählzeichenübertragung (Lexmark Teilenummer 14B5109 oder 80D1877) für jede Leitung installiert werden, über die in der Schweiz Zeitsteuertakte übertragen werden. Die Verwendung des Lexmark Filters ist obligatorisch, da in allen analogen Telefonleitungen in der Schweiz Zeitsteuertakte vorhanden sind.

Uso del prodotto in Svizzera

Questo prodotto richiede un filtro toni Billing svizzero, (codice Lexmark 14B5109 o 80D1877) da installare su tutte le linee che ricevono impulsi remoti in Svizzera. È necessario utilizzare il filtro Lexmark poiché gli impulsi remoti sono presenti su tutte le linee analogiche in Svizzera.

Notice to Users in the European Union

Products bearing the CE mark are in conformity with the protection requirements of EC Council directives 2004/108/EC, 2006/95/EC, and 1999/5/EC on the approximation and harmonization of the laws of the Member States relating to electromagnetic compatibility, safety of electrical equipment designed for use within certain voltage limits and on radio equipment and telecommunications terminal equipment.

Compliance is indicated by the CE marking.



A declaration of conformity with the requirements of the directives is available from the Director of Manufacturing and Technical Support, Lexmark International, S. A., Boigny, France.

Refer to the table at the end of the Notices section for further compliance information.

Regulatory notices for wireless products

This section contains the following regulatory information pertaining to wireless products that contain transmitters, for example, but not limited to, wireless network cards or proximity card readers.

Exposure to radio frequency radiation

The radiated output power of this device is far below the radio frequency exposure limits of the FCC and other regulatory agencies. A minimum separation of 20 cm (8 inches) must be maintained between the antenna and any persons for this device to satisfy the RF exposure requirements of the FCC and other regulatory agencies.

Notice to users in Brazil

Este equipamento opera em caráter secundário, isto é, não tem direito a proteção contra interferência prejudicial, mesmo de estações do mesmo tipo, e não pode causar interferência a sistemas operando em caráter primário. (Res. ANATEL 282/2001).

Industry Canada (Canada)

This device complies with Industry Canada specification RSS-210. Operation is subject to the following two conditions: (1) this device may not cause interference, and (2) this device must accept any interference, including interference that may cause undesired operation of the device.

This device has been designed to operate only with the antenna provided. Use of any other antenna is strictly prohibited per regulations of Industry Canada.

To prevent radio interference to the licensed service, this device is intended to be operated indoors and away from windows to provide maximum shielding. Equipment (or its transmit antenna) that is installed outdoors is subject to licensing.

The installer of this radio equipment must ensure that the antenna is located or pointed such that it does not emit RF fields in excess of Health Canada limits for the general population; consult Safety Code 6, obtainable from Health Canada's Web site www.hc-sc.gc.ca/rpb.

The term "IC:" before the certification/registration number only signifies that the Industry Canada technical specifications were met.

Industry Canada (Canada)

Cet appareil est conforme à la norme RSS-210 d'Industry Canada. Son fonctionnement est soumis aux deux conditions suivantes :

(1) cet appareil ne doit pas provoquer d'interférences et (2) il doit accepter toute interférence reçue, y compris celles risquant d'altérer son fonctionnement.

Cet appareil a été conçu pour fonctionner uniquement avec l'antenne fournie. L'utilisation de toute autre antenne est strictement interdite par la réglementation d'Industry Canada.

En application des réglementations d'Industry Canada, l'utilisation d'une antenne de gain supérieur est strictement interdite.

Pour empêcher toute interférence radio au service faisant l'objet d'une licence, cet appareil doit être utilisé à l'intérieur et loin des fenêtres afin de garantir une protection optimale.

Si le matériel (ou son antenne d'émission) est installé à l'extérieur, il doit faire l'objet d'une licence.

L'installateur de cet équipement radio doit veiller à ce que l'antenne soit implantée et dirigée de manière à n'émettre aucun champ HF dépassant les limites fixées pour l'ensemble de la population par Santé Canada. Reportez-vous au Code de sécurité 6 que vous pouvez consulter sur le site Web de Santé Canada www.hc-sc.gc.ca/rpb.

Le terme « IC » précédant le numéro de d'accréditation/inscription signifie simplement que le produit est conforme aux spécifications techniques d'Industry Canada.

Taiwan NCC RF notice statement

NCC型式認證設備注意事項 台灣低功率射頻電機設備之使用注意事項

經型式認證合格之低功率射頻電機，非經許可，公司、商號或使用者均不得擅自變更頻率、加大功率或變更原設計之特性及功能。

低功率射頻電機之使用不得影響飛航安全及干擾合法通信；經發現有干擾現象時，應立即停用，並改善至無干擾時方得繼續使用。前項合法通信，指依電信規定作業之無線電信。低功率射頻電機須忍受合法通信或工業、科學及醫療用電波輻射性電機設備之干擾。

Notice to users in the European Union

Products bearing the CE mark are in conformity with the protection requirements of EC Council directives 2004/108/EC, 2006/95/EC, and 1999/5/EC on the approximation and harmonization of the laws of the Member States relating to electromagnetic compatibility, safety of electrical equipment designed for use within certain voltage limits and on radio equipment and telecommunications terminal equipment.

Compliance is indicated by the CE marking.



A declaration of conformity with the requirements of the directives is available from the Director of Manufacturing and Technical Support, Lexmark International, S. A., Boigny, France. Refer to the table at the end of the Notices section for further compliance information.

Products equipped with 2.4GHz Wireless LAN option are in conformity with the protection requirements of EC Council directives 2004/108/EC, 2006/95/EC, and 1999/5/EC on the approximation and harmonization of the laws of the Member States relating to electromagnetic compatibility, safety of electrical equipment designed for use within certain voltage limits and on radio equipment and telecommunications terminal equipment.

Compliance is indicated by the CE marking.



Operation is allowed in all EU and EFTA countries, but is restricted to indoor use only.

A declaration of conformity with the requirements of the directives is available from the Director of Manufacturing and Technical Support, Lexmark International, S. A., Boigny, France. Refer to the table at the end of the Notices section for further compliance information.

Česky	Společnost Lexmark International, Inc. tímto prohlašuje, že výrobek tento výrobek je ve shodě se základními požadavky a dalšími příslušnými ustanoveními směrnice 1999/5/ES.
Dansk	Lexmark International, Inc. erklærer herved, at dette produkt overholder de væsentlige krav og øvrige relevante krav i direktiv 1999/5/EF.
Deutsch	Hiermit erklärt Lexmark International, Inc., dass sich das Gerät dieses Gerät in Übereinstimmung mit den grundlegenden Anforderungen und den übrigen einschlägigen Bestimmungen der Richtlinie 1999/5/EG befindet.
Ελληνική	ΜΕ ΤΗΝ ΠΑΡΟΥΣΑ Η LEXMARK INTERNATIONAL, INC. ΔΗΛΩΝΕΙ ΟΤΙ ΑΥΤΟ ΤΟ ΠΡΟΪΟΝ ΣΥΜΜΟΡΦΩΝΕΤΑΙ ΠΡΟΣ ΤΙΣ ΟΥΣΙΩΔΕΙΣ ΑΠΑΙΤΗΣΕΙΣ ΚΑΙ ΤΙΣ ΛΟΙΠΕΣ ΣΧΕΤΙΚΕΣ ΔΙΑΤΑΞΕΙΣ ΤΗΣ ΟΔΗΓΙΑΣ 1999/5/ΕΚ.
English	Hereby, Lexmark International, Inc., declares that this type of equipment is in compliance with the essential requirements and other relevant provisions of Directive 1999/5/EC.
Español	Por medio de la presente, Lexmark International, Inc. declara que este producto cumple con los requisitos esenciales y cualesquiera otras disposiciones aplicables o exigibles de la Directiva 1999/5/CE.
Eesti	Käesolevaga kinnitab Lexmark International, Inc., et seade see toode vastab direktiivi 1999/5/EÜ põhinõuetele ja nimetatud direktivist tulenevatele muudele asjakohastele sätetele.
Suomi	Lexmark International, Inc. vakuuttaa täten, että tämä tuote on direktiivin 1999/5/EY oleellisten vaatimusten ja muiden sitä koskevien direktiivin ehtojen mukainen.
Français	Par la présente, Lexmark International, Inc. déclare que l'appareil ce produit est conforme aux exigences fondamentales et autres dispositions pertinentes de la directive 1999/5/CE.
Magyar	Alulírott, Lexmark International, Inc. nyilatkozom, hogy a termék megfelel a vonatkozó alapvető követelményeknek és az 1999/5/EC irányelv egyéb előírásainak.
Íslenska	Hér með lýsir Lexmark International, Inc. yfir því að þessi vara er í samræmi við grunnkröfur og aðrar kröfur, sem gerðar eru í tilskipun 1999/5/EC.
Italiano	Con la presente Lexmark International, Inc. dichiara che questo questo prodotto è conforme ai requisiti essenziali ed alle altre disposizioni pertinenti stabilite dalla direttiva 1999/5/CE.
Latviski	Ar šo Lexmark International, Inc. deklarē, ka šis izstrādājums atbilst Direktīvas 1999/5/EK būtiskajām prasībām un citiem ar to saistītajiem noteikumiem.
Lietuvių	Šiuo Lexmark International, Inc. deklaruoja, kad šis produktas atitinka esminius reikalavimus ir kitas 1999/5/EB direktyvos nuostatas.
Malti	Bil-preżenti, Lexmark International, Inc., jiddikjara li dan il-prodott huwa konformi mal-ħtiġijiet essenzjali u ma dispożizzjonijiet oħrajn relevanti li jinsabu fid-Direttiva 1999/5/KE.
Nederlands	Hierbij verklaart Lexmark International, Inc. dat het toestel dit product in overeenstemming is met de essentiële eisen en de andere relevante bepalingen van richtlijn 1999/5/EG.
Norsk	Lexmark International, Inc. erklærer herved at dette produktet er i samsvar med de grunnleggende krav og øvrige relevante krav i direktiv 1999/5/EF.
Polski	Niniejszym Lexmark International, Inc. oświadcza, że niniejszy produkt jest zgodny z zasadniczymi wymogami oraz pozostałymi stosownymi postanowieniami Dyrektywy 1999/5/EC.
Português	A Lexmark International Inc. declara que este este produto está conforme com os requisitos essenciais e outras disposições da Diretiva 1999/5/CE.

Slovensky	Lexmark International, Inc. týmto vyhlasuje, že tento produkt spĺňa základné požiadavky a všetky príslušné ustanovenia smernice 1999/5/ES.
Slovensko	Lexmark International, Inc. izjavlja, da je ta izdelek v skladu z bistvenimi zahtevami in ostalimi relevantnimi določili direktive 1999/5/ES.
Svenska	Härmed intygar Lexmark International, Inc. att denna produkt står i överensstämmelse med de väsentliga egenskapskrav och övriga relevanta bestämmelser som framgår av direktiv 1999/5/EG.

LEXMARK SOFTWARE LIMITED WARRANTY AND LICENSE AGREEMENTS

PLEASE READ CAREFULLY BEFORE USING THIS PRODUCT: BY USING THIS PRODUCT, YOU AGREE TO BE BOUND BY ALL THE TERMS AND CONDITIONS OF THIS SOFTWARE LIMITED WARRANTY AND LICENSE AGREEMENTS. IF YOU DO NOT AGREE WITH THE TERMS OF THIS SOFTWARE LIMITED WARRANTY AND LICENSE AGREEMENTS, PROMPTLY RETURN THE PRODUCT UNUSED AND REQUEST A REFUND OF THE AMOUNT YOU PAID. IF YOU ARE INSTALLING THIS PRODUCT FOR USE BY OTHER PARTIES, YOU AGREE TO INFORM THE USERS THAT USE OF THE PRODUCT INDICATES ACCEPTANCE OF THESE TERMS.

PRINTER LICENSE AGREEMENT

I agree that this patented printer is licensed for, and designed to work with only genuine Lexmark ink cartridges for the life of the patented printer. I agree to: (1) use only genuine Lexmark ink cartridges with this printer (except I may use replacement cartridges made by Lexmark but sold without single use terms as described in the below cartridge license agreement), and (2) pass this printer license/agreement to any subsequent user of this printer.

CARTRIDGE LICENSE AGREEMENT*

I agree that the patented print cartridge(s) shipped with this printing device are sold subject to the following license/agreement: The patented print cartridge(s) contained inside is/are licensed for a single use only and is/are designed to stop working after delivering a fixed amount of ink. A variable amount of ink will remain in the cartridge when replacement is required. After this single use, the license to use the print cartridge terminates, and the used cartridge must be returned only to Lexmark for remanufacturing, refilling or recycling. If I buy another cartridge in the future that is sold subject to the above terms, I accept such terms as to that cartridge. If you do not accept the terms of this single use license/agreement; return this product in its original packaging to your point of purchase. A replacement cartridge sold without these terms is available at www.lexmark.com.

LEXMARK SOFTWARE LICENSE AGREEMENT

This Software License Agreement ("License Agreement") is a legal agreement between you (either an individual or a single entity) and Lexmark International, Inc. ("Lexmark") that, to the extent your Lexmark product or Software Program is not otherwise subject to a written software license agreement between you and Lexmark or its suppliers, governs your use of any Software Program installed on or provided by Lexmark for use in connection with your Lexmark product. The term "Software Program" includes machine-readable instructions, audio/visual content (such as images and recordings), and associated media, printed materials and electronic documentation, whether incorporated into, distributed with or for use with your Lexmark product.

1 STATEMENT OF SOFTWARE LIMITED WARRANTY. Lexmark warrants that the media (e.g., diskette or compact disk) on which the Software Program (if any) is furnished is free from defects in materials and workmanship under normal use during the warranty period. The warranty period is ninety (90) days and commences on the date the Software Program is delivered to the original end-user. This limited warranty applies only to Software Program media purchased new from Lexmark or an Authorized Lexmark Reseller or Distributor. Lexmark will replace the Software Program should it be determined that the media does not conform to this limited warranty.

2 DISCLAIMER AND LIMITATION OF WARRANTIES. EXCEPT AS PROVIDED IN THIS SOFTWARE LICENSE AGREEMENT AND TO THE MAXIMUM EXTENT PERMITTED BY APPLICABLE LAW, LEXMARK AND ITS SUPPLIERS PROVIDE THE SOFTWARE PROGRAM "AS IS" AND HEREBY DISCLAIM ALL OTHER WARRANTIES AND CONDITIONS, EITHER EXPRESS OR IMPLIED, INCLUDING, BUT NOT LIMITED TO, TITLE, NON-INFRINGEMENT, MERCHANTABILITY AND FITNESS FOR A PARTICULAR PURPOSE, AND ABSENCE OF VIRUSES, ALL WITH REGARD TO THE SOFTWARE PROGRAM. TO THE EXTENT LEXMARK CANNOT BY LAW DISCLAIM ANY COMPONENT OF THE IMPLIED WARRANTIES OF MERCHANTABILITY OR FITNESS FOR A PARTICULAR PURPOSE, LEXMARK LIMITS THE DURATION OF SUCH WARRANTIES TO THE 90-DAY TERM OF THE EXPRESS SOFTWARE LIMITED WARRANTY. This Agreement is to be read in conjunction with certain statutory provisions, as that may be in force from time to time, that imply warranties or conditions or impose obligations on Lexmark that cannot be excluded or modified. If any such provisions apply, then to the extent Lexmark is able, Lexmark hereby limits its liability for breach of those provisions to one of the following: providing you a replacement copy of the Software Program or reimbursement of the price paid for the Software Program.

The Software Program may include internet links to other software applications and/or internet web pages hosted and operated by third parties unaffiliated with Lexmark. You acknowledge and agree that Lexmark is not responsible in any way for the hosting, performance, operation, maintenance, or content of, such software applications and/or internet web pages.

3 LIMITATION OF REMEDY. TO THE MAXIMUM EXTENT PERMITTED BY APPLICABLE LAW, ANY AND ALL LIABILITY OF LEXMARK UNDER THIS SOFTWARE LICENSE AGREEMENT IS EXPRESSLY LIMITED TO THE GREATER OF THE PRICE PAID FOR THE SOFTWARE PROGRAM AND FIVE U.S. DOLLARS (OR THE EQUIVALENT IN LOCAL CURRENCY). YOUR SOLE REMEDY AGAINST LEXMARK IN ANY DISPUTE UNDER THIS SOFTWARE LICENSE AGREEMENT SHALL BE TO SEEK TO RECOVER ONE OF THESE AMOUNTS, UPON PAYMENT OF WHICH LEXMARK SHALL BE RELEASED AND DISCHARGED OF ALL FURTHER OBLIGATIONS AND LIABILITY TO YOU.

IN NO EVENT WILL LEXMARK, ITS SUPPLIERS, SUBSIDIARIES, OR RESELLERS BE LIABLE FOR ANY SPECIAL, INCIDENTAL, INDIRECT, EXEMPLARY, PUNITIVE, OR CONSEQUENTIAL DAMAGES (INCLUDING BUT NOT LIMITED TO LOST PROFITS OR REVENUES, LOST SAVINGS, INTERRUPTION OF USE OR ANY LOSS OF, INACCURACY IN, OR DAMAGE TO, DATA OR RECORDS, FOR CLAIMS OF THIRD PARTIES, OR DAMAGE TO REAL OR TANGIBLE PROPERTY, FOR LOSS OF PRIVACY ARISING OUT OR IN ANY WAY RELATED TO THE USE OF OR INABILITY TO USE THE SOFTWARE PROGRAM, OR OTHERWISE IN CONNECTION WITH ANY PROVISION OF THIS SOFTWARE LICENCE AGREEMENT), REGARDLESS OF THE NATURE OF THE CLAIM, INCLUDING BUT NOT LIMITED TO BREACH OF WARRANTY OR CONTRACT, TORT (INCLUDING NEGLIGENCE OR STRICT LIABILITY), AND EVEN IF LEXMARK, OR ITS SUPPLIERS, AFFILIATES, OR REMARKETERS HAVE BEEN ADVISED OF THE POSSIBILITY OF SUCH DAMAGES, OR FOR ANY CLAIM BY YOU BASED ON A THIRD-PARTY CLAIM, EXCEPT TO THE EXTENT THIS EXCLUSION OF DAMAGES IS DETERMINED LEGALLY INVALID. THE FOREGOING LIMITATIONS APPLY EVEN IF THE ABOVE-STATED REMEDIES FAIL OF THEIR ESSENTIAL PURPOSE.

4 U.S.A. STATE LAWS. This Software Limited Warranty gives you specific legal rights. You may also have other rights that vary from state to state. Some states do not allow limitations on how long an implied warranty lasts or the exclusion of limitation of incidental or consequential damages, so the above limitations may not apply to you.

- 5 LICENSE GRANT.** Lexmark grants you the following rights provided you comply with all terms and conditions of this License Agreement:
- a Use.** You may Use one (1) copy of the Software Program. The term “Use” means storing, loading, installing, executing, or displaying the Software Program. If Lexmark has licensed the Software Program to you for concurrent use, you must limit the number of authorized users to the number specified in your agreement with Lexmark. You may not separate the components of the Software Program for use on more than one computer. You agree that you will not Use the Software Program, in whole or in part, in any manner that has the effect of overriding, modifying, eliminating, obscuring, altering or de-emphasizing the visual appearance of any trademark, trade name, trade dress or intellectual property notice that appears on any computer display screens normally generated by, or as a result of, the Software Program.
 - b Copying.** You may make one (1) copy of the Software Program solely for purposes of backup, archiving, or installation, provided the copy contains all of the original Software Program’s proprietary notices. You may not copy the Software Program to any public or distributed network.
 - c Reservation of Rights.** The Software Program, including all fonts, is copyrighted and owned by Lexmark International, Inc. and/or its suppliers. Lexmark reserves all rights not expressly granted to you in this License Agreement.
 - d Freeware.** Notwithstanding the terms and conditions of this License Agreement, all or any portion of the Software Program that constitutes software provided under public license by third parties (“Freeware”) is licensed to you subject to the terms and conditions of the software license agreement accompanying such Freeware, whether in the form of a discrete agreement, shrink-wrap license, or electronic license terms at the time of download. Use of the Freeware by you shall be governed entirely by the terms and conditions of such license.
- 6 TRANSFER.** You may transfer the Software Program to another end-user. Any transfer must include all software components, media, printed materials, and this License Agreement and you may not retain copies of the Software Program or components thereof. The transfer may not be an indirect transfer, such as a consignment. Prior to the transfer, the end-user receiving the transferred Software Program must agree to all these License Agreement terms. Upon transfer of the Software Program, your license is automatically terminated. You may not rent, sublicense, or assign the Software Program except to the extent provided in this License Agreement, and any attempt to do so shall be void.
- 7 UPGRADES.** To Use a Software Program identified as an upgrade, you must first be licensed to the original Software Program identified by Lexmark as eligible for the upgrade. After upgrading, you may no longer use the original Software Program that formed the basis for your upgrade eligibility.
- 8 LIMITATION ON REVERSE ENGINEERING.** You may not alter, decrypt, reverse engineer, reverse assemble, reverse compile or otherwise translate the Software Program, except as and to the extent expressly permitted to do so by applicable law for the purposes of inter-operability, error correction, and security testing. If you have such statutory rights, you will notify Lexmark in writing of any intended reverse engineering, reverse assembly, or reverse compilation. You may not decrypt the Software Program unless necessary for the legitimate Use of the Software Program.
- 9 ADDITIONAL SOFTWARE.** This License Agreement applies to updates or supplements to the original Software Program provided by Lexmark unless Lexmark provides other terms along with the update or supplement.
- 10 TERM.** This License Agreement is effective unless terminated or rejected. You may reject or terminate this license at any time by destroying all copies of the Software Program, together with all modifications, documentation, and merged portions in any form, or as otherwise described herein. Lexmark may terminate your license upon notice if you fail to comply with any of the terms of this License Agreement. Upon such termination, you agree to destroy all copies of the Software Program together with all modifications, documentation, and merged portions in any form.
- 11 TAXES.** You agree that you are responsible for payment of any taxes including, without limitation, any goods and services and personal property taxes, resulting from this Agreement or your Use of the Software Program.

- 12 LIMITATION ON ACTIONS.** No action, regardless of form, arising out of this Agreement may be brought by either party more than two years after the cause of action has arisen, except as provided under applicable law.
- 13 APPLICABLE LAW.** This Agreement is governed by the laws of the Commonwealth of Kentucky, United States of America. No choice of law rules in any jurisdiction shall apply. The UN Convention on Contracts for the International Sale of Goods shall not apply.
- 14 UNITED STATES GOVERNMENT RESTRICTED RIGHTS.** The Software Program has been developed entirely at private expense. Rights of the United States Government to use the Software Program is as set forth in this Agreement and as restricted in DFARS 252.227-7014 and in similar FAR provisions (or any equivalent agency regulation or contract clause).
- 15 CONSENT TO USE OF DATA.** You agree that Lexmark, its affiliates, and agents may collect and use information you provide in relation to support services performed with respect to the Software Program and requested by you. Lexmark agrees not to use this information in a form that personally identifies you except to the extent necessary to provide such services.
- 16 EXPORT RESTRICTIONS.** You may not (a) acquire, ship, transfer, or reexport, directly or indirectly, the Software Program or any direct product therefrom, in violation of any applicable export laws or (b) permit the Software Program to be used for any purpose prohibited by such export laws, including, without limitation, nuclear, chemical, or biological weapons proliferation.
- 17 AGREEMENT TO CONTRACT ELECTRONICALLY.** You and Lexmark agree to form this License Agreement electronically. This means that when you click the "Agree" or "Yes" button on this page or use this product, you acknowledge your agreement to these License Agreement terms and conditions and that you are doing so with the intent to "sign" a contract with Lexmark.
- 18 CAPACITY AND AUTHORITY TO CONTRACT.** You represent that you are of the legal age of majority in the place you sign this License Agreement and, if applicable, you are duly authorized by your employer or principal to enter into this contract.
- 19 ENTIRE AGREEMENT.** This License Agreement (including any addendum or amendment to this License Agreement that is included with the Software Program) is the entire agreement between you and Lexmark relating to the Software Program. Except as otherwise provided for herein, these terms and conditions supersede all prior or contemporaneous oral or written communications, proposals, and representations with respect to the Software Program or any other subject matter covered by this License Agreement (except to the extent such extraneous terms do not conflict with the terms of this License Agreement, any other written agreement signed by you and Lexmark relating to your Use of the Software Program). To the extent any Lexmark policies or programs for support services conflict with the terms of this License Agreement, the terms of this License Agreement shall control.

* Products within the XX90 Series (including but not limited to models Z2390, Z2490, X2690, X3690, and X4690) are not subject to the Cartridge License Agreement. This Cartridge License Agreement does not apply to cartridges included within the printer boxes of XX75 Series products (including but not limited to models X4975 and X7675). It applies to replacement cartridges that are sold subject to these terms and conditions, however. Replacement cartridges sold without these terms are available through www.lexmark.com.

MICROSOFT CORPORATION NOTICES

- 1 This product may incorporate intellectual property owned by Microsoft Corporation. The terms and conditions upon which Microsoft is licensing such intellectual property may be found at <http://go.microsoft.com/fwlink/?LinkId=52369>.
- 2 This product is based on Microsoft Print Schema technology. You may find the terms and conditions upon which Microsoft is licensing such intellectual property at <http://go.microsoft.com/fwlink/?LinkId=83288>.

ADOBE SYSTEMS INCORPORATED NOTICE

Contains Flash®, Flash® Lite™ and/or Reader® technology by Adobe Systems Incorporated

This Product contains Adobe® Flash® player software under license from Adobe Systems Incorporated, Copyright © 1995-2007 Adobe Macromedia Software LLC. All rights reserved. Adobe, Reader and Flash are trademarks of Adobe Systems Incorporated.

Index

A

- ad hoc
 - SSID 66
 - WEP 66
- ad hoc network 77
- ad hoc wireless network
 - adding a printer 69
 - creating using Macintosh 66
 - creating using Windows 66
- additional computers
 - installing wireless printer 63
- AliceBox 64
- aligning the printhead 84
- appliances
 - wireless network 78
- application list
 - downloading 59
 - updating 59
- assigning IP address 83

B

- banner paper 26
- bidirectional communication
 - enabling 112
- black and white scanning 59
- Bluetooth
 - printing 44
 - setting the security level 43
 - setting up a connection 42
- buttons, printer control panel
 - Back 15
 - Cancel 15
 - Color/Black 14
 - Copy 14
 - Display 15
 - Photo 14
 - Power 14
 - Scan 14
 - Select 15
 - Settings 15
 - Start 14

C

- cable
 - installation 76
 - USB 76

- camera
 - connecting 40
- canceling
 - copy job 53
 - print job 47
 - scan job 60
- cannot delete documents from print queue 92
- cannot print from a flash drive 98
- cannot print over wireless network 100
- cannot print through USB 92
- cannot scan to computer over a network 97
- cartridges, ink
 - ordering 11
 - using genuine Lexmark 11
- changing Power Saver timeout 16
- changing printing mode 45
- changing temporary settings into default 15
- changing wireless settings after installation (Mac) 65
- changing wireless settings after installation (Windows) 65
- checking an unresponsive printer 87
- checking ink levels 84
- checklist
 - before you troubleshoot 87
 - memory card troubleshooting 98
- cleaning exterior of the printer 86
- cleaning printhead nozzles 85
- Club Internet 64
- collating copies 51
- Communication not available message 112
- computer slows down when printing 96
- configuring
 - IP address 65
- connection
 - configurations 81
- conserving energy, ink, and paper 6
- conserving paper
 - using Eco-Mode 17
- continue button greyed out 104
- continue button not working 104
- continue button unavailable 104
- copier or scanner does not respond 96
- copies
 - making 49
- copy and scan troubleshooting
 - cannot scan to computer over a network 97
 - copier or scanner does not respond 96
 - partial document or photo scans 97
 - poor scanned image quality 96
 - scan not successful 97
 - scanning takes too long or freezes the computer 97
- copy job
 - canceling 53
- copy quality, adjusting 50
- copy troubleshooting
 - scanner unit does not close 96
- copying 49
 - adjusting quality 50
 - collating copies 51
 - enlarging an image 50
 - making a copy lighter or darker 50
 - multiple page images on one sheet 52
 - on both sides of the paper 52
 - Pages per Sheet 52
 - photos 49
 - reducing an image 50
 - repeating an image 51
 - tips 49
- custom-size paper
 - printing on 34

D

- default printer, setting 45
- defaults
 - resetting factory defaults 17
- disabling settings timeout 15
- documents
 - loading on scanner glass 28
 - printing 29
 - scanning for editing 57

- scanning using the printer control panel 54
- duplex
 - copying, manual 52
 - printing, manual 35

E

- Eco-Mode
 - using 17
- emission
- notices 119, 120, 123, 127, 128
- energy
 - conserving 6
- enlarging an image 50
- envelopes 26
 - loading 33
 - printing 33
- error using memory card 98
- Ethernet 81
- exterior of the printer
 - cleaning 86
- e-mailing
 - scanned documents 57

F

- factory default settings
 - resetting internal wireless print server 100
 - resetting to 17
- FCC notices 119, 123, 127
- file types
 - supported 38
- finding
 - information 7
 - MAC address 81
 - publications 7
 - Web site 7
- finding IP address of computer (Mac) 82
- firewall on computer 105
- flash drive
 - inserting 37
 - printing documents from 32
 - printing photos using the proof sheet 41
 - scanning to 55
- France
 - special wireless setup instructions 64
- FreeBox 64

G

- greeting cards 27

H

- heavyweight matte paper 26

I

- improving scan quality 59
- incorrect language appears on display 88
- index cards 27
- information
 - finding 7
- information needed for setting up printer on wireless network 62
- infrastructure network 77
- ink
 - conserving 6
- ink cartridge access 9
- ink cartridges
 - ordering 11
 - replacing 12
 - using genuine Lexmark 11
- ink levels
 - checking 84
- inserting a memory card or flash drive 37
- installation
 - cable 76
- installing
 - network printer 83
- installing optional software 22
- installing printer
 - on wireless network (Macintosh) 63
 - on wireless network (Windows) 63
- installing printer software 24
- installing wireless printer
 - additional computers 63
- interference
 - wireless network 78
- internal wireless print server
 - resetting to factory default settings 100
- IP address 82
 - configuring 65
- IP address, assigning 83
- iron-on transfers 27

J

- jams and misfeeds troubleshooting
 - paper jam in the paper support 93
 - paper jam in the printer 93
 - paper or specialty media 93

K

- key index 83

L

- labels 26
 - printing 33
- language
 - changing 88
- LiveBox 64
- loading
 - documents on scanner glass 28
 - envelopes 33
- loading paper 25
- locating
 - SSID 74
 - WEP key 73
 - WPA passphrase 73

M

- MAC address 81
 - finding 81
- MAC address filtering 81
- Macintosh
 - installing printer on wireless network 63
 - USB 70
 - wireless 70
- Macintosh printer software
 - using 21
- memory card
 - inserting 37
 - printing documents from 32
 - printing photos using the proof sheet 41
 - scanning to 55
 - supported types 38
- memory card cannot be inserted 98
- memory card slots 9
- memory card troubleshooting
 - cannot print from a flash drive 98
 - checklist 98

- nothing happens when memory card is inserted 98
- minimum system requirements 19
- multiple WEP keys 83

N

- N9UF Box 64
- network connection
 - with USB 81
- network overview 74
- network printer
 - installing 83
- network security 74
- network setup page
 - printing 62
- networking
 - finding IP address of computer 82
 - finding IP address of computer (Mac) 82
 - finding IP address of printer 82
 - IP addresses 82
 - sharing the printer with a Macintosh computer 72
 - sharing the printer with a Windows computer 72
- no wireless network 66
- noise emission levels 120
- nothing happens when memory card is inserted 98
- notices 119, 120, 121, 122, 123, 124, 125, 126, 127, 128

O

- ordering paper and other supplies 13

P

- page does not print 90
- Pages per Sheet copies 52
- paper
 - conserving 6
- paper and media
 - banner paper 26
 - envelopes 26
 - heavyweight matte paper 26
 - index cards 27
 - iron-on transfers 27
 - photo cards 27
 - photo/glossy paper 27
 - plain paper 25

- postcards 27
- transparencies 27
- paper and other supplies
 - ordering 13
- paper default settings
 - saving 27
- paper exit tray 9
- paper feed guard 9
- paper guides 9
- paper jam in the paper support 93
- paper jam in the printer 93
- paper or specialty media
 - misfeeds 93
- paper support 9
- partial document or photo scans 97
- parts
 - diagram 9
- password 74
- pausing
 - print job 46
- PDF
 - creating from scan 58
- photo cards 27
- photo/glossy paper 27
- photos
 - copying photos 49
 - making borderless copies 50
 - printing from digital camera using DPOF 42
 - printing using printer control panel 38
 - printing using the proof sheet 41
 - scanning for editing 55
- photos do not print from memory card across wireless network 99
- photos from memory device
 - printing using printer software 39
- PictBridge port 9
- PictBridge-enabled camera
 - connecting 40
- plain paper 25
- poor quality at the edges of page 94
- poor scanned image quality 96
- postcards 27
- Power Saver timeout
 - changing 16
- power supply port 10
- print job
 - canceling 47

- pausing 46
- resuming 47
- print media
 - greeting cards 27
 - labels 26
- print speed is slow 95
- print troubleshooting
 - cannot delete documents from print queue 92
 - computer slows down when printing 96
 - poor quality at the edges of page 94
 - slow print speed 95
 - streaks or lines on printed image 95
- printer
 - sharing 71
 - sharing in Windows 71
 - printer control panel 9
 - using 14
 - printer does not print wireless 105
 - printer does not print wirelessly 106
 - printer does not respond 91
 - printer printing blank pages 91
 - printer problems, basic solutions 87
 - printer software
 - installing 24
 - uninstalling 23
 - printer, setting as default 45
- printhead
 - aligning 84
- printhead access 10
- printhead error 88
- printhead nozzles
 - cleaning 85
- printing
 - collate 30
 - custom-size paper 34
 - documents 29
 - documents from memory card or flash drive 32
 - envelopes 33
 - from a Bluetooth-enabled device 44
 - from a PictBridge-enabled camera 40
 - labels 33
 - last page first 30

- multiple pages on one sheet 31
- network setup page 62
- on both sides of the paper 35
- photos from digital camera using DPOF 42
- photos from memory device using printer software 39
- photos using printer control panel 38
- photos using the proof sheet 41
- reverse page order 30
- tips 29
- two-sided 35
- printing in draft mode 45
- printing mode
 - changing 45
- proof sheet
 - using 41
- protocol 82
- publications
 - finding 7

R

- recycling 6
 - Lexmark products 13
 - WEEE statement 121
- reducing an image 50
- repeating an image 51
- replacing ink cartridges 12
- resetting
 - internal wireless print server to factory default settings 100
 - resetting to factory defaults 17
- resuming
 - print job 47
- reverse page order 30

S

- safety information 5
- saving paper default settings 27
- scan
 - black and white 59
 - improving quality 59
 - PIN 59
- scan job
 - canceling 60
- scan was not successful 97
- scanner glass 10
 - cleaning 86
- scanner lid 9
- scanner unit 10

- scanner unit does not close 96
- scanning
 - creating a PDF from scan 58
 - documents for editing 57
 - documents for e-mailing 57
 - photos for editing 55
 - tips 54
 - to a computer 54
 - to a flash drive 55
 - to a memory card 55
 - to a network 54
 - using the printer control panel 54
- scanning takes too long or freezes the computer 97
- security
 - wireless network 61
- security information
 - wireless network 74
- security key 74
- selecting the wireless port 112
- Service Center 87
- setting up printer
 - on wireless network (Macintosh) 63
 - on wireless network (Windows) 63
- settings timeout
 - disabling 15
- setup troubleshooting
 - cannot print through USB 92
 - incorrect language appears on display 88
 - page does not print 90
 - printer does not respond 91
 - printer printing blank pages 91
 - printhead error 88
 - software did not install 90
- shared printing 72
- sharing printer in Windows 71
- software
 - Service Center 87
 - software did not install 90
 - software updates
 - checking 23
 - enabling 23
 - software, optional
 - finding, installing 22
- SSID
 - ad hoc 66
 - finding 79
 - locating 74

- wireless network 73
- streaks or lines on printed image 95
- supported memory cards and file types 38
- supported operating systems 19
- switching from USB
 - to wireless 70
 - to wireless, using Mac OS X 70
- switching from wireless
 - to USB 70
 - to USB, using Mac OS X 70

T

- TCP/IP 82
- technical support 87
- telecommunication notices 123, 124, 125, 126
- temporary settings
 - changing into default 15
- tips for
 - copying 49
 - printing 29
 - scanning 54
- transparencies 27
- troubleshooting
 - checking an unresponsive printer 87
 - contacting technical support 87
 - Service Center 87
 - solving basic printer problems 87
 - wireless network 99
- troubleshooting, copy
 - scanner unit does not close 96
- troubleshooting, copy and scan
 - cannot scan to computer over a network 97
 - copier or scanner does not respond 96
 - partial document or photo scans 97
 - poor scanned image quality 96
 - scan not successful 97
 - scanning takes too long or freezes the computer 97
- troubleshooting, jams and misfeeds
 - paper jam in the paper support 93
 - paper jam in the printer 93
 - paper or specialty media 93

- troubleshooting, memory card
 - cannot print from a flash drive 98
 - checklist 98
 - nothing happens when memory card is inserted 98
- troubleshooting, print
 - cannot delete documents from print queue 92
 - computer slows down when printing 96
 - poor quality at the edges of page 94
 - slow print speed 95
 - streaks or lines on printed image 95
- troubleshooting, setup
 - cannot print through USB 92
 - incorrect language appears on display 88
 - page does not print 90
 - printer does not respond 91
 - printer printing blank pages 91
 - printhead error 88
 - software did not install 90
- troubleshooting, wireless
 - cannot print over wireless network 100
 - changing wireless settings after installation (Mac) 65
 - changing wireless settings after installation (Windows) 65
 - photos do not print from memory card across wireless network 99
 - resolving communication problems 115
 - Wi-Fi indicator light is blinking orange 108
 - Wi-Fi indicator light is not lit 105
 - Wi-Fi indicator light is still orange 107

U

- UK
 - special wireless setup instructions 64
- uninstalling printer software 23
- updating printer software 23
- updating the application list 59
- USB 70, 81
 - cable 76
 - Macintosh 70

- USB connection
 - with network connection 81
- USB port 10
- using
 - Macintosh printer software 21

V

- Virtual Private Network 114
- VPN
 - lose connection to printer 114

W

- Web site
 - finding 7
- WEP 61
 - ad hoc 66
- WEP key
 - key index 83
 - locating 73
- Windows
 - installing printer on wireless network 63
- Windows software
 - Abbyy Sprint OCR 19
 - Fast Pics 19
 - Fax Setup Utility 19
 - Fax Solutions software 19
 - Printer Home 19
 - Printing Preferences 19
 - Service Center 19
 - Toolbar 19
 - Tools for Office 19
 - Wireless Setup Utility 19
- wireless 70, 81
 - Macintosh 70
 - printer does not print 105
 - troubleshooting 106, 114
 - wireless network
 - adding a printer to existing ad hoc network 69
 - common home configurations 74
 - creating an ad hoc network using Macintosh 66
 - creating an ad hoc network using Windows 66
 - information needed for setting up wireless printing 62
 - installing printer on (Macintosh) 63
 - installing printer on (Windows) 63

- interference 78
- resolving communication problems 115
- security 61
- security information 74
- signal strength 78
- SSID 73
- troubleshooting 99
- types of wireless networks 77
- wireless network compatibility 61
- wireless print server
 - not installed 112
- wireless settings
 - changing after installation (Mac) 65
- wireless setup
 - information needed for 62
- wireless signal
 - strength 78
- wireless signal absorption 78
- wireless troubleshooting
 - cannot print over wireless network 100
 - changing wireless settings after installation (Mac) 65
 - changing wireless settings after installation (Windows) 65
 - photos do not print from memory card across wireless network 99
 - printer and computer on different networks 79
 - printer works intermittently on wireless network 115
 - Wi-Fi indicator light is blinking orange 108
 - Wi-Fi indicator light is not lit 105
 - Wi-Fi indicator light is still orange 107
- Wi-Fi indicator
 - description of colors 64
 - light is not lit 105
- Wi-Fi indicator light is blinking orange 108
- Wi-Fi indicator light is green
 - printer does not print 106
- Wi-Fi indicator light is still orange 107
- Wi-Fi Protected Setup 69
 - using 73
- Wi-Fi Protected Setup logo
 - identifying 73
- WPA 61

WPA passphrase
 locating 73
WPA2 61
WPS 69