

DriveStation  
External Hard Drive  
HD-WHU3R1  
HD-QHU3R5

## **User Manual**

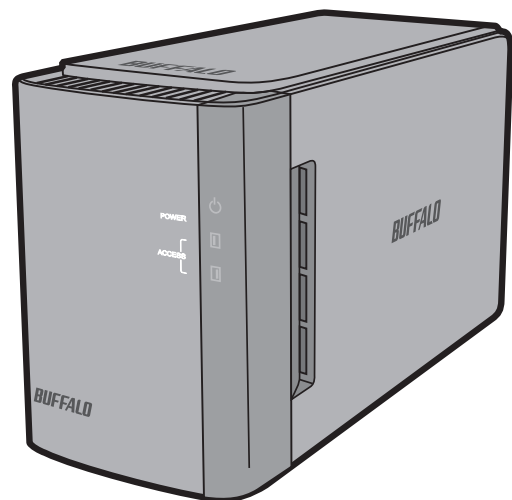
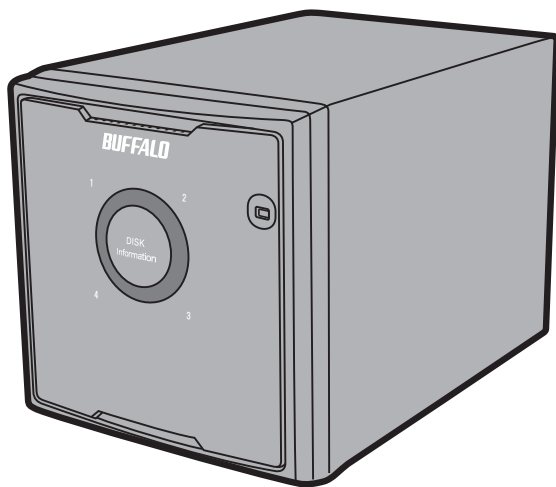

***Americas: [www.buffaloamericas.com](http://www.buffaloamericas.com)***  
***Europe: [www.buffalo-technology.com](http://www.buffalo-technology.com)***

# Contents

## **Overview .....3**

Diagrams.....3

Power On/Off .....4

## **Specifications.....6**

Technical Specifications .....6

HD-WHU3R1 ..... 6

HD-QHU3R5..... 6

Recommended Usage .....7

Dismounting the DriveStation .....8

Windows ..... 8

Mac..... 8

Troubleshooting.....9

I cannot see the DriveStation..... 9

I can see the DriveStation but I cannot access it ..... 9

My backup program cannot save files to the DriveStation ..... 9

## **Formatting ..... 10**

What is Formatting? ..... 10

Windows ..... 10

Mac..... 10

Notes ..... 10

Formatting with NTFS (Windows)..... 10

Formatting with HFS+ (Mac) ..... 15

**Regulatory Compliance Information ..... 19**  
**The United States ..... 19**  
**Europe ..... 19**

# Overview

## Diagrams

### HD-WHU3R1

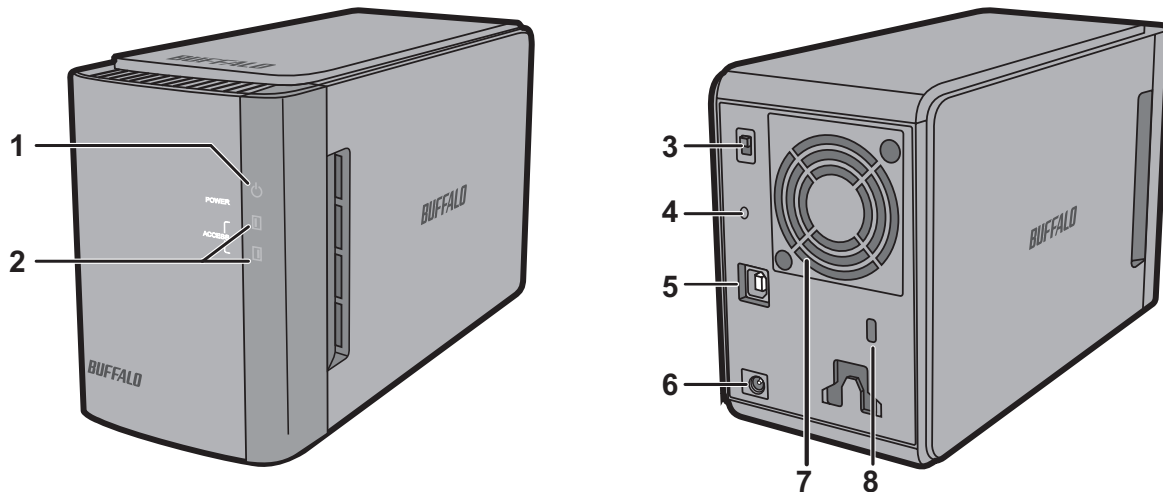

### HD-QHU3R5

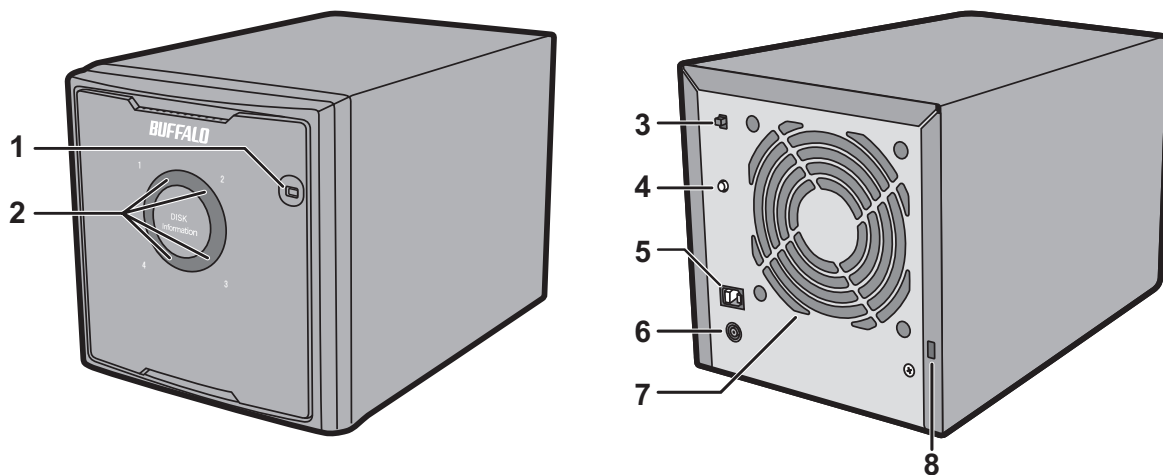

- 1** Power LED  
Power On: blue  
RAID Maintenance: purple

- 2** Access LEDs  
These indicate the status of the built-in hard drives.  
The top LED indicates the status for disk 1 and the bottom LED indicates the status for disk 2. (HD-WHU3R1)  
The number next to the LED corresponds to the hard drive number. (HD-QHU3R5)  
Power On: green

Accessing: blinking green

Error: red

Rebuilding: blinking red

### 3 Power Mode Switch

See "Power On/Off".

### 4 RAID Mode Button

This button can change RAID modes, confirm the current RAID mode, or rebuild the DriveStation. Refer to the manual on the utility CD for more details.

### 5 USB Connector

Connect to your computer with the included USB cable.

### 6 DC in

Connect the AC adapter here.

### 7 Fan

Don't block airflow from the fan.

### 8 Security Slot

---

## Power On/Off

---

Auto power mode will turn the DriveStation on and off automatically with your computer, or you may turn the DriveStation off manually.

Auto: The DriveStation turns on and off automatically with your computer.

Off: This turns off the DriveStation's power.

### HD-WHU3R1

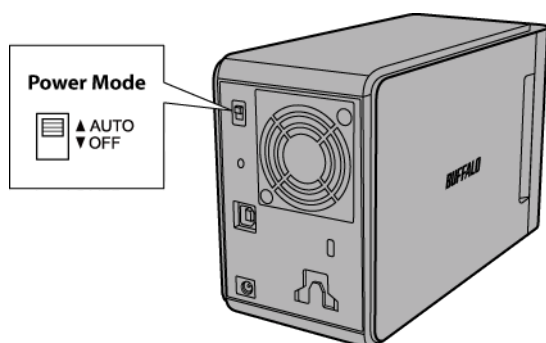

## HD-QHU3R5

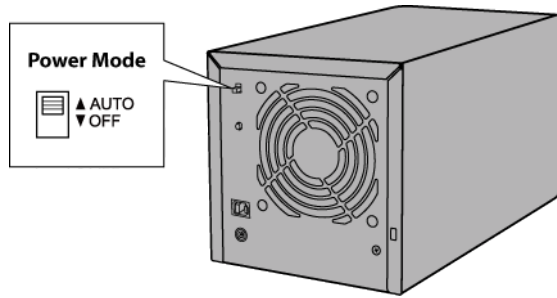

### Notes:

- In Auto mode, after the computer is turned off, there may be a short delay before the DriveStation shuts down.
- If the DriveStation is connected to a USB hub with its own power supply, it may not shut down automatically when the computer is turned off. In this case, use the switch to turn it off manually.

# Specifications

Check Buffalo website for information about the latest products or compatible models.

## Technical Specifications

### HD-WHU3R1

Interface	USB 3.0
Transfer Speed	5 Gbps Maximum (USB 3.0)*
External Dimensions (Excluding protruding parts)	86 x 127 x 204 mm
Power Consumption	48 W (Max)
Power	AC 100 - 240 V 50/60 Hz
Compatible OS	Windows 10 (64-bit or 32-bit) Windows 8.1 (64-bit or 32-bit) Windows RT 8.1** Windows 8 (64-bit or 32-bit) Windows RT** Windows 7 (64-bit or 32-bit) Windows Vista (64-bit or 32-bit) Windows XP (32-bit) Windows Server 2012 R2 (64-bit) Windows Server 2012 (64-bit) Windows Server 2008 R2 (64-bit) Windows Server 2008 (64-bit or 32-bit) OS X 10.6 or later (models with Intel Processor)
Internal Hard Drive	If a hard drive in the DriveStation malfunctions, replace it with a Buffalo OP-HDWH series drive of the same capacity.

\*Connect the DriveStation to a USB 3.0 port for best transfer speeds. The DriveStation will function when connected to a USB 2.0 or USB 1.1 port, but data transfers will be slower.

\*\*Only basic external hard drive functionality is supported with these operating systems; some included utilities may not work.

### HD-QHU3R5

Interface	USB 3.0
Transfer Speed	5 Gbps Maximum (USB 3.0)*
External Dimensions (Excluding protruding parts)	149 x 154 x 233 mm
Power Consumption	90 W (Max)
Power	AC 100 - 240 V 50/60 Hz

Compatible OS	Windows 10 (64-bit or 32-bit) Windows 8.1 (64-bit or 32-bit) Windows RT 8.1** Windows 8 (64-bit or 32-bit) Windows RT** Windows 7 (64-bit or 32-bit) Windows Vista (64-bit or 32-bit) Windows XP (32-bit) Windows Server 2012 R2 (64-bit) Windows Server 2012 (64-bit) Windows Server 2008 R2 (64-bit) Windows Server 2008 (64-bit or 32-bit) OS X 10.6 or later (models with Intel Processor)
Internal Hard Drive	If a hard drive in the DriveStation malfunctions, replace it with a Buffalo OP-HDQH series drive of the same capacity.

\*Connect the DriveStation to a USB 3.0 port for best transfer speeds. The DriveStation will function when connected to a USB 2.0 or USB 1.1 port, but data transfers will be slower.

\*\*Only basic external hard drive functionality is supported with these operating systems; some included utilities may not work.

---

## Recommended Usage

---

To avoid damage to data, never do any of the following while data is being accessed:

- unplug the cables
- turn off your computer
- put your computer into standby, hibernate, or sleep mode

- The DriveStation supports hot-plugging.  
You can plug or unplug the USB cable while the DriveStation and your PC are on. However, never unplug the cable while the data is being accessed. If you unplug the DriveStation while the data is being accessed, your data may be damaged or lost.
- The first time you connect the DriveStation, it may take about 20 seconds before the power/access LED turns on.
- If your Windows computer will not boot while the DriveStation is connected, try the followings:
  - (1) Connect the DriveStation to your computer after rebooting Windows.
  - (2) Refer to your computer's manual to change the BIOS setting not to boot from a USB device.
- If your computer does not recognize the DriveStation, disconnect the USB cable and reconnect it after several seconds. Connect the DriveStation directly to your computer without a USB hub.
- In some environment, Windows may display a message that a high-speed USB device is connected to a non high-speed USB hub.  
If your DriveStation supports USB 3.0, connect to a USB 3.0 port and the message will disappear.  
If your DriveStation supports USB 2.0, connect to a USB 3.0 or 2.0 port and the message will disappear.



- The maximum size of a file on a FAT32 hard drive is 4 GB. To use files that are 4 GB or larger, keep the default NTFS format.
- To use the DriveStation with Mac OS, reformat with HFS+ (Mac OS extended).
- If you use the DriveStation with multiple partitions, format each partition before use.
- Never configure the DriveStation as a destination for virtual memory.
- Booting an operating system from the DriveStation is not supported.
- Some computers may display a delayed write when they return from an energy-saving state. If this happens, unplug the DriveStation before putting your computer into the energy-saving mode.
- Do not lean any object against the DriveStation. It may cause the DriveStation to malfunction.
- You may hear some noise while the DriveStation is working, especially while it's booting or being accessed. This is normal.
- The DriveStation may become hot during use.  
The DriveStation is designed to release heat through its case. The surface of the case may become quite hot in normal use. Even when the DriveStation is off, the case may still be warm from standby current.
- It may take some time until the power/access LED turns off after your computer is switched off.

---





## Dismounting the DriveStation

---

If your computer is turned on, please follow the procedure below to unplug the DriveStation. If your computer is turned off, then it is always safe to unplug the DriveStation. Unplugging the DriveStation incorrectly can corrupt data. Please be careful.



### Windows

---

- 1** Click the , , , or  icon in the system tray.
- 2** When the menu opens, click the device name.
- 3** A message that indicates you can safely remove the device will appear. Unplug the DriveStation.

### Mac

---

- 1** Drag the DriveStation's icon to the trash  (). Or, click the dismount icon  in the sidebar of the Finder.
- 2** Unplug the DriveStation.

---

# Troubleshooting

---

## **I cannot see the DriveStation**

---

- **If you're using the DriveStation with Windows XP, reformat the drive by building a RAID array with the RAID utility. Refer to the manual on the utility CD for the procedure.**
- Verify that the power LED is on. If it is not, then ensure that the power mode switch is in the on position. Check the cables. The DriveStation should be connected to your computer by a USB cable. Check that both ends are correctly plugged in.
- Verify that the hard drive inside the DriveStation is spinning. This can be verified by placing your hand on the side of the case and feeling for a slight vibration.
- After the DriveStation has been powered on for 15 minutes or more it will begin to get warm. If neither of the preceding tests verified that the hard drive is spinning, then please contact technical support for further assistance.

## **I can see the DriveStation but I cannot access it**

---

The drive may require formatting. There are two ways to format the drive:

- (1) Format the drive by building a RAID array with the RAID utility. Refer to the manual on the utility CD for the procedure.
- (2) Format the drive from *Disk Management* in Windows. Refer to "Formatting" for the procedure.

## **My backup program cannot save files to the DriveStation**

---

Reformat your DriveStation with NTFS or HFS+ (Mac OS extended). FAT32 is limited to 4 GB file sizes.

# Formatting

---

## What is Formatting?

---

Formatting is a process that creates a file system, allowing a drive to be usable with your computer. The DriveStation is formatted with NTFS by default.

### Windows

---

Keep the default NTFS format.

### Mac

---

Refer to the procedure below to reformat with HFS+ (Mac OS extended).

---

## Notes

---

- Never unplug, reset, or turn off the computer during the formatting process. This could result in damage to the drive or other problems. Proper operation cannot be guaranteed if the format process is interrupted.
- Formatting will erase all data on the hard drive. Before formatting, back up any data. The user is responsible for any data lost due to formatting of the hard drive.  
Don't format the wrong drive! Check the drive letter and partition name carefully.

---

## Formatting with NTFS (Windows)

---



The DriveStation is formatted with NTFS by default.

If the drive has been formatted with HFS+ to use with a Mac and you want to reformat with NTFS, follow the procedure below.

**Notes:**

- The drive can also be formatted by building a RAID array with the RAID utility. However, the RAID utility cannot format only some partitions.
- If you're using Windows XP, the drive may not be able to be formatted by the following procedure. In this case, use the RAID utility.

**1** Connect the DriveStation to your computer with the supplied USB cable.

**2** Click  (  ) on the taskbar. Right-click *This PC* and select *Manage*.

For Windows Vista, Windows XP, follow the procedure below:

Click *Start*. Right-click *Computer (My Computer)* and select *Manage*.

**Note:** If the "User Account Control" window opens, select *Yes* or *Continue*.

**3** Click *Disk Management*.

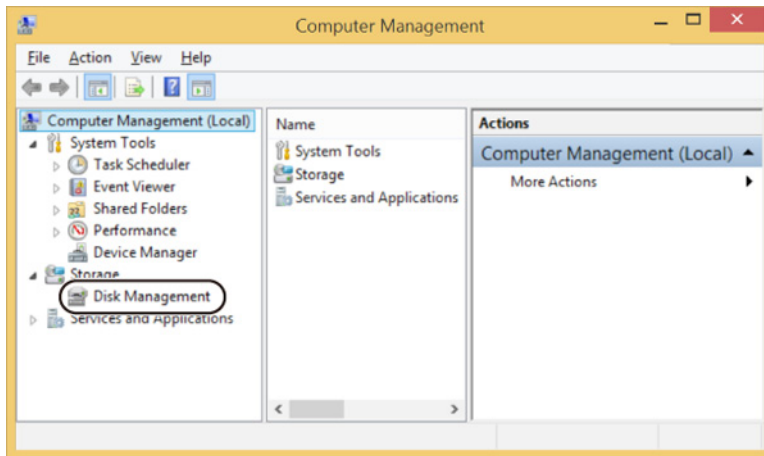

**4** Right-click the disk area assigned to the DriveStation and select *Delete Volume*.

**Notes:**

- Formatting will erase all data on the disk. Don't format the wrong disk!
- If the disk assigned to the DriveStation appears as "Unallocated", proceed to step 6.

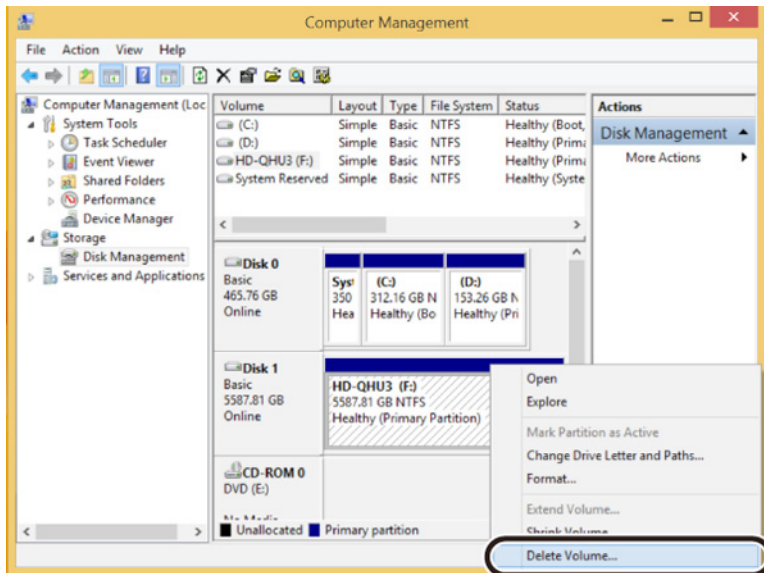

**5** Click *Yes*.

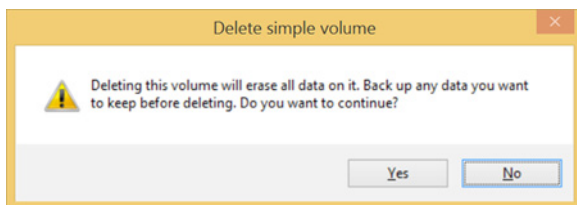

6 Right-click the unallocated space and select *New Simple Volume*.

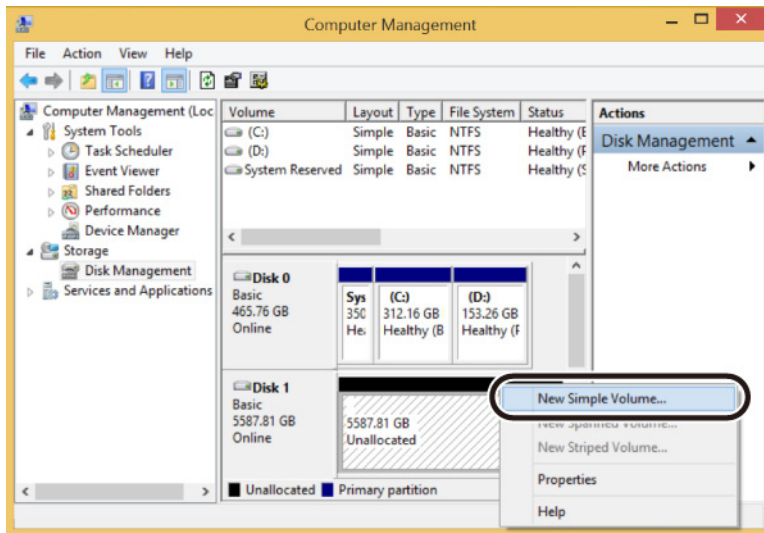

7 Click Next.

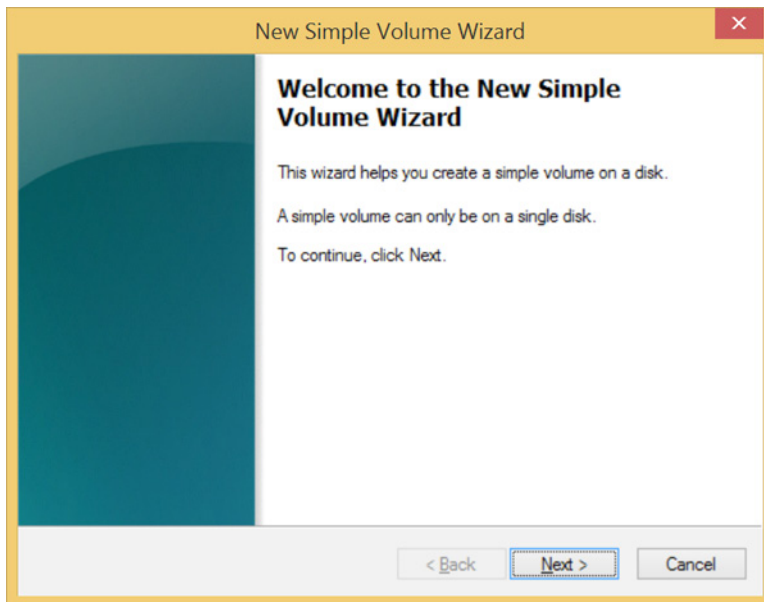

If this screen opens

Select *Primary partition* and click *Next*.

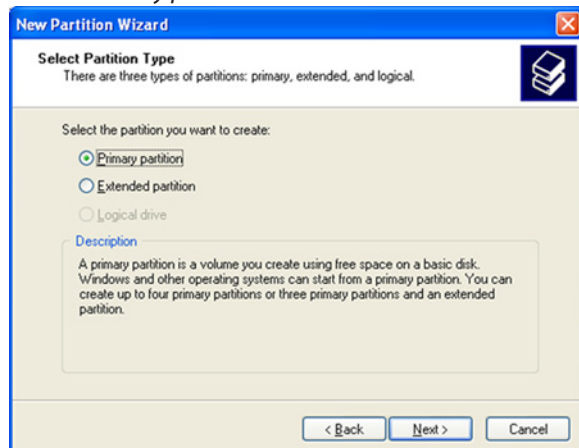

**8** Leave the default (maximum size) setting as it is and click *Next*.

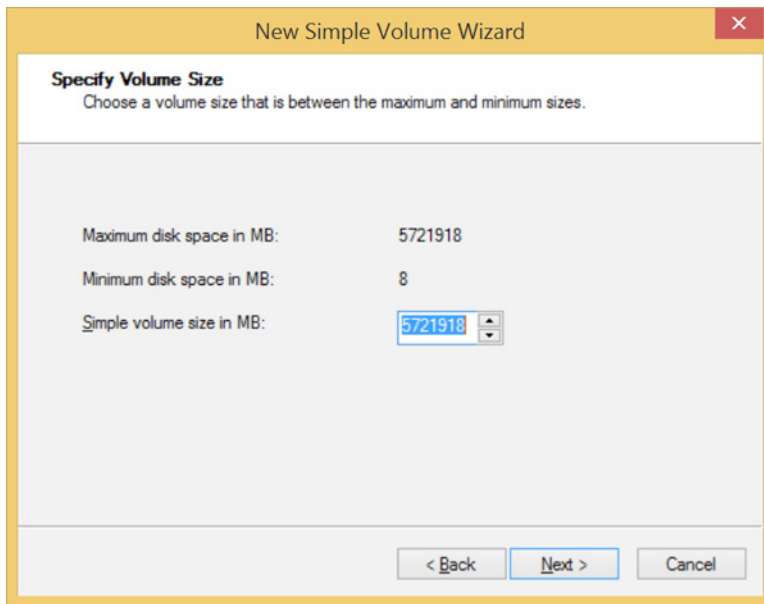

**9** Click *Assign the following drive letter* and specify a drive letter. Leave the other settings at their default values and click *Next*.

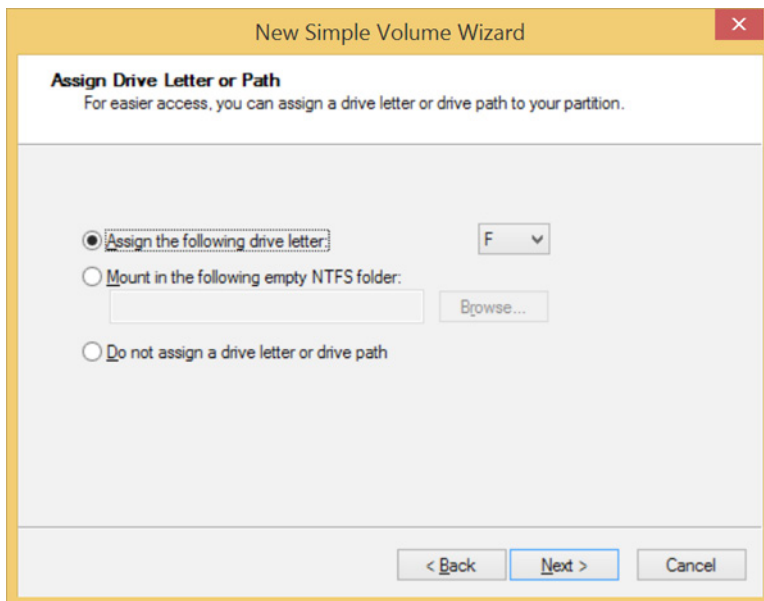

**10** Configure each setting as below.

- (1) Select *Format this volume with the following settings* (*Format this partition with the following settings*).
- (2) Select *NTFS*.
- (3) Leave the allocation unit size set to its default setting.
- (4) Enter a name for the volume.
- (5) Click *Next*.

**Note:** If the DriveStation does not have any partitions, do not insert a check mark for *Perform a quick format*. If a check mark is inserted, the formatting process may not be completed normally.

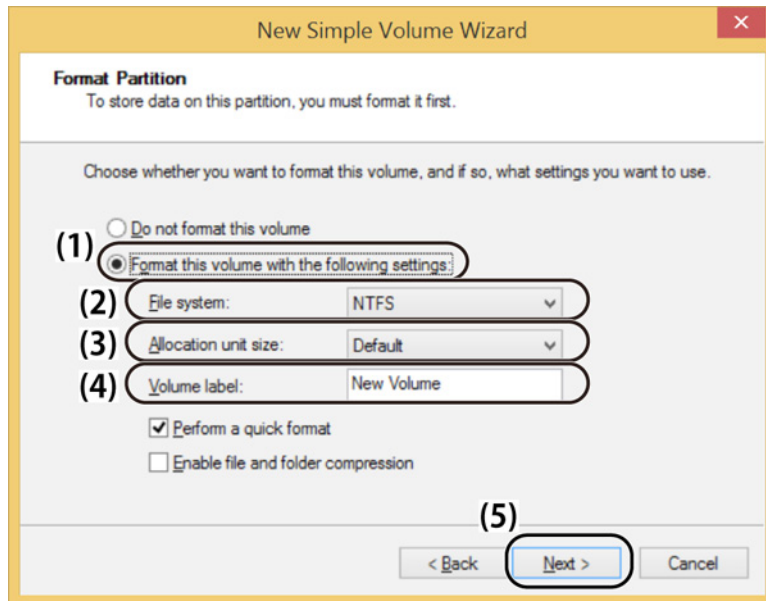

**11** Click *Finish*. Formatting will begin.

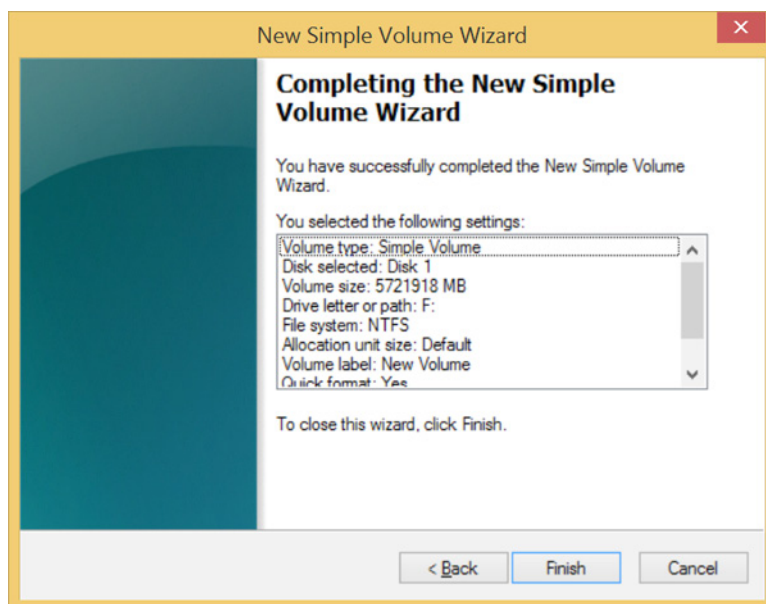

**12** If the formatting process completed normally, "Healthy" is displayed.

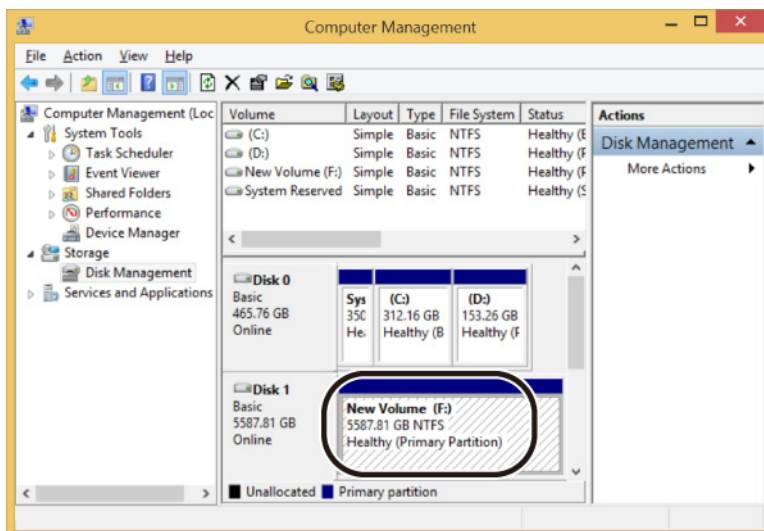

**If the message "The request cannot be completed because the volume is open or in use" is displayed**

The partition was created, but the format didn't complete. Click OK to format the partition as below.

(1) Right-click the newly created partition and select *Format*.

(2) If necessary, set the file system to "NTFS" and enter a name for the volume in the "Volume label" field. Click *OK*.

If *Perform a quick format* is checked, the format will be completed much quicker. (3) Follow the on-screen instructions.

---

## Formatting with HFS+ (Mac)

---

If you want to use the DriveStation with a Mac, follow the procedure below to reformat it with HFS+.

**Notes:**

- Use a Mac computer to format the drive with HFS+. Windows does not support HFS+.
- For more details on HFS+, consult your Mac OS help.

**1** Connect the DriveStation to your computer with the supplied USB cable.

**2** Select *Go - Utilities* from the menu bar.

**3** Double-click *Disk Utility*.

**4** Click the disk to be formatted.



**Note:** Formatting will erase all data on the disk. Don't format the wrong disk!

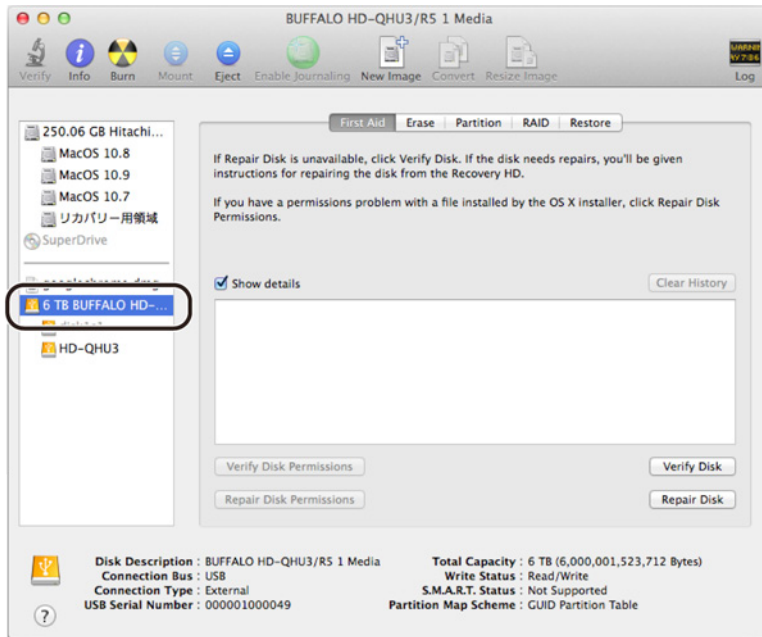

**5** Configure each setting as below.

- (1) Click *Partition*.
- (2) Select *1 Partition*.
- (3) Select the number of partitions that you want to create on the drive.
- (4) Click *Options*.

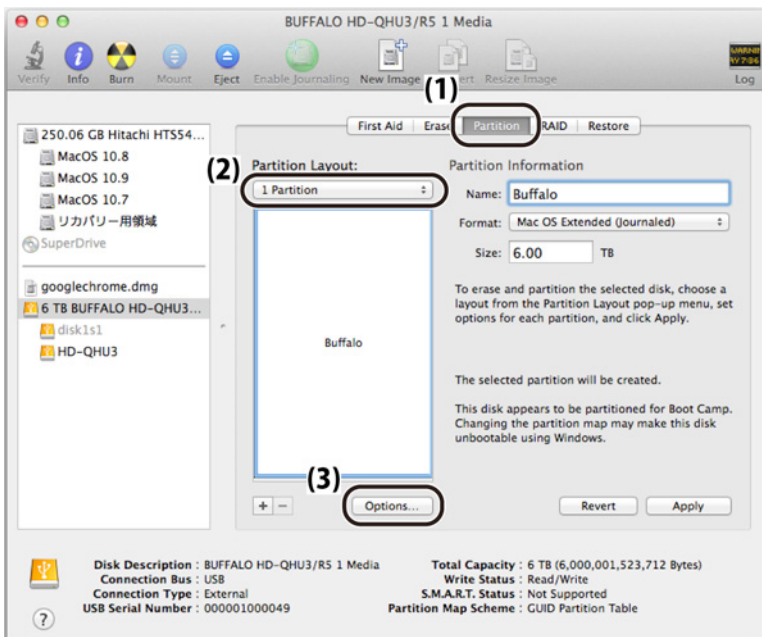

6 Select *Apple Partition Map* and click *OK*.

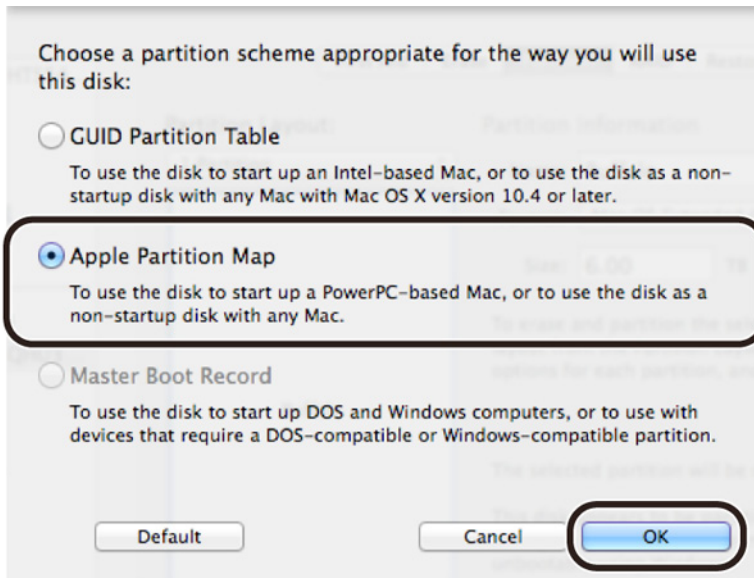

7 Select *Mac OS Extended (Journaled)* and click *Apply*.

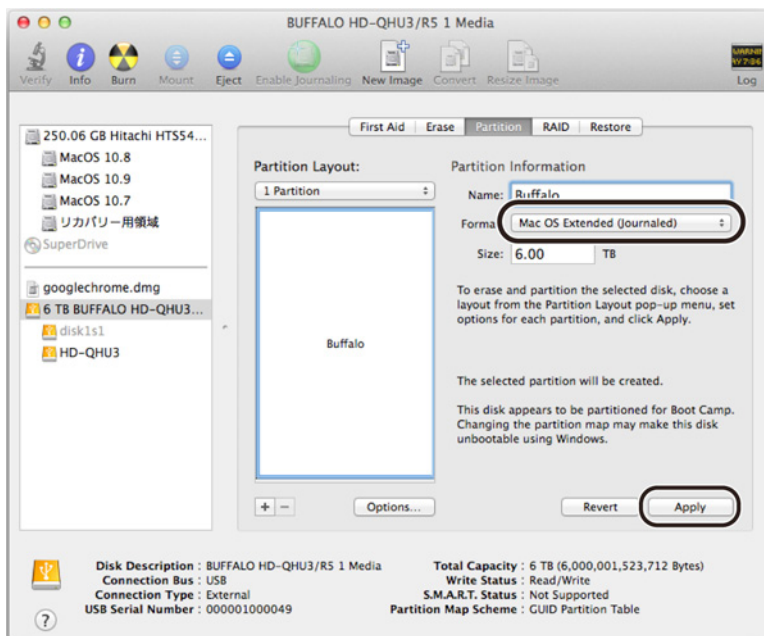

**8** Click *Partition*.



This completes the formatting process.

**Note:** If "Do you want to use Volume\_name to back up with Time Machine?" is displayed, you may click *Use as Backup Disk* and Time Machine will use the drive for backup. If you don't want to use it as a dedicated backup drive, click *Cancel*.

**Note:**

# Regulatory Compliance Information

Only use the cables and accessories that are included in the package. Don't use other accessories or cables unless specifically instructed to in the documentation.

---

## The United States

---

### FCC Statement

This equipment has been tested and found to comply with the limits for a Class A digital device, pursuant to part 15 of the FCC Rules. These limits are designed to provide reasonable protection against harmful interference when the equipment is operated in a commercial environment. This equipment generates, uses, and can radiate radio frequency energy and, if not installed and used in accordance with the instruction manual, may cause harmful interference to radio communications. Operation of this equipment in a residential area is likely to cause harmful interference in which case the user will be required to correct the interference at his own expense.

This device complies with Part 15 of the FCC Rules. Operation is subject to the following two conditions: (1) This device may not cause harmful interference, and (2) this device must accept any interference received, including interference that may cause undesired operation.

### Proposition 65

#### WARNING:

This product and its components contain chemicals known to the State of California to cause cancer and birth defects, or reproductive harm. Wash hands after handling.

---

## Europe

---

### AC Adapter

HD-QHU3R5	Asian Power Devices Inc. DA-90C19 or DA-90F19
-----------	---