



PRODUCT DESCRIPTION

A. Refrigerator Compartment

- 1. Crisper drawer
- 2. Shelves / Shelf area
- 3. Thermostat control knob/light
- 4. Door trays
- 5. Bottle rack
- 6. Removable bottle restraint
- 7. Rating plate (at the side of crisper drawer)
- 8. Ice cube tray
- 9. Low Temperature compartment door

B. Low temperature compartment if *** present

-  Coldest zone
-  Least cold zone

Note: The number of shelves and type of accessories may vary, depending on the model. All shelves, door trays and racks are removable.

Important: Refrigerator accessories must not be washed in a dishwasher.

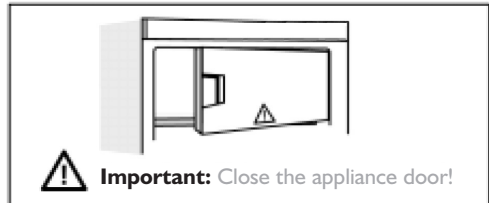
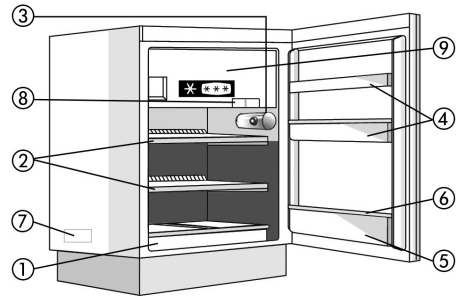
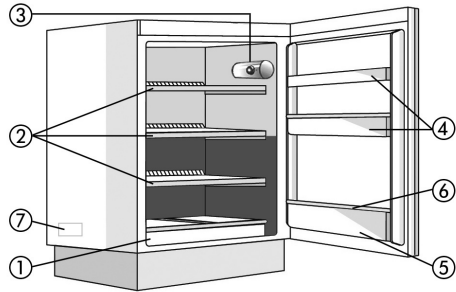

CONTROLS

- A. Thermostat knob
- B. Light switch
- D. Thermostat control reference
- E. Light bulb

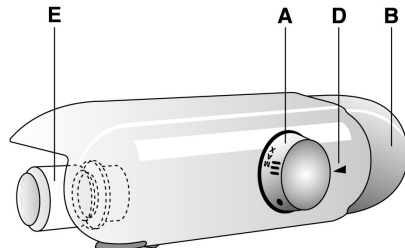

HOW TO OPERATE THE REFRIGERATOR COMPARTMENT

This appliance is an automatic refrigerator or a refrigerator with a  star low temperature compartment.

Defrosting of the refrigerator compartment is completely automatic.

The refrigerator can operate at ambient temperatures between +16°C and +32°C.

Switching on the refrigerator for the first time

Insert the plug into the mains socket.

The thermostat knob is used to adjust the temperature of the refrigerator compartment, maintaining the temperature inside the low temperature compartment.

Adjusting temperature

To adjust the temperature in the compartment, turn the thermostat control knob:

- to lower numbers **1-2/MIN** for the **LEAST COLD** internal temperatures;
- to **3-4/MED** for a **MEDIUM** temperature;
- to **5-7/MAX** for the **COLDEST** temperature.

Thermostat set to •: no operation, no light.

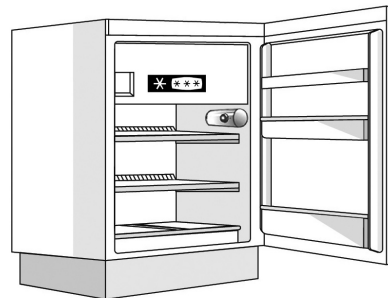
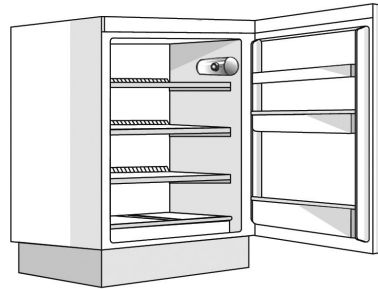

Note:

The ambient temperature, frequency of door opening and position of the appliance can affect the temperatures inside the two compartments.

Take these factors into consideration when setting the thermostat knob.

How to use the refrigerator compartment

Position the food as illustrated in the figure

A. Cooked food

B. Fish, meat

C. Fruit and vegetables

D. Bottles

E. Eggs

F. Butter, cheese and dairy products

Note:

- The space between the shelves and the rear wall of the refrigerator compartment must be unobstructed to allow circulation of air.
- Do not place food in direct contact with the rear wall of the compartment.
- Store liquids in closed containers.
- Even under normal conditions, storing vegetables with a high water content (e.g.: lettuce) can cause condensation to form in the lower drawers and/or on the middle shelves; this will not affect the correct operation of the appliance. However, we recommend vegetables are wrapped in order to avoid formation of condensation.

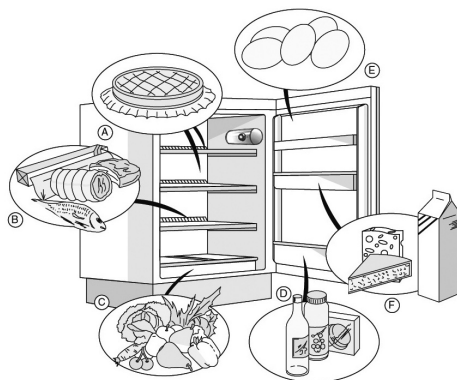

HOW TO OPERATE THE LOW TEMPERATURE COMPARTMENT

The low temperature compartment, if present, is a

✳️** star compartment.

For recommended storage times for frozen foods, see the packaging of individual food products.

When purchasing frozen food products:

- Make sure the packaging is not damaged, since the product quality may have deteriorated. If the package is swollen or has damp patches, it may not have been stored under optimal conditions and defrosting may have already begun.
- When shopping, leave frozen food purchases until last and transport the products in a thermally insulated cool bag.
- Place the items in the low temperature compartment as soon as you get home.
- If food has defrosted even partially, do not re-freeze it. Consume within 24 hours.
- Avoid, or reduce temperature variations to the minimum. Respect the best-before date on the package.
- Always follow the storage instructions on the frozen food packages.

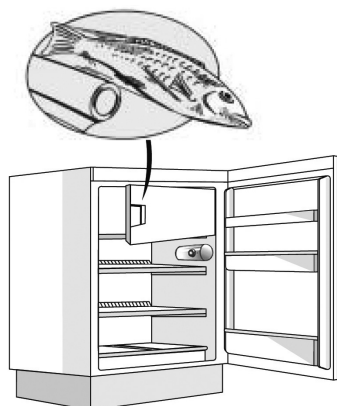

Making ice cubes

- Fill the ice cube tray 3/4 with water and place it on the bottom of the low temperature compartment.

Do not use sharp or pointed instruments to detach the tray if it is stuck to the low temperature compartment **bottom**.

HOW TO DEFROST AND CLEAN THE LOW TEMPERATURE COMPARTMENT

For optimum performance, we recommend the low temperature compartment is defrosted at least twice a year, or when the ice on the walls reaches a thickness of about 3mm.

If possible, defrost the freezer when it is nearly empty.

1. Remove the food from the freezer, wrap in newspaper and group together in a cool place or in a portable cooler.
2. Disconnect the appliance from the mains power supply.
3. Leave the door open to allow the frost/ice to melt.
4. Remove the defrost water with a sponge.
5. Clean the compartment using a sponge dampened in a solution of warm water and neutral detergent. Do not use abrasive products.
6. Rinse and dry carefully.



- **Note: Do not use sharp or pointed metal instruments to scrape off ice; do not heat the low temperature compartment artificially.**

HOW TO CLEAN THE REFRIGERATOR COMPARTMENT

Periodically clean the inside of the refrigerator compartment.

Defrosting of the refrigerator compartment is completely automatic.

Droplets of water on the rear wall of the refrigerator compartment indicate that the periodic automatic defrost cycle is in progress. The defrost water is automatically routed to a drain outlet and into a container from which it evaporates.

Clean the defrost water drain outlet regularly using the tool supplied with the appliance in order to ensure defrost water is removed correctly.

Before carrying out any cleaning operations, unplug the appliance.

- Use a sponge dampened in lukewarm water and/or neutral detergent.
- Rinse and dry with a soft cloth.

Do not use abrasive products.

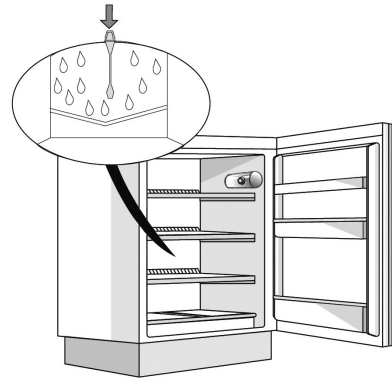

CLEANING AND MAINTENANCE

- Clean the air vents and condenser at the rear of the appliance regularly with a vacuum cleaner or brush
- Clean the outside using a soft cloth

For long vacations

1. Empty the refrigerator and low temperature compartments.
2. Disconnect the appliance from the mains power supply.
3. Defrost the low temperature compartment, and clean and dry both compartments.
4. Leave the doors open to prevent formation of unpleasant odours.

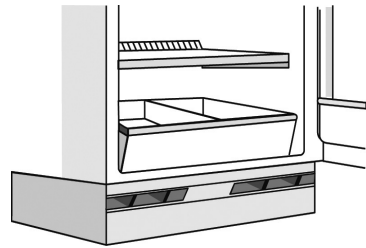

ENERGY SAVING TIPS

- Avoid exposing the appliance to very high temperatures and direct sunlight and do not position it in close proximity to heaters or cookers, since these increase energy consumption.
- Do not obstruct the appliance's air inlet or outlet vents.
- To defrost food, place it in the refrigerator, making best use of the cold temperature produced by the frozen food.
- Restrict the frequency and duration of door opening as much as possible.
- Do not place hot food in the refrigerator compartment.
- Do not leave the low temperature compartment door open.

TROUBLESHOOTING GUIDE

1. The appliance is not working.

- Is there a power failure?
- Is the plug properly inserted in the socket?
- Is the main power switch on?
- Has the fuse blown?
- Is the thermostat set to °?

2. Temperature inside the compartments is not low enough.

- Are the doors closed properly?
- Is the appliance installed near a heat source?
- Is the thermostat setting correct?
- Are the air circulation grilles blocked?

3. Temperature inside the refrigerator compartment is too low.

- Is the thermostat setting correct?

4. Water collects at the bottom of the refrigerator compartment.

- Is the defrost water drain blocked?

5. The inside light is not working.

Perform the checks for problem 1 and then:

- Disconnect the appliance from the mains power supply.
- Replace the lamp with one of the same power or of the max. power in watt, specified near the lamp holder.
- To remove the bulb: unscrew anti-clockwise as shown in the figure.



6. Excessive frost build-up in the low temperature compartment.

- Is the low temperature compartment door closed properly?

Note:

- It is normal for the appliance to make a range of noises (gurgling and hissing due to expansion in the refrigerant circuit ...) during the normal operating cycle.

AFTER-SALES SERVICE

Before contacting the After Sales Service:

1. See if you can solve the problem yourself with the help of the Troubleshooting guide.
2. Switch the appliance off and then on again to see if the problem has been solved. If it has not, switch off the appliance again and repeat the operation after one hour.
3. If the problem persists after this course of action, contact After-sales Service.

Specify:

- the nature of the fault,
- the appliance model,
- the Service number (the number after the word SERVICE on the data plate at the side of the crisper drawer),

- Your full address,
- Your telephone number and area code.

SERVICE 0000 000 00000



Note:

The direction of door opening can be changed. If this operation is performed by After-sales Service it is not covered by the warranty.

INSTALLATION

- Install the appliance away from heat sources (minimum distance: 30 cm from coal and paraffin stoves, 3 cm from ovens and electric cookers).
- Install the appliance in a dry, well-ventilated place.
- **Do not obstruct the appliance's air vents.**
- Clean the inside (see relevant chapters).
- Fit the accessories supplied.

Electrical connection

- **Electrical connections must be made in accordance with local regulations.**
- Voltage and power consumption are indicated on the rating plate at the side of the crisper drawer.

- **Regulations require that the appliance be earthed. The manufacturer declines all liability for injury to persons or animals and for damage to property resulting from failure to observe the above procedures and reminders.**
- If the plug and socket are not of the same type, have the socket replaced by a qualified electrician.
- Do not use extension leads or adapters

Disconnecting the appliance

- It must be possible to disconnect the appliance by unplugging it or by means of a two-pole switch fitted upline of the socket.

ELECTRICAL CONNECTION FOR GREAT BRITAIN AND IRELAND ONLY

Warning - this appliance must be earthed

Fuse replacement

If the mains lead of this appliance is fitted with a BS 1363A 13amp fused plug, to change a fuse in this type of plug use an A.S.T.A. approved fuse to BS 1362 type and proceed as follows:

1. Remove the fuse cover (A) and fuse (B).
2. Fit replacement 13A fuse into fuse cover.
3. Refit both into plug.

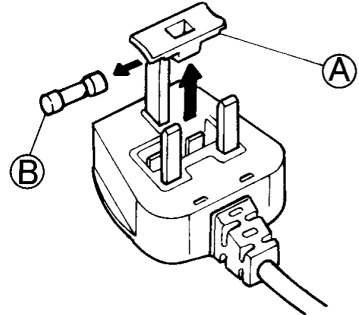

Important:

The fuse cover must be refitted when changing a fuse and if the fuse cover is lost the plug must not be used until a correct replacement is fitted.

Correct replacement are identified by the colour insert or the colour embossed in words on the base of the plug.

Replacement fuse covers are available from your local electrical store.

For the Republic of Ireland only

The information given in respect of Great Britain will frequently apply, but a third type of plug and socket is also used, the 2-pin, side earth type.

Socket outlet / plug (valid for both countries)

If the fitted plug is not suitable for your socket outlet, please contact After-sales Service for further instruction. Please do not attempt to change plug yourself. This procedure needs to be carried out by a qualified technician in compliance with the manufactures instructions and current standard safety regulations.