

M Series

3D mapping

Auditoriums

Boardrooms

Broadcast studios

Business presentations

Civil engineering

Construction management

Energy

Events and large venues

Home cinema

Houses of worship

Industrial design

Medical training

Museums and education

Post-production

Scientific research

Theme parks

And more...



Redefine your expectations.

CHRISTIE[®]

We didn't just raise the bar, we redefined the entire game.

The Christie M Series shining even brighter than before

We've designed the M Series, a flexible, efficient line of 3-chip DLP® projectors, with your needs in mind.

The most compact in its class, this dual mercury lamp platform, now with even more choice in brightness levels, provides the high-performance and feature-rich standards you've come to expect from all Christie® products. We've also made it possible to future-proof your investment. Select M Series¹ projectors can be upgraded from their existing 2D display technology to include 3D capabilities – ensuring your 3D needs are met for today and tomorrow.

Ranging from 2360 ANSI (2600 center) lumens (single lamp, 200W) to 12,500 ANSI (14,000 center) lumens (dual lamp, 450W), each M Series projector offers high efficiency and low cost of ownership by operating at 1500W (450W lamp) – giving you full brightness while using less power.

The Christie M Series platform includes four resolutions, WXGA (1366 x 768), SXGA+ (1400 x 1050), HD (1920 x 1080) and WUXGA (1920 x 1200), all with a variable contrast ratio of 2500-10,000:1² full on/full off (650:1 ANSI) for crisp, detailed images. Each of the projectors in the series can also be fitted with the broadest range of high quality lenses – all with true Intelligent Lens System (ILS™) capabilities.

All this, combined with a 3-year warranty and our industry leading service and support, enables the M Series to provide high performance and peace of mind for everyone.

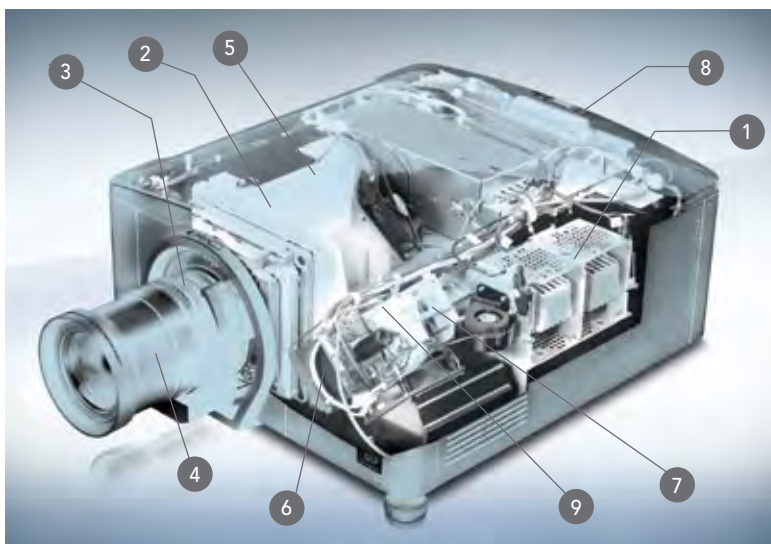

Brightness	Center lumens	Resolution
Christie WX7K-M ¹	6270	WXGA
Christie WX10K-M ¹	10,450	WXGA
Christie DS+6K-M	6930	SXGA+
Christie DS+10K-M	11,550	SXGA+
Roadster S+10K-M	11,550	SXGA+
Christie DS+14K-M	14,000	SXGA+
Roadster S+14K-M	14,000	SXGA+
Christie HD6K-M	6300	1080 HD
Christie HD10K-M	11,000	1080 HD
Roadster HD10K-M	11,000	1080 HD
Christie HD14K-M	13,500	1080 HD
Roadster HD14K-M	13,500	1080 HD
Christie WU7K-M	6930	WUXGA
Christie WU12K-M	11,550	WUXGA
Roadster WU12K-M	11,550	WUXGA
Christie WU14K-M	14,000	WUXGA
Roadster WU14K-M	14,000	WUXGA

[1] Dual-lamp system^{3, 4}

High-efficiency, dual-lamp system

200W, 350W or 450W (two-lamp system)

120V (operation) for full brightness

At maximum brightness 12,500 ANSI (14,000 center) lumens the unit only draws 1500W (450W lamp)

Stand-by power consumption (phantom power draw) is less than 20W

Lamps can be hot swapped while projector is powered on and in use

Brightness		200W	350W	450W
Dual lamp	max power	6300 ANSI lumens (6930 center lumens)	10,500 ANSI lumens (11,500 center lumens)	12,500 ANSI lumens (14,000 center lumens)
	min power	4725 ANSI lumens (5200 center lumens)	8535 ANSI lumens (9400 center lumens)	9740 ANSI lumens (10,900 center lumens)
Single lamp	max power	3150 ANSI lumens (3465 center lumens)	5250 ANSI lumens (5775 center lumens)	6250 ANSI lumens (7000 center lumens)
	min power	2360 ANSI lumens (2600 center lumens)	4260 ANSI lumens (4700 center lumens)	4870 ANSI lumens (5450 center lumens)

▲ Lumen values are for SXGA+ models. Flexible lumens levels at various lamp powers. Lamp power is specific to each model and cannot be interchanged.

Dual lamp design vs quad (4) lamp design

A dual lamp design:

Uses less power to achieve the same levels of brightness as quad lamps

Lowers cost of ownership:

- Only two lamps need to be replaced instead of four
- Less energy is used to power the projector

Redundancy – the second lamp remains in a state of readiness for continuous uptime

Flexibility – you can choose to operate in: Single lamp mode:

- When ambient light is controlled
- Enhances energy and cost savings
- Extends life of the projector

Dual lamp mode is ideal for applications where increased brightness is required

Consistent 24/7 operation – a dual lamp design enables continuous projection for long periods of time

¹ WXGA models are not 3D capable. ² Using dynamic iris. ³ US Patents 7,230,768; 6,205,271; 6,734,957. ⁴ Patent pending.



▲ 3-chip DLP technology



▲ Intelligent Lens System



▲ Full suite of lenses



▲ LCD keyboard

[2] Image quality

3-chip DLP technology, high-quality optics and world-class 10-bit image processing.

With low maintenance and highly reliable (>100,000 MTBF for DMDs) DLP technology, the Christie M Series delivers:

- High brightness
- Excellent color
- Excellent uniformity
- High contrast
- Excellent fill ratio

[3] Intelligent Lens System (ILS)

The ILS automatically recognizes and calibrates a lens when it is installed. Stepper motor based encoding ensures that motor drift does not occur, as typically found with DC encoded motors, providing accurate and repeatable recall of all lens offset, zoom and focus positions. This lens system ensures that the images adjust to optimize screen coverage and maintain alignment in applications with moving screens or variable aspect ratios.

[4] Expanded lens suite

With the addition of a short zoom (1.25-1.6:1 SX+/1.16-1.49:1 HD) and a long zoom (7.5-11.2:1 SX+/6.9-10.4:1 HD), this expanded suite provides the broadest range of HD lenses in this marketplace.

LCD keyboard

This easy-to-use LCD keypad includes:

Contextual menus providing a fully-featured, intuitive interface; removing the need for a cluttered keypad

Large, four line LCD display

Adjustable brightness and timed LCD off mode

Intuitive keypad design that lights up when features are active – making it user friendly

Active keys that are color-coded amber to indicate that selections will result in changes visible to the audience

[6] Motorized yellow notch filter

The motorized yellow notch filter optically expands the color gamut for richer greens and yellows. Since you lose some brightness by improving the greens and yellows, this is a channel-configurable option which enables you to decide when it is needed. This filter, available on M Series HD and WUXGA models only¹, is ideal when video is being displayed.

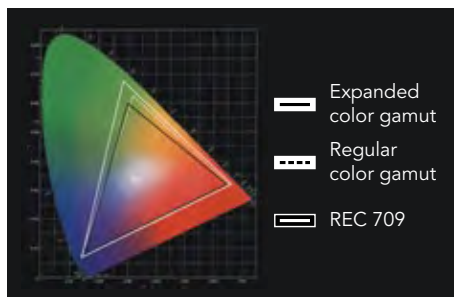

▲ Standard color gamut



▲ Expanded color gamut

¹ Not available in: DS+14K-M, Roadster S+14K-M, HD14K-M, Roadster HD14K-M, WU14K-M, Roadster WU14K-M models.

[7] Dynamic iris¹

Ideal for video applications, the dynamic iris is a channel-configurable option. It automatically adjusts an internal iris to extend the range of blacks and provide richer details during dark scenes for true image reproduction. A variable contrast ratio of 2500-10,000:1 produces a picture with a rich, dynamic appearance.

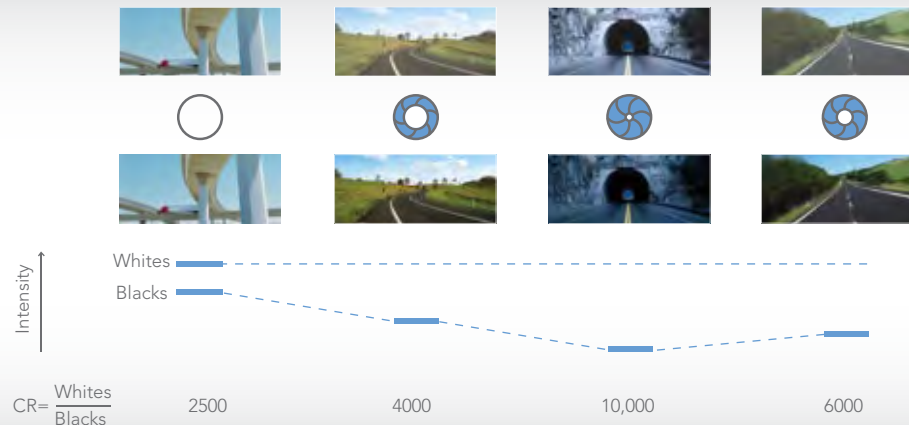

No Dynamic iris – standard contrast ratio.

Dynamic iris – this feature dramatically increases the on/off contrast ratio of the system. A fast-acting dynamic iris optically minimizes the black levels in the image while electronically increasing the gain in the image which enhances the overall detail in the blacks.

[8] Embedded Christie Twist

Standard in all Christie M Series models, Christie Twist™ enables seamless edge-blending of multiple curved images faster and more easily than through traditional, manual methods. Controlled by an easy-to-use GUI, users can expertly control and edge-blend or stack multiple curved images. As well, images can be warped to fit virtually any dimension or shape display. Embedded Christie Twist ensures that all M Series projectors work with value-added accessories, such as Christie AutoStack™.

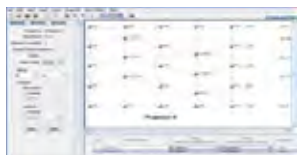

▲ Easy-to-use GUI



▲ Easy-to-use GUI



▲ Image on curved screen – without blending



▲ Curved screen – with blending

[8] Multi-window/screen processing

External processors are not required for simple, small tiled and blended arrays, therefore lowering your costs for installation. Each M Series projector has the ability to send signals to multiple projectors (up to a 3x3 array) without any additional hardware or software. The projectors in the tiled array can then show only the portion of the signal that they need to project.

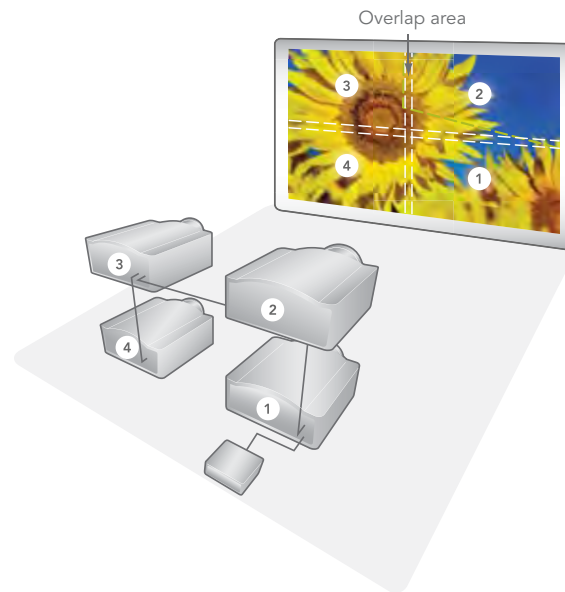

[8] Embedded edge blending and color matching

Advanced blending capabilities and Comprehensive Color Adjustment (CCA™) ensure digitally accurate color matching and uniformity across multi-screen blended or tiled images.

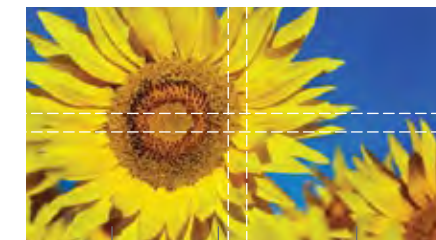

Color matching Edge blending

▼ Without edge blending

▼ With edge blending

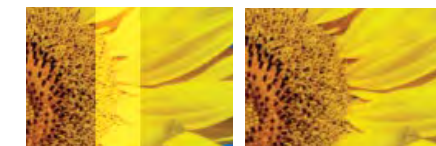

Overlapping image edges

¹ Not available in DS+14K-M, Roadster S+14K-M, HD14K-M, Roadster HD14K-M, WU14K-M, Roadster WU14K-M, Mirage DS+14K-M, Mirage HD14K-M, Mirage WU14K-M models.

Comprehensive Color Adjustment (CCA)



Sound and Output Frequency

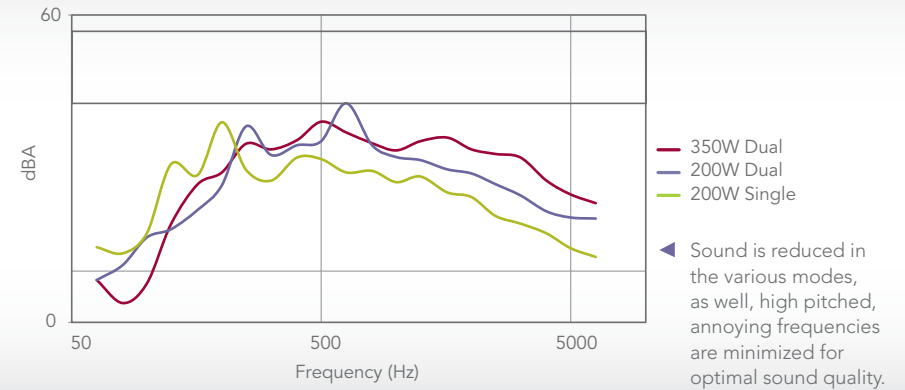

[8] Projector control and management

Users can access all projector menus and control through a web interface (via Ethernet) without disrupting the live presentation. This allows for real-time adjustments and monitoring of each projector on the network – regardless of geographic location.



▲ Main page controls and information

▲ Virtual On Screen Display (OSD): access full menu structure, remotely



▲ Status and diagnostics: display alarm events for quick projector monitoring and diagnosis

▲ Admin screen includes upload, backup, restore and more

[8] Automatic shut-off¹

This feature lowers the cost of ownership by reducing power consumption and extending lamp life when the projector is not in use. In this mode, if a signal is not detected, the projector will close the shutter and reduce power to the lamps. If there is still no signal, the system will go into standby mode. If a signal is detected during the ramp-down phase, the unit will revert back to its full power, dual lamp mode.

Lamp Power Management (LPM)

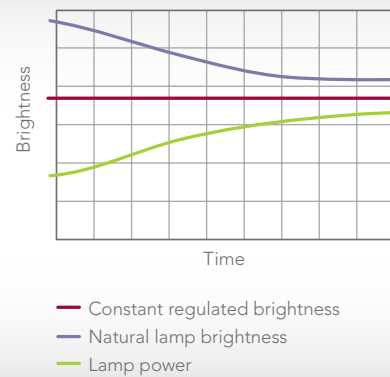

▲ Main page controls and information

▲ Virtual On Screen Display (OSD): access full menu structure, remotely



▲ Status and diagnostics: display alarm events for quick projector monitoring and diagnosis

▲ Admin screen includes upload, backup, restore and more

Quiet operation

When a presentation depends on the full attention of the audience, noise from a projector can be distracting. The filter-free design with auto-sensing fan and temperature sensors automatically adjust for a virtually noise-free operation.

[9] LiteLOC

The LiteLOC™ feature automatically manages your display's brightness levels over time so that you can match the brightness of a multiple projector system in tiled or blended arrays. This feedback system continuously monitors lamp brightness, so that as the lamp goes through its natural brightness decay, the system increases the lamp power in order to maintain consistent brightness.



▲ Without LiteLOC

▲ With LiteLOC

Aspect ratios

Wide screen ratios provide a multitude of benefits in a variety of different projection applications. Carefully matching the pixel format of the projector with that of the sources to be displayed will ensure the best image quality and maximum impact. The M Series offers 4:3, 16:9 and 16:10 models to match the aspect ratio requirements of any application.



WUXGA HD SXGA+ WXGA

¹ Users determine the length of time before shutter closes, as well as when to go into stand-by mode.

[8] Input cards

In total, there are four input card slots available. Each projector is equipped with a standard set of input cards.



Twin HDMI input card

The Twin HDMI™ input card accepts two HDMI inputs and provides 12-bit deep color handling on the input. It also supports the HDMI v1.4a format required for 3D systems providing the projector is upgraded with 3D capabilities. Additionally, advanced loop-through allows any input on any input card to be looped through to the two HDMI outputs on the card.

This functionality ensures that when stacking systems with any input, the Twin HDMI card can be used to send the signal to a second projector. This stacked system is also a passive loop-through providing the repeater projector has AC power, even when powered off, the signal will continue to be looped out to the second projector.



Analog input card

The Analog input card accepts an analog video signal input over a 5 BNC connector interface. It can accept RGBH&V signals over 5 connectors, as well as component YPrPb signals on the RGB inputs.



Dual-link DVI input card

The Dual-link DVI input card has a 330 MHz DVI-I connector which can support a single or dual-link DVI, analog and HDCP video signals with proper cables. There is also an additional 15-pin VGA connector. Only one input is active on this card at a time. Christie Mirage M Series models come standard with two of these cards installed.



Dual 3G SD/HD-SDI input card

The Dual 3G SD/HD-SDI input card accepts both standard definition (SD) and high-definition (HD) serial-digital-interface (SDI) signals, and enables you to connect two of either types of signal. Both single-link HD and dual-link HD signals are accepted. This card also has two 3G SD/HD-SDI outputs to enable "loop-through" for its respective input.



Video decoder input card

The Video decoder input card accepts various types of standard definition (SD) video, including CVBS (composite video), S-video, and component. It accepts NTSC 3.58, NTSC 4.4, PAL, PAL-N, PAL-M or SECAM formats. This card has two mini-DIN connectors (for S-video signals) and four BNC connectors that can be grouped to allow combinations of CVBS, S-Video, YPbPr or RGB video sources.



▲ Christie Roadster HD10K-M



▲ Optional coarse dust filter



▲ Optional fog juice filter



◀ Christie YK100

Roadster models

The Christie M Series Roadster models have been designed with staggers in mind. Each of these Roadster models ships equipped with more input cards than the other M Series models, as well as a stacking frame.

Christie AutoStack

Christie AutoStack is a software driven, camera-based system that enables stacking and blending of projector arrays in a fraction of the time it takes to do manually and automates the regular maintenance of a blended display. It is designed for use on a flat screen and supports various screen sizes and aspect ratios, using screen points for quick geometric calibration. An optional curve module (sold separately) is also available for curved screen applications.

DMX512 interface card

This interface card supports the DMX512 communication standard through two 5-pin XLR connectors.



Filters (optional)

If the environment you're working in requires more than the protection of our dust sealed engine, choose from one of two filters (coarse dust and fog juice). Help extend the life of your projector and protect your investment from dirt, dust, sand as well as fog, smoke, hazers and pyrotechnics. Each Christie M Series projector is equipped with two removable side panels that are designed to hold a filter, if required.

[5] Dust sealed engine

Christie M Series projectors can operate filter-free because of dust-sealed engines and optics. Since dust and dirt cannot affect the system and filters are not required, image quality is maintained and maintenance costs are lower. Removable side panels enable the addition of optional coarse dust and fog juice filters for projectors that are exposed to harsh environments.



▲ Dust sealed engine

Christie YK100

All Christie M Series projectors can be used with the Christie YK100, a single-arm yoke moving projection system, to give you a range of brightness levels (6270 to 14,000 center lumens) and resolutions to choose from. Each Christie M Series model comes equipped with DMX512 capabilities, which makes it easy to use with the yoke since this solution can be controlled by the same console as your lighting equipment.

These versatile yokes can be flown, rigged or set up at floor level, according to your application needs.

Portrait display capabilities

All Christie M Series projectors have built-in capabilities to project in portrait orientation - no additional equipment required. Legacy M Series models require the latest firmware to enable portrait capabilities.



◀ The M Series in portrait orientation.

Innovative high-performance 3D

When you want crisp and detailed 3D images, think Christie Mirage M Series.

Whether using active or passive display technology, the Christie Mirage M Series is easy to set up and configure. The most compact 3-chip DLP active stereo projectors in their class, the Christie Mirage M Series delivers visually stunning 3D for boardrooms, home theater, museums, education, scientific research, virtual prototyping, oil and gas exploration and anything in between.

Offering complete compatibility with today's 3D home entertainment requirements, the Christie Mirage M Series is ready for Blu-ray 3D™ video, PS3 and other gaming consoles and meets the mandatory 3D spec for HDMI v1.4a. To ensure your 3D solution is complete, Christie also offers a range of accessories that include: 3D glasses (active and passive), emitters and modulators.

Powered by dual image processing, the Christie Mirage M Series displays full resolution at a native frame rate up to 120Hz. Two standard Dual-link DVI input cards support 330 MHz bandwidth for full resolution Dual Input 3D.

For the ultimate home theater including Blu-ray 3D video content, the Christie Mirage M Series uses triple flash to provide the best images possible, no matter how fast-motion your content might be. You can count on Christie to ensure the highest image quality and a comfortable theater-like viewing experience.

Active stereoscopic viewing – single projector

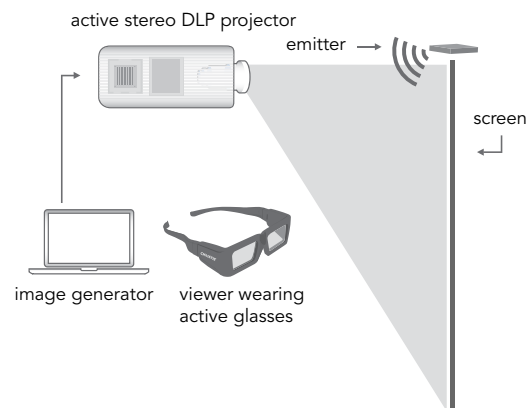

Active stereoscopic viewing

Active stereoscopic displays provide the best 3D imagery available today. Active stereo is typically used for applications where vivid color reproduction and finite detail are required for precise content in key decision making applications. Offering the most detailed and life-like 3D images, the Christie Mirage M Series supports full resolution at 330 MHz and can be used with Christie Mirage 3D active stereoscopic accessories, including an emitter and LCD shutter glasses.

Active single projector versus stacked dual projectors

Single, active 3D projection eliminates the need to stack, align and color match projectors and continually monitor and match brightness of two projectors for consistent left eye/right eye display. Typically for comparable brightness, single active 3D projection will operate with less noise, heat, physical space requirements and consumables along with fewer failure points and overall lower power consumption.

Active stereoscopic viewing – multiple projectors

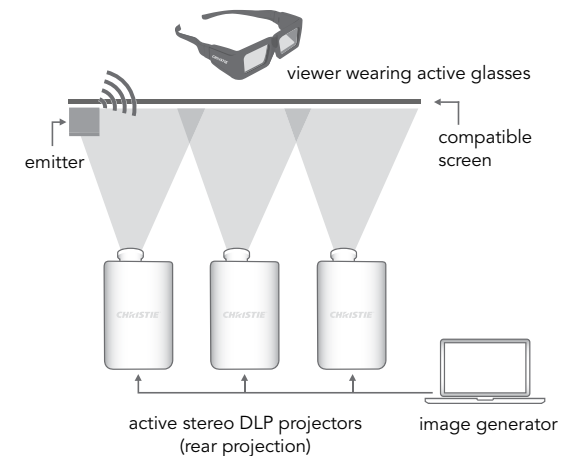

Active stereoscopic viewing – multiple projectors

For applications that require a larger display for 1:1 scale visuals, you can use multiple Christie Mirage M Series projectors blended into a single, larger display.

Passive stereoscopic viewing – single projector

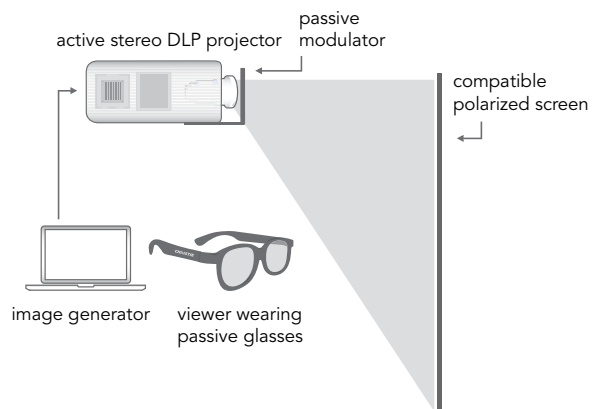

Passive stereoscopic viewing

When it comes to 3D for a larger crowd, passive stereoscopic displays offer the best return on investment. Using low-cost polarized glasses that can be given away or recycled after a single use, a passive stereo display is a cost effective way to deliver quality 3D images. Combine a silver screen and Christie Mirage M Series projectors with Christie Mirage 3D accessories, including our passive modulator and circular polarized 3D glasses, and you can bring incredible eye-popping 3D to even the largest of audiences!



▲ University of Reims Champagne-Ardenne (URCA), 3D display used for scientific research and development

Model	Center lumens	Resolution
Mirage DS+6K-M	6930	SXGA+
Mirage DS+10K-M	11,550	SXGA+
Mirage DS+14K-M	14,000	SXGA+
Mirage HD6K-M	6300	1080 HD
Mirage HD10K-M	11,000	1080 HD
Mirage HD14K-M	13,500	1080 HD
Mirage WU7K-M	6930	WUXGA
Mirage WU12K-M	11,550	WUXGA
Mirage WU14K-M	14,000	WUXGA

Proven 3D technology

With over a three-decade history of development and integration of 3D displays, Christie offers the benefit of experience. Evolving from original CRT-based technology, we developed a truly game-changing 3D display with the world's first purpose-built 3-chip DLP active stereo projector line – Christie Mirage. Christie Mirage is a full 3D display product line that offers a range of brightness levels, resolutions and active or passive stereoscopic options that enable 3D displays to be used in any application.



▲ Christie 3D active glasses



▲ Christie 3D passive glasses



▲ Emitter (active) – standard and long range



▲ Modulator (passive)

Benefits of 3D

- Provides perspective not possible with traditional 2D software and tools
- Reduces time to market
- Excites audiences ... WOW! factor
- Accelerates understanding and decision making
- Enables faster, more intuitive interaction with data
- Promotes collaboration and focus on collective strengths
- Ensures greater accuracy of concepts and designs
- Removes inherent boundaries found in traditional tools

3D Accessories

	Description	Part number
Active stereoscopic	Glasses – single	108-407102-XX
	Glasses – 5 pack	108-408103-XX
	Glasses – 10 pack	108-409104-XX
	Emitter – standard range	108-410106-01
	Emitter – long range	108-415101-01
Passive stereoscopic	Glasses – single	108-412108-XX
	DepthQ polarization modulator	108-411107-XX

Source	Input signal type	Dual DVI input card DVI-D	VGA	HDMI	Analog BNC input card RGB/YPrPb	SDI
Data/Graphics	frame sequential – native 3D	• Range 96-120Hz (48-60Hz per eye, >165MPixels < 330MPixels)	•	•	•	•
		• Range 96-120Hz (48-60Hz per eye, <165MPixels)	•	•	•	•
	frame doubled <165MPixel	• Range 48-60Hz (24-30Hz per eye) doubled to 96-120Hz	•	•	•	•
	dual input 3D each input <165MPixel	• 2 input cards: 48-60Hz per eye. Two identical format, frame-locked, passive 3D inputs are fed into the projector and frame-interleaved to create active 96-120Hz 3D	•	•	•	•
		• 1 input card: 48-60Hz per eye. Two passive 3D inputs are fed into the projector, one per eye on the same input card and frame-interleaved to create active 96-120Hz 3D			•	•
	frame tripled – triple flash1	• Range 48Hz (24Hz per eye) tripled to 144Hz	•	•	•	

Source	Input signal type	Dual DVI input card DVI-D	VGA	HDMI	Analog BNC input card RGB/YPrPb	SDI
Blu-ray	for movie content: <165MPixel					
	frame packing	• 1080p @ 23.98/24Hz	•	•		
	frame tripled – triple flash (automatically) ²	• Range 48Hz (24Hz per eye) tripled to 144Hz		•		
PS3, XBOX, PC	for game content: <165MPixel					
	frame packing	• 720p @ 50 or 59.94/60Hz	•	•		
Sat/Cable, Set top box etc.	for broadcast content: <165MPixel					
	side-by-side horizontal	• 1080i @ 50 or 59.94/60Hz	•	•	•	•
		• 720p @ 50 or 59.94/60Hz	•	•	•	•
	top and bottom	• 1080p @ 23.97/24Hz	•	•	•	•
		• 720p @ 50 or 59.94/60Hz	•	•	•	•

• = Available

Standard 3D inputs

Whether your data content or images are being generated by a computer, a Blu-ray player, a gaming console, or a server – 3D content comes in a wide variety of shapes and sizes. The way that your content is distributed can have an impact on your 3D experience.

3D upgradable

Christie also makes it easy to future proof your investment by being the first in the industry to offer upgrade paths for select 3-chip DLP projectors to Mirage Series models. Whether you need 3D capability today or tomorrow, Christie has the innovation, breadth of technologies, engineering strength and the integration expertise to offer the right display solutions to fit your business needs.



	Description	Part number
3D upgrade kits ³	Kit upgrade DS+6K-M to Mirage	118-117100-XX
	Kit upgrade DS+10K-M to Mirage ⁴	118-118101-XX
	Kit upgrade DS+14K-M to Mirage ⁴	118-123107-XX
	Kit upgrade HD+6K-M to Mirage	118-119102-XX
	Kit upgrade HD10K-M to Mirage ⁴	118-120104-XX
	Kit upgrade HD14K-M to Mirage ⁴	118-124108-XX
	Kit upgrade WU7K-M to Mirage	118-121105-XX
	Kit upgrade WU12K-M to Mirage ⁴	118-122106-XX
	Kit upgrade WU14K-M to Mirage ⁴	118-125109-XX

¹ Legacy Christie Mirage M Series models require the latest firmware to enable triple flash capabilities.

² Blu-ray content is forced to be triple flashed (144Hz output). Users should not need to select "Triple Flash" from the menu.

³ WXGA models are not 3D capable. ⁴ Can also be used with equivalent Christie M Series Roadster model.



▲ Optional stacking frame



▲ Replacement lamp



▲ Optional lenses



▲ Optional Christie AutoStack



▲ Optional ceiling mount

Accessories

Whatever you need, Christie has a large selection of optional accessories. Create the projector you need by choosing from eight lenses, various input cards and much more.

	Description	Part number
Lens – fixed	Lens ILS 0.73:1 SX+/0.67:1 HD	118-100110-XX
	Lens ILS 1.2:1 SX+ /1.1:1 HD	118-100117-XX
Lens – zoom	Lens ILS 1.25-1.6:1 SX+/1.16-1.49:1 HD	118-100111-XX
	Lens ILS 1.5-2.0:1 SX+/1.4-1.8:1 HD	118-100112-XX
	Lens ILS 2.0-2.8:1 SX+/1.8-2.6:1 HD	118-100113-XX
	Lens ILS 2.8-4.5:1 SX+/2.6-4.1:1 HD	118-100114-XX
	Lens ILS 4.5-7.5:1 SX+/4.1-6.9:1 HD	118-100115-XX
	Lens ILS 7.5-11.2:1 SX+/6.9-10.4:1 HD	118-100116-XX
Lamps¹	Assembly 200W lamp	003-100856-XX
	Assembly 350W lamp	003-100856-XX
	Assembly 450W lamp	003-102385-XX
Input cards	Analog input	108-309101-XX
	Dual link DVI input	108-312101-XX
	Video decoder input	108-310101-XX
	Dual 3G SD/HD-SDI input	108-313101-XX
	Twin HDMI input	108-311101-XX
	DMX512 interface	108-314101-XX
Miscellaneous accessories	Coarse dust filter pack M Series	118-100104-XX
	Fog juice filter pack M Series	118-100105-XX
	Stacking frame	118-100107-XX
	Ceiling mount	118-100108-XX
	Ceiling mount extension	104-101001-XX
	ILS lens adapter kit	108-331108-XX
	Christie AutoStack	108-423100-XX

¹ Lamp power is specific to each model and cannot be interchanged.

Environmental commitment

We recognize our responsibility to control the impact our business activities, products and services have on the environment. We're fully committed to finding and using environmentally friendly solutions, and to meeting or exceeding applicable laws, regulations and organizational objectives.

You'll notice that the Christie M Series includes features that support our commitment to being eco-friendly. As an industry leader, we are committed to the prevention of pollution and continual improvement through implementation of our ISO14001 registered environmental management system.

Efficiency

The lamps used in Christie M Series projectors produce the highest lumens per watt, enabling brighter images without additional power requirements.

Auto shut-off and eco mode

Reduce your cost of ownership by reducing power consumption and extending lamp life when the projector isn't being used. These projectors can run in eco mode, which reduces brightness and therefore reduces your power requirements and extends the life of your lamp. A reduction in the projector's thermal output minimizes energy use and possible air-conditioning needs.

Low power stand-by modes

Stand-by power consumption (phantom power draw) is less than 20W.



- ▲ The Christie solution at ESRI headquarters in Redlands, CA was chosen because it met the business and technical requirements for each room, was easy to use, and fell within budget.
- ◀ Perfect edge-blending, multi-windowing and screen processing in the Command Center and Rail Operation Center of the Washington Metropolitan Area Transit Authority.

Expanded lens suite

This full suite of fixed, short zoom and long zoom lenses for WXGA, SXGA+, HD and WUXGA resolutions, provides the broadest range of lenses in this marketplace.

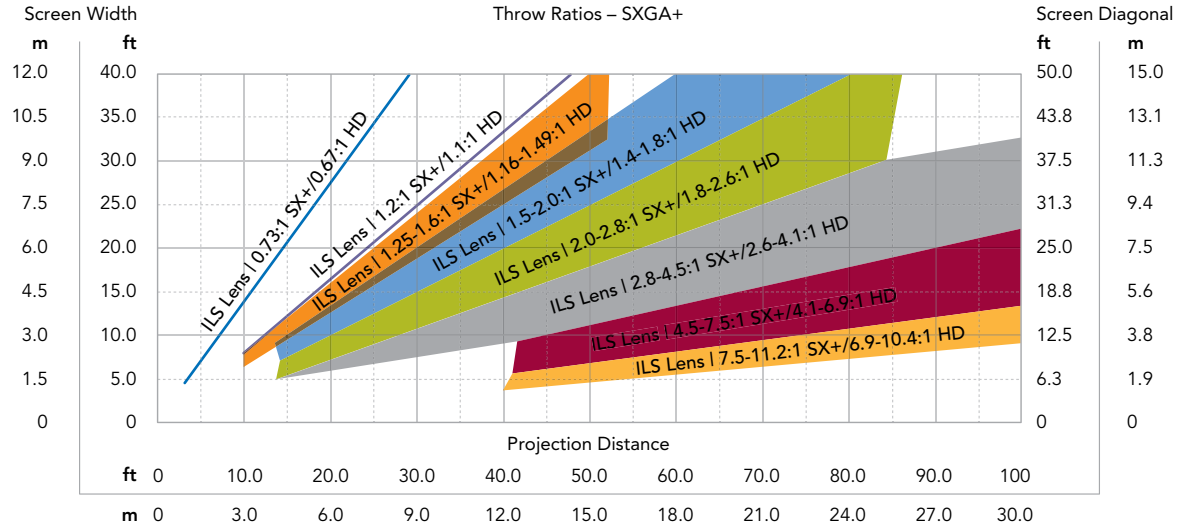

Lenses	Part number
ILS Lens 0.73:1 SX+/0.67:1 HD	118-100110-XX
ILS Lens 1.2:1 SX+/1.1:1 HD	118-100117-XX
ILS Lens 1.25-1.6:1 SX+/1.16-1.49:1 HD	118-100111-XX
ILS Lens 1.5-2.0:1 SX+/1.4-1.8:1 HD	118-100112-XX
ILS Lens 2.0-2.8:1 SX+/1.8-2.6:1 HD	118-100113-XX
ILS Lens 2.8-4.5:1 SX+/2.6-4.1:1 HD	118-100114-XX
ILS Lens 4.5-7.5:1 SX+/4.1-6.9:1 HD	118-100115-XX
ILS Lens 7.5-11.2:1 SX+/6.9-10.4:1 HD	118-100116-XX

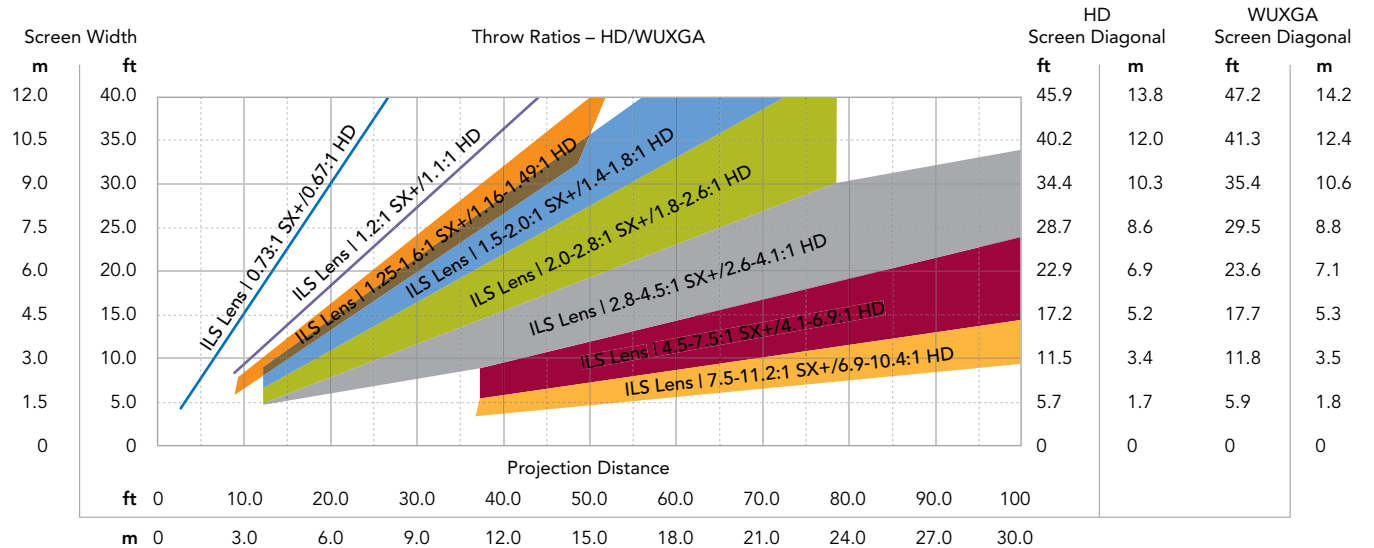

Throw distance values are subject to a +/- 5% lens tolerance.

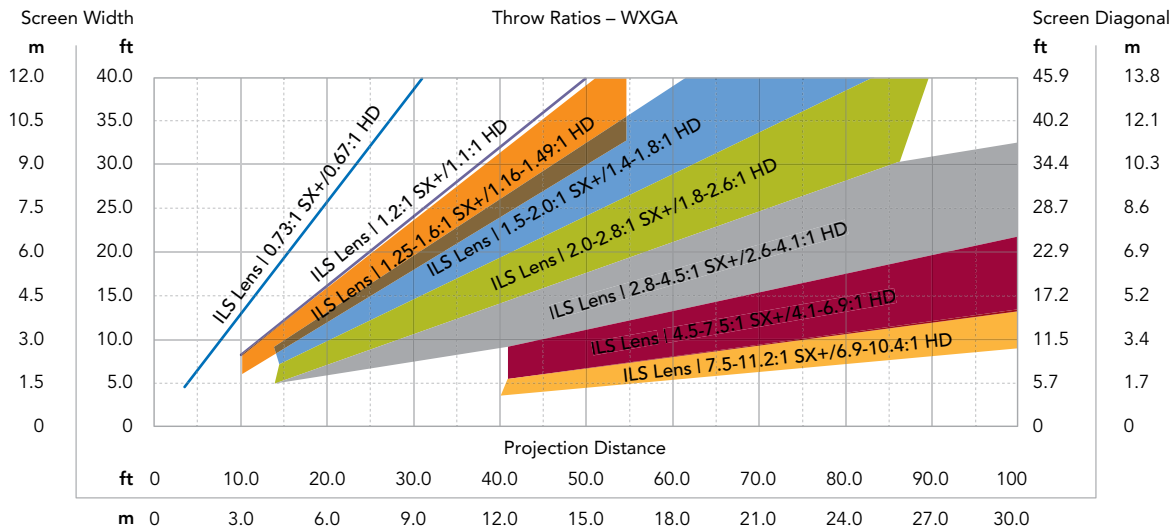
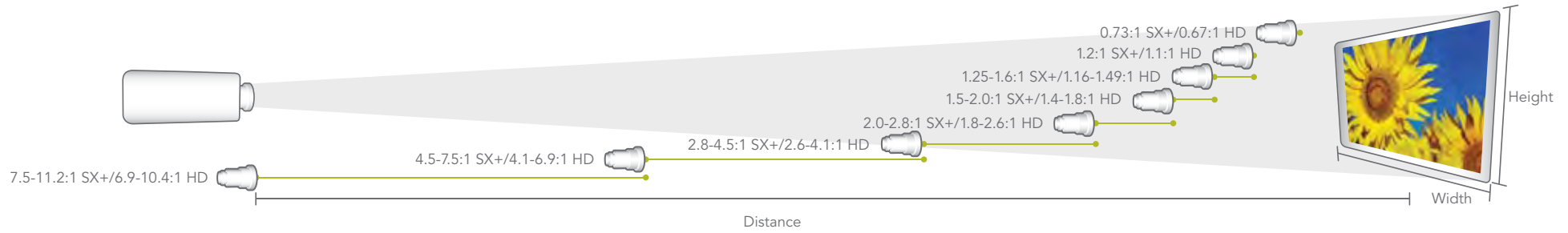

Throw distance values are subject to a +/- 5% lens tolerance.

		SXGA+ (4:3)				HD (16:9)				
		DS+6K-M	DS+10K-M	Roadster S+10K-M	DS+14K-M	Roadster S+14K-M	HD6K-M	HD10K-M	Roadster HD10K-M	
Image	brightness	dual lamp	• 6300 ANSI lumens (6930 center lumens)	• 10,500 ANSI lumens (11,550 center lumens)	• 12,500 ANSI lumens (14,000 center lumens)		• 6000 ANSI lumens (6600 center lumens)	• 10,000 ANSI lumens (11,000 center lumens)		
		single lamp	• 3150 ANSI lumens (3465 center lumens)	• 5250 ANSI lumens (5775 center lumens)	• 6250 ANSI lumens (7000 center lumens)		• 3000 ANSI lumens (3300 center lumens)	• 5000 ANSI lumens (5500 center lumens)		
	contrast		• 2500-10,000:1 (full on/off) 650:1 ANSI (typical)			• 2500:1 (full on/off) 650:1 ANSI (typical)		• 2500-10,000:1 (full on/off) 650:1 ANSI (typical)		
	uniformity		• 90% brightness uniformity							
Display technology	type	• 3-chip 0.95" DMD								
	native resolution	• SX+ (1400 x 1050)					• HD (1920 x 1080)			
Lamp	type	• Dual 200W P-VIP® Osram	• Dual 350W P-VIP Osram	• Dual 450W NSH		• Dual 200W P-VIP Osram	• Dual 350W P-VIP Osram			
	life	high power	• 2000 hrs @ 200W	• 1500 hrs @ 350W	• 1250 hrs @ 450W		• 2000 hrs @ 200W	• 1500 hrs @ 350W		
	low power	• 3000 hrs @ 150W	• 2000 hrs @ 300W	• 1500 hrs @ 360W		• 3000 hrs @ 150W	• 2000 hrs @ 300W			
Input	standard	• Analog (5 BNC) • Dual-link DVI		• Analog (5 BNC) • Dual-link DVI • 3G SD/HD-SDI • Video decoder	• Analog (5 BNC) • Dual-link DVI	• Analog (5 BNC) • Dual-link DVI • 3G SD/HD-SDI • Video decoder	• Analog (5 BNC) • Dual-link DVI		• Analog (5 BNC) • Dual-link DVI • 3G SD/HD-SDI • Video decoder	
	optional	• Analog (5 BNC) • Dual-link DVI • 3G SD/HD-SDI • Video decoder • Twin HDMI • DMX512 interface card								
	signals	• HDTV formats VGA through to QXGA (2048 x 1536) • Accepts all current HDTV/DTV formats • Multi-standard video decoder • Horizontal and vertical scaling, all inputs								
	pixel clock	• 165 MHz								
	scan rates	• Horizontal: 15-120kHz • Vertical: 23.97-150Hz								
Inputs, control and networking		• RS-232 in/out • RS-422 in • Ethernet (10/100) • GPIO (RS-232 9 Pin male connector) • Built-in backlit LCD keypad • Remote control (with optional wired XLR connection)								
Optical system		• Dust sealed, 3-chip DMD light engine • Motorized horizontal and vertical lens offset • Scheimpflug (tilt) adjustment • Built-in light shutter • Tool-free lens insertion system								
Lenses	fixed	• 0.73:1 SX+/0.67:1 HD* • 1.2:1 SX+/1.1:1 HD								
	zoom	• 1.25-1.6:1 SX+/1.16-1.49:1 HD** • 1.5-2.0:1 SX+/1.4-1.8:1 HD • 2.0-2.8:1 SX+/1.8-2.6:1 HD • 2.8-4.5:1 SX+/2.6-4.1:1 HD • 4.5-7.5:1 SX+/4.1-6.9:1 HD • 7.5-11.2:1 SX+/6.9-10.4:1 HD								
	offsets ¹	• All lenses ±100% Vertical ±50% Horizontal except noted below * 0.73:1 fixed lens ±23%V ±13%H ** 1.25-1.6:1 zoom lens ±73%V ±45%H						• All lenses ±120% Vertical ±42% Horizontal except noted below * 0.67:1 fixed lens ±35%V ±12%H ** 1.16-1.49:1 zoom lens ±102%V ±40%H		
Accessories	standard	• IR remote • Line cord	• Stacking frame • IR remote • Line cord	• IR remote • Line cord	• Stacking frame • IR remote • Line cord	• IR remote • Line cord	• Stacking frame • IR remote • Line cord			
	optional	• Coarse dust filter • Fog juice filter • Ceiling mount • ILS lens adapter kit • Stacking frame • Christie AutoStack (optional curve module available)								
Enhanced feature sets		• LiteLOC • Comprehensive Color Adjustment (CCA) • Embedded Christie Twist image warping and edge-blending • Intelligent Lens System (ILS) for zoom, focus, horizontal and vertical offset for all lenses • Auto setup • Digital keystone correction • Dynamic iris ² • Menus in five languages • 99 channel memories • Multi-windowing and processing (up to a 3x3 array) • Motorized yellow notch filter (HD and WUXGA models only) ² • Black level blending ³ • 24/7 operation • 3D upgradable ³ • Built-in portrait capabilities								
Power requirements	operating voltage	• 110-240 VAC 50/60Hz								
	maximum operating current	• 8.7A @ 100 VAC	• 13.2A @ 100 VAC	• 15A @ 100 VAC		• 8.7A @ 100 VAC	• 13.2A @ 100 VAC			
	power	• 870W	• 1320W	• 1500W		• 870W	• 1320W			
	dissipation	• 2971 BTU/hr	• 4508 BTU/hr	• 5118 BTU/hr		• 2971 BTU/hr	• 4508 BTU/hr			
Dimensions	size	• (LxWxH): 22.1 x 19.7 x 10.2" (561 x 500 x 259mm)								
	shipping size	• (LxWxH): 29.0 x 27.0 x 24.6" (735 x 685 x 625mm)								
	weight	• 55lbs (25kg) (without lens)								
	shipping weight	• 80lbs (36kg)								
Operating environment		• Temperature: 40-104°F (5-40°C) • Humidity: 20-80% non-condensing								
Regulatory approvals		• Directives (EC) 2002/95/EC (RoHS); 2002/96/EC (WEEE); Regulation (EC) No. 1907/2006 (REACH) • CAN/CSA C22.2 No. 60950-1 • UL 60950-1 • IEC 60950-1 • FCC, Part 15, Subpart B, Class A • EN55022/CISPR22 Class A • EN55024 / CISPR24 • Certifications marks (check with Christie for latest update): cULus (Canada & US), CE (EU), CCC (China), GoST-R (Russia), KC (Korea), PSE (Japan), C-Tick								
Limited warranty		• Three years parts and labor (including light engine) • Contact an authorized Christie representative for full details of our limited warranty								



¹ Values are for reference and should be validated with the Christie lens calculator.

² Not available in: DS+14K-M, Roadster S+14K-M, HD14K-M, Roadster HD14K-M, WU14K-M, Roadster WU14K-M models.

³ Not available in WXGA models.

		WXGA (16:9)		WUXGA (16:10)				
HD14K-M	Roadster HD14K-M	WX7K-M	WX10K-M	WU7K-M	WU12K-M	Roadster WU12K-M	WU14K-M	Roadster WU14K-M
• 12,000 ANSI lumens (13,500 center lumens)		• 5700 ANSI lumens (6270 center lumens)	• 9500 ANSI lumens (10,450 center lumens)	• 6300 ANSI lumens (6930 center lumens)	• 10,500 ANSI lumens (11,550 center lumens)		• 12,500 ANSI lumens (14,000 center lumens)	
• 6000 ANSI lumens (6750 center lumens)		• 2850 ANSI lumens (3135 center lumens)	• 4750 ANSI lumens (5225 center lumens)	• 3150 ANSI lumens (3465 center lumens)	• 5250 ANSI lumens (5775 center lumens)		• 6250 ANSI lumens (7000 center lumens)	
• 2500:1 (full on/off) 650:1 ANSI (typical)		• 2500-10,000:1 (full on/off) 650:1 ANSI (typical)					• 2500:1 (full on/off) 650:1 ANSI (typical)	
		• 3-chip 0.85" DMD		• 3-chip 0.96" DMD				
		• WXGA (1366 x 768)		• WUXGA (1920 x 1200)				
• Dual 450W NSH		• Dual 200W P-VIP Osram	• Dual 350W P-VIP Osram	• Dual 200W P-VIP Osram	• Dual 350W P-VIP Osram		• Dual 450W NSH	
• 1250 hrs @ 450W		• 2000 hrs @ 200W	• 1500 hrs @ 350W	• 2000 hrs @ 200W	• 1500 hrs @ 350W		• 1250 hrs @ 450W	
• 1500 hrs @ 360W		• 3000 hrs @ 150W	• 2000 hrs @ 300W	• 3000 hrs @ 150W	• 2000 hrs @ 300W		• 1500 hrs @ 360W	
• Analog (5 BNC) • Dual-link DVI	• Analog (5 BNC) • Dual-link DVI • 3G SD/HD-SDI • Video decoder	• Dual-link DVI		• Analog (5 BNC) • Dual-link DVI	• Analog (5 BNC) • Dual-link DVI • 3G SD/HD-SDI • Video decoder		• Analog (5 BNC) • Dual-link DVI	• Analog (5 BNC) • Dual-link DVI • 3G SD/HD-SDI • Video decoder
		• All lenses ±150% Vertical ±76% Horizontal except noted below * 0.67:1 fixed lens ±50%V ±18%H ** 1.16-1.49:1 zoom lens ±120%V ±58%H		• All lenses ±112% Vertical ±54% Horizontal except noted below * 0.67:1 fixed lens ±22%V ±6%H ** 1.16-1.49:1 zoom lens ±82%V ±38%H				
• IR remote • Line cord	• Stacking frame • IR remote • Line cord	• IR remote • Line cord • HD15 to 5-wire BNC female adapter	• IR remote • Line cord		• Stacking frame • IR remote • Line cord	• IR remote • Line cord	• Stacking frame • IR remote • Line cord	
• 15A @ 100 VAC		• 8.7A @ 100 VAC	• 13.2A @ 100 VAC	• 8.7A @ 100 VAC	• 13.2A @ 100 VAC		• 15A @ 100 VAC	
• 1500W		• 870W	• 1320W	• 870W	• 1320W		• 1500W	
• 5118 BTU/hr		• 2971 BTU/hr	• 4508 BTU/hr	• 2971 BTU/hr	• 4508 BTU/hr		• 5118 BTU/hr	

Australia & New Zealand), South Africa

			SXGA+ (4:3)			HD (16:9)			
			Mirage DS+6K-M	Mirage DS+10K-M	Mirage DS+14K-M	Mirage HD6K-M	Mirage HD10K-M	Mirage HD14K-M	
Image	brightness	dual lamp	• 6300 ANSI lumens (6930 center lumens)	• 10,500 ANSI lumens (11,550 center lumens)	• 12,500 ANSI lumens (14,000 center lumens)	• 6000 ANSI lumens (6600 center lumens)	• 10,000 ANSI lumens (11,000 center lumens)	• 12,000 ANSI lumens (13,500 center lumens)	
		single lamp	• 3150 ANSI lumens (3465 center lumens)	• 5250 ANSI lumens (5775 center lumens)	• 6250 ANSI lumens (7000 center lumens)	• 3000 ANSI lumens (3300 center lumens)	• 5000 ANSI lumens (5500 center lumens)	• 6000 ANSI lumens (6750 center lumens)	
	contrast		• 2500-10,000:1 (full on/off) 650:1 ANSI (typical)			• 2500:1 (full on/off) 650:1 ANSI (typical)		• 2500-10,000:1 (full on/off) 650:1 ANSI (typical)	
	uniformity		• 90% brightness uniformity						
Display	type		• 3-chip 0.95" DMD						
	native resolution		• SXGA+ (1400 x 1050)			• HD (1920 x 1080)			
	frame delay		• As little as one frame						
Lamp	type		• Dual 200W P-VIP Osram	• Dual 350W P-VIP Osram	• Dual 450W NSH	• Dual 200W P-VIP Osram	• Dual 350W P-VIP Osram	• Dual 450W NSH	
	life	high power	• 2000 hrs @ 200W	• 1500 hrs @ 350W	• 1000 hrs @ 450W	• 2000 hrs @ 200W	• 1500 hrs @ 350W	• 1000 hrs @ 450W	
		low power	• 3000 hrs @ 150W	• 2000 hrs @ 300W	• 1500 hrs @ 360W	• 3000 hrs @ 150W	• 2000 hrs @ 300W	• 1500 hrs @ 360W	
Input	standard		• Two dual link DVI-I with VGA		• 2x Dual-link DVI	• Two dual link DVI-I with VGA		• 2x Dual-link DVI	
	optional		• Analog (5 BNC) • Dual-link DVI • 3G SD/HD-SDI • Video decoder • Twin HDMI • DMX512 interface card						
	signals 2D		• HDTV formats VGA through to QXGA (2048 x 1536) • Accepts all current HDTV/DTV formats • Multi-standard video decoder • Horizontal and vertical scaling, all inputs						
	signals 3D		• Native 3D 48-60Hz per eye • Frame doubled 3D 24-30Hz per eye • Dual input 3D 48-60Hz per eye • HDMI 1.4a Frame packed and Side-by-Side Horizontal						
	pixel clock		• 330 MHz						
	scan rates		• Horizontal: 15-120 kHz • Vertical: 23.97-50 Hz (frame-locked maximum 120Hz)						
Inputs, control and networking			• RS-232 in/out • RS-422 In • Ethernet (10/100) • GPIO (RS-232 9 Pin male connector) • Built-in backlit LCD keypad • Remote control (with optional wired XLR connection) • Slot 1-2 populated, standard: Input 3D compatibility) • Slot 3-4 unpopulated						
Optical system			• Dust sealed, 3-chip DMD light engine • Motorized horizontal and vertical lens offset • Scheimpflug (tilt) adjustment • Built-in light shutter • Tool-free lens insertion system						
Lenses	fixed		• 0.73:1 SX+/0.67:1 HD/WU* • 1.2:1 SX+/1.1:1 HD/WU						
	zoom		• 1.25-1.6:1 SX+/1.16-1.49:1 HD/WU** • 1.5-2.0:1 SX+/1.4-1.8:1 HD/WU • 2.0-2.8:1 SX+/1.8-2.6:1 HD/WU • 2.8-4.5:1 SX+/2.6-4.1:1 HD/WU • 4.5-7.5:1 SX+/4.1-6.9:1 HD/WU • 7.5-11.2:1 SX+/6.9-10.4:1 HD/WU						
	offsets ¹		• All lenses ±100% Vertical ±50% Horizontal except where noted * 0.73:1 fixed lens ±23%V ±13%H ** 1.25-1.6:1 zoom lens ±73%V ±45%H			• All lenses ±120% Vertical ±54% Horizontal except where noted * 0.67:1 fixed lens ±35%V ±12%H ** 1.16-1.49:1 zoom lens ±102%V ±40%H			
Accessories	standard		• Two (330 MHz) DVI-D input cards • IR remote • Line cord • GPIO 3D sync cable						
	optional		• Coarse dust filter • Fog juice filter • Ceiling mount • Ceiling mount extension • ILS lens adapter kit • Stacking frame • Christie AutoStack (optional curve module available)						
Enhanced feature sets			• LiteLOC • Comprehensive Color Adjustment (CCA) • Embedded Christie Twist image warping and edge-blending • Intelligent Lens System (ILS) for zoom, focus, horizontal and vertical offset for all lenses • 99 channel memories • Black level blending • 24/7 operation • Motorized yellow notch filter (HD & WUXGA models only) ² • Built-in portrait capabilities						
Power requirements	operating voltage		• 100-240 VAC 50/60Hz						
	maximum operating current		• 8.7A @ 100 VAC	• 13.2A @ 100 VAC	• 15A @ 100 VAC	• 8.7A @ 100 VAC	• 13.2A @ 100 VAC	• 15A @ 100 VAC	
			• 1500W			• 1500W			
	maximum operating power		• 1500W						
dissipation		• 2971 BTU/hr	• 4508 BTU/hr	• 5118 BTU/hr	• 2971 BTU/hr	• 4508 BTU/hr	• 5118 BTU/hr		
Dimensions	size		• (LxWxH): 22.1 x 19.7 x 10.2" (561 x 500 x 259mm)						
	shipping dimensions		• (LxWxH): 29.0 x 27.0 x 24.6" (735 x 685 x 625mm)						
	weight		• 55lbs (25kg) (without lens)						
	shipping weight		• 80lbs (36kg)						
Operating environment			• Temperature: 40-104°F (5-40°C) • Humidity: 20-80% non-condensing						
Regulatory approvals /markings			• Directives (EC) 2002/95/EC (RoHS); 2002/96/EC (WEEE); Regulation (EC) No. 1907/2006 (REACH) • CAN/CSA C22.2 No. 60950-1 • UL 60950-1 • IEC 60950-1 • FCC, Part 15, Subpart B, Class A • EN55022/CISPR22 Class A • EN55024 / CISPR24 • Certifications marks (check with Christie for latest update): cULus (Canada & US), CE (EU), CCC (China), GoST-R (Russia), KC (Korea), PSE (Japan), C-Tick						
Limited warranty			• Three years parts and labor (including light engine) • Contact an authorized Christie representative for full details of our limited warranty						

¹ Values are for reference and should be validated with the Christie lens calculator. ² Not available in the following models: Mirage DS+14K-M, Mirage HD14K-M, Mirage WU14K-M.

WUXGA (16:10)		
Mirage WU7K-M	Mirage WU12K-M	Mirage WU14K-M
<ul style="list-style-type: none"> • 6300 ANSI lumens (6930 center lumens) • 3150 ANSI lumens (3465 center lumens) • 2500-10,000:1 (full on/off) 650:1 ANSI (typical) 	<ul style="list-style-type: none"> • 10,500 ANSI lumens (11,550 center lumens) • 5250 ANSI lumens (5775 center lumens) 	<ul style="list-style-type: none"> • 12,500 ANSI lumens (14,000 center lumens) • 6250 ANSI lumens (7000 center lumens) • 2500:1 (full on/off) 650:1 ANSI (typical)

- 3-chip 0.96" DMD
- WUXGA (1920 x 1200)

<ul style="list-style-type: none"> • Dual 200W P-VIP Osram • 2000 hrs @ 200W • 3000 hrs @ 150W • Two dual link DVI-I with VGA 	<ul style="list-style-type: none"> • Dual 350W P-VIP Osram • 1500 hrs @ 350W • 2000 hrs @ 300W 	<ul style="list-style-type: none"> • Dual 450W NSH • 1000 hrs @ 450W • 1500 hrs @ 360W • 2x Dual-link DVI
---	---	---

two Dual Link DVI-D (330 MHz) input cards (each has VGA (165 MHz) for 3D or Dual

- All lenses ±112% Vertical ±54% Horizontal except where noted
- * 0.67:1 fixed lens ±22%V ±6%H ** 1.16-1.49:1 zoom lens ±82%V ±38%H

- Auto setup • Digital keystone correction • Dynamic iris² • Menus in five languages

• 8.7A @ 100 VAC	• 13.2A @ 100 VAC	• 15A @ 100 VAC
		• 1500W
• 2971 BTU/hr	• 4508 BTU/hr	• 5118 BTU/hr

(Australia & New Zealand), South Africa

Description	Part number	Dimension 'A'
Lens ILS 0.73:1 SX+/0.67:1 HD	118-100110-XX	217mm (8.54")
Lens ILS 1.2SX+/1.1HD	118-100117-XX	281mm (11.06")
Lens ILS 1.25-1.6 SX+/1.16-1.49 HD	118-100111-XX	238mm (9.37")
Lens ILS 1.5-2.0 SX+/1.4-1.8 HD	118-100112-XX	206mm (8.11")
Lens ILS 2.0-2.8 SX+/1.8-2.6 HD	118-100113-XX	171mm (6.73")
Lens ILS 2.8-4.5 SX+/2.6-4.1 HD	118-100114-XX	157mm (6.18")
Lens ILS 4.5-7.5 SX+/4.1-6.9 HD	118-100115-XX	141mm (5.51")
Lens ILS 7.5-11.2 SX+/6.9-10.4 HD	118-100116-XX	201mm (7.91")

Front view

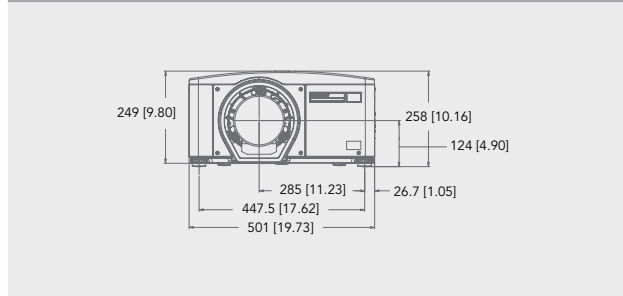

Side view

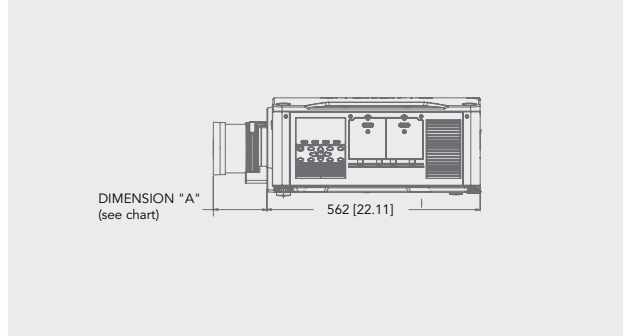

Top view

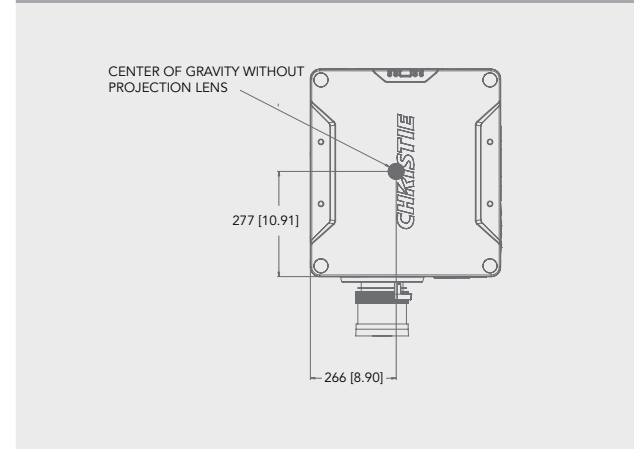

Underneath view

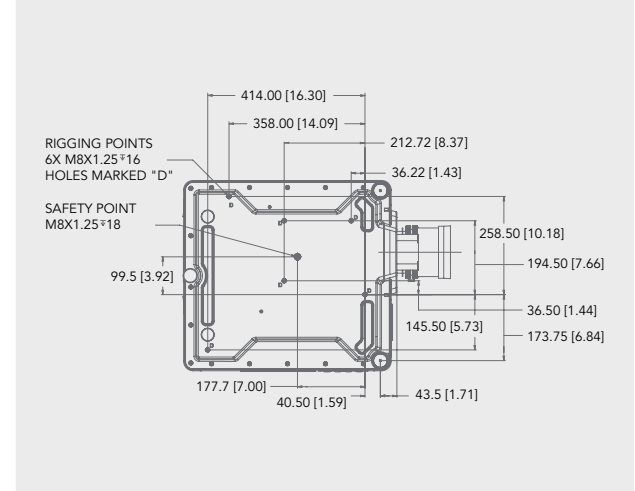

Corporate offices

Christie Digital Systems USA, Inc.
USA – Cypress
ph: 714 236 8610

Christie Digital Systems Canada Inc.
Canada – Kitchener
ph: 519 744 8005

Independent sales consultant offices

Italy
ph: +39 (0) 2 9902 1161

Worldwide offices

United Kingdom
ph: +44 (0) 118 977 8000

Germany
ph: +49 2161 664540

France
ph: +33 (0) 1 41 21 44 04

Spain
ph: +34 91 633 9990

Eastern Europe and
Russian Federation
ph: +36 (0) 1 47 48 100

Republic of South Africa
ph: +27 (0)11 510 0094

United Arab Emirates
ph: +971 4 3206688

India
ph: +91 80 6708 9999

Singapore
ph: +65 6877 8737

China (Shanghai)
ph: +86 21 6278 7708

China (Beijing)
ph: +86 10 6561 0240

Japan (Tokyo)
ph: 81 3 3599 7481

Korea (Seoul)
ph: +82 2 702 1601



ISO 9001
ISO 14001

Kitchener, Ontario



For the most current specification information, please visit www.christiedigital.com

 Copyright 2013 Christie Digital Systems USA, Inc. All rights reserved. All brand names and product names are trademarks, registered trademarks or tradenames of their respective holders. Christie Digital Systems Canada Inc.'s management system is registered to ISO 9001 and ISO 14001. Performance specifications are typical. Due to constant research, specifications are subject to change without notice.
Printed in Canada on recycled paper. 3501 Mar 13

CHRISTIE®