

ELMO

INSTRUCTION MANUAL

VISUAL PRESENTER

TT-L1

(previously LX-1 and TT-LX1)

Please read this instruction manual carefully before using this product.





IMPORTANT SAFEGUARDS

Please read all precautions and warnings before using the product.







The information is provided to ensure proper operation of this product and will prevent you or others from personal injury or loss of assets.

Review the following symbols so that you understand them before reading the rest of the manual.

Please read carefully and keep the manual in a safe place for future reference.

	Warning	Ignoring the warning and operating the system incorrectly subjects the user to possible risk of injury or death.
	Attention	Ignoring the warning and operating the system incorrectly subjects the user to risk of injury or loss of assets.

Meaning of Symbols

	Name: Caution Meaning: Indicates that the user must, without fail, pay careful attention to any sentences or illustrations marked with a Caution symbol.
	Name: Prohibited Meaning: Indicates that the user must pay careful attention to any sentences or illustrations marked with a Prohibited (do not do) symbol.
	Name: Do not use in a bathroom or shower cubicle Meaning: Indicates that using the product in a bathroom or shower cubicle could result in injuries through a fire or electric shock, and is strictly prohibited.
	Name: Do not touch Meaning: Indicates that touching the area could result in injuries through electric shock, and is strictly prohibited.
	Name: Do not disassemble Meaning: Indicates that disassembling the product could result in injuries through electric shock, and is strictly prohibited.
	Name: Compulsory Meaning: Indicates that the user must pay careful attention to any sentences or illustrations marked with a Compulsory (must do) symbol.
	Name: Unplug the power plug from the outlet Meaning: Indicates that the user must unplug the power plug from the outlet.

Warning

If for any reason smoke comes out of the product, or you notice any unusual odors or sounds, immediately turn off the power switch on the product and then unplug the power plug from the outlet.

Continuing to use the product while it is operating unusually could result in a fire or electric shock. Check that smoke is no longer coming out of the product, and then contact your local dealer to request maintenance.

Do not attempt to service this product yourself.



If for any reason liquid is spilled into the product, immediately turn off the power switch on the product and then unplug the power plug from the outlet.

Contact your local dealer immediately. Continuing to use the product in this condition could result in a fire or electric shock.



If for any reason foreign objects enter the product, immediately turn off the power switch on the product and then unplug the power plug from the outlet.

Contact your local dealer immediately. Continuing to use the product in this condition could result in a fire or electric shock.

(Be extra careful if there are children in the area when using the product.)



If for any reason there is a breakdown causing no images to be projected, turn off the power switch on the product and then unplug the power plug from the outlet. Then contact your local dealer to request maintenance. Continuing to use the product in this condition could result in a fire or electric shock.



If for any reason the product is dropped or the cabinet is damaged, turn off the power switch on the product and then unplug the power plug from the outlet. Then contact your local dealer. Continuing to use the product in this condition could result in a fire or electric shock.



If the power cable or the cable of the AC adapter is damaged (e.g. if the inside of the cord is exposed or broken), contact your local dealer and request a replacement.

Continuing to use the product in this condition could result in a fire or electric shock.



Do not remove the back panel, cabinet, or cover from this product.

Doing so may expose you to dangerous voltage and could result in electric shock.

Contact your local dealer for any internal inspections, maintenance, or repair.



Do not remodel this device.

This could result in a fire or electric shock.



Do not place this product on an uneven surface or unstable stand. It could fall or topple over and result in an injury.









Be sure to use the power cable and the AC adapter supplied with the product.

Otherwise, a fire or electric shock could occur.



The supplied power cable and the AC adapter are designed to be used for the LX-1 only. Do not use them for other products.



<p>Do not spill water or insert any foreign objects into this product. This could result in a fire or electric shock. Do not use this product in rainy weather, during a snowfall, on the coast, or on a water front.</p>	
<p>Do not place any heavy objects on the power cable or the AC adapter. Do not place this product on top of the power cable or the AC adapter. Do not cover the power cable or the AC adapter. The cable could be damaged and result in a fire or electric shock. (If the cable is covered by a carpet, there are times when you may not notice that a heavy object has been placed on the cable.)</p>	
<p>Do not damage, process, pinch, twist, pull, or heat the power cable or the AC adapter. The cable could be damaged and result in a fire or electric shock.</p>	
<p>Do not use this product in a bathroom or shower cubicle. This could result in a fire or electric shock.</p>	
<p>If there is dust on the prongs of the power plug or the connector surface, turn off the power switch on the product, unplug the power plug from the outlet, and then remove the dust. The drop in insulation for the power plug could result in a fire.</p>	
<p>Do not touch the product, the connector cable, the power cable, or the AC adapter during a thunder storm. This could result in an electric shock.</p>	

Attention

Whenever moving the product, turn off the power switch on the product and then unplug the power plug from the outlet. Move after checking that the external connection cable is disconnected. Otherwise, the cable could be damaged and result in a fire or electric shock.



For safety reasons, if this product is not used for a long time, be sure to unplug the power plug from the outlet. Otherwise, it could result in a fire.



Do not disconnect the power cable or the AC adapter by pulling the cable. Otherwise, the cable could be damaged and result in a fire or electric shock. Disconnect by holding both ends of the power plug or the AC adapter.



If the product is placed on a stand with casters, make sure the caster's brakes are on. It could result in an injury if it moves and falls.



Do not place the product in a damp or dusty location. This could result in a fire or electric shock.



Do not place the product in a location where it could be exposed to smoke, steam, or water droplets such as on a kitchen counter or near a humidifier. This could result in a fire or electric shock.



Do not sit on, or place any heavy objects on, this product. Be extra careful if there are any small children in the area when using the product. It could result in an injury if it falls or breaks.



Do not place the power cable or the AC adapter next to a heater. The cable covering could melt and result in a fire or electric shock.



Do not connect or disconnect the power cable or the AC adapter with wet hands. Otherwise, it could result in an electric shock.



Make sure the power plug is securely inserted into the outlet. If it is not inserted correctly, it could generate excess heat and dust could enter which could result in a fire. Also, touching a prong of the power plug could result in an electric shock.



Do not use a loose outlet. Excess heat could be generated and result in a fire. Request a replacement outlet from your local dealer or electrical appliance store.



BEFORE YOU USE

- Be sure to use the power cable or the AC adapter supplied with the product. Do not use them with other products.
- Be sure to use the AC adapter applicable to your local power specifications. If the product was sold in Japan, use the AC adapter sold with the product with 100 VAC and 50 or 60 Hz.
- When storing the product, do not leave it under direct sunlight or by heaters. It may be discolored, deformed, or damaged.
- Do not place this product in any humid, dusty, salt bearing wind, or vibrating locations. Use it under the following environmental conditions:
 - Temperature: 0°C - 40°C
 - Humidity: 30% - 85% (No condensation)
- Use a soft, dry cloth for cleaning.
Do not use any volatile solvent such as thinner or benzene.
- Luminescent and Black Spots
There may be some pixels that do not properly operate due to the use of CMOS Area Image Sensors made-up of many pixels.
Though luminescent or black spots may be found on the screen, it is a phenomenon peculiar to the CMOS Area Image Sensors and is not a malfunction.
- Follow the guidelines below to prevent the unit from dropping or overturning.
 - Use the product on a stable base, desk, or table. Do not place the product on an unstable base or slanted location.
 - Place or wire the product to prevent the power cable, the AC adapter cable or the video cable from pulling.
- Carry the product by holding the lower part of the main unit in both hands. Never hold the product by the column or the camera head.
- Pay careful attention when using (including setting-up and storing) or transferring the product to prevent the camera head from receiving any shocks.
- Be careful not to pinch your fingers when moving the arm or camera head.

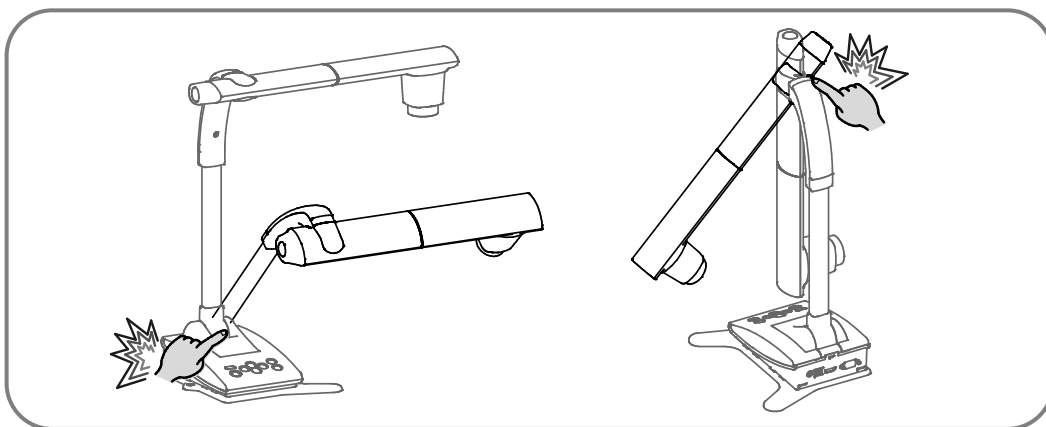

-
- Do not point the lens directly to the sun. It could degrade the imaging capability.
 - Do not look directly into the LED light. If you look directly into it at close range, your eyes may be injured.
 - If this product is used for longer than the warranty period, its performance and quality may deteriorate due to the lifetime of its parts. For parts replacement (on chargeable basis), consult the dealer from whom you purchased this product or our branch/office near your location.
 - Menu and Icons
Some functions of this product may not be set or used depending on the operation mode or menu settings.
 - Copyright
Unless used for personal use, it is prohibited strictly under copyright law to use any photo files without the prior consent of the copyright holder. Even if using for personal use, be careful that there could be a situation where video or audio recording is restricted or illegal.
 - The contents of this document are subject to change without notice. The latest version can be obtained from the following Website:
<http://www.elmoussa.com>
<http://www.elmoeurope.com>
 - It is prohibited under copyright law to use or copy any part or the whole of this document without our prior written consent.
 - ELMO shall not be liable for any claim for damage or loss of earnings or any claim raised by a third person due to the use, malfunction or repair of this product.

HANDLING PRECAUTIONS

The followings are special precautions against mishandling of the product, which may cause serious damages to the product. Pay close attention to them.

① Installation

Do not place the product on an unstable place or slanted surface.

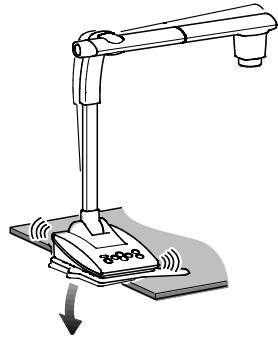

② Carrying the product

Carry the product by holding the lower part of the main unit in both hands.

Be careful not to give an impact to the column or the camera head.

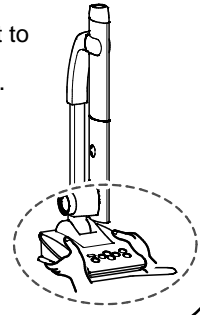

③ Zoom operation

Rotate the zoom dial gently. Otherwise the zoom dial may be broken.

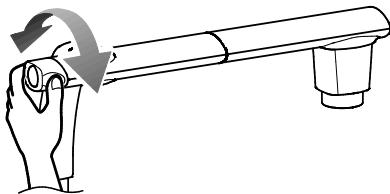

④ Cabling of the AC adapter

Do not wrap the power cable tightly around the AC adapter. By doing so may cause cable disconnection.



⑤ Camera head

Make sure to return the camera head to the initial position before moving the camera head.

Otherwise, the camera head could be damaged.

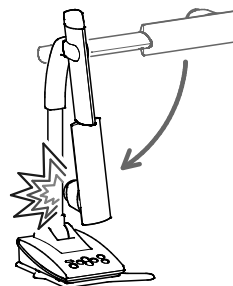

■ TABLE OF CONTENTS

IMPORTANT SAFEGUARDS.....	2
BEFORE YOU USE.....	6
HANDLING PRECAUTIONS	8
■ TABLE OF CONTENTS.....	9
❶ PREPARATION.....	11
❷ BASIC OPERATIONS.....	12
2-1 DOCUMENT CAMERA	12
■ PART NAMES	12
■ OPERATING PANEL	13
■ REAR PANEL AND CABLE CONNECTION	14
■ MOVING PARTS OF THE LX-1	16
2-2 SUPPLIED ACCESSORIES.....	17
■ IMAGE MATE 4	17
2-3 SHOOTING IMAGES.....	18
■ SETTING UP THE LX-1	18
■ TURNING THE POWER ON/OFF.....	19
■ ADJUSTING THE SIZE	20
■ AF (AUTO FOCUS)	21
■ ADJUSTING THE BRIGHTNESS.....	22
■ TURNING THE LED ON/OFF.....	23
■ CHANGING THE OUTPUT DESTINATION	24
2-4 CHANGING THE SETTINGS.....	25
■ HOW TO CHANGE THE SETTINGS.....	25
■ LIST OF MENU ICONS	25
■ DESCRIPTIONS OF EACH MENU	26
❸ ADVANCED OPERATIONS	28
3-1 CONNECTING TO A COMPUTER VIA THE USB CABLE	28

4	ABOUT IMAGE MATE 4	30
4-1	INSTALLING IMAGE MATE 4	30
	■INSTALLATION PROCEDURE	30
4-2	USING IMAGE MATE 4	31
	■HOW TO SELECT THE CAMERA	31
	■MENU WINDOW OF IMAGE MATE 4	32
5	ABOUT THE SETTING TOOL	34
5-1	STARTING THE SETTING TOOL	34
5-2	USING THE SETTING TOOL	34
6	OTHERS	35
6-1	SHOOTING FORWARD OR BACKWARD	35
6-2	ABOUT THE BASE PLATE	35
	■HOW TO CHANGE THE POSITION BASE PLATE	35
6-3	DISPLAYING ENLARGED IMAGESUSING A MICROSCOPE	36
	■PROCEDURE	36
	■EXITING THE MICROSCOPE MODE	37
6-4	FIRMWARE UPDATE PROCEDURE	38
6-5	CAPTURING A3 SIZED DOCUMENTS	39
7	TROUBLE SHOOTING	40
7-1	SYMPTOMS AND CONFIRMATION	40
8	SPECIFICATIONS	42
8-1	GENERAL	42
8-2	MAIN CAMERA	42
8-3	ILLUMINATION DEVICE	43
8-4	TRADEMARKS AND LICENSES	44

1 PREPARATION

The items below are included with this product. If any item is missing, contact the dealer from whom you purchased this product.

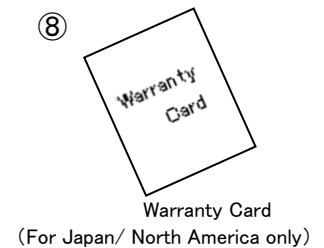
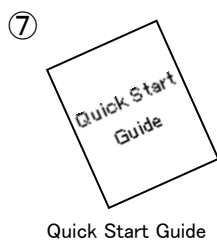
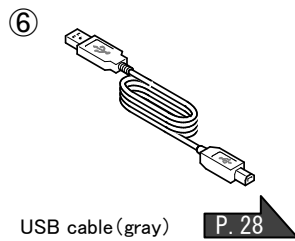
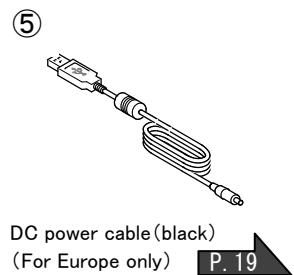
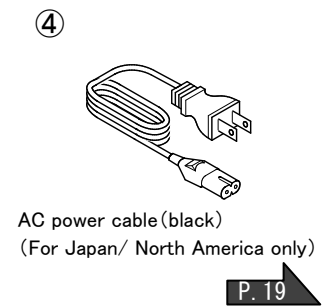
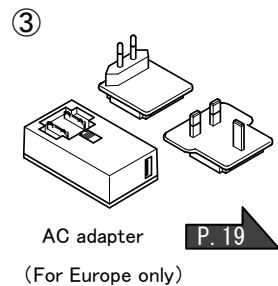
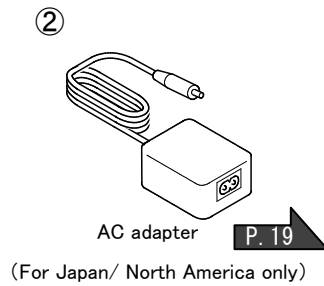
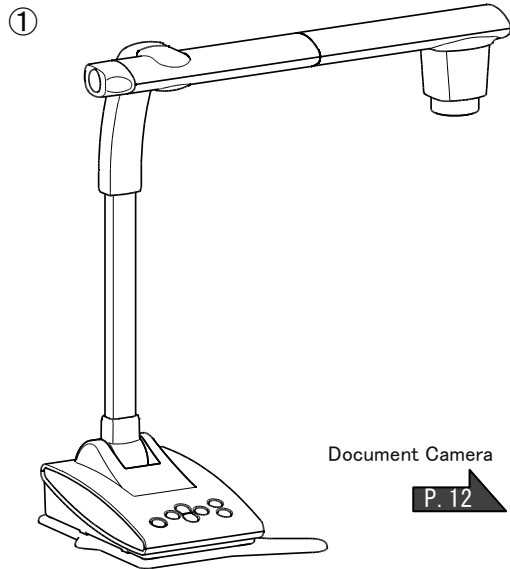

③ Assembly

Press and slide the plug into the groove of the AC adapter as shown in the drawing.

※Slide it until it clicks.

※Choose the correct plug according to the outlet.

When removing the plug from the AC adapter, slide and pull the plug in the opposite direction while pressing the lock button.

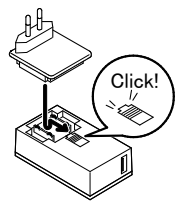

【Caution】

- The supplied DC power cable (black, for Europe) (⑤) is designed to be used for the LX-1 only. Do not use for other purpose than connecting the supplied AC adapter (for Europe) (③) to the LX-1.

Using the supplied DC power cable with a computer may damage a computer.

- Use the supplied USB cable (gray) (⑥) to connect the LX-1 to a computer.

② BASIC OPERATIONS

2-1 DOCUMENT CAMERA

■ PART NAMES



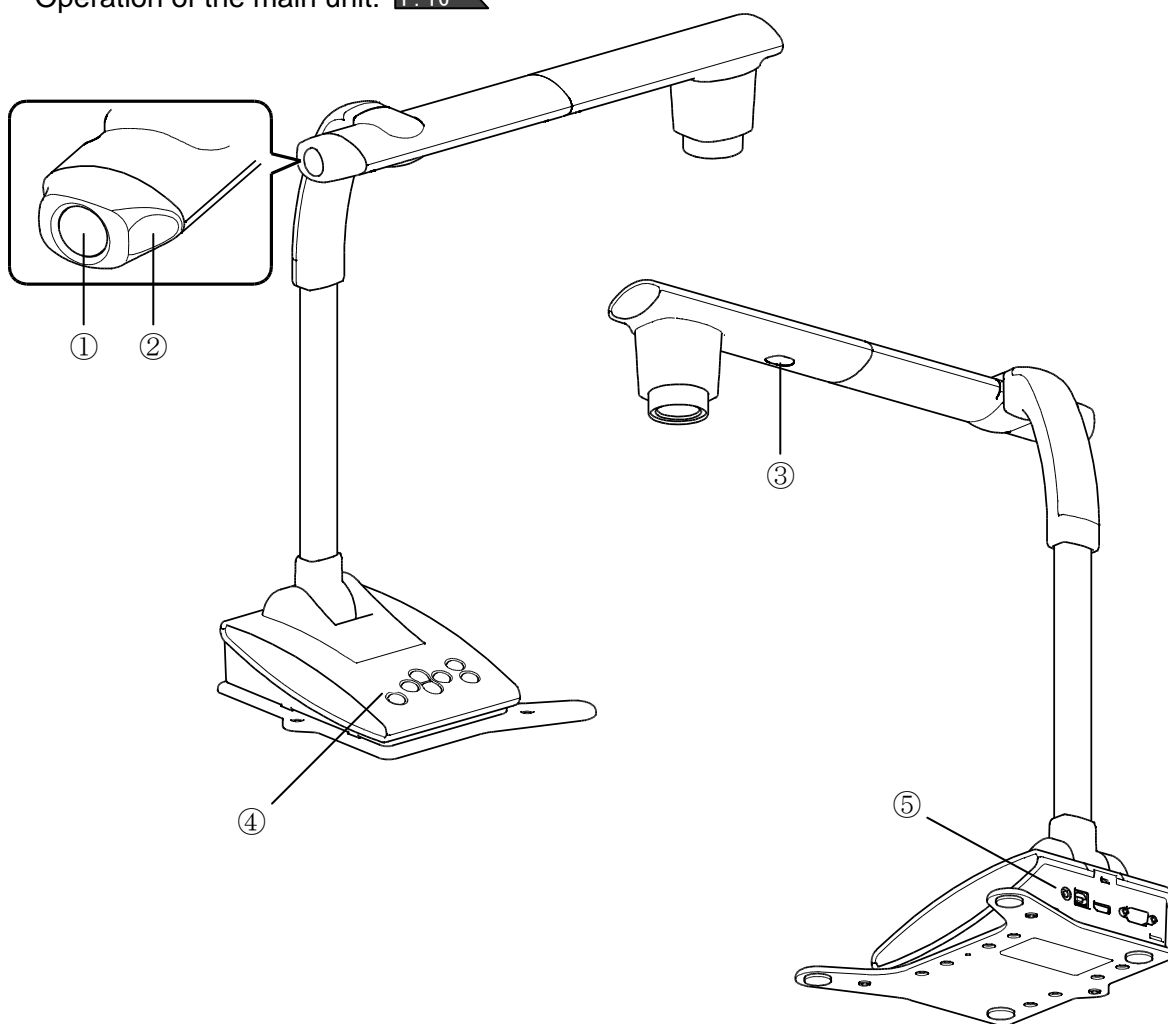



Operation of the main unit: [P. 16](#)

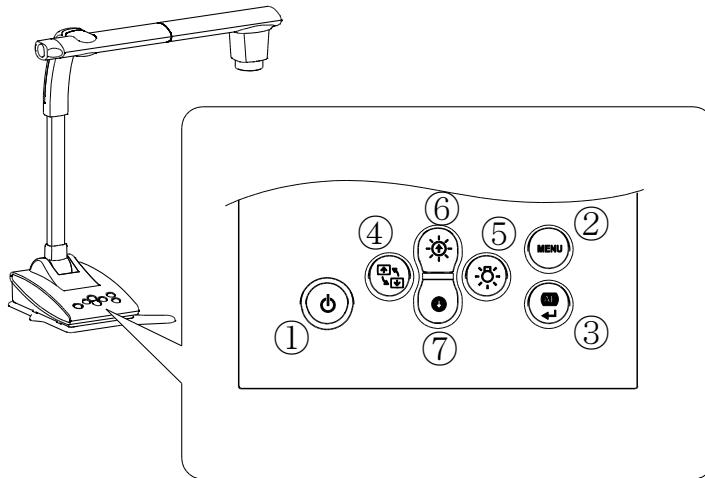

	Name	
①	AF button	P. 21
②	Zoom dial	P. 20
③	LED lighting	P. 23
④	Operating panel	P. 13
⑤	Rear panel	P. 14

■ OPERATING PANEL



	Mark	Name of function	Detail of function
①		Power	To turn the power ON/OFF. Power ON : LED turns blue Power OFF : LED turns red
②		MENU	To show/hide the menu on the screen.
③		AF/ Enter	When MENU is not displayed: to focus automatically. When MENU is displayed: to execute the selected menu item.
④		Image rotation	To rotate the image by 180°.
⑤		LED lighting	To ON/OFF the LED lighting.
⑥		Brightness +	To brighten the image.
⑦		Brightness -	To darken the image.

REAR PANEL AND CABLE CONNECTION

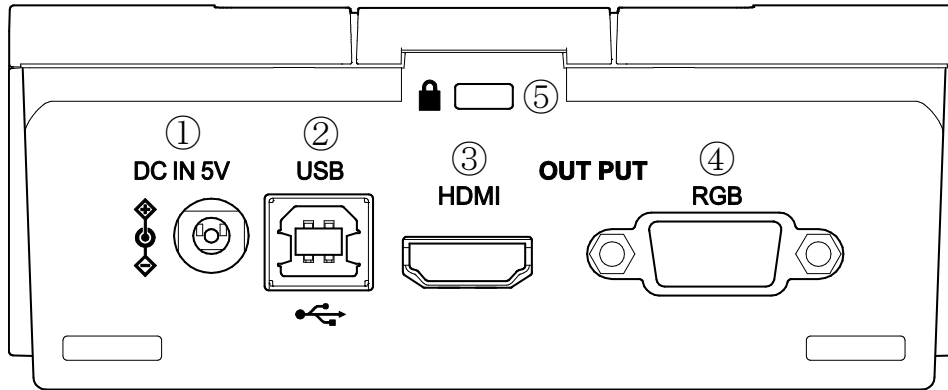

	Mark	Function
①	DC IN 5V	To connect the supplied DC power cable.
②	USB	To connect to a computer via the supplied USB cable.
③	HDMI OUT	To output digital images. (HDMI cable is not supplied with this product.)
④	RGB OUT	To output analog RGB images. (RGB cable is not supplied with this product.)
⑤	Anti theft lock hole	To guard against theft.

① To connect the AC adapter

Connect the supplied AC adapter and the supplied power cable. Connect video cables such as HDMI cable and RGB cable to the LX-1. Then connect the AC adapter to the DC IN 5V in the rear panel and plug the power cable to the outlet.

Make sure to connect the power cable to the outlet after connecting the video cables to the LX-1. **P. 18**

CAUTION

The supplied DC power cable (black, for Europe) is designed to be used for the LX-1 only. Do not use for other purpose than connecting the supplied AC adapter to the LX-1. Using the supplied DC power cable with a computer may damage a computer.

② To connect to a computer via the USB cable

Connect the supplied USB cable to the USB terminal on the rear panel.

CAUTION

Use the supplied USB cable (gray) to connect the LX-1 to a computer.

③ To connect to a device with an HDMI input terminal

Connect a commercially available HDMI cable to the HDMI OUT terminal on the rear panel.

Note

- Use a monitor which supports input resolution of 720p or higher.
The LX-1 may not operate with the cable which does not conform to the HDMI standard.
- The LX-1 conforms to the HDMI standard. However, we do not guarantee the operation of all types of monitors with the LX-1.

④ To connect to a device with an analog RGB terminal

Connect the RGB cable to the RGB OUT terminal on the rear panel.

⑤ To use the Anti theft lock hole

Connect a security cable to this hole to prevent theft.

Note

- If the displayed image is off-center, adjustment of the horizontal and vertical position should be made from a connected device.
- In some cases, vertical stripes may appear on the display device. This can be reduced by adjusting the "clock phase" function of a connected device.
- We recommend using the supplied USB cable or commercially available USB 2.0 compliant USB cable.
- If you connect the USB cable while the LX-1 or a computer is turned on, a computer may not recognize the device.
- Depending on the computer's USB environment or the peripheral equipment, image transfer may be disrupted.
- Successful operation in all environments and conditions is not guaranteed.

MOVING PARTS OF THE LX-1

The camera head of the LX-1 can be moved as shown below.

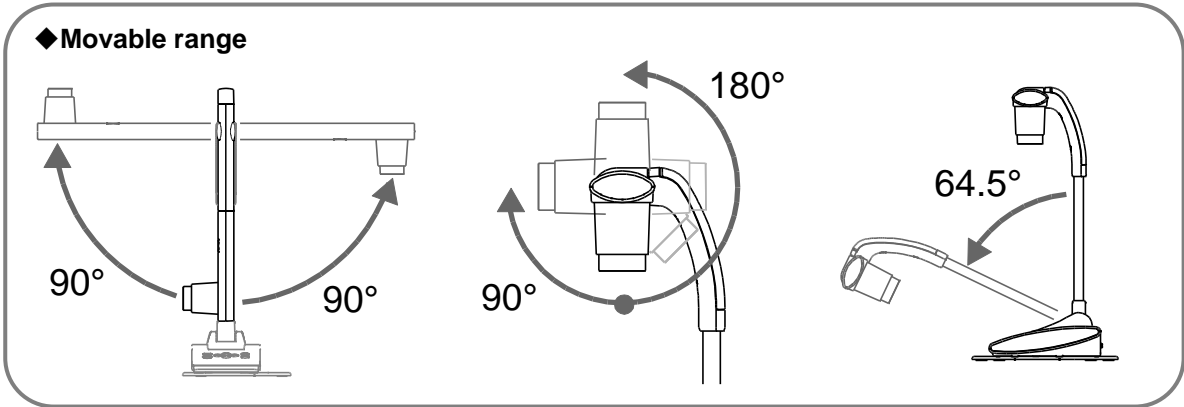
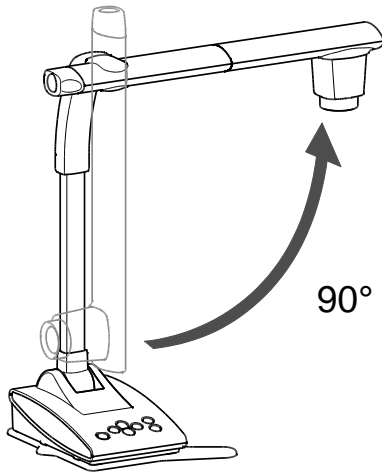

※ Depending on the position of the camera head or the installation place of the LX-1, stable operation may not be possible. In that case, change the position of the base plate. [P. 35](#)

※ In order to prevent the damage to the camera head, pay attention to the position of the camera head when moving the camera head. [P. 8](#)

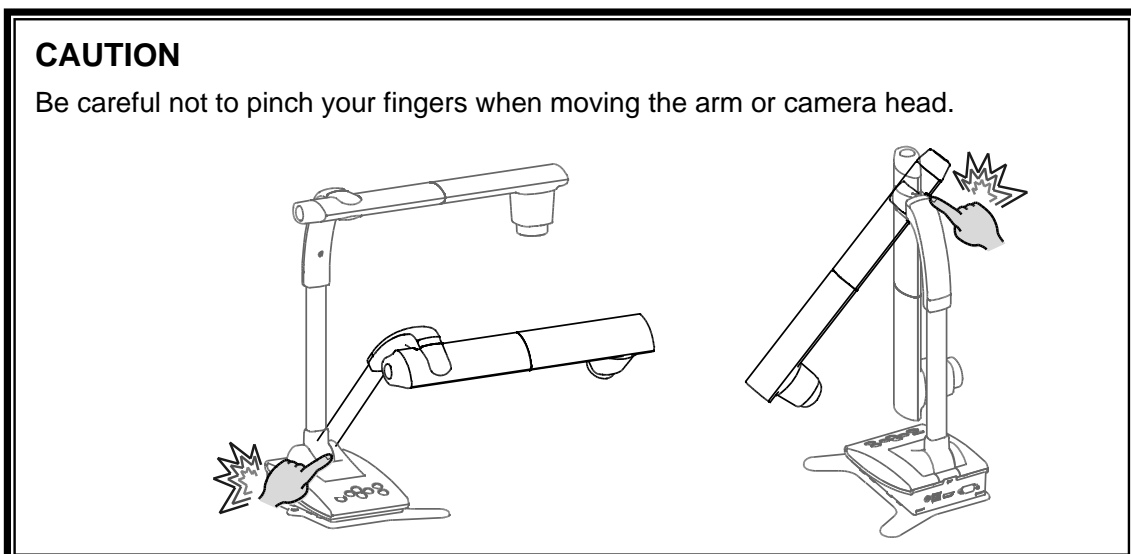

2-2 SUPPLIED ACCESSORIES

■ IMAGE MATE 4

Image Mate 4 (the controlling software for the LX-1) can be downloaded from Elmo official website.

For details of the downloading procedure, refer to “4-1 INSTALLING IMAGE MATE 4”

P. 30

The following operations can be performed by using Image Mate 4:

- Capture a still image from a live video stream from the LX-1 and save it to your computer
- Record a live video stream from the LX-1 and save it to your computer
- Control the LX-1

P. 32

This instruction manual briefly explains the feature of Image Mate 4.

Refer to “4-2 USING IMAGE MATE 4” for information how to use Image Mate 4.

P. 31

Carefully read the instruction manual of Image Mate 4 before using it.

2-3 SHOOTING IMAGES

■ SETTING UP THE LX-1

Connect the power cable (black) and the AC adapter. Connect the video cable (connected to a projector or monitor) and the AC adapter to the LX-1 respectively. Then connect the power cable (black) to the outlet and setup the LX-1 as shown below.

1. Place the LX-1 on a stable, even surface.
2. Raise the camera head as shown below.

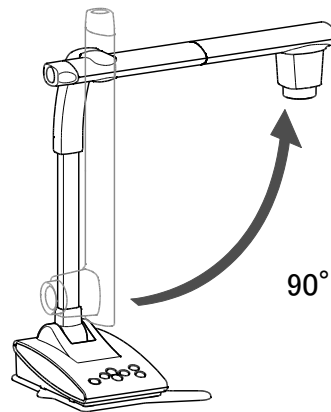
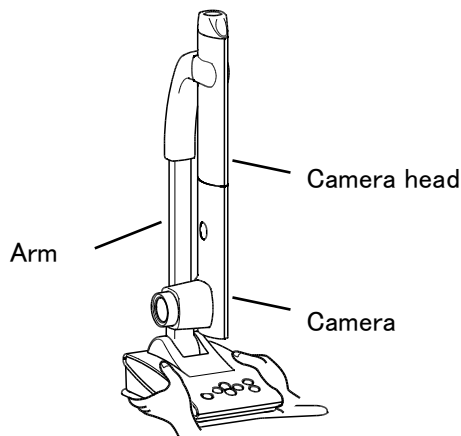

CONNECTING THE VIDEO CABLE

Connect the video cable corresponding to an image display device to the LX-1.

- with RGB cable (commercially available)

⇒RGB OUT

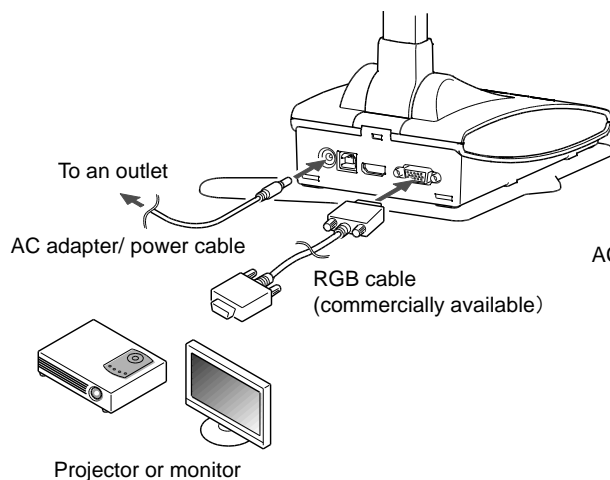

- with HDMI cable (commercially available)

⇒HDMI OUT

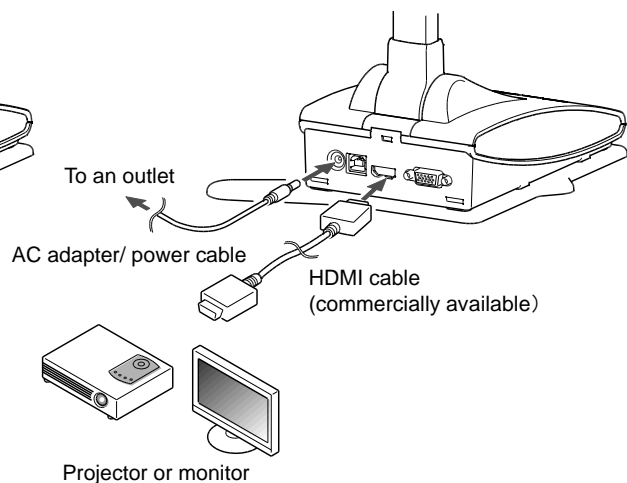

CONNECTING THE POWER CABLE

Connect the power cable (black) and the AC adapter. Connect the AC adapter to the DC IN 5V terminal in the rear panel of the LX-1 as shown in the connection diagram above. Then connect the power cable (black) to the outlet.

CAUTION

Before connecting the LX-1 to other devices, be sure to turn off the power of all the devices.

TURNING THE POWER ON/OFF

The [] button turns red when the power cable (black) is connected to the outlet.

The [] button turns purple for a few seconds when this button is pressed.

The image appears on the screen when the color changes to blue.

Press the [] button to turn off the LX-1. Then disconnect the power cable (black) from the outlet.

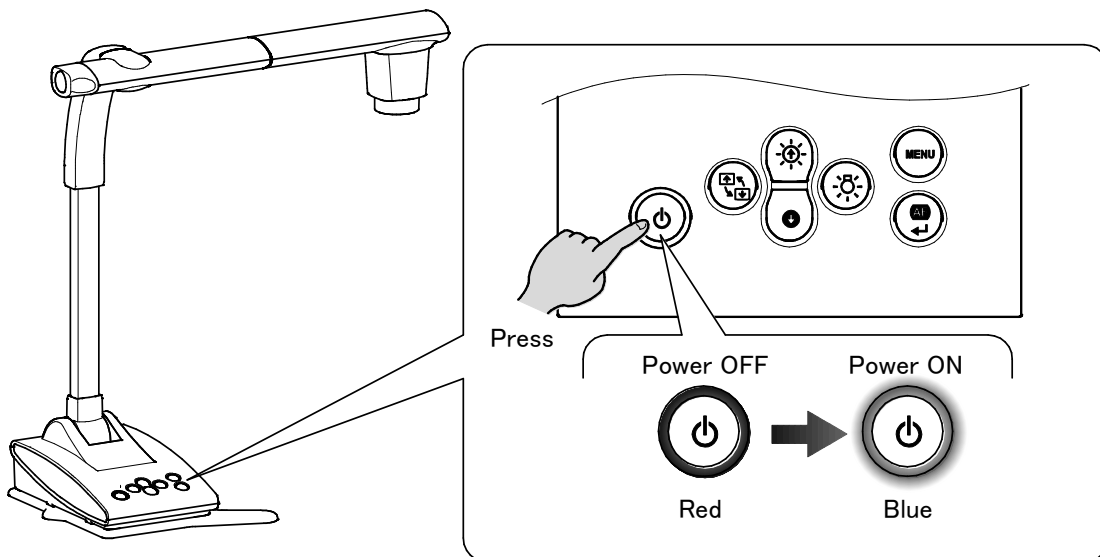



Note

Do not operate the LX-1 while the LED is lit in purple.

■ ADJUSTING THE SIZE

The display range of the document can be adjusted by rotating the zoom dial.

ZOOM-IN  : The object can be shown in large size.

ZOOM-OUT  : The object can be shown in small size.

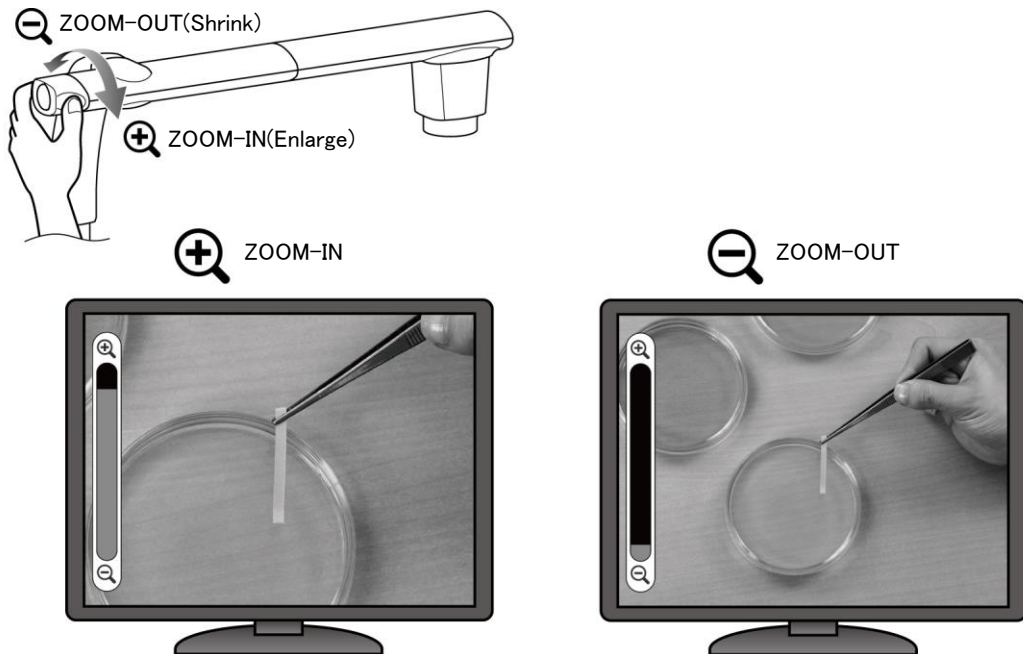

Note

- Zoom ratio: Optical 12x, Digital 8x (Maximum digital zoom is 4x when using RGB output.)
- When the optical zoom reaches 12x, it automatically shifts to the digital zoom.
- Within the digital zoom range, the image quality is degraded.
- Digital zoom can be set ON/OFF from the Settings menu.

■ AF (AUTO FOCUS)

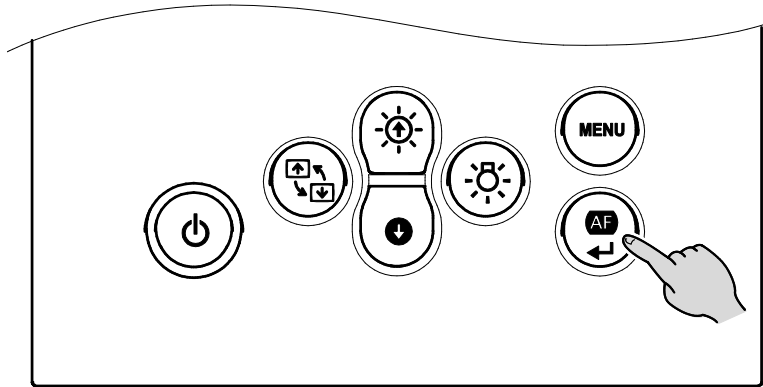

The auto focus works once when the AF button on the operating panel is pressed in One-Push Auto Focus mode. [P. 26](#)

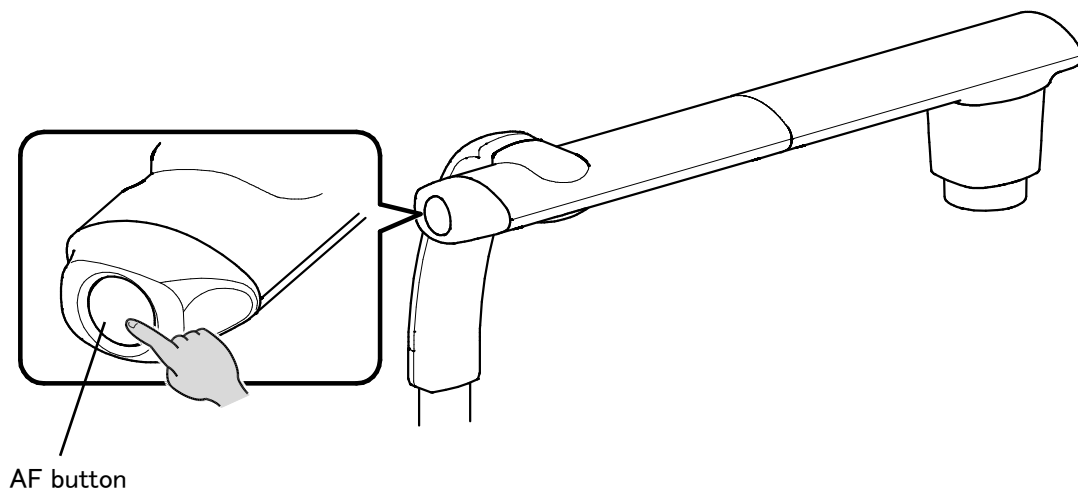

The auto focus can also be performed by pressing the AF button in the camera head.



ADJUSTING THE BRIGHTNESS



Press the [ / ] button on the operating panel to adjust the image brightness.

When the OSD menu is not displayed

Brightness+  : The brightness of the image is increased.

Brightness-  : The brightness of the image is decreased.

※When the OSD menu is displayed, these buttons are used to move the cursor and the brightness adjustment cannot be performed.

※Pressing the [ (brightness+)] button and the [ (brightness-)] button at the same time: The brightness of the image returns to factory default setting.

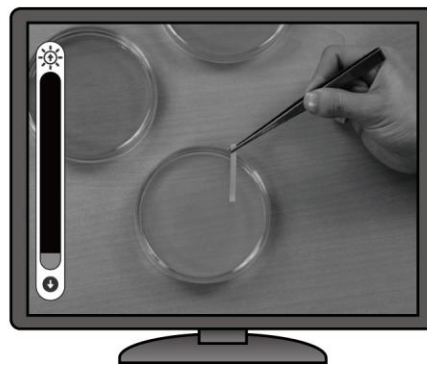
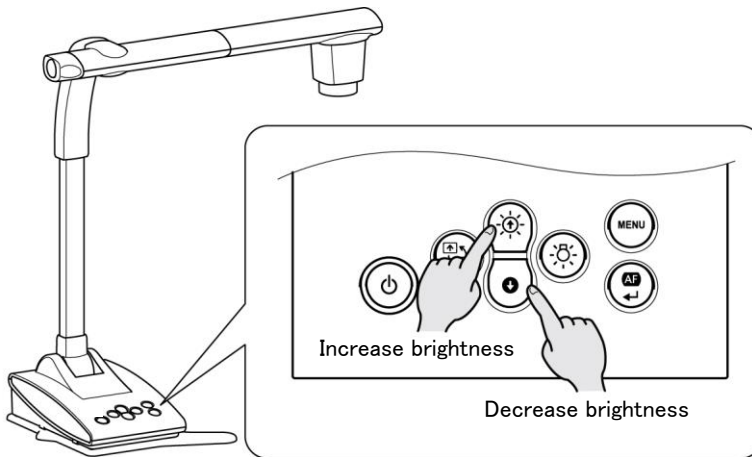

Note

In places where the object is exposed to bright sunlight (e.g. near a window), or extremely bright lights, the brightness of the image may not be decreased well, even by pressing the [] button on the operating panel.

In such cases, to adjust the amount of light, close the curtains or move the object away from the light.

■ TURNING THE LED ON/OFF

The LED lighting can be turned ON/OFF by pressing the LED lighting button.

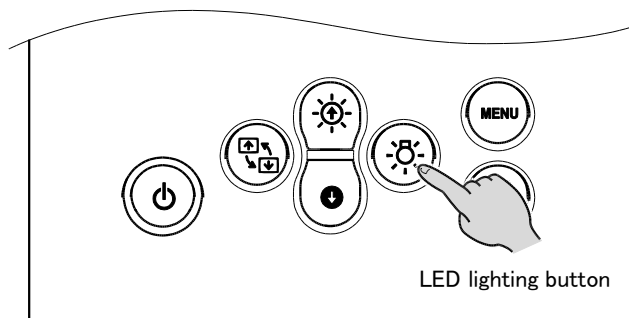
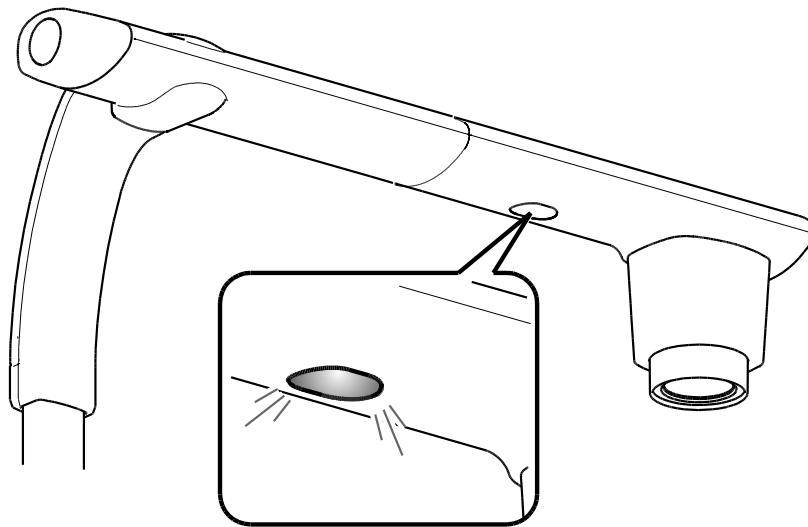

CAUTION



- To take shots of people, turn the LED lighting OFF.
- Make sure that the light from the LED lighting does not shine directly into your eyes.
- This product is equipped with a high-brightness LED. You can safely use it to light up the object.



The brightness will gradually decrease with long-term use. This is not a malfunction but a characteristic of the LED.



- Do not touch the LED lighting while it is on as it may become very hot.



■ CHANGING THE OUTPUT DESTINATION

The output destination of the video signal can be changed by the following procedure:

[ MENU] > [ Settings] > [ Output settings]

Auto : [ MENU] > [ Settings] > [ Output settings] > [Auto]
→The LX-1 automatically selects the output destination.

HDMI: [ MENU] > [ Settings] > [ Output settings] > [HDMI]
→Set the output destination to HDMI.

RGB : [ MENU] > [ Settings] > [ Output settings] > [RGB]
→Set the output destination to RGB.

Note

When the output destination is set to Auto while both HDMI and RGB cables are connected to the LX-1, the LX-1 automatically selects HDMI as the output destination.

CAUTION





The output destination will be changed to the one selected by []. If a corresponding image output device is not connected to the LX-1 you cannot view the image.

Verify that a correct image output device is connected to the LX-1 before selecting the output destination.

2-4 CHANGING THE SETTINGS

Various settings for the LX-1 can be changed through the OSD menu (characters and icons).

■ HOW TO CHANGE THE SETTINGS

- ① Press the [] button on the operating panel to display the OSD menu, and then use the [ / ] buttons to move the cursor to the icon you want to operate or set.
- ② Press the [] button to set the setting value.

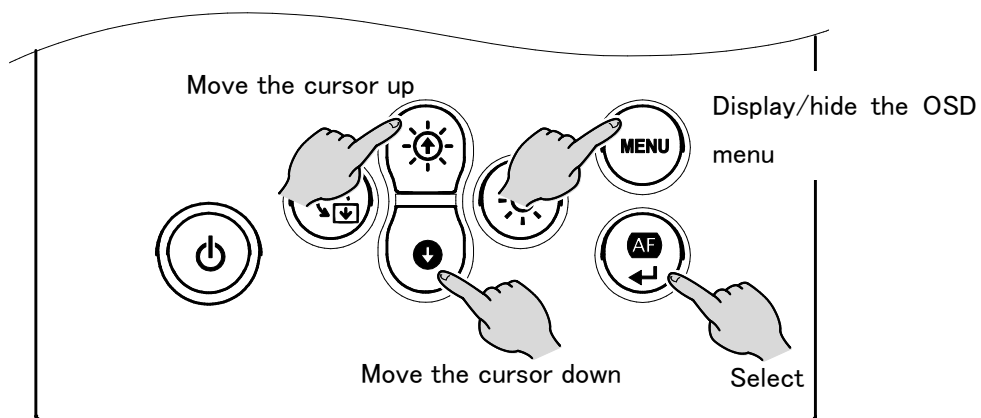

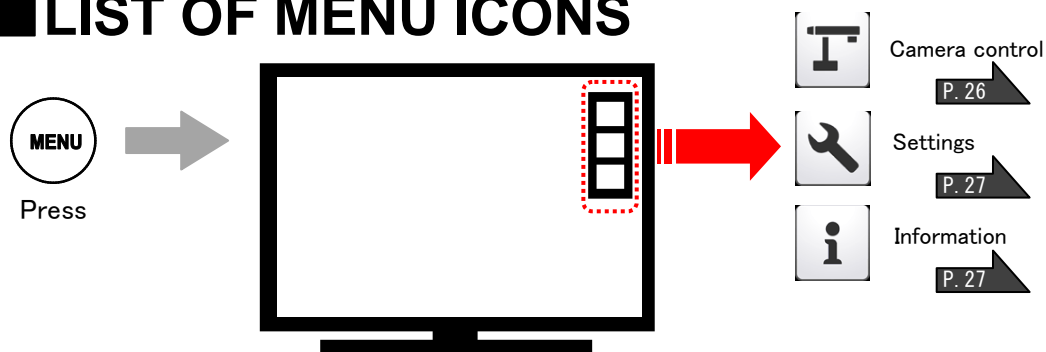

■ LIST OF MENU ICONS







※To go back the previous layer, select []. To hide the menu, press the [] button.

■ DESCRIPTIONS OF EACH MENU







MAIN UNIT [FIRST LAYER]

Icon	Name	Function
	Camera control	To display the setting menu for the camera image.
	Settings	To display the setting menu for various functions.
	Information	To display the setting details.

CAMERA CONTROL [SECOND LAYER]

Icon	Name	Selection Item	Factory Setting	Function
	Microscope mode	ON		To ON/OFF the microscope mode.
		OFF	✓	
		Return		
	Image mode	Document camera	✓	To set to the mode suitable for displaying documents.
		Black&White		To change color to B&W.
		Photo		To set to the mode suitable for displaying photos.
		Return		
	AF mode	Zoom Sync	✓	To auto focus after zooming.
		One-push		To auto focus only once when the AF/Enter button on the operating panel or the AF button in the camera head is pressed.
		Return		
	Return			To go back one layer in the menu.

SETTINGS [SECOND LAYER]

Icon	Name	Selection Item	Factory Setting	Function
	Flickerless	50Hz	Europe/Others	To reduce fluorescent light flickering due to the power supply frequency. Select the same value as used for the power supply frequency.
		60Hz	Japan/U.S	
		Return		
	Digital zoom	ON	✓	To ON/OFF the digital zoom.
		OFF		
		Return		
	Output settings	Auto	✓	To automatically change the output destination (prioritizing HDMI over RGB).
		HDMI		To set the output destination to HDMI.
		RGB		To set the output destination to RGB.
		Return		
	Language	English		To display the menu in English.
		Japanese	✓	To display the menu in Japanese.
		Return		
	Reset	Camera settings		To reset the settings other than network settings to factory defaults.
		Return		
	Return	To go back one layer in the menu.		

INFORMATION [SECOND LAYER]

Name	Description		
Camera	Model name	LX-1	To display the model name of the camera.
	Serial number	*****	To display the serial number of the camera.
	Version	FW : *.*.* Main FPGA: ***** Head FPGA: *****	To display the firmware version of the camera.
Return	To go back one layer in the menu.		

③ ADVANCED OPERATIONS

3-1 CONNECTING TO A COMPUTER VIA THE USB CABLE

The LX-1 is compliant to UVC (video class) standard and there is no need to install a driver. Just by connecting it to the USB port of your computer, you can use the LX-1 with a video conference system or various applications.

By connecting the LX-1 to a computer with Image Mate 4 (the controlling software for the LX-1) installed, the following operations can be performed:

- Save live video streaming or still images to a computer
- Operate the LX-1 from a computer

This instruction manual briefly explains the feature of Image Mate 4.

Refer to the instruction manual of Image Mate 4 for details such as the system requirements of the computer and operation procedure of the OS or the software.

※Image Mate 4 (the controlling software for the LX-1) and its instruction manual can be downloaded from Elmo official website.

For details of Image Mate 4, refer to “④ ABOUT IMAGE MATE 4”  P. 30

※When the image is output via the USB cable, it is not possible to output the image from the RGB and HDM outputs.

<How to connect>

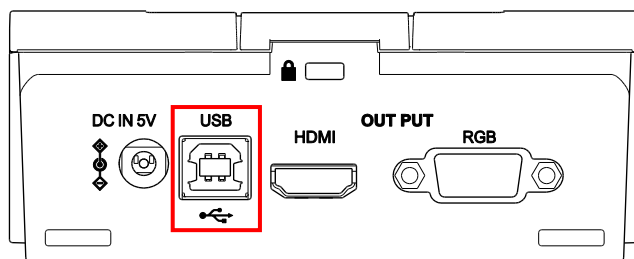

Connect the USB terminal of the LX-1 to a computer with the supplied USB cable (gray).

CAUTION

- Do not connect/disconnect the USB cable while the LX-1 is in operation. It could cause malfunction.
- We recommend using the supplied USB cable or commercially available USB 2.0 compliant USB cable.
- It may take some time to display the image when the video streaming is started or resolution is changed. Do not turn off the power of the LX-1 or disconnect the USB cable before the image is displayed.
- Only MJPEG images can be output through the USB port. Depending on the software you use, you may not be able to display the images.
- The displayed image may pause for a brief second when the object moves quickly. This is not a malfunction.
- The displayed image may be distorted depending on the object being displayed. The image distortion may be improved by the following measures:
 - Reduce the resolution
 - Reduce the frame rate
 - Reduce the image quality

Note

- Depending on the computer's USB environment or the peripheral equipment, image transfer may be disrupted.
- Successful operation in all environments and conditions is not guaranteed.

4 ABOUT IMAGE MATE 4

This instruction manual briefly explains the feature of Image Mate 4, downloading/installation procedure of the instruction manual of Image Mate 4, and the menu items.

For further details, refer to the instruction manual of Image Mate 4.



4-1 INSTALLING IMAGE MATE 4

■ INSTALLATION PROCEDURE

1. Access the following Elmo official website.

<http://www.elmousa.com/LX-1>

<http://elmoeurope.com/en/html/download/02.php>

2. Select "Image Mate 4".
3. Click "Download" and read the "Precautions on the handling of the downloaded data".
Click "Agree"
4. Downloading will start after a short while.
※If you cannot find the downloaded file, check the download folder of your computer.
5. Run "ImageMate4Setup.msi" after the downloading is completed. Follow the instructions displayed in the installation window of Image Mate 4.
6. The icons 「」 and 「」 will be created on the desktop after the installation is completed.

※Advanced WiFi settings can be configured using the Image Mate 4 Setting tool.

Refer to the instruction manual of Image Mate 4 for details of the Setting tool.

P. 34

4-2 USING IMAGE MATE 4

Run Image Mate 4 [**IM**], installed to your computer in the step “4-1 INSTALLING IMAGE MATE 4”.

Select the desired camera to display by the following procedure



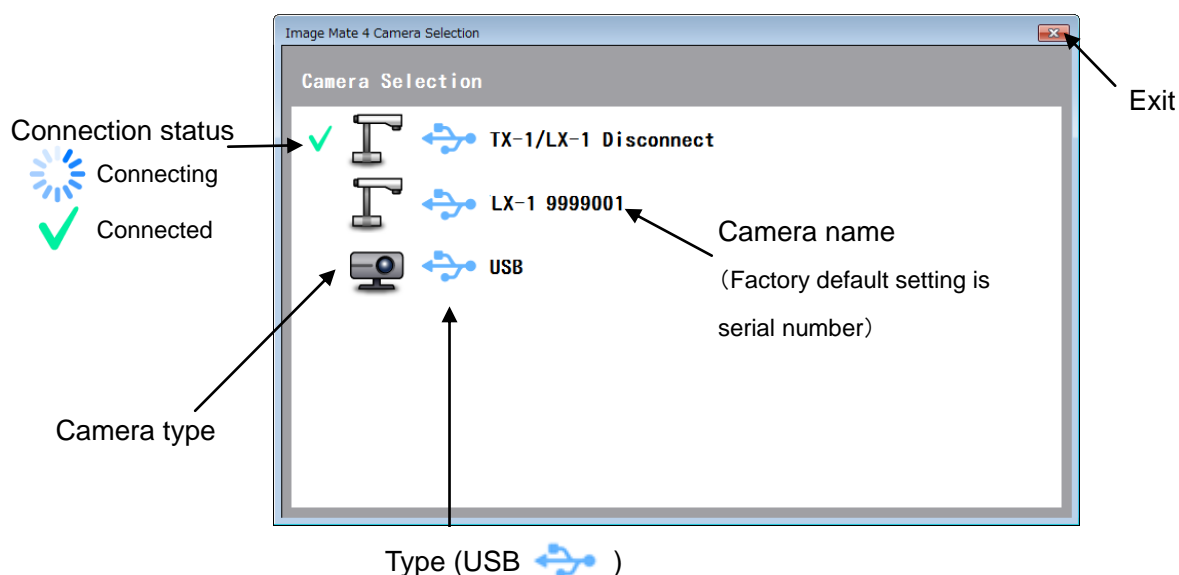

※The camera will not be recognized when it is not turned on. Turn on the camera.

■ HOW TO SELECT THE CAMERA

- When the LX-1 is connected to a computer via the USB cable (the camera selection window does not appear on the screen), the live image of the camera appears after Image Mate 4 is started.
- When several cameras are connected to a computer, the camera selection window appears on the screen.



<Connection procedure>

- ① Click the selected camera name.
- ② The connection status changes to “Connecting” [].
- ③ The connection status changes to “Connected” [] from “Connecting” [] after the connection is established.
 - ※ The software will cancel the selection and start to connect to the other selected camera if the camera name of the other camera is selected before the connection is established.
 - ※ The connection will be disconnected if “Connected” [] is pressed.
- ④ The camera selection window disappears and the live image of the camera appears.









■ MENU WINDOW OF IMAGE MATE 4

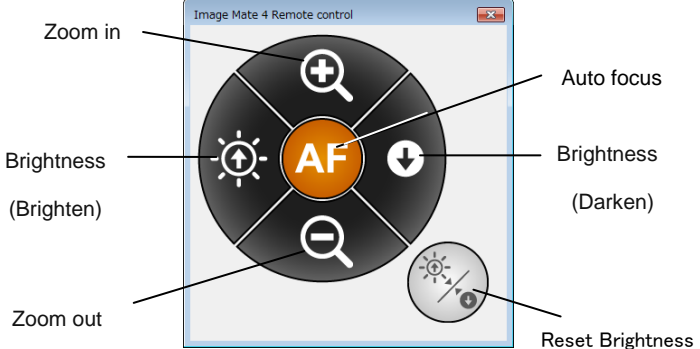

This instruction manual briefly explains the feature of Image Mate 4.

For details, refer to the instruction manual of Image Mate 4.



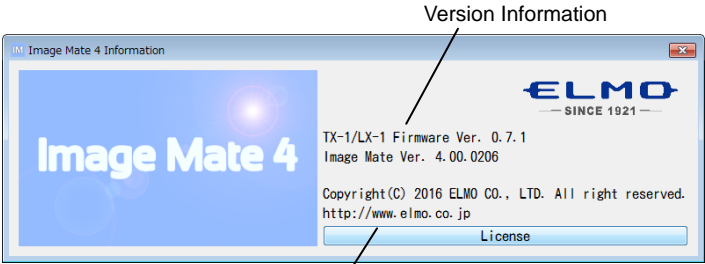

DESCRIPTIONS OF ICONS 【MENU】

Icon	Name	Function
	Remote control	To display the remote control window. 
	Capture	To save the currently displayed image as a still image.
	Start recording/ Stop recording	To start and stop recording.
	Open	To open the destination folder of still image files or video files recorded with Image Mate 4.
	Freeze	To pause the image. Click this icon again to resume the image.
	Rotate Images	To rotate the image by 180°.
	Live settings	To set the resolution, frame rate and image quality.
	Camera selection	To display a list of connected cameras. Select the camera to display.

	<p>Show version</p>	<p>To display the version information of the connected Document Camera and Image Mate 4.</p>  <p>The software license agreement will be displayed. Carefully read it before using Image Mate 4.</p>
	<p>Exit</p>	<p>To close the application. A confirmation window will be displayed when this icon is clicked. Click "OK" to close the application.</p>

DESCRIPTIONS OF ICONS 【STATUS】

	<p>Recording a video</p>	<p>This icon appears during video recording. The color of this icon changes between red and white during video recording.</p>
	<p>Capturing a still image</p>	<p>This icon appears during still image capturing.</p>

This instruction manual briefly explains the feature of Image Mate 4.



For details, refer to the instruction manual of Image Mate 4.

5 ABOUT THE SETTING TOOL

This instruction manual briefly explains downloading / installation procedure of the LX-1 Setting tool. You can find further information of the LX-1 Setting tool in the instruction manual of Image Mate 4, downloaded in the step “4 ABOUT IMAGE MATE 4”. 

For details, refer to the instruction manual of Image Mate 4.

5-1 STARTING THE SETTING TOOL

A shortcut icon for the Image Mate Setting tool [] is created when Image Mate 4 is installed. Click the icon [] to start the Image Mate 4 Setting tool.

5-2 USING THE SETTING TOOL

The following items which cannot be configured from the setting menu of the LX-1 can be configured using the Setting tool:

- White balance settings
- Changing the frequency of the flicker correction
- Saving the zoom position etc

<Setting tool – Camera setting window>

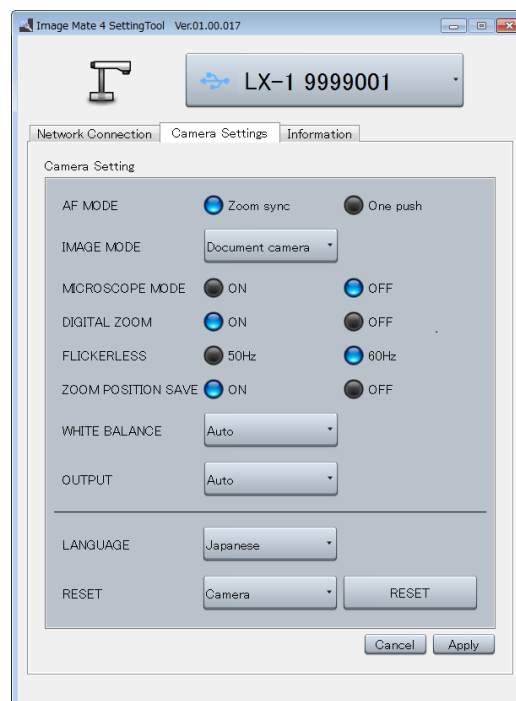

For details, refer to “THE SETTING TOOL” in the instruction manual of Image Mate 4.

※ There is no wireless in the LX-1. Network connection can not be selected.

6 OTHERS

6-1 SHOOTING FORWARD OR BACKWARD

By rotating the camera head you can shoot forward, backward, up, down, left and right.

※For information of the rotatable range of the camera head, refer to P.16 “MOVING PARTS OF THE LX-1”.

The image will become upside down depending on the direction of the rotation. In that case, correct it by pressing the “Image rotation” button on the operating panel.

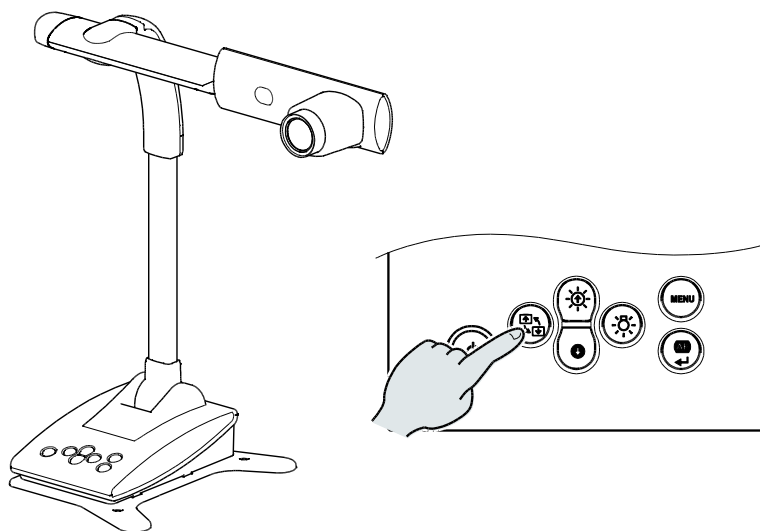

6-2 ABOUT THE BASE PLATE

The base plate of the LX-1 is removable and can be attached in both directions.

Attaching the base plate facing the legs to the camera head direction will prevent the fall of the LX-1.

Change the position of the base plate according to the installation place or the purpose of use.

■ HOW TO CHANGE THE POSITION BASE PLATE

1. Remove 4 screws on the bottom of the LX-1 to remove the base plate.
2. Change the position of the base plate and firmly attach it with 4 screws.

※The base plate can be secured to a desk or stand with screws (M4).

6-3 DISPLAYING ENLARGED IMAGES USING A MICROSCOPE

By attaching the separately sold microscope attachment lens to a microscope, you can display the enlarged image.

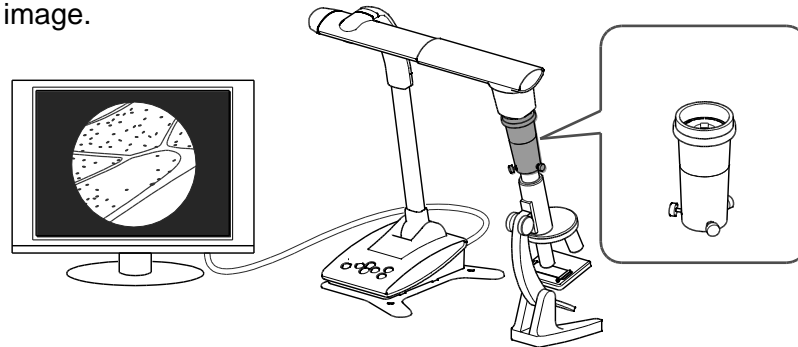

PROCEDURE

① Change the setting of the LX-1.

[ MENU] > [ Camera control] > [ Microscope mode] > [ON]

② Set the microscope.

Place the object you want to view, such as a prepared slide, on the microscope and then look into the microscope to adjust the focus and brightness.

③ Attach the microscope attachment lens.

Attach the guide ring to the microscope attachment lens and cover the eyepiece with it.

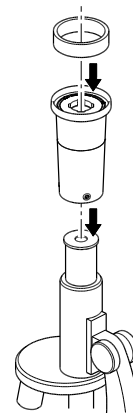
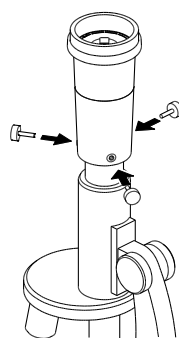

Match the centers of the microscope attachment lens and eyepiece, and use the three screws to evenly tighten the lenses against each other.

CAUTION

If the screws are screwed too tightly, the microscope eyepiece or tube may be damaged. A trace of damage may be left on the microscope where the screws come into contact.

Protecting the microscope with tape before attaching the microscope attachment lens will prevent the damage to a certain extent.

④ Adjust the angle of the microscope and the LX-1 to fit each other.

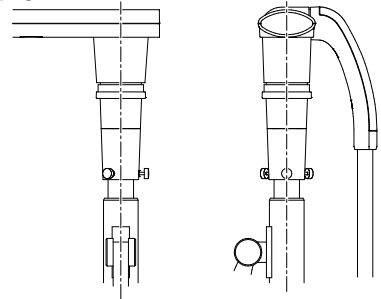

⑤ Adjust the brightness.

Adjust the brightness with the mirror or the light on the microscope.

⑥ Adjust the display range.

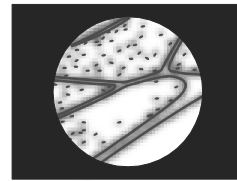
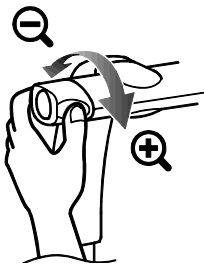
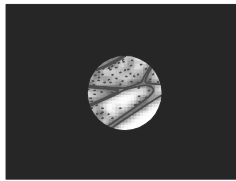

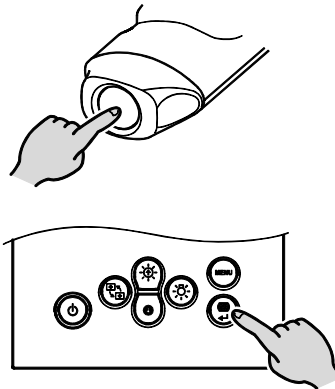
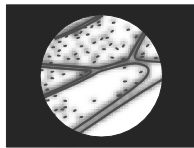

⑦ Adjust the focus.



- Depending on the type of eyepiece, you may not be able to view the object clearly even after adjusting the zoom.
- We recommend using a WF type eyepiece. If you do not use a WF type, we recommend using an eyepiece of 10x or less.
- You can use the microscope attachment lens when the external diameter of the eyepiece is 20 to 28mm.
- Use the thinner guide ring for Microscope Lens Attachment. There are two types of rings included in the package; the thicker one is not used here.

EXITING THE MICROSCOPE MODE

Change the setting of the LX-1.

[ MENU] > [ Camera control] > [ Microscope mode] > [OFF]

6-4 FIRMWARE UPDATE PROCEDURE

The firmware of the LX-1 will be updated from time to time.

By updating the firmware, you will be able to use new functions.

Download the latest firmware from Elmo official website and update the firmware of the LX-1 according to the following procedure.

※Check the firmware version of the LX-1 before starting the firmware update. There is no need to update the firmware if the firmware of the LX-1 is the latest version. P. 27

●Items required for the firmware update

- LX-1
- Computer
- The latest firmware (※1)
- USB cable (to connect the LX-1 to the computer)

※1 Download the latest firmware from the following Elmo official website and copy “update.bin” file to your computer in advance.

<http://www.elmoussa.com/LX-1>

<http://elmoeurope.com/en/html/download/02.php>

<Update Procedure>

1. Connect the LX-1 to your computer via the supplied USB cable.
2. Press the Power button, Image rotation button and LED lighting button together for about 20 seconds until the purple lit Power LED starts to flash between red and blue. P. 13
3. The operating procedure is displayed on a computer screen after the Power LED starts to flash between red and blue.
4. The AutoPlay window appears on a computer screen. Open the folder.
※If the AutoPlay window does not appear, manually open the folder.
5. Copy “update.bin” to the folder you opened.

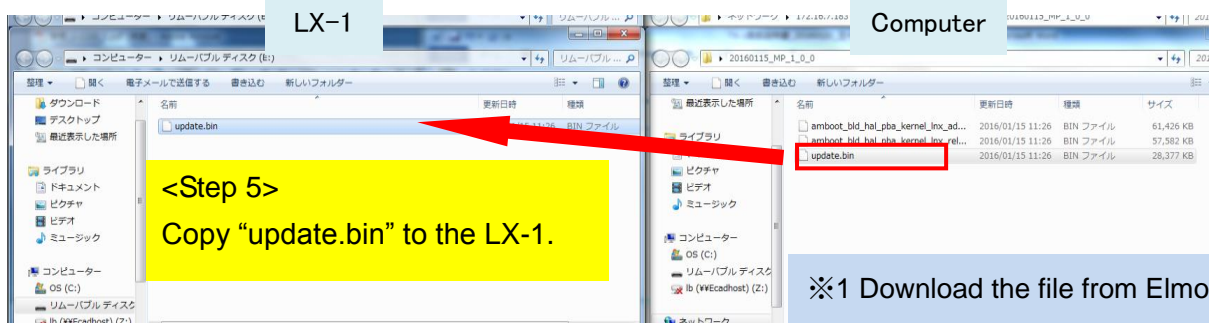

6. Disconnect the USB cable after the copy is completed.
7. When the Power LED starts to flash quickly between red and blue, the firmware update starts.
 - ※The update takes several minutes.
 - (The LX-1 restarts several times during the update process.)
8. The update is complete when the Power LED turns blue.

※Check whether the firmware has been successfully updated to the latest version by going to: “Information” → “Version”. [P. 27](#)

6-5 CAPTURING A3 SIZED DOCUMENTS

The LX-1 can capture images in 3 different angles of view.

A3 sized documents (4:3 aspect ratio ①) can be captured. The shooting conditions are as follows: For details about how to change the resolution, refer to “Live Settings” [P. 32](#)

◆ A3 sized documents shooting conditions (when not using the zoom)

• A3 sized documents cannot be captured when the LX-1 is connected to a computer via the HDMI cable.

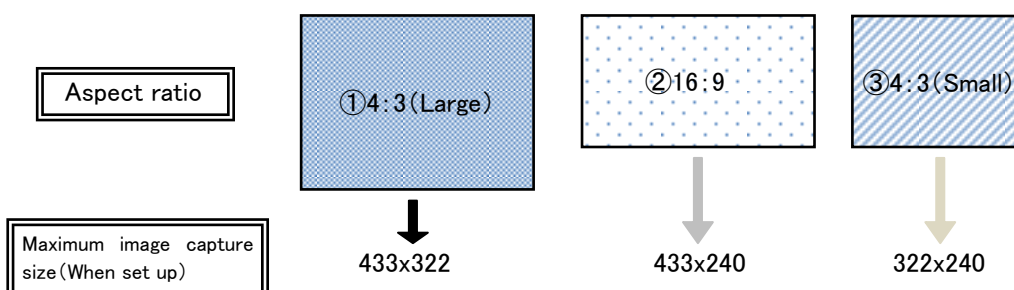



RGB	XGA	①
HDMI	1080i	②
	720p	②
USB	1080p	②
	720p	②
	XGA	①
	VGA	①

7 TROUBLE SHOOTING

7-1 SYMPTOMS AND CONFIRMATION

Check the following items. If any abnormality is found, consult the dealer from whom you purchased this product or our nearest branch/office.

Symptom	Possible cause/remedy
No image is displayed.	<ul style="list-style-type: none"> • The cable is not correctly connected. • The AC adapter is disconnected from the wall outlet. • The AC adapter is disconnected from the power supply socket of the unit. • The power is not ON. (Blue light) • Zoom is set at the TELE side, displaying only the white or black part of the document. • If you turn the power ON immediately after turning it OFF, the unit may not start. Wait for several seconds after turning the power OFF, and then turn it back ON. • Wrong output destination (Auto/HDMI/RGB) is selected. Set the correct output destination. Use a correct monitor which supports the set output signal. • Reconnect the AC adapter or the power cable.
No image is output from the RGB and HDMI outputs.	<ul style="list-style-type: none"> • Is the USB cable connected? When the image is output via the USB cable, it is not possible to output the image from the RGB and HDM outputs. . Remove the USB cable and retry
The output image (resolution) changes automatically.	<ul style="list-style-type: none"> • When the HDMI monitor is connected, the output image (resolution) is automatically changed based on information from the connected monitor.
No image is displayed from the USB. (when connecting to a computer)	<ul style="list-style-type: none"> • Image Mate 4 is not started correctly. Restart Image Mate 4 and try to connect again.
The image is out of focus.	<ul style="list-style-type: none"> • The document (object) is too close to the lens. Move the document (object) slightly away from the lens. • CAMERA CONTROL [SECOND LAYER] it may be difficult to obtain a proper focus when the AF mode is set to "Zoom sync". Try to press the AF button to obtain a proper focus.
The image is too dark.	<ul style="list-style-type: none"> • The intensity of the lighting is insufficient. Press the [] button on the operating panel to adjust the brightness. Or press the [] button to turn on the LED lighting.
The image does not move.	<ul style="list-style-type: none"> • "Freeze" function is selected by Image Mate 4. Cancel the freeze status to resume the live image feed.

The image is striped.	<ul style="list-style-type: none"> • This may be interference fringes between dots of printed matter and TV scanning lines or CMOS pixels. Changing the shooting range may help the problem. • Vertical stripes may appear on an LCD projector image. Manually adjusting the dot clock at the projector side may help the problem. • The image may be distorted when shooting a monitor screen while the live image feed is displayed.
The UVC video stream is upside down.	<ul style="list-style-type: none"> • Verify that the graphic driver and other device drivers of your computer are the latest version. You can download the latest version of device drivers from the official website of the manufacturer of your computer.
Other image than the camera image overlaps on the UVC video stream.	<ul style="list-style-type: none"> • Depending on your software, OS or the connection status, other images than the camera image may be overlapped on the camera image. This can be solved by reconnecting the LX-1 or restarting the software.
No UVC video stream is displayed. (An error message appears.)	<ul style="list-style-type: none"> • The software may recognize it as error when it takes time to prepare the image output. Restart the LX-1 and reconnect it to the computer. Then restart the software.
Fails to output the UVC video stream.	<ul style="list-style-type: none"> • Disconnect the USB cable and restart the software. Then connect the USB cable again. • If the problem still persists, contact the manufacturer of your software and check if the software supports MJPEG.
The UVC video stream sometimes freezes.	<ul style="list-style-type: none"> • The displayed image may pause for a brief second when the object moves quickly. In that case, adjusting the brightness manually may improve the problem.

About the light (LED lighting)

The brightness of the LED lighting will diminish with long-term use. If its brightness has significantly diminished, consult the dealer from whom you purchased this product or our nearest branch/office for replacement (subject to charge).

About long-term usage of this product

Due to the lifetime of its parts, if this product is used for longer than the warranty period, its performance and quality may deteriorate. In this case, we will replace the parts for a charge. Consult the dealer from whom you purchased this product or our nearest branch/office.

⑧ SPECIFICATIONS

8-1 GENERAL

Item	Specifications
Power source	DC5V (AC adapter AC100 ~ 240V)
Power consumption	7.0W
Outside dimensions	W391.7 x D230.0 x H427.9mm (When setup)
	W183.0 x D230.0 x H482.8mm (When folded)
Weight	Approx. 2.4kg (Main body only)
Output terminal	RGB input Mini Dsub 15P connector, female x 1
	HDMI output terminal x 1
Ext. control terminal	USB device (2.0 compliant) Mini-B receptacle x 1

8-2 MAIN CAMERA

Item	Specifications															
Lens	f=4.0mm ~ 48.0mm F3.2~F3.6															
Frame rate	30fps															
Shooting area	<table border="1"> <thead> <tr> <th></th> <th colspan="2">Max.</th> <th colspan="2">Min.</th> </tr> </thead> <tbody> <tr> <td>1080i</td> <td>433.1mm</td> <td>240.1mm</td> <td>46.9mm</td> <td>26.4mm</td> </tr> <tr> <td>XGA</td> <td>433.1mm</td> <td>322.5mm</td> <td>46.9mm</td> <td>35.2mm</td> </tr> </tbody> </table>		Max.		Min.		1080i	433.1mm	240.1mm	46.9mm	26.4mm	XGA	433.1mm	322.5mm	46.9mm	35.2mm
	Max.		Min.													
1080i	433.1mm	240.1mm	46.9mm	26.4mm												
XGA	433.1mm	322.5mm	46.9mm	35.2mm												
Focus working range	TELE : 200mm ~ ∞ WIDE : 50mm ~ ∞															
Optical zoom	12x															
Digital zoom	8x (max.4x when using RGB output)															
Focus	Manual(Push) / Zoom Sync															
Image pick-up element	1/2.8" CMOS 3.4mil pixels															
Total pixels	H: 2144 / V: 1588															
Effective pixels	H: 1920 / V: 1440															
Sync. signal	Internal															
Resolution	HDMI 1080i Horizontal: 800TV lines or more Vertical: 800TV lines or more															

Item	Specifications	
Analog RGB output	Analog RGB output 0.7V (p-p) 75 Ω unbalanced Sync. signal XGA : Negative polarity	XGA : 1024 × 768 @ 60Hz Horizontal frequency: 48.363kHz Vertical frequency: 60.004Hz
HDMI output	Image output 1080i 720p	
White balance	Auto / Natural light / Fluorescent light / Incandescent light ※1	
Brightness control	Auto (with level adjustment) / Manual	
Image mode	Document / B&W / Photo	
Flicker correction	60Hz / 50Hz	

※1 The white balance mode can be set using the Setting tool. Refer to the instruction manual of Image Mate 4 for details.  P. 30

8-3 ILLUMINATION DEVICE

Item	Specifications
Illumination light	White LED

8-4 TRADEMARKS AND LICENSES

ELMO、Image Mate are the registered trademarks of ELMO Co., Ltd.

HDMI、**HDMI**™ logo and High-Definition Multimedia interface are trademarks or registered trademarks of HDMI Licensing LLC.

All other company/product names described in this manual are trademarks or registered trademarks of their respective companies.

This product is licensed under the AVC Visual Patent Portfolio License (AVC Video) for the personal and non-commercial use of a consumer to

- (i) play AVC Video that was recorded by a consumer engaged in a personal and a non-commercial activity and/or,
- (ii) play AVC Video that was obtained from a video provider licensed from MPEG-LA, LLC.

Additional information including that relating to promotional and commercial uses may be obtained from MPEG-LA, LLC.

ATTENTION

- Unless used for personal use, it is prohibited by copyright law to record slides, books and photos without the prior consent of copyright holder.
- This product is designed to be used in industrial environment. If it is used in a residential area or in an adjacent area thereto, harmful interference to radio or television reception may occur.
- Repair parts
Repair parts are the items which are needed to maintain product functionality. The holding period of such repair parts is 8 years after the product discontinuation, which is equal to the repair period we will accept.
- Any image, which is obtained by this product, and which can be identified, is considered to be private information. Be forewarned that the person who makes use of such images shall be liable for disclosing of such images.

For details about specifications and instruction manual of the product, refer to the following official website.

<http://www.elmousa.com/LX-1>

<http://elmoeurope.com/en/html/download/02.php>

6X1VLAB04 R0-Xxx