



Panasonic®

Operating Instructions Plasma Television

Model No. **TX-P37C10Y**
TX-P37C10YS
TX-P42C10Y
TX-P42C10YS
TX-P50C10Y

Contents

Be Sure to Read

- Safety Precautions 4
(Warning / Caution)
- Notes 5
- Maintenance 5

Quick Start Guide

- Accessories / Options 6
- Identifying Controls 8
- Basic Connection 10
- Auto Setup 12
- How to Use Menu Functions 14

VIERA

VIERA
Link



VIERA
IMAGE VIEWER



DVB®

DOLBY
DIGITAL PLUS

dts™
Digital Out



HD
TV

HDMI™
HIGH-DEFINITION MULTIMEDIA INTERFACE

Please read these instructions before operating your set and retain them for future reference.
The images shown in this manual are for illustrative purposes only.
Please refer to Pan European Guarantee Card if you need to contact your local Panasonic dealer for assistance.

For more detailed instructions, refer to the Operating Instructions on the CD-ROM.
To view the Operating Instructions on the CD-ROM, you need a computer equipped with a CD-ROM drive, and Adobe® Reader® (Version 7.0 or later is recommended) installed on your computer.
Depending on the operating system or settings on your computer, the Operating Instructions may not start automatically.
In this case, open the PDF file under \MANUAL\PDF manually to view the instructions.

English



TQB0E0825U-G

Turn your own living room into a movie theatre!

Experience an amazing level of multi-



Notice for DVB functions

- Any functions related to DVB (Digital Video Broadcasting) will work in areas where DVB-T (MPEG2 and MPEG4-AVC(H.264)) digital terrestrial broadcasting are received or where DVB-C (MPEG2 and MPEG4-AVC(H.264)) digital cable services are supplied.

Consult your local dealer with coverage areas or your cable provider to access.

- DVB functions may not be available in some countries.
- Some functions may not be available in some countries.
- Some functions may not be available with some cable provider.
- This TV has the capability for DVB specifications. But future DVB services cannot be guaranteed.

media excitement

Enjoy rich multi-media

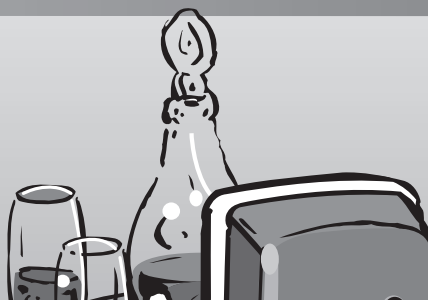
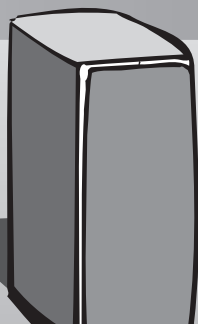
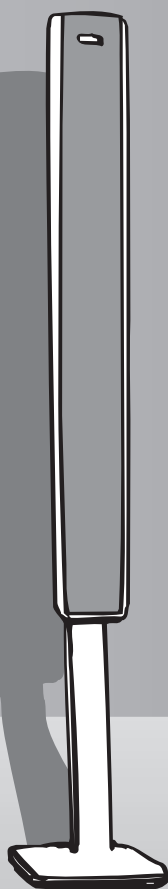
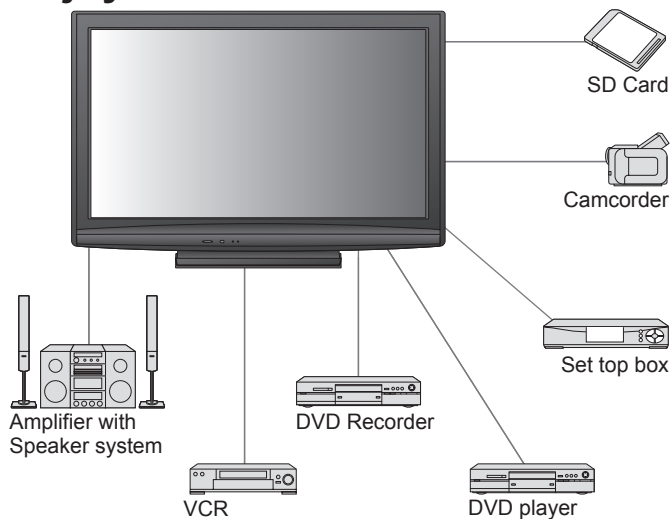

Up to 100,000 hours Plasma Panel Lifetime

The Plasma display panel used in the 2009 VIERA TV range is rated for up to 100,000 hours.*

*This measurement is based on the time taken for the brightness of the panel to reduce to half of its maximum level.

The time taken to reach this level may vary depending on the image content and the environment where the TV is used.

Image retention and malfunctions are not taken into account.

Safety Precautions

Warning

Handling the mains plug and lead

- Insert the mains plug fully into the socket outlet. (If the mains plug is loose, it could generate heat and cause fire.)
- Ensure that the mains plug is easily accessible.
- Ensure the earth pin on the mains plug is securely connected to prevent electrical shock.
 - An apparatus with CLASS I construction shall be connected to a mains socket outlet with a protective earthing connection.
- Do not touch the mains plug with a wet hand. (This may cause electrical shock.)
- Do not use any mains lead other than that provided with this TV. (This may cause fire or electrical shock.)
- Do not damage the mains lead. (A damaged lead may cause fire or electrical shock.)
 - Do not move the TV with the lead plugged in the socket outlet.
 - Do not place a heavy object on the lead or place the lead near a high-temperature object.
 - Do not twist the lead, bend it excessively, or stretch it.
 - Do not pull on the lead. Hold onto the mains plug body when disconnecting lead.
 - Do not use a damaged mains plug or socket outlet.

If you find any abnormality, remove the mains plug immediately!

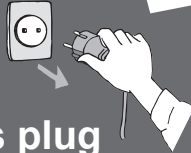

AC 220-240 V
50 / 60 Hz



Power source

- This TV is designed to operate on 220-240 V, 50 / 60 Hz AC.

Do not remove covers NEVER modify the TV yourself

(High-voltage components may cause serious electrical shock.)

- Do not remove the rear cover as live parts are accessible when it is removed. There are no user serviceable parts inside.
- Have the TV checked, adjusted, or repaired at your local Panasonic dealer.

Do not expose to rain or excessive moisture

- To prevent damage which might result in electric shock or fire, do not expose this TV to rain or excessive moisture. This TV must not be exposed to dripping or splashing water and objects filled with liquid, such as vases, must not be placed on top of or above the TV.

Do not expose to direct sunlight and other sources of heat

- Avoid exposing the TV to direct sunlight and other sources of heat. To prevent fire never place any type of candle or naked flame on top or near the TV.

Do not place foreign objects inside the TV

- Do not allow any objects to drop into the TV through the air vents (fire or electrical shock may result).

Do not place the TV on sloped or unstable surfaces

- The TV may fall off or tip over.

Use only the dedicated pedestals / mounting equipment

- Using an unapproved pedestal or other fixtures may make the TV unstable, risking injury. Be sure to ask your local Panasonic dealer to perform setup.
- Use approved pedestals / mounts (p. 6).

Do not allow children to handle SD Card

- As with a small object, SD Card can be swallowed by young children. Please remove SD Card immediately after use.

Caution

■ When cleaning the TV, remove the mains plug

- Cleaning an energized TV may cause electrical shock.

■ When the TV is not going to be used for a long period of time, remove the mains plug

- This TV will still consume some power even in the Off mode, as long as the mains plug is still connected to a live socket outlet.

■ Transport only in upright position

- Transporting the TV with its display panel facing upright or downward may cause damage to the internal circuitry.

■ Allow sufficient space around the TV for radiated heat

Minimum distance

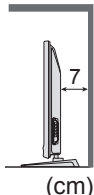
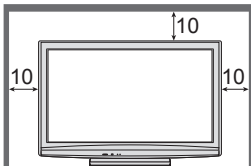

- When using the pedestal, keep the space between the bottom of the TV and the surface where the TV is set.

- In case of using Wall-hanging bracket, follow the manual of it.

■ Do not block the rear air vents

- Blocked ventilation by newspapers, table cloths, curtains, etc. may cause overheating, fire or electrical shock.

■ Do not expose your ears to excessive volume from the headphones

- Irreversible damage can be caused.

■ The TV is heavy. Handle the TV by 2 or more people. Support as shown to avoid injury by the TV tipping or falling.

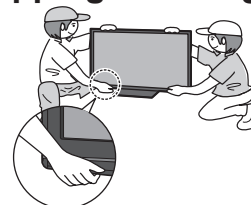

Notes

Do not display a still picture for a long time

This causes the image to remain on the plasma screen ("image retention").

This is not considered a malfunction and is not covered by the warranty.

Typical still images

- Channel number and other logos
- Image displayed in 4:3 mode
- Video game
- Computer image



To prevent image retention, contrast is lowered automatically after a few minutes if no signals are sent or no operations are performed.

■ Auto power standby function

- If no signal is received and no operation is performed in Analogue TV mode for 30 minutes, the TV will automatically go to standby mode.

■ Keep the TV away from these types of equipment

- Electronic equipment
In particular, do not place video equipment near the TV (electromagnetic interference may distort images / sound).
- Equipment with an infrared sensor
This TV also emits infrared rays (this may affect operation of other equipment).

Maintenance

First, remove the mains plug from the socket outlet.

Display panel

Regular care: Gently wipe the surface clean of dirt by using a soft cloth.

Major contamination: Wipe the surface clean using a soft cloth dampened with clean water or diluted neutral detergent (1 part detergent to 100 parts water). Then, using a soft dry cloth, evenly wipe the surface clean until it is dry.

Caution

- Do not tap or scratch the surface with your fingernail or other hard object.
- Take care not to subject the surface to insect repellent, solvent, thinner, or other volatile substances (this may degrade surface quality).

Cabinet, Pedestal

Regular care: Wipe the surface clean using a soft dry cloth.

Major contamination: Dampen a soft cloth with clean water or water containing a small amount of neutral detergent. Then, wring the cloth and wipe the surface clean with it. Finally, wipe the surface clean with a dry cloth.

Caution

- Take care not to subject the TV's surfaces to detergent (a liquid inside the TV could lead to product failure).
- Take care not to subject surfaces to insect repellent, solvent, thinner, or other volatile substances (this may deteriorate the surface by peeling the paint).
- Do not allow the cabinet and pedestal to make contact with a rubber or PVC substance for a long time.

Mains plug

Wipe the mains plug with a dry cloth at regular intervals. (Moisture and dust may lead to fire or electrical shock.)

Accessories / Options

Standard accessories

Check that you have the accessories and items shown

- Remote Control
- N2QAYB000328



- Batteries for the Remote Control (2)
- R6 (UM3)

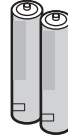

- Mains Lead
- ➔ p. 11

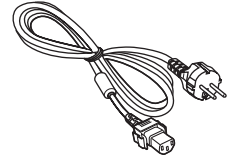

- Operating Instructions
- Pan European Guarantee Card

- Cleaning cloth
- (TX-P37C10Y)
- (TX-P42C10Y)
- (TX-P50C10Y)



- Pedestal
- ➔ p. 7

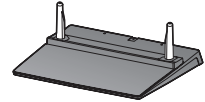

- This product contains possibly dangerous parts (such as plastic bags), that can be breathed in or swallowed by young children accidentally. Keep these parts out of reach of young children.

Optional accessories

- Wall-hanging bracket
- TY-WK4P1RW

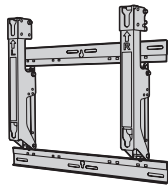

Caution

- In order to maintain the unit's performance and safety, be absolutely sure to ask your dealer or a licenced contractor to secure the wall-hanging brackets.
- Carefully read the instructions accompanying the pedestal, and be absolutely sure to take steps to prevent the TV from tipping over.
- Handle the TV carefully during installation since subjecting it to impact or other forces may cause product damage.
- Take care when fixing wall brackets to the wall. Always ensure that there are no electrical cables or pipes in the wall before hanging bracket.
- To prevent fall and injury, remove the TV from its fixed wall position when it is no longer in use.

Installing / removing remote's batteries

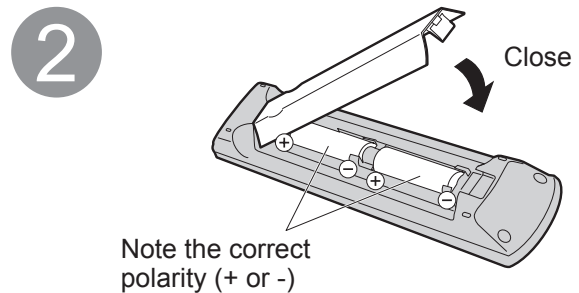
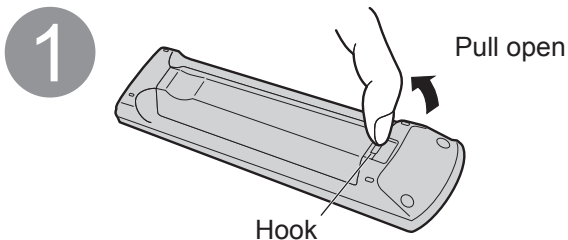

Caution

- Incorrect installation may cause battery leakage and corrosion, resulting in damage to the remote control.
 - Do not mix old and new batteries.
 - Do not mix different battery types (such as alkaline and manganese batteries).
 - Do not use rechargeable (Ni-Cd) batteries.
 - Do not burn or breakup batteries.
- Batteries must not be exposed to excessive heat such as sunshine, fire or the like.

Attaching the pedestal

Warning

Do not disassemble or modify the pedestal.

- Otherwise the TV may fall over and become damaged, and personal injury may result.

Caution

Do not use any other TV and displays.

- Otherwise the TV may fall over and become damaged, and personal injury may result.

Do not use the pedestal if it becomes warped or physically damaged.

- If you use the pedestal while it is physically damaged, personal injury may result. Contact your nearest Panasonic dealer immediately.

During set-up, make sure that all screws are securely tightened.

- If insufficient care is taken to ensure screws are properly tightened during assembly, the pedestal will not be strong enough to support the TV, and it might fall over and become damaged, and personal injury may result.

Ensure that the TV does not fall over.

- If the TV is knocked or children climb onto the pedestal with the TV installed, the TV may fall over and personal injury may result.

Two or more people are required to install and remove the TV.

- If two or more people are not present, the TV may be dropped, and personal injury may result.

Ⓐ Assembly screw (4)
(silver)

- XYN5+F18FN

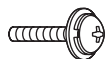

M5 × 18

Ⓑ Assembly screw (4)
(black)

- THEL061N
(TX-P37C10Y, TX-P42C10Y,
TX-P37C10YS, TX-P42C10YS)
- THEL060N
(TX-P50C10Y)

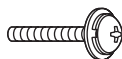

M5 × 25

Ⓒ Pole (2)

- R : TBLA3685
- L : TBLA3686
(TX-P37C10Y, TX-P42C10Y,
TX-P37C10YS, TX-P42C10YS)
- R : TBLA3679
- L : TBLA3680
(TX-P50C10Y)

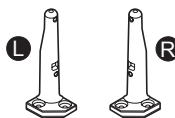

Ⓓ Base

- TBLX0096
(TX-P37C10Y)
(TX-P42C10Y)
- TBLX0127
(TX-P37C10YS)
(TX-P42C10YS)
- TBLX0089
(TX-P50C10Y)



■ Assembling the pedestal

Use the four assembly screws Ⓐ to fasten the left and right poles to the base securely.

- Make sure that the screws are securely tightened.
- Forcing the assembly screws the wrong way will strip the threads.
- "L" or "R" mark is stamped on the bottom of the pole.

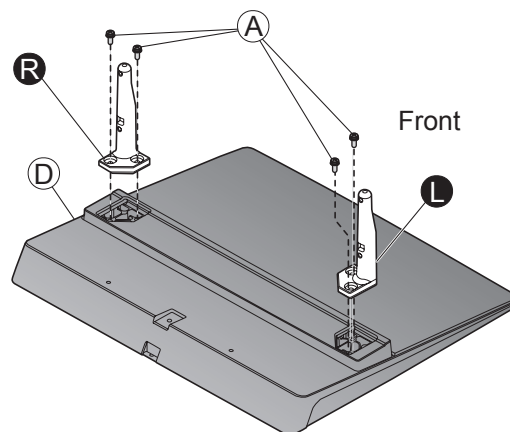

■ Securing the TV

Use the assembly screws Ⓑ to fasten securely.

- Make sure that the screws are securely tightened.
- Carry out the work on a horizontal and level surface.

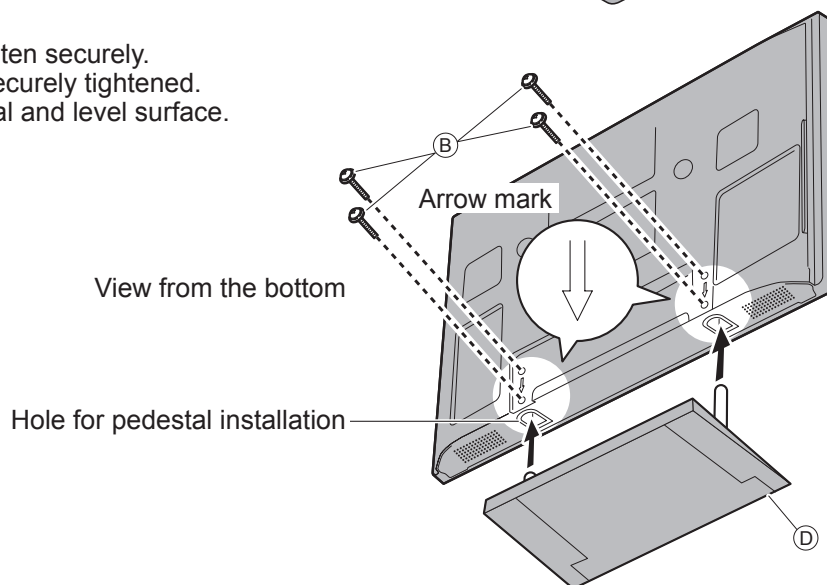

Identifying Controls

TV

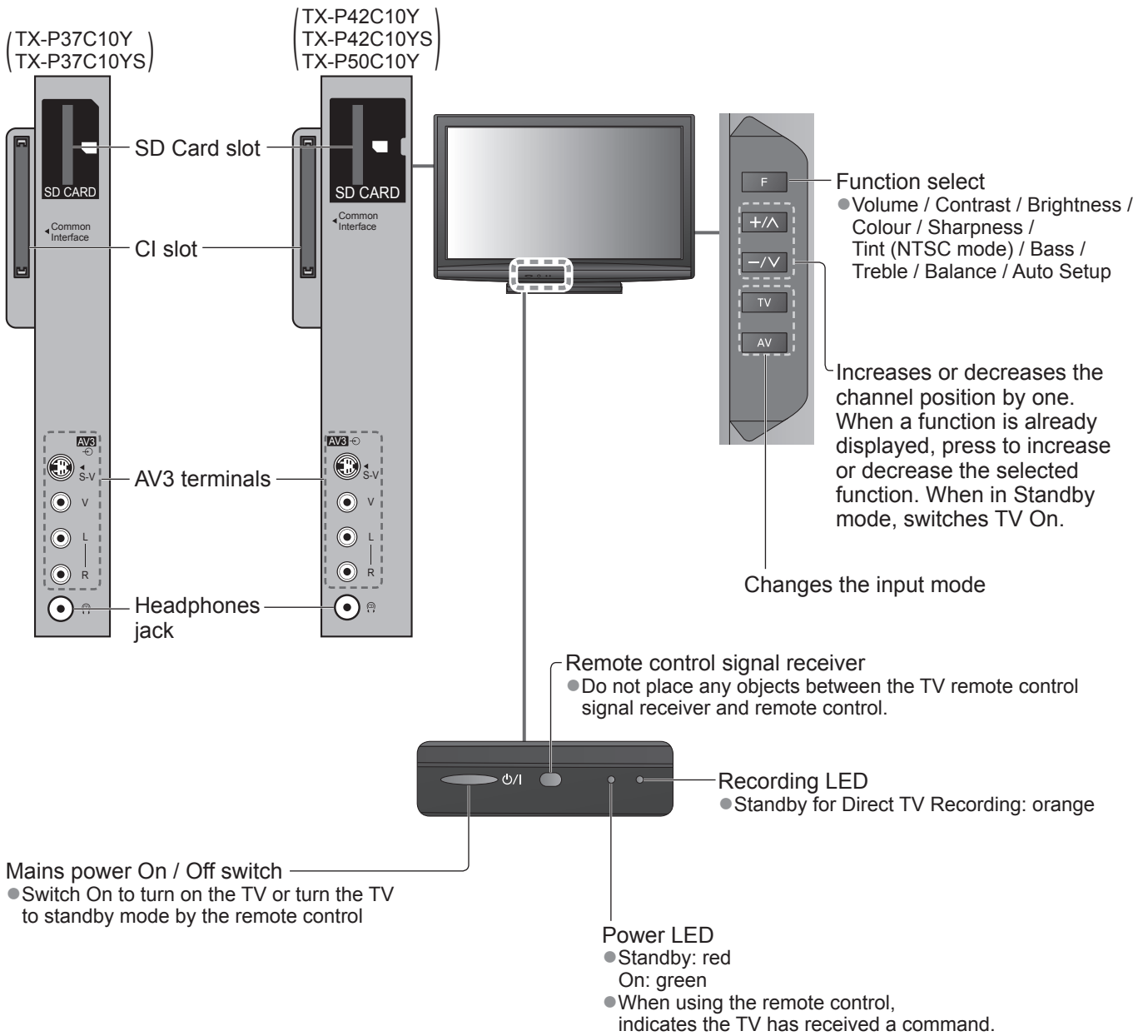

Remote Control

VIERA IMAGE VIEWER

- Switches to SD Card viewing mode

Standby On / Off switch

- Switches TV On or Off standby

Aspect

- Changes aspect ratio from Aspect Selection list
- Also possible by pressing this button repeatedly until you reach the desired aspect

Main Menu

- Press to access Picture, Sound and Setup Menus

Channel / Programme Information

- Displays channel and programme information

VIERA Link Menu

- Accesses VIERA Link Menu

OK

- Confirms selections and choices
- Press after selecting channel positions to quickly change channel

Option Menu

- Easy setting for viewing and sound options

Coloured buttons

- Used for the selection, navigation and operation of various functions

Teletext

- Switches to teletext mode

Subtitles

- Displays subtitles

Numeric buttons

- Changes channel and teletext pages
- Sets characters
- When in Standby mode, switches TV On

Sound Mute

- Switches sound mute On or Off

Volume Up / Down

Input mode selection

- TV - switches DVB-C / DVB-T / Analogue mode
- AV - switches to AV input mode from Input Selection list

Direct TV Recording

- Records programme immediately in DVD Recorder / VCR with Q-Link or VIERA Link connection

Normalise

- Resets picture and sound settings to their default levels

Exit

- Returns to the normal viewing screen

VIERA TOOLS

- Displays some special feature icons and accesses easily

Guide

- Displays TV Guide

Cursor buttons

- Makes selections and adjustments

Return

- Returns to the previous menu / page

Hold

- Freeze / unfreeze picture
- Holds the current teletext page (teletext mode)

Index

- Returns to the teletext index page (teletext mode)

Surround

- Switches Surround sound

Channel Up / Down

- Selects channel in sequence

Connected equipment operations



Basic Connection

External equipment and cables shown are not supplied with this TV.
Please ensure that the unit is disconnected from the mains socket before attaching or disconnecting any leads.
When disconnecting the mains lead, be absolutely sure to disconnect the mains plug at the socket outlet first.

Example 1 Connecting aerial

TV only

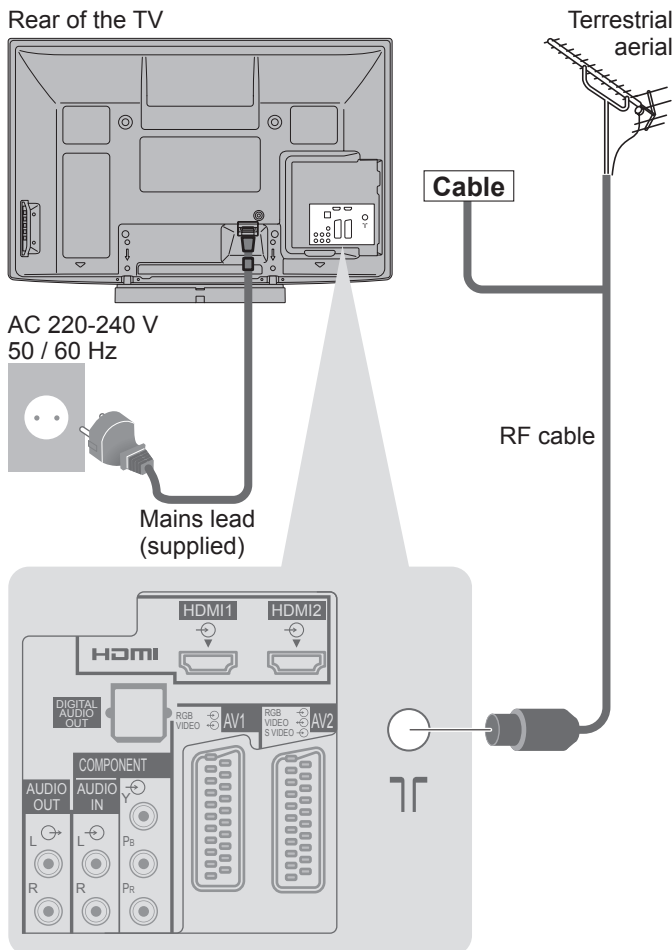

Example 2 Connecting DVD Recorder / VCR

TV, DVD Recorder or VCR

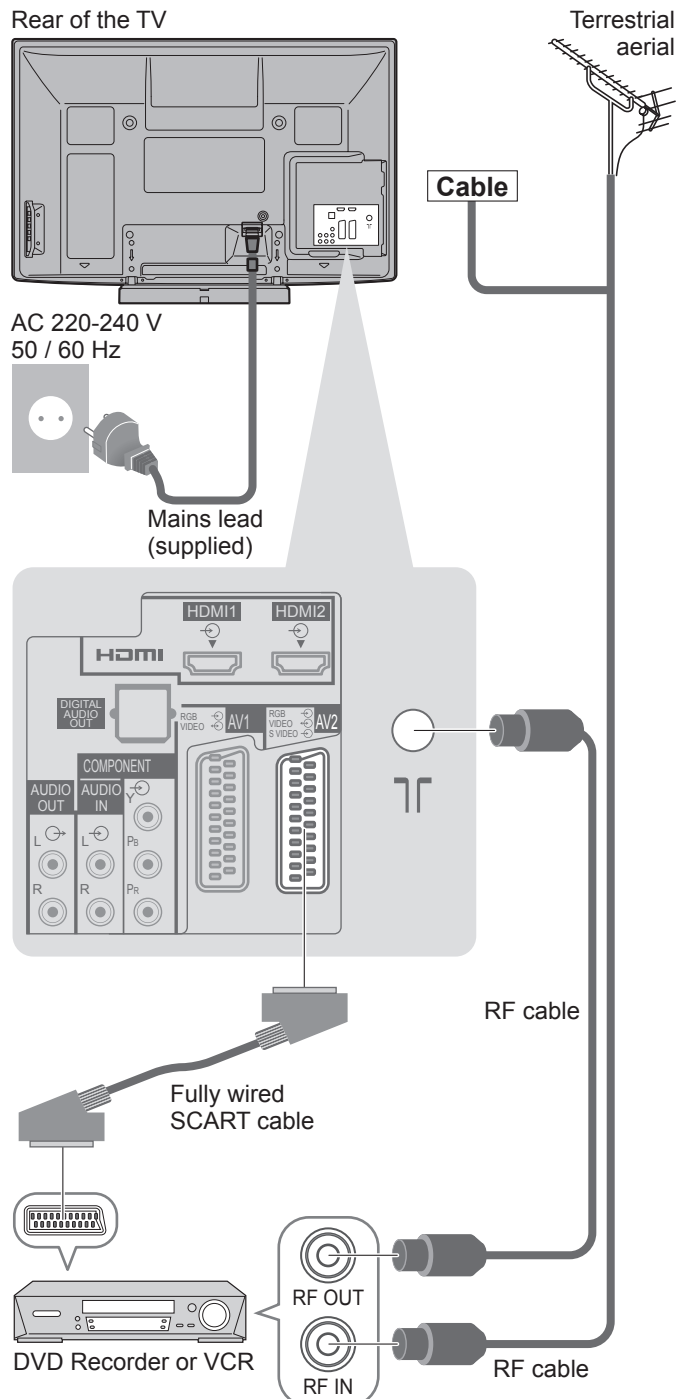

Note

- Connect to the TV's AV1 / AV2 for a DVD Recorder / VCR supporting Q-Link.
- For HDMI-compatible equipment, possible to connect to HDMI terminals (HDMI1 / HDMI2) by using HDMI cable.
- Read the manual of the equipment too.

Example 3 Connecting DVD Recorder / VCR and Set top box

TV, DVD Recorder / VCR and Set top box

Rear of the TV

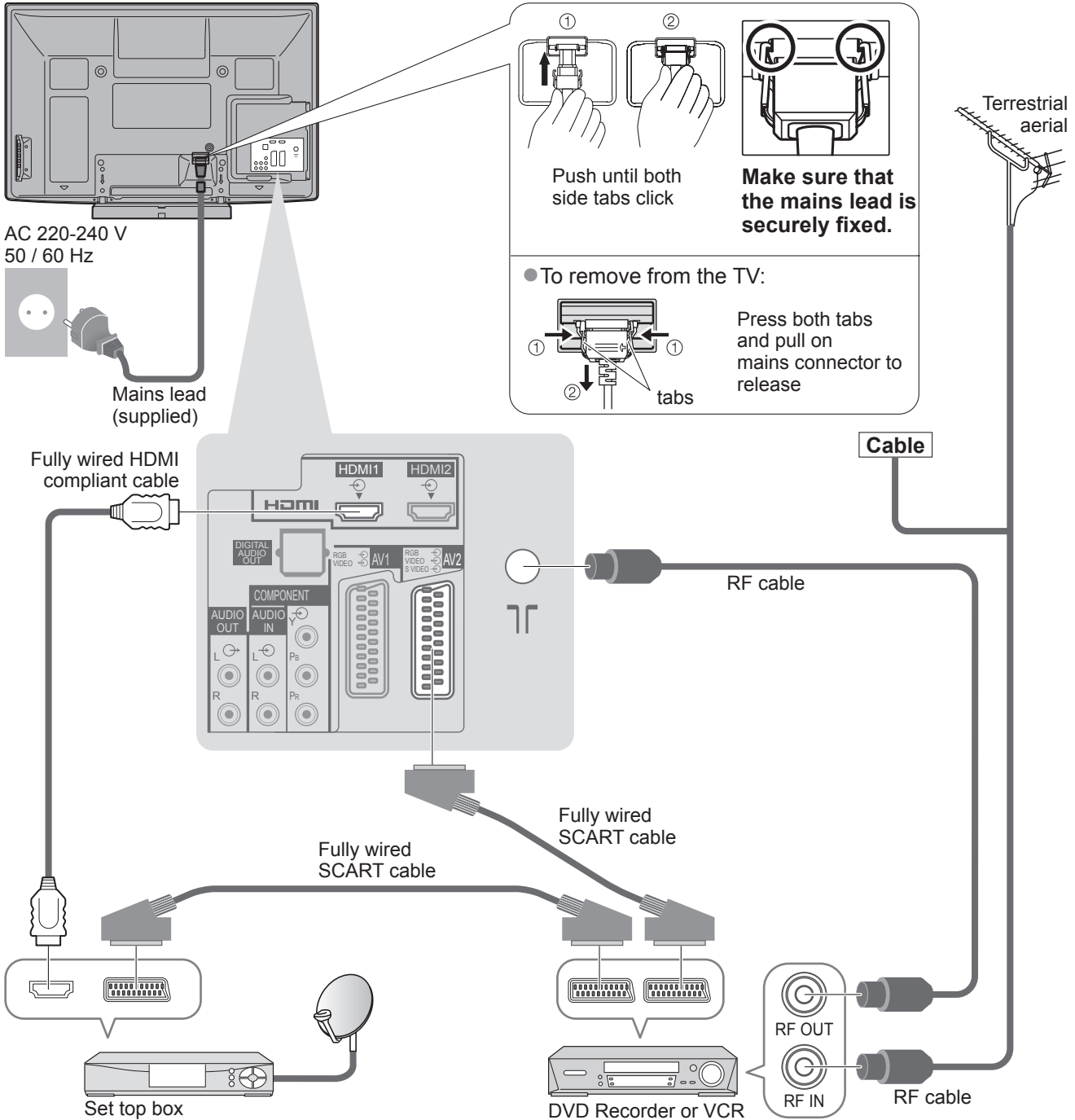

● Basic Connection

Auto Setup

Search and store TV channels automatically.

- These steps are not necessary if the setup has been completed by your local dealer.
- Please complete connections (p. 10 and p. 11) and settings (if necessary) of the connected equipment before starting Auto Setup. For details of settings for the connected equipment, read the manual of the equipment.

1 Plug the TV into mains socket and switch On (Takes a few seconds to be displayed)



2 Select the language

Menüsprache			
Deutsch	Dansk	Polski	Srpski
English	Svenska	čeština	Hrvatski
Français	Norsk	Magyar	Slovenščina
Italiano	Suomi	Slovenčina	Latviešu
Español	Türkçe	Български	eesti keel
Portugués	Ελληνικά	Română	Lietuvių
Nederlands			

3 Select your country

Country		
Germany	Denmark	Poland
Austria	Sweden	Czech
France	Norway	Hungary
Italy	Finland	Slovakia
Spain	Luxembourg	Slovenia
Portugal	Belgium	Estonia
Switzerland	Netherlands	Lithuania
Malta	Turkey	E. Eu
Andorra	Greece	

Auto Setup starts

- Auto Setup will start to search for TV channels and store them. The sorted channel order depends upon the TV signal, the broadcasting system and reception conditions.

Sending Preset Data
Please wait!
0% 100%
Remote control unavailable

- If Q-Link, VIERA Link or similar technology compatible recorder is connected, channel, language, country / region settings are automatically downloaded to the recorder.
- If downloading has failed, you can download later by the menu item. ➔ "Download" (p. 18)

4 Select "Home"

Please select your viewing environment.
Home Shop

Auto Setup is now complete and your TV is ready for viewing.



Using the On Screen Displays

Many features available on this TV can be accessed via the On Screen Display menu.

How to use remote control



Move the cursor / select the menu item



Move the cursor / adjust levels / select from a range of options



Access the menu / store settings after adjustments have been made or options have been set



Return to the previous menu



Open the main menu



Exit the menu system and return to the normal viewing screen

ON SCREEN HELP Instructions box - Operation guide

(example: Sound Menu)

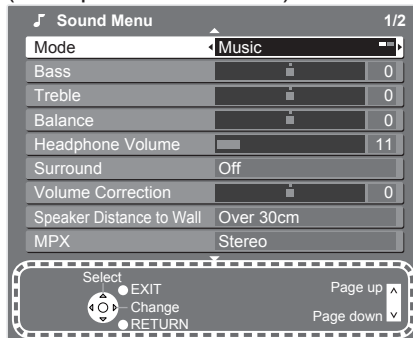

Operation guide will help you.

Note

- If tuning has failed → "Auto Setup" (p. 18 and p. 19)
- To initialize all settings → "Shipping Condition" (p. 19)
- If you turned the TV Off during Standby mode last time, the TV will be in Standby mode when you turn the TV On with Mains power On / Off switch.

Auto Setup varies depending on the country you select

- Favourite Network Selection (if you select "Sweden")

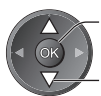
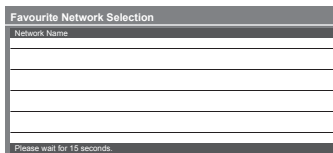

② set
① select network

- Region Selection (if you select "Finland")

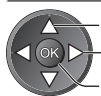

① select region
② set

- Search Mode (if you select "Sweden" or "Finland")



① select mode
② set

- Analogue Auto Setup

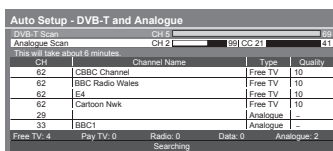

- DVB-T Auto Setup (if you select a country except "Portugal", "Poland", "Hungary" and "E.Eu")

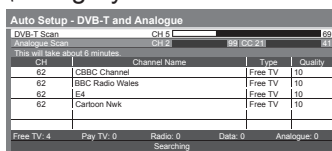

- DVB-C Auto Setup (if you select "Sweden" or "Finland")

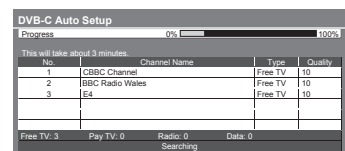

If you select "Shop" by mistake

Return to viewing environment selection by pressing the RETURN button.



Select "Home"



Auto Setup is complete

- If you set to "Off" or "On" in this menu the TV will be in "Shop" viewing environment. To return to "Home" viewing environment initialise all settings by accessing Shipping Condition.

→ "Shipping Condition" (p. 19)



① select
② set

How to Use Menu Functions

Various menus allow you to make settings for the picture, sound, and other functions.



1 Display the menu
 MENU • Displays the functions that can be set (varies according to the input signal)

2 Select the menu
 (example: Picture Menu)
 ② access
 ① select

3 Select the item
 (example: Picture Menu)
 select

4 Adjust or select
 (example: Picture Menu)
 ① change
 ② store or access (Required by some functions)

■ To return to TV at any time
 EXIT

■ To return to the previous screen
 RETURN

■ To change menu pages
 up
 down

■ Choose from among alternatives

Number and positions of alternatives
 Changed

■ Adjust using the slide bar

Moved

■ Go to the next screen

Displays the next screen

■ Enter characters by free input menu

You can enter names or numbers freely for some items.



Set characters one by one

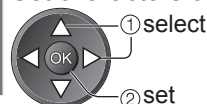

• You can set characters by using numeric buttons.

■ To reset the settings

- To reset the picture settings only
 ➔ "Reset to Defaults" in the Picture Menu (p. 16)
- To reset the sound settings only
 ➔ "Reset to Defaults" in the Sound Menu (p. 17)
- To reset the picture and sound settings together
 ➔ (Also volume level and aspect mode are reset)
- To initialize all settings
 ➔ "Shipping Condition" in the Setup Menu (p. 19)

■ Overview

● How to operate → p. 14

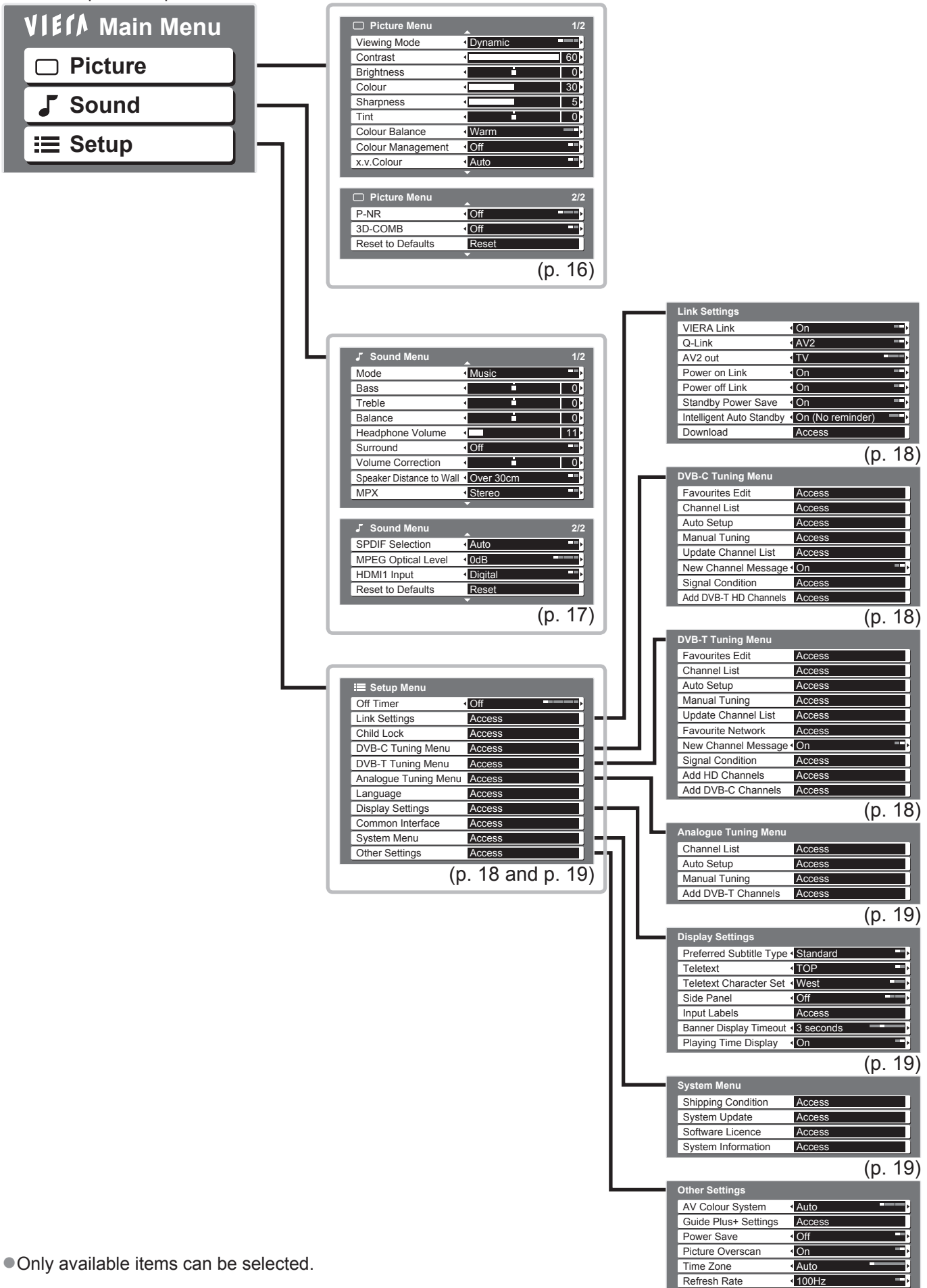

● Only available items can be selected.

How to Use Menu Functions

■ Menu list

Menu	Item	Adjustments / Configurations (alternatives)
Picture	Viewing Mode	<p>Basic picture mode (Dynamic / Normal / Cinema / Game)</p> <ul style="list-style-type: none"> ● Set for each input signal <p>Dynamic : Provides enhanced picture contrast and sharpness when viewing in a bright room Normal : Recommended for viewing under normal ambient room lighting conditions Cinema : For watching movies in a darkened room producing a cinema-like picture Game : Fast response signal specifically to provide suitable images for playing games</p> <ul style="list-style-type: none"> ● Not valid on TV mode ● A continuous record of time spent using Game mode can be displayed in the top right of the screen. <ul style="list-style-type: none"> ➔ "Playing Time Display" (p. 19)
	Contrast, Brightness, Colour, Sharpness	Increases or decreases the levels of these options according to your personal preference
	Tint	<p>With an NTSC signal source connected to the TV, the picture hue can be adjusted to suit your taste</p> <ul style="list-style-type: none"> ● For NTSC signal reception only
	Colour Balance	Allows you to set the overall colour tone of the picture (Cool / Normal / Warm)
	Colour Management	Automatically adjusts colours to vivid ones (Off / On)
	x.v.Colour	<p>Increases the colour gradations (Off / Auto)</p> <ul style="list-style-type: none"> ● This is effective when watching HD moving pictures from an external equipment. ● HDMI input mode only
	P-NR	<p>Picture Noise Reduction</p> <p>Automatically reduces unwanted picture noise and flicker noise in the contoured parts of a picture (Off / Min / Mid / Max)</p>
	3D-COMB	<p>Occasionally, whilst viewing still or slow moving pictures, colour patterning may be seen. Set to "On" to display sharper and more accurate colours (Off / On)</p> <ul style="list-style-type: none"> ● For PAL or NTSC signal reception only ● Not valid on RGB, S-Video, Component, HDMI and SD Card
	Reset to Defaults	Press the OK button to reset the present Picture Viewing Mode to the default settings

Menu	Item	Adjustments / Configurations (alternatives)
Sound	Mode	Basic sound mode (Music / Speech)
	Bass	Increases or decreases level to enhance or minimise lower, deeper sound output
	Treble	Increases or decreases level to enhance or minimise sharper, higher sound output
	Balance	Adjusts volume level of right and left speakers
	Headphone Volume	Adjusts the volume of the headphones
	Surround	Surround sound settings (Off / V-Audio) Provides a dynamic enhancer of width to simulate improved spatial effects ● Switching is also possible by the Surround button on the remote control (p. 9).
	Volume Correction	Adjusts the volume of individual channel or input mode
	Speaker Distance to Wall	Adjusts the low frequency sound (Over 30cm / Up to 30cm) ● If the back space between the TV and wall is over 30 cm, "Over 30cm" is recommended. ● If the back space between the TV and wall is within 30 cm, "Up to 30cm" is recommended.
	MPX	Select stereo / monaural (Mono / Stereo) ● Normally: Stereo ● Stereo signal cannot be received: Mono ● M1 / M2: Available while mono signal is transmitted ● Analogue mode only
	SPDIF Selection	Selects the initial setting for digital audio output signal from DIGITAL AUDIO OUT terminal (Auto / PCM) Auto : Dolby Digital Plus and Dolby Digital are output as Dolby Digital Bitstream. HE-AAC (48 kHz) is output as DTS. MPEG is output as PCM. PCM : Digital output signal is fixed to PCM. ● DVB mode only
	MPEG Optical Level	Normally, MPEG sound is larger comparing with the other types of audio track You can adjust the audio level of MPEG output from DIGITAL AUDIO OUT terminal as the initial setting (0 / -2 / -4 / -6 / -8 / -10 / -12dB) ● DVB mode only
HDMI1 Input	Select to fit the input signal (Digital / Analogue) Digital : HDMI cable connection Analogue : HDMI-DVI adapter cable connection ● HDMI input mode only ● HDMI2 terminal is for digital signal only ● No setting for HDMI2 available	
Reset to Defaults	Press the OK button to reset the present Sound Mode to the default settings	

- A different menu will be displayed while SD Card is used.
- Only available items can be selected.

How to Use Menu Functions

■ Menu list

Menu	Item	Adjustments / Configurations (alternatives)	
Setup	Off Timer	Sets the time the TV automatically turns Off (Off / 15 / 30 / 45 / 60 / 75 / 90 minutes)	
	Link Settings	VIERA Link	Sets to use VIERA Link functions (Off / On)
		Q-Link	Selects which AV terminal is to be used for data communication between this TV and a compatible recorder (AV1 / AV2) ● Select the connected terminal to the recorder even it is not compatible with Q-Link.
		AV1 / AV2 out	Chooses the signal to be transmitted from the TV to Q-Link (TV / AV1 / AV2 / AV3 / Monitor) ● Monitor: Image displayed on screen ● Component and HDMI signals cannot be outputted.
		Power on Link	Sets to use Power on Link function (Off / On)
		Power off Link	Sets to use Power off Link function (Off / On)
		Standby Power Save	Controls the power consumption in Standby mode of the connected equipment to reduce the consumption (Off / On) ● This function is available when "VIERA Link" is set to "On" and "Power off Link" is set to "On".
		Intelligent Auto Standby	Makes non-watched or non-used connected equipment go into Standby mode to reduce the power consumption (Off / On (With reminder) / On (No reminder)) ● This function is available when "VIERA Link" is set to "On".
	Download	Downloads channel, language, country / region settings to a Q-Link or VIERA Link compatible equipment connected to the TV ● DVB-C channel setting cannot be downloaded.	
	Child Lock	Locks a channel / AV input to prevent access to it	
	DVB-C Tuning Menu	Favourites Edit	Creates list of favourite DVB-C channels
		Channel List	Skips the unwanted DVB-C channels or edits DVB-C channels
		Auto Setup	Automatically sets the DVB-C channels supplied
		Manual Tuning	Sets the DVB-C channels manually
		Update Channel List	Updates DVB-C Channel List with keeping your settings
		New Channel Message	Selects whether to give a notification message when a new DVB-C channel is found
		Signal Condition	Checks the DVB-C signal condition
	DVB-T Tuning Menu	Add DVB-T HD Channels	Retunes all TV channels to add DVB-T HD channels ● All the previous tuning settings are erased. ● Use this function if DVB-T HD services start in your area.
		Favourites Edit	Creates list of favourite DVB-T channels
		Channel List	Skips the unwanted DVB-T channels or edits DVB-T channels
		Auto Setup	Automatically sets the DVB-T channels received in the area
		Manual Tuning	Sets the DVB-T channels manually
		Update Channel List	Updates DVB-T Channel List with keeping your settings
		Favourite Network	Selects your favourite network for each broadcasters
		New Channel Message	Selects whether to give a notification message when a new DVB-T channel is found
		Signal Condition	Checks the DVB-T signal condition
		Add HD Channels	Retunes all TV channels to add HD channels ● All the previous tuning settings are erased. ● Use this function if HD services start in your area.
	Add DVB-C Channels	Retunes all TV channels to add DVB-C channels ● All the previous tuning settings are erased. ● Use this function if DVB-C services supply.	

Menu	Item	Adjustments / Configurations (alternatives)		
Setup	Analogue Tuning Menu	Channel List	Skips the unwanted Analogue channels or edits Analogue channels	
		Auto Setup	Automatically sets the Analogue channels received in the area	
		Manual Tuning	Sets the Analogue channels manually	
		Add DVB-T Channels	Retunes all TV channels to add DVB-T channels ● All the previous tuning settings are erased. ● Use this function if DVB-T services start in your area.	
	Language	OSD Language	Changes language for on-screen displays	
		Preferred Audio 1 / 2	Selects the first and second preferred language for DVB multi audio (depending on the broadcaster)	
		Preferred Subtitles 1 / 2	Selects the first and second preferred language for DVB subtitles (depending on the broadcaster)	
		Preferred Teletext	Selects the preferred language for DVB teletext service (depending on the broadcaster)	
	Display Settings	Preferred Subtitle Type	Selects the preferred subtitle type (Standard / Hard of Hearing) ● “Hard of Hearing” provides aids in understanding and enjoyment with DVB subtitles (depending on the broadcaster). ● “Preferred Subtitles 1 / 2” in “Language” are given priority.	
		Teletext	Teletext display mode (TOP (FLOF) / List)	
		Teletext Character Set	Selects teletext language (West / East1 / East2) ● West: English, French, German, Greek, Italian, Spanish, Swedish, Turkish, etc. ● East1: Czech, English, Estonian, Lettish, Rumanian, Russian, Ukrainian, etc. ● East2: Czech, Hungarian, Lettish, Polish, Rumanian, etc.	
		Side Panel	Increases the brightness of the side panel (Off / Low / Mid / High) ● The recommended setting is “High” to prevent panel “image retention”.	
		Input Labels	Labels or skips each input terminal	
		Banner Display Timeout	Sets how long the Information banner stays on screen (0 (No display) / 1 / 2 / 3 / 4 / 5 / 6 / 7 / 8 / 9 / 10 seconds)	
		Playing Time Display	Set to “On” to display a continuous record of time spent using Game mode (Off / On) ● This function is available when “Game” is selected in “Viewing Mode” (p. 16).	
	System Menu	Common Interface	Uses include to watch pay-TV	
		Shipping Condition	Resets all settings, for example, when moving house	
		System Update	Downloads new software to TV	
		Software Licence	Displays the software licence information	
		System Information	Displays the system information of this TV	
	Other Settings	AV Colour System	Selects optional colour system based on video signals in AV mode (Auto / PAL / SECAM / M.NTSC / NTSC)	
		GUIDE Plus+ Settings	Update	Performs the update of the GUIDE Plus+ schedule and advertising informations for the GUIDE Plus+ system
			Postcode	Sets your postcode to display advertisements in the GUIDE Plus+ system
			System Information	Displays the system information of the GUIDE Plus+ system
Power Save		Reduces brightness of picture to economise on power consumption (Off / On)		
Picture Overscan		Selects the screen area displaying the image (Off / On) On : Enlarged the image to hide the edge of the image. Off : Displayed the image in the original size. ● Set to “On” if noise is generated on the edge of the screen. ● This function is available when aspect is set to Auto (16:9 signal only) or 16:9. ● This function can be memorized separately for SD (Standard definition) and HD (High definition) signals.		
Time Zone		Adjusts the time data ● The time data will be corrected based on GMT. ● Set to “Auto” to adjust the time automatically according to your area.		
Refresh Rate	Changes the image processing of the panel (depending on the input signal) (50Hz / 100Hz) ● Set to “100Hz” normally			

- A different menu will be displayed while SD Card is used.
- Only available items can be selected.

Information for Users on Collection and Disposal of Old Equipment and used Batteries



These symbols on the products, packaging, and/or accompanying documents mean that used electrical and electronic products and batteries should not be mixed with general household waste. For proper treatment, recovery and recycling of old products and used batteries, please take them to applicable collection points, in accordance with your national legislation and the Directives 2002/96/EC and 2006/66/EC.

By disposing of these products and batteries correctly, you will help to save valuable resources and prevent any potential negative effects on human health and the environment which could otherwise arise from inappropriate waste handling.

For more information about collection and recycling of old products and batteries, please contact your local municipality, your waste disposal service or the point of sale where you purchased the items.

Penalties may be applicable for incorrect disposal of this waste, in accordance with national legislation.

For business users in the European Union

If you wish to discard electrical and electronic equipment, please contact your dealer or supplier for further information.

[Information on Disposal in other Countries outside the European Union]

These symbols are only valid in the European Union. If you wish to discard these items, please contact your local authorities or dealer and ask for the correct method of disposal.

Note for the battery symbol (bottom two symbol examples):

This symbol might be used in combination with a chemical symbol. In this case it complies with the requirement set by the Directive for the chemical involved.



Cd

	TX-P37C10Y TX-P37C10YS	TX-P42C10Y TX-P42C10YS	TX-P50C10Y
Power Source	AC 220-240 V, 50 / 60 Hz		
Power Consumption	230 W	245 W	350 W
Power Consumption in Standby mode	0.7 W (Without monitor out recording) 15 W (With monitor out recording)		0.5 W (Without monitor out recording) 15 W (With monitor out recording)

- This equipment complies with the EMC standards listed below.
EN55013, EN61000-3-2, EN61000-3-3, EN55020.

Customer's Record

The model number and serial number of this product may be found on its rear panel. You should note this serial number in the space provided below and retain this book, plus your purchase receipt, as a permanent record of your purchase to aid in identification in the event of theft or loss, and for Warranty Service purposes.

Model Number _____

Serial Number _____

Panasonic Corporation

Web Site : <http://www.panasonic.net>

© Panasonic Corporation 2009

Printed in Czech Republic