

# SAMSUNG

# FULL MANUAL

---

## MX-T70

Imagine the possibilities

Thank you for purchasing this Samsung product.









To receive more complete service, please register  
your product at [www.samsung.com/register](http://www.samsung.com/register)

# SAFETY INFORMATION

## SAFETY WARNINGS

TO REDUCE THE RISK OF ELECTRIC SHOCK, DO NOT REMOVE THE COVER (OR BACK). NO USER-SERVICEABLE PARTS ARE INSIDE. REFER SERVICING TO QUALIFIED SERVICE PERSONNEL.

Refer to the table below for an explanation of symbols which may be on your Samsung product.

	<p style="text-align: center;"><b>CAUTION</b> <b>RISK OF ELECTRIC SHOCK.</b> <b>DO NOT OPEN.</b></p>	
	<p>This symbol indicates that high voltage is present inside. It is dangerous to make any kind of contact with any internal part of this product.</p>	
	<p>This symbol indicates that this product comes with important literature concerning operation and maintenance.</p>	
	<p>Class II product : This symbol indicates that a safety connection to electrical earth (ground) is not required. If this symbol is not present on a product with a power cord, the product MUST have a reliable connection to protective earth (ground).</p>	
	<p>AC voltage : Rated voltage marked with this symbol is AC voltage.</p>	
	<p>DC voltage : Rated voltage marked with this symbol is DC voltage.</p>	
	<p>Caution. Consult Instructions for use : This symbol instructs the user to consult the user manual for further safety related information.</p>	

## WARNING

- To reduce the risk of fire or electric shock, do not expose this appliance to rain or moisture.
- This product contains chemicals known to the State of California to cause cancer and birth defects or other reproductive harm.

## CAUTION

- Do not expose this apparatus to dripping or splashing. Do not put objects filled with liquids, such as vases, on the apparatus.
- To turn this apparatus off completely, you must pull the power plug out of the wall socket. Consequently, the power plug must be easily and readily accessible at all times.

## FCC NOTE (for U.S.A):

### FCC Supplier's Declaration of Conformity

#### Responsible Party - U.S. Contact Information:

Samsung Electronics America, Inc.  
85 Challenger Road.  
Ridgefield Park, NJ 07660  
Phone: 1-800-SAMSUNG (726-7864)

#### FCC Compliance Statement :

This device complies with Part 15 of the FCC Rules. Operation is subject to the following two conditions:  
(1) This device may not cause harmful interference, and (2) this device must accept any interference received, including interference that may cause undesired operation.

### **FCC Caution :**

- Any changes or modifications not expressly approved by the party responsible for compliance could void the user's authority to operate this equipment.
- This product satisfies FCC regulations when shielded cables and connectors are used to connect the unit to other equipment. To prevent electromagnetic interference with electric appliances, such as radios and televisions, use shielded cables and connectors for connections.

### **Class B FCC Statement**

This equipment has been tested and found to comply with the limits for a Class B digital device, pursuant to Part 15 of the FCC Rules. These limits are designed to provide reasonable protection against harmful interference in a residential installation. This equipment generates, uses and can radiate radio frequency energy and, if not installed and used in accordance with the instructions, may cause harmful interference to radio communications. However, there is no guarantee that interference will not occur in a particular installation. If this equipment does cause harmful interference to radio or television reception, which can be determined by turning the equipment off and on, the user is encouraged to try to correct the interference by one of the following measures:

- Reorienting or relocating the receiving antenna.
- Increasing the separation between the equipment and receiver.
- Connecting the equipment to an outlet that is on a different circuit than the radio or TV.
- Consulting the dealer or an experienced radio/TV technician for help.

### **FCC Radiation Exposure Statement :**

This equipment complies with FCC radiation exposure limits set forth for an uncontrolled environment. This equipment should be installed and operated so there is at least 8 inches (20 cm) between the radiator and your body. This device and its antenna(s) must not be co-located or operated in conjunction with any other antenna or transmitter.

### **CALIFORNIA USA ONLY (Applicable for networking models only.)**

This Perchlorate warning applies only to primary CR(Manganese Dioxide) Lithium coin cells in the product sold or distributed ONLY in California USA "Perchlorate Material - special handling may apply, See [www.dtsc.ca.gov/hazardouswaste/perchlorate](http://www.dtsc.ca.gov/hazardouswaste/perchlorate)."

Dispose unwanted electronics through an approved recycler. To find the nearest recycling location, go to our website:[www.samsung.com/recycling](http://www.samsung.com/recycling) Or call, 1-800-SAMSUNG

 **WARNING: Cancer and Reproductive Harm**  
- [www.P65Warnings.ca.gov](http://www.P65Warnings.ca.gov).

### **Important Safety Instructions**

Read these operating instructions carefully before using the unit. Follow all the safety instructions listed below. Keep these operating instructions handy for future reference.

1. Read these instructions.
2. Keep these Instructions.
3. Heed all warnings.
4. Follow all instructions.
5. Do not use this apparatus near water.
6. Clean only with dry cloth.
7. Do not block any ventilation openings. Install in accordance with the manufacturer's instructions.

8. Do not install near any heat sources such as radiators, heat registers, stoves, or other apparatus (including amplifiers) that produce heat.
9. Do not defeat the safety purpose of the polarized or grounding-type plug. A polarized plug has two blades with one wider than the other. A grounding type plug has two blades and a third grounding prong. The wide blade or the third prong are provided for your safety. If the provided plug does not fit into your outlet, consult an electrician for replacement of the obsolete outlet.
10. Protect the power cord from being walked on or pinched particularly at plugs, convenience receptacles, and the point where they exit from the apparatus.
11. Only use attachments/accessories specified by the manufacturer.
12. Use only with the cart, stand, tripod, bracket, or table specified by the manufacturer, or sold with the apparatus.  
When a cart is used, use caution when moving the cart/apparatus combination to avoid injury from tip-over.
13. Unplug this apparatus during lightning storms or when unused for long periods of time.
14. Refer all servicing to qualified service personnel. Servicing is required when the apparatus has been damaged in any way, such as power-supply cord or plug is damaged, liquid has been spilled or objects have fallen into the apparatus, the apparatus has been exposed to rain or moisture, does not operate normally, or has been dropped.



## PRECAUTIONS

1. Ensure that the AC power supply in your house complies with the power requirements listed on the identification sticker located on the rear of your product. Install your product horizontally, on a suitable base (furniture), with enough space around it for ventilation (3~4 inches). Make sure the ventilation slots are not covered. Do not place the unit on amplifiers or other equipment which may become hot. This unit is designed for continuous use. To fully turn off the unit, disconnect the AC plug from the wall outlet. Unplug the unit if you intend to leave it unused for a long period of time.
2. During thunderstorms, disconnect the AC plug from the wall outlet. Voltage peaks due to lightning could damage the unit.
3. Do not expose the unit to direct sunlight or other heat sources. This could lead to overheating and cause the unit to malfunction.
4. Protect the product from moisture (i.e. vases), and excess heat (e.g. a fireplace) or equipment creating strong magnetic or electric fields. Unplug the power cable from the AC wall socket if the unit malfunctions. Your product is not intended for industrial use. It is for personal use only. Condensation may occur if your product has been stored in cold temperatures. If transporting the unit during the winter, wait approximately 2 hours until the unit has reached room temperature before using.
5. The battery used with this product contains chemicals that are harmful to the environment. Do not dispose of the battery in the general household trash. Do not expose the battery to excess heat, direct sunlight, or fire. Do not short circuit, disassemble, or overheat the battery. Danger of explosion if the battery is replaced incorrectly. Replace only with the same or equivalent type.

# ABOUT THIS MANUAL

The user manual has two parts: this simple paper USER MANUAL and a detailed FULL MANUAL you can download.



## **USER MANUAL**

See this manual for safety instructions, product installation, components, connections, and product specifications.



## **FULL MANUAL**

You can access the FULL MANUAL on Samsung's on-line customer support center by scanning the QR code on the left. To see the manual on your PC or mobile device, download the manual in document format from Samsung's website. (<https://www.samsung.com/us/support/downloads/>)

Design and specifications are subject to change without prior notice.  
Sound Tower is a new name for Giga Party Audio.

# CONTENTS

<b>01</b>	<b>Checking the Components</b>	<b>2</b>
	Inserting Batteries before using the Remote Control (AAA batteries X 2)	2
<b>02</b>	<b>Product Overview</b>	<b>3</b>
	Top Panel of the Sound Tower	3
	Rear Panel of the Sound Tower	4
<b>03</b>	<b>Connecting the Sound Tower</b>	<b>6</b>
	Connecting Electrical Power	6
	How to use Audio Group	7
<b>04</b>	<b>Connecting an External Device</b>	<b>13</b>
	Connecting using an Analog Audio (AUX) Cable	13
	Connecting a mobile device via Bluetooth	14
	Connecting the Samsung TV via Bluetooth	17
<b>05</b>	<b>Connecting a USB Storage Device</b>	<b>18</b>
	Software Update	19
<b>06</b>	<b>Using the Remote Control</b>	<b>20</b>
	How to Use the Remote Control	20
	How to use Sound Mode	22
	How to use the DJ Effect	22

<b>07</b>	<b>Using the Samsung Sound Tower (Giga Party Audio) App</b>	<b>23</b>
	Install Samsung Sound Tower (Giga Party Audio) App	23
	Launching the Samsung Sound Tower (Giga Party Audio) App	23
<b>08</b>	<b>Troubleshooting</b>	<b>24</b>
<b>09</b>	<b>License</b>	<b>25</b>
<b>10</b>	<b>Open Source License Notice</b>	<b>25</b>
<b>11</b>	<b>Important Notes About Service</b>	<b>25</b>
<b>12</b>	<b>Specifications and Guide</b>	<b>26</b>
	Specifications	26

# 01 CHECKING THE COMPONENTS



Sound Tower Main Unit

Remote Control (AH81-11472A) /  
Batteries

Power Cord  
(AH81-11474A)

- For more information about the power supply and power consumption, refer to the label attached to the product. (Label: Rear of the Sound Tower Main Unit)
- To purchase additional components or optional cables, contact a Samsung Service Center or Samsung Customer Care.
- When moving the product, do not drag or pull the product from the ground. Lift the product when moving the product.

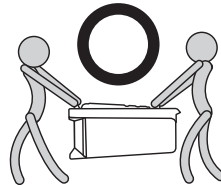
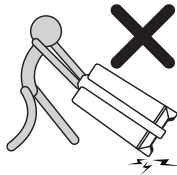

## Inserting Batteries before using the Remote Control (AAA batteries X 2)

Slide the battery cover in the direction of the arrow until it is completely removed. Insert 2 AAA batteries (1.5V) oriented so that their polarity is correct. Slide the battery cover back into position.

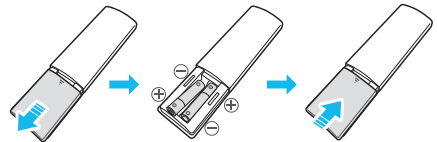





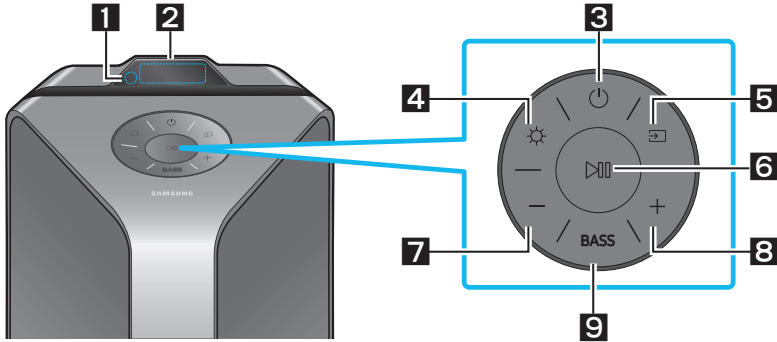

# 02 PRODUCT OVERVIEW

## Top Panel of the Sound Tower



1	<b>Remote Sensor</b>	When operating the Sound Tower system, please aim the front of the remote control at the remote sensor.
2	<b>Display Window</b>	Displays operating messages or current status of the Sound Tower system.
3	<b>Power</b>	Turns the Sound Tower on and off.
4	<b>Light</b>	Press the  ( <b>Light</b> ) button to turn the Lighting Mode on. Press the button repeatedly to cycle through the available lighting modes: <b>AMBIENT, PARTY, DANCE, THUNDERBOLT, STAR</b> or <b>OFF</b> .
5	<b>Source</b>	Press to select a source connected to the Sound Tower. Press and hold the  ( <b>Source</b> ) button for more than 5 seconds to enter the "SEARCHING TV" mode.
6	<b>Play/Pause</b>	<ul style="list-style-type: none"> <li>• <b>Play/Pause</b> Press the  button to pause a music file temporarily. When you press the button again, the music file plays.</li> <li>• <b>Demo play</b> Press and hold the  button for more than 5 seconds to start the Demo play while the system is turned on. "DEMO" appears on the display and it plays demo music for 60 seconds. To cancel Demo Play, press and hold the  button for more than 5 seconds during Demo Play. <ul style="list-style-type: none"> <li>- If you input any commands while in demo play, 60 seconds timer is refreshed.</li> <li>- All the buttons on the remote control and rear panel are disabled while in demo play. If you want to use the remote control, cancel the demo play.</li> <li>- Demo play is canceled when you change the source or power off the system.</li> <li>- Please be careful as it may play louder than the set volume.</li> </ul> </li> </ul>

<b>7</b>	<b>Volume down</b>	Press the — ( <b>Volume down</b> ) button to lower the volume. Press and hold the — ( <b>Volume down</b> ) button to quickly lower the volume.
<b>8</b>	<b>Volume up</b>	Press the + ( <b>Volume up</b> ) button to raise the volume. Press and hold the + ( <b>Volume up</b> ) button to quickly raise the volume.
<b>9</b>	<b>BASS</b>	Press the <b>BASS</b> button to use the powerful bass sound. Press it again to return to the normal sound. Press and hold the <b>BASS</b> button for more than 5 seconds to turn on or off the <b>BLUETOOTH POWER</b> function.

## Rear Panel of the Sound Tower

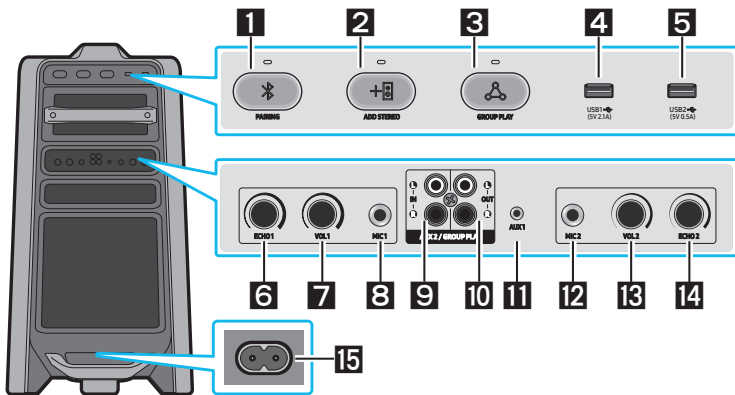

<b>1</b>	<b>Bluetooth PAIRING</b>	Press the <b>PAIRING</b> button to enter the “ <b>BT PAIRING</b> ” mode. You can connect the Sound Tower to a new Bluetooth device in this mode by selecting the Sound Tower from the Bluetooth device's search list.
<b>2</b>	<b>ADD STEREO</b>	Press the <b>ADD STEREO</b> button to connect to another Sound Tower wirelessly. Press the <b>ADD STEREO</b> button again before connecting another Sound Tower to exit Stereo Group mode. When the connection is made, you can enjoy stereo sound. Press and hold the <b>ADD STEREO</b> button for more than 5 seconds to disconnect the Stereo Group mode.
<b>3</b>	<b>GROUP PLAY</b>	Press the <b>GROUP PLAY</b> button to connect up to ten Sound Tower systems wirelessly. Press the <b>GROUP PLAY</b> button again before connecting other Sound Tower to exit wireless Group Play. When the connection is made, you can use multiple Sound Tower systems at the same time using Group Play mode. Press and hold the <b>GROUP PLAY</b> button for more than 5 seconds to disconnect the wireless Group Play mode.
<b>4</b>	<b>USB1</b>	Connect a USB device to the <b>USB1</b> or <b>USB2</b> ports on the main unit. If you connect your cell phone to the <b>USB1</b> port, you can charge it.
<b>5</b>	<b>USB2</b>	<ul style="list-style-type: none"> <li>Press the <b>Source</b> button to select <b>USB1</b> or <b>USB2</b>.</li> </ul>

<b>6</b>	<b>ECHO1</b>	You can give an echo effect to the sound from a connected microphone ( <b>MIC1</b> ) by adjusting the <b>ECHO1</b> knob. If you turn clockwise, the echo effect goes up, and if you turn counter-clockwise, the echo effect goes down.
<b>7</b>	<b>VOL1</b>	Use the <b>VOL1</b> knob to adjust the volume of a connected microphone ( <b>MIC1</b> ). If you turn clockwise, the volume goes up, and if you turn counter-clockwise, the volume goes down.
<b>8</b>	<b>MIC1</b>	Connect your microphone to the <b>MIC1</b> jack.
<b>9</b>	<b>AUX2/ GROUP PLAY IN Terminals</b>	Use an Audio Cable (not supplied) to connect <b>AUX2 (IN)</b> terminals on the main unit to Audio Out on an external analog output device. <ul style="list-style-type: none"> <li>• Be sure to match connector colors.</li> <li>• If the external analog output device has only one Audio Out jack, connect either left or right.</li> <li>• Press the  (<b>Source</b>) button to select <b>AUX2</b>.</li> <li>• If the product is in <b>AUX2</b> mode with no playback and no command input for more than 20 minutes, the system will turn off.</li> <li>• If the product is in <b>AUX2</b> mode with playback for more than 8 hours and no command input, the system will turn off.</li> </ul>
<b>10</b>	<b>GROUP PLAY OUT Terminals</b>	Use an Audio Cable (not supplied) to connect <b>GROUP PLAY (OUT)</b> terminals on the main unit to Audio In on an external analog output device. <ul style="list-style-type: none"> <li>• Be sure to match connector colors.</li> <li>• If the external analog output device has only one Audio In jack, connect either left or right.</li> </ul>
<b>11</b>	<b>AUX1</b>	Use an Audio (AUX) Cable (not supplied) to connect <b>AUX1</b> jack on the main unit to Audio Out on an external device. <ul style="list-style-type: none"> <li>• If the product is in <b>AUX1</b> mode with no playback and no command input for more than 20 minutes, the system will turn off.</li> <li>• If the product is in <b>AUX1</b> mode with playback for more than 8 hours and no command input, the system will turn off.</li> </ul>
<b>12</b>	<b>MIC2</b>	Connect your microphone to the <b>MIC2</b> jack.
<b>13</b>	<b>VOL2</b>	Use the <b>VOL2</b> knob on the main unit to adjust the volume of a connected microphone ( <b>MIC2</b> ). If you turn clockwise, the volume goes up, and if you turn counter-clockwise, the volume goes down.
<b>14</b>	<b>ECHO2</b>	You can give an echo effect to the sound from a connected microphone ( <b>MIC2</b> ) by adjusting the <b>ECHO2</b> knob. If you turn clockwise, the echo effect goes up, and if you turn counter-clockwise, the echo effect goes down.
<b>15</b>	<b>Power</b>	Connect the power cord to the <b>Power</b> jack and connect the other end of the power cord to a wall socket to supply electrical power to the Sound Tower.

# 03 CONNECTING THE SOUND TOWER

## Connecting Electrical Power

Use the power cord to connect the Sound Tower to an electrical outlet in the following order: Connect the power cord to the Sound Tower and then to a wall socket.

See the illustrations below.

- For more information about the required electrical power and power consumption, refer to the label attached to the product. (Label: Rear of the Sound Tower)

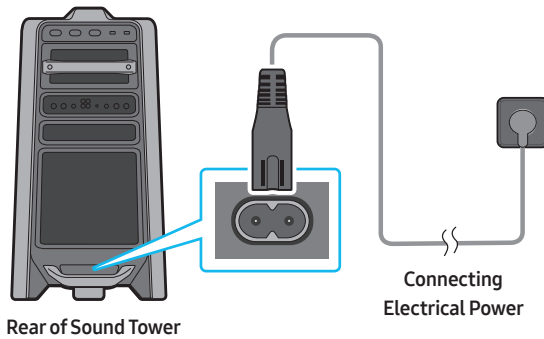

# How to use Audio Group

You can connect multiple audio systems in a group to create a party environment and produce higher sound output. Set one Sound Tower as the HOST and any music played on it will be shared among any other Sound Tower systems in the Audio group.

## Connecting the wired Group Play mode

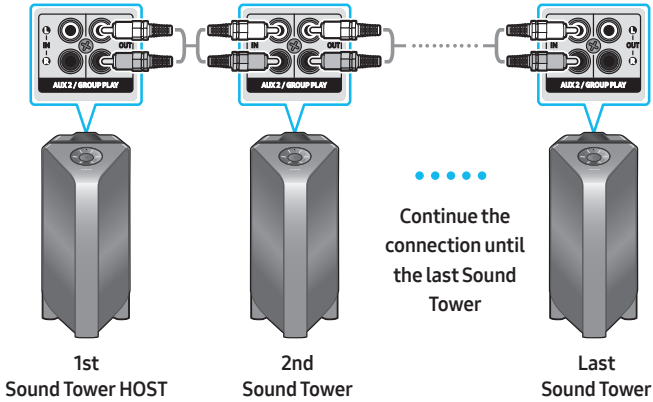

Set up Group Play by connecting all the systems using audio cables (not supplied). Use the **AUX** or  (**Source**) button to change the source to **AUX2** for every Sound Tower system except the 1st (or HOST) Sound Tower system.

### NOTES

- The 1st Sound Tower HOST can play music from any source.
- Depending on the length or characteristics of the cable, there may be a difference in operating distance.

## Connecting the wireless Group Play mode

You can connect up to ten Sound Tower systems with the wireless Group Play function.

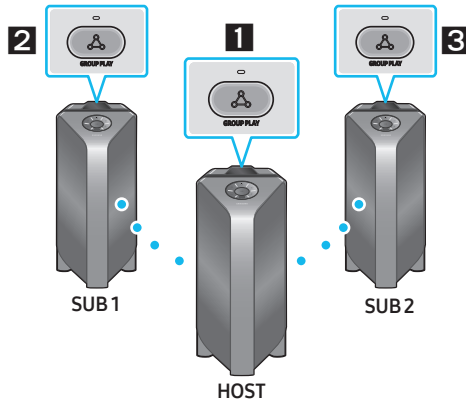

1. Press the **GROUP PLAY** button on the HOST Sound Tower system. The “**HOST**” message appears on the display of the HOST Sound Tower and the LED blinks on the **GROUP PLAY** button.
2. Press the **GROUP PLAY** button on the 2nd Sound Tower system (SUB 1). The “**GROUP PLAY CONNECTED**” message appears on the display and the **GROUP PLAY** button on both systems stops blinking.
3. Press the **GROUP PLAY** button on the 3rd Sound Tower system (SUB 2). The “**GROUP PLAY CONNECTED**” message appears on the display and the **GROUP PLAY** button on the system stops blinking.
4. If you want to add more Sound Tower systems, repeat step 3.
5. Play music on the HOST Sound Tower. Sound outputs from all the connected systems.

### NOTES

- If Sound Tower is connected with Samsung TV, Wireless Group Play is not available.
- The wireless Group Play connection is available for any Sound Tower system.
- Environmental conditions or other factors with connected devices may have effect on playback quality.
- If the red LED is on the **GROUP PLAY** button, an error has occurred in the wireless Group Play connection. Try step 1 to step 5 again.
- The **ADD STEREO** button and **PAIRING** button on the SUB Sound Tower systems are not available while in wireless Group Play mode.
- The **ADD STEREO** button on the HOST Sound Tower system is not available while in wireless Group Play mode.
- When adding a SUB unit, if you press and hold **GROUP PLAY** on the SUB, before the “**GROUP PLAY CONNECTED**” message appears, it will become the HOST unit instead.

- All SUB units must be connected one by one. For example, after HOST is connected, press **GROUP PLAY** button on SUB 1 to connect, and after SUB 1 is connected, you should connect SUB 2 and SUB 3 one by one sequentially.
- While using Group Play, currently connected Bluetooth devices are disconnected and Bluetooth connection is disabled.
- Bluetooth devices can search and connect with the HOST Sound Tower only.
- When in Group Play mode, the SUBs cannot connect to a Bluetooth device.
- If you power off and then power on the Sound Tower or select any source other than **BT** on a SUB unit, in Group Play mode, the Group Play mode is disconnected.
- This product does not support aptX audio stream with Wireless Group Play mode.

### Disconnecting the wireless Group Play mode

1. Press and hold the **GROUP PLAY** button over 5 seconds (HOST or SUBs) after Group Play is connected or press the **GROUP PLAY** button (HOST or SUBs) before Group Play is connected.
  - “**OFF-GROUP PLAY**” appears on the display and the LED above the **GROUP PLAY** button is off.
2. If you select any source other than **BT** on the SUB units or turn off the HOST Sound Tower, the Group Play mode is disconnected.
  - If the disconnection is made from the HOST Sound Tower, Group Play is disconnected.

### LED Indications

LED	STATE	Description
Green	Blink	Waiting for a wireless Group Play connection.
	Solid	The wireless Group Play connection was successful.
Red	Solid	There is an error with the wireless Group Play connection.

### NOTE

- In wireless connection, Playback quality can be unstable depending on Bluetooth environment. For better play, please keep the device in wired Group Play mode.

## Using a Smartphone and Stereo Group mode

Connect two Sound Towers and use them with your smartphone to enjoy stereo sound.

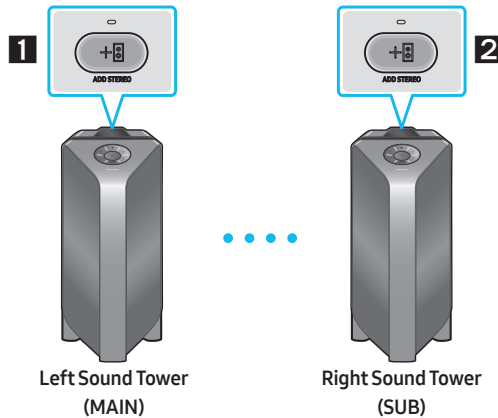

1. Press the **ADD STEREO** button on the left Sound Tower system. The “**SEARCHING STEREO**” message appears on the display and the LED blinks on the **ADD STEREO** button.
2. Press the **ADD STEREO** button on the right Sound Tower system. The “**SEARCHING STEREO**” message appears on the display and the LED blinks on the **ADD STEREO** button.
3. When the connection is made, The “**LEFT**” message appears on the MAIN Sound Tower system and “**RIGHT**” appears on the SUB Sound Tower system.
  - The MAIN Sound Tower system outputs left channel sound and the SUB Sound Tower system outputs right channel sound. Press the **ADD STEREO** button on the MAIN or SUB Sound Tower to change the sound channel of the Sound Tower.
4. Play music by connecting your smartphone to the MAIN Sound Tower and Bluetooth. Sound is output from both Sound Towers.

### NOTES

- To use the Stereo Group mode, both Sound Tower systems must be the same model.
- Environmental conditions or other factors with connected devices may have effect on playback quality.
- If the red LED is on the **ADD STEREO**, an error has occurred in the Stereo Group connection. Try step 1 and step 3 again.
- Remote Controller, **BT PAIRING**, **GROUP PLAY** and  (**Source**) buttons on the SUB Sound Tower systems are disabled while in Stereo Group mode.
- The **GROUP PLAY** button on the MAIN Sound Tower system is not available while in Stereo Group mode.



- In mode other than “BT” (ex. **USB, AUX** mode), music is played only in MAIN Sound Tower and music is not played in SUB Sound Tower.
- The lighting colors between MAIN Sound Tower and SUB Sound Tower may vary.
- The Bluetooth device has the same name as MAIN Sound Tower and SUB Sound Tower when connected to the Bluetooth device, and only the MAIN Sound Tower can be connected.
- This product does not support aptX audio stream with Stereo Group mode.
- If you try to connect a Bluetooth device while Stereo Group is connecting, the Stereo Group mode may fail.

### Terminate the Stereo Group mode

Press the **ADD STEREO** button (MAIN or SUB) for at least 5 seconds after the Stereo Group is connected.

- “**OFF-STEREO MODE**” appears on the display and the LED above the **ADD STEREO** button is off.

### LED Indications

LED	STATE	Description
Green	Blink	Waiting for a Stereo Group connection.
	Solid	The Stereo Group connection is successful.
Red	Solid	There is an error with the Stereo Group connection.

### Using Samsung TV and Stereo Group mode

Connect two Sound Towers by wire and use them with Samsung TV to enjoy stereo sound.

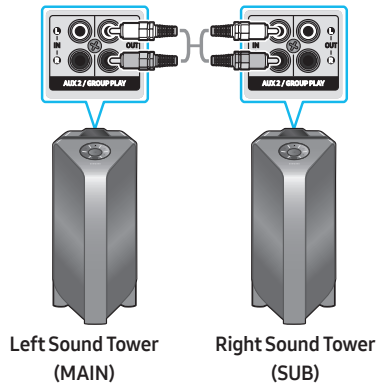

1. Refer to “**Using a Smartphone and Stereo Group mode**” to connect the two Sound Towers in a Stereo Group.

2. Connect the RCA cable to the **AUX2 OUT** on the MAIN and **AUX2 IN** on the SUB as shown by using the RCA cable (not supplied).
3. In "**BT**" mode, press the "**AUX**" button on the MAIN Sound Tower remote control for at least 5 seconds. "**SEARCHING TV STEREO**" appears on the display.
4. When the connection is complete, "**TV STEREO MODE**" appears in the display and then the current output **CHANNEL** is displayed.
5. When the connection is complete, a "**SEARCHING TV**" message appears in the MAIN Sound Tower display and a "**SUB**" appears in the SUB Sound Tower display.
  - The MAIN Sound Tower outputs the left channel sound and the SUB Sound Tower outputs the right channel sound. Press the **ADD STEREO** button on the MAIN or SUB Sound Tower to change the sound channel of the Sound Tower.
6. Connect a TV and MAIN Sound Tower via Bluetooth to play music. Sound is output from both Sound Towers.

## NOTES

- To use Stereo Group mode, both Sound Towers must be the same model.
- A red light on the LED on the **ADD STEREO** button indicates an error in the Stereo Group connection. Try Step 1 to 5 again.
- In Stereo Group mode, the remote control, **BT PAIRING**, **GROUP PLAY**, and  (**Source**) buttons on the SUB Sound Tower are disabled.
- The **GROUP PLAY** button on the MAIN Sound Tower is not available in Stereo Group mode.
- If Samsung TV supports a simple connection, the connection pop-up is automatically displayed on the TV, and if you select "**Yes**", it connects to the TV. If there is a previous connection history between Samsung TV and Sound Tower, it will be connected to Samsung TV without pop-up. For a simple connection to Samsung TV, refer to page 17.
- The lighting colors may vary between the MAIN Sound Tower and the SUB Sound Tower.
- When connecting to a TV, the names of the MAIN and SUB Sound Tower are the same in the Bluetooth list on the TV, and only the MAIN Sound Tower can be connected.

## Terminating the Stereo Group mode connection

Press the **ADD STEREO** button (MAIN or SUB) for at least 5 seconds after the Stereo Group is connected.

- "**OFF-STEREO MODE**" appears in the display and the LED on the **ADD STEREO** button turns off.

# 04 CONNECTING AN EXTERNAL DEVICE

Connect to an external device via a wired or wireless network to play the external device's sound through the Sound Tower.

## Connecting using an Analog Audio (AUX) Cable

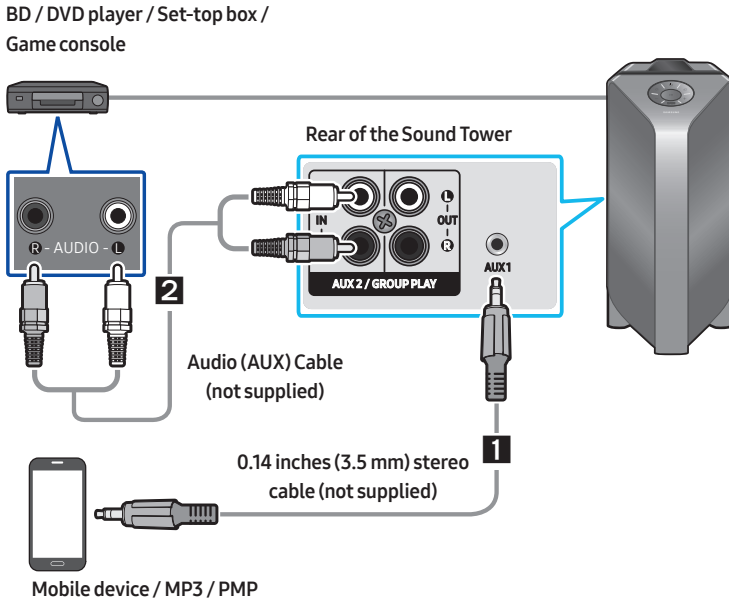

### 1 0.14 inches (3.5 mm) stereo Cable (AUX1)

1. Connect **AUX1** jack on the main unit to the AUDIO OUT jack of the Source Device using an 0.14 inches (3.5 mm) stereo cable .
2. Select “**AUX1**” mode by pressing the  (**Source**) button on the top panel or on the remote control.
  - You can also select a source using **AUX** button on the remote control.

### 2 Audio Cable (AUX2)

1. Connect **AUX2 (IN)** terminals on the main unit to the AUDIO OUT terminals of the Source Device using an audio cable .
2. Select “**AUX2**” mode by pressing the  (**Source**) button on the top panel or on the remote control.
  - You can also select a source using **AUX** button on the remote control.

# Connecting a mobile device via Bluetooth

When a mobile device is connected using Bluetooth, you can hear stereo sound without the hassle of cabling.

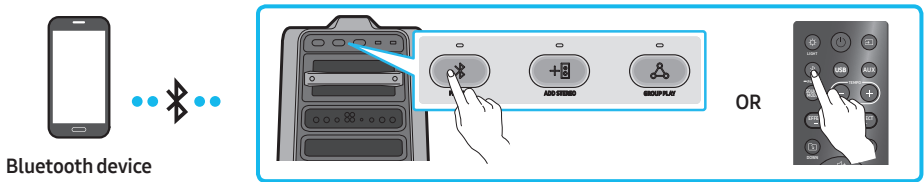

## The initial connection

1. Press and hold the **PAIRING** button on the remote control for more than 5 seconds to enter the “**BT PAIRING**” mode.
- (OR) Press the **PAIRING** button on the rear panel.
2. On your device, select “[AV] MX-T70” from the list that appears.
  - When the Sound Tower is connected to the Bluetooth device, [Bluetooth Device Name] → “BT” appears in the front display.
3. Play music files from the device connected via Bluetooth through the Sound Tower.

## If the device fails to connect

- If a previously connected Sound Tower listing (e.g. “[AV] MX-T70”) appears in the list, delete it.
- Then repeat steps 1 and 2.

## What is the difference between BT READY and BT PAIRING?

- **BT READY** : In this mode, you can search for previously connected TVs or connect a previously connected mobile device to the Sound Tower.
- **BT PAIRING** : In this mode, you can connect a new device to the Sound Tower.  
(Press and hold the **PAIRING** button on the remote control for more than 5 seconds or press the **PAIRING** button on the rear of the Sound Tower to enter the “**BT PAIRING**” mode.)

## **Bluetooth Multi connection**

Sound Tower supports up-to two simultaneous Bluetooth device connections. Sound Tower can play music through one of the connected Bluetooth devices without disconnecting the second device.

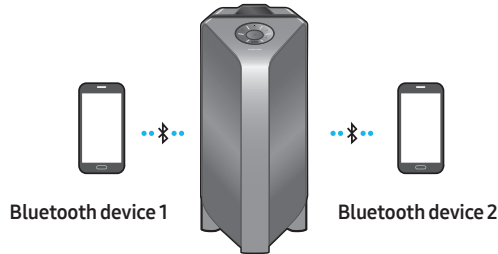

1. Connect Sound Tower to the first device and the second device respectively for the first time. (See page 14)
2. Music can be played on only one of the two connected devices, and when the music is played on the other device, the music on the playing device is paused.

### **NOTES**

- If you want to connect Sound Tower to a third device, you can disconnect Sound Tower from one of the two currently connected devices and then connect Sound Tower to the third device.
- With the Sound Tower and two devices currently connected, when pairing to a new Bluetooth device, the devices currently connected may be disconnected.
- You can connect to two Bluetooth devices at the same time.
- If asked for a PIN code when connecting a Bluetooth device, enter <0000>.
- Environmental conditions or other factors with connected devices may have effect on playback quality.
- The Sound Tower automatically turns off after 20 minutes with no command input in the ready state.
- The Sound Tower may not perform Bluetooth search or connection correctly under the following circumstances:
  - If there is a strong electrical field around the Sound Tower.
  - If several Bluetooth devices are simultaneously paired with the Sound Tower.
  - If the Bluetooth device is turned off, not in place, or malfunctions.
- Electronic devices may cause radio interference. Devices that generate electromagnetic waves must be kept away from the Sound Tower main unit - e.g., microwaves, wireless LAN devices, etc.
- When the Sound Tower is connected to your TV by Bluetooth connection, the video on the TV and audio from the Sound Tower may not be synchronized because the distance between the Sound Tower and the TV is too far. It is recommended to move the Sound Tower closer to your TV within 3.3 ft (1 meter).

- When the speaker is in the Bluetooth Multi connection mode, you will need to connect the other Bluetooth device and speaker within a few minutes (Approx. 1 minute). Otherwise Bluetooth Multi connection mode will be canceled.
- Bluetooth Multi connection may not be supported depending on the connected device's specifications.
- Removable/detachable Bluetooth devices (Ex:Dongle etc..) ,windows phone, laptops, TV, etc. do not support Bluetooth Multi connection.
- After Bluetooth Multi connection pairing, there may be a slight delay before music starts playing depending on the Bluetooth devices.
- If you move too far out of range from the Sound Tower without first disconnecting your Bluetooth device, it may take a few minutes to connect other Bluetooth devices. If you turn the Sound Tower off and back on, you can connect other Bluetooth devices without waiting.

## LED Indications

LED	STATE	Description
Blue	Fast Blink	BT PAIRING mode
	Blink	BT READY mode
	Solid	A Bluetooth device is connected.

## Using Bluetooth Power On

When the Sound Tower is turned off, you can connect your smart device via a Bluetooth connection to turn it on.

1. Press and hold the **BASS** button on the remote control or on the top panel to set the Bluetooth Power On function on. "**ON-BLUETOOTH POWER**" appears on the display.
2. When the Sound Tower is off, connect your smart device via Bluetooth. (For information on Bluetooth connections, refer to your smart device's manual.)
3. When the connection is complete, the Sound Tower turns itself on automatically in Bluetooth mode.
  - Select the desired music to play from your smart device.

## NOTE

- Press and hold the **BASS** button for more than 5 seconds on the remote control or on the top panel to turn the Bluetooth Power On function on or off.

Each time you press the **BASS** button, the Sound Tower displays :

**ON-BLUETOOTH POWER → OFF-BLUETOOTH POWER**

# Connecting the Samsung TV via Bluetooth



If Sound Tower connected with Samsung TV via Bluetooth, Sound Tower can be controlled by TV UI.  
(Volume +/-, Mute On/Off and Power On/Off)

## Easy connect with Samsung TV (SEARCHING TV mode)

Sound Tower has “**SEARCHING TV**” mode for easy connect with Samsung TV.

1. Press and hold  (**Source**) button on remote control or top panel then Sound Tower will start to search Samsung TV. The “**SEARCHING TV**” message appears on the display.  
(Or, when the wired Stereo Group mode connection is complete, the “**SEARCHING TV**” mode is automatically activated.)
2. If Samsung TV support easy connection, connection popup will be displayed on TV.  
If Samsung TV has connected with Sound Tower before, Samsung TV will be connected without popup.
3. If Sound Tower can not find any Samsung TV within 5 minutes, Sound Tower will terminate “**SEARCHING TV**” mode and turn to “**BT PAIRING**” mode. If find any Samsung TV, Sound Tower will request connection to those TV.

## NOTES

- While in wireless Group Play mode, searching TV is not available.
- To stop searching Samsung TV, turn off the Sound Tower or press the  (**Source**) or  **PAIRING** button.
- Sound Tower does not support multi connection if Samsung TV is connected.
- While Samsung TV is connected, Sound mode is **PARTY** and **SOUND MODE** button is not available.
- While Samsung TV is connected, Sound Tower APP can not connect with Sound Tower.
- Connection popup may not be displayed according to TV spec.
- You can select and connect directly from the Bluetooth speaker list on your TV when the connection pop-up does not appear on your TV.

# 05 CONNECTING A USB STORAGE DEVICE

You can play music files located on USB storage devices through the Sound Tower.

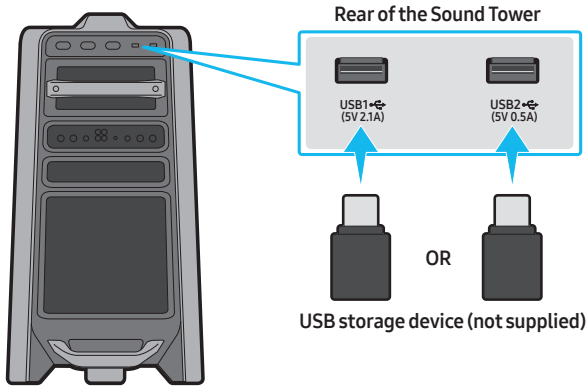

1. Connect a USB storage device to the USB1 or USB2 jacks on your Sound Tower.
2. Press the  (**Source**) button on the top panel or on the remote control, and then select “**USB1**” or “**USB2**”.
  - You can also select a source using **USB** button on the remote control.
3. “**USB1**” or “**USB2**” appears in the display screen.
4. Play music files from the USB storage device through the Sound Tower.
  - The Sound Tower automatically turns off (Auto Power Down) if USB device is not connected, playback stopped, or there is no input for more than 20 minutes.

## NOTES

- This product only supports USB storage devices that are formatted in the FAT and FAT32 file system.
- This product does not support HDD storage or storage on mobile devices.
- A maximum of 999 files can be played per USB storage device.
- A maximum of 256 folders can be read per USB storage device.



## Supported Audio Formats

File Extension	Audio Codec	Sampling Rate	Bit Rate
*.mp3	MPEG 1 Layer3	32 kHz ~ 48 kHz	32 kbps ~ 320 kbps
	MPEG 2 Layer3	16 kHz ~ 24 kHz	8 kbps ~ 160 kbps
	MPEG 2.5 Layer3	8 kHz ~ 12 kHz	8 kbps ~ 160 kbps
*.wma	WMA7/8/9	8 kHz ~ 48 kHz	32 kbps ~ 320 kbps
*.aac	AAC	8 kHz ~ 96 kHz	< 1728 kbps
	AAC-LC	8 kHz ~ 96 kHz	< 1728 kbps
	HE-AAC	8 kHz ~ 96 kHz	< 1728 kbps
*.wav	PCM/LPCM/ IMA_ADPCM	8 kHz ~ 192 kHz	< 5 Mbps
*flac	-	8 kHz ~ 192 kHz	< 5 Mbps

### NOTES

- This product does not support WMA Professional codec.
- The above table shows supported sampling rates and bit rates. Files in formats that are not supported will not play.
- AAC files only support the ADTS native format.

## Software Update







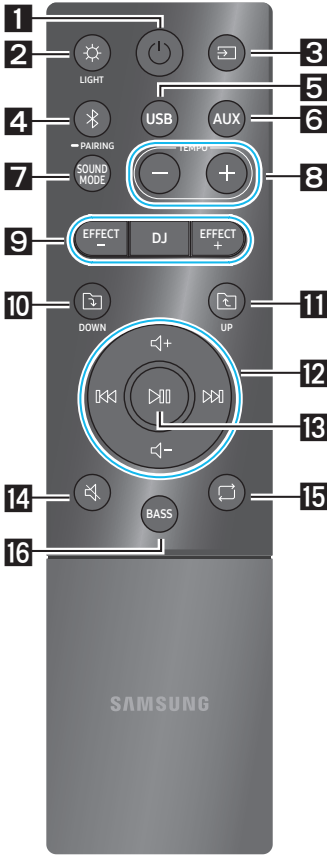

### Samsung may offer updates for the Sound Tower's system firmware in the future.











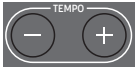





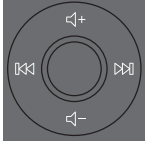



If an update is offered, you can update the firmware by connecting a USB device with the firmware update stored on it to the **USB1** or **USB2** port on your Sound Tower. For more information about how to download update files, go to the Samsung Electronics website at [www.samsung.com/us/support/](http://www.samsung.com/us/support/). Then, enter or select the model number of your Sound Tower, select the Software & Apps option, and then Downloads. Note that the option names can vary.



# 06 USING THE REMOTE CONTROL

## How to Use the Remote Control



<p><b>1</b></p>  <p><b>Power</b></p>	<p>Turn the Sound Tower on and off.</p>
<p><b>2</b></p>  <p><b>LIGHT</b></p>	<p>Press the  (<b>LIGHT</b>) button to turn the Lighting Mode on. Press the button repeatedly to cycle through the available light modes: <b>AMBIENT, PARTY, DANCE, THUNDERBOLT, STAR</b> or <b>OFF</b>.</p>
<p><b>3</b></p>  <p><b>Source</b></p>	<p>Press to select a source connected to the Sound Tower. Press the button repeatedly to cycle through the available sources: <b>BT, USB1, USB2, AUX1</b> or <b>AUX2</b>.</p>
<p><b>4</b></p>  <p><b>Bluetooth PAIRING</b></p>	<p>Press to select a source connected directly to "BT" mode. Press and hold the button for more than 5 seconds to enter the "BT PAIRING" mode. You can connect the Sound Tower to a new Bluetooth device in this mode by selecting the Sound Tower from the Bluetooth device's search list.</p>
<p><b>5</b></p>  <p><b>USB</b></p>	<p>Press to select the <b>USB1</b> or <b>USB2</b> sources connected to the Sound Tower.</p>
<p><b>6</b></p>  <p><b>AUX</b></p>	<p>Press to select the <b>AUX1</b> or <b>AUX2</b> sources connected to the Sound Tower.</p>
<p><b>7</b></p>  <p><b>SOUND MODE</b></p>	<p>Press the button repeatedly to cycle through the available sound effects: <b>PARTY, STANDARD, HIPHOP, EDM, ROCK, LATIN, HOUSE</b> or <b>REGGAE</b>.</p>

<p><b>8</b></p>	 <p>TEMPO +/-</p>	<p>Press the <b>TEMPO +</b> or <b>TEMPO -</b> buttons to change the tempo of the music up or down.</p> <ul style="list-style-type: none"> <li>This function only works in the <b>USB1</b> and <b>USB2</b> mode.</li> </ul>
<p><b>9</b></p>	 <p>DJ</p>	<p>This function lets you turn on the DJ effect function.</p> <p>Press the button repeatedly to cycle through the available DJ sound effects: <b>NOISE, FILTER, CRUSH, CHORUS, WAHWAH</b> or <b>OFF</b>.</p>
<p><b>10</b></p>	 <p>Folder DOWN</p>	<p>Press the  (<b>DOWN</b>) button to move to the next folder in the USB device.</p>
<p><b>11</b></p>	 <p>Folder UP</p>	<p>Press the  (<b>UP</b>) button to move to the previous folder in the USB device.</p>
<p><b>12</b></p>	 <p>Volume up, Volume down / Skip</p>	<ul style="list-style-type: none"> <li><b>Volume up, Volume down</b> Press the + (<b>Volume up</b>) or - (<b>Volume down</b>) to adjust the volume level up or down.</li> <li><b>Music Skip</b> Press the  button to select the next music file. Press the  button to select the previous music file. Press and hold the  button or the  button for more than 3 seconds in USB play mode to search forward or search backward. Press and hold the  button or the  button for more than 3 seconds again to get back to normal play.</li> </ul>
<p><b>13</b></p>	 <p>Play / Pause</p>	<p>Press the  button to pause a music file temporarily. When you press the button again, the music file plays.</p> <ul style="list-style-type: none"> <li><b>Auto Power Down Function</b> To turn off Auto Power Down function while the unit is in <b>AUX1, AUX2</b> mode, press and hold the  button for more than 5 seconds. <b>ON-AUTO POWER DOWN / OFF-AUTO POWER DOWN</b> appears on the display.</li> </ul>
<p><b>14</b></p>	 <p>Mute</p>	<p>Press the  (<b>Mute</b>) button to mute the sound. Press it again to unmute the sound.</p>

15	 <p><b>Repeat</b></p>	<p>Press the  (<b>Repeat</b>) button to use the Repeat function in “<b>USB1</b>” and “<b>USB2</b>” mode. Press the button repeatedly to cycle through the available repeat functions: <b>ONE, FOLDER, ALL, RANDOM</b> or <b>OFF</b>.</p>
16	 <p><b>BASS</b></p>	<p>Press the <b>BASS</b> button to use the powerful bass sound. Press it again to return to the normal sound. Press and hold the <b>BASS</b> button for more than 5 seconds to turn on or off the <b>BLUETOOTH POWER</b> function.</p>

## How to use Sound Mode

Your Sound Tower provides predefined equalizer settings that are optimized for particular music genres.

1. Press the **SOUND MODE** button on the Remote control.
2. Each time you press the **SOUND MODE** button, the Sound Tower cycles through the available sound effects: **PARTY, STANDARD, HIPHOP, EDM, ROCK, LATIN, HOUSE** or **REGGAE**.

### NOTES

- Default sound mode is **PARTY**.
- When turned off, press and hold the  button on product or remote control for more than 5 seconds to turn on in the default Sound Mode setting.

## How to use the DJ Effect

The DJ Effect function lets you add DJ sound effects to your music. The level of each effect is adjustable.

1. Press the **DJ** button on the Remote control.
2. Each time you press the **DJ** button, the Sound Tower cycles through the available DJ Effects:
  - **NOISE**: Create white noise and mixed with the original sound through the filter and output.
  - **FILTER**: Creates an effect similar to the sound of only treble or bass.
  - **CRUSH**: Creates an effect that makes the original sound sharper.
  - **CHORUS**: Creates an effect similar to a singing chorus.
  - **WAHWAH**: Creates a ‘Wah~ Wah~’ effect.
  - **DJ EFFECT OFF**: Turns off the DJ Effect.
3. Press the **EFFECT +** or **EFFECT -** buttons to raise or lower the level of each of the DJ sound effects from -15 to +15.

### NOTE

- When turned off, press and hold the  button on product or remote control for more than 5 seconds to turn on in the default DJ Effect setting.

# 07 USING THE SAMSUNG SOUND TOWER (GIGA PARTY AUDIO) APP

## Install Samsung Sound Tower (Giga Party Audio) App

To control this product with your Smart Device and the Samsung Sound Tower (Giga Party Audio) app, download the Samsung Sound Tower (Giga Party Audio) App from the Google Play Store or Apple App Store, and install it on your Smart Device.

### NOTES

- The Samsung Sound Tower (Giga Party Audio) app is compatible with Android mobile phone devices running Android OS 6.0 or later.
- The Samsung Sound Tower (Giga Party Audio) app is compatible with Apple mobile devices running iOS 10.0 or later.

Market search : Samsung Sound Tower or Samsung Giga Party Audio



## Launching the Samsung Sound Tower (Giga Party Audio) App

To launch and use the Samsung Sound Tower (Giga Party Audio) app, touch the Sound Tower (Giga Party Audio) icon on your smart device, and then follow the directions on the screen.



# 08 TROUBLESHOOTING

Refer to the table below if this product does not function properly. If the problem you are experiencing is not listed below or if the instructions below do not help, turn off the product, disconnect the power cord, and contact Samsung Electronics at 1-800-SAMSUNG (1-800-726-7864).

## The unit will not turn on.

### Is the power cord plugged into the outlet?

→ Connect the power plug to the outlet.

### A function does not work when the button is pressed.

#### Is there static electricity in the air?

→ Disconnect the power plug and connect it again.

### Sound dropouts occur in BT mode.

→ See the Bluetooth connection sections on page 14.

### Sound is not produced.

#### Is the Mute function on?

→ Press the  (Mute) button to cancel the mute function.

#### Is the volume set to minimum?

→ Adjust the Volume.

### The remote control does not work.

#### Are the batteries drained?

→ Replace them with new batteries.

#### Is the distance between the remote control and Sound Tower main unit too far?

→ Move the remote control closer to the Sound Tower main unit.

### Stereo Group connection is not working.

#### Is the system in wireless Group Play mode?

→ Disconnect the wireless Group Play mode and try Stereo Group connection again.

### It cannot make a Bluetooth connection.

#### Is the system connected to another system in wireless Group Play mode or Stereo Group mode?

→ Try Bluetooth connection again after disconnecting the wireless Group Play or Stereo Group connection.

#### Are the two Bluetooth devices already connected?

→ Try Bluetooth connection again after disconnecting other Bluetooth connections.

### The PAIRING button is not working.

#### Is the system in wireless Group Play mode or Stereo Group mode?

→ Try again after disconnecting the wireless Group Play or Stereo Group connection.

### I want to switch the HOST (MAIN) system to the other in wireless Group Play or Stereo Group connection.

→ Disconnect Group Play mode, press the Speaker which you want make to HOST first, and after it displays "HOST" message, connect the others one by one.  
→ With Stereo Group mode, MAIN is fixed. You can not change others as MAIN.

### I want to play AUX1 or AUX2 more than 8 hours without control input.

→ Press and hold the  button for more than 5 seconds in AUX1 or AUX2 mode to disable Auto Power Down Function. Change from ON-AUTO POWER DOWN to OFF-AUTO POWER DOWN.

---

**I can't connect a SUB to Group play.**

---

- After 1 hour, the HOST will block any additional SUBs from being added. Press the **GROUP PLAY** button on HOST, after it display "**HOST**" message, the SUB can be reconnected.

---

**It cannot make a "Wireless/Wired Group/Add Stereo/Bluetooth" connection.**

---

**Is the distance between systems too far?**

- It is recommended to make a "Wireless/Wired Group/Add Stereo/Bluetooth" pairing within 3.3 ft (1 meter) from the system.
  - The recommended operating distance between Sound Tower systems is closer than 32.8 ft (10 meters).
- 

## 09 LICENSE

---



The Bluetooth® word mark and logos are registered trademarks owned by the Bluetooth SIG, Inc. and any use of such marks by Samsung Electronics Co., Ltd. is under license. Other trademarks and trade names are those of their respective owners.

---



Qualcomm aptX is a product of Qualcomm Technologies, Inc. and/or its subsidiaries. Qualcomm is a trademark of Qualcomm Incorporated, registered in the United States and other countries. aptX is a trademark of Qualcomm Technologies International, Ltd., registered in the United States and other countries.

---

## 10 OPEN SOURCE LICENSE NOTICE

To send inquiries and requests regarding open sources, contact Samsung via Email ([oss.request@samsung.com](mailto:oss.request@samsung.com)).

## 11 IMPORTANT NOTES ABOUT SERVICE

- Figures and illustrations in this User Manual are provided for reference only and may differ from actual product appearance.
- An administration fee may be charged if either:
  - a. An engineer is called out to your home at your request and there is no defect in the product.
  - b. You bring the unit to a repair center and there is no defect in the product.
- You will be advised of the amount of the administration fee before any work is done or a home visit is made.
- If you have a problem with this product, we strongly recommend you read the appropriate section of this manual, visit the Support page for your product at [www.samsung.com](http://www.samsung.com), or call Samsung Product Support (1-800-726-7864) to find an answer before you contact a service center for a repair.

# 12 SPECIFICATIONS AND GUIDE

## Specifications

Model Name		MX-T70
USB1/USB2		USB1: 5V/2.1A USB2: 5V/0.5A
Weight		58.4 lbs (26.5 kg)
Dimensions (W x H x D)		18.2 x 34.8 x 17.9 inches (463.0 x 884.0 x 455.0 mm)
Operating Temperature Range		+41°F to +95°F (+5°C to +35°C)
Operating Humidity Range		10 % ~ 75 %
AMPLIFIER Rated Output power	Tweeter	150W x 2, 12 ohm
	Middle	300W x 2, 6 ohm
	Woofers	600W x 1, 3 ohm

### NOTES

- Samsung Electronics Co., Ltd reserves the right to change the specifications without notice.
- Weight and dimensions are approximate.



## LIMITED WARRANTY TO ORIGINAL PURCHASER

This SAMSUNG brand product, as supplied and distributed by SAMSUNG and delivered new, in the original carton to the original consumer purchaser, is warranted by SAMSUNG against manufacturing defects in materials and workmanship for a limited warranty period of:

### **One (1) Year Parts and Labor\*** **(\*90 Days Parts and Labor for Commercial Use)**

This limited warranty begins on the original date of purchase, and is valid only on products purchased and used in the United States. To receive warranty service, the purchaser must contact SAMSUNG for problem determination and service procedures. Warranty service can only be performed by a SAMSUNG authorized service center. The original dated bill of sale must be presented upon request as proof of purchase to SAMSUNG or SAMSUNG's authorized service center. Transportation of the product to and from the service center is the responsibility of the purchaser. SAMSUNG will repair or replace this product, at our option and at no charge as stipulated herein, with new or reconditioned parts or products if found to be defective during the limited warranty period specified above. All replaced parts and products become the property of SAMSUNG and must be returned to SAMSUNG. Replacement parts and products assume the remaining original warranty, or ninety (90) days, whichever is longer. SAMSUNG's obligations with respect to software products distributed by SAMSUNG under the SAMSUNG brand name are set forth in the applicable end user license agreement. Non-SAMSUNG hardware and software products, if provided, are on an "AS IS" basis.

Non-SAMSUNG manufacturers, suppliers, publishers, and service providers may provide their own warranties. This limited warranty covers manufacturing defects in materials and workmanship encountered in normal, and except to the extent otherwise expressly provided for in this statement, noncommercial use of this product, and shall not apply to the following, including, but not limited to: damage which occurs in shipment; delivery and installation; applications and uses for which this product was not intended; altered product or serial numbers; cosmetic damage or exterior finish; accidents, abuse, neglect, fire, water, lightning or other acts of nature; use of products, equipment, systems, utilities, services, parts, supplies, accessories, applications, installations, repairs, external wiring or connectors not supplied and authorized by SAMSUNG, or which damage this product or result in service problems; incorrect electrical line voltage, fluctuations and surges; customer adjustments and failure to follow operating instructions, cleaning, maintenance and environmental instructions that are covered and prescribed in the instruction book; product removal or reinstallation; reception problems and distortion related to noise, echo, interference or other signal transmission and delivery problems. SAMSUNG does not warrant uninterrupted or error-free operation of the product.

THERE ARE NO EXPRESS WARRANTIES OTHER THAN THOSE LISTED AND DESCRIBED ABOVE, AND NO WARRANTIES WHETHER EXPRESS OR IMPLIED, INCLUDING, BUT NOT LIMITED TO, ANY IMPLIED WARRANTIES OF MERCHANTABILITY OR FITNESS FOR A PARTICULAR PURPOSE, SHALL APPLY AFTER THE EXPRESS WARRANTY PERIODS STATED ABOVE, AND NO OTHER EXPRESS WARRANTY OR GUARANTY GIVEN BY ANY PERSON, FIRM OR CORPORATION WITH RESPECT TO THIS PRODUCT SHALL BE BINDING ON SAMSUNG. SAMSUNG SHALL NOT BE LIABLE FOR LOSS OF REVENUE OR PROFITS, FAILURE TO REALIZE SAVINGS OR OTHER BENEFITS, OR ANY OTHER SPECIAL, INCIDENTAL OR CONSEQUENTIAL DAMAGES CAUSED BY THE USE, MISUSE OR INABILITY TO USE THIS PRODUCT, REGARDLESS OF THE LEGAL THEORY ON WHICH THE CLAIM IS BASED, AND EVEN IF SAMSUNG HAS BEEN ADVISED OF THE POSSIBILITY OF SUCH DAMAGES. NOR SHALL RECOVERY OF ANY KIND AGAINST SAMSUNG BE GREATER IN AMOUNT THAN THE PURCHASE PRICE OF THE PRODUCT SOLD BY SAMSUNG AND CAUSING THE ALLEGED DAMAGE. WITHOUT LIMITING THE FOREGOING, PURCHASER ASSUMES ALL RISK AND LIABILITY FOR LOSS, DAMAGE OR INJURY TO PURCHASER AND PURCHASER'S PROPERTY AND TO OTHERS AND THEIR PROPERTY ARISING OUT OF THE USE, MISUSE OR INABILITY TO USE THIS PRODUCT SOLD BY SAMSUNG NOT CAUSED DIRECTLY BY THE NEGLIGENCE OF SAMSUNG. THIS LIMITED WARRANTY SHALL NOT EXTEND TO ANYONE OTHER THAN THE ORIGINAL PURCHASER OF THIS PRODUCT, IS NONTRANSFERABLE AND STATES YOUR EXCLUSIVE REMEDY.

Some states do not allow limitations on how long an implied warranty lasts, or the exclusion or limitation of incidental or consequential damages, so the above limitations or exclusions may not apply to you. This warranty gives you specific legal rights, and you may also have other rights which vary from state to state.

To obtain warranty service, please contact SAMSUNG customer care center.

The benefits of this Limited Warranty extend only to the original purchaser of Samsung products from an authorized Samsung reseller. THIS LIMITED WARRANTY SHALL NOT APPLY TO ANY SAMSUNG PRODUCTS PURCHASED FROM UNAUTHORIZED RESELLERS OR RETAILERS, EXCEPT IN STATES WHERE SUCH RESTRICTION MAY BE PROHIBITED. For a list of Samsung authorized retailers, please go to:

[http://www.samsung.com/us/peaceofmind/authorized\\_resellers.html](http://www.samsung.com/us/peaceofmind/authorized_resellers.html).

# SAMSUNG



Certification model only

## QUESTIONS OR COMMENTS?

AREA	CALL	OR VISIT US ONLINE AT	WRITE
IN THE US	1-800-SAMSUNG (726-7864)	<a href="http://www.samsung.com/us/support">www.samsung.com/us/support</a>	Samsung Electronics America, Inc. 85 Challenger Road Ridgefield Park, NJ 07660

© 2019 Samsung Electronics Co., Ltd. All rights reserved.