

Panasonic
ideas for life

PT-F300 Series
LCD Projectors

PT-FW300NTU
PT-FW300U
PT-F300NTU
PT-F300U



**Designed for Durability
and
Installation Flexibility**

Performance You Can Count On



In addition to being bright and easy to use, the PT-F300 Series LCD projectors give you enhanced performance with minimal maintenance over time. Highly reliable optical block and a long operating life are ensured by the use of inorganic materials for the LCD panels and polarizers. The new Auto Cleaning Filter (ACF) extends the filter replacement cycle to over 10,000 hours,*¹ and together with the dust-resistant design boost reliability.

High Durability for Long-Lasting Brightness

New Inorganic Materials Add Durability to the Optical Block

The F300 Series projectors' optical block maintains a high level of performance over time, due to the use of inorganic materials in the LCD panels and polarizers. It also makes them the logical choice for a truly dependable LCD projector system.

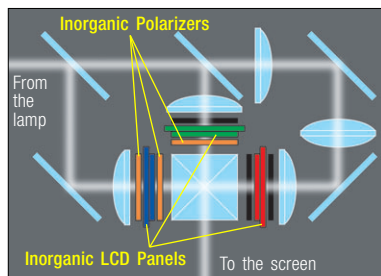

dust-resistant design, minimizes brightness loss due to dust accumulation. As a result, the filter does not need to be replaced for over 10,000 hours,*¹ greatly reducing the hassle of maintenance.

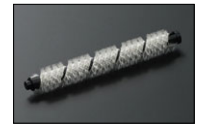

ACF brush

Dust-Resistant Design

In developing the dust-resistant design, Panasonic totally re-engineered the airflow path, from intake to exhaust, to create a cabinet that hermetically seals off the projector interior. This design and the ACF team up to keep the air inside the projector clean for long periods of time and minimize any brightness degradation.



The front panel covers the lens to protect from dust, and conceals the controls to prevent accidental misoperation. It can be opened for easy access to controls even after the projector is mounted to the ceiling.

Auto Cleaning Filter to Minimize Maintenance



Panasonic's proprietary Auto Cleaning Filter (ACF) uses a highly efficient electrostatic filter called the Micro Cut Filter. The ACF brushes away dust that adheres to the filter, which helps prevent clogging that can impair operation or cause malfunction. This helps maintain the Micro Cut Filter's superior dust-collecting performance and, coupled with a

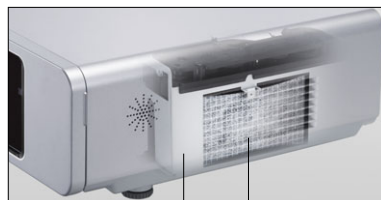

ACF unit

Micro Cut Filter

A highly efficient electrostatic filter in the air intake section traps dust particles that are 1 micron or larger. By capturing approximately seven times as more dust than conventional filters, it guards the optical block and reduces the penetration of dust into the interior to provide stable operation and halt drops in brightness.

5,000-Hour Lamp Life

Lamps used in a projector require much higher precision than ordinary household lamps. Panasonic employs a number of advanced technologies—including a proprietary lamp drive system—that help maintain optimal lamp performance for longer-lasting brightness. This has resulted in a 5,000-hour*² lamp replacement cycle.

*¹ The replacement cycle given here is a guideline. It may be shorter depending on the usage environment.

*² This is a maximum value calculated by continuously turning the lamp on for 3.5 hours and off for 0.5 hour. The lamp replacement cycle will decrease if the lamp is turned on/off more frequently, or if it is left on for longer intervals.

Panasonic PT-F300 Series projectors boast superior installation flexibility and easy maintenance, making them the ideal choice for business or educational use.



Choose the One that Meets Your Needs



PT-FW300NTU

WXGA 3,500 lm Side by Side  



PT-FW300U

WXGA 3,500 lm Side by Side 



PT-F300NTU

XGA 4,000 lm  



PT-F300U

XGA 4,000 lm 



Looking to Replace Your Projectors?

Full of Features for Smooth Replacements

PT-F300 Series projectors make ideal replacements in existing systems. The 2x zoom lens and horizontal/vertical lens shift expand the applicable installation area, so you can place them in the same exact locations as your previous projectors. Abundant interfaces minimize additional cabling when replacing projectors. Using serial input and the Emulate function, you can continue to use the control commands of previous Panasonic models. The LAN terminals support PLink™ class 1 connection for easy control when used in a multi-projector system. All of this means that the PT-F300 Series is your best choice both as a first-time projector and as a replacement.



Excellent Standard Features

Brightness of 4,000/3,500 lumens

A high-performance optical system combines with a high-efficiency 250 W UHM lamp to deliver a high brightness of 4,000 lumens (PT-F300NTU and PT-F300U) or 3,500 lumens (PT-FW300NTU and PT-FW300U). All models deliver crisp, bright images that are easy for the audience to see.

Daylight View 5 Gives Better Color Perception for Easy Viewing in Various Lighting Conditions



The PT-F300 Series features Panasonic's Daylight View 5 technology. Remarkable detail is provided and perceived brightness and contrast are enhanced,*³ so images appear crisp, vivid, 3-dimensional and easy to see even in brightly lit rooms. Sharp edges are achieved with the "Edge Enhancer Control" and "Gamma Curve Control," while the perceived contrast is improved by extending the white level. Daylight View 5 operates in combination with a built-in ambient light sensor that automatically detects room brightness and adjusts operation accordingly.

in brightly lit rooms. Sharp edges are achieved with the "Edge Enhancer Control" and "Gamma Curve Control," while the perceived contrast is improved by extending the white level. Daylight View 5 operates in combination with a built-in ambient light sensor that automatically detects room brightness and adjusts operation accordingly.



Simulated image with Daylight View 5 turned off. Overall contrast appears lower, and images in dark areas cannot be seen.

Simulated image with Daylight View 5 turned on. Detail, depth, brightness and contrast over the entire image are enhanced.

Wide Images (PT-FW300NTU/FW300U)

The PT-FW300NTU and PT-FW300U feature wide-aspect LCD panels, which allow native reproduction of WXGA (1,280 x 800) images from a PC. This provides a visually powerful display of wide-screen images from DVD sources, as well as wide-screen images from wide-aspect PCs, which are now the mainstream.



When projecting images from a source with a wide aspect ratio onto a 4:3 screen, the projector reduces the image to use only 75% of the screen area. Also, wide-screen projection makes it possible to display larger images where room for the screen height is limited.

Side-by-Side Function (PT-FW300NTU/FW300U)

The PT-FW300NTU and PT-FW300U can simultaneously display images from two sources*⁴ onto a single screen. For example, you can display a PC image on the right and a video image on the left. Taking advantage of the wide-screen projection, this function gives you a host of new application possibilities to explore.

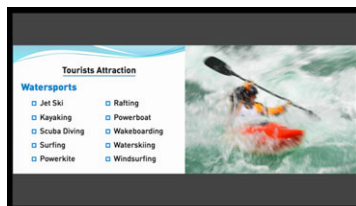

With the wide-aspect-ratio capability, you can project two large 4:3 images side by side.

*³ There is no actual change in the rated brightness or contrast ratio.

*⁴ This function is not effective for some source combinations.

Easy Installation and Maintenance

Wide 2x Zoom and Horizontal/Vertical Lens Shift Give You More Installation Flexibility

Every model can project a 120-inch image from any distance between 3.6 m (11.8 feet) and 7.2 m (23.6 feet).⁵ In new installations, this lets you accommodate a wide range of room sizes and shapes. And when replacing existing projectors, the 2x zoom greatly enhances your ease of installation and can reduce costs by permitting the use of existing mounting positions and cabling.

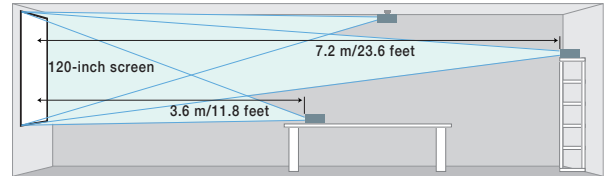

NOTE: This illustration shows the projection distances of the PT-F300NTU/F300U.

Wired LAN: Web Browser Control/Monitoring, E-Mail Message Alert

Anyone can operate a PT-F300 Series projector by remote control or monitor its status over a LAN network, because it is all done using the computer's familiar web browser. Furthermore, the projector sends an e-mail message to notify the operator when an error has occurred, or a lamp needs to be replaced.

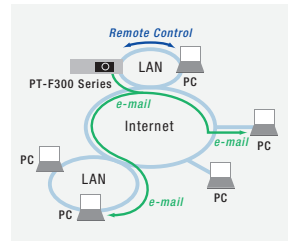

Controlling and Monitoring Multiple Projectors

Panasonic's original Multi Projector Monitoring and Control freeware*⁶ allows the user to control and monitor up to 1,024 projectors via LAN from a remote location. If a problem occurs, an alarm message is sent to the controlling/monitoring PC.

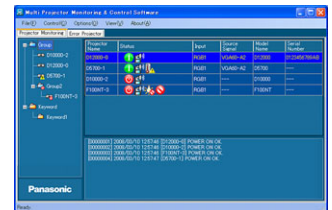

Abundant Connection Terminals

Designed for versatility, each projector comes equipped with a host of connection terminals, including a DVI-D input*⁷ and LAN terminal. Using the serial input, you can continue to use the control commands of previous Panasonic models with the Emulate function. This makes replacement quick and easy. Upon preference, audio out terminal can still be used during standby mode, so you can output audio without turning the projector on.

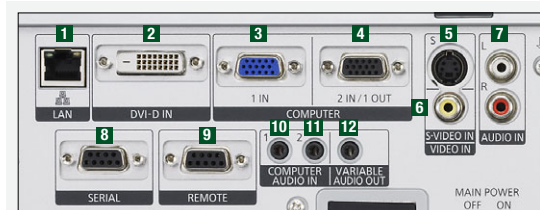

- 1 LAN
- 2 DVI-D input (HDCP-compliant)
- 3 Computer 1 input
- 4 Computer 2 input/computer 1 output
- 5 S-Video input
- 6 Video input
- 7 Audio input for S-Video and video
- 8 Serial input
- 9 Remote input
- 10 Audio input for computer 1
- 11 Audio input for DVI-D and computer 2
- 12 Variable audio output

*⁵ For the PT-F300NTU and PT-F300U. For the PT-FW300NTU and FW300U with 16:10 projection, 3.4 m (11.2 feet) and 6.9 m (22.6 feet).

*⁶ Please consult a sales representative if necessary.

*⁷ HDCP-compliant. HDMI output connection is also possible by using a commercially available HDMI to DVI-D cable.

Direct Power Off

You can turn off the room's main power without waiting for the projector to cool down, because the fan keeps operating until the lamp returns to room temperature.

Easy Lamp Replacement

For easier maintenance, you can replace the lamp from the rear. The lamp is easily replaced even after the projector is installed on the ceiling. Furthermore, Panasonic PT-F300 Series projectors use the same lamp as the Panasonic PT-F100/F200 Series projectors, for efficient lamp purchase planning.

Easy Wireless Projection from Multiple PCs

(PT-FW300NTU/F300NTU)

With wireless capability, you don't need cables to connect a PC. That means it's easy to bring in a laptop (with a wireless LAN function) and deliver a smooth, hassle-free presentation. You can make the settings for wireless connection quickly and easily using Wireless Manager ME 5.5 software. When the presentation is finished, Wireless Manager restores the PC to its previous LAN settings, so the PC is ready to reconnect to your LAN. Functions include Live mode and Multi-Live mode. In Live mode, the image projected is identical to the image seen on the PC screen. In Multi-Live mode, you can wirelessly connect with multiple PCs.*8



Control Panel (Launcher)

To begin wireless projection, simply use the control panel (launcher).



Projector Signal Map
The signal map (S-MAP) graphically shows the strength of wireless connection signals. This is convenient for the users to determine which projector to use when multiple wireless projectors are used in adjacent rooms.

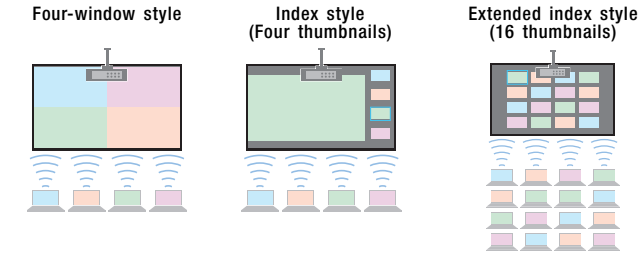

A Wide Variety of Wireless Functions

The PT-F300 Series projectors have a host of convenient wireless functions, including Wireless Prompter (Secondary Display Transmission), Selective Area Transmission and a 16-window index style that lets you project images from up to 16 PCs at the same time. Wireless transmission is possible from one PC to a maximum of eight projectors at a time.

Easy-to-Use Remote Control with Laser Pointer*9

The supplied remote control features a number of wireless projection controls, including Microsoft® PowerPoint® page up/down capability. A frequently used function can also be assigned to the Function button.*10 In addition, remote control operation from as far away as approximately 15 meters (49.2 feet) is possible.*11

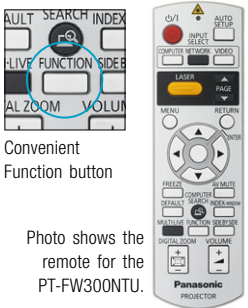

Convenient Function button

Photo shows the remote for the PT-FW300NTU.

Other Valuable Features

- Anti-theft features: Security anchor, user password, control panel lock and text superimposing
- HDTV compatibility
- Picture mode selection (standard/dynamic/natural/cinema/blackboard)
- AV mute for image/sound muting
- Selectable 17-language onscreen menu
- Menu lock function
- Built-in closed caption decoder

Made in Japan

All PT-F300 Series projectors are carefully manufactured at the Panasonic factory in Japan under strict quality control.



Options



Replacement lamp unit ET-LAF100
Replacement filter unit ET-ACF100
Ceiling mount bracket for high ceilings ET-PKF100H
Ceiling mount bracket for low ceilings ET-PKF100S

To use wireless or wired LAN functions, a PC is required to meet the following conditions:

- OS: Microsoft® Windows® 2000 Professional SP4, Windows® XP Professional, Windows® XP Home Edition, Windows® XP Tablet PC Edition 2005, Windows Vista® Ultimate 32-bit, Windows Vista® Business 32-bit, Windows Vista® Home Premium 32-bit, Windows Vista® Home Basic 32-bit, Apple Mac OS X 10.4 (Tiger) and OS X 10.5 (Leopard)
- NOTE: Some functions are not available with Windows Vista™ and Mac OS X.**
- Web browser: Windows®: Internet Explorer 6.0 or later, or Netscape Communicator 7.0 or later. Mac OS: Safari 2.0 or later
- CPU: Windows®: Intel® Pentium® III or higher, or other compatible processor (1 GHz or higher is recommended.)
Macintosh: 1.0-GHz or higher PowerPC G4, or 1.8-GHz or higher Intel® Core™ processor
- Memory: Windows®: 256 MB or more is recommended.
Macintosh: 512 MB or more is recommended.
- Free hard disk space: 60 MB or more
CD-ROM drive: CD-ROM drive or DVD drive
- Wireless LAN (NT-FW300NT/F300NT):
IEEE 802.11b/g compatible (built-in wireless LAN system or external IEEE 802.11b/g LAN card must be installed.)
- NOTE: Some IEEE 802.11g/b wireless LAN may not allow connection to the projector.**
- Wired LAN connector: RJ-45

ECOLOGY-CONSCIOUS DESIGN

Panasonic works from every angle to minimize environmental impact in the product design, production and delivery processes, and in the performance of the product itself over its life cycle. The PT-F300 Series reflects the following ecological considerations.

- RoHS compliance.
- Lead-free solder is used to mount components to the printed circuit boards.
- No halogenated flame retardants are used in the cabinet.
- Lenses contain a minimal amount of lead.

*8 Live mode and Multi-Live mode can also be used with a wired LAN system.
*9 The laser pointer can be disabled.
*10 The following functions can be assigned: aspect menu, picture mode, Daylight View menu, and closed caption setting.
*11 When operated from directly in front of the signal receptor. The operating range depends on the environment.

Specifications (The specifications and design are subject to change without notice as product development proceeds.)

Models	PT-FW300NTU	PT-FW300U	PT-F300NTU	PT-F300U
Power supply	100-240 V AC, 50/60 Hz			
Power consumption	350 W (Approx. 4 W in standby mode with fan stopped. Approx. 25 W when in network standby mode, and approx. 35 W when audio is set to output during standby mode.)			
LCD panel	Panel size	0.75" (19.05 mm) diagonal, 16:10 aspect ratio		0.8" (20.32 mm) diagonal, 4:3 aspect ratio
	Pixels	1,024,000 (1,280 x 800) x 3, total of 3,072,000 pixels		786,432 (1,024 x 768) x 3, total of 2,359,296 pixels
Lamp	250 W UHM lamp			
Brightness*1	3,500 lumens		4,000 lumens	
Center-to-corner uniformity*1	80 %			
Contrast ratio*1	600:1			
Lens	Manual zoom (1:1-1:1.2), manual focus, F 1.7-2.6, f 21.6-43.0 mm		Manual zoom (1:1-1:1.2), manual focus, F 1.7-2.6, f 24.0-47.2 mm	
	Projection size (diagonally)	838-7,620 mm (33-300 inches) diagonally, 16:10 aspect ratio		838-7,620 mm (33-300 inches) diagonally, 4:3 aspect ratio
	Optical axis shift*2	Vertical: ±51%, horizontal: ±24%		Vertical: ±30% Horizontal: 15-91 kHz, Vertical: 50-85 Hz
Keystone correction range	Vertical: ±30°			
Scanning frequency	RGB	Horizontal: 15-91 kHz, Vertical: 50-85 Hz		
	YPbPr	480i (525i), 480p (525p), 576i (625i), 576p (625p), 720 (750)/60p, 720 (750)/50p, 1080 (1125)/60i, 1080 (1125)/50i, 1080 (1125)/60p, 1080 (1125)/50p		
	S-Video/Video	NTSC, NTSC4.43, PAL-M, PAL60: fh 15.75 kHz; fv 60 Hz PAL, SECAM, PAL-N: fh 15.63 kHz; fv 50 Hz		
Built-in speakers	5.0 W (monaural) output power			
Terminals	DVI-D IN	DVI-D 24-pin		
	COMPUTER 1 IN	D-sub HD 15-pin x 1		
	COMPUTER 2 IN/1 OUT	D-sub HD 15-pin x 1 (input/output selectable using on-screen menu)		
	VIDEO IN	RCA pin x 1		
	S-VIDEO IN	Mini DIN 4-pin x 1		
	COMPUTER 1 AUDIO IN	M3 (stereo) x 1 (for COMPUTER 1)		
	COMPUTER 2 AUDIO IN	M3 (stereo) x 1 (for DVI-D and COMPUTER 2)		
	AUDIO IN	RCA (L-R) x 1 (for VIDEO/S-VIDEO)		
	VARIABLE AUDIO OUT	M3 (stereo) x 1		
	SERIAL	D-sub 9-pin x 1 (RS-232C)		
	REMOTE	D-sub 9-pin x 1		
	LAN	RJ45		
Wireless LAN	IEEE802.11b/g		IEEE802.11b/g	
Dimensions*3 (W x H x D)	432 x 128.5 x 323 mm (17" x 5-1/16" x 12-23/32")			
Weight*4	Approx. 6.2 kg (13.7 lbs.)			
Supplied accessories	Power cord, power cord secure lock, wireless remote control, batteries for remote control, Wireless Manager ME 5.5 (CD-ROM), safety wire rope			
Optional accessories	ET-LAF100 replacement lamp unit, ET-ACF100 replacement filter unit, ET-PKF100H ceiling mount bracket for high ceilings, ET-PKF100S ceiling mount bracket for low ceilings			

*1 Measurement, measuring conditions, and method of notation all comply with ISO 21118 international standards. *2 Shift range is limited during simultaneous horizontal and vertical shifting. *3 Including protruding parts.
*4 Average value. May differ depending on models.

PT-FW300NTU/FW300U Projection Distance (16:10)

Projection size (diagonal)	Projection distance (L)		Height from the edge of screen to center of lens (H)
	Min (wide)	Max (telephoto)	
0.84 m / 33"	- / -	1.8 m / 6.2'	0 - 0.23 m / 0 - 0.8'
1.02 m / 40"	1.1 m / 3.6'	2.3 m / 7.6'	0 - 0.28 m / 0 - 0.9'
1.52 m / 60"	1.7 m / 5.5'	3.4 m / 11.5'	0 - 0.42 m / 0 - 1.4'
2.03 m / 80"	2.3 m / 7.4'	4.6 m / 15.3'	0 - 0.55 m / 0 - 1.8'
2.54 m / 100"	2.9 m / 9.3'	5.7 m / 19.2'	0 - 0.69 m / 0 - 2.3'
3.81 m / 150"	4.3 m / 14.1'	8.6 m / 28.9'	0 - 1.04 m / 0 - 3.4'
5.08 m / 200"	5.7 m / 18.8'	11.5 m / 38.6'	0 - 1.39 m / 0 - 4.5'
7.62 m / 300"	8.6 m / 28.3'	17.2 m / 58.1'	0 - 2.08 m / 0 - 6.8'

PT-FW300NTU/FW300U Projection Distance (16:9)

Projection size (diagonal)	Projection distance (L)		Height from the edge of screen to center of lens (H)
	Min (wide)	Max (telephoto)	
0.84 m / 33"	- / -	1.9 m / 6.4'	0 - 0.24 m / 0 - 0.8'
1.02 m / 40"	1.2 m / 3.8'	2.3 m / 7.6'	0 - 0.29 m / 0 - 0.9'
1.52 m / 60"	1.8 m / 5.7'	3.5 m / 11.5'	0 - 0.43 m / 0 - 1.4'
2.03 m / 80"	2.4 m / 7.6'	4.7 m / 15.3'	0 - 0.57 m / 0 - 1.9'
2.54 m / 100"	3.0 m / 9.6'	5.9 m / 19.2'	0 - 0.71 m / 0 - 2.3'
3.81 m / 150"	4.5 m / 14.5'	8.8 m / 28.9'	0 - 1.07 m / 0 - 3.5'
5.08 m / 200"	5.9 m / 19.3'	11.8 m / 38.6'	0 - 1.43 m / 0 - 4.7'
7.62 m / 300"	8.9 m / 29.1'	17.7 m / 58.1'	0 - 2.14 m / 0 - 7.0'

PT-F300NTU/F300U Projection Distance (4:3)

Projection size (diagonal)	Projection distance (L)		Height from the edge of screen to center of lens (H)
	Min (wide)	Max (telephoto)	
0.84 m / 33"	- / -	1.9 m / 6.4'	0 - 0.25 m / 0 - 0.8'
1.02 m / 40"	1.2 m / 3.8'	2.4 m / 7.8'	0 - 0.30 m / 0 - 1.0'
1.52 m / 60"	1.8 m / 5.8'	3.6 m / 11.7'	0 - 0.46 m / 0 - 1.5'
2.03 m / 80"	2.4 m / 7.8'	4.8 m / 15.7'	0 - 0.61 m / 0 - 2.0'
2.54 m / 100"	3.0 m / 9.9'	6.0 m / 19.7'	0 - 0.76 m / 0 - 2.5'
3.81 m / 150"	4.5 m / 14.9'	9.0 m / 29.6'	0 - 1.14 m / 0 - 3.8'
5.08 m / 200"	6.1 m / 19.9'	12.0 m / 39.5'	0 - 1.52 m / 0 - 5.0'
7.62 m / 300"	9.1 m / 29.9'	18.1 m / 59.3'	0 - 2.29 m / 0 - 7.5'

NOTES ON USE

- The projector uses a high-voltage mercury lamp that contains high internal pressure. This lamp may break, emitting a large sound, or fail to illuminate, due to impact or extended use. The length of time that it takes for the lamp to break or fail to illuminate varies greatly depending on individual lamp characteristics and usage conditions.
- The brightness of the lamp will gradually decrease with use.
- The projector includes consumable parts. The frequency of replacement for the lamp and other consumable parts will increase if the projector is subjected to extended, continuous use. For details, please consult a service representative.

Dimensions

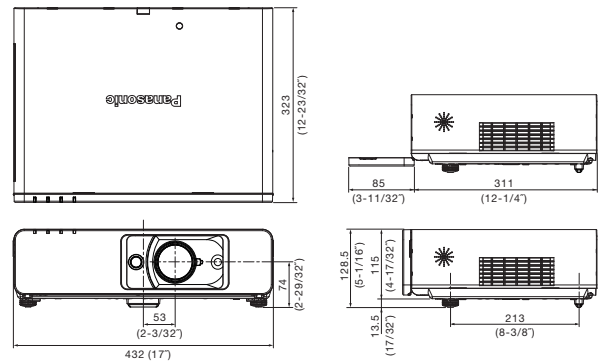

unit: mm (inch)



Projectors Global Web Site: <http://panasonic.net/avc/projector>

Please contact Panasonic or your dealer for a demonstration.

Panasonic Projector Systems Company,
Unit of Panasonic Corporation of North America
www.panasonic.com/projectors

Headquarters
3 Panasonic Way, 4B-9
Secaucus, NJ 07094
888-411-1996

Panasonic Canada Inc.
5770 Ambler Drive
Mississauga, Ontario
Canada L4W 2T3
905 624 5010



Weights and dimensions shown are approximate. Specifications are subject to change without notice. Product availability differs depending on region and country. This product may be subject to export control regulations. Intel, Pentium, and Intel Core are trademarks or registered trademarks of Intel Corporation or its subsidiaries in the United States and other countries. Microsoft, Windows Vista and Windows are either registered trademarks or trademarks of Microsoft Corp. in the United States and/or other countries. Apple, Mac, Mac OS, and Macintosh are trademarks of Apple Inc., registered in the U.S. and other countries. PowerPC is a trademark of International Business Machines Corporation, registered in the U.S. Fujitsu is a registered trademark or trademark in Japan, the United States, and other countries and regions. All other trademarks are the property of their respective trademark owners. Projection images simulated. (C) 2008 Panasonic Projector Systems Company is a Unit of Panasonic Corporation of North America. All rights reserved. (C) 2008 Panasonic Corporation. All rights reserved.

All information included here is valid as of November 2008.

PT-F300NTU1-08DEC Printed in Japan.