



ACTION CAMCORDER

Functions

This user's manual has referred to the latest information we had when this user's manual was made. The screen display and illustrations are used in this user's manual for the purpose of introducing details of this digital camera in a more specific and direct way. Difference may arise between these displays and illustrations and the digital camera actually available for you due to difference in technological development and production batch, under which case, the actual functions of this video camera shall prevail.

Announcements

Please read the Announcements carefully before using this video camera for proper and safe operation, so as to bring its optimum performance into play and extend its service life.

- ◆ Do not expose the video camera to sunshine directly, nor point its lens to sunlight. Otherwise, the image sensor of the video camera may be damaged.
- ◆ Take good care of the video camera and prevent water or sand particles from entering the video camera when it is used on the beach or water, because water, sand particles, dust or component containing salt may damage the video camera.
- ◆ Keep the video camera contaminated free of dust and chemical materials. Place it in a cool, dry and well ventilated place. Do not place the video camera in a high temperature, moist or dusty place.
- ◆ Please check if the video camera can operate normally before use.
- ◆ If dirt or stain is accumulated on the video camera or on its lens, use soft, clean and dry rag to wipe it away gently. If the video camera or its lens is stained with sand particles, blow them away gently. Do not use cloth to wipe arbitrarily. Otherwise, it may scratch the surface of video camera or its lens.
- ◆ If it is required to clean camera surface, firstly blow away the sand dust accumulated on this surface, and then wipe the camera gently with rag or tissue applicable to optical equipments. Please use the cleaning

agent of video camera for wiping if necessary. Do not use organic solvent to clean the video camera.

- ◆ Do not touch the lens surface with fingers.
 - ◆ Please back up the data if the memory card inside this video camera is used for the first time.
 - ◆ The externally installed memory-cards are manufactured from precise electronic components. Data may be lost or damaged under the following circumstances:
 1. Improper use of the memory card.
 2. The memory card is bent, dropped or collided.
 3. Place it under high temperature or moist environment or expose to sunshine directly.
 4. Electrostatic or electromagnetic field exists around the memory card.
 5. This memory card is taken out or power supply is interrupted when this video camera or computer is connected to the memory card (i.e. during reading, writing and formatting).
 6. Touch the metal contact surface of the memory card with fingers or metal materials.
-

Waterproof Case Using Notice

- ◆ Before sealing the waterproof case, keep the camera housing's rubber seal clean, a single hair or grain of sand can cause a leak. You can test by closing the case without inserting the camera. Submerge the case completely in water for about a minute. Remove the case from the water, dry off its exterior with a towel, then open the case. If the entire interior is dry, the case is safe for use under water.
- ◆ Remember to put the Mode Switch in your desired recording position before inserting the camera in the waterproof case. There is no external button for the Mode Switch.
- ◆ After every use in salt water you will need to rinse the outside of the housing with non-salt water and dry. Not doing this can eventually cause corrosion of the hinge pin and salt buildup in the seal, which can cause failure.
- ◆ To clean the seal, rinse in fresh water and shake dry (drying with a cloth may cause lint to compromise the seal). Re-install the seal into the grooves in the backdoor of the housing.

System Requirements

System Requirements	
Operating System	Microsoft Windows2000, XP, Vista, 7
CPU	Intel Pentium III of more than 800MHz or other CPU with equivalent performance
Internal Memory	Larger than 512MB
Sound Card and Display Card	The sound card and display card shall support DirectX8 or higher version.
CD Driver	Speed of 4 times or faster
Hard Disk	Free space of more than 500MB
Others	One standard USB1.1 or USB2.0 port

Introduction to Appearance and Keypad

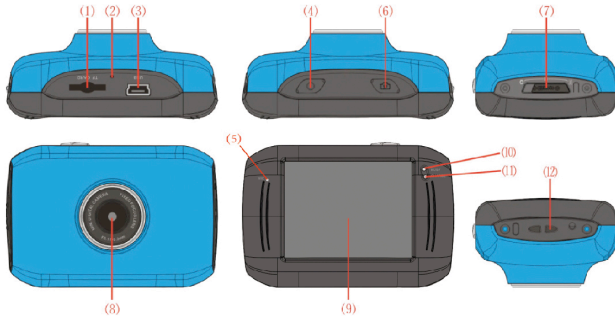

- (1)Memory card slot
- (2)Reset
- (3)USB slot
- (4)Power button
- (5)MIC
- (6)Shutter button
- (7)Mode Switch:

- (8)Lens
- (9)LCD TFT
- (10)Working Indicator Light
- (11)Indicator Light for charging
- (12)Wrist strap eyelet

Usage

1. Charge the built-in lithium battery



Connect the video camera with computer for charging in the shutdown state. The indicator light for charging is on at this time and will be off after charging. In general, it can be fully charged after 2-4 hours.

2. Use of Memory Card

1. Push the memory card into the card slot according to the concave lettering beside the slot of memory card till it is completely inserted.
2. To take out the memory card, gently press the end of the memory card inward and it will pop up.

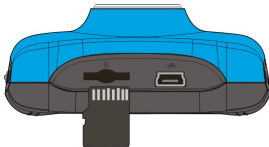

Note: No built-in memory is available in this video camera. Make sure to insert memory card before using.

3. Startup/Shutdown

3.1 Startup: Press the POWER button for 3 seconds, the screen is displayed and the camera is on.

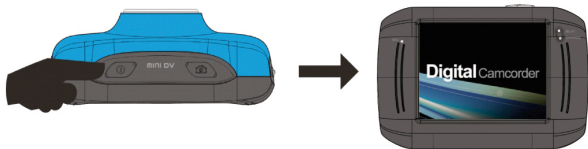

3.2. Shutdown: Press the POWER Key, and the camera will be shut down. .

Automatic shutdown: when the idle time of the video camera reaches the time for automatic shutdown, it will be shut down automatically to save power. The default time of this camera for automatic shutdown is 5 minutes.

3.3. Shutdown in case of power shortage: when the power of the battery is insufficient, the LCD display screen will display the low power icon. Please charge it in time. When indicate light turns red and flickering, the video camera will be shut down automatically.

4. Conversion between Function Modes

Three modes are available for this video camera, i.e. picture taking mode, video recording mode and vehicle-mounted mode. Conversion is available via the mode switch after startup.

Picture taking mode: pictures can be taken;

Video recording mode: video can be recorded;

Vehicle-mounted mode: videotape can be recorded.

(one section every 5 minutes)

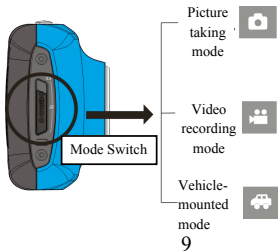

5. Indicator light

Busy light: when the camera is busy (such as, recording a film, taking photos, automatic off-screen), the busy light will be on.

Charging light: when the light is on for a long time, it prompts the user that the camera is charging.

6. Video recording mode

When the mode switch is turned to video recording mode, press the shutter button once or click the LCD center once to begin recording under previewing state; press the shutter button once again if you want to stop recording, and the camera will also stop recording, automatically when the memory card is full or the power is insufficient-







1 **00:12:18:** Timer means that video recording can still last for 12 minutes and 18 seconds.

2  : mode icon, represents that the video camera is in video recording mode.

3  : videoing size, clicks this icon and you can choose 720P/VGA.



4  : means that the memory card is inserted at present.









- 5  : digital zoom icon, click it and enlarge it.
- 6  : digital zoom icon, click and minify it.
- 7  : visual shutter, touch this visible frame for taking photos or recording.
- 8  : battery icon, represents the power status of the battery.
- 9  : represents the status of digital zoom.
- 10  : click this icon to switch to the playback mode.
- 11  : click this icon to set the date and time, finished setting and press Shutter key to confirm.

7 Picture taking mode:

Switch the mode switch into the Picture taking mode, press the shutter button or click the LCD center once under the previewing state to take a photo:

- 1 **0/1234**: Counter, indicating current number of photos taken already /number of photos to be taken.
- 2  : mode I con, indicating that the camera is in photo taking mode.
- 3  : video size, click this icon to select the photo resolution.
- 4  : means that the memory is been inserted at present.











- 5  : digital zoom icon, click it to enlarge.
- 6  : digital zoom icon, click it to minify.
- 7  : visual shutter, touch this visible frame for taking photos or recording.
- 8  : battery icon, indicates the power status of the battery.
- 9  : represents the status of digital zoom.
- 10  : click this icon to switch to the playback mode.
- 11  : click this icon to set the date and time, finished setting and press Shutter key to confirm.



8 Vehicle-mounted mode:

Turn the mode switch to vehicle-mounted mode, press the shutter button or click the LCD center once under the preview state to begin recording, save a segment for recording every 5 minutes, then start to record the next segment of video. When the storage card is full, the earliest segment of video will be deleted to release the corresponding space for continuous recording.

- 1 00:12:18 timer, indicating that the camera can still record for 12 minutes and 18 seconds.

- 2  : mode icon, representing that the camera is in vehicle-mounted mode.
- 3  : video size, click this icon to select 720P, VGA.
- 4  : represents that the memory card has been inserted .
- 5  : digital zoom icon, click it to enlarge.
- 6  : digital zoom icon, click it to minify.
- 7  : visual shutter, touch this visible frame for taking photos or recording.
- 8  : battery icon, representing the current power status of the battery.
- 9  : represents the status of digital zoom.
- 10  : click this icon to switch into the playback mode.
- 11  : click this icon to set the date and time, finished setting and press Shutter key to confirm.

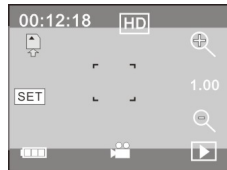









Note: the screen will be off automatically during recording process in order to save power; user can press the power button shortly to start the screen and restore display.

9 Playback mode:

- 9.1 After starting up and entering the previewing state, click the playback icon () at the lower right corner of the LCD to switch to the playback mode:

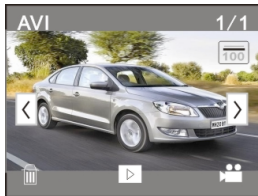

Click

- 1  : represents that the current file is an AVI video file.
- 2  : represents that there is one file in the current folder/one file in total.
- 3  : current folder name (such as: I:\DCIM\100MEDIA
I: is the movable disk of the device).
- 4  : Means that clicking can select files frontwards.
- 5  : Means that clicking can select files backwards.
- 6  : Means that clicking can activate to confirm the deletion of the current file picture.
- 7  : Means that clicking can play the current movie clips.
- 8  : Means that clicking can switch back to the previous photo mode (video mode).

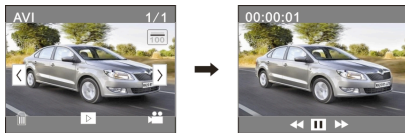

9.2 Movie clips playing:



Click  to pause playing, click  to play forward, and click  to play backward.

9.3 File deletion:



Click YES to delete the current file immediately, or click NO to cancel the request of deletion.

Apply on the personal computer

Connect to personal computer

The camera is provided with the plug and play function. Connect the device to the computer with USB line under turning-on state, then it will be switched into the movable hard disk mode.

Icon of movable disk will appear on the window of “my computer”. Photos/videos you have taken are saved in folder I:\DCIM\100MEDIA (I is the movable disk of this device) in the movable disk. Files recorded in vehicle-mounted mode are saved in I:\DCIM\RECORDER.

Technical parameters

Image sensor	1.3 million pixel (CMOS)	
Function mode	videoing, taking photos, vehicle-mounted mode, removable disk	
Camera lens	F3.1 f=9.3mm	
Digital zooming	4 times	
Shutter	Electronic shutter	
LCD display screen	2.0-inch touch screen	
Image resolution	5M (2592×1944), 3M (2048×1536), 1M(1280×1024)	
Video resolution	VGA: 640x480 (60 frames/second), 720P:1280x720 (30 frames/second)	
White balance	Automatic	
Exposure	Automatic	
File formats	Image	JPEG
	Video	AVI
Storage medium	Micro SD card (Supporting up to 32GB), (without built-in flash memory)	
USB interface	High-speed USB 2.0 interface	
Power Supply	Built-in 3.7V rechargeable lithium	
Dimension (length × width × height)	66*45*25mm	
Weight	about 48 grams	



This symbol indicates that the relevant electrical product or battery should not be disposed of as general household waste in Europe. To ensure the correct waste treatment of the product and battery, please dispose them in accordance to any applicable local laws of requirement for disposal of electrical equipment or batteries. In so doing, you will help to conserve natural resources and improve standards of environmental protection in treatment and disposal of electrical waste (Waste Electrical and Electronic Equipment Directive).

DECLARATION OF CONFORMITY

Easypix hereby declares that the product GoXtreme Race is in conformity to all the essential requirements of Directive 1999/5/EC. The declaration of conformity can be downloaded here:

http://www.easypix.info/download/pdf/doc_goxtreme_race.pdf

For technical help please visit our support area on www.easypix.eu.



