



®

GENERATION FUTURE

HOVER



USER MANUAL



IMPORTANT SAFETY REMINDERS

This appliance should only be used for domestic cleaning, as described in this user guide. Please ensure that this guide is fully understood before operating the appliance.

Do not leave the appliance plugged in. Always switch off and remove the plug from the socket after use, or before cleaning the appliance or any maintenance task.

This appliance can be used by children aged from 8 years and above and persons with reduced physical, sensory or mental capabilities or lack of experience and knowledge if they have been given supervision or instruction concerning use of the appliance in a safe way and understand the hazards involved. Children shall not play with the appliance. Cleaning and user maintenance shall not be made by children without supervision.

If the power cord is damaged stop using the appliance immediately. To avoid a safety hazard, an authorised Hoover service engineer must replace the power cord.

Keep hands, feet, loose clothing and hair away from rotating brushes.

Use only attachments, consumables or spares recommended or supplied by Hoover.

When using cleaning tools ensure that the appliance is kept in the upright (parked) position. This will avoid possible damage to the carpet or floor covering. When cleaning stairs, do not position the appliance above you.

Static electricity: some carpets can cause a small build up of static electricity. Any static discharge is not hazardous to health.

Do not use your appliance out of doors or on any wet surface or for wet pick up.

Do not pick up hard or sharp objects, matches, hot ashes,

cigarette ends or other similar items.

Do not spray with or pick up flammable liquids, cleaning fluids, aerosols or their vapours.

Do not run over the power cord when using your appliance or remove the plug by pulling on the power cord.

Do not continue to use your appliance if it appears faulty.

Hoover service: To ensure the continued safe and efficient operation of this appliance we recommend that any servicing or repairs are only carried out by an authorised Hoover service engineer.

Do not stand on or wrap the cord around arms or legs when using your appliance.

Do not use the appliance to clean animals or people.

When using the cleaning tools, ensure to always steady the appliance with your other hand. This will ensure that the appliance does not fall while in use.

WARNING: A thermal cut out switches off the appliance to prevent overheating if it is used when full or there is a blockage or dirty filters. If this should happen then switch off, unplug and correct the fault. It will take approximately 45 minutes for the cut out to automatically reset.

The Environment

The symbol on this appliance indicates that this appliance may not be treated as household waste. Instead it must be handed over to the applicable collection point for the recycling of electrical and electronic equipment. Disposal must be carried out in accordance with local environmental regulations for waste disposal. For more detailed information about treatment, recovery and recycling of this appliance, please contact your local city office, your household and waste disposal service or the shop where you purchased the appliance.



CE This appliance complies with the European Directives 2006/95/EC, 2004/108/EC and 2011/65/EU.

HOOVER Limited, Pentrebach, Merthyr Tydfil, Mid Glamorgan, CF48 4TU, UK

GETTING TO KNOW YOUR CLEANER

Effortless
cleaning
with your
new Hoover

This vacuum cleaner is
supplied with an Energy
Label as required by
European Regulation (EU) 665/2013.

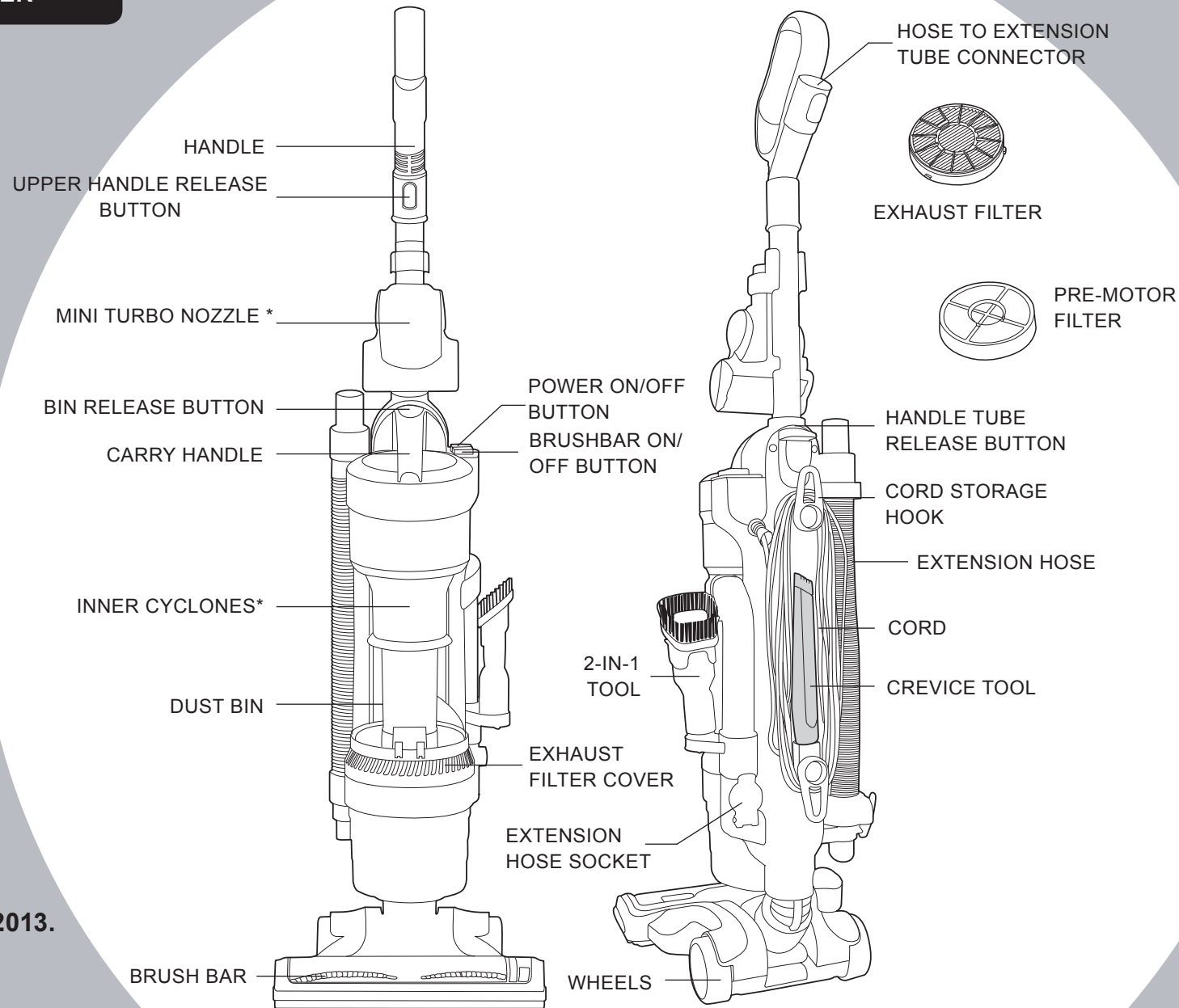

* Certain models only



PREPARING YOUR CLEANER

Insert the main handle in the cleaner body and then adjust handle up/down to the desired height.

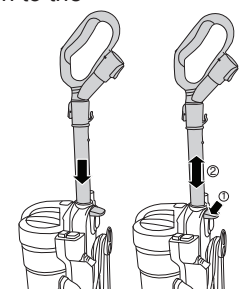

SUPPLY CORD

Do not run over the supply cord.

Clip the supply cord in the cord clip at the back of the handle to avoid accidentally running the cleaner over the cord and causing any damage.

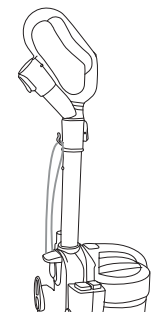

MINI TURBO BRUSH ASSEMBLY*

Assemble the mini turbo brush holder to the handle tube of the cleaner, then put the mini turbo nozzle to the holder.

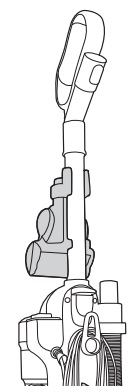

Put 2-in-1 tool and crevice tool on board storage area.

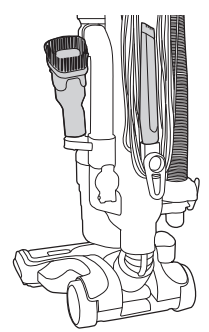

POWER SWITCH

Plug in your machine and turn it on.

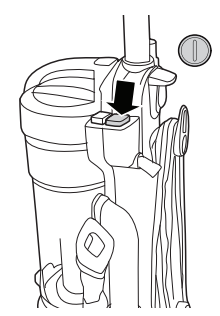

BRUSH BAR SWITCH

Press the brush bar on/off button at the top of the unit.
Brush bar on - carpet
Brush bar off - hard floor

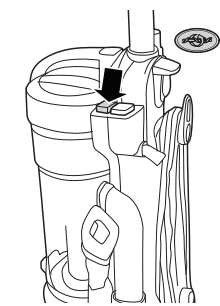

CLEANER RELEASE

Recline to unlock the cleaner

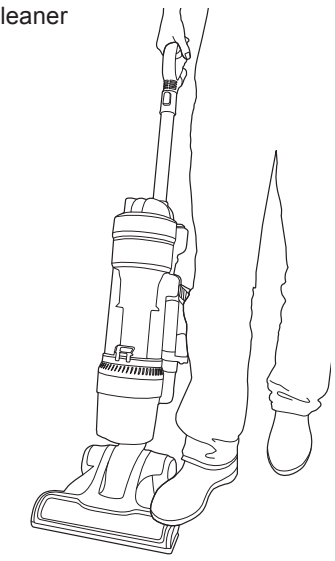

Twist the handle to manoeuvre under or around furniture

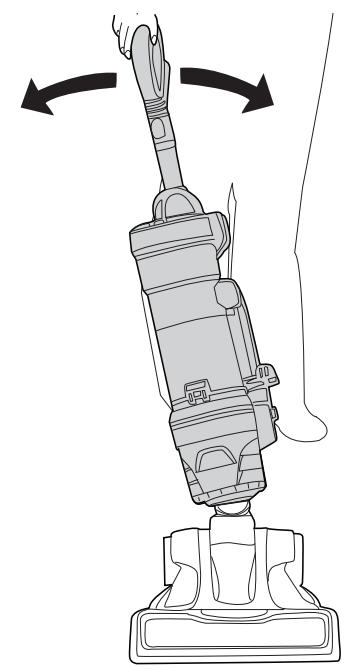

* Certain models only



CLEANING TOOLS

Handle

All accessories can fit onto the end of the hose, handle and handle tube. Combine accessories depending on use.

Mini Turbo Nozzle*

The Mini turbo nozzle* is ideal for removing pet hairs. DO NOT touch the rotating brush.

Parquet Nozzle*

The parquet nozzle is ideal for cleaning delicate surfaces.

Connecting Accessory to Hose

- 1 Plug in the long stretch hose in the hose socket.
 - 2 Choose your accessory.
 - 3 Connecting accessory to hose.
-

Connecting accessory to Handle Tube

- 1 Remove handle tube.
 - 2 Connect hose to handle tube.
 - 3 Connect accessory to the handle tube.
-

! IMPORTANT! When using cleaning tools, the cleaner must be kept in the upright position, particularly when cleaning stairs. Hold unit while using hose or handle tube.

CLEANING THE STAIRS

It is dangerous to place the cleaner above you when cleaning stairs.

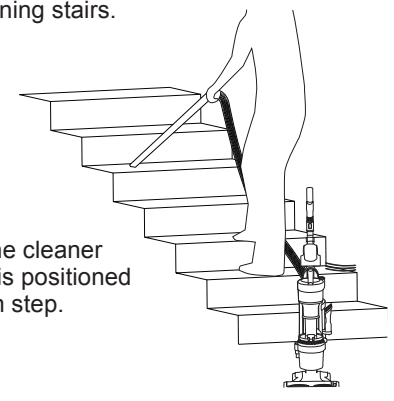

ALWAYS work with the cleaner below you. Ensure it is positioned up against the bottom step.

STORING THE CLEANER

Turn the cleaner off and remove the plug. Wind the power cord around the cord storage hooks.

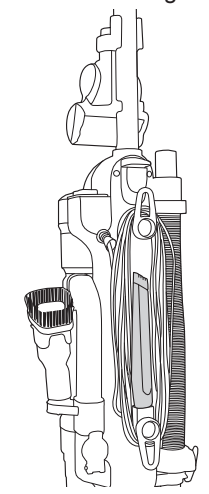

* Certain models only



EMPTYING THE BIN

! IMPORTANT: Before emptying the bin, make sure vacuum cleaner has been switched off.

1 To remove the bin from the cleaner press the bin release button.

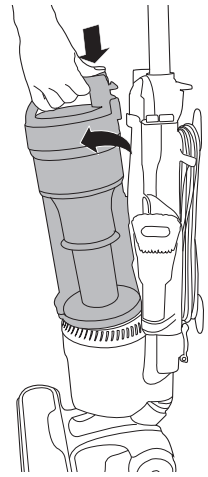

2 Hold the container over the Bin and press the easy open button.

The bin door will open and you can empty into a bin with no dust contact.

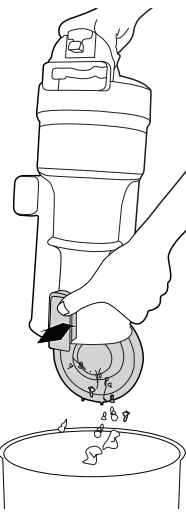

3 Once emptied, gently tap or shake the container to release any excess dust.

Do not overfill the bin above the max level line.

CLEANING THE PRE MOTOR FILTERS

1 Rotate the upper part of the dust bin to open.

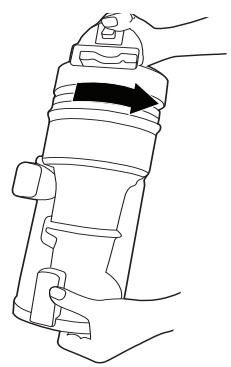

3 Gently tap both filters to release any excess dust.

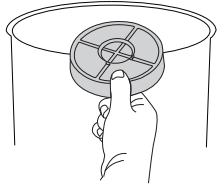

2 Take out the pre-motor filter.

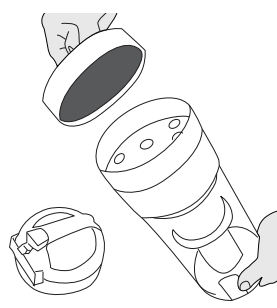

4 Wash both filter and sponge under warm water until the water runs clean. Remove excess water by shaking and leave to dry for 24 hours. Reassemble and refit filters to cleaner, only when they are completely dry.

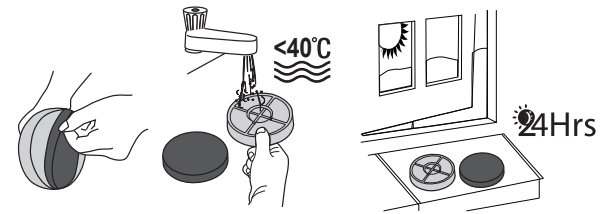

! IMPORTANT! Ensure the pre-motor filter and exhaust filters are reassembled to the cleaner before use.

CLEANING THE EXHAUST FILTER

The exhaust filter should be washed every month. Remove the exhaust filter from your cleaner and wash with lukewarm water.

Remove excess water by shaking and leave to dry for 24 hours. Refit filters only when completely dry.

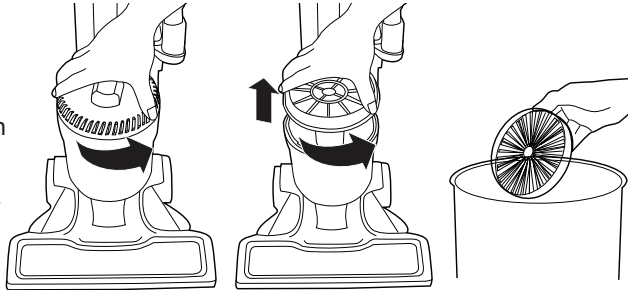



CHANGING THE BELT OR BRUSHES

If your cleaner is not picking up efficiently, the belt or brushes (or both) may need replacing, but first please make sure you have:

- Emptied the bin
- Cleaned the filters
- Checked for blockages

IMPORTANT: Switch the cleaner off and remove the plug from the electricity supply before attempting any maintenance.

1 Turn the cleaner over and remove 2 rear rollers and 2 retaining screws.

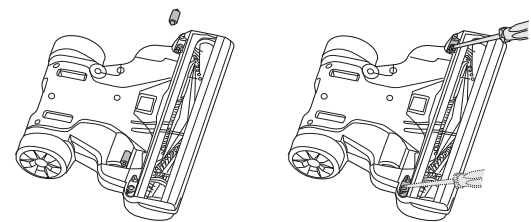

2 Remove the brush guard.

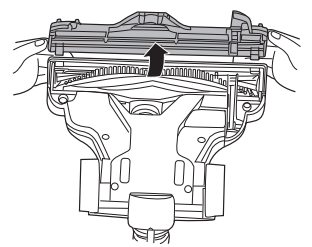

3 Remove brush assembly and check for wear on the belt. Loop the new belt around the motor and brush channel.

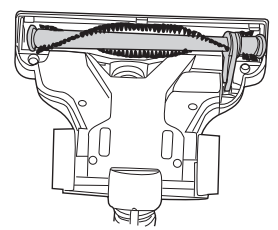

4 Hold the brush assembly and stretch the belt until the brush can be slotted back into the cleaner housing.

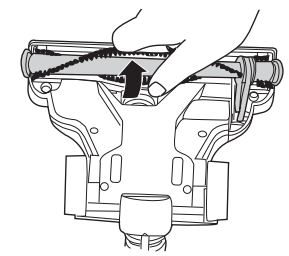

5 Rotate the brush to ensure free movement of the belt.

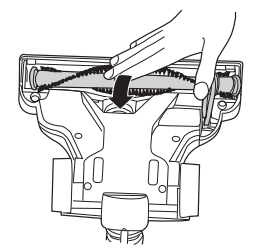

6 Refit the brush guard with 2 retaining screws and 2 rear rollers..

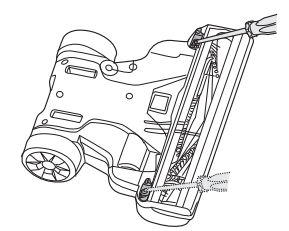

NOTE: When the brush was blocked and stopped rotating, switch off and remove the plug from the electricity supply, then use a pair of scissors to cut through any threads or hairs caught around the brush. **Reassemble** the brush and brush guard.

CLEARING A BLOCKAGE

IMPORTANT: Switch the cleaner off and remove the plug from the electricity supply before attempting any maintenance.

Check the cleaning tools and hose for blockages.

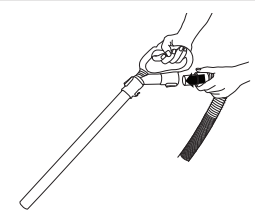

The hose can be removed at both ends.

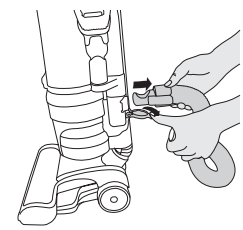

Turn the cleaner over and rotate the brushes to identify any obstructions including hair.

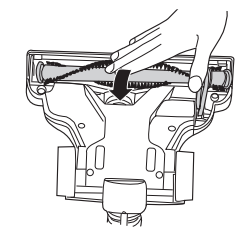

Check for a blockage in the hose socket. Use a flexible rod to remove any obstruction.

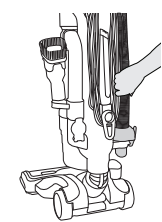

Removing a blockage from the mini turbo nozzle. Open the nozzle at each side, lift cover and remove the blockage.

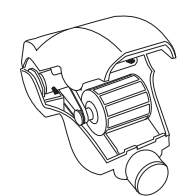

*Certain models only

User checklist

If your cleaner is not working properly run through the following checklist.

1. Is there a working electricity supply to the cleaner?
Check with another electrical product.
2. Is the bin full or choked with fine dust?
To empty the bin, see the User Manual on P6.
3. Is the hose blocked?
To clear a blockage, see the User Manual on P7.
4. Is there a blockage in the cleaner base?
To clear a blockage, see the User Manual on P7.
5. Are the filters blocked?
To clean filters, see the the User Manual on P6.
6. Are the brushes rotating correctly?
To check the brushes, see the User Manual on p7.
7. Has the cleaner overheated?
If so, it will take about 30 minutes to reset.

If there is any doubt call the Hoover Service Office for advice. They may be able to assist you over the telephone. A service charge will be made if the cleaner is examined and found to be in working order, has not been assembled in accordance with these instructions or has been used incorrectly. working order, has not been assembled in accordance with these instructions or has been used incorrectly.

WARNING!

A thermal cut out switches off the cleaner to prevent overheating if it is used when full or there is a blockage or dirty filters. If this should happen switch off, unplug and correct the fault.

It will take about 45 minutes for the cut out to automatically reset.

IMPORTANT: Do not run cleaner over the supply cord as this could damage the supply cord insulation.

IMPORTANT INFORMATION

Hoover Service

Should you require service at any time, please contact your local Hoover Service Office.

Hoover spares and Consumables

Always replace parts with genuine Hoover spares. These are available from your local Hoover dealer or direct from Hoover. When ordering parts always quote your model number.

USE ONLY HOOVER SPARES

| CONSUMABLES & SPARE PARTS | CODE |
|--------------------------------|------------------|
| PRE-MOTOR & EXHAUST FILTER KIT | U71 - 35601420 |
| HOSE | D146 - 35601418 |
| AGITATOR | Y31 - 35601419 |
| DUST & BRUSH FURNITURE NOZZLE | P15 - 35601415 |
| PET HAIR REMOVER NOZZLE | J61 - 35601417 |
| BELT | V29 - 35600744 |
| PARQUET EXTRA NOZZLE | G87PC - 35600655 |

Quality

Hoover's factories have been independently assessed for quality. Our products are made using a quality system which meets the requirements of ISO 9001

GUARANTEE STATEMENT

The guarantee conditions for this appliance are as defined by our representative in the country in which it is sold. Details regarding these conditions can be obtained from the dealer from whom the appliance was purchased. The bill of sale or receipt must be produced when making any claim under the terms of this guarantee.

Subject to change without notice.



GENERATION FUTURE

Hoover Limited
Pentrebach
Merthyr Tydfil
Mid Glamorgan
CF48 4TU

HOOVER CUSTOMER HELPLINE
08444 995 599

PRINTED IN P.R.C.
48017168