

DL30/DL50

User Manual



Federal Communications Commission Statement

NOTE: This equipment has been tested and found to comply with the limits for a Class A digital device, pursuant to part 15 of the FCC Rules. These limits are designed to provide reasonable protection against harmful interference when the equipment is operated in a commercial environment. This equipment generates, uses, and can radiate radiofrequency energy and, if not installed and used in accordance with the instruction manual, may cause harmful interference to radio communications. Operation of this equipment in a residential area is likely to cause harmful interference in which case the user will be required to correct the interference at his own expense.

FCC Caution: Any changes or modifications not expressly approved by the party responsible for compliance could void the user's authority to operate this equipment.

This device complies with part 15 of the FCC Rules.

Operation is subject to the following two conditions:

- (1) This device may not cause harmful interference, and
- (2) this device must accept any interference received, including interference that may cause undesired operation.

Warning - This is a class A product. In a domestic environment, this product may cause radio interference in which case the user may be required to take adequate measures.

This Class A digital apparatus complies with Canadian ICES-003.

Caution

Risk of explosion if battery is replaced by an incorrect type.

Dispose of used batteries in a safe and proper manner.

Remote Control Battery Safety Information

- Store batteries in a cool and dry place.
- Do not throw away used batteries in the trash. Properly dispose of used batteries through specially approved disposal methods.
- Remove the batteries if they are not in use for long periods of time. Battery leakage and corrosion can damage the remote control. Dispose of batteries safely and through approved disposal methods.
- Do not use old batteries with new batteries.
- Do not mix and use different types of batteries: alkaline, standard (carbon-zinc) or rechargeable (nickel-cadmium).
- Do not dispose of batteries in a fire.
- Do not attempt to short-circuit the battery terminals.

DISCLAIMER

No warranty or representation, either expressed or implied, is made with respect to the contents of this documentation, its quality, performance, merchantability, or fitness for a particular purpose. Information presented in this documentation has been carefully checked for reliability; however, no responsibility is assumed for inaccuracies. The information contained in this documentation is subject to change without notice.

In no event will AVer Information Inc. be liable for direct, indirect, special, incidental, or consequential damages arising out of the use or inability to use this product or documentation, even if advised of the possibility of such damages.

TRADEMARKS

“AVer” is a trademark owned by AVer Information Inc. Other trademarks used herein for description purpose only belong to each of their companies.

COPYRIGHT

©2021 AVer Information Inc. All rights reserved.

All rights of this object belong to AVer Information Inc. Reproduced or transmitted in any form or by any means without the prior written permission of AVer Information Inc. is prohibited. All information or specifications are subject to change without prior notice.

NOTICE

SPECIFICATIONS ARE SUBJECT TO CHANGE WITHOUT PRIOR NOTICE. THE INFORMATION CONTAINED HEREIN IS TO BE CONSIDERED FOR REFERENCE ONLY.

WARNING

- To reduce the risk of fire or electric shock, do not expose this appliance to rain or moisture. Warranty will be void if any unauthorized modifications are done to the product.
- Do not drop the camera or subject it to physical shock.
- Use the correct power supply voltage to avoid the damaging camera.
- Do not place the camera where the cord can be stepped on as this may result in fraying or damage to the lead or the plug.
- Hold the bottom of the camera with both hands to move the camera. Do not grab the lens or lens holder to move the camera.

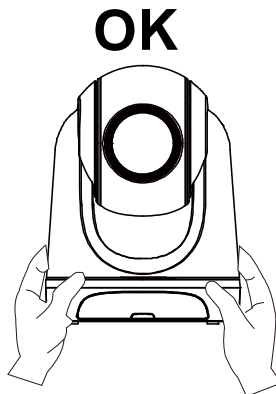
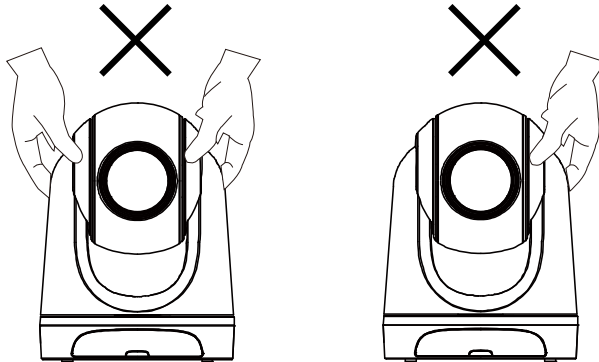

More Help

For FAQs, technical support, software and user manual download, please visit:

Global & European Headquarters: <https://www.aver.com/download-center>

USA: <https://www.averusa.com/education/support/>

Contact Information

Global

AVer Information Inc.

<https://www.aver.com>

8F, No.157, Da-An Rd., Tucheng Dist., New Taipei City 23673, Taiwan

Tel: +886 (2) 2269 8535

European Headquarters

AVer Information Europe B.V.

<https://www.avereurope.com>

Westblaak 140, 3012KM, Rotterdam, Netherlands

Tel: +31 (0) 10 7600 550

Technical support: eu.rma@aver.com

USA

AVer Information Inc.

<https://www.averusa.com>

668 Mission Ct., Fremont, CA 94539, USA

Tel: +1 (408) 263 3828

Toll-free: +1 (877) 528 7824

Technical support: support.usa@aver.com







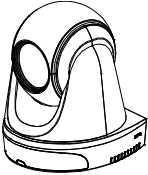
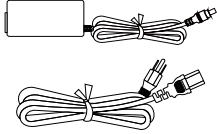
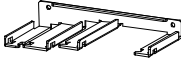
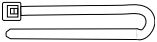

Contents

| | |
|--|----|
| Package Contents..... | 1 |
| Camera Mount Suggestions (Optional Accessories)..... | 1 |
| Product Introduction..... | 2 |
| Overview..... | 2 |
| LED Indicator..... | 2 |
| Pan and Tilt Angle..... | 3 |
| Dimension..... | 3 |
| Cable Fixing Plate Installation..... | 4 |
| Device Connection..... | 5 |
| PoE+ Connection..... | 5 |
| HDMI Connection..... | 6 |
| Audio Input Connection..... | 7 |
| Ceiling Mount Installation (Optional)..... | 8 |
| Wall Mount Installation (Optional)..... | 9 |
| Tracking Setup..... | 11 |
| Remote Control..... | 12 |
| Hot Key..... | 13 |
| Set Up the Camera..... | 13 |

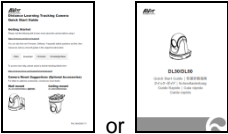
| | |
|---|----|
| Set Up IP Address of the Camera | 13 |
| If there is DHCP environment | 13 |
| Or if you want to configure by yourself | 13 |
| Web Setup | 14 |
| Use the AVer IPCam Utility to Find the Camera | 14 |
| Make a Connection to the Camera via Browser | 15 |
| Live View..... | 16 |
| Snapshot | 16 |
| Pan-Tilt-Zoom Control..... | 17 |
| Manual Pan-Tilt Speed Adjustment..... | 17 |
| Focus | 18 |
| Preset Position | 18 |
| Tracking Control..... | 19 |
| Settings..... | 20 |
| Tracking Settings | 20 |
| Tracking Control..... | 20 |
| Presenter..... | 21 |
| Zone | 22 |
| Camera Settings | 24 |
| Camera Control..... | 24 |

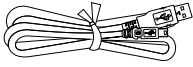
| | |
|----------------------|----|
| Preset..... | 24 |
| Exposure | 25 |
| Image Process | 25 |
| Video & Audio..... | 26 |
| Network | 27 |
| System | 28 |
| FAQ..... | 29 |
| Specification* | 30 |
| DL30 | 30 |

Package Contents

| | | | |
|---|---|---|--|
| Camera Unit | Power Adapter & Power Cord | Cable Fixing Plate | Cable Ties (x4) |
|  |  |  |  |
| M2 x 4mm Screws (x2) | Quick Start Guide | Remote Control | USB Cable |
|  |  |  |  |
| 1/4"-20, L=7.5mm Screw | User Manual* | Warranty Card* | |
|  |  |  | |

*Only for Japan

Camera Mount Suggestions (Optional Accessories)

For details on optional accessories, consult your local dealer.

Wall mount

USA: Part#PTMLTWM01

Other countries: Part#60S5000000AC

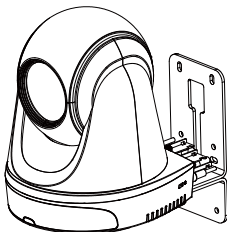

Ceiling mount

USA: Part#PTMLTCM02

Other countries: Part#60S5000000AB

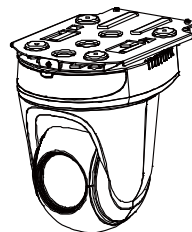

Product Introduction

Overview

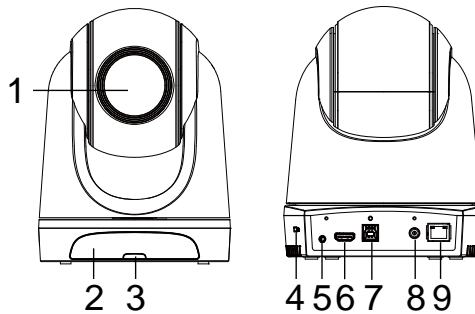

| | | |
|-------------------|---------------------|-------------------|
| (1) Camera Lens | (4) Kensington Lock | (7) USB Port |
| (2) IR Sensor | (5) Audio In* | (8) DC Power Jack |
| (3) LED Indicator | (6) HDMI Port** | (9) PoE+ Port*** |

*Line input level: 1Vrms (max)

*Mic input level: 50mVrms (max); Supplied voltage: 3.3V

**DL30 does not support HDMI port.

***Only support IEEE 802.3at PoE+ standard.

LED Indicator

| LED | Status |
|---------------------------------|-----------------------------------|
| Blue (Blinking every 2 seconds) | Tracking On |
| Blue (Solid) | Normal Operation and Tracking Off |
| Orange (Blinking) | Camera Initialization |
| Orange (Solid) | Standby Mode |
| Red (Blinking) | Firmware Update |

Pan and Tilt Angle

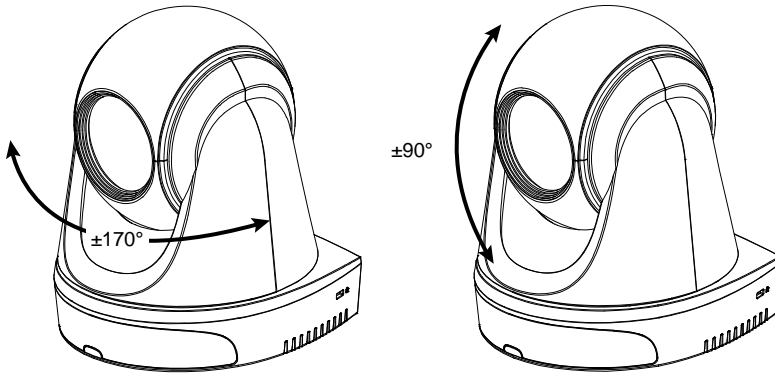

Dimension

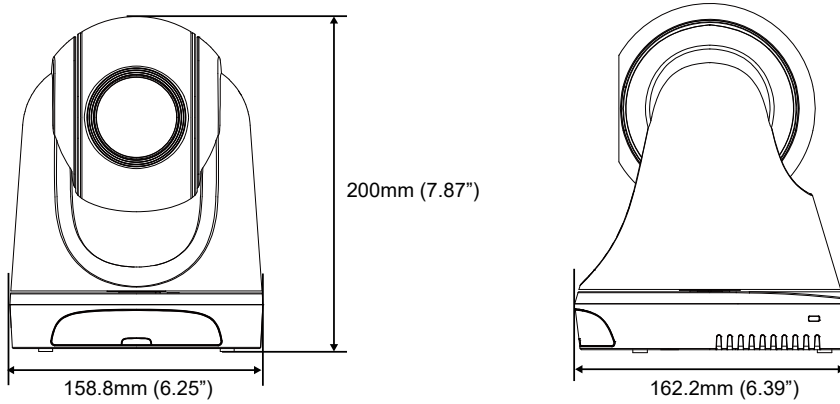

Cable Fixing Plate Installation

- 1 Secure the cable fixing plate to the camera with two M2 x 4mm screws in the package.

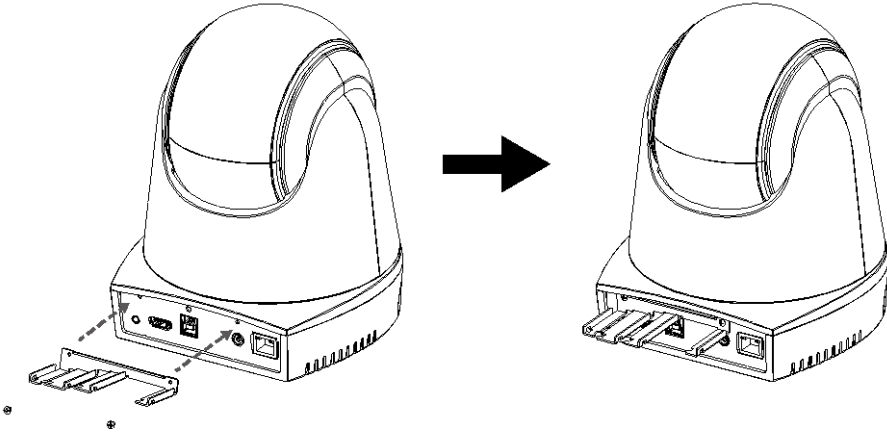

- 2 Plug in cables.

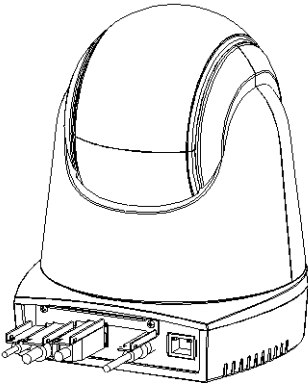

- 3 Use four cable ties in the package to secure the cables and cable fixing plate.

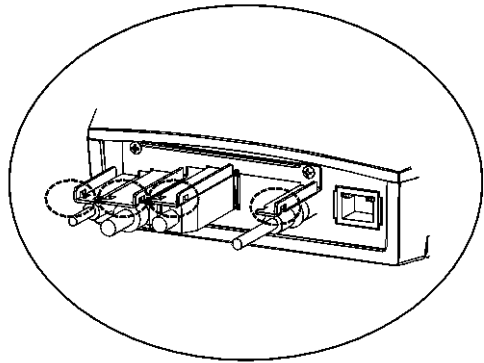

[Note] DL30 does not support HDMI port.

Device Connection

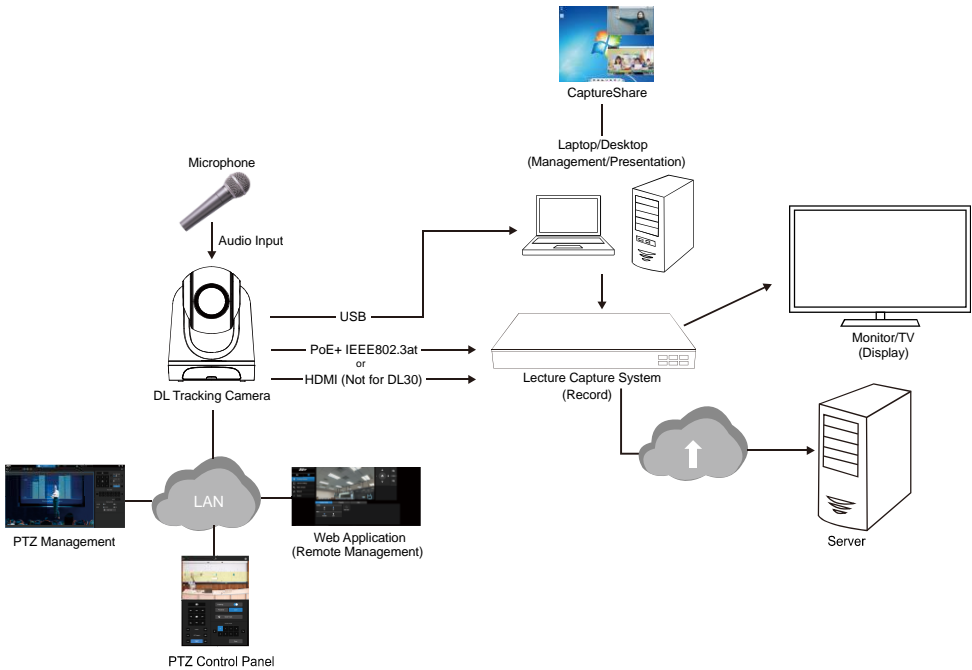

PoE+ Connection

Connect the camera to the router or switch through the PoE+ port.

[Note] Only support IEEE 802.3at PoE+ standard.

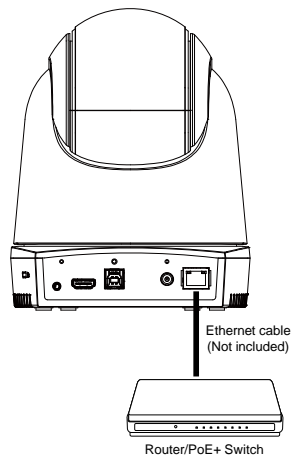

HDMI Connection

Use the HDMI cable to connect with monitor or TV for video output.

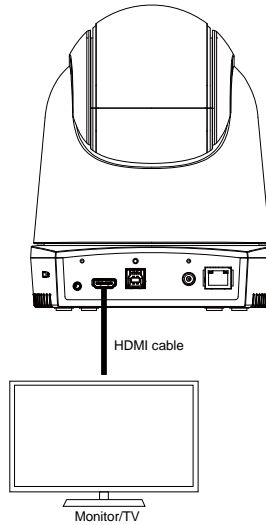

[Note]

1. DL30 does not support HDMI port.
2. HDMI monitor can be connected to camera and output live video. Assuming HDMI monitor is well connected before the camera is turned on, the OSD menu will be displayed on HDMI monitor in default.

Audio Input Connection

Connect the audio device for audio receiving.

[Note]

1. Line input level: 1Vrms (max)
2. Mic input level: 50mVrms (max); Supplied voltage: 3.3V
3. Because video conferencing software such as Google Hangouts (Windows), Skype (Mac), or Teams (Windows and Mac) can automatically adjust volume, the user might experience randomly unstable volume while using the camera.

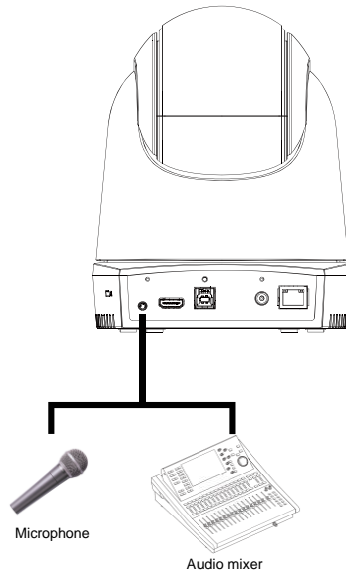

Ceiling Mount Installation (Optional)

1. Use two M2 x 4mm screws (in the DL camera package) to secure the cable fixing plate (in the DL camera package) to the camera. Plug in cables. Use four cable ties (in the DL camera package) to secure the cables and cable fixing plate.
2. Use four M4 (L≥10mm) screws (not supplied) to secure the mount bracket on the ceiling.
3. Use three 1/4"-20, L=7.5mm screws (in the ceiling mount kit) to install another mount bracket on the camera.
4. Slide the mount bracket with the camera into the mount bracket secured on the ceiling.
5. Use three M3 x 6mm screws (in the ceiling mount kit) to secure the camera.

①

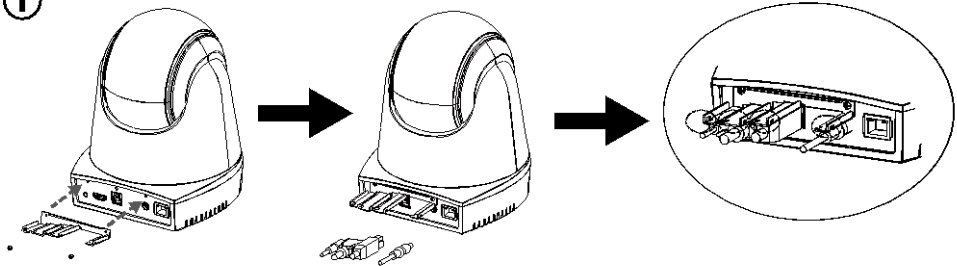

②

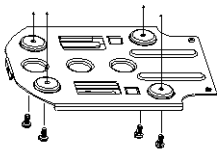

③

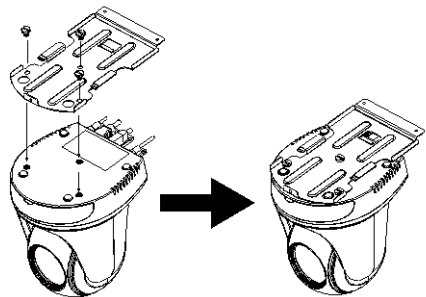

④

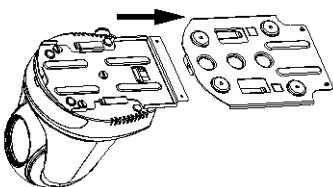

⑤

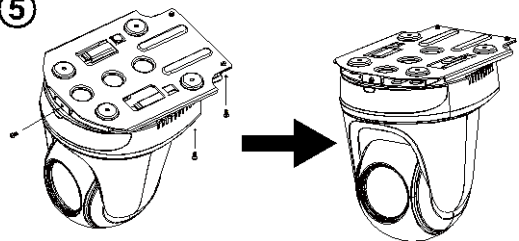

Wall Mount Installation (Optional)

1. Use two M2 x 4mm screws (in the DL camera package) to secure the cable fixing plate (in the DL camera package) to the camera. Plug in cables. Use four cable ties (in the DL camera package) to secure the cables and cable fixing plate.
2. Use the drilling paper included in the package to drill the holes in the wall where the user wants to mount the camera.
3. Use the screws (not included) to secure the L-mount bracket on the wall.

[Note] For cement wall: M4 x 20mm self-tapping screws (x4) + plastic conical anchor

For wooden wall: M4 x 20mm self-tapping screws (x4)

4. Then, assemble the L-mount brackets + with 2 screws (M4 x 8mm, included in the package).

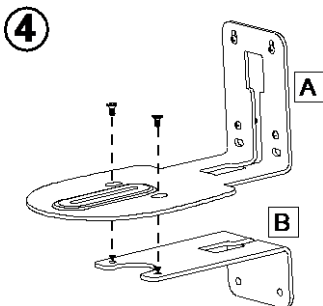
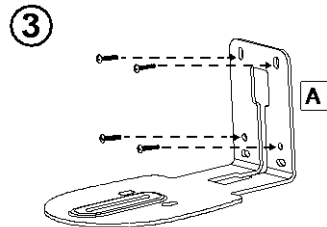
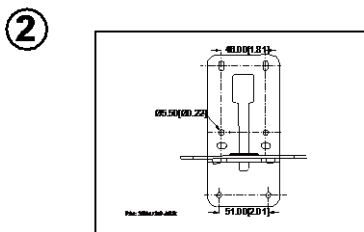
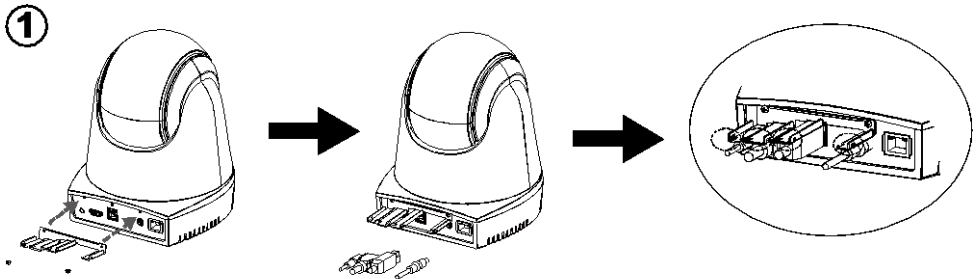

5. After assembling the L-mount brackets, use the screws (not included) to secure the lower part of L-mount brackets on the wall.

[Note] For cement wall: M4 x 20mm self-tapping screws (x2) + plastic conical anchor

For wooden wall: M4 x 20mm self-tapping screws (x2)

6. Pass the cables through the hole on the L-mount brackets and connect the cables to corresponding connection ports.
7. Use the remaining screw (1/4"-20, L=7.5mm, included in the package) to secure the camera on the L-mount brackets.

5

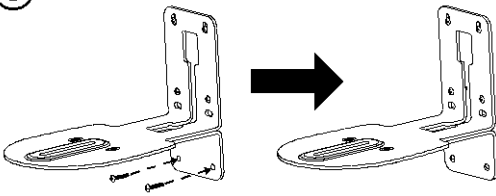

6

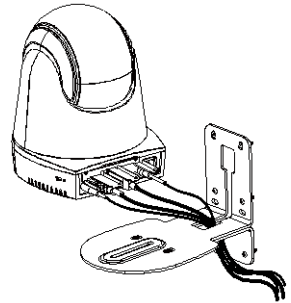

7

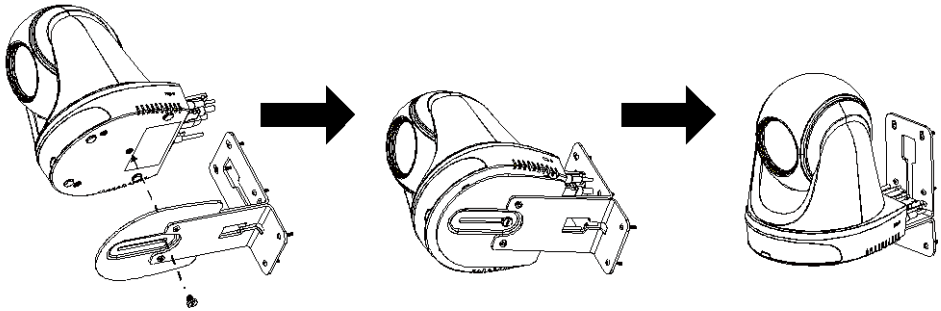

Tracking Setup

- Distance range to podium: 8~9m is suggested.
- Tracking distance for upper body: 2~16m; tracking distance for full body: 3~28m.
- Suggested setup position: center of classroom.
- Install height range (from floor): 2~3m; 2.4m is suggested.
- No human outline on poster/screen/monitor/TV in the background.
- No more than three people in a single camera view.

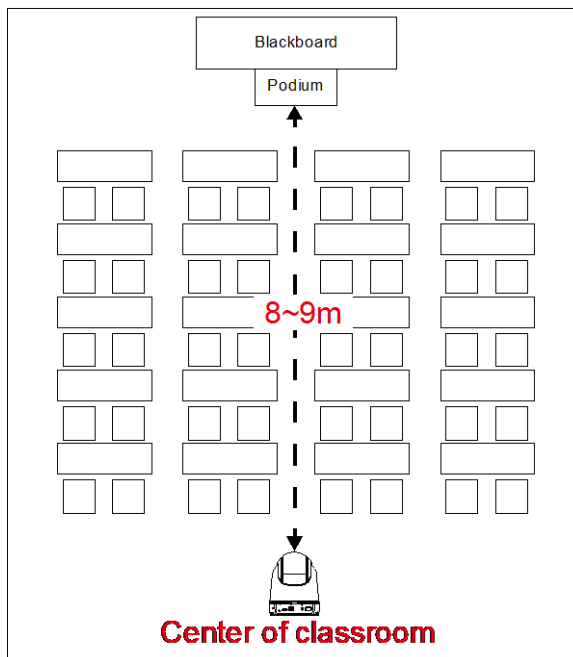

Remote Control

The remote control requires two “AAA” size batteries. Make sure batteries are installed properly before use.

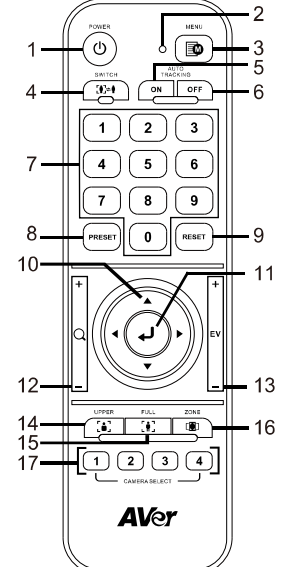
|  | Name | Function |
|---|------------------------|--|
| 1 | (1) Power | Turn the unit on/standby/privacy: <ul style="list-style-type: none"> ■ Press once to turn on privacy mode. Press again to turn off privacy mode. ■ Long press for 3 seconds to turn on standby mode. Short press again to turn off standby mode. |
| 2 | (2) Remote Control LED | It will be on when pressing other buttons. |
| 3 | (3) Menu | Open and exit the OSD menu. [Note] DL30 does not support OSD menu. |
| 4 | (4) Switch | Switch from presenter to another presenter. |
| 5 | (5) Auto Tracking On | Turn on auto tracking. |
| 6 | (6) Auto Tracking Off | Turn off auto tracking. |
| 7 | (7) Number buttons | Use for setting the preset position 0~9. |
| 8 | (8) Preset | User can use below two ways to set the preset position: a) press “Preset” + “Number button (0~9)” simultaneously, or b) hold “Preset” then press “Number button (0~9)”. Remote control LED and camera button LED will not light when pressing Preset button alone. |
| 9 | (9) Reset | User can use below two ways to cancel pre-configured preset position: a) press “Reset” + “Number button (0~9)” simultaneously, or b) hold “Reset” then press “Number button (0~9)”. Remote control LED and camera button LED will not light when pressing Reset button alone. |
| 10 | (10) ▲, ▼, ◀, & ▶ | Pan and tilt the camera. Pan/Tilt speed by remote control is fixed. You may change pan/tilt speed by using web browser. For setting details of web browser, please refer to user manual. |
| 11 | (11) Enter | After opening the OSD menu, confirm the selection or make a selection in OSD menu. |
| 12 | (12) Zoom In/Out | Zoom in/out. Zoom in/out speed by remote control is fixed. You may change zoom in/out speed by using web browser. For setting details of web browser, please refer to user manual. |
| 13 | (13) EV +/- | EV level adjustment. |
| 14 | (14) Upper Body | Tracking mode switches to Presenter Mode when pressing Upper Body button, and presenter's size on screen is upper body. |
| 15 | (15) Full Body | Tracking mode switches to Presenter Mode when also pressing Full Body button, and presenter's size on screen is full body. |
| 16 | (16) Zone | Tracking mode switches to Zone Mode when pressing Zone button. |

| | |
|--------------------|---|
| (17) Camera Select | CAM1 to CAM4 buttons. Select a camera to operate. Once a camera is selected, the CAM button LED will be on when pressing other buttons. |
|--------------------|---|

Hot Key

Press certain button on remote controller to perform hot key function.

| Button | Action | Function |
|--------|------------------------------|--|
| 5 | Press five times (55555) | Turn on DHCP. |
| 7 | Press seven times (7777777) | Show the tracking indicator. When the hot key takes effect, you will see the tracking indicator on the target outline. |
| 8 | Press eight times (88888888) | Set DL camera's IP address as default IP (192.168.1.168). |
| 9 | Press nine times (999999999) | Password reset mechanism: When the hot key takes effect, the password of entering Web UI will go back to the default "admin". |

Set Up the Camera

Set Up IP Address of the Camera

DL camera's default setting is DHCP on.

If there is DHCP environment

1. Connect your camera to the internet and wait for your camera to get IP address.
2. From your server, you can find your new camera IP address.
3. If necessary, modify the IP address.

Or if you want to configure by yourself

1. Use the remote control and press the button "8" eight times to switch to Static IP mode.
2. The default IP for the camera would be set to 192.168.1.168.
3. Set up your computer with static IP 192.168.1.x and then type in 192.168.1.168 in your web browser to access the camera.

Web Setup

Connect the camera from a remote site through the internet.

Use the AVer IPCam Utility to Find the Camera

To find the IP address of your cameras, you can execute the IPCam Utility installer. Follow the below steps to find the IP address of the camera.

1. Download the IPCam Utility from <https://www.aver.com/download-center> (Global & European Headquarters) or <https://www.averusa.com/education/support> (USA).
2. Run the IPCam Utility.
3. Click Search, and all available devices will be listed on the screen.
4. Select a camera from the list.
5. The corresponding fields of IP address will display.
6. Double-click on the IP address of the camera from the list to connect to the camera through the browser.

[Note] If IPCam utility cannot find the camera, please check following:

1. Please make sure the Ethernet connection of camera is well connected.
2. The camera and PC (IPCam utility) are in the same LAN segment.

AVer IPCam Utility v2.7.1029.34

Network Device: Intel(R) Ethernet Connection (12) I219-V [Search]

Login: User ID [] Password []

Network Setting | Date/Time Setting | Maintenance | Import/Export Config

Search Result: [Select All]

| No. | Status | Progress | Model Name | Device Name | FW version | IPv4 Address | MAC Address | IPv6 A |
|----------------------------|---------|----------|-------------|-------------|-------------|-----------------|-------------------|------------|
| <input type="checkbox"/> 1 | Working | | VC520 Pro2 | VC520 Pro2 | 0.0.7200.36 | 10.100.93.19:80 | 00:18:1a:94:62:55 | []:80 |
| <input type="checkbox"/> 2 | Working | | VB130 | VB130 | 0.0.7300.10 | 10.100.93.14:80 | 36:69:88:00:00:99 | []:80 |
| <input type="checkbox"/> 3 | Working | | DL30 | DL30 | 7.0.0000.08 | 10.100.93.18:80 | 00:18:1a:06:e4:be | [fe80:]:80 |
| <input type="checkbox"/> 4 | Working | | VB130 | VB130 | 0.0.7300.13 | 10.100.93.32:80 | 36:69:88:33:34:43 | []:80 |
| <input type="checkbox"/> 5 | Working | | CAM520 Pro2 | CAM520 Pro2 | 0.0.7200.36 | 192.168.1.33:80 | 00:18:1a:ba:02:db | []:80 |

Settings: Device Name: [] Start IP Address: [. . .] End IP Address: [. . .] Subnet Mask: [. . .] Gateway: [. . .] Primary DNS: [. . .] Secondary DNS: [. . .]

DHCP Static IP

*Auto search will start after settings changed!
 Don't start auto search this time!

[Apply]

Make a Connection to the Camera via Browser

Open the browser and enter the IP address of the camera. The PC/laptop requires an internet access. After connecting to the camera, enter the user account and password (default is **admin/admin**) to log in Web.



[Note] User will be asked to set a new account and password after first login. Please use the new account and password to log in later.

The image shows a 'Login' dialog box with a dark background. At the top, it says 'Login'. Below that, it prompts the user: 'Please change new Name & Password for login'. There are two input fields: 'Login Name' with a person icon to its left, and 'Login Password' with a lock icon to its left. At the bottom, there are two buttons: 'Cancel' and 'Change'.

Live View

In live view, the user can make a snapshot, set up camera control (zoom in/out, camera direction control, pan/tilt speed, focus), view preset, and tracking control (on, off, tracking mode).





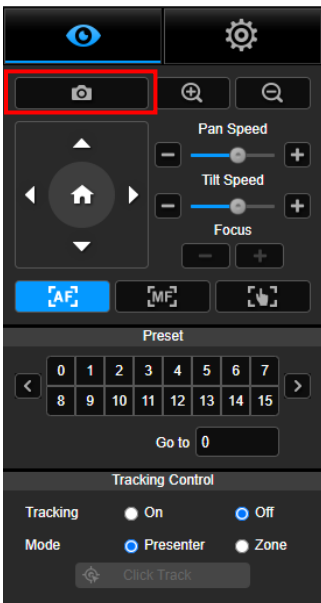

Snapshot



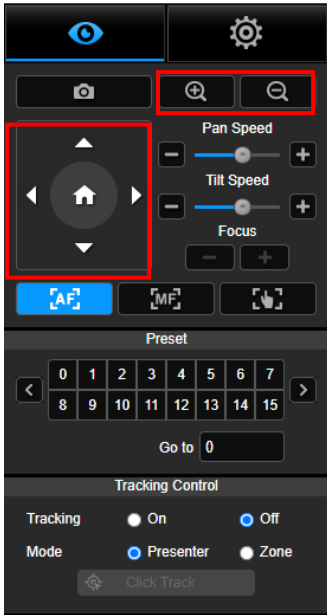



Select the camera button to make a snapshot and download the file to local storage.

Pan-Tilt-Zoom Control



To operate the PTZ Camera motion, use , , ,

and  to adjust the camera view position and use 

and  to zoom. Select  to go back to default position.

Manual Pan-Tilt Speed Adjustment

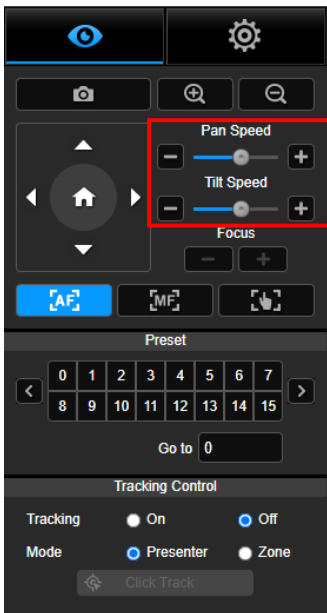

Adjust the speed of manual Pan-Tilt.

[Note] The max manual pan speed is 90°/sec. The max manual tilt speed is 45°/sec.

Focus



Switch to auto (AF) or manual (MF) focus. The manual focus use “+” and “-” to adjust focus. Select “+” to adjust focus to the far end and focusing on a far subject; select “-” to adjust focus to near end and focusing on a near subject.

One push focus: By clicking the  button to adjust Lens focus automatically once.

Preset Position

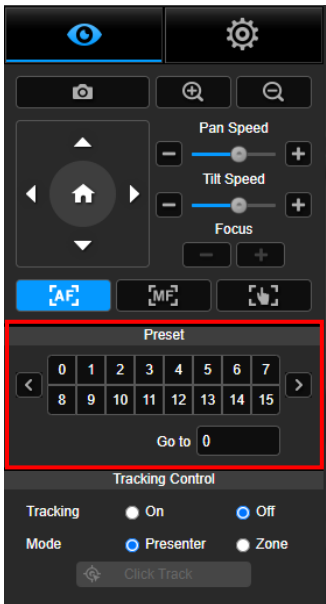

Select the number to view preset positions. User can also enter preset position number (0~255) in “Go to” column directly for a quickly calling section.

Tracking Control

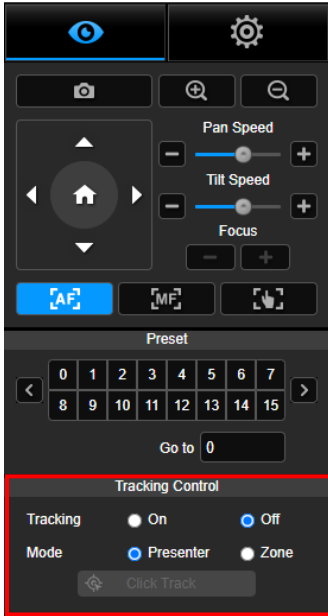

Enable/disable tracking function, select tracking mode, and operate one-click tracking function.

- **Tracking mode** (refer to [Tracking Settings](#) section for setup)

- **Presenter:** Camera will start tracking when object enters the tracking point.

- [Note]** Tracking point under presenter mode: default set is preset 1. When preset 1 is not set, tracking point is home position.

- **Zone:** Camera will start tracking when object is moving between the preset tracking block area.

- **Click Track:** This function allows user to change tracking object while auto tracking.

1. Select **Click Track** button. A red frame is targeted on the tracking object and blue frames are targeted on other objects on the live screen.

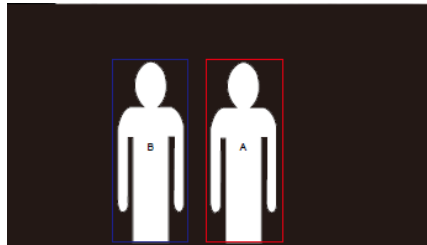

2. To select a new target, just simply click the object on the live screen.

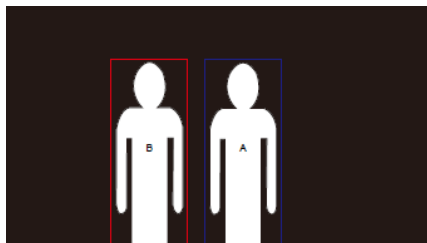

Settings

Tracking Settings

Enable/disable tracking function, set up tracking mode, operate one-click tracking function and pan/tilt/zoom the camera.

[Note] Tracking will be off when activating pan/tilt/zoom function.

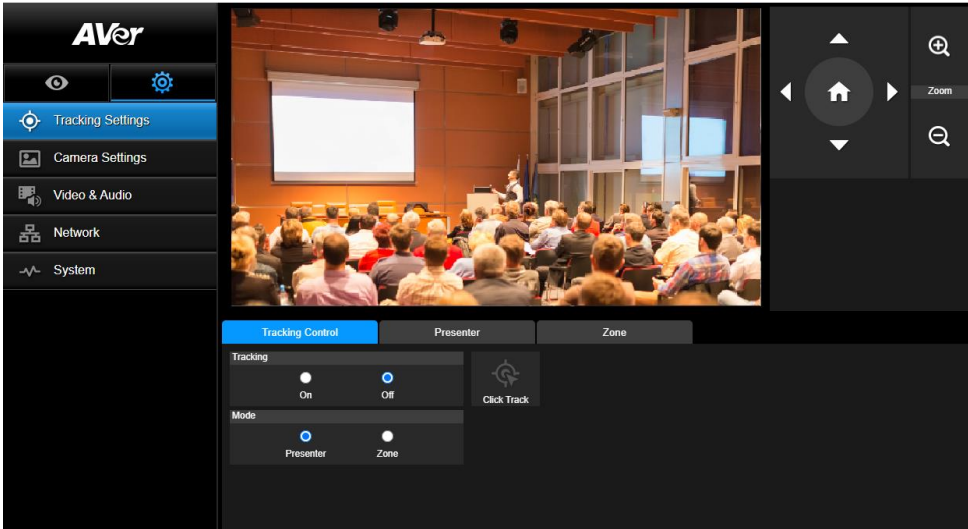

Tracking Control

Enable/disable tracking function, select tracking mode, operate one-click tracking function (refer to [Tracking Control](#) section), and pan/tilt/zoom the camera.

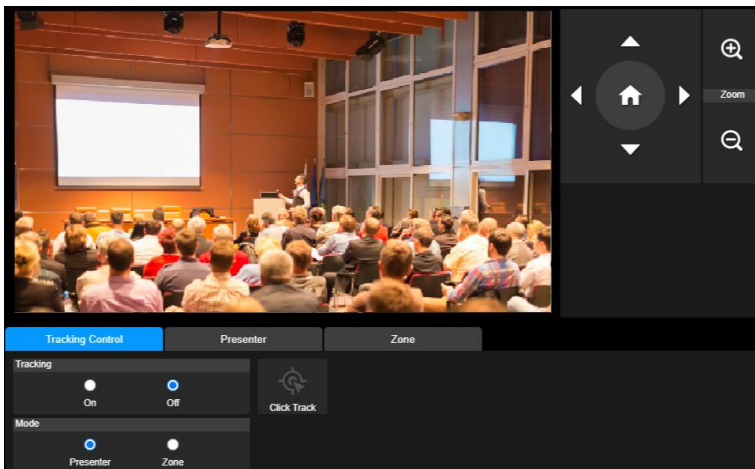





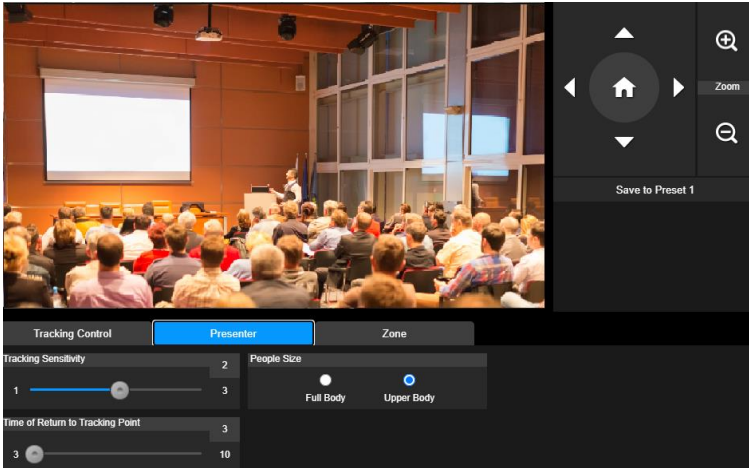

Presenter

Select the “**Presenter**” tab in Tracking Settings interface.



Camera will start tracking when object enters the tracking point.

1. Use , , , ,  and  to adjust the camera to tracking point.
2. Then, select **Save to Preset 1** to save the tracking point.
3. **Tracking Sensitivity**: sets the sensitive level of tracking. Move bar to set the value. The current value is displayed at upper right corner.
4. **Time of Return to Tracking Point**: sets the idle time for camera return to tracking point. Move bar to set the value. The current value is displayed at upper right corner.
5. **People Size**: selects the people in full or upper body while tracking.

[Note] Tracking point under presenter mode: default set is preset 1. When preset 1 is not set, tracking point is home position.

Zone



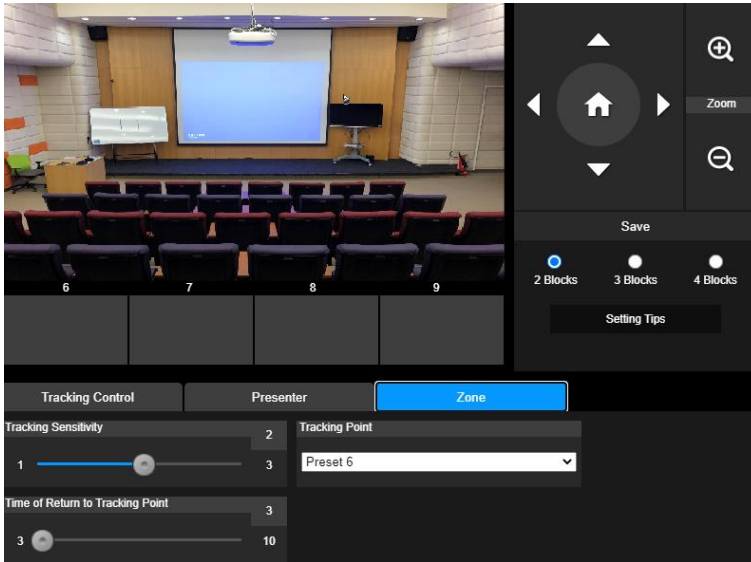



Select the “Zone” tab in Tracking Settings interface.

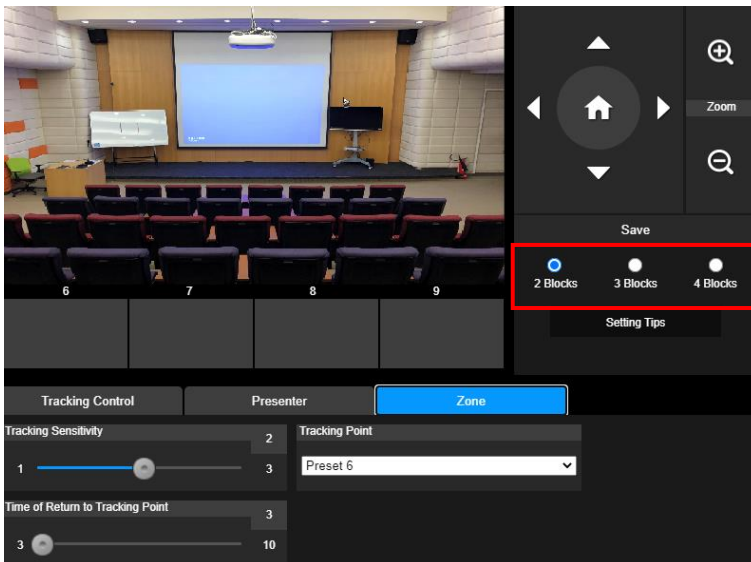

Set up 2 to 4 block areas for the camera. Each block is corresponding to one preset position. Camera will switch between preset positions when the presenter enters different blocks.

1. Select the “Number of block” (2, 3, or 4).



2. Select the block and set the preset positions in order (preset 6 to preset 9). Use , , , ,  and  to move the camera to wanted position and select "Save" to save the preset position. And, a snapshot of the preset image will show at corresponding image display box. Repeat the steps to set another preset position.

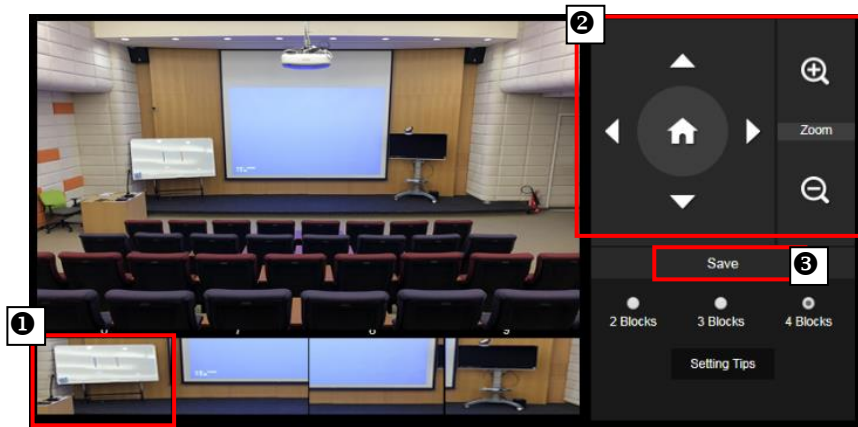

[Notes]

- Set each preset overlapping with the next one (one man width).
 - Set the preset view to clearly see at least 60% upper body of the presenter to ensure tracking accuracy. Make sure no other human-outline poster/TV/monitor in the background.
3. **Tracking Sensitivity:** sets the sensitive level of tracking. Move bar to set the value. The current value is displayed at upper right corner.
 4. **Time of Return to Tracking Point:** sets the idle time for camera return to tracking point. Move bar to set the value. The current value is displayed at upper right corner.

Camera Settings

Camera Control



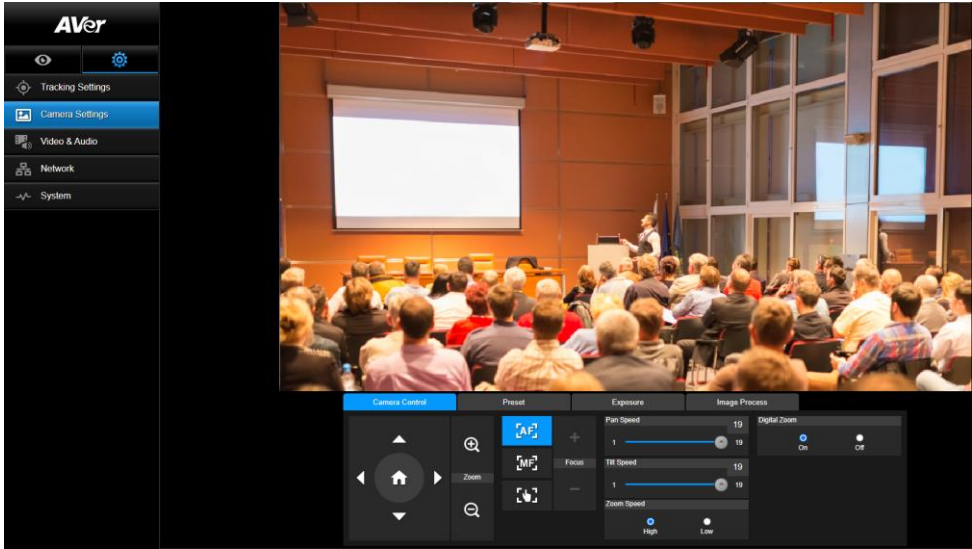

The user can set up camera control (zoom in/out, camera direction control, focus, pan/tilt/zoom speed), and enable/disable digital zoom function.

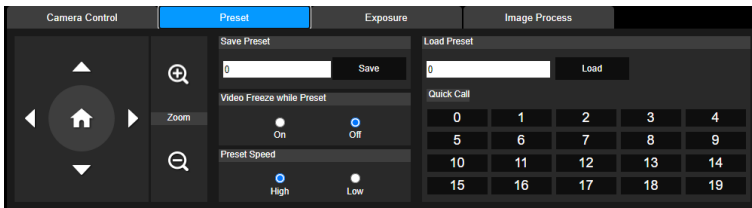

Preset

Set up preset position and view preset position.



1. Select the "Preset" tab in Camera Settings interface.
2. Use , , , and  to adjust camera view position.
3. Enter preset position number (0~255) in **Save Preset** column and select "**Save**" to save the position.
4. To call the preset position, enter a preset number (0~255) in **Load Preset** column or select the preset number (0~19) from **Quick Call** section.
5. **Video Freeze while Preset:** turns on/off the screen view freeze function. When "**Video Freeze while Preset**" is on, during the preset operation, the screen will freeze until the operation is done.
6. **Preset Speed:** selects the preset speed.

[Note] Preset point value includes: pan/tilt/zoom, exposure, shutter, iris, ev, brightness, gain, slow, shutter, white balance, focus, focus position, digital zoom, and R&B gain.

Exposure

Select the “**Exposure**” tab in camera settings interface.

Set up the exposure type - Full Auto or Manual and relevant settings.

[Note] If IFP seems blurry in live view, please set up web setting as following: **Camera Settings > Exposure > Manual > Shutter Speed > 1/60**.

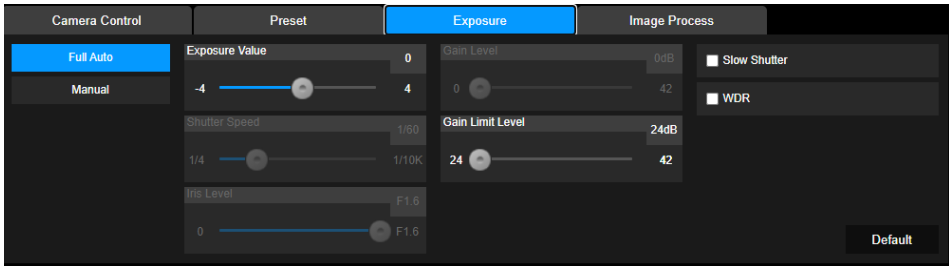
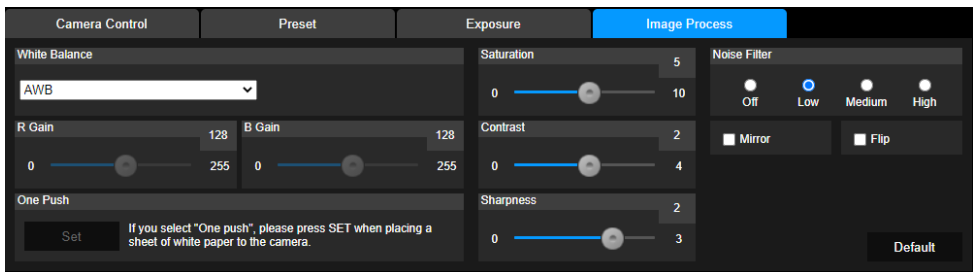

Image Process

Select the “**Image Process**” tab in camera settings interface.

Set up the white balance, saturation, contrast, sharpness, noise filter, mirror, and flip.



Video & Audio

The user can set up Power Frequency, Video Mode, Stream Video Output, Bitrate, Encoding Type, Framerate, I-VOP Interval (S), Rate Control, Audio Input Type, Audio Volume, and Sampling Rate.

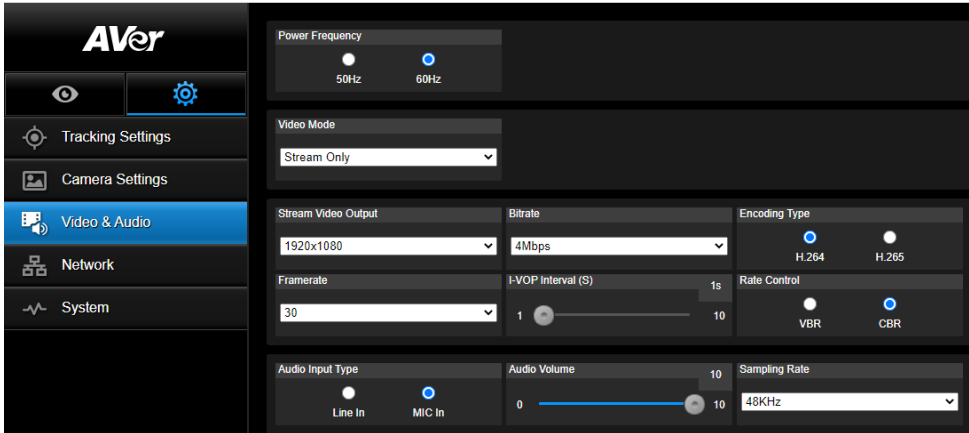

3 types of video modes can be selected and each one only supports single function,

- **Stream Only:** supports RTSP/RTMP only.
- **USB Only** (factory default): supports USB port output only; not compatible with AVer PTZ Management and PTZ Control Panel. Please switch to other two modes if necessary.
- **USB + Streaming:** supports both RTSP/RTMP and USB output at the same time.

[Note] If Video mode is in “Stream Only”, the frame rate is up to 60fps; in “USB + Streaming” mode, the frame rate is up to 30fps.

Network

Set up IP address of camera – DHCP or static IP, Netmask, Gateway, and DNS. After setting, select “**Confirm**” to apply settings.

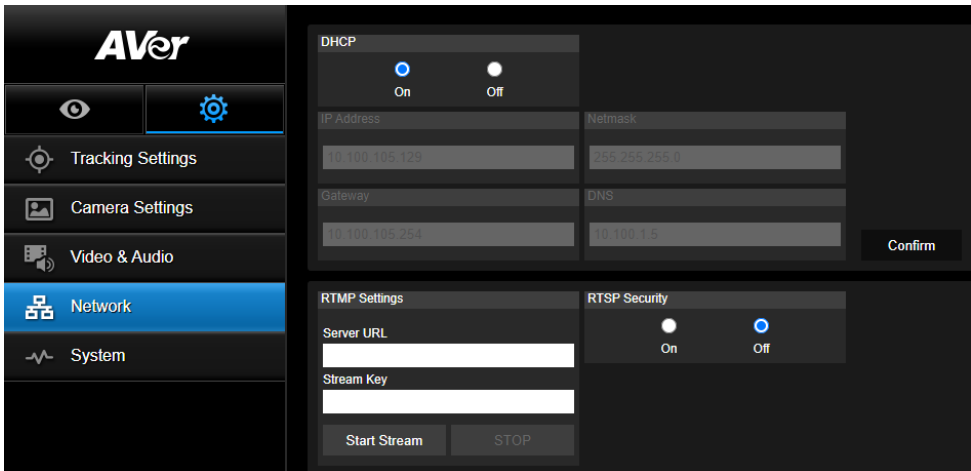

Follow below steps to set up RTMP:

1. Get the RTMP server URL and stream key from the broadcasting platform and enter in “**Server URL**” and “**Stream Key**” column.
2. Select “**Start Stream**” to begin uploading the live video of the camera to the broadcasting platform.
3. Select “**STOP**” to stop uploading the video.

[Note] To get the RTMP server URL and stream key, please refer to the instruction of broadcasting. RTSP Security for user to set a security key number for streaming.

System

The system information of camera is displayed in this page, including Model Name, IP Address, Serial Number, MAC Address, and Firmware Version.

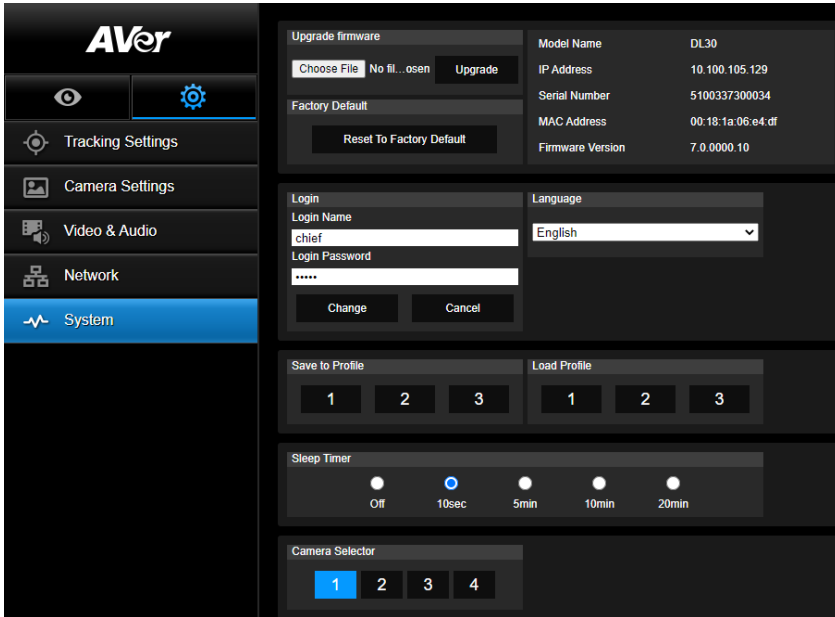

- **Upgrade firmware:** follows below steps to upgrade the firmware.
 1. Download the newest firmware from <https://www.aver.com/download-center> (Global & European Headquarters) or <https://www.averusa.com/education/support> (USA).
 2. Connect to the camera through the browser.
 3. Select **System** > **Upgrade firmware** > **Choose File**.
 4. Select the firmware and select the “**Upgrade**” button.
 5. It takes about 5 minutes to finish update. After update, log in the web page again.
- **Factory Default:** clears all values and resets the camera back to factory default values.
- **Login:** the default login name and password are **admin/admin**. To change the login name and password, enter the new login name and password and select the “**Change**” button.
- **Language:** changes the Web UI language.
- **Save to Profile:** saves up to 3 different settings including preset settings values, tracking mode, and tracking setting values of camera.

[Note] The settings of profiles will be cleared after factory reset.
- **Load Profile:** loads up to 3 different settings of camera. After selecting Load Profile, camera will go back to Home position.
- **Sleep Timer:** sets the duration of sleep timer. When there is no UVC and RTSP connection and timer is up, camera will enter sleep mode.
- **Camera Selector:** selects a camera to operate.

FAQ

1. Can I pan, tilt, zoom, and preset when tracking is on?
 - Yes, but tracking will be off when activating pan/tilt/zoom function.
2. Any value will be auto saved and shifted when going to the preset point?
 - Yes, preset point value: PTZ, exposure, shutter, iris, ev, brightness, gain, slow shutter, white balance, focus, focus position, digital zoom, R&B gain.
3. What value will be saved in profile?
 - Profile saving value: 1) preset setting values, 2) tracking mode, and 3) tracking setting values.
4. How to switch from Zone mode to Presenter mode?
 - You may switch to Presenter mode by simply pressing Upper or Full button on your remote control.
5. Why does my IFP seem blurry in live view?
 - Please set up web setting as following: **Camera Settings > Exposure > Manual > Shutter Speed > 1/60.**

Specification*

DL30

| Camera | |
|----------------------------|--|
| Image Sensor | 1/2.8" CMOS |
| Effective Picture Elements | 2 Megapixels |
| Output Resolutions | USB: 1080P60 (max) RTSP: 1080P60 (max) |
| Minimum Illumination | 0.5 Lux (IRE50, F1.6, 30FPS) |
| S/N Ratio | ≥ 50dB |
| Gain | Auto, Manual |
| TV Line | 800 (Center/Wide) |
| Shutter Speed | 1/4 s to 1/10,000 s (60Hz) 1/3 s to 1/10,000 s (50Hz) |
| Exposure Control | Full Auto, Manual, WDR |
| White Balance | Auto, Manual |
| Optical Zoom | 12X |
| Digital Zoom | 2X |
| Viewing Angles | DFOV: 84.1° (Wide) to 7.8° (Tele) |
| | HFOV: 76.5° (Wide) to 6.8° (Tele) |
| | VFOV: 47.3° (Wide) to 3.8° (Tele) |
| Focal Length | f = 3.9 mm (Wide) to 46.8 mm (Tele) |
| Aperture (Iris) | F = 1.6 (Wide) to 2.8 (Tele) |
| Minimum Working Distance | 0.3 m (Wide), 1.5m (Tele) |
| Pan/Tilt Angles | Pan: ±170°, Tilt: ±90° |
| Pan/Tilt Speed (Manual) | Pan: 1° to 90°/sec, Tilt: 7.85° to 45°/sec |
| Preset Speed | Pan: 120°/sec, Tilt: 110.84°/sec |

| | |
|-----------------------------------|--|
| Preset Positions | 10 (IR), 256 (IP) |
| Camera Control - Interface | IP, USB |
| Camera Control - Protocol | VISCA (IP), CGI (IP), USB |
| Noise Reduction | 2D/3D NR |
| Image Effect | Flip, Mirror |
| WDR | Yes |
| Power Frequency | 50 Hz, 60 Hz |
| AI Auto Tracking Functions | |
| Tracking Mode | Presenter Mode, Zone Mode |
| Sleep Mode | |
| Sleep Mode | Yes (Control by Web Page and CaptureShare) |
| Audio | |
| Channel | 2ch Stereo |
| Codec | AAC, PCM |
| Sample Rate | AAC (48/32/16/8Khz), PCM (48Khz) |
| Interface | |
| Video Outputs | IP, USB |
| Audio Outputs | IP, USB |
| Audio Inputs | MIC in, Line in |
| General | |
| Power Requirement | AC100 - 240V to DC12V 2A or above |
| Power Consumption | 12W |
| PoE+ | Yes |
| Dimensions (W x D x H) | 158.8mm x 162.2mm x 200mm |
| Net Weight | 1.617±0.1KG |
| Application | Indoor |
| Tally | NA |

| | |
|--------------------------------|--|
| Security | Kensington slot |
| Operating Conditions | Temperature: 0°C to +40°C Humidity: 20% to 80% |
| Storage Conditions | Temperature: -20°C to +60°C Humidity: 20% to 95% |
| IP Streaming | |
| Resolution | 1080P (60FPS) |
| Network Video Compress Formats | H.264, MJPEG (Web Page) |
| Maximum Frame Rate | 60FPS |
| Bit-rate Control Modes | VBR/CBR |
| Range of Bit-rate Setting | 512 Kbps to 32 Mbps |
| Network Interface | 10/100 Base-T |
| Multi-stream Capability | 2 |
| | (RTSP/Web Page), 1080P60FPS (max) |
| | (RTSP/USB), 1080P60FPS (max) |
| | 3 |
| | (RTSP/Web Page/USB), 1080P30FPS (max) |
| Network Protocols | IPv6, IPv4, TCP, UDP, ARP, ICMP, IGMP, HTTP, DHCP, RTP/RTCP, RTSP, RTMP, VISCA over IP |
| NDI® HX Capability | NA |
| USB | |
| Connector | USB 3.1 Gen1 Type B, backward compatible with USB 2.0 |
| Video Format | MJPG/YUY2 |
| Maximum Video Resolution | 1080P60 |
| USB Video Class (UVC) | UVC 1.1 |
| USB Audio Class (UAC) | UAC 1.0 |
| Web UI | |
| Live Video Preview | Yes |

| | |
|--|---|
| Camera PTZ Control | Pan, Tilt, Zoom, Focus, Preset Control |
| Camera/Image Adjustment | Exposure/White Balance/Picture |
| Network Configuration | DHCP, IP Address, Gateway, Subnet mask, DNS |
| Software Tools | |
| Single Camera Control | AVer CaptureShare (via USB), AVer PTZ Control Panel (via IP) |
| Multi-Camera Control and Configuration | AVer PTZ Management (via IP) |
| Device IP Searching | AVer CaptureShare/Information AVer PTZ Control Panel/Auto Search AVer PTZ Management/Setup/Device/Add/Auto Search |
| Warranty | |
| Camera | 3 Years |
| Accessories | 1 Year |

*Specifications are subject to change without prior notice.