

Dual Link DVI/USB Extender SRX™

**Extend DVI-D dual link video plus four USB devices up to 165 feet (50m) from your computer.**

Uses just one length of Category 6a or 7 twisted-pair cable.



**Customer  
Support  
Information**

Order toll-free in the U.S.: Call 877-877-BBOX (outside U.S. call 724-746-5500)  
FREE technical support 24 hours a day, 7 days a week: Call 724-746-5500 or fax 724-746-0746  
[www.blackbox.com](http://www.blackbox.com) • [info@blackbox.com](mailto:info@blackbox.com)

### Trademarks Used in this Manual

Black Box and the Double Diamond logo are registered trademarks, and ServSwitch is a trademark, of BB Technologies, Inc.

Mac is a registered trademark of Apple Computer, Inc.

Linux is registered trademark of Linus Torvalds.

Windows is a registered trademark of Microsoft Corporation.

NetWare is a registered trademark of Novell, Inc.

Sun is a trademark of Sun Microsystems, Inc.

Unix is a registered trademark of UNIX System Laboratories, Inc.

BSD is a registered trademark of UUNet Technologies, Inc.

Any other trademarks mentioned in this manual are acknowledged to be the property of the trademark owners.

We're here to help! If you have any questions about your application or our products, contact Black Box Tech Support at **724-746-5500** or go to **blackbox.com** and click on "Talk to Black Box." You'll be live with one of our technical experts in less than 60 seconds.

### Federal Communications Commission and Industry Canada Radio Frequency Interference Statements

This equipment generates, uses, and can radiate radio-frequency energy, and if not installed and used properly, that is, in strict accordance with the manufacturer's instructions, may cause interference to radio communication. It has been tested and found to comply with the limits for a Class A computing device in accordance with the specifications in Subpart B of Part 15 of FCC rules, which are designed to provide reasonable protection against such interference when the equipment is operated in a commercial environment. Operation of this equipment in a residential area is likely to cause interference, in which case the user at his own expense will be required to take whatever measures may be necessary to correct the interference.

Changes or modifications not expressly approved by the party responsible for compliance could void the user's authority to operate the equipment.

This digital apparatus does not exceed the Class A limits for radio noise emission from digital apparatus set out in the Radio Interference Regulation of Industry Canada.

Le présent appareil numérique n'émet pas de bruits radioélectriques dépassant les limites applicables aux appareils numériques de la classe A prescrites dans le Règlement sur le brouillage radioélectrique publié par Industrie Canada.

## Instrucciones de Seguridad

### (Normas Oficiales Mexicanas Electrical Safety Statement)

1. Todas las instrucciones de seguridad y operación deberán ser leídas antes de que el aparato eléctrico sea operado.
2. Las instrucciones de seguridad y operación deberán ser guardadas para referencia futura.
3. Todas las advertencias en el aparato eléctrico y en sus instrucciones de operación deben ser respetadas.
4. Todas las instrucciones de operación y uso deben ser seguidas.
5. El aparato eléctrico no deberá ser usado cerca del agua—por ejemplo, cerca de la tina de baño, lavabo, sótano mojado o cerca de una alberca, etc.
6. El aparato eléctrico debe ser usado únicamente con carritos o pedestales que sean recomendados por el fabricante.
7. El aparato eléctrico debe ser montado a la pared o al techo sólo como sea recomendado por el fabricante.
8. Servicio—El usuario no debe intentar dar servicio al equipo eléctrico más allá a lo descrito en las instrucciones de operación. Todo otro servicio deberá ser referido a personal de servicio calificado.
9. El aparato eléctrico debe ser situado de tal manera que su posición no interfiera su uso. La colocación del aparato eléctrico sobre una cama, sofá, alfombra o superficie similar puede bloquea la ventilación, no se debe colocar en libreros o gabinetes que impidan el flujo de aire por los orificios de ventilación.
10. El equipo eléctrico deber ser situado fuera del alcance de fuentes de calor como radiadores, registros de calor, estufas u otros aparatos (incluyendo amplificadores) que producen calor.
11. El aparato eléctrico deberá ser conectado a una fuente de poder sólo del tipo descrito en el instructivo de operación, o como se indique en el aparato.
12. Precaución debe ser tomada de tal manera que la tierra física y la polarización del equipo no sea eliminada.
13. Los cables de la fuente de poder deben ser guiados de tal manera que no sean pisados ni pellizcados por objetos colocados sobre o contra ellos, poniendo particular atención a los contactos y receptáculos donde salen del aparato.
14. El equipo eléctrico debe ser limpiado únicamente de acuerdo a las recomendaciones del fabricante.
15. En caso de existir, una antena externa deberá ser localizada lejos de las líneas de energía.
16. El cable de corriente deberá ser desconectado del cuando el equipo no sea usado por un largo periodo de tiempo.
17. Cuidado debe ser tomado de tal manera que objetos líquidos no sean derramados sobre la cubierta u orificios de ventilación.
18. Servicio por personal calificado deberá ser provisto cuando:
  - A: El cable de poder o el contacto ha sido dañado; u
  - B: Objetos han caído o líquido ha sido derramado dentro del aparato; o
  - C: El aparato ha sido expuesto a la lluvia; o
  - D: El aparato parece no operar normalmente o muestra un cambio en su desempeño; o
  - E: El aparato ha sido tirado o su cubierta ha sido dañada.

## Contents

1. Specifications.....	6
2. Welcome.....	7
3. Installation.....	8
3.1 Mounting the modules – desk or rack.....	8
3.1.1 Desk mount.....	8
3.1.2 Rack mount.....	9
3.2 Connections.....	10
3.2.1 Connections at the local module.....	10
3.2.2 Connections at the remote module.....	14
4. Operation.....	17
4.1 General use.....	17
4.2 Video display (EDID) information.....	17
4.3 HDMI 1.3a operation.....	17
4.4 Power and activity indicators.....	18
Appendix A. Troubleshooting.....	19
Appendix B. Safety Information.....	20

# Dual Link DVI/USB Extender SRX

---

## 1. Specifications

Approvals: CE, FCC

Hardware Compatibility: All computers with DVI-D digital video and USB interfaces

Software Compatibility: Operates with all known software and operating systems including Windows®, Linux®, Unix®, BSD, all Sun® OS, all Mac® OS, NetWare®, etc.

Connectors:

(local transmitter) Video: DVI-D female  
USB: USB Type B female  
Audio: 1 x 3.5mm jack socket  
Other: RJ-45 CATx link socket  
Power jack

Connectors:  
(remote receiver) Video: DVI-D female  
USB: (4) USB Type A female  
Audio: 1 x 3.5mm jack socket  
Other: RJ-45 CATx link socket  
Power jack

Operating Temperature: 32 to 104°F (0 to 40°C)

Power adapter(s): Input: 100–240 VAC, 50/60 Hz  
Output: DC jack (5VDC output)

Dimensions

(w): 120mm (4.66")  
(h): 26mm (1.02")  
(d): 75mm (2.94")

Weight: 0.32kg (0.7lbs)

Power requirements: 400mA @ 5VDC

## 2. Welcome

Thank you for choosing the Black Box Dual Link DVI/USB Extender SRX units. These compact modules provide the quickest way to extend high quality dual link DVI digital video plus USB keyboard, mouse and stereo audio with an additional two USB peripherals up to 165 feet (50 meters) away from your computer.

Thanks to our long involvement and investment in extender technology we have succeeded in overcoming the numerous problems associated with extending digital video signals. Using our proprietary transmission techniques these modules can extend all dual link video resolutions up to 2560 x 1600. In effect, these modules can reliably transfer video rates up to 330 Mpixels per second. This is in addition to multiple USB channels plus stereo audio - all via the same single length of CAT6a or CAT7 shielded twisted pair cabling.

The Dual Link DVI/USB Extender SRX modules have been designed to be quick to install and totally transparent in operation.

### Dual Link DVI/USB Extender SRX link with direct cable connection

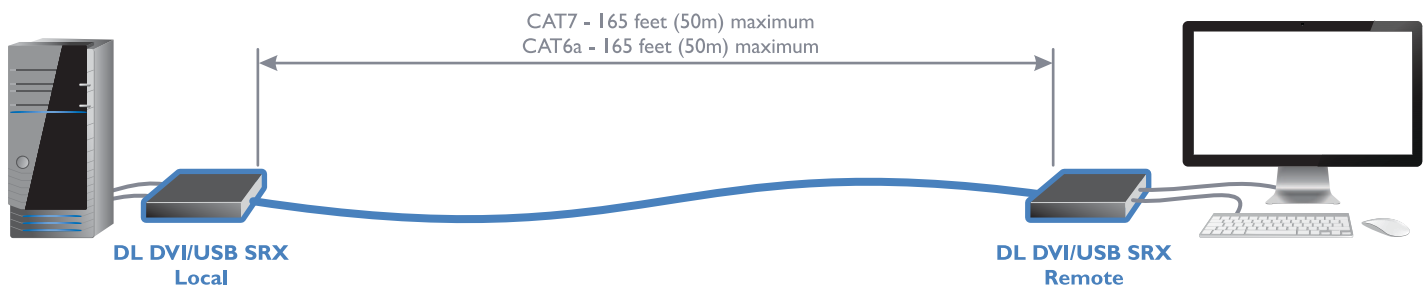

### Dual Link DVI/USB Extender SRX link with cable and patch panel connection

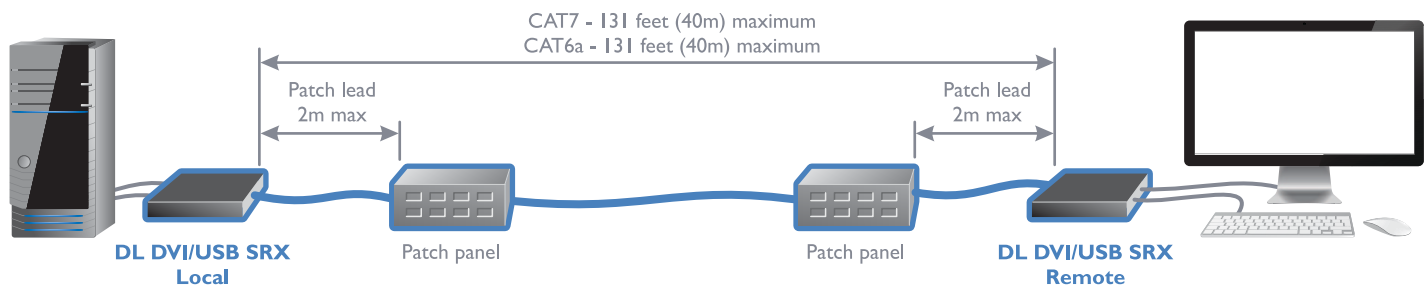

#### Cable type and distance rules

- Cable screening is paramount. The best cable screening specifications for digital KVM extension are: S/FTP, S/STP or PiMF.
- Extension distances up to 50m are supported with single uninterrupted runs of recommended cable (Black Box CAT7a patch cable) at full resolution.
- Extensions of 50m may be achieved with single uninterrupted runs of shielded CAT6a bulk/trunk (not patch) cable at full resolution.
- Black Box does not recommend CAT5e cables for use with this product.
- Overall cable runs must be reduced by 5m for each additional cable coupling.
- Run specifications may be increased by 10m when using resolutions of 1280 x 1024 or lower.
- All patch cables should be as short as possible and should be no longer than 2m.
- It is recommended that Black Box CAT7a patch cables are used for maximum performance.

## 3. Installation

### 3.1 Mounting the modules – desk or rack

The Dual Link DVI/USB Extender SRX modules can be situated on a desk or alternatively, for larger installations, mounted within an optional rack mount chassis.

#### 3.1.1 Desk mount

Apply the supplied self-adhesive rubber feet to the underside of the module as shown in Figure 3-1:

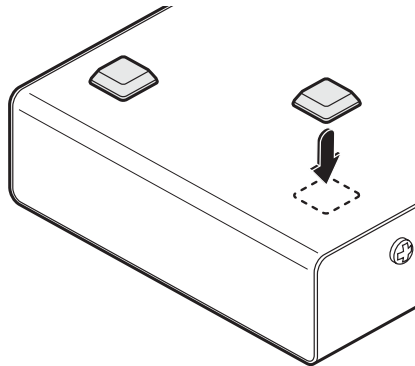

Figure 3-1. Applying the supplied self-adhesive rubber feet to the underside of the module



### 3.1.2 Rack mount

Note: The module switches are not accessible once it is inserted into the rack, therefore, check all settings before insertion.

- 1 Place the rack securing plate (available as a separate kit) onto the front of the module and secure it with the two countersunk screws.
- 2 Orient the Dual Link DVI/USB Extender SRX module on its side so that its labeled face is the correct way up.
- 3 Slide the module into the required rack position. The rectangular cut-out in the front upper lip of the rack allows the two screws on the module's upper edge to slide through.
- 4 The rack mount chassis has a series of holes in its floor that are spaced to accommodate the two screws on the module's lower edge. Ensure that the screws correctly locate into the two holes of the chosen slot. The rack securing plate on the module should now be flush with the front of the rack mount chassis.
- 5 Use the third (pan-head) screw, in the top hole of the rack securing plate to fasten the module to the rack as shown in Figure 3-2:

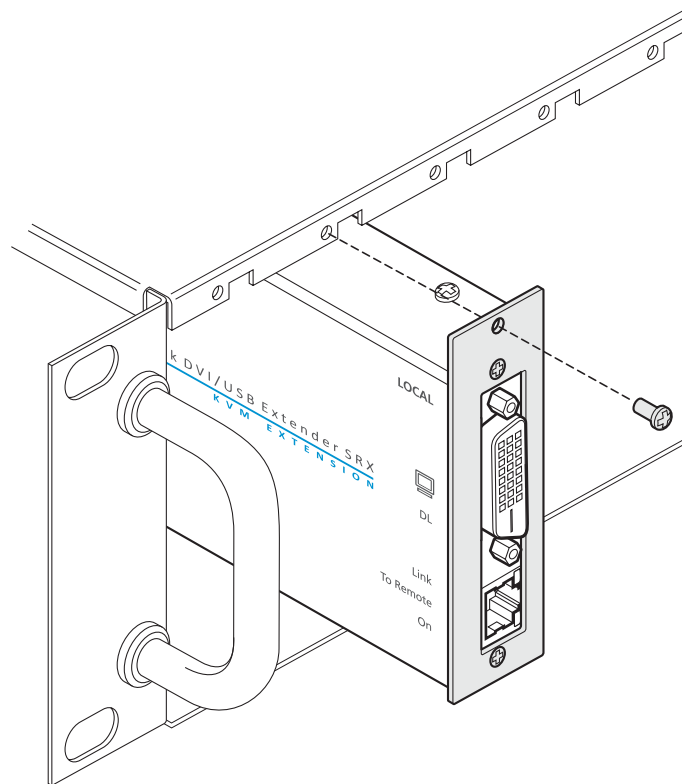

Figure 3-2. Fixing the module into the rack

## 3.2 Connections

Installation of the Dual Link DVI/USB Extender SRX modules is straightforward and requires minimal configuration in most cases.

- Connections at the local module
- Connections at the remote module

Note: After all connections are made, power up the monitor connected to the remote module, then power up the remote module and finally switch on the computer connected to the local module.

### 3.2.1 Connections at the local module

#### 3.2.1.1 Video connection

- 1 Use the supplied DVI/D link cable to connect the DVI input socket of the local module to the digital video output socket of the computer as shown in Figure 3-3:

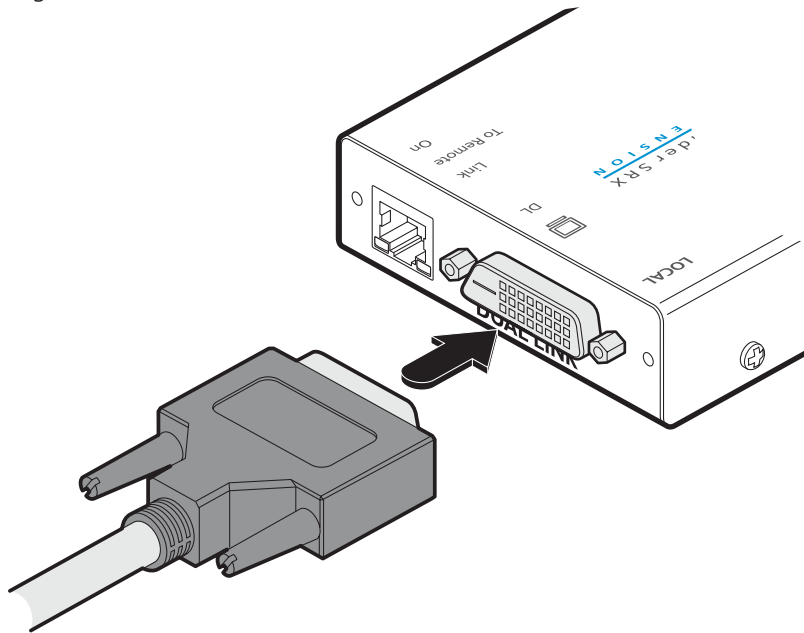

Figure 3-3. Attaching the DVI/D video link cable

### 3.2.1.2 USB connection

- 1 Use the supplied USB cable to link the USB socket of the local module to a vacant USB socket on the computer as shown in Figure 3-4:

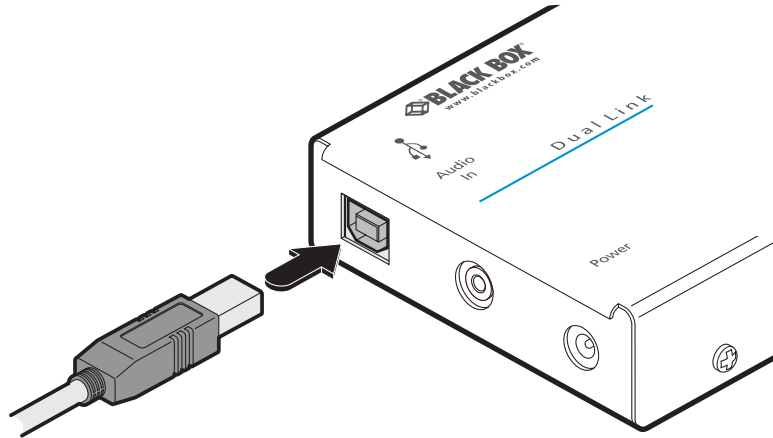

Figure 3-4. Attaching the USB link cable

### 3.2.1.3 Link connection

- 1 Connect the link cable (see page 2 for cable advice) to the local module socket labeled **TO REMOTE** as shown in Figure 3-5:

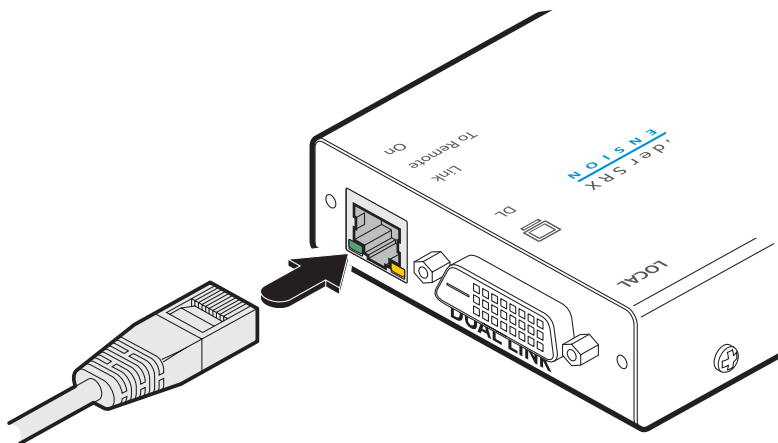

Figure 3-5. Attaching the CATx link cable

#### IMPORTANT:

- This is NOT an Ethernet port and must not be connected to network switches or any device other than the remote module.
- These extenders are NOT compatible with the standard DVI/USB SRX (single link) versions. Where both types are being used in close proximity, take care not to cross connect the local and remote modules between the two versions.

### 3.2.1.4 Audio connection

Optionally link a audio input to the local module using a 3.5mm audio cable.

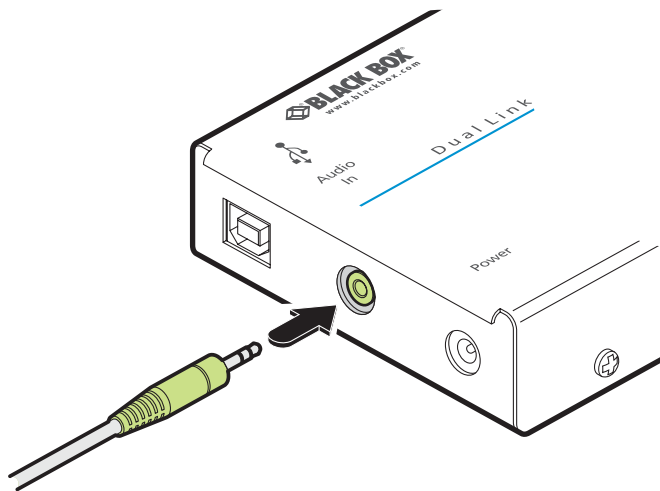

Figure 3-6. Attaching an audio link to the local module

### 3.2.1.5 Power connection

- 1 Connect the output lead of the supplied power adapter to the socket labeled '**POWER**' on the local module as shown in Figure 3-7:

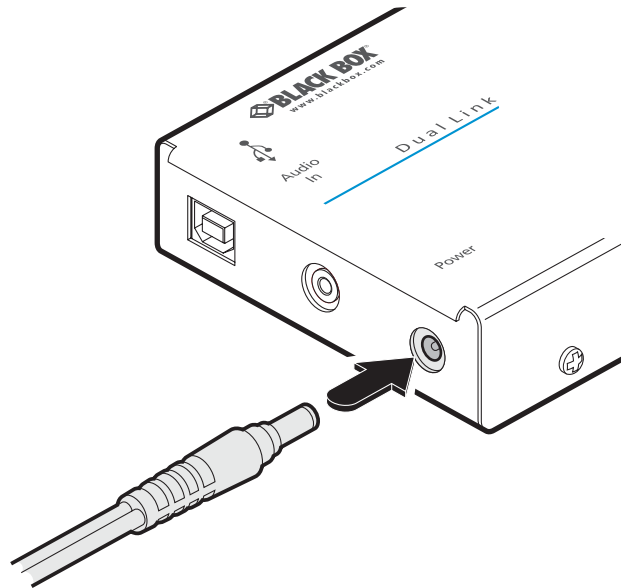

Figure 3-7. Attaching the power adapter connection to the local module

- 2 Insert the IEC connector of the separate power cord into the corresponding socket of the power adapter as shown in Figure 3-8:

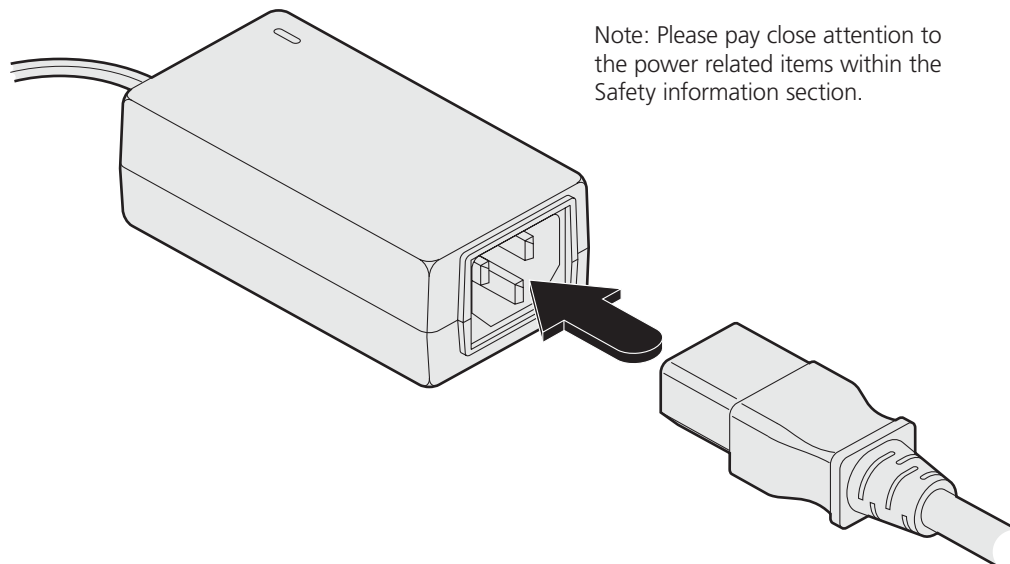

Figure 3-8. Connecting the power cord to the adapter

- 3 Wait before connecting the other end of the power cord to a nearby mains outlet, until the remote module has been powered up. The correct power up sequence is:
  - a) Remote module and screen > b) Local module > c) Computer.

## 3.2.2 Connections at the remote module

### 3.2.2.1 Video connections

- 1 Place the remote module adjacent to the user location.
2. Connect the DVI/D lead from the video monitor to the DVI output socket of the remote module as shown in Figure 3-9:

Note: If dual link screen resolutions are required, the DVI-D cables used at both the local and remote modules must be dual link types.

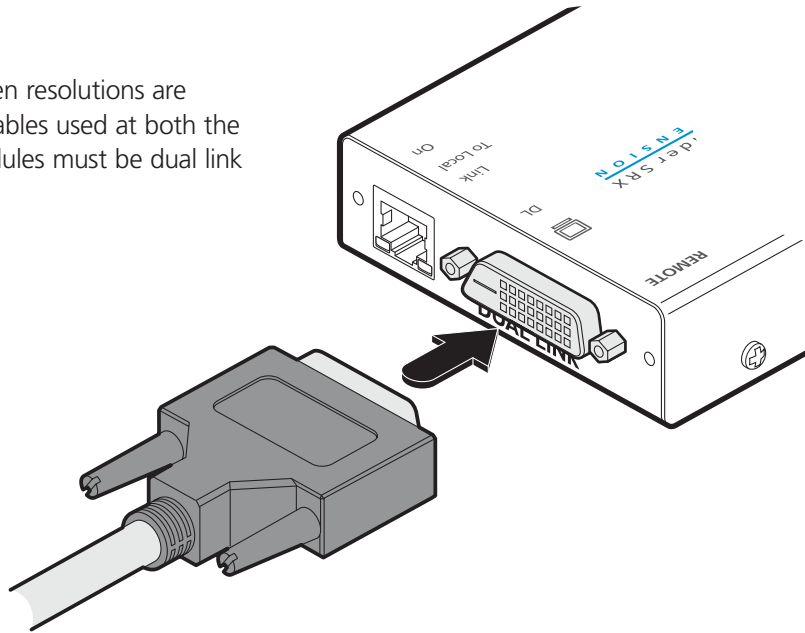

Figure 3-9. Attaching the DVI/D video monitor cable

### 3.2.2.2 USB connection

- 1 Connect the leads from the keyboard and mouse to two of the USB sockets on the remote module as shown in Figure 3-10:

Note: It is not important which of the four sockets are used.

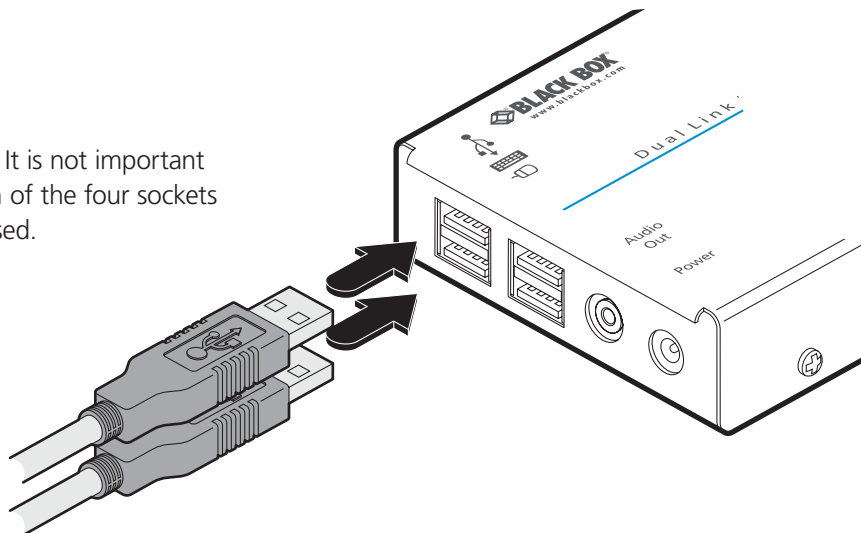

Figure 3-10. Attaching the keyboard and mouse USB cables

**IMPORTANT:** The total current that may be drawn from the USB ports is 1.2A, which should be sufficient for a keyboard, mouse (no more than 100mA each) and any two other devices (500mA maximum each). If more power for USB devices is required, please use a powered USB hub.

- 2 Where other USB peripherals are also required, connect up to two other leads to the remaining USB sockets.

### 3.2.2.3 Link connections

1 Connect the link cable (see page 2 for cable advice) to the remote module socket labeled **TO LOCAL** as shown in Figure 3-11:

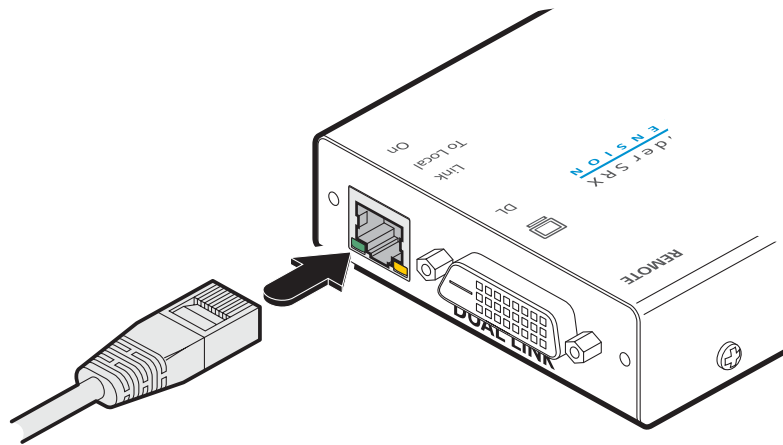

Figure 3-11. Attaching the CATx link cable

#### IMPORTANT:

- This is NOT an Ethernet port and must not be connected to network switches or any device other than the remote module.
- These extenders are NOT compatible with the standard DVI/USB SRX (single link) versions. Where both types are being used in close proximity, take care not to cross connect the local and remote modules between the two versions.

### 3.2.2.4 Speaker connection

Optionally link stereo speakers to the remote module using 3.5mm audio cable.

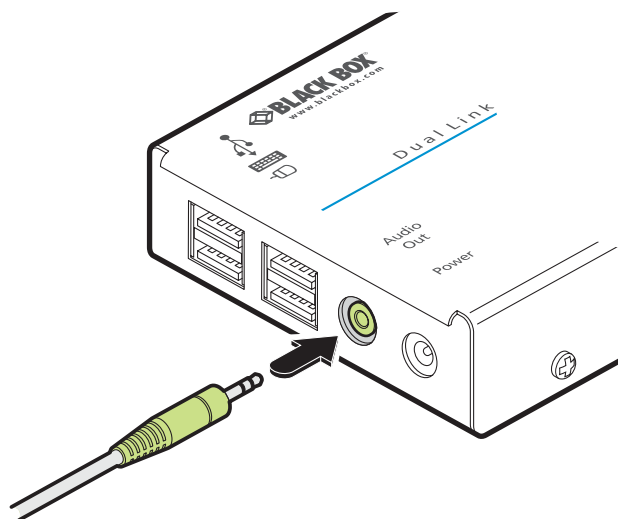

Figure 3-12. Attaching speakers to the remote module

## 3.2.2.5 Power connection

- 1 Connect the output lead of the supplied power adapter to the socket labeled '**POWER**' on the remote module as shown in Figure 3-13:

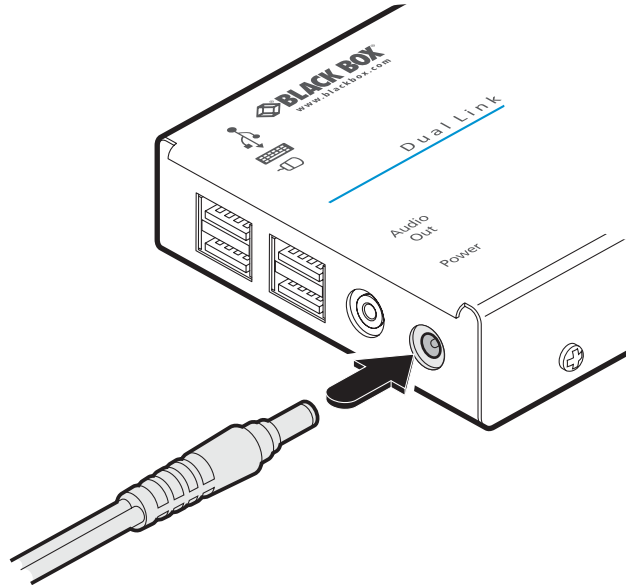

Figure 3-13. Attaching the power adapter connection

- 2 Insert the IEC connector of the separate power cord into the corresponding socket of the power adapter as shown in Figure 3-14:

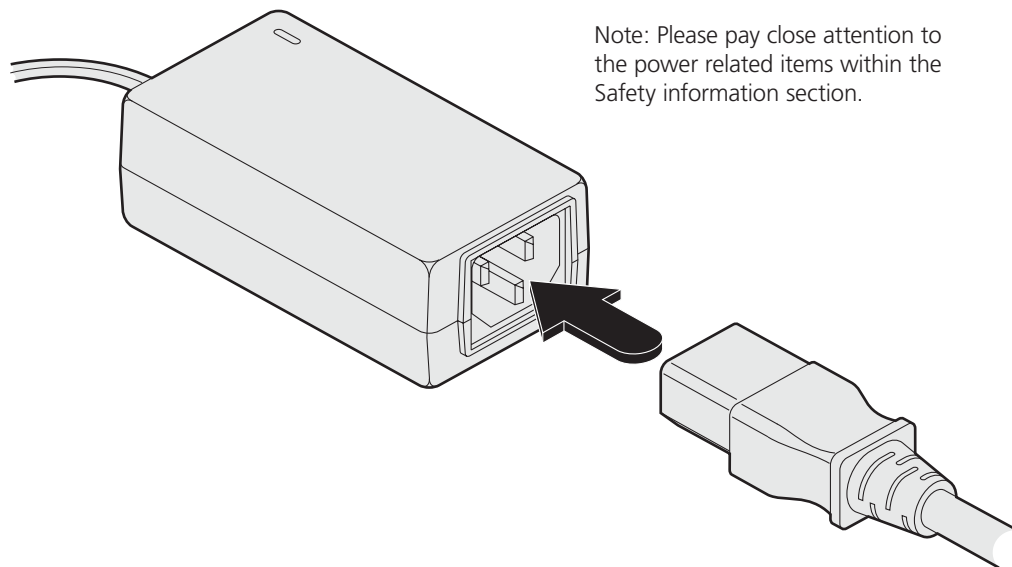

Figure 3-14. Connecting the power cord to the adapter

- 3 After all connections are made, power up the display screen and connect the other end of this power cord to a nearby mains outlet. Then power up the local module and finally switch on the computer. This will allow each item, in order, to correctly discover the one immediately downstream.



### 4. Operation

#### 4.1 General use

In use, the Dual Link DVI/USB Extender SRX modules should be transparent - the system and its peripherals should operate exactly as normal, the only difference being that they are now up to 165 feet (50 meters) apart.

#### 4.2 Video display (EDID) information

Extended Display Identification Data (or EDID) is an industry standard scheme which allows video monitors to declare their capabilities to the computer's video adapter circuitry, allowing the latter to optimize their outputs accordingly. Since the widespread adoption of the scheme, video adapters have become increasingly dependent on receiving relevant EDID information during start-up, before they will output anything more than a rudimentary video signal.

Each time that the remote module is powered on, it attempts to read the EDID information from the connected DVI video monitor. If the attempt is successful, the information is transferred to the local module and stored within non-volatile memory. This information is then made available to the computer's video adapter when required.

#### 4.3 HDMI 1.3a operation

Using optional HDMI to DVI converter cables, the Dual Link DVI/USB Extender SRX modules can support HDMI video and audio up to the 165MHz clock rate (1920 x 1080 at 60Hz, 24-bit colour).

Eight channels of HDMI audio are supported with sample sizes of 16, 20 or 24-bits at 32KHz, 44.1kHz, 48kHz, 88.2kHz, 96kHz, 176.4kHz, or 192kHz (simultaneously with the jack audio).

*Note: The High-bandwidth Digital Content Protection (HDCP) and Consumer Electronics Control (CEC) schemes are not supported.*

## 4.4 Power and activity indicators

Each module provides two indicators to confirm power status and also feedback about the various input signals:

### Local module

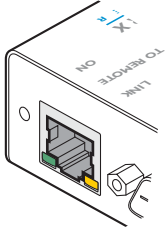

#### Green:

- On when power is present.

#### Yellow:

- On when a valid single link DVI video input signal is being received from the computer.
- Blinks (mostly on with short off periods) when a valid dual link DVI video input signal is being received from the computer.
- Flashes if no valid DVI signal is being received from the computer.
- Off if the CATx link cable is disconnected.

### Remote module

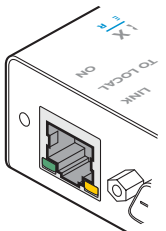

#### Green:

- On when power is present.

#### Yellow:

- On when a valid single link DVI video input signal is being received from the local module.
- Blinks (mostly on with short off periods) when a valid dual link DVI video input signal is being received from the local module.
- Flashes if the CATx link is present but no valid DVI video signal is being received from the local module.
- Off if the CATx link cable is disconnected.

## Appendix A. Troubleshooting

If you experience problems when installing or using the modules, please check through this section for a possible solution. If your problem is not listed here and you cannot resolve the issue, then please contact Black Box technical support.

### No video image is displayed on the remote monitor

- Check the yellow indicators on the local and remote modules while no keys are pressed on the keyboard and no mouse movements are being made:

LOCAL: If the yellow indicator is flashing\*, then the video feed to the local module is not valid. Try connecting a DVI monitor (preferably using the same DVI link cable as used with the local module) directly to the computer and check for a correct image.

REMOTE: If the yellow indicator is flashing\*, then the video feed via the link cable is not valid. If the link cable is long, try using a short link cable temporarily to check for basic operation.

If the yellow indicators are off, then the link cable is not properly connected.

- Check that both the local and remote ends of the extender are Dual Link DVI/USB Extender SRX variants. The single link DVI/USB SRX modules are not compatible.

### Only single link resolutions are displayed

- Check that the video cables connected to the local and remote modules are both specifically dual link types.

### Video blanking is occurring on the remote display screen

- Check that the correct type and length of link cable is being used. Please see the cable advice given on page 2.

\* Take care not to confuse the *flash* and *blink* codes used by the yellow indicators:

- A *flash* is when the yellow indicator shows a regular on/off cycle every second, to warn that there's a video feed problem.
- A *blink* is when the yellow indicator is mostly on with short off periods, to confirm that a valid dual link video signal is present.

### Appendix B. Safety Information

- For use in dry, oil free indoor environments only.
- Do not use to link between buildings.
- Ensure that the twisted pair interconnect cable is installed in compliance with all applicable wiring regulations.
- Do not connect the CATx link interface (RJ45 style connector) to any other equipment, particularly network or telecommunications equipment.
- Warning – the power adapter contains live parts.
- No user serviceable parts are contained within the power adapter - do not dismantle.
- Plug the power adapter into a grounded socket outlet close to the unit that it is powering.
- Replace the power adapter with a manufacturer approved type only.
- Do not use the power adapter if the power adapter case becomes damaged, cracked or broken or if you suspect that it is not operating properly.
- If you use a power extension cord with the units, make sure the total ampere rating of the devices plugged into the extension cord do not exceed the cord's ampere rating. Also, make sure that the total ampere rating of all the devices plugged into the wall outlet does not exceed the wall outlet's ampere rating.
- Do not attempt to service the units yourself.
- The units and power supplies can get warm in operation – do not situate them in an enclosed space without any ventilation.
- The units do not provide ground isolation and should not be used for any applications that require ground isolation or galvanic isolation.

**Black Box Tech Support: FREE! Live. 24/7.**

Tech support the  
way it should be.



Great tech support is just 60 seconds away at 724-746-5500 or [blackbox.com](http://blackbox.com).



### About Black Box

Black Box Network Services is your source for an extensive range of networking and infrastructure products. You'll find everything from cabinets and racks and power and surge protection products to media converters and Ethernet switches all supported by free, live 24/7 Tech support available in 60 seconds or less.

© Copyright 2015. Black Box Corporation. All rights reserved.

ACU5520A, rev. 1.0