



M73 Series
Network Projector
Operation Guide

Copyright

Copyright 2017 BenQ Corporation. All rights reserved. No part of this publication may be reproduced, transmitted, transcribed, stored in a retrieval system or translated into any language or computer language, in any form or by any means, electronic, mechanical, magnetic, optical, chemical, manual or otherwise, without the prior written permission of BenQ Corporation.

All other logos, products, or company names mentioned in this manual may be the registered trademarks or copyrights of their respective companies, and are used for informational purposes only.

Disclaimer

BenQ Corporation makes no representations or warranties, either expressed or implied, with respect to the contents hereof and specifically disclaims any warranties, merchantability or fitness for any particular purpose. Further, BenQ Corporation reserves the right to revise this publication and to make changes from time to time in the contents hereof without obligation of BenQ Corporation to notify any person of such revision or changes.

This user manual aims to provide the most updated and accurate information to customers, and thus all contents may be modified from time to time without prior notice. Please visit <http://www.benq.com> for the latest version of this manual.

BenQ is not responsible for the content of the websites or of similar resources, which are maintained and controlled by third parties, that may be linked from this product. Providing links to those websites or to similar resources does not mean that BenQ makes any warranty or representation to their content by expression or by implication.

Any third party content or service preinstalled in this product is provided "as is". BenQ does not, by expression or by implication, make any warrant to the content or to the services provided by third parties. BenQ does not warrant or guarantee that the content or services provided by third parties are accurate, effective, most up-to-date, legal, or complete. Under no circumstances shall BenQ be liable for the content or services provided by third parties including their negligence.

Services provided by third parties may be terminated temporarily or permanently. BenQ does not warrant or guarantee that the any content or services provided by third parties are in good condition at any time, and is not liable for the termination of the said content and services.

In addition, BenQ is not involved in any transactions you conduct in the websites or similar resources maintained by third parties.

You should contact the content or service providers for any questions, concerns, or disputes.

Table of contents

- Preparation 5
 - Switching to **Advanced Menu**..... 5
 - Wired connections 6
 - Setting up a wired network for the projector 6
 - Connecting your computer to the projector via a wired connection 7
 - Wireless connections 8
 - Setting up a wireless network for the projector 8
 - Connecting your computer or mobile device to the projector wirelessly..... 9
- Projecting via **QCast** (for PCs)..... 11
 - Minimum system requirements..... 11
 - Prerequisite..... 11
 - Downloading **QCast**..... 11
 - Installing **QCast** 11
 - Connecting your computer to the projector 12
 - Selecting **Network Display** in the input source menu 12
 - Launching **QCast**..... 12
 - Using **QCast**..... 14
 - Role assignment 14
 - Network Display Code**..... 15
 - Mirror Off / On / Extension..... 15
 - Quality**..... 16
 - Audio** 16
 - Compatible** 17
 - Advanced** 17
 - Preference**..... 21
- Projecting via **QCast** (for mobile devices)..... 22
 - Minimum system requirements..... 22
 - Prerequisite..... 22
 - Selecting **Network Display** in the input source menu 22
 - Downloading **QCast**..... 22
 - Connecting your mobile device to the projector 23
 - Launching **QCast**..... 23

Using QCast	26
Role assignment.....	26
Network Display Code	27
Mirror Off / Mirror On	27
Photo	28
Camera	28
Document	28
Advanced	29
Preference	29
Managing the projector using a web browser	30
Supported web browsers.....	30
Configuring Standby Settings for the projector	30
Accessing the BenQ Projector Control System	30
Main function.....	32
Accessing the Internet with a wireless connection.....	40
Accessing the Internet via QCast	40
Accessing the Internet via projector OSD.....	40
PJLink commands.....	42

Preparation

Your BenQ projector is equipped with wired and wireless network function. Via a network connection you can project what is shown on your computer or mobile device's screen using the **QCast** app. You can also manage and control the projector from remote devices such as desktops, laptops, tablets, and smartphones using web browsers.

In order to take advantage of these features, you need to complete the steps described in the following sections. The basic workflow for projecting through a network is:

1. Set up a wired or wireless network for the projector.
See "[Setting up a wired network for the projector](#)" on page 6 or "[Setting up a wireless network for the projector](#)" on page 8 for details.
2. Connect your computer or mobile device to the projector.
For wired connections, see "[Connecting your computer to the projector via a wired connection](#)" on page 7 for details.
For wireless connections, see "[Connecting your computer or mobile device to the projector wirelessly](#)" on page 9 for details.
3. Download **QCast** on your computer or mobile device.
For downloading **QCast** on your computer, see "[Downloading QCast](#)" on page 11 for details.
For downloading **QCast** on your mobile devices, see "[Downloading QCast](#)" on page 22 for details.
4. Project via **QCast**.
For using your computer to project via wired connections, see "[Launching QCast](#)" on page 12 for details.
For using your computer to project via wireless connections, see "[Launching QCast](#)" on page 12 for details.
For using your mobile device to project, see "[Launching QCast](#)" on page 23 for details.

Switching to Advanced Menu

When you first enter the projector's OSD menu, you will see the OSD's **Basic Menu**. Before you can configure the projector and network settings to use the features described in this guide, you need to switch to the OSD's **Advanced Menu**. Follow the steps below to switch to the **Advanced Menu**:

1. Turn on the projector.
2. Press **MENU** to open the OSD's **Basic Menu**.
3. Highlight **Menu Type** and press **OK**.
4. Highlight **Advanced** and press **OK**.

The OSD menu will now be set to the **Advanced Menu** which allows you to start configuring the network settings.



After setting the **Menu Type** to **Advanced**, the **Advanced Menu** will be shown every time you press the **MENU** button.

Wired connections

For projecting through a wired network, you need to connect the projector and your device to the same local area network (LAN).

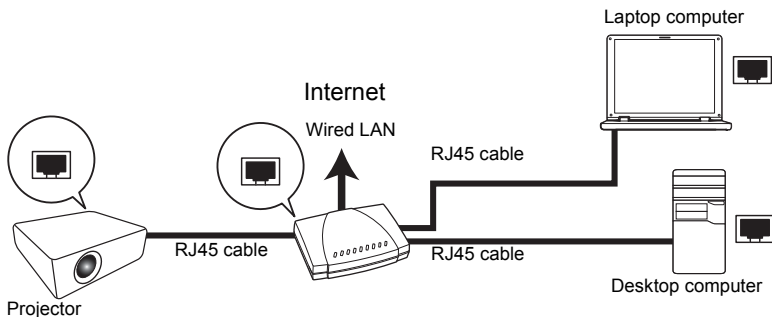

Setting up a wired network for the projector

If you are in a DHCP environment:

If your projector is in a DHCP environment, you do not have to manually set the IP address. Follow the steps below to configure the wired network settings for the projector in a DHCP environment:

1. Connect the projector to a local area network via an RJ45 cable.
2. Turn on the projector.
3. Press **MENU** to open the **Advanced Menu**.
4. Highlight **Network** and press **OK**.
5. Highlight **Wired LAN** and press **OK**.
6. Highlight **DHCP** and press **OK**.
7. Select **On** and press **OK**.
8. Highlight **Apply** and press **OK**.
9. Re-enter the **Wired LAN** page and check if the **IP Address**, **Subnet Mask**, **Default Gateway**, and **DNS Server** have been automatically configured. Make sure the **Status** is **Connect**.



If the **IP Address** still does not appear, contact your network administrator.

If you are in a non-DHCP environment:

If your projector is in a non-DHCP environment, you need to manually set the IP Address, Subnet Mask, Default Gateway, and DNS Server. Follow the steps below to configure the wired network settings for the projector in a non-DHCP environment:

1. Repeat step 1 to 5 described in "[If you are in a DHCP environment:](#)" on page 6.
2. Highlight **DHCP** and press **OK**.
3. Select **Off** then press **OK**.
4. Contact your network administrator for information on the **IP Address**, **Subnet Mask**, **Default Gateway**, and **DNS Server** settings.
5. Enter the projector's **IP Address**, **Subnet Mask**, **Default Gateway**, and **DNS Server** and assign the values as needed.
6. After finishing the settings, highlight **Apply** and press **OK**.

Your projector is now connected to your local area network and can be accessed by any devices linked to the same local area network.



Alternatively, to check the IP address of the projector, make sure the projector is connected to the network, and press **SOURCE** on the projector and then select **Network Display**. The IP address is displayed on the bottom left corner of the **Network Display** screen.

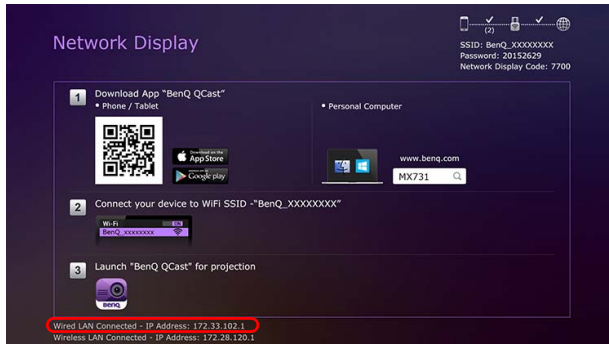

Connecting your computer to the projector via a wired connection

Follow the steps below to connect your computer to the projector through the local area network:

1. Ensure the projector is connected to the local area network. You can enter the **Wired LAN** page to check if the **IP Address**, **Subnet Mask**, **Default Gateway**, and **DNS Server** are configured as needed and if the **Status** is **Connect**.
2. Connect your computer to the same local area network via an RJ45 cable.

Now your computer and the projector are on the same local area network.



Your computer should be properly configured to detect a wired network connection. Check the user manual of your computer or visit the manufacturer's website for information on how to configure a wired network connection.

Wireless connections

If you want to project wirelessly, you must first install the BenQ WDR8192 USB wireless dongle onto your projector. This USB wireless dongle is not shipped with your projector and is sold separately. Do not install any other type of wireless dongle or module.

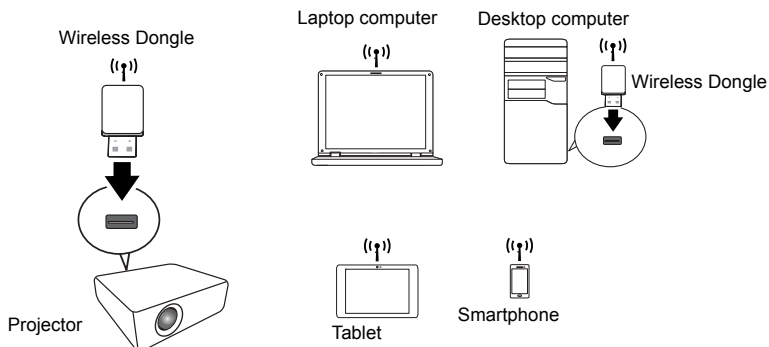

With the USB wireless dongle, your projector will be able to operate as a wireless LAN access point (AP), allowing you to connect your computer or mobile device directly to this ad hoc network. Furthermore, with the USB dongle installed, the projector can also connect to your organization's wireless network so that you can access the Internet while projecting and making a presentation. See "[Network Setup](#)" on page 18 or "[Accessing the Internet with a wireless connection](#)" on page 40 for details on accessing the Internet via a wireless connection.

Setting up a wireless network for the projector

In order to use your projector wirelessly, follow the steps below:

1. Turn on the projector.
2. Insert the designated USB wireless dongle into the **WIRELESS DONGLE** port at the rear of the projector, a wireless network for the projector will be set up automatically.

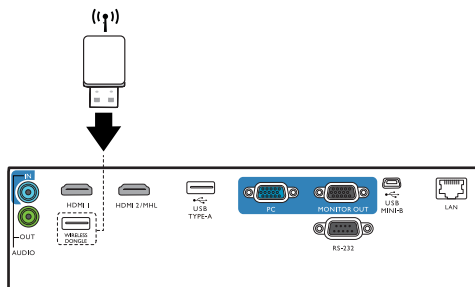

The wireless dongle should only be installed into the **WIRELESS DONGLE** port. Installing the dongle into the **USB TYPE-A** port on the projector will prevent the wireless dongle from functioning.

The projector is now operating as a wireless LAN access point and can be accessed wirelessly by your computer or mobile device.

If you want to check the projector's wireless network connection status, follow the steps below:

1. Press **MENU** to open the **Advanced Menu**.
2. Highlight **Network** and press **OK**.
3. Highlight **Wireless LAN** and press **OK**.
4. Highlight **Point to Point** and press **OK**.
5. On the **Point to Point** page, make sure that **Status** is **Connect**, and that the **Network (SSID)** information and **IP Address** are displayed.



- Network (SSID) is the projector's ID used to identify the projector over the network and can be modified. If you want to modify the SSID, select the **Network (SSID)** on the **Point to Point** page and the **(SSID)** page will appear. On the **(SSID)** page, you can modify the projector's SSID. Select **Commit** to have the modifications take effect.
- The projector supports WPA2 security encryption.
- The SSID has a maximum length of 13 alphanumeric characters.
- The SSID and password can also be modified using a web browser. See "[Network Settings](#)" on [page 38](#) for details.

Connecting your computer or mobile device to the projector wirelessly

Follow the steps below to connect your computer or mobile device wirelessly to the projector:

1. Make sure the BenQ USB wireless dongle has been properly inserted into the **WIRELESS DONGLE** port at the rear of the projector.
2. Check the projector's wireless network connection status. Go to the **Point to Point** page, make sure the **Network (SSID)** has been set up and the **Status** shows **Connect**.
3. Open the wireless menu of your computer or mobile device and search for the available wireless networks.
4. Select the SSID of the projector.
5. Enter the login password to connect to the projector. You can find the password on the **(SSID)** page.



- If your computer or mobile device cannot detect the wireless network, check the user manual of your computer or mobile device or visit the manufacturer's website for information on how to connect to a wireless network.



Alternatively, to check the login passwords and SSID of the projector, make sure the USB wireless dongle is properly connected to the projector, and press **SOURCE** on the projector. Select **Network Display**. The SSID and password are displayed on the upper right corner of the screen.

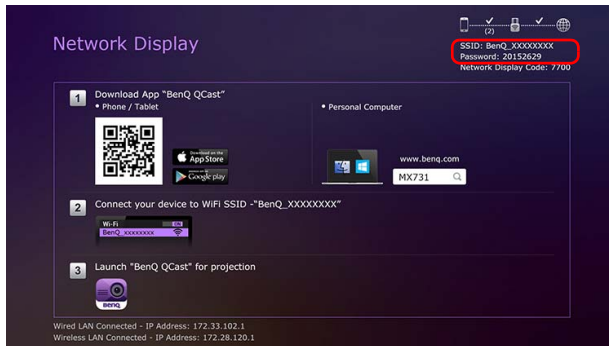

Projecting via **QCast** (for PCs)

QCast is an application that allows you to project your computer's screen as well as photos and documents saved on your computer on the BenQ network projector.

Minimum system requirements

Before installing and running **QCast**, please make sure your computer meets the requirements listed below.

- Computers with Windows Operating System (OS):
 - Supported OS version: Windows 7 / 8.0 / 8.1 / 10
 - CPU: Dual Core Intel Core i 2.4GHz equivalent or above
 - Memory: 4GB DDR memory or more
 - Graphics: 256MB VRAM equivalent or more
 - Atom processors are not supported
- Computers with Mac OS:
 - Supported OS version: Mac OS X 10.11 / OS X 10.12 (The latest 2 versions will be supported.)
 - CPU: Dual Core Intel Core i 1.4GHz equivalent or above
 - Graphics: Intel or nVIDIA or ATI with 64MB VRAM equivalent or more
 - PowerPC is not supported.



BenQ does not guarantee compatibility in respective user environments. Certain users may experience compatibility issues when running **QCast**.

Prerequisite

The basic workflow for projecting via **QCast**:

1. Download **QCast** from BenQ's website.
2. Install **QCast** on your computer.
3. Connect your computer to the projector.
4. Select **Network Display** in the input source menu.
5. Launch **QCast** and start projecting.

Downloading **QCast**

Visit BenQ's website at <http://business-display.benq.com/en/index.html> or www.BenQ.com and search for the projector by model name, and then download the latest version of **QCast** from the projector's feature page.

Installing **QCast**

For Windows OS

1. When the download from BenQ's website is complete, double-click the .exe file.
2. Follow the on-screen instructions to finish the installation.

For Mac OS

1. When the download from BenQ's website is complete, double-click the .dmg file to make its content available.
2. Drag the content into the computer's **Applications** folder. The installation will be processed automatically.

Connecting your computer to the projector

You can connect your computer to the projector either through a wired or wireless network.

Wired connection

Make sure you have set up a wired connection for the projector and connected your computer and the projector to the same local area network. See "[Wired connections](#)" on [page 6](#) for details.

Wireless connection

Make sure the BenQ WDRT8192 USB wireless dongle is installed on your projector and your computer has been connected to the projector's wireless network. See "[Wireless connections](#)" on [page 8](#) for details.

Selecting **Network Display** in the input source menu

Before projecting your computer's screen to the projector, you have to select **Network Display** in the input source menu.

1. Press **SOURCE** on the projector.
2. Highlight **Network Display** and press **OK**.

Launching **QCast**

1. Launch **QCast**.



2. Click the Search button to detect available projectors.

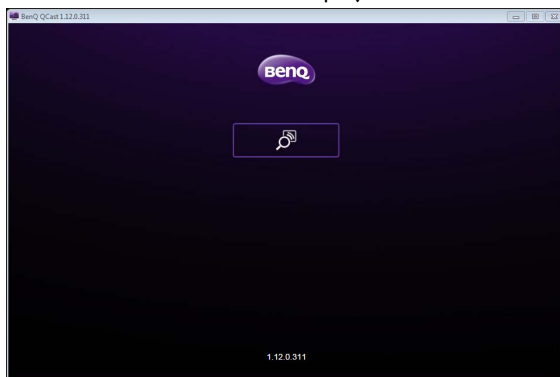

3. Click the preferred projector and your computer will connect to the projector.

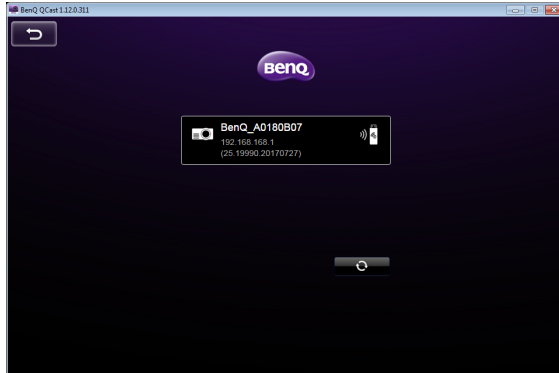

4. A preferred device prompt will display. Click **Yes** if you want to set the projector as the default projector. If the projector is set as the default projector, the next time you launch **QCast** your computer will search for the projector and automatically connect to it if it is available through the network.

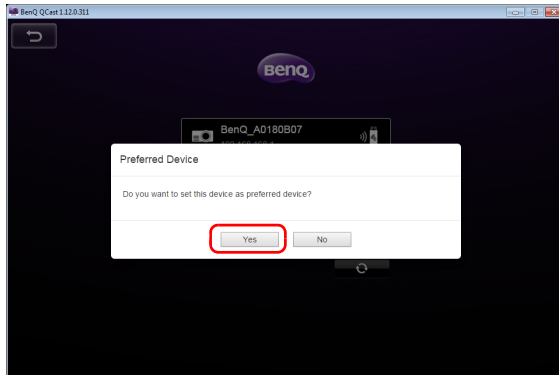

5. After you confirm or decline the preferred device setting, the **QCast** main screen will appear. You can start using **QCast**.

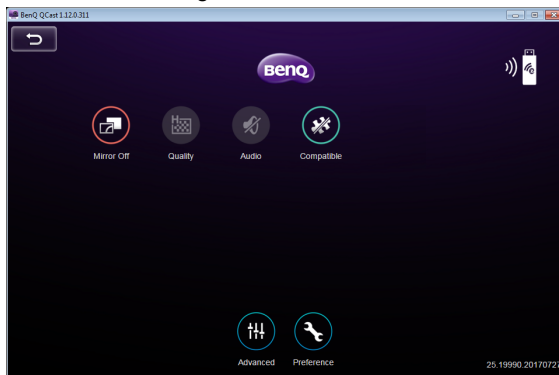

Using QCast

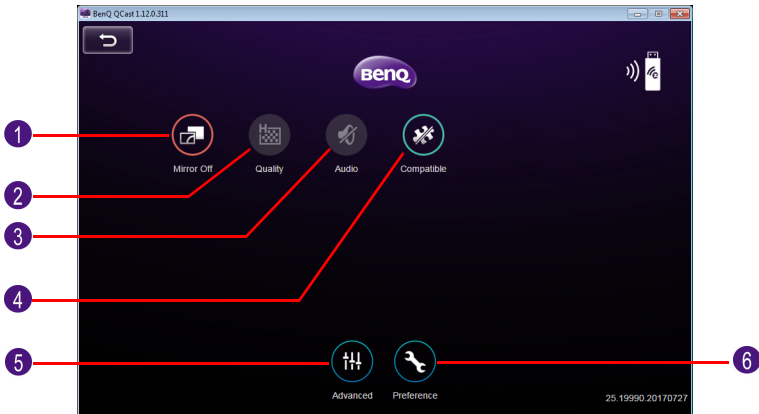

No.	Function	Description
1	Mirror Off/ On/Extension	Allows you to mirror or extend your screen to the projector. See " Mirror Off / On / Extension " on page 15 for details.
2	Quality	Allows you to adjust the image quality. See " Quality " on page 16 for details.
3	Audio	Allows you to broadcast audio on the projector. See " Audio " on page 16 for details.
4	Compatible	Allows you to mirror the mouse-over information of a document or folder on your computer. See " Compatible " on page 17 for details.
5	Advanced	Allows you to view more functions for QCast . See " Advanced " on page 17 for details.
6	Preference	Allows you to set your personal preferences. See " Preference " on page 21 for details.

Role assignment

The first user connected to the projector using **QCast** is designated as the host. Users that join subsequently are designated as guests. Only the host is allowed to use the **Advanced** function. See "[Advanced](#)" on page 17 for details.

Network Display Code

If you are the first user (the host) connected to the projector, when you click the **Mirror Off/On** button to mirror your computer screen on the projector, a password prompt will display requesting a password. You will need to enter the **Network Display Code** to start mirroring. The **Network Display Code** is displayed at the upper right corner of the **Network Display** screen.

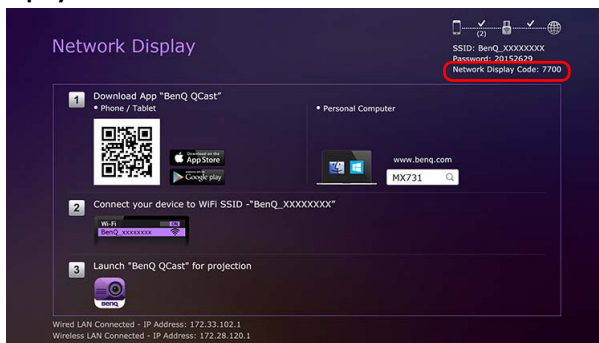

- If the **Network Display** screen is not shown on the projector, press **SOURCE** on the projector and then select **Network Display** to view the screen.
- Subsequent users (the guests) do not have to enter the **Network Display Code** to join the session. However, their projection requests must be approved by the host. See "[Preference](#)" on [page 21](#) for details.

Mirror Off / On / Extension

You can switch between different display options by clicking the **Mirror Off/On/Extension** button. The options available are: **Mirror Off**, **Mirror On**, and **Mirror Extension**.

Icon	Name	Description
	Mirror Off	When Mirror Off is displayed, your screen is not mirrored on the projector.
	Mirror On	When Mirror On is displayed, your screen is mirrored on the projector, allowing other users to see your screen.
	Mirror Extension	When Mirror Extension is displayed, the projector will act as an extended desktop for the computer.

- If you are the first user and you click the **Mirror Off / Mirror On / Mirror Extension** button to switch to **Mirror On**, a password prompt will appear. See "[Network Display Code](#)" on [page 15](#) for details.



Certain computers may not support **Mirror Extension**. If you are notified of a display extension failure, check the user manual of your computer or visit the manufacturer's website for more information about mirroring or extending your screen.

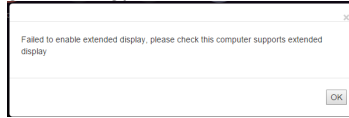

Quality

You can switch between **High Quality** and **Low Quality** by clicking the **Quality** button.

Icon	Name	Description
	High Quality	When High Quality is displayed, the mirrored screen will have better image quality but slower transmission speed.
	Low Quality	When Low Quality is displayed, the mirrored screen will have normal image quality but faster transmission speed.
	Quality	This button is not selectable when QCast is set to Mirror Off .



Audio

You can switch between **Audio Off** and **Audio On** by clicking the **Audio** button.

Icon	Name	Description
	Audio Off	When Audio Off is displayed, the projector's speaker is turned off.
	Audio On	When Audio On is displayed, the projector's speaker is turned on.
	Audio	This button is not selectable when QCast is set to Mirror Off .

Compatible

When you hover your cursor over a document or folder while projecting in **QCast**, the document or folder information will be displayed. The **Compatible** button allows you to enable/disable this function.

Icon	Name	Description
	Grayed-out Compatible	When Compatible is grayed out, other users cannot see the hover-over information.
	Compatible	When Compatible is on, other users can see the hover-over information.



The **Compatible** function is only supported on the computers running Windows 7.

Advanced

When you click **Advanced** on the main screen, the **Advanced** panel appears. The **Advanced** features the **Conference**, **Network Setup** and **Remote Control** options.

Icon	Name	Description
	Advanced	<ul style="list-style-type: none">• Consists of Conference, Network Setup and Remote Control options.• Only the host is allowed to access the options in the Advanced menu.• Guests will not be able to use the Advanced options and the button will be grayed out on their screens.

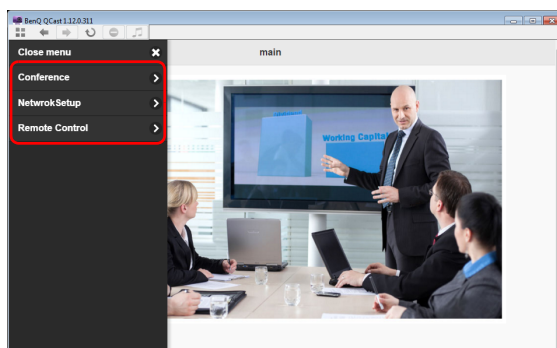

Conference

Conference allows the host to create and manage a presentation where there are multiple users connected to the projector.

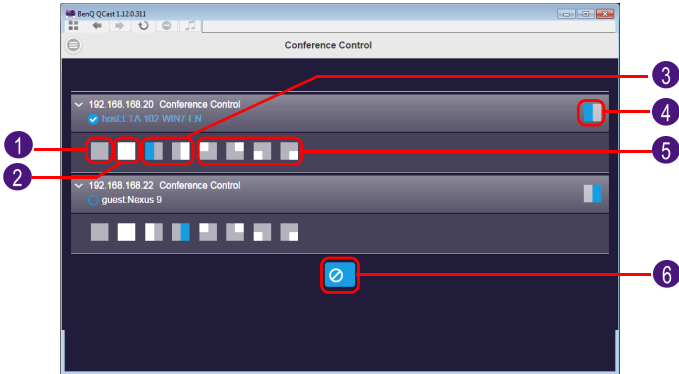

No.	Description
1	Disconnects the user from the presentation.
2	Projects the user's screen in full-screen mode.
3	Projects the user's screen in half-screen mode.
4	Displays/Hides the user status bar.
5	Projects the user's screen in 4-way split screen mode.
6	Disconnects all users, including the host, from the presentation.



For hosts, a **Network Display Code** is required during the initial conference. For guests, login requests require the host's approval. See "[Network Display Code](#)" on page 15 and "[Preference](#)" on page 21 for details.

Network Setup

When an ad hoc wireless network is setup for your projector using the steps described in the [Wireless connections](#) section, connections to the projector by your computer or mobile device will lack internet access. The **Network Setup** option allows you to connect the projector to a wireless network that provides connected devices Internet access.



This option is also available via the projector's OSD. See "[Accessing the Internet with a wireless connection](#)" on page 40.

Accessing the Internet via **Network Setup**

Follow the steps below to connect your projector to a wireless network with Internet access:

1. Click **Network Setup** on the **Advanced** panel to prompt the **Network Setup** screen.
2. Click the **Network (SSID)** to display the available wireless networks.

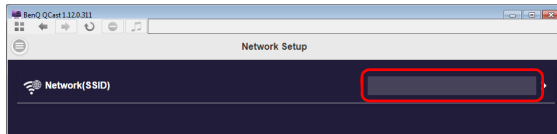

3. A list of the wireless networks that can be detected by the projector will be displayed. Select the wireless network that you want to connect your projector to.

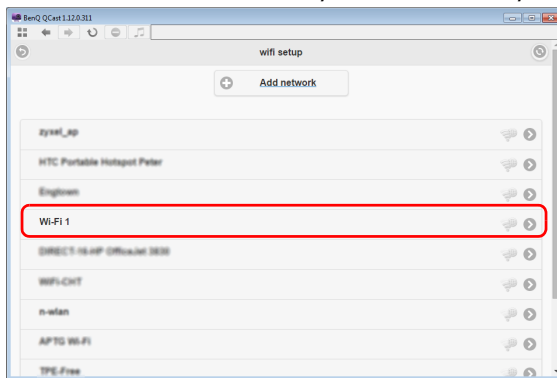

4. Enter the password and click **OK** to proceed.

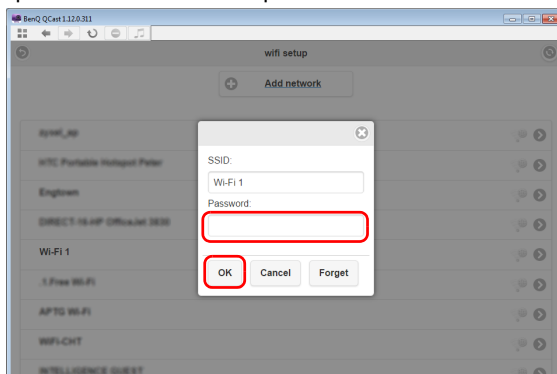

5. If the projector successfully connects to the wireless network, a message will appear instructing you to reconnect the projector. When this message appears, turn off **QCast** and reconnect your computer to the projector and re-launch **QCast**.

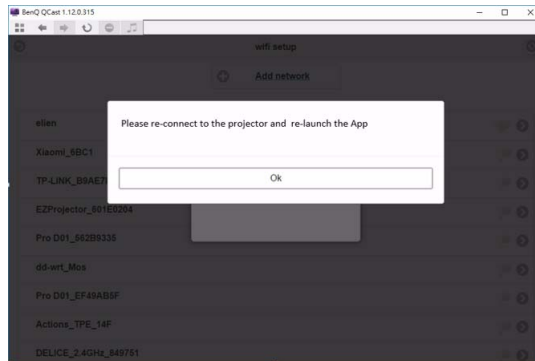

For confirming if the projector is connected to the wireless network, you can re-enter the **Network Setup** in **QCast** and check if the wireless network's SSID is displayed.

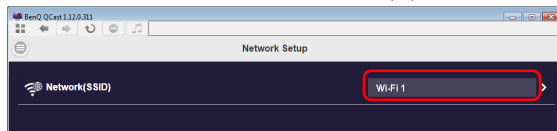

Remote Control

When you click **Remote Control** on the **Advanced** panel, a virtual keypad appears. It allows you to control the projector as if using the physical keypad on the projector.

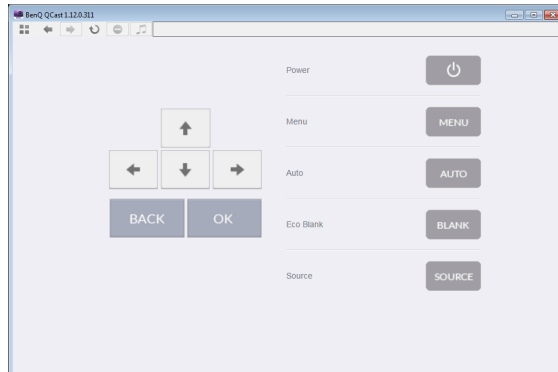

Preference

Preference allows users to set customized settings that are in effect when they are designated as the host.

Icon	Name	Description
	Preference	Allows users to set My Hostname , Preferred Device and Host Control .

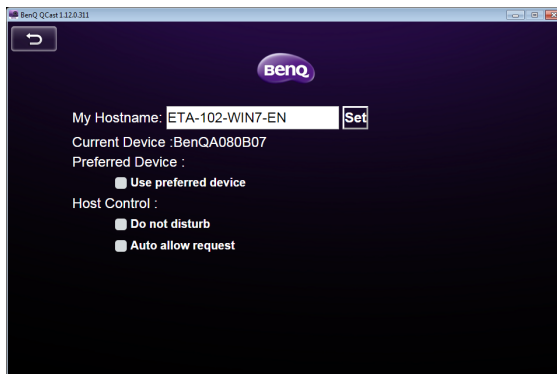

- **My Hostname:** Sets a custom name for your computer. Press **Set** to make the hostname go into effect.
- **Current Device:** Displays the projector which you are currently mirroring your screen to.
- **Preferred Device:** Check to make the current projector your default projector when using **QCast**.
- **Host Control:** Check **Do not disturb** to automatically reject projection requests from guests. Check **Auto allow request** to automatically accept projection requests from guests.

QCast supports up to 4 users presenting via a 4-way presentation. If **Auto allow request** and **Do not disturb** are not checked, a request confirmation box will appear on the host's screen whenever a guest attempts to project, as seen in the image below.

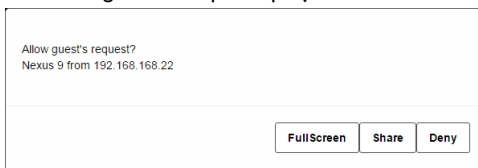

- **Full Screen:** Click **Full Screen** to accept the request and enter the full screen projection.
- **Share:** Click **Share** to accept the request and then decide to use the 2-way or 4-way projection.
- **Deny:** Click **Deny** to decline the request.

Projecting via **QCast** (for mobile devices)

QCast is an application that allows you to project your mobile device's screen as well as photos and documents saved on your computer on the BenQ network projector.

Minimum system requirements

Before installing and running **QCast**, please check to make sure your mobile device meets the requirements listed below.

- Mobile devices with Android Operating System (OS):
 - Supported OS version: Android 5.0
 - CPU: Quad Core equivalent or above
 - Memory: 1GB memory or more
 - Storage: At least 100MB free space needed
- Mobile devices with iOS:
 - Supported OS version: iOS 9 / 10 (The latest 2 versions will be supported.)
 - All iPhone models after iPhone 5 are supported
 - All iPad models after iPad mini 2 are supported
 - Storage: At least 100MB free space needed



BenQ does not guarantee compatibility in respective user environments. Certain users may experience compatibility issues when running **QCast**.

Prerequisite

The basic workflow for projecting via **QCast** is:

1. Select **Network Display** in the input source menu.
2. Download and install **QCast** using the app store of your mobile device.
3. Connect your mobile device to the projector.
4. Launch **QCast** and start projecting.

Selecting **Network Display** in the input source menu

Before projecting your computer's screen to the projector, you have to select **Network Display** in the input source menu.

1. Press **SOURCE** on the projector.
2. Highlight **Network Display** and press **OK**.

Downloading **QCast**

1. Ensure that the projector's input source is set to **Network Display**.

2. Make sure that your mobile device has Internet access. Scan the QR code displayed on the **Network Display** screen. The **QCast** download screen will appear on your mobile device.

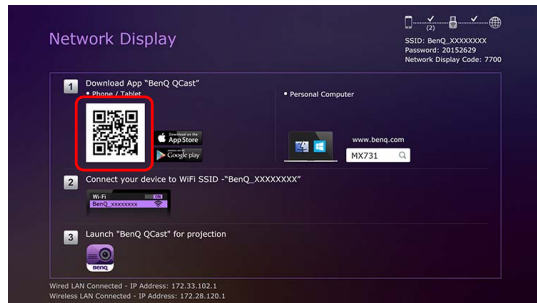

3. Follow on-screen instructions to download and install **QCast** on your mobile device.

Connecting your mobile device to the projector

To wirelessly connect your mobile device to the projector, follow step 2 shown on the **Network Display** screen, or see "[Wireless connections](#)" on page 8 for detailed instructions.

Launching QCast

1. Launch **QCast**.



2. Tap **QCast**.

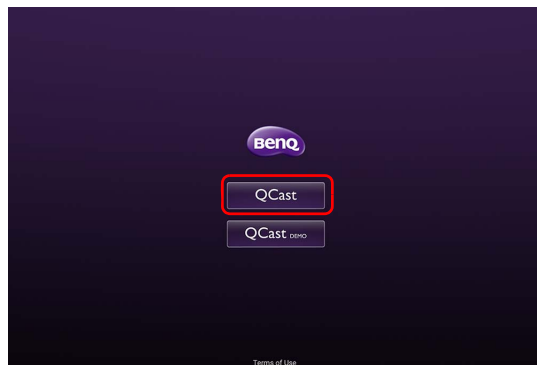

3. Tap the Search button to detect available projectors.

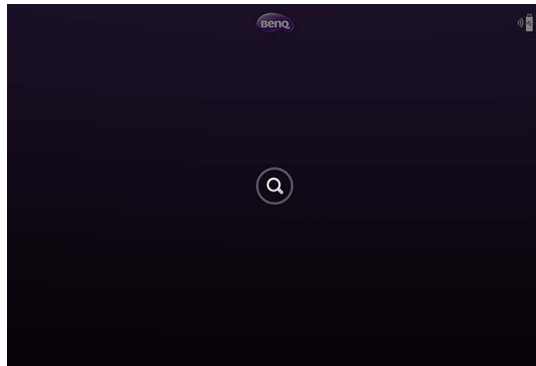

4. Tap the preferred projector and your mobile device will connect to the projector.

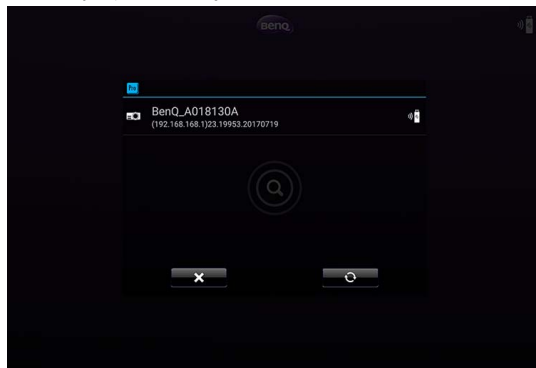

5. A preferred device prompt will display. Tap **Yes** if you want to set the projector as the default projector. If the projector is set as the default projector, the next time you launch **QCast** your computer will search for the projector and automatically connect to it if it is available through the network.

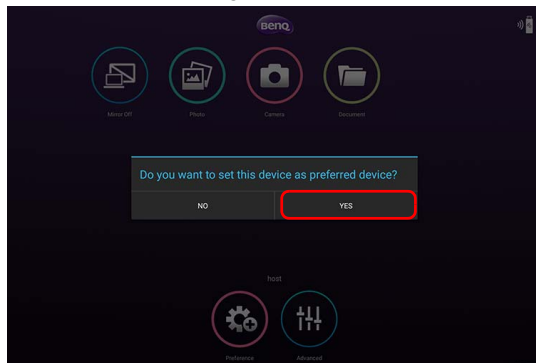

6. After you confirm or decline the preferred device setting for default projector in previous step, the **QCast** main screen will appear. You can start using **QCast**.

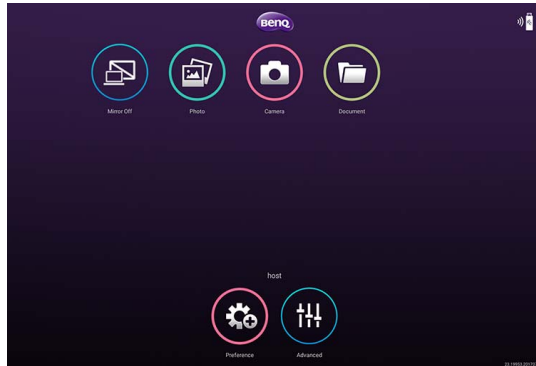

Using QCast

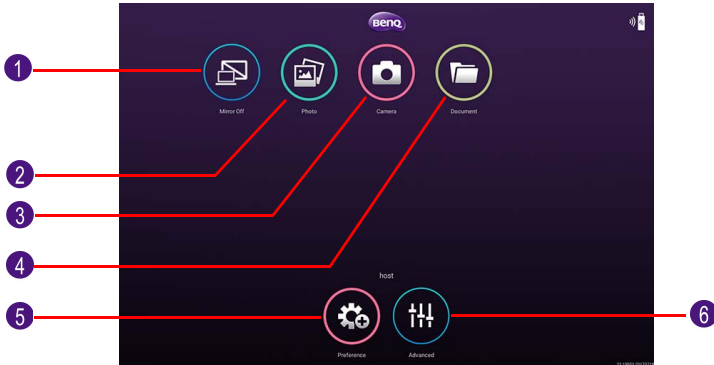

No.	Function	Description
1	Mirror Off / Mirror On	Allows you to mirror your screen to the projector. See "Mirror Off / Mirror On" on page 27 for details.
2	Photo	Allows you to display and share the images saved on your device. See "Photo" on page 28 for details.
3	Camera	Allows you to use your device's camera to broadcast a live video feed via the projector. See "Camera" on page 28 for details.
4	Document	Allows you to share the documents saved on your device. See "Document" on page 28 for details.
5	Preference	Allows you to set your personal preferences. See "Preference" on page 21 for details.
6	Advanced	Allows you to view more functions for QCast . See "Advanced" on page 17 for details.

Role assignment

The first user connected to the projector using **QCast** is designated as the host. Users that join subsequently are designated as guests. Only the host is allowed to use the **Advanced** function. See ["Advanced" on page 17](#) for details.

Network Display Code

If you are the first user (the host) connected to the projector, when you tap the **Mirror Off/On** button to mirror your computer screen on the projector, a password prompt will display requesting a password. You will need to enter the **Network Display Code** to start mirroring. The **Network Display Code** is displayed at the upper right corner of the **Network Display** screen.



- If the **Network Display** screen is not shown on the projector, press **SOURCE** on the projector and then select **Network Display** to view the screen.
- Subsequent users (the guests) do not have to enter the **Network Display Code** to join the session. However, their projection requests must be approved by the host. See "[Preference](#)" on [page 21](#) for details.

Mirror Off / Mirror On

You can switch between **Mirror Off** and **Mirror On** by tapping the **Mirror Off / Mirror On** button. This button will not be displayed on devices running iOS.

Icon	Name	Description
	Mirror Off	When Mirror Off is displayed, your screen is not mirrored on the projector.
	Mirror On	When Mirror On is displayed, your screen is mirrored on the projector, allowing other users can see your screen.

- If you are the first user and you click the **Mirror Off / Mirror On** button to switch to **Mirror On**, a password prompt will appear. See "[Network Display Code](#)" on [page 27](#) for details.

Photo

The **Photo** button allows you to share or display images saved on your device.

Icon	Name	Description
	Photo	<ul style="list-style-type: none">• Follow the on-screen instructions or the user interface of your device to share or display your images.• For sharing images saved on devices running iOS, the images have to be sent to QCast via iTunes.• When this function is first used on the devices running iOS, a request confirmation prompt will pop up.

Camera

The **Camera** button allows you to use your device's camera to broadcast a live video feed via the projector.

Icon	Name	Description
	Camera	<ul style="list-style-type: none">• When this function is first used on the devices with iOS, a request confirmation prompt will pop up.• Both portrait mode and landscape mode are supported.

Document

The **Document** button allows you to present and share the documents saved on your mobile device.

Icon	Name	Description
	Document	<ul style="list-style-type: none">• Follow the on-screen instructions or the user interface of your mobile device to present or share your documents.

Advanced

Advanced consists of **Conference**, **Network Setup** and **Remote Control** options. See "[Advanced](#)" on page 17 for details.

Icon	Name	Description
	Advanced	<ul style="list-style-type: none">• Consists of Conference, Network Setup and Remote Control options.• Only the host is allowed to access the options in the Advanced menu.• Guests will not be able to use the Advanced options and the button will be grayed out on their screens.

Preference

The **Preference** button allows users to set customized settings that are in effect when they are designated as the host.

Icon	Name	Description
	Preference	Allows users to set My Hostname , Preferred Device and Host Control . See " Preference " on page 21 for details.

Managing the projector using a web browser

Once the projector is connected to a wired local area network and the projector is on or in standby mode, you can use any computer that is in the same network to manage and control the projector via **BenQ Projector Control System** accessed through the computer's web browser.

Supported web browsers

Make sure you are using one of the following web browsers:

- Internet Explorer: 9 / 10 / 11
- Chrome: 55.0 / 56.0 / 57.0
- Safari: 8.0 / 9.0 / 10.0
- Firefox: 50.0 / 51.0 / 52.0

Configuring Standby Settings for the projector

In order to control the projector remotely while the projector is in standby mode, you need to enable the Network Standby Mode and Monitor Out settings for the projector. To do so, follow the steps below:

1. Press **MENU** on the projector to open the **Advanced Menu** options.
2. Highlight **System** and press **OK**.
3. Highlight **Standby Settings** and press **OK**.
4. Highlight **Network** and press **OK**.
5. Highlight **Enable Network Standby Mode** and press **OK**.
6. Select **On** then press **OK**.
7. Press **BACK** to return to **Standby Settings**.
8. Highlight **Monitor Out** and press **OK**.
9. Select **On** then press **OK**.

Accessing the BenQ Projector Control System

1. Make sure your computer and the projector are connected to the same local area network. See "[Wired connections](#)" on page 6 for details.
2. Launch the web browser on your computer.
3. Enter the IP address of the projector in the browser's address bar and press the computer's **Enter** key.





You can follow the steps described in "Setting up a wired network for the projector" on page 6 to check the projector's IP address. Alternatively, you can press **SOURCE** on the projector. Select **Network Display**. The IP address is displayed on the bottom left corner of the screen.

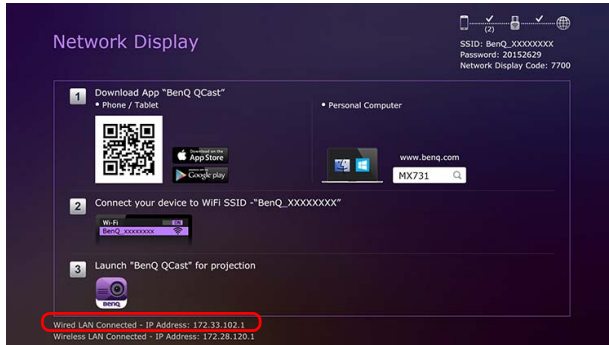

4. The main page of **BenQ Projector Control System** appears. This web page provides access to a variety of functions described in the following sections.

BenQ Projector Control System

Information

Virtual Keypad

Image Settings

Projector Setup

Crestron e-Control

Management

Network Settings

Projector Language

Logout

- Projector
 - Projector Device Name: T02
 - Model Name: MW732
 - Network Standby Status: On
 - Power Status: Power On
 - Lamp Mode: Smart Eco
 - Source: VGA
 - Picture Mode: Presentation
 - Resolution: 0000:000:00hz
 - Color System: Current No Source
 - Lamp Usage Time: 6 hr
 - BenQ Firmware Version: 0.11
 - BenQ Web Firmware Version: v011.52.023.013
- Wired LAN Status
 - Link Status: Connected
 - IP Address: 192.168.2.187
 - Subnet Mask: 255.255.255.0
 - Default Gateway: 192.168.2.254
 - DNS Server: 0.0.0.0
 - MAC Address: 00:73:22:00:60:08
- Wireless LAN Client Status
 - Link Status: Disconnected
 - Link SSID:
 - Link Channel:
 - IP Address: 0.0.0.0
 - Default Gateway: 0.0.0.0
 - DNS Server: 0.0.0.0

Main function

Virtual Keypad

The **Virtual Keypad** page displays a virtual keypad with which you can control the projector as if using the physical keypad on the projector.

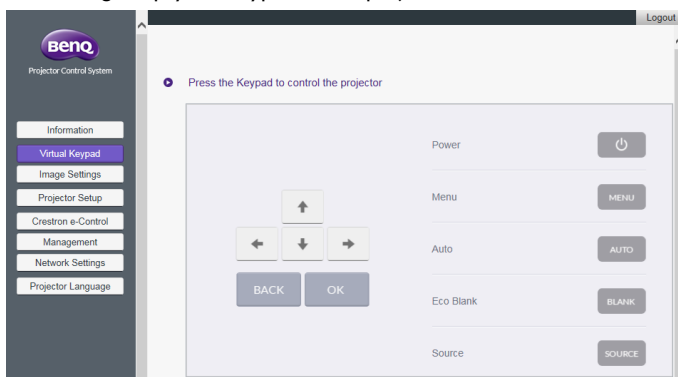

Image Settings

Image Settings consists of the **Picture** and **Display** pages.

Display

The **Display** page features **Auto Keystone** and **Corner Fit** options.

- **Auto Keystone:** Allows you to automatically adjust the keystone setting for the projector.
- **Corner Fit:** Allows you to correct image dimensions by adjusting each corner of an image when the projector is used to project within a restricted or unevenly rectangular frame.
- After making any adjustments, click **Apply** to have the adjustments take effect.

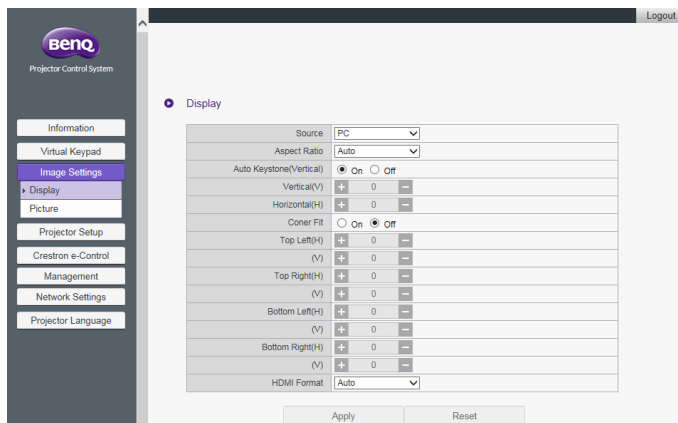



When adjusting **Auto Keystone** or **Corner Fit**, it is suggested to adjust each value in small intervals and then check if the image is projected as expected, as applied values may cause the projected image dimensions to exceed the edge of frame.

Picture

The **Picture** page allows you to adjust effects for projected images.

- **Color Temperature Tuning:** Allows you to adjust the color temperature.
- **Color Management:** Allows you to control conversion between the color representations of a variety of devices.
- After making any adjustments, click **Apply** to have the adjustments take effect.

The screenshot shows the BenQ Projector Control System web interface. On the left is a navigation menu with options: Information, Virtual Keypad, Image Settings (selected), Display, Picture (sub-selected), Projector Setup, Crestron e-Control, Management, Network Settings, and Projector Language. The main content area is titled 'Picture' and contains the following settings:

- Picture Mode: Presentation
- Reference Mode: Bright
- Brightness: 0
- Contrast: 0
- Color: 0
- Sharpness: 0
- Brilliant Color: Off
- Color Temperature: Cool
- Color Temperature Tuning:
 - R Gain: 0
 - G Gain: 0
 - B Gain: 0
 - R Offset: 0
 - G Offset: 0
 - B Offset: 0
- Color Management:
 - Primary Color: R (selected), G, B, C, M, Y
 - Hue: 0
 - Saturation: 0
 - Gain: 0

At the bottom of the settings area are 'Apply' and 'Reset' buttons.

Projector Setup

- **Setup Settings:** Allows you to choose the type of physical setting in which the projector is installed.
- **Lamp Mode:** Allows you to select different lamp mode to extend the lamp life as long as possible.
- After making any adjustments, click **Apply** to make the settings go into effect.

The screenshot shows the BenQ Projector Control System web interface. On the left is a navigation menu with options: Information, Virtual Keypad, Image Settings, Projector Setup (selected), Crestron e-Control, Management, Network Settings, and Projector Language. The main content area is titled 'Projector Setup' and contains the following settings:

- Projector Installation: Front Table
- Remote Receiver: Front
- Auto Source Search: On
- Lamp Settings:
 - Lamp Mode: SmartEco

At the bottom of the settings area are 'Apply' and 'Reset' buttons.

Crestron eControl

The **Crestron eControl** page displays the **Crestron eControl** and RoomView user interface. The eControl page provides a variety of virtual keys to control the projector or adjust the projected pictures.



No.	Function
1	Click the Tools tab for more setting options and Info tab for information on the projector.
2	Allows you to select the input source.
3	These buttons function in the same way as the buttons on the OSD menus or remote control. See the chapter “Controls and Functions” in the user manual for details.



The **Menu** button can also be used to return to the previous OSD menu, exit and save menu settings.

Tools

The **Tools** menu allows you to manage the projector, configure the wired LAN settings and protect access to the remote network operation for this projector. Every sub-menu can be configured separately. After making any adjustments, click **Send** to have the settings go into effect. Click **Exit** to return to the **BenQ Projector Control System** page.

The screenshot shows the BenQ Projector Control System web interface. The 'Tools' menu is highlighted in red. The interface is divided into five numbered sections:

- 1**: Projector settings including Projector Name (PROJECTOR), Comment (LOCATION), and Assigned To (GROUP). A 'Send' button is at the bottom.
- 2**: Network settings including DHCP (checked/Enabled), IP Address (0.0.0.0), Subnet Mask (0.0.0.0), Default Gateway (0.0.0.0), and DNS Server (0.0.0.0). A 'Send' button is at the bottom.
- 3**: User Password settings including an 'Enabled' checkbox, New Password, and Confirm fields. A 'Send' button is at the bottom.
- 4**: Admin Password settings including an 'Enabled' checkbox, New Password, and Confirm fields. A 'Send' button is at the bottom.
- 5**: An 'Exit' button at the bottom center.

No.	Function
1	Allows you to name the projector and add remarks for the projector. After making any adjustments, click Send to have the settings go into effect.
2	Allows you to configure the network settings. After making any adjustments, click Send to have the settings go into effect.
3	Allows you to set User Password . If User Password is enabled, a password will be required to access the remote network operation. After making any adjustments, click Send to have the settings go into effect.
4	Allows you to set Admin Password . If Admin Password is enabled, a password will be required for having access to the Tools page. After making any adjustments, click Send to have the settings go into effect.
5	Click Exit to return to the remote network operation page.

Info

The **Info** page includes the current status and information for this projector.

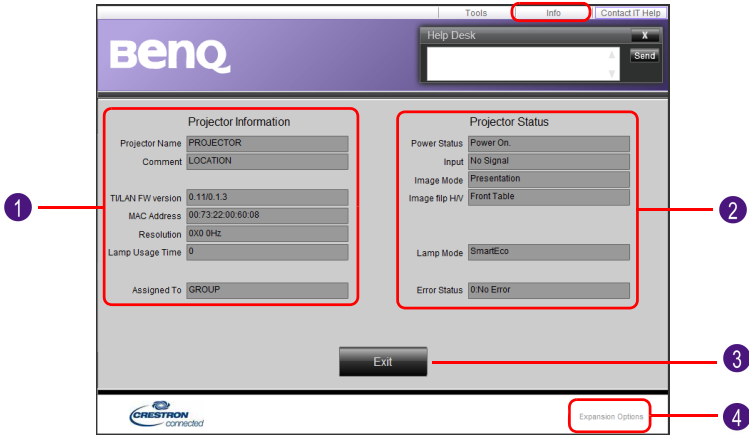

No.	Function
1	Displays basic information about the projector.
2	Displays the current status of the projector.
3	Click Exit to return to the remote network operation page.
4	Click Expansion Options for more information about the Crestron and RoomView monitoring and control system.

For more information about Crestron and RoomView monitoring and control system, visit <http://www.crestron.com> & <http://www.crestron.com/microsites/get-roomview>.

Management

The **Management** page allows you to name the projector for quick identification and set a password to protect the projector's configuration.

BenQ
Projector Control System

Information
Virtual Keypad
Image Settings
Projector Setup
Crestron e-Control
Management
Basic
Network Settings
Projector Language

Logout

Basic Settings

Projector Device Name

Security Settings

Panel Key Lock On Off

Web Control Lock On Off

Web Admin Account Name Change
Current Account admin
Enter New Account
Confirm New Account

Web Admin Password Change
Enter Old Password ****
Enter New Password
Confirm New Password

Apply Reset

- **Projector Device Name:** Allows you to name the projector.
- **Web Control Lock:**
 - When set to **Off** (default), users are allowed to access the **BenQ Projector Control System** and change the projector's configuration.
 - When set to **On**, users can only review the **Information** page. An admin password will be required to enter other function control pages.
- **Web Admin Account Name Change:** Allows you to change the admin account name. The default account name is admin.
- **Web Admin Password Change:** Allows you to change the admin password. The default admin password is 0000.



- Record the new admin password if you change the admin password. If the admin password is lost, you must contact BenQ Customer Center to make an unlock request.
- Web Admin Account Name and Web Admin Password can only be changed when **Web Control Lock** is set to **On**.

Alternatively, you can also enable the **Web Control Lock** using the projector's OSD menu:

1. Press **MENU** on the projector.
2. Highlight **Settings** and press **OK**.
3. Highlight **Security Settings** and press **OK**.
4. Highlight **Web Control Lock** and set it to **On**.



- Once **Web Control Lock** is set to **On**, you cannot set the **Web Control Lock** to **Off** via the projector's OSD. To set **Web Control Lock** to **Off**, you need to have the admin password and reset **Web Control Lock** to **Off** via the **BenQ Projector Control System**.

Network Settings

Network Settings consists of the **Wired LAN** and **Wireless LAN** pages.

Wired LAN

The **Wired LAN** page allows you to modify the Wired LAN settings.

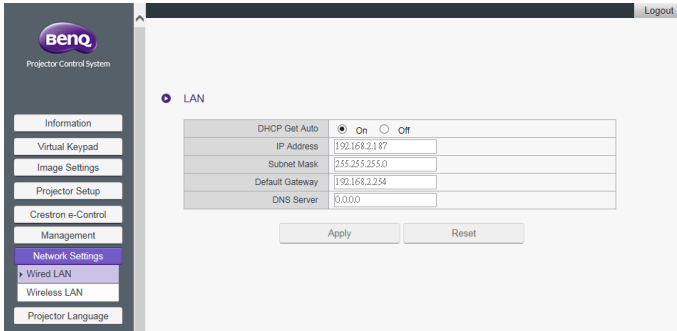

- **DHCP Get Auto:** If the projector is in a DHCP environment, set this setting to **On** to obtain the IP address provided by the DHCP server. Set this setting to **Off** if you want to configure the wired LAN settings manually.

Wireless LAN

The **Wireless LAN** page allows you to modify the wireless LAN settings.

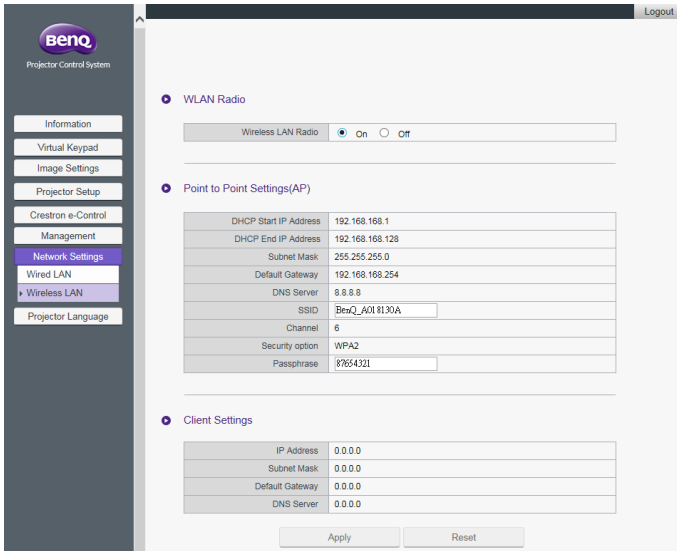

- The **Point to Point Settings (AP)** table will be blank if the projector is not installed with the BenQ WDRT8192 USB wireless dongle.
- **Wireless LAN Radio:** Allows you to reset the power for RF dongle.
- **SSID:** Allows you to modify the projector's ID for quick identification over the wireless network. The **SSID** has a maximum length of 13 alphanumeric characters.

- **Password:** Allows you to set the projector's login password. The **Password** has a maximum length of 8 alphanumeric characters.
- **Client Settings:** Displays the client settings only. It cannot be configured through this interface.

Projector Language

The **Projector Language** page allows you to change the projector's OSD interface language.

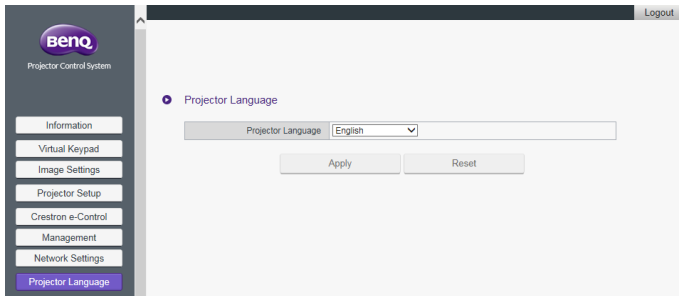

Accessing the Internet with a wireless connection

When a wireless network is set up for your projector as described in the [Wireless connections](#) section, connections to the projector by your computer or mobile device will lack internet access. You can obtain Internet access for the network either via **QCast** or the projector's OSD menu options.

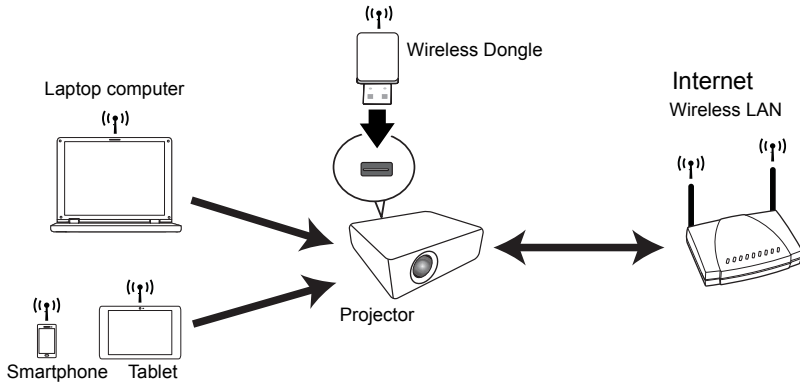

Accessing the Internet via QCast

1. Make sure the projector is installed with BenQ WDRT8192 USB wireless dongle and a wireless network is set up for the projector. See ["Setting up a wireless network for the projector"](#) on page 8 for details.
2. Make sure your computer or mobile device is connected to the wireless network created by the designated USB wireless dongle. See ["Connecting your computer or mobile device to the projector wirelessly"](#) on page 9 for details.
3. Launch **QCast**. Go to the **Network Setup** page in the **Advanced** menu and configure the network settings. See ["Accessing the Internet via Network Setup"](#) on page 19 for details.

Accessing the Internet via projector OSD

1. Press **MENU** on the projector.
2. Highlight **Network** and press **OK**.
3. Highlight **Wireless LAN** and press **OK**.
4. Highlight **Client** and press **OK**.
5. Highlight **Network (SSID)** and press **OK**.
6. Select a wireless network with Internet access and press **OK**.
7. Enter the password for the wireless network.
8. Highlight **Commit** and press **OK**.
9. Return to the **Client** page. Check if the **Status** is **Connect** and the SSID of the desired wireless network is displayed. If so, the projector is connected to the desired wireless network.
10. Connect your computer or mobile device to the projector.

Now you can access the Internet while your device is wirelessly connected to the projector.



- The display format for SSIDs only support alphanumeric characters and underscores. If a router's SSID does not match this format, the router's MAC address will be shown instead.
 - The projector can detect up to 16 router signals depending on the strength of the signal.
 - The network router supports WPA2 security and its password has a maximum length of 20 alphanumeric characters.
-

PJLink commands

This projector supports standard protocol PJLink for projector control. Supported commands are as below.



The below supported commands may vary depending on different models.

Command	Description	Parameter
POWER OFF	Power control.	0 = Power Off
POWER ON	Power control.	1 = Power On
Power?	Query the power status.	0 = Power Off 1 = Power On 2 = Cooling down 3 = Warm up
INPT	Input switch command.	11 = VGA1 12 = VGA2
INPT?	Query the current input switch status.	21 = SVideo 22 = CVBS 31 = HDMI 51 = CARD_READER 52 = LAN_DISPLAY 53 = USB_DISPLAY
AVMT	Mute control.	10 = Video mute off 11 = Video mute on
AVMT?	Query the current mute status.	20 = Audio mute off 21 = Audio mute on 30 = Video & Audio mute off 31 = Video & Audio mute on
LAMP?	Query the number of lamp hours.	Lamp hour
INST?	Query the list which enables input switch.	Return "11 12 21 22 31 51 52 53"
NAME?	Query the projector name.	Return "Digital Projector"
INF0?	Query resolution information.	Return "Education Series"
INF1?	Query the maker name.	Return "BenQ"
INF2?	Query the model name.	Return model name as below, "BenQ Projector"
CLSS?	Query class information.	Return "Version"
ERST?	Query the error status	Error Status
GET ALL	Query all status	Return all "?" items