

Dell Latitude E6540

Setup and Features Information

About Warnings

 **WARNING:** A WARNING indicates a potential for property damage, personal injury, or death.

Front and Back View

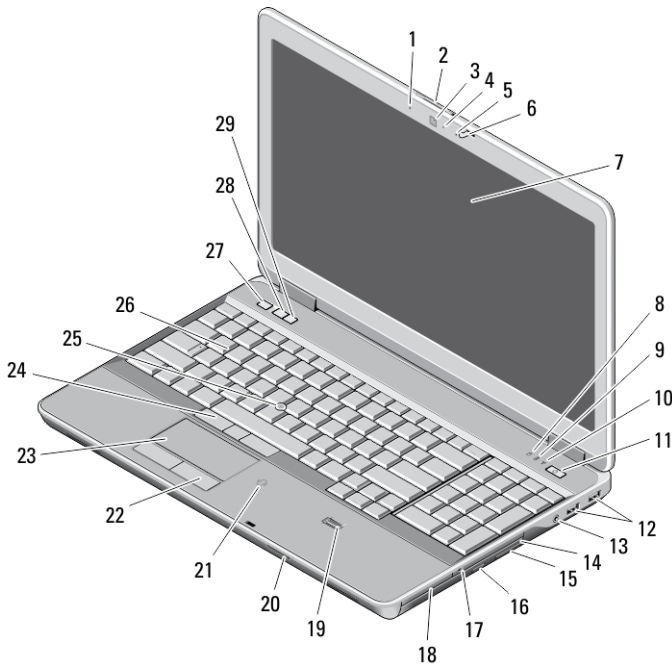

Figure 1. Front View

- | | |
|--------------------------|------------------------|
| 1. microphone | 3. camera |
| 2. display release latch | 4. camera status light |



Regulatory Model: P29F
Regulatory Type: P29F001
2013 - 04

- 5. microphone
- 6. display latch
- 7. display
- 8. hard-drive activity light
- 9. battery status light
- 10. wireless status light
- 11. power button
- 12. USB 3.0 connectors (2)
- 13. audio/microphone connector
- 14. optical drive
- 15. optical drive release latch
- 16. optical drive eject button
- 17. wireless switch
- 18. express-card reader
- 19. fingerprint reader
- 20. Secure Digital (SD) memory-card reader
- 21. contactless smart-card reader
- 22. touchpad buttons (2)
- 23. touchpad
- 24. trackstick buttons (2)
- 25. trackstick
- 26. keyboard
- 27. mute button
- 28. volume down button
- 29. volume up button

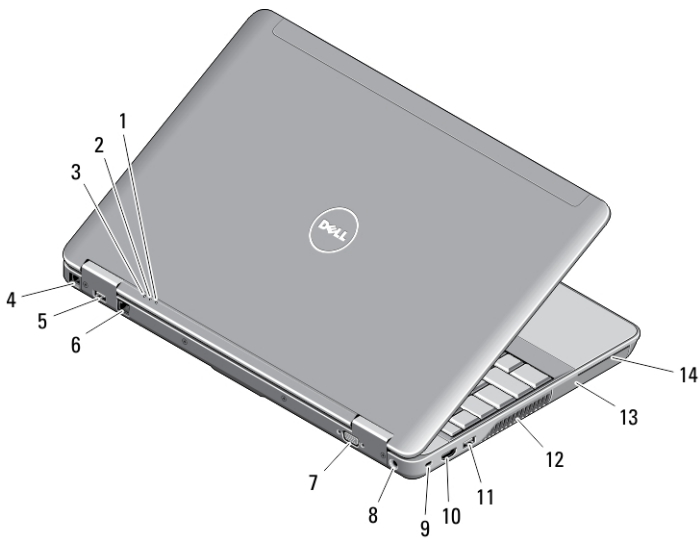

Figure 2. Back View

- 1. power status light
- 2. hard-drive activity light
- 3. battery status light
- 4. modem connector
- 5. USB 3.0 connector with PowerShare
- 6. network connector
- 7. VGA connector
- 8. power connector

- 9. security cable slot
- 10. HDMI connector
- 11. USB 3.0 connector
- 12. cooling vents
- 13. hard drive
- 14. smart card slot

⚠ WARNING: Do not block, push objects into, or allow dust to accumulate in the air vents. Do not store your Dell computer in a low-airflow environment, such as a closed briefcase, while it is running. Restricting the airflow can damage the computer or cause a fire. The computer turns on the fan when the computer gets hot. Fan noise is normal and does not indicate a problem with the fan or the computer.

Base View

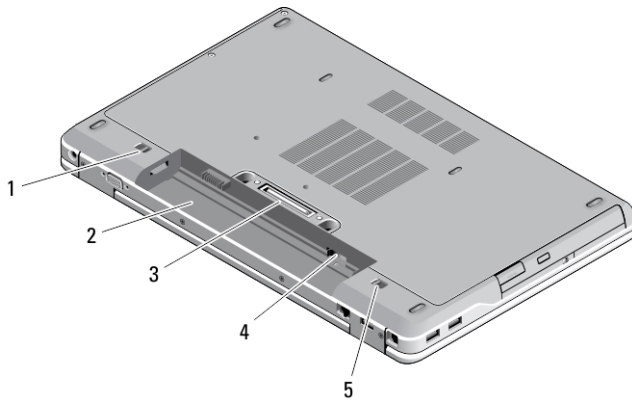





Figure 3. Base View

- 1. battery release latch (left)
- 2. battery bay
- 3. docking station connector
- 4. SIM card slot
- 5. battery release latch (right)

Quick Setup

 **WARNING:** Before you begin any of the procedures in this section, read the safety information that shipped with your computer. For additional best practices information, see www.dell.com/regulatory_compliance

 **WARNING:** The AC adapter works with electrical outlets worldwide. However, power connectors and power strips vary among countries. Using an incompatible cable or improperly connecting the cable to the power strip or electrical outlet may cause fire or equipment damage.

 **CAUTION:** When you disconnect the AC adapter cable from the computer, grasp the connector, not the cable itself, and pull firmly but gently to avoid damaging the cable. When you wrap the AC adapter cable, ensure that you follow the angle of the connector on the AC adapter to avoid damaging the cable.

 **NOTE:** Some devices may not be included if you did not order them.

1. Connect the AC adapter to the AC adapter connector on the computer and to the electrical outlet.

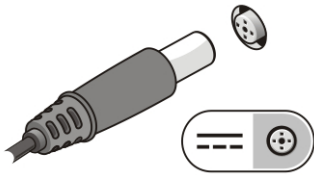

Figure 4. AC Adapter

2. Connect the network cable (optional).

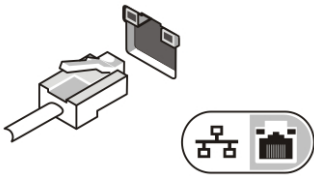

Figure 5. Network Connector

3. Connect USB devices, such as a mouse or keyboard (optional).

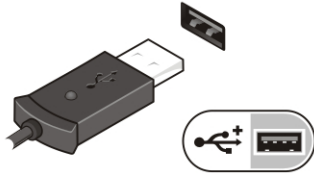

Figure 6. USB Connector

4. Open the computer display and press the power button to turn on the computer.

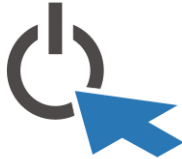



Figure 7. Power Button

-  **NOTE:** It is recommended that you turn on and shut down your computer at least once before you install any cards or connect the computer to a docking device or other external device, such as a printer.

Specifications

-  **NOTE:** Offerings may vary by region. The following specifications are only those required by law to ship with your computer. For more information regarding the configuration of your computer, click **Start** → **Help and Support** and select the option to view information about your computer.

Power

AC Adapter	65 W, 90 W and 130 W
Input Voltage	100 VAC to 240 VAC
Coin-cell battery	3 V CR2032 lithium coin cell

Physical

Height	33.40 mm (1.31 inches)
Width	379.00 mm (14.92 inches)
Depth	250.50 mm (9.86 inches)

Physical

Weight (with 4-cell battery) 2.36 kg (5.21 lb)

Environmental

Operating Temperature 0 °C to 35 °C (32 °F to 95 °F)

Information para NOM (únicamente para México)

The following information is provided on the device described in this document in compliance with the requirements of the official Mexican standards (NOM).

Voltaje de alimentación	100 V AC – 240 V AC
Frecuencia	50 Hz – 60 Hz
Consumo eléctrico	1,5 A/1,6 A/1,7 A/2,5 A
Voltaje de salida	19,50 V de CC
Intensidad de salida	3,34 A/4,62 A/6,7A

Finding More Information and Resources

See the safety and regulatory documents that shipped with your computer and the regulatory compliance website at www.dell.com/regulatory_compliance for more information on:

- Safety best practices
- Regulatory certification
- Ergonomics

See www.dell.com for additional information on:

- Warranty
- Terms and Conditions (U.S. only)
- End User License Agreement

Additional information on your product is available at www.dell.com/support/manuals

© 2013 Dell Inc.

Trademarks used in this text: Dell™, the DELL logo, Dell Precision™, Precision ON™, ExpressCharge™, Latitude™, Latitude ON™, OptiPlex™, Vostro™, and Wi-Fi Catcher™ are trademarks of Dell Inc. Intel®, Pentium®, Xeon®, Core™, Atom™, Centrino®, and Celeron® are registered trademarks or trademarks of Intel Corporation in the U.S. and other countries. AMD® is a registered trademark and AMD Opteron™, AMD Phenom™, AMD Sempron™, AMD Athlon™, ATI Radeon™, and ATI FirePro™ are trademarks of Advanced Micro Devices, Inc. Microsoft®, Windows®, MS-DOS®, Windows Vista®, the Windows Vista start button, and Office Outlook® are either trademarks or registered trademarks of Microsoft Corporation in the United States and/or other countries. Blu-ray Disc™ is a trademark owned by the Blu-ray Disc Association (BDA) and licensed for use on discs and players. The Bluetooth® word mark is a registered trademark and owned by the Bluetooth® SIG, Inc. and any use of such mark by Dell Inc. is under license. Wi-Fi® is a registered trademark of Wireless Ethernet Compatibility Alliance, Inc.