

M11-8MV

Instruction Manual



Content

Package Contents	1
Optional Accessories	1
Overview	2
Function Buttons	2
Control Panel	2
OSD Mode	3
Compound Key	3
LED Indicator	3
Device Connection	4
Power Connection to Wall Outlet	4
Power Connection to PC/Laptop	5
HDMI Connection	6
USB Connection	6
VGA Connection	7
Insert a Micro SD Card	7
Operate the Camera with AVerTouch	8
Playback Mode	9
Switch to Playback Mode	9
OSD Menu Buttons	10
Playback Menu Buttons	10
Slid Show	10
Interval	11

Storage	11
Delete File	11
Delete All	11
Using the Camera	12
Camera Head Angle	12
Camera Body Angle	12
Shooting Area	13
Object Position	14
Storage the Camera	14
Specification	15

Package Contents

The items below are included with this product. If any item is missing, contact the dealer from whom you purchased this product.

M11-8MV unit

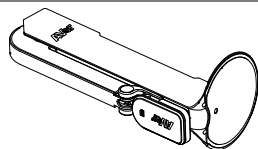

USB Cable

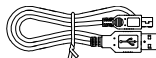

QR Code Card

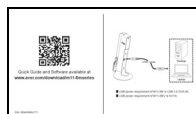

Optional Accessories

Carrying Bag



Anti-glare Sheet

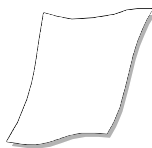



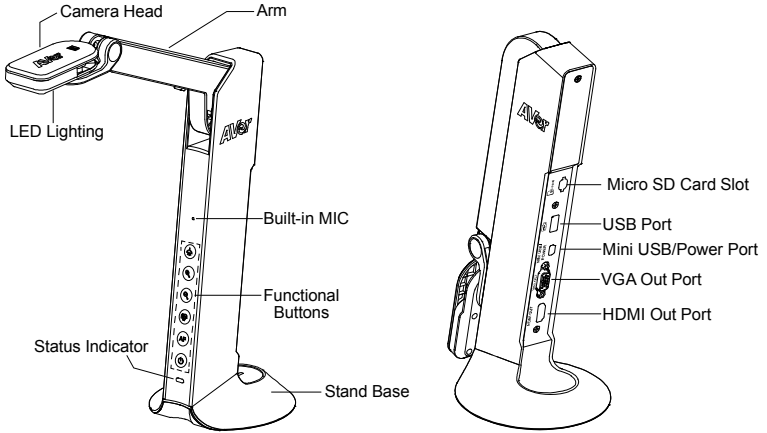



Overview







Function Buttons

Control Panel





Button	Function
	<ul style="list-style-type: none"> ■ Lamp on/off ■ Press and hold 3 seconds to call out OSD menu.
	Zoom in
	Zoom out
	<ul style="list-style-type: none"> ■ Rotate 0/180° ■ Press and hold 3 seconds to freeze the screen. Un-freeze, press and hold 3 seconds again.
	<ul style="list-style-type: none"> ■ Auto focus ■ Press and hold 3 seconds to start recording. <p>To stop recording, press and hold  3 seconds again</p>
	Power on/off

OSD Mode

Button	Function
	<ul style="list-style-type: none"> ■ Back to last menu level page ■ Exit from OSD menu
	Up(selection item)
	Down(selection item)
	Selection enter

Compound Key

Press keys to operate the compound key function.

Button	Function
 + 	Back to factory default settings.
 + 	Capture image

[Note] For **Recording** and **Capture**, please change to “**Power Supply only**” mode.

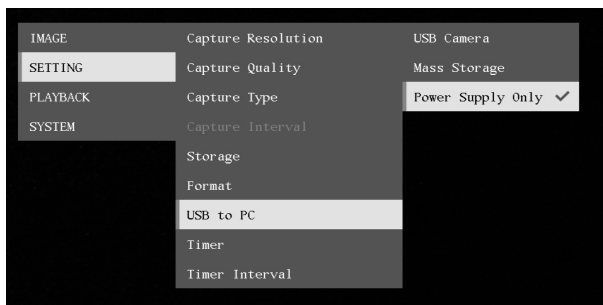

LED Indicator

Power 	<p>Solid green: Power on</p> <p>Solid red: Standby</p> <p>Flashing red: The camera is in start-up process</p>
---	--

Device Connection

Power Connection to Wall Outlet

1

Plug in power and turn on M11-8MV.

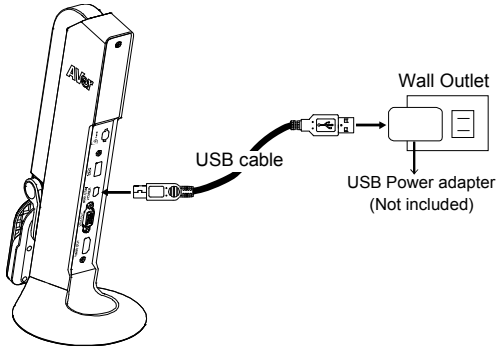

[Note]

- Use the USB cable which included in package connects to mini USB/ Power port of M11-8MV with USB power adapter (not included)to wall outlet.
- User needs to purchase a 5V/1A USB power adapter (not included) to connect the USB cable to wall outlet.
- When the camera is start-up, the power indicator is in flashing red.

Power Connection to PC/Laptop

1

Connect to USB port of PC/laptop for power supply.

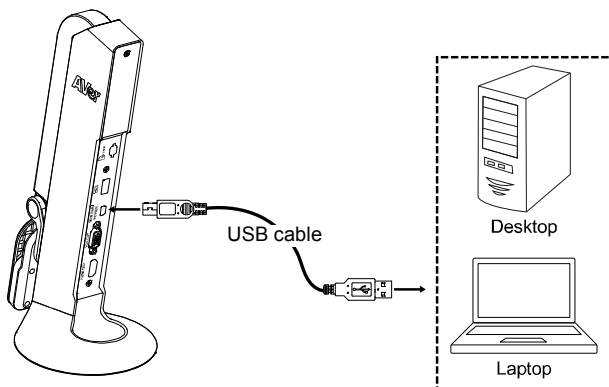

[Note]

- Use the USB cable which included in package connects to mini USB/ Power port of M11-8MV with laptop/PC.
- When the camera is start-up, the power indicator is in flashing red.
- USB power requirement of M11-8MV is USB 5V/1A.
- For Storage, Format, Capture, Recording and Playback functions, please change to “Power Supply Only” mode

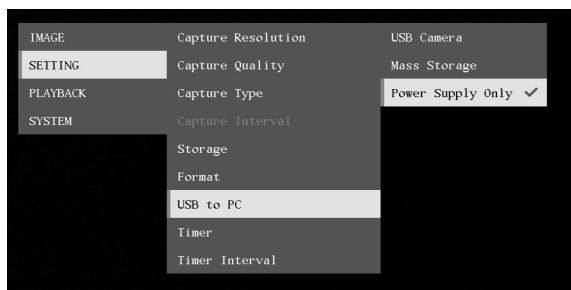

HDMI Connection

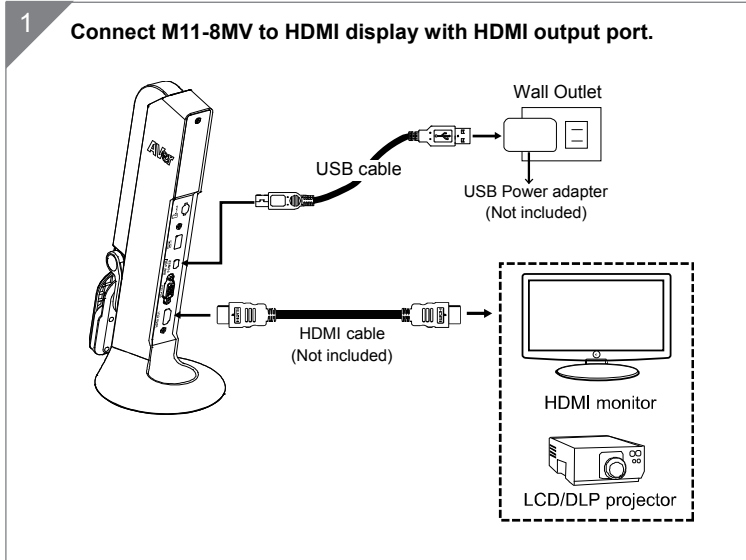

USB Connection

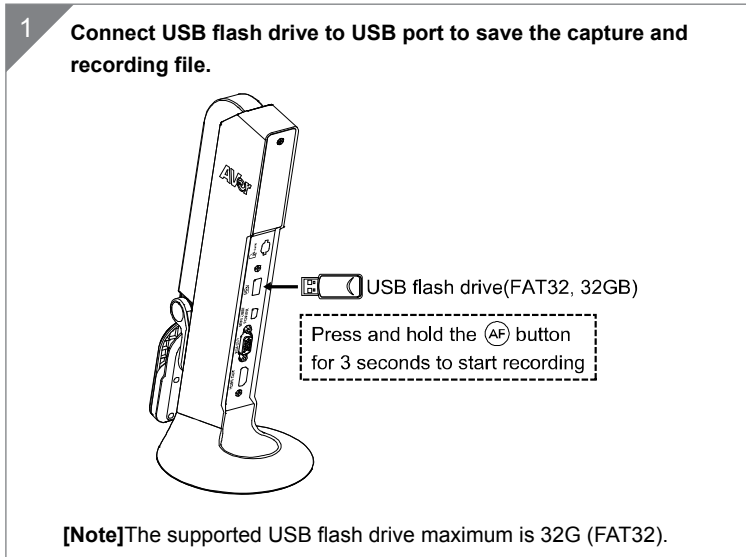

VGA Connection

1

Connect M11-8MV to VGA display with VGA output port.

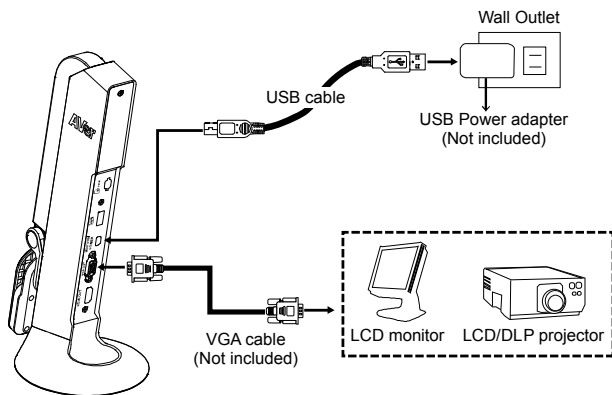

Insert a Micro SD Card

1

Insert the card to micro SD card slot.

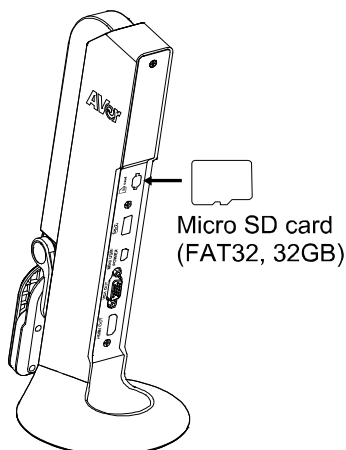

[Note]

- Micro SD card can storage capture images and recording files.
- The supported micro SD card capacity maximum is 32G (FAT32).

Operate the Camera with AVerTouch

1

Connect the camera to PC/laptop and Install the AVerTouch application.

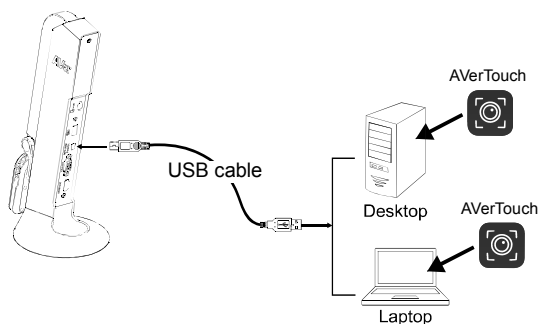

[Note]

- Download AVerTouch application at:
<https://presentation.aver.com/download-center/>
- Please set the camera to USB mode. Go to **OSD menu > Setting > USB to PC > USB Camera**.

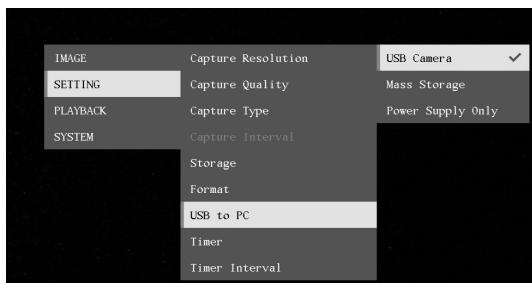

2

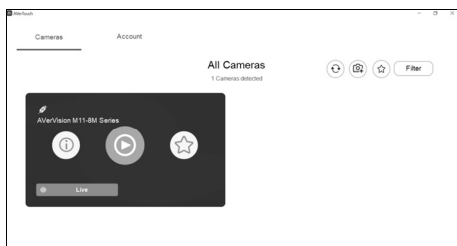

Open AVerTouch application, click  to connect the camera.











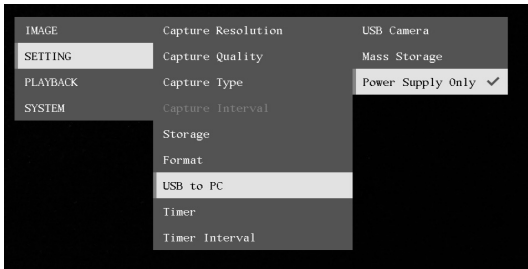



Playback Mode

View the capture images and recording files.

Switch to Playback Mode





1. In camera mode, press and hold  button for 3 seconds to call out OSD menu.
2. Use  and  button move to **Setting > USB to PC > Power Supply Only**.

















3. Use ,  and  button move to **Playback** selection.
4. Then, press  confirm the selection and switch to playback mode.
5. In Playback mode, use  +  and  +  buttons to select image or video to view manually. To play a video, press  button to start playback.
To pause playback, press  button again. Press  to stop playback.



OSD Menu Buttons

Button	Function
	Back to last menu level page
	Up(selection item)
	Down(selection item)
	Selection enter

Playback Menu Buttons

Button	Function
 + 	<ul style="list-style-type: none"> Image /video selection
 + 	<ul style="list-style-type: none">  + : Fast forward while playback video
 + 	<ul style="list-style-type: none">  + : Back to 1x playback speed
	Zoom in image
	Zoom out image
	<ul style="list-style-type: none"> Play video Press and hold to pause while video is playback
	Stop play video

Slid Show

To automatically play all capture images and recorded videos; but videos only display files and will not play video contents.



Interval

Set the interval before displaying the next picture. The length can be set up to 120 sec.



Storage

Select the source of the images and videos.

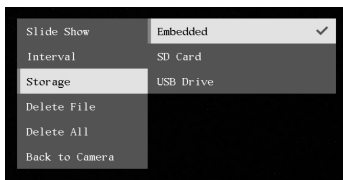

Delete File

Permanently delete the image or video in selected. A Warning Message will appear. Select **Yes** to continue and **No** to cancel the deletion.

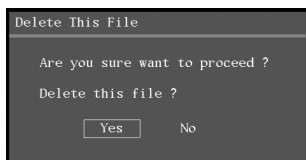

Delete All

Permanently delete all the data in selected memory source. A Warning Message will appear. Select **Yes** to continue and **No** to cancel the deletion.

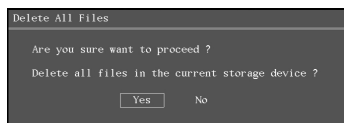

Using the Camera

Camera Head Angle

Move the camera head as figure shown.

[CAUTION] To avoid damage the camera head, hold the edge of the camera head to rotation the camera head.

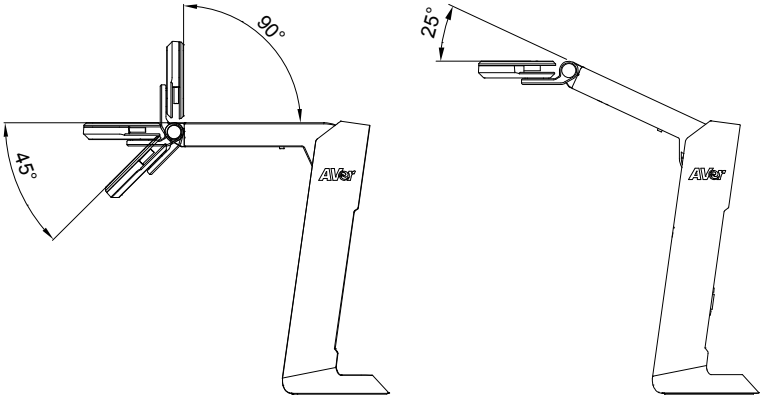
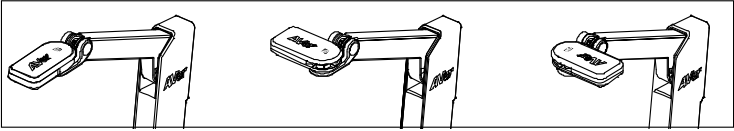

Camera Body Angle

[CAUTION] To avoid damage the camera unit, **DO NOT** pull the arm angle over 107°.

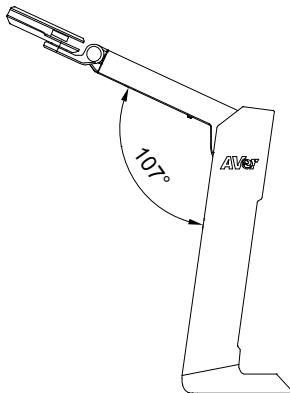

Shooting Area

When camera position is 342.4mm high, the shooting area will be A3 size.

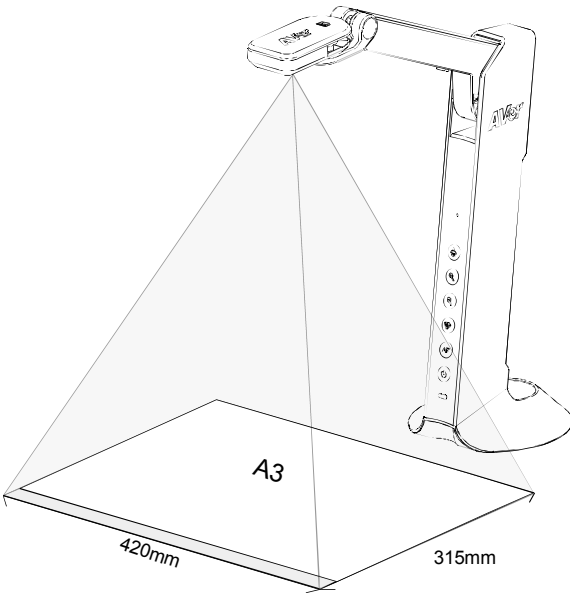
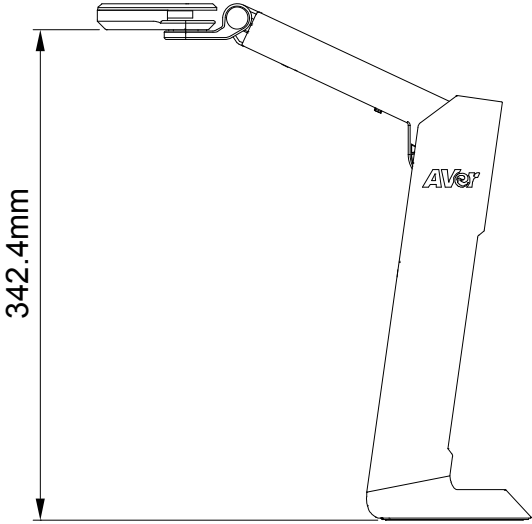

Object Position

The icon on top of camera head can help user to place objects in a positive direction.

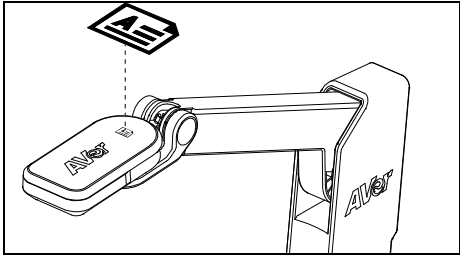

Storage the Camera

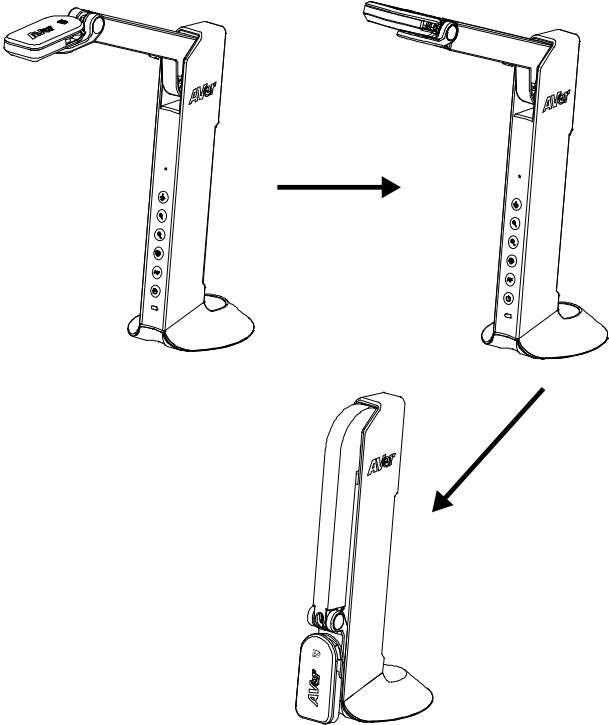

Specification

Sensor	1/3.06" CMOS sensor
Pixel Count	8MP
Frame Rate	Max.60fps(display)
Image mode	Normal/Motion /High Quality
Effect	Color / B&W / Negative
Focusing	Auto/Manual
Shooting Area	A3,420mm(H) * 315mm(V)
Zooming	20x digital zoom
Power Source	Mini-USB in, 5V/1A
Consumption	4.5 Watts(lamp on) 4 Watts(lamp off)
USB Bus Power	Yes, via mini-USB port
Lamp Type	LED light
USB	USB2.0 Type-A x1 (< 5V/0.1A, USB flash drive FAT32, 32GB) USB Type mini-B x 1(Power)
USB Output	3168 x 2376, 1920 x 1080, 1280 x 720, 1024 x 768, 800 x 600, 640 x 480
HDMI Output	1920 x 1080, 1280 x 720, 720 x 480
VGA Output	1920 x 1080, 1280 x 720, 720 x 480
Image Capture	120 pictures(2 megapixel)
Built-in MIC	Yes
Micro SD card slot	FAT 32,32GB
Operating	360.4mm(H)*116.7mm(W)*303.4mm(D)
Folded	296.1mm(H)*116.7mm(W)*143.1mm(D)
Net Weight	0.83 Kg
Gross Weight	1.301 Kg
Software support	AVerTouch

WARNING

- To reduce the risk of fire or electric shock, do not expose this appliance to rain or moisture. Warranty will be void if any unauthorized modifications are done to the product.
- Do not drop the camera or subject it to physical shock.
- Use the correct power supply voltage to avoid the damaging camera.
- Do not place the camera where the cord can be stepped on as this may result in fraying or damage to the lead or the plug.
- Hold the bottom of the camera with both hands to move the camera. Do not grab the lens or arm to move the camera.

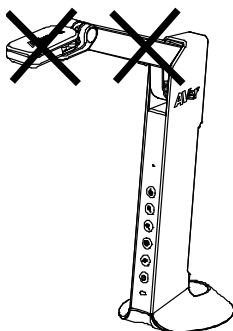

- Do not pull the camera arm and camera part in the opposite direction.

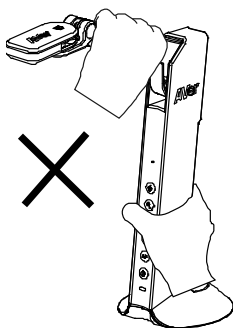

COPYRIGHT

©2020 AVer Information Inc. All rights reserved.

FEDERAL COMMUNICATIONS COMMISSION

NOTE: This equipment has been tested and found to comply with the limits for a Class A digital device, pursuant to part 15 of the FCC Rules. These limits are designed to provide reasonable protection against harmful interference when the equipment is operated in a commercial environment. This equipment generates, uses, and can radiate radiofrequency energy and, if not installed and used in accordance with the instruction manual, may cause harmful interference to radio communications. Operation of this equipment in a residential area is likely to cause harmful interference in which case the user will be required to correct the interference at his own expense.

FCC Caution: Any changes or modifications not expressly approved by the party responsible for compliance could void the user's authority to operate this equipment.

This device complies with part 15 of the FCC Rules.

Operation is subject to the following two conditions:

- (1) This device may not cause harmful interference, and
- (2) this device must accept any interference received, including interference that may cause undesired operation.

Warning:

This is a class A product. In a domestic environment this product may cause radio interference in which case the user may be required to take adequate measures.



THE MARK OF CROSSED-OUT WHEELED BIN INDICATES THAT THIS PRODUCT MUST NOT BE DISPOSED OF WITH YOUR OTHER HOUSEHOLD WASTE. INSTEAD, YOU NEED TO DISPOSE OF THE WASTE EQUIPMENT BY HANDING IT OVER TO A DESIGNATED COLLECTION POINT FOR THE RECYCLING OF WASTE ELECTRICAL AND ELECTRONIC EQUIPMENT. FOR MORE INFORMATION ABOUT WHERE TO DROP OFF YOUR WASTE EQUIPMENT FOR RECYCLING, PLEASE CONTACT YOUR HOUSEHOLD WASTE DISPOSAL SERVICE OR THE SHOP WHERE YOU PURCHASED THE PRODUCT.

DISCLAIMER

No warranty or representation, either expressed or implied, is made with respect to the contents of this documentation, its quality, performance, merchantability, or fitness for a particular purpose. Information presented in this documentation has been carefully checked for reliability; however, no responsibility is assumed for inaccuracies. The information contained in this documentation is subject to change without notice.

In no event will AVer be liable for direct, indirect, special, incidental, or consequential damages arising out of the use or inability to use this product or documentation, even if advised of the possibility of such damages.

More Help

For FAQs, technical support, software and instruction manual download, please visit:

Global:

<http://presentation.aver.com/download-center/>

Technical Support:

<https://aver.com/technical-support>

Contact Information

Global

AVer Information Inc.

www.aver.com

8F, No.157, Da-An Rd.

Tucheng Dist.

New Taipei City, Taiwan

Europe B.V.

AVer Information Inc.

www.aver.com

Westblaak 140, 3012KM

Rotterdam, Netherland

Tel: +31(0)10 7600 550

Technical support: EU.RMA@aver.com

