

# VC80x

## Vehicle-Mounted Computer



## User Guide for Android™ 7.1.2 Nougat



**ZEBRA**

---

## Copyright

© 2018 ZIH Corp. and/or its affiliates. All rights reserved. ZEBRA and the stylized Zebra head are trademarks of ZIH Corp., registered in many jurisdictions worldwide. Google, Android, Google Play and other marks are trademarks of Google LLC. All other trademarks are the property of their respective owners.

COPYRIGHTS & TRADEMARKS: For complete copyright and trademark information, go to [www.zebra.com/copyright](http://www.zebra.com/copyright).

WARRANTY: For complete warranty information, go to [www.zebra.com/warranty](http://www.zebra.com/warranty).

END USER LICENSE AGREEMENT: For complete EULA information, go to [www.zebra.com/eula](http://www.zebra.com/eula).

---

## Terms of Use

- Proprietary Statement

This manual contains proprietary information of Zebra Technologies Corporation and its subsidiaries (“Zebra Technologies”). It is intended solely for the information and use of parties operating and maintaining the equipment described herein. Such proprietary information may not be used, reproduced, or disclosed to any other parties for any other purpose without the express, written permission of Zebra Technologies.

- Product Improvements

Continuous improvement of products is a policy of Zebra Technologies. All specifications and designs are subject to change without notice.

- Liability Disclaimer

Zebra Technologies takes steps to ensure that its published Engineering specifications and manuals are correct; however, errors do occur. Zebra Technologies reserves the right to correct any such errors and disclaims liability resulting therefrom.

- Limitation of Liability

In no event shall Zebra Technologies or anyone else involved in the creation, production, or delivery of the accompanying product (including hardware and software) be liable for any damages whatsoever (including, without limitation, consequential damages including loss of business profits, business interruption, or loss of business information) arising out of the use of, the results of use of, or inability to use such product, even if Zebra Technologies has been advised of the possibility of such damages. Some jurisdictions do not allow the exclusion or limitation of incidental or consequential damages, so the above limitation or exclusion may not apply to you.

---

## Revision History

Changes to the original guide are listed below:

Change	Date	Description
-01 Rev A	12/2017	Initial release
-02 Rev A	4/2018	Added Display and Built-In Speaker to VC Settings. Added RS507x support. Updated instructions for Installing Applications Using a USB Drive. General edits.

# Table of Contents

Copyright .....	2
Terms of Use .....	2
Revision History .....	2

## About This Guide

Introduction .....	13
Configurations .....	13
Chapter Descriptions .....	13
Notational Conventions .....	14
Related Documents and Software .....	14
Service Information .....	15
Provide Documentation Feedback .....	15

## Getting Started

Introduction .....	16
Unpacking .....	16
Removing the Protective Film from the Display .....	16
Safety .....	17
Initial Operation Safety Considerations .....	17
Power Supply/Cable Safety .....	17
External Devices Safety .....	17
Features .....	18
Front Keys and LED Indicators .....	20
Front Keys .....	20
LED Indicators .....	21
Powering Up the VC80x .....	22
Powering Down the VC80x .....	22
Setting Up WLAN .....	22
Device Settings .....	22
Heater Status .....	22
Battery Management .....	22
Monitor Battery Usage .....	23
Low Battery Notification .....	23
Turning Off the Radios .....	24

**Installation**

Introduction ..... 25

Overview ..... 25

Mounting Instructions ..... 25

Installing the VC80x ..... 26

    Electrical Installation ..... 26

        Wiring Guidelines ..... 26

    Wiring Vehicle Power to the VC80x ..... 28

    External Antenna Installation ..... 28

    Positioning the VC80x in the Vehicle ..... 29

    Overview of the Assembly Steps ..... 29

    Cable Dust Cover ..... 29

    Strain Relief ..... 30

    Installing the VC80x on a Forklift ..... 31

Forklift Battery Replacement Conditions ..... 32

Starting from Cold Soak ..... 32

Installing the Power Pre-Regulator ..... 33

Non-Vehicle Installations ..... 33

Power On/Off with Ignition ..... 34

Screen Blanking Wiring ..... 35

    Connecting Switch for Screen Blanking ..... 35

**Using the VC80x**

Google Mobile Services ..... 36

Home Screen ..... 36

    Status Bar ..... 38

        Status Icons ..... 38

        Notification Icons ..... 39

Managing Notifications ..... 40

    Setting Application Notifications ..... 40

    Viewing Notification Settings for All Apps ..... 40

    Controlling Lock Screen Notifications ..... 41

Quick Access Panel ..... 41

    Edit Icons on Quick Settings ..... 42

Application Shortcuts and Widgets ..... 42

    Adding an Application to the Home Screen ..... 43

    Adding a Widget to the Home Screen ..... 43

    Moving Items on the Home Screen ..... 43

    Removing an Application Shortcut or Widget from the Home Screen ..... 43

Folders ..... 43

    Creating a Folder ..... 43

    Naming Folders ..... 43

    Removing a Folder ..... 44

Home Screen Wallpaper ..... 44

Using the Touchscreen ..... 44

On-Screen Keyboards ..... 45

    Editing Text ..... 45

    Entering Numbers, Symbols and Special Characters ..... 45

    Switching Language Keyboards ..... 45

    Configuring the Keyboard ..... 46

## Table of Contents

Applications .....	47
Accessing Applications .....	50
Switching Between Recent Applications .....	51
Un-Locking the Screen .....	51
Resetting the Device .....	53
Performing a Soft Reset .....	53
Performing a Hard Reset .....	54
Suspend Mode .....	54
Transferring Files .....	55
Using a USB Drive .....	55
Disconnecting USB Drive .....	56

### Applications

Battery Manager .....	57
Device Central .....	60
Peripherals Tab .....	61
My Device .....	62
Paging an RS6000 Ring Scanner .....	62
Heater Control .....	64
Temperatures .....	64
Serial Port Heater .....	65
USB Port Heater .....	65
Battery Heater .....	65
VC Settings .....	66
Display .....	67
Peripheral Power .....	67
Ignition Detection .....	67
WIFI Antenna Switching .....	68
Built-In Speaker .....	68
Screen Blanking .....	68
File Browser .....	69
Contacts .....	71
Adding a Contact .....	71
Editing Contacts .....	72
Deleting Contacts .....	72
Gallery .....	73
Photos .....	74
DataWedge Demonstration .....	76
Sound Recorder .....	78
PTT Express Voice Client .....	79
Speaker/Microphone Setup .....	79
PTT Audible Indicators .....	79
Notification Icons .....	80
Enabling PTT Communication .....	81
Selecting a Talk Group .....	81
PTT Communication .....	81
Creating a Group Call .....	81
Responding with a Private Response .....	81
Disabling PTT Express Voice Client Communication .....	82
RxLogger .....	83

## Table of Contents

Enabling Logging .....	83
Disabling Logging .....	84
RxLogger Configuration .....	84
ANR Module .....	84
Kernel Module .....	85
Logcat Module .....	85
LTS Module .....	86
Ramoops Module .....	87
Resource Module .....	87
Snapshot Module .....	87
TCPDump Module .....	88
Tombstone Module .....	88
Enabling Logging .....	88
Disabling Logging .....	88
Extracting Log Files .....	89
RxLogger Utility .....	90
App View .....	90
Viewing Logs .....	91
Backup .....	92
Archiving .....	93
Overlay View .....	93
Removing the Main Chat Head .....	93
Viewing Logs .....	94
Removing a Sub Chat Head Icon .....	95
Backup .....	95
Diagnostic Tool .....	96
Settings .....	100
Battery Test Information .....	100
GPS Test Information .....	101
System Test Information .....	101
WLAN Test Information .....	101
WWAN Test Information .....	101
Bluetooth Test Information .....	101
Velocity .....	102
Scanner Setup in Velocity .....	102
<b>Data Capture</b> .....	
Imaging .....	103
Operational Modes .....	104
Laser Scanning .....	104
Scanning Considerations .....	104
Barcode Capture with RS6000 Bluetooth Ring Scanner .....	105
Barcode Capture with RS507/RS507x Hands-Free Imager .....	106
Bar Code Capture with Zebra Scanner .....	107
Connecting an RS-232 Scanner .....	108
Connecting a USB Scanner .....	110
Connecting Using Simple Serial Interface .....	110
Connecting Using HID Mode .....	110
Pairing the RS507/RS507x/RS6000 Hands-Free Imager .....	111
Pairing Using Simple Serial Interface .....	111

## Table of Contents

Pairing Using Human Interface Device .....	112
Pairing a DS3678 Scanner .....	113
Pairing Using Simple Serial Interface .....	113
Pairing a DS3678 Scanner Using Human Interface Device .....	114
DataWedge .....	114
Enabling DataWedge .....	114
Disabling DataWedge .....	114
<b>Wireless</b>	
Wireless Local Area Networks .....	115
Scan and Connect to a Wi-Fi Network .....	115
Remove a Wi-Fi Network .....	117
Configuring a Wi-Fi Network .....	117
Manually Adding a Wi-Fi Network .....	118
Configuring for a Proxy Server .....	119
Configuring the Device to Use a Static IP Address .....	120
Wi-Fi Settings .....	121
Advanced Wi-Fi Settings .....	122
Wi-Fi Direct .....	124
WPS Pin Entry .....	125
Additional Wi-Fi Advanced Features .....	126
Zebra Mobility Extensions .....	127
Bluetooth .....	128
Adaptive Frequency Hopping .....	128
Security .....	128
Bluetooth Profiles .....	129
Bluetooth Power States .....	129
Bluetooth Radio Power .....	130
Enabling Bluetooth .....	130
Disabling Bluetooth .....	130
Discovering Bluetooth Device(s) .....	130
Changing the Bluetooth Name .....	130
Connecting to a Bluetooth Device .....	131
Selecting Profiles on the Bluetooth Device .....	131
Unpairing a Bluetooth Device .....	131
<b>Accessories and Mounting</b>	
Introduction .....	132
Accessories .....	132
VC80x Antenna Options .....	135
VC80x Mounting Accessories .....	136
MT43XX RAM Mount .....	137
Optional Mounts .....	137
Plate Bases for MT35XX Mounts .....	138
MT4200 Quick Release Mount .....	139
Assembling MT4200 .....	139
Attaching MT4200 to VC80x .....	140
MT4210 Adapter Bracket .....	141

**DataWedge Configuration**

Introduction .....	142
Profiles .....	142
Profile0 .....	142
Plug-ins .....	143
Input Plug-ins .....	143
Process Plug-ins .....	143
Output Plug-ins .....	143
Profiles Screen .....	144
Profile Context Menu .....	144
Options Menu .....	145
Disabling DataWedge .....	145
Creating a New Profile .....	145
Profile Configuration .....	146
Associating Applications .....	147
Data Capture Plus .....	149
Bar Code Input .....	152
Enabled .....	152
Scanner Selection .....	152
Decoders .....	153
Decoder Params .....	155
Codabar .....	155
Code 11 .....	155
Code128 .....	156
Code39 .....	157
Code93 .....	157
Composite AB .....	158
Discrete 2 of 5 .....	158
GS1 DataBar Limited .....	158
HAN XIN .....	158
Interleaved 2 of 5 .....	158
Matrix 2 of 5 .....	159
MSI .....	159
Trioptic 39 .....	159
UK Postal .....	159
UPCA .....	160
UPCE0 .....	160
UPCE1 .....	160
US Planet .....	161
Decode Lengths .....	161
UPC EAN Params .....	161
Reader Params .....	163
Scan Params .....	165
UDI Parameters .....	166
Keep Enabled on Suspend .....	166
Serial Port Input from Serial Port 1 .....	166
Serial Port Input from Serial Port 2 .....	166
Keystroke Output .....	167
Intent Output .....	168
Intent Overview .....	169
IP Output .....	170



## Table of Contents

Usage .....	171
Using IP Output with IPWedge .....	172
Using IP Output without IPWedge .....	173
Generating Advanced Data Formatting Rules .....	174
Configuring ADF Plug-in .....	175
Creating a Rule .....	175
Defining a Rule .....	176
Defining Criteria .....	176
Defining an Action .....	178
Deleting a Rule .....	179
Order Rules List .....	179
Deleting an Action .....	181
ADF Example .....	181
DataWedge Settings .....	184
Importing a Configuration File .....	185
Exporting a Configuration File .....	186
Importing a Profile File .....	186
Exporting a Profile .....	186
Restoring DataWedge .....	186
Configuration and Profile File Management .....	187
Enterprise Folder .....	187
Auto Import .....	187
Programming Notes .....	187
Overriding Trigger Key in an Application .....	187
Disable DataWedge on Device and Mass Deploy .....	188
Soft Scan Feature .....	188
Sample .....	188
Scanner Input Plugin .....	188
Function Prototype .....	189
Parameters .....	189
Return Values .....	189
Example .....	189
Comments .....	189
Enumerate Scanners .....	190
Function Prototype .....	190
Parameters .....	190
Return Values .....	190
Comments .....	191
Set Default Profile .....	191
Default Profile Recap .....	191
Usage Scenario .....	192
Function Prototype .....	192
Parameters .....	192
Return Values .....	192
Example .....	193
Comments .....	193
Reset Default Profile .....	194
Function Prototype .....	194
Parameters .....	194
Return Values .....	194
Example .....	194

## Table of Contents

Comments .....	194
Switch To Profile .....	195
Profiles Recap .....	195
Usage Scenario .....	195
Function Prototype .....	195
Parameters .....	195
Return Values .....	196
Example .....	196
Comments .....	196
Notes .....	197
<b>Settings</b>	
Introduction .....	198
Setting the Date and Time .....	198
Display Setting .....	198
Setting the Screen Brightness .....	199
Setting Screen Timeout Setting .....	199
Setting Font Size .....	199
Setting Screen Rotation .....	200
General Sound Setting .....	201
Do Not Disturb Feature .....	203
Limit Sounds and Vibrations .....	203
Total Silence .....	203
Alarms Only .....	204
Priority Notifications Only .....	204
Automatically Block Sounds and Vibrations .....	205
Silence Sounds During Certain Times .....	205
Silence Sounds During Events and Meetings .....	205
Turn Sounds Back On .....	205
Override Do Not Disturb for Specific Apps .....	205
Screen Unlock Settings .....	206
Set Screen Unlock Using PIN .....	206
Set Screen Unlock Using Password .....	207
Set Screen Unlock Using Pattern .....	208
Passwords .....	209
System Language Usage .....	210
Adding Languages .....	210
Selecting a Language .....	210
Removing a Language .....	210
Adding Words to the Dictionary .....	210
Keyboard Settings .....	211
Enabling Keyboards .....	211
Configuring a Keyboard .....	211
Key Programmer .....	212
Remapping a Button .....	212
About Phone .....	213
<b>Application Deployment</b>	
Introduction .....	215

## Table of Contents

Security .....	215
Secure Certificates .....	215
Installing a Secure Certificate .....	215
Configuring Credential Storage Settings .....	216
Development Tools .....	217
Android .....	217
EMDK for Android .....	218
StageNow .....	218
ADB USB Setup .....	218
Enabling USB Debugging .....	219
Application Installation .....	219
Installing Applications Using a USB Drive .....	219
Installing Applications Using the Android Debug Bridge .....	220
Uninstalling an Application .....	222
Performing a System Update .....	223
Download the System Update Package .....	223
Using USB Drive .....	224
Using ADB .....	225
Verify System Update Installation .....	226
Performing an Enterprise Reset .....	226
Download the Enterprise Reset Package .....	226
Using a USB Drive .....	226
Using ADB .....	227
Performing a Factory Reset .....	227
Download the Factory Reset Package .....	227
Using a USB Drive .....	228
Using ADB .....	228
Storage .....	229
Random Access Memory .....	229
Internal Storage .....	230
External Storage .....	232
Formatting a USB Drive .....	234
Enterprise Folder .....	236
Application Management .....	236
Viewing Application Details .....	237
Managing Downloads .....	238
<b>Maintenance and Troubleshooting</b>	
Introduction .....	239
Cleaning .....	239
Housing Cleaning .....	239
Touchscreen Cleaning .....	239
Touchscreen .....	239
Screen Calibration .....	240
Troubleshooting .....	242
<b>Specifications</b>	
Introduction .....	245
Technical Specifications .....	245

## Table of Contents

VC80x Drill Hole Dimensions .....	248
-----------------------------------	-----

# About This Guide

---

## Introduction

This guide provides instructions for setting up, operating, configuring, and maintaining the VC80x vehicle-mount computer.



**NOTE** Screens and windows pictured in this guide are samples and can differ from actual screens.



**WARNING!** Before transporting, assembling, and starting the computer, please read this manual carefully and follow all the safety guidelines and requirements.

---

## Configurations

The VC80x offers different configurations to suit various work requirements. Some of the configuration options include:

- Qualcomm 8056 1.8 GHz hexa-core 64 bit with power optimization and 4 GB RAM
- Sunlight Readable Display
- Internal and External Antenna
- Freezer Condensing
- Android 7.1.2 Nougat Google™ Mobile Services (GMS) or Android Open Source Project (AOSP)
- Basic I/O.



**NOTE** For detailed configuration and part number information, contact your Zebra representative.

---

## Chapter Descriptions

Topics covered in this guide are as follows:

- [Getting Started](#) provides information on safety guidelines and initial VC80x setup.
- [Installation](#) provides instructions on installing the VC80x.
- [Using the VC80x](#) provides information for operating the VC80x.

- [Applications](#) provides information on using applications installed on the VC80x.
- [Data Capture](#) explains how to capture data using the optional scanners.
- [Wireless](#) provides information on the various wireless options.
- [Accessories and Mounting](#) describes the accessories and mounting options available for the VC80x.
- [DataWedge Configuration](#) describes how to use and configure the DataWedge application.
- [Settings](#) provides the settings for configuring the VC80x.
- [Application Deployment](#) provides information for developing and managing applications.
- [Maintenance and Troubleshooting](#) includes instructions on cleaning the VC80x and provides troubleshooting solutions for potential problems during device operations.
- [Specifications](#) summarizes the device's intended operating environment and technical specifications.

---

## Notational Conventions

The following conventions are used in this document:

- **Bold** text is used to highlight the following:
  - Dialog box, window and screen names
  - Drop-down list and list box names
  - Check box and radio button names
  - Icons on a screen
  - Key names on a keypad
  - Button names on a screen.
  - Chapters and sections in this guide
- Bullets (•) indicate:
  - Action items
  - Lists of alternatives
  - Lists of required steps that are not necessarily sequential.
- Sequential lists (e.g., those that describe step-by-step procedures) appear as numbered lists.

---

## Related Documents and Software

The following document provides more information about the VC80x vehicle-mount computer.

- VC80x Quick Reference Guide, p/n MN-003133-xx - includes VC80x setup information and regulatory information.
- U-Mount Bracket Installation Guide, p/n MN-002931-xx - includes the instructions to install the U-Mount Bracket Kit (KT-U-MOUNT-VC80-R) and dimensions.
- Adapter Bracket Kit for VC50 U-Mount Installation Guide, p/n MN-002932-xx - provides instruction on installing the Adapter Bracket Kit (MNT-VC80-ADPA1-1) to attach the VC80x to the VC5090 U-Mount.
- Adapter Bracket Kit for Honeywell U-Mount Installation Guide, p/n MN-002934-xx - provides instruction on installing the Adapter Bracket Kit (MNT-VC80-ADPB1-1) to attach the VC80x to the Honeywell U-Mount Bracket.

- Keyboard Elastomer Installation Instructions, p/n MN-003089-xx - provides instructions for installing the keyboard to the VC80x.

For the latest version of this guide and all guides, go to: <http://www.zebra.com/support>.

---

## Service Information

If you have a problem with your equipment, contact Zebra Customer Support for your region. Contact information is available at: <http://www.zebra.com/support>.

When contacting support, please have the following information available:

- Serial number of the unit
- Model number or product name
- Software type and version number.

Zebra responds to calls by email, telephone or fax within the time limits set forth in support agreements.

If your problem cannot be solved by Zebra Customer Support, you may need to return your equipment for servicing and will be given specific directions. Zebra is not responsible for any damages incurred during shipment if the approved shipping container is not used. Shipping the units improperly can possibly void the warranty.

If you purchased your Zebra business product from a Zebra business partner, contact that business partner for support.

---

## Provide Documentation Feedback

If you have comments, questions, or suggestions about this guide, send an email to [EVM-Techdocs@zebra.com](mailto:EVM-Techdocs@zebra.com).

# Getting Started

---

## Introduction

The VC80x is a rugged, vehicle mounted computer running Android 7.1.2 operating systems. Wireless communications are supported over a 802.11 WLAN network. The Bluetooth module supports Bluetooth printers and scanners. The VC80x can be used with or without an external keyboard. There are six programmable macro keys on the front bezel and when used with the Blue modifier key, provides six additional programmable keys.

The VC80x is intended for use in commercial and industrial applications with a focus on real time wireless data transactions with options suiting materials handling applications in warehouses, manufacturing facilities, ports, yards, and freezers.

---

## Unpacking



**WARNING!** Before operating the unit for the first time, carefully read [Safety on page 17](#).



**NOTE** Configure the computer before fastening it to machines or vehicles.

Carefully remove all protective material from the device and save the shipping container for later storage and shipping.

Inspect the equipment for damage. If any equipment is missing or damaged, contact the Zebra Support Center immediately. See [Service Information on page 15](#) for contact information.

## Removing the Protective Film from the Display

The front display of the VC80x is protected during transport by a transparent film. This film should remain on the front display during assembly to avoid damage to the front display surface. Only remove the film once all of the assembly work has been completed.



### Safety

In order to prevent injury and damage, observe the following safety guidelines prior to assembly and commissioning. The VC80x is a multifunction vehicle computer for stationary and mobile use in commercial environments such as, warehouses, manufacturing, yard/ports, and freezers. Different or extraordinary usage is not permitted. For resulting damage, the user/operator of the VC80x is solely responsible. This also applies to any changes that you make to the device. Compliance with the safety guidelines is particularly important for the proper use of this device. The manufacturer assumes no liability for any and all damages that can be attributed to non-compliance with these guidelines.

#### Initial Operation Safety Considerations

- Installation/Initial Operation - Perform VC80x installation in accordance with [Installation](#). Specifically, pay special attention to the various electrical potentials of the vehicle. Some vehicles have a chassis that is connected to one of the battery supply lines (DC+ or DC-), while most electrically-driven forklift vehicles have floating chassis, connected to neither DC+ or DC-. See [Wiring Vehicle Power to the VC80x on page 28](#) for required wiring of vehicle power and fusing for the VC80x.
- Risk of injury during transit or installation - The unit can fall during transit or installation and cause injury. Always ensure that there are two persons available when installing or removing the device.
- Ensure that no persons are injured in case the mounting bracket breaks - The VC80x may not be installed in such a way that persons can be injured during a breaking of the mounting bracket (e.g. fatigue break). If the device is mounted in a place where people can be injured if the bracket breaks, apply appropriate safety measures (e.g. install a security cable in addition to the device bracket).

#### Power Supply/Cable Safety

The main power cord shall comply with the national safety regulations of the country where the equipment is to be used.

- Operation in an emergency - In case of an emergency (such as damage to the power cable or housing, or ingress of liquid or other foreign bodies), disconnect the device immediately from the power supply. Contact technical support staff at once.
- Protection of the power supplies - If, after replacement, the fuse fed by the internal power supply blows, send the device for servicing immediately.
- Danger of electrocution when cleaning/servicing the device - In order to avoid electrocution, always disconnect the VC80x from the power supply before cleaning or servicing the device.
- Do not exceed maximum voltage when charging the vehicle battery - While charging the vehicle battery, disconnect the VC80x from the battery or ensure that the maximum allowed input voltage of the VC80x is not exceeded.
- Do not switch on devices with damaged cables or plugs - Do not use the VC80x if a cable or plug is damaged. Replace damage parts immediately.
- Do not connect or disconnect cables during storms - Cables must never be connected or disconnected during an electrical storm.

#### External Devices Safety

The use of additional wiring and other peripheral devices, which are not recommended or sold by the manufacturer, can result in fire, electrocution or personal injury.

- If a power supply is used, only use the power supply recommended by the manufacturer.

- Before connecting or disconnecting peripheral devices (exception: USB devices), disconnect the VC80x from the power supply to avoid serious damage to both the VC80x and the connected devices.

## Features

Figure 1 VC80x Front View

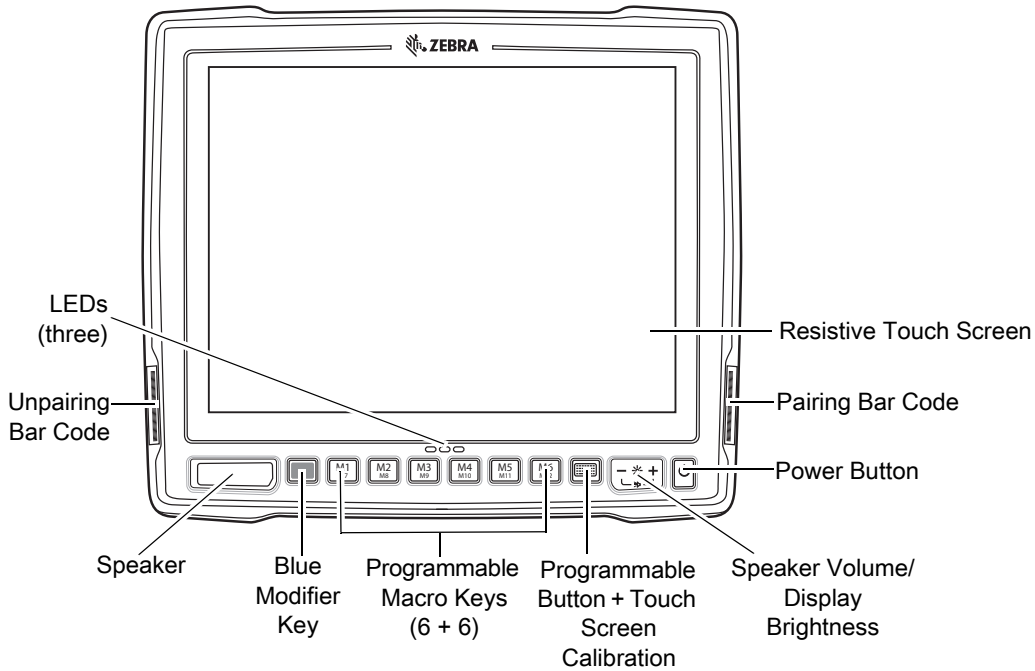
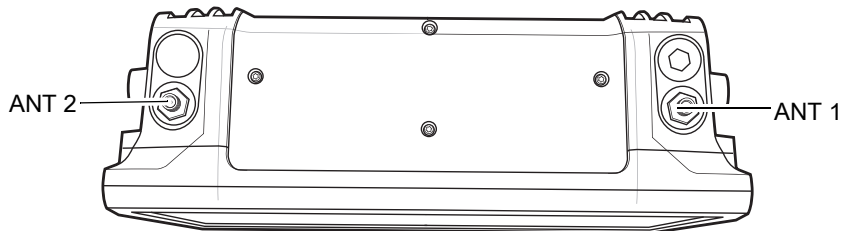


Figure 2 VC80x Top View

802.11 a/b/g/n/ac Radio External Antenna Connectors



ANT 1 - Reverse Polarity SMA Jack (WLAN & BT) / External Main Antenna  
 ANT 2 - Reverse Polarity SMA Jack (WLAN) / External Aux Antenna

- ✓ **NOTE** WiFi antennas are not shipped with the VC80x and must be ordered as a separate accessory. VC80x can be switched between internal and external antenna. For a complete list of configurations see [Table 9 on page 132](#).

Figure 3 VC80x Back View with Dust Cover

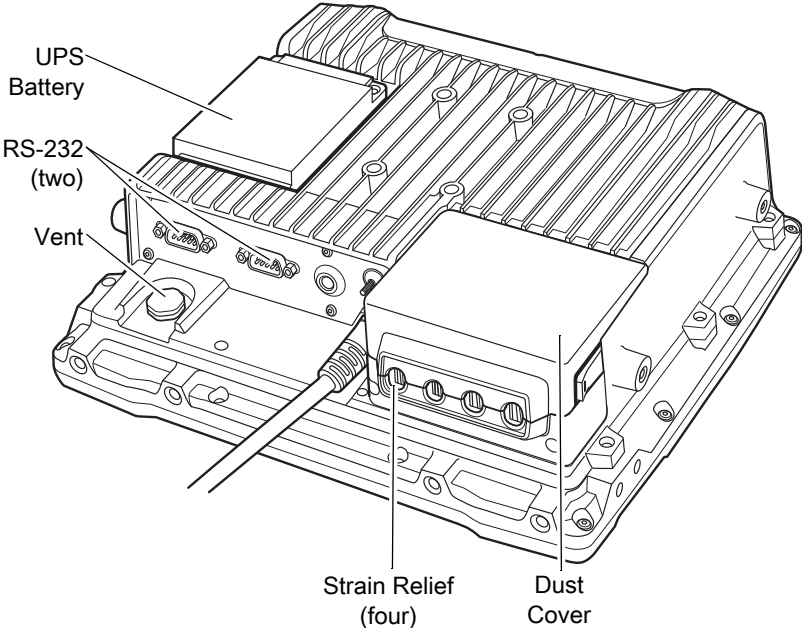
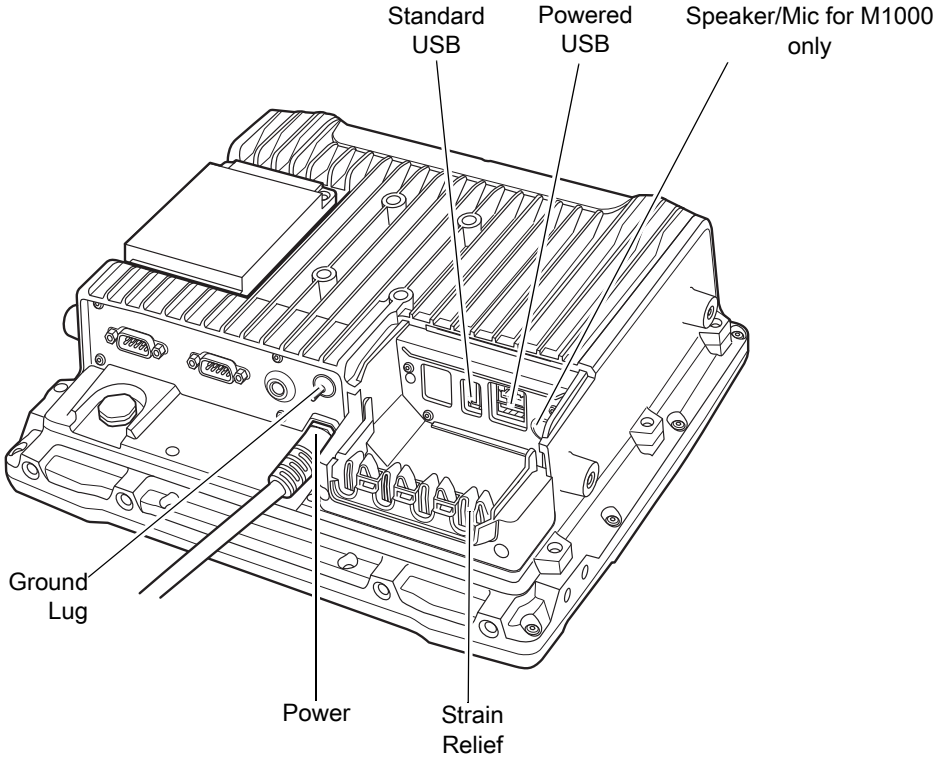


Figure 4 VC80x Back View without Dust Cover



## Front Keys and LED Indicators

The VC80x has the following front bezel keys and LEDs:

### Front Keys

**Table 1** VC80x Front Keys

Front	Function
<b>Power Keys</b>	
On/Off Button	Powers the VC80x On or Off. Use the On/Off button to reset the device. See <a href="#">Resetting the Device on page 53</a> .
Speaker/Display	Speaker volume and display brightness adjustment button. Use - to decrease brightness and use +) to increase the brightness. Press Blue key then use - to decrease volume and use + to increase volume.
Programmable Key	Opens the Key Programmer app. When used with the Blue modifier key, opens the touch screen calibration tool.
Blue Modifier Key	Modifies programmable macro keys allowing for an additional six programmable keys. Press the Blue Modifier key twice to lock the key on and to unlock, press the key once again.
Macro Keys Programmable	Six programmable macro keys. When used with the Blue modifier key, six additional programmable keys are provided. Keys may be mapped in the Key Programmer settings. By default the Marco keys are mapped as F1 through F12.
<b>Bar Codes</b>	
Pairing Bar Code	Pair peripheral Bluetooth scanners to the VC80x.
Unpairing Bar Code	Unpair peripheral Bluetooth scanners to the VC80x.
<b>Speaker</b>	
Front Speaker	Located on front bezel.

## LED Indicators

**Table 2** VC80x LED Indicators

Green/Amber LED	Red LED	Blue LED	Description
Off	Off	Off	No external power and the VC80x is not running on UPS.
Amber On	Off	Off	External power is available but the VC80x is not turned On (in shutdown mode). The VC80x is ready to be turned on and is currently charging the UPS battery.
Green On	Off		External power is available and the VC80x is turned ON. The UPS battery is charging.
Green Flashing (50% Duty Cycle On at 500 ms Period)			External power is removed. The VC80x is running on UPS battery power.
Green Flashing (25% Duty Cycle On at 4000 ms Period)	Off	Off	The VC80x is in sleep mode.
Green On	Off	Off	Bezel keyboard keys: M1, M2, M3, M4, M5, M6. Display brightness buttons active.
Green On	Off	On	Bezel keyboard keys: M7, M8, M9, M10, M11, M12. Volume buttons active.
	Flashing Red (50% Duty Cycle On at 500ms Period)		Temperature related warning or error event in the system. No action is required if the OS is running. If the OS is in Sleep or Hibernate state, then the EC should switch the VC80x Off.
Off	On	Off	Warm up condition. The OS is not running. The Power Button is disabled.



**NOTE** For fields in the above table without LED information, the LED can be On or Off dependent on user actions and ambient temperature.

---

## Powering Up the VC80x

Power up the VC80x after connecting all of the devices.

To power up the VC80x, connect to an appropriate power supply and press the Power button (see [Figure 1](#)) or the ignition signal.



**CAUTION** Make sure there is a suitable disconnecting device such as a power switch or circuit breaker in the power supply circuit. See [Installing the VC80x on page 26](#) for more information.

---

## Powering Down the VC80x

Always shut down the VC80x as follows:

1. Press the Power button until the menu appears on the screen.
2. Touch **Power off**.
3. Touch **OK**.

---

## Setting Up WLAN

To connect to a WLAN, see [Scan and Connect to a Wi-Fi Network on page 115](#).

---

## Device Settings

The user can configure the VC80x setting:

- Date and Time settings. See [Setting the Date and Time on page 198](#).
- Display settings, see [Display Setting on page 198](#).
- Sound settings, see [General Sound Setting on page 201](#).



---

## Heater Status

The VC80x offers a unique heater system that enables continuous operations in freezer environments. See [Heater Control on page 64](#) for information about the heater settings.

---



## Battery Management

To check the charge status of the backup battery, open **Settings** and touch  **About phone > Battery Information** or touch  **About phone > Status**.

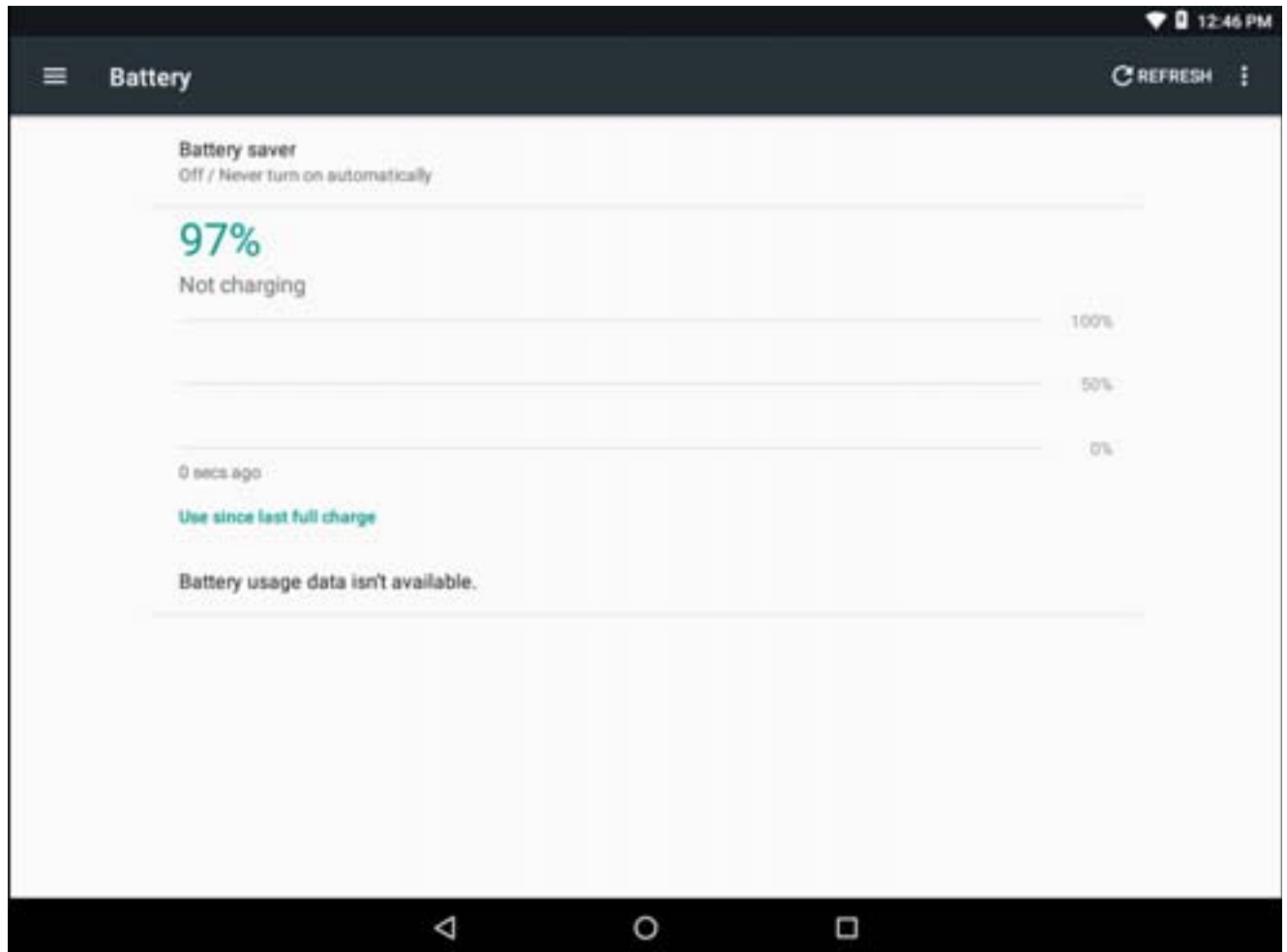
**Battery status** indicates that the battery is discharging and **Battery level** lists the battery charge (as a percentage of fully charged).

## Monitor Battery Usage

The **Battery** screen lists which applications consume the most battery power. Also use it to turn off applications that were downloaded if they are consuming too much power.

1. Swipe down from the status bar and then touch .
2. Touch  **Battery**.

**Figure 5** Battery Screen



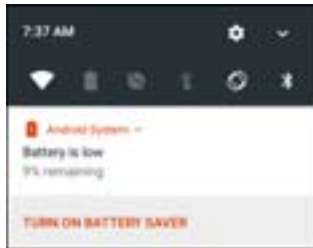
The **Battery** screen lists the applications using the battery. The discharge graph at the top of the screen shows the rate of the battery discharge since last charged (short periods of time when connected to a charger are shown as thin green lines at the bottom of the chart), and how long it has been running on battery power.

Touch an application in the **Battery** screen to display details about its power consumption. Different applications display different information. Some applications include buttons that open screens with settings to adjust power use.

## Low Battery Notification

When the battery charge level drops below 30%, the VC80x displays a notice to connect the VC80x to power. The user should charge the battery using one of the charging accessories.

**Figure 6** Low Battery Notification



When the battery charge drops below 15%, the VC80x displays a notice to connect the VC80x to power. The user must charge the battery using one of the charging accessories.

When the battery charge drops below 7%, the VC80x turns off.

The user must charge the VC80x using one of the charging accessories.

## Turning Off the Radios

To turn off all the radios:

1. Press the Power button until the menu appears.
2. Touch **Airplane mode**. The airplane icon ✈ appears in the Status bar indicating that all the radios are off.



# Installation

---

## Introduction

This chapter provides instructions on installing the VC80x.

---

## Overview

The VC80x can be installed in a variety of ways:

- Position the VC80x horizontally on a desk or mounted on a vehicle console.
- Wall mount the VC80x using the optional wall mount (see [VC80x Mounting Accessories on page 136](#)).
- Overhead mount on a lift truck cage using mounting hardware.

Depending on the vibration resistance and pivoting demands, mounting brackets, clamp feet or RAM mount elements can also be used to attach the device. Contact your Zebra sales office to find out more about the range of available installation options.



**WARNING!** The unit could fall during transit or installation/mounting and cause injury. Always ensure that there are two people available when installing or removing the device.

---

## Mounting Instructions

Follow and retain the mounting instructions included with assembly kit when installing the VC80x. See [Safety on page 17](#) for safety instructions.

## Installing the VC80x

### Electrical Installation

There are various electrical potentials when installing the unit on a vehicle such as a forklift.

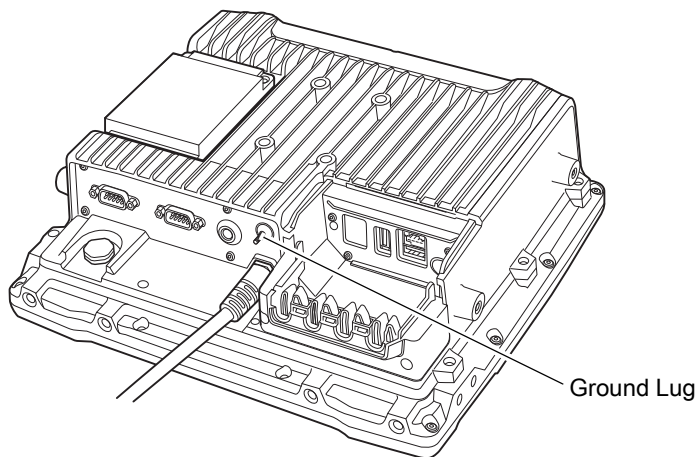


**WARNING!** Most electrically driven forklift vehicles have floating chassis connected to neither DC+ or DC-. However, electrical faults can cause the battery + or - to be connected to the chassis via low resistance paths. All connected peripherals must be completely isolated.

The VC80x accepts DC power sources with a minimum of 10VDC nominal and 48VDC nominal. A Power Pre-regulator is required for voltages above 48VDC nominal.

Applying a voltage above 48VDC nominal without the pre-regulator or reversing polarity may result in permanent damage to the VC80x and voids the product warranty.

Figure 7 VC80x Ground Lug



**CAUTION** Attach the VC80x connecting cable as close to the battery as possible. Connecting the VC80x to large electrical loads, such as converters for the forklift motor may result in random restarts, malfunctions and/or irreparable damage to the device.

To connect devices fed by other power sources to the VC80x, such as printers, power up the peripheral devices at the same time or after the VC80x to avoid start-up problems, malfunctions or irreparable damage to the device.

### Wiring Guidelines

The metal chassis of the VC80x is equipped with a ground lug (located on the underside adjacent to the power cable) to provide additional ground to the vehicle. It is strongly recommended that a grounding strap is used to connect the ground stud on the vehicle-mount to a solid, reliable contact point on the main portion of the vehicle chassis. It must not be connected to battery negative or terminal block.

As with other vehicle cables, carefully consider the routing of the ground strap to ensure it does not pose a hazard to the operator or the safe operation of the vehicle. If necessary, secure the ground strap with cable ties or some other mechanical means to prevent loops or loose lengths of wire from catching on stationary items when the vehicle is in motion.

Before installing the cables between the mount and other devices, consider the following:

- Ensure that drilling holes do not damage the vehicle or its wiring.
- Protect cable runs from pinching, overheating and physical damage.
- Use grommets to protect cables that pass through metal.
- Use plastic straps and tie-downs to secure cables and connectors in their desired location, away from areas where they may get snagged or pulled.
- Keep cables away from heat sources, grease, battery acid and other potential hazards.
- Keep cables away from control pedals and other moving parts that may damage the cables or interfere with the operation of the vehicle.



**IMPORTANT** Make sure the cables run inside the roll cage of the vehicle.

If the VC80x is installed in an environment where earth ground is present such as a vehicle with metal wheels running on a metal track, or is powered by the AC/DC adaptor in a permanent installation, the ground lug must be connected to the ground structure.

## Wiring Vehicle Power to the VC80x



**WARNING!** Applying voltage above the input voltage rating or reversing polarity may result in permanent damage to the VC80x and void the product warranty.

An extension power cable is used to wire the VC80x to the truck battery (order cable separately, see [Accessories on page 132](#)). Wire this cable to a filtered, fused (15A max) accessory supply on the vehicle. Follow the installation instructions supplied with the extension cable.

Additional wiring (minimum 14 gauge), connectors or disconnects used should be rated for at least 300 VDC, 15A.

When connecting the extension power cable:

- If a power extension cable with ignition sense is used, ensure that the ignition sense wires (18AWG wires in red and black leads) and the power wires (14AWG in red and black leads) are reliably secured away from each other, or are separated with reliably secured certified insulation. Minimum 2.8 mm distance, or 0.4 mm distance through insulation is required for the separation.
- The red lead of the 14AWG power cables attach to the vehicles battery positive terminal. The 14AWG black lead connects to the vehicle's battery negative terminal. This should be connected to a proper terminal block and not to the vehicle body. An optional grounding strap wire (sourced separately) may be connected to the ground lug of the VC80x terminal connector bay and to the vehicle chassis.
- You may have the option to connect power before or after the key switch. Though the VC80x is equipped with a UPS, a proper shut down is recommended using the Power Off procedure. If it is wired after the key switch, the operator must shut down the VC80x using the Power Off procedure before turning off the vehicle. If it is wired before the key switch, then to avoid excessive drain on the vehicle battery, either the operator should shut it down when the vehicle is to be left off for an extended period, or the ignition cable shut down wire should be connected and the VC80x configured to shut down automatically.
- An appropriate fuse type must be used with the power extension cable according to the installation instructions. For main power cable, use 3AB, 15A, 250V, slow blow fuse. For ignition sense input, use 3AB, 0.3A, 250V, slow blow fuse.



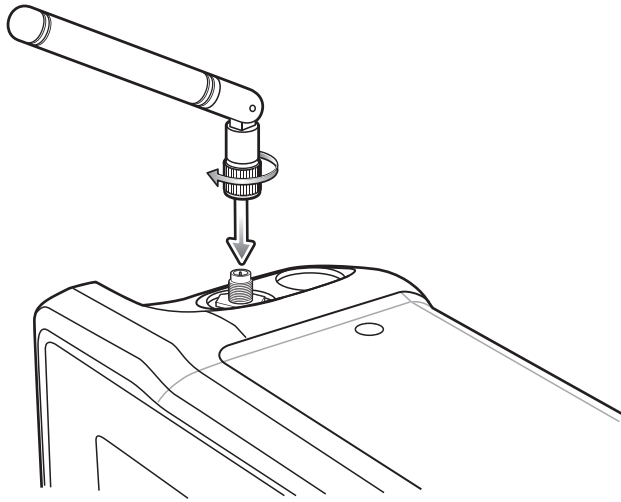
**NOTE** The VC80x supports the ignition sense feature that detects when the ignition switch or key switch is On or Off to allow automatic computer start up or shut down (with delay as needed).



When wiring the ignition sense wires (18AWG in red and black), the red 18AWG wire is connected to a positive DC voltage source switched on by the ignition. The black 18AWG wire is connected to ground reference of this switched ignition source.

## External Antenna Installation

To install an external antenna:

1. Align the antenna connector with the connector on top of the VC80x.
2. Insert the antenna connector onto the VC80x connector.
3. Tighten the antenna connector.

**Figure 8** Installing External Antenna

4. Swipe up from the bottom of the Home screen and touch .
5. Touch **Choose Antenna**.
6. Touch **External Antenna**.
7. Touch .

## Positioning the VC80x in the Vehicle

When positioning the VC80x on the vehicle:

- The driver's field of view must be kept free.
- Plan for sufficient space if a keyboard and scanner are installed with the VC80x.
- No part of the VC80x system may project beyond the vehicle.

## Overview of the Assembly Steps

Before fastening the VC80x to the vehicle:

- Configure shut down automation.
- Prepare the forklift such as ignition connection and correct voltage.
- It is recommended to fasten the bracket to the vehicle and then install the VC80x to the bracket.

## Cable Dust Cover

For the dust cover location, see [VC80x Back View with Dust Cover on page 19](#).



**CAUTION** Turn on external peripheral devices with their own power supply at the same time or after the VC80x. If this is not possible, ensure that the VC80x is adequately protected from power leakage caused by an external device.



**CAUTION** For safety reasons, install the supplied cable cover for the external ports prior to using the VC80x.

## Strain Relief

After the VC80x and bracket are fastened, prepare the strain relief as follows:

1. Install the cables loosely on the strain relief rail (see [Figure 4 on page 19](#)).
2. As far as possible, route cables leading to or away from the unit next to one another without crossing.
3. Fasten the cables into the strain relief rail precisely at the positions at which the cable openings in the cable cover are located.

## Installing the VC80x on a Forklift



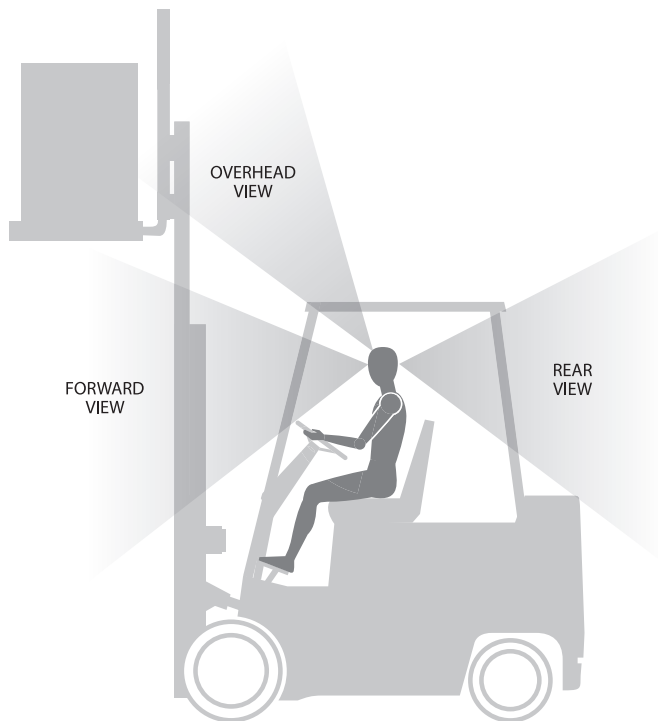
**CAUTION** Tighten peripherals with thumbscrews by hand only. Do not use tools for tightening thumbscrews.



**NOTE** If installing peripherals, allow enough space when selecting a mounting location.

1. Attach the desired mount to the VC80x. See [VC80x Mounting Accessories on page 136](#) for detailed mounting options and instructions.
2. Attach the mounted VC80x to the vehicle and position in a location that does not obstruct the operator's view.
3. If using an external antenna, connect antenna in a vertical position to the VC80x.
4. Connect peripherals to the VC80x. Place the cables in the strain relief brackets inside the dust cover and replace the dust cover (see [Figure 3 on page 19](#)).
5. Connect the VC80x to the vehicle DC supply.
6. Press the **Power** button to turn the device On or Off (see [Figure 2 on page 18](#)).

**Figure 9** View Obstruction Considerations



---

### Forklift Battery Replacement Conditions

The VC80x maintains normal function of applications and connections during and after forklift battery replacement.

Replace the forklift battery at any point during a shift and/or while the VC80x is fully running.

The forklift battery may be replaced under following condition: VC80x external temperature range: -30° C to +50° C (-22°F to 122°F).

During forklift battery replacement (VC80x is running on UPS battery), both Android and the VC80x are monitoring remaining UPS battery capacity. The default Low Battery notification threshold is set to 30%. The Critical Battery threshold is set to 7%. If UPS battery is discharged below 7%, the VC80x automatically shuts down.

---

### Starting from Cold Soak

The VC80x can start up from a saturated cold soak at -30°C (or above) internal VC80x temperature when a valid external DC power source is present.

The VC80x design minimizes wait time from -30°C cold soak to load the OS and have internal heaters to assist system warm up.

From a -30°C cold soak condition, the VC80x battery heater may be activated to warm the UPS battery to an acceptable charging temperature if charging is needed. The conditions and time to heat the battery are managed by the system. The OS load time and VC80x ready for use time is independent of warming the battery.



## Installing the Power Pre-Regulator



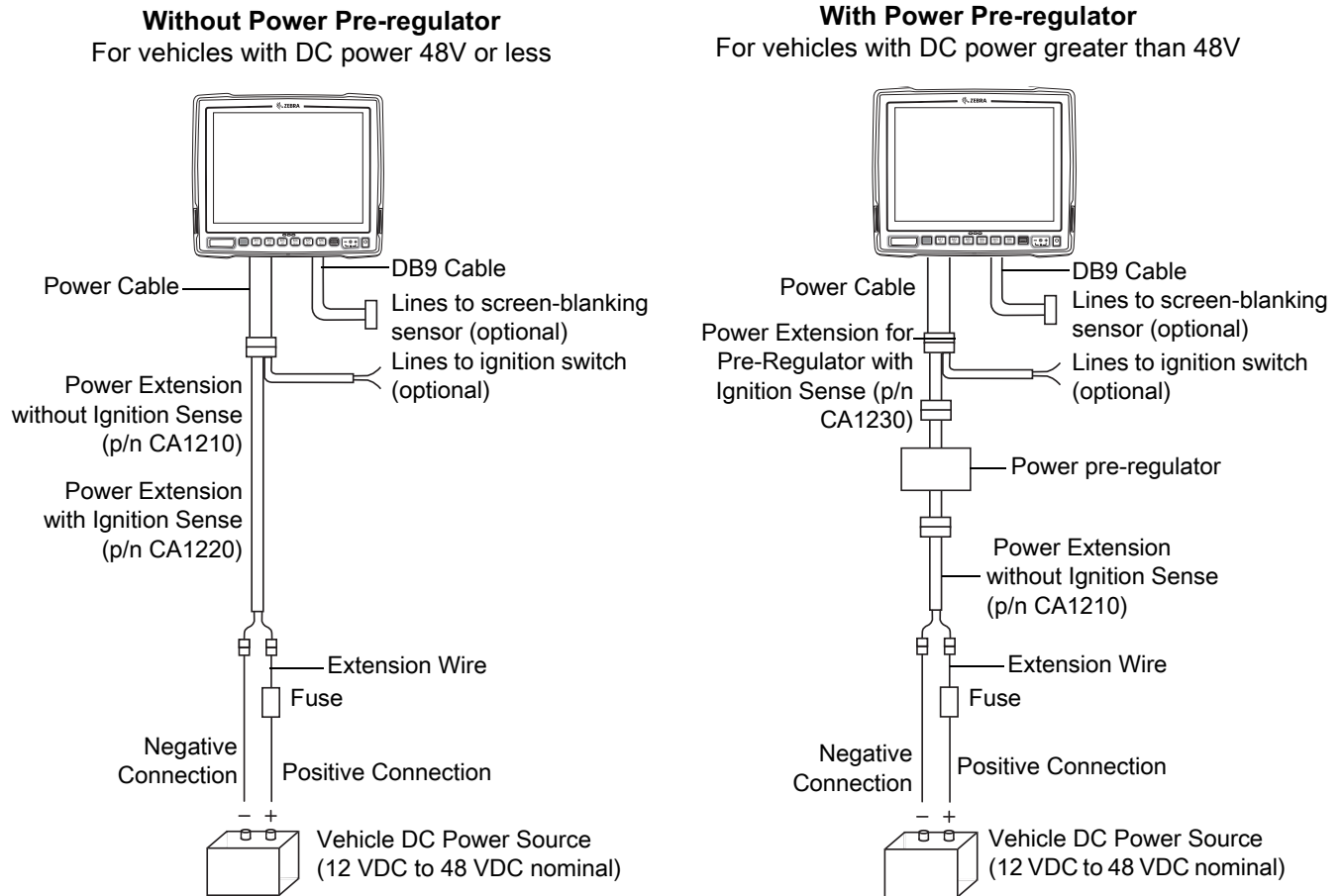
**IMPORTANT** The Zebra power extension cable positive lead is red and the negative lead is black.

It is recommended that all connections be secured with electrical tape or heat shrink to prevent contaminants from degrading the connection.

To install the power pre-regulator:

1. Attach the pre-regulator cable male connector to the Zebra power extension cable which is installed on the vehicle.
2. Connect the pre-regulator cable female connector either directly to the VC80x power cable, or to the power extension cable. See [Figure 10](#).

**Figure 10** Connections To Vehicle DC Supply



## Non-Vehicle Installations

Using AC power, the VC80x Vehicle-Mount Computer can be mounted at fixed locations adjacent to cross-dock doors, manufacturing stations, or in offices.

Use the 100/240 VAC Power Supply (p/n PWR-BGA24V150W0WW) to power the computer from an AC source.



**IMPORTANT** The AC/DC power supply is only intended for use at room temperature condition such as an office environment.

## Power On/Off with Ignition

The VC80x is equipped with an ignition sense feature which shuts down the VC80x when the vehicle ignition is turned off and can power on the VC80x when the ignition is switched on. To use this feature, a power extension cable with ignition sense wires must be used and installed properly on the vehicle.

The cable in [Figure 11](#) is the power extension cable (p/n CA1220) with two wires used to connect to vehicle ignition. The red and black leads of the two 18AWG wires that connect to the key switch of the ignition and ground, respectively. Once the wires are connected, the VC80x may switch on or off depending on the state of the vehicle ignition key. See [VC Settings on page 66](#) to select power settings.

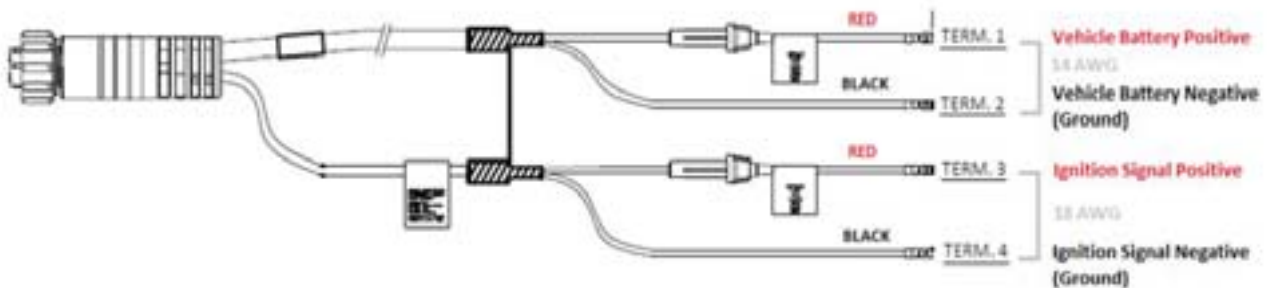


**IMPORTANT** When connecting to an ignition switch using the power extension cable with ignition sense wires, ensure that the wires of different polarities are reliably secured away from each other, or are separated with reliably secured certified insulation. A minimum distance of 2.8mm (or 0.4mm distance through insulation) is required for the separation.

The thinner wires (18 AWG) are used for Ignition Sense wires while the thicker wires (14AWG) are used for Vehicle Power and Ground. Identify them carefully and **Do Not** confuse them.

An appropriate fuse type must be used with the power extension cable according to the installation instructions. For the main power cable, use 3AB, 15A, 250V, slow blow fuse. For ignition sense input, use 3AB, 0.3A, 250V, slow blow fuse.

**Figure 11** Power Extension Cable Kit with Optional Ignition Sense Wires (p/n CA1220)

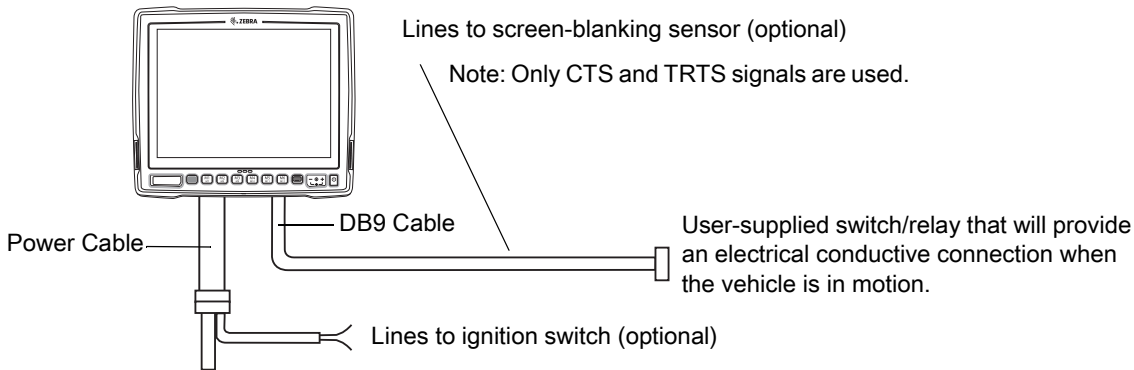


## Screen Blanking Wiring

### Connecting Switch for Screen Blanking

To use Screen Blanking, connect one of the two DB9 serial ports (using CA1300 Screen Blanking cable) on the VC80x to a switch. Activate this switch electrically (e.g. motion sensor) or mechanically (e.g. pedal switch) when the vehicle is in motion.

**Figure 12** Connecting the Switch to the DB9 Cable



**IMPORTANT**

For customers migrating to the VC80x from a 8515, 8525, 8535 vehicle mount computer or a 753x hand-held computer cradle:

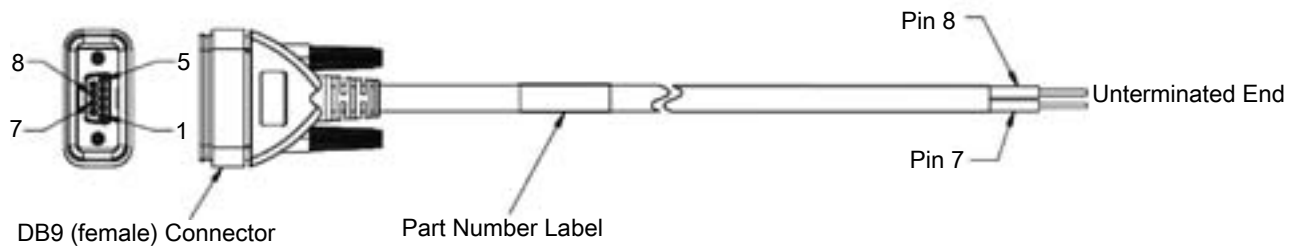
If the screen blanking feature was used previously, ensure that you are no longer feeding the screen blanking signals to the VC80x main DC power cable. Rewire the screen blanking inputs to the VC80x DB-9 serial port through the DB-9 screen blanking cable. In previous generations of vehicle-mount computers, the screen blanking signals were fed in to the terminal through 2 of the 4 wires in the CPC connector of the DC power cable. This no longer applies for the VC80x.

The screen blanking feature makes use of either one of the DB-9 ports to monitor electrical relay closure. When enabled, the CTS/RTS pins of the DB9 port are continuously monitored by the screen blanking application. See [Figure 13](#) for pin configuration.

When the vehicle is in motion, the switch closes the circuit, allowing data packets to be sent or received through the RTS and CTS pins. The computer detects that the circuit is closed and turns off the screen.

When the vehicle is not in motion, the switch opens the circuit, preventing data packets from being sent or received. The computer detects that the circuit is open and turns on the screen.

**Figure 13** Screen Blanking DB9 Pin Configuration



# Using the VC80x

This chapter explains the buttons, status icons, and controls on the VC80x, and provides basic instructions for using the VC80x including resetting the VC80x and entering data.

---

## Google Mobile Services



**NOTE** This section only applies to VC80x devices with Google Mobile Services (GMS) software.

The VC80x with Google Mobile Services (GMS) contains applications and services that provide additional functionality to the VC80x.

GMS includes:

- **Applications** - GMS adds a variety of Google applications and associated widgets including Chrome, Gmail, Drive and Maps.
- **Services:**
  - **TalkBack Service** - Provides spoken feedback on various parts of the user interface. To enable, go to **Settings > Accessibility**.
  - **Network Location Provider** - Adds a location provider which uses Wi-Fi access point information to provide a location without using GPS. To enable, go to **Settings > Location**.
  - **Widevine DRM** - Enables the digital rights management so that protected content can be played. Enable via DRM Info from the Play Store.
  - **Google Cloud Messaging** - Allows the sending of data from your server to your VC80x and also to receive messages from devices on the same connection.
  - **Backup and Restore** - Allows the users settings and applications to be backed up to a Google server and subsequently restored from that server after a factory reset.
- **Google accounts** - Create and use a Google account to synchronize mail, files, music, photos, contacts and calendar events.

---

## Home Screen

The Home screen displays when the VC80x turns on. Depending upon the configuration, the Home screen might appear different. Contact your system administrator for more information.

After a suspend or screen time-out, the Home screen displays with the lock sliders. Touch the screen and slide up to unlock. For screen locking information see [Un-Locking the Screen on page 51](#).

**Figure 14** Home Screen - GMS



**Figure 15** Home Screen - AOSP



**Table 3** Home Screen Items

Item	Description
1 — Status Bar	Displays the time, status icons (right side), and notification icons (left side). For more information see <a href="#">Status Bar on page 38</a> and <a href="#">Managing Notifications on page 40</a> .
2 — Widgets	Launches stand-alone applications that run on the Home screen. See <a href="#">Application Shortcuts and Widgets on page 42</a> for more information.
3 — Back	Displays the previous screen.
4 — Home	Displays the Home screen.
5 — Recent Button	Displays recently used applications.

**Table 3** Home Screen Items (Continued)

Item	Description
6 — All Apps	Opens the APPS window.
7 — Shortcut Icons	Opens applications installed on the VC80x. See <a href="#">Application Shortcuts and Widgets on page 42</a> for more information.
8 — Folder	Contains apps.

The Home screen provides four additional screens for placement of widgets and shortcuts. Swipe the screen left or right to view the additional screens.

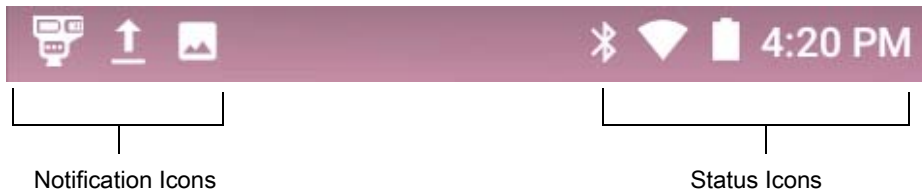
## Status Bar

The Status bar displays the time, notification icons (left side) and status icons (right side).



**NOTE** Some status icons may not appear in the Status bar if there are too many icons to display.

**Figure 16** Notification and Status Icons









If there are more notifications than can fit in the Status bar displays indicating that more notifications exist. Open the Notifications panel to view all notifications and status.

## Status Icons

**Table 4** Status Icons















Icon	Description
	Indicates that the Alarm is active.
	Indicates that the UPS battery is fully charged.
	Indicates that the UPS battery is partially drained.
	Indicates that the UPS battery charge is low.
	Indicates that the UPS battery charge is very low.
	Indicates that the UPS battery is charging.
	Indicates that all sounds except media and alarms are silenced and vibrate mode is active.

**Table 4** Status Icons (Continued)



Icon	Description
	Indicates that the Airplane Mode is active. All radios are turned off.
	Indicates that Bluetooth is on.
	Indicates that the VC80x is connected to a Bluetooth device.
	Connected to a Wi-Fi network.
	Not connected to a Wi-Fi network or no Wi-Fi signal.
	Connected to an Ethernet network.

## Notification Icons

**Table 5** Notification Icons

Icon	Description
	Indicates the main battery is low.
	Indicates that more notifications are available for viewing.
	Indicates that data is syncing.
	Indicates an upcoming event.
	Indicates that an open Wi-Fi network is available.
	Indicates that a song is playing.
	Indicates that a problem with sign-in or sync has occurred.
	Indicates that the VC80x is uploading data.
	Indicates that the VC80x is downloading data when animated and download is complete when static.
	Indicates that USB tethering is active.
	Indicates that the VC80x is connected to or disconnected from virtual private network (VPN).
	Preparing Internal Storage.
	Indicates that USB debugging is enabled on the VC80x.
	Indicates the status of the PTT Express Voice Client. See Notification Icons for complete list of PTT Express notification icons.

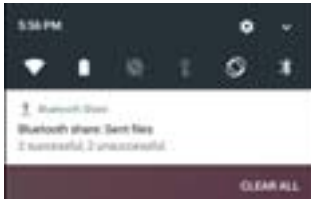
**Table 5** Notification Icons (Continued)

Icon	Description
	Indicates that RxLogger application is running.
	Indicates the RS6000 is connected to the VC80x.

## Managing Notifications

Notification icons report the arrival of new messages, calendar events, and alarms, as well as ongoing events. When a notification occurs, an icon appears in the Status bar with a brief description. See [Notification Icons on page 39](#) for a list of possible notification icons and their description. Open the Notifications panel to view a list of all the notifications.

To open the Notification panel drag the Status bar down from the top of the screen.

**Figure 17** Notification Panel


To respond to a notification, open the Notifications Panel and then touch a notification. The Notifications Panel closes and the subsequent activity is dependent on the notification.

To clear all notifications, open the Notifications Panel and then touch **CLEAR ALL**. All event-based notifications disappear. Ongoing notifications remain in the list.


To close the Notification Panel, swipe the Notifications Panel up.

## Setting Application Notifications

To change notification settings for a specific app:

1. Swipe down from the status bar and then touch .
2. Touch **Notifications**.
3. Select an app.
4. Select an option:
  - **Block all**
  - **Show silently**
  - **Override Do Not Disturb**.



**IMPORTANT** In the notification, slide the notification slightly left or right and touch .

## Viewing Notification Settings for All Apps



1. Swipe down from the status bar and then touch .



2. Touch **Notifications**.
3. Touch down-arrow next to **All apps**.
4. To see all the apps currently set to a specific setting, touch that setting.

## Controlling Lock Screen Notifications

To control notification content on the lock screen:

1. Swipe down from the status bar and then touch .
2. Touch **Notifications** > .
3. Touch **On the lock screen**.
4. Select **Show all notification content** to or select **Don't show notifications at all**.

## Quick Access Panel

Use Quick Settings to get to frequently used settings, like turning on airplane mode. To open the Quick Settings bar, swipe down once from the top of an unlocked screen.

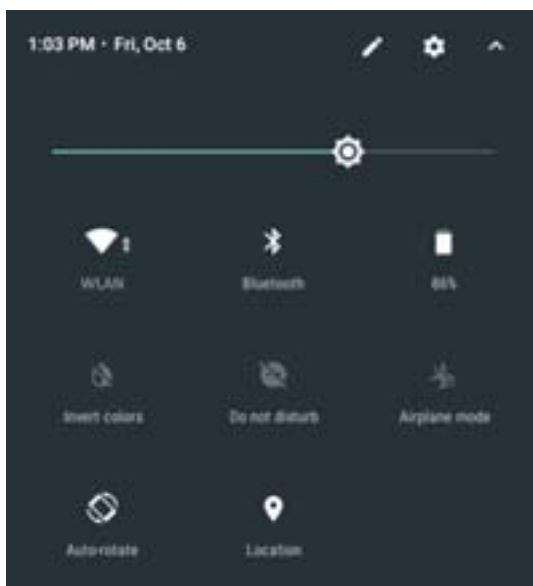
**Figure 18** Quick Settings Bar



To see the full Quick Settings panel:

- If the VC80x is locked, swipe down once.
- If the VC80x is unlocked, swipe down once with 2 fingers, or twice with one finger.
- If the Quick Settings bar is open, touch the Down arrow.

**Figure 19** Full Quick Settings





Available setting tiles:

- Display brightness: Slide to lower or increase the brightness of the screen.
- Wi-Fi network: Turn Wi-Fi on or off. To open Wi-Fi settings, touch the Wi-Fi network name.
- Battery Power - Indicates percentage of battery power remaining. Touch to view battery usage.
- Do not disturb: Control how and when to receive notifications.
- Auto-rotate: Lock the device's orientation in portrait or landscape mode or set to automatically rotate.
- Bluetooth settings: Turn Bluetooth on or off. To open Bluetooth settings, touch the **Bluetooth**.
- Airplane mode: Turn airplane mode on or off. Airplane mode means device will not connect to Wi-Fi or Bluetooth.
- Location - Turn locationing on or off.
- Invert colors - Invert the display colors.
- Data Saver - Turn on to prevent some apps from sending or receiving data in the background.



### Edit Icons on Quick Settings

The first several setting tiles become the Quick Settings bar.



To move a setting tile:

1. Touch .
2. Touch and drag a setting tile to another location.
3. Release the tile.
4. Touch  to save tiles and return to quick settings.

To add a setting tile:

1. Open Quick Settings.
2. Touch .
3. Slide Quick Settings panel up to reveal additional tiles.
4. Touch and drag a setting tile from the **Drag to add tiles** area to the main area.
5. Release the tile.
6. Touch  to save tiles and return to quick settings.

To remove a setting tile:

1. Open Quick Settings.
2. Touch .
3. Touch and drag a setting tile to the **Drag here to remove** area.
4. Release the tile.
5. Touch  to save tiles and return to quick settings.

### Application Shortcuts and Widgets

Application shortcuts placed on the Home screen allow quick and easy access to applications. Application Widgets are self-contained applications placed on the Home screen to access frequently used features.

## Adding an Application to the Home Screen

1. Go to the desired Home screen.
2. Swipe up from the bottom of the screen.
3. Scroll through the list to find the application icon.
4. Touch and hold the icon until the Home screen appears.
5. Position the icon on the screen and then release.

## Adding a Widget to the Home Screen


To add a widget to the Home screen:

1. Go to the desired Home screen.
2. Touch and hold onto the menu appears.
3. Touch **WIDGETS**.
4. Scroll through the list to find the widget.
5. Touch and hold the widget until the Home screen appears.
6. Position the widget on the screen and then release.

## Moving Items on the Home Screen

1. Touch and hold the item until it floats on the screen.
2. Drag the item to a new location. Pause at the edge of the screen to drag the item onto an adjacent Home screen.
3. Lift finger to place the item on the Home screen.

## Removing an Application Shortcut or Widget from the Home Screen

1. Go to the desired Home screen.
2. Touch and hold the application shortcut or widget icon until it floats on the screen.
3. Drag the icon to  **Remove** on the top of the screen and then release.

## Folders

Use **Folders** to organize similar applications together. Tap the folder to open and display items in the folder.

### Creating a Folder

To create a folder, there must be at least two app icons on the Home screen.

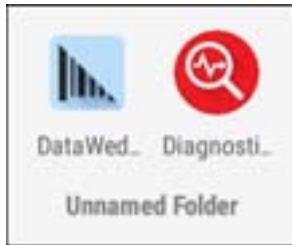
1. Go to the desired Home screen.
2. Touch and hold on one application icon.
3. Drag the icon and stack on top of another icon.
4. Lift and release.

### Naming Folders

To name a folder:

1. Touch the folder.

**Figure 20** Open Folder



2. Touch the title area and enter a folder name using the keyboard.
3. Touch Enter key on the keyboard.
4. Touch anywhere on the Home screen to close the folder. The folder name appears under the folder.

**Figure 21** Renamed Folder



## Removing a Folder

To remove a folder:

1. Touch and hold the folder icon until it enlarges.
2. Drag the folder to  **Remove** and release.

## Home Screen Wallpaper

To change the Home screen wallpaper:

1. Touch and hold on the screen until the menu appears.
2. Touch **WALLPAPERS**.
3. Touch **My photos** to select a photo from Gallery or select one of the pre-installed photos.
4. Touch **Save wallpaper**.

---

## Using the Touchscreen

Use the multi-tap sensitive screen to operate the device.

- **Tap** - Tap to:
  - select items on the screen
  - type letters and symbols using the on-screen keyboard
  - press on-screen buttons.

- **Tap and Hold** - Tap and hold:
  - an item on the Home screen to move it to a new location or to the trash.
  - an item in Apps to create a shortcut on the Home screen.
  - the Home screen to open a menu for customizing the Home screen.
  - an empty area on the Home screen until the menu appears.
- **Drag** - Tap and hold an item for a moment and then move finger on the screen until reaching the new position.
- **Swipe** - Move finger up and down or left and right on the screen to:
  - unlock the screen
  - view additional Home screens
  - view additional application icons in the Launcher window
  - view more information on an application's screen.
- **Double-tap** - Tap twice on a web page, map, or other screen to zoom in and out.
- **Pinch** - In some applications, zoom in and out by placing two fingers on the screen and pinching them together (to zoom out) or spreading them apart (to zoom in).

---

## On-Screen Keyboards



Use the on-screen keyboard to enter text in a text field.

### Editing Text

Edit entered text and use menu commands to cut, copy, and paste text within or across applications. Some applications do not support editing some or all of the text they display; others may offer their own way to select text.

### Entering Numbers, Symbols and Special Characters

To enter numbers and symbols:

- Touch and hold one of the top-row keys until a menu appears then select a number. Keys with alternate characters display an ellipsis ( ... ) below the character.
- Double tap the the Shift key to lock the keyboard into Shift mode, touch one or more capital letters or symbols to enter them, and then touch the Shift key to return to the lowercase keyboard.
- Touch  to switch to the numbers and symbols keyboard.
- Touch the  key on the numbers and symbols keyboard to view additional symbols.

To enter special characters, touch and hold a number or symbol key to open a menu of additional symbols.

- A larger version of the key displays briefly over the keyboard.
- Keys with alternate characters display an ellipsis ( ... ) below the character.

### Switching Language Keyboards

The user can enable multiple language keyboards. The available language codes appear on the space bar.

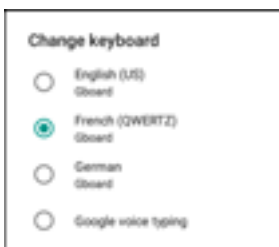
**Figure 22** GMS Keyboard



**Figure 23** AOSP Keyboard



**Figure 24** Change Keyboard Option



Select one of the keyboard languages. The keyboard automatically changes to the selected language.













## Configuring the Keyboard

To configure the keyboard, See [Keyboard Settings on page 211](#).














## Applications

The **APPS** screen displays icons for all installed applications. The table below lists the applications installed on the VC80x. See [Application Deployment on page 215](#) for information on installing and uninstalling application.

**Table 6** Applications












Icon	Description
	<b>AppGallery</b> - Provides links to utilities and demonstration applications that can be installed on the VC80x.
	<b>Battery Manager</b> - Displays battery information, including charge level, status, health and wear level.
	<b>Bluetooth Pairing Utility</b> – Use to pair a Bluetooth Imager with the VC80x by scanning a barcode.
	<b>Calculator</b> - Provides the basic and scientific arithmetic functions.
	<b>Calendar</b> - Use to manage events and appointments.
	<b>Chromium</b> - Use to access the Internet or intranet (Available only on devices with AOSP software).
	<b>Chrome</b> - Use to access the Internet or intranet (Available only on devices with GMS software).
	<b>Clock</b> - Use to schedule alarms for appointments or as a wake-up.
	<b>Contacts</b> - Use to manage contact information. See <a href="#">Contacts on page 71</a> for more information.
	<b>DataWedge</b> - Enables data capture using the imager. See <a href="#">DataWedge Configuration</a> for more information.
	<b>Device Central</b> - Provides information on connected peripherals. See <a href="#">Device Central on page 60</a> for more information.
	<b>Diagnostic Tool</b> - Use to diagnose the VC80x. See <a href="#">Diagnostic Tool on page 96</a> for more information.

**Table 6** Applications (Continued)




Icon	Description
	<b>Downloads</b> - lists all downloads files.
	<b>Drive</b> - Upload photos, videos, documents, and other files to personal storage site (Available only on devices with GMS software).
	<b>DWDemo</b> - Provides a way to demonstrate the data capture features using the imager. See <a href="#">DataWedge Demonstration on page 76</a> for more information.
	<b>Email</b> - Use to send and receive email. (Available only on devices with AOSP software)
	<b>File Browser</b> - Organize and manage files on the VC80x. See <a href="#">File Browser on page 69</a> for more information.
	<b>Gallery</b> - Use to view photos stored on the device. For more information, see <a href="#">Gallery on page 73</a> for more information (Available only on devices with AOSP software).
	<b>Gmail</b> - Use to send and receive email using a Google email account (Available only on devices with GMS software).
	<b>Google</b> - Launches Google search application (Available only on devices with GMS software).
	<b>Hangouts</b> - Use to communicate with friends using text messages and photos (Available only on devices with GMS software).
	<b>Heater Control</b> - Use to enable heaters when using the device in cold environments. See <a href="#">Heater Control on page 64</a> .
	<b>License Manager</b> - Use to manager software licenses on the VC80x.
	<b>Maps</b> - Use to see you location on a map (with public transit, traffic or satellite overlays). Search for any business or place of interest. Provides turn-by-turn navigation with voice guidance and traffic-avoidance and alternate routes, for drivers, cyclist, walkers and users of public transportation (Available only on devices with GMS software).
	<b>Music</b> - Play music stored on the device (Available only on devices with AOSP software).



**Table 6** Applications (Continued)

Icon	Description
	<b>Notes</b> - Use to take and save notes.
	<b>Photos</b> - Use to sync photos with Google account (Available only on devices with GMS software).
	<b>Play Movies &amp; TV</b> - View movies and video on your device (Available only on devices with GMS software).
	<b>Play Music</b> - Use to listen to music (Available only on devices with GMS software).
	<b>Play Store</b> - Download music, movies, books, and Android apps and games from the Google Play Store (Available only on devices with GMS software).
	<b>PTT Express</b> - Use to launch PTT Express client for VoIP communication.
	<b>RxLogger</b> - Use to diagnose device and application issues. See <a href="#">RxLogger on page 83</a> .
	<b>RxLogger Utility</b> - Use for viewing logs in the VC80x while RxLogger is running. See <a href="#">RxLogger Utility on page 90</a> .
	<b>Search</b> - Use the Google search engine to search the internet and the VC80x. (Available only on devices with AOSP software).
	<b>Settings</b> - Use to configure the VC80x.
	<b>Sound Recorder</b> - Use to record audio (Available only on devices with AOSP software).
	<b>StageNow</b> - Allows the VC80x to stage a device for initial use by initiating the deployment of settings, firmware and software.
	<b>VC Settings</b> - Use to control various settings for the VC80x. See <a href="#">VC Settings on page 66</a> .

**Table 6** Applications (Continued)

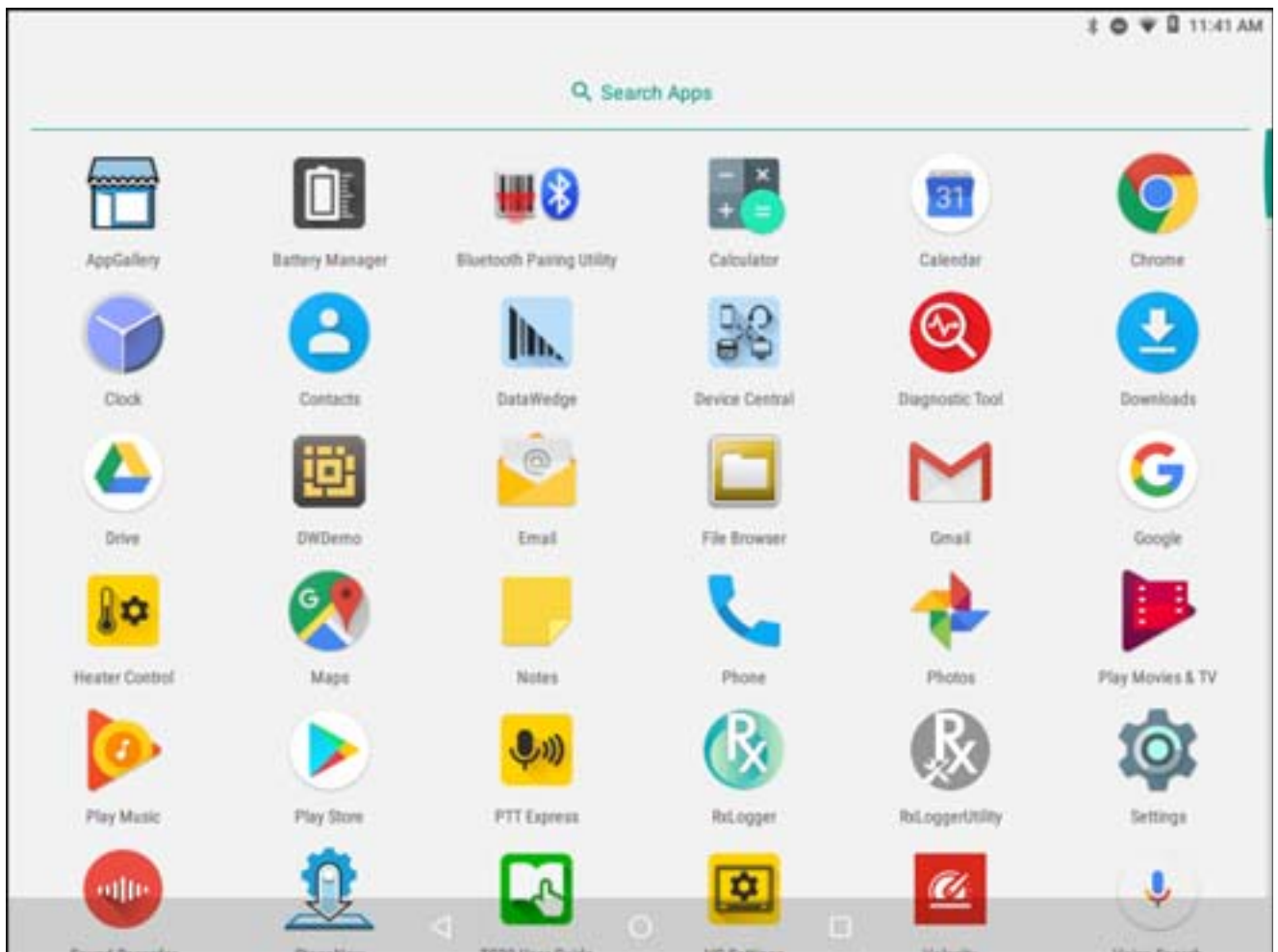
Icon	Description
	<b>Velocity</b> - Opens the Wavelink terminal emulation application. See
	<b>Voice Search</b> - Use to perform searches by asking questions (Available only on devices with GMS software).
	<b>YouTube</b> - Use to view videos on the YouTube web site (Available only on devices with GMS software).

## Accessing Applications

All applications installed on the device are accessed using the **APPS** window.

1. On the Home screen, swipe up from the bottom of the screen.


**Figure 25** APPS Window Example



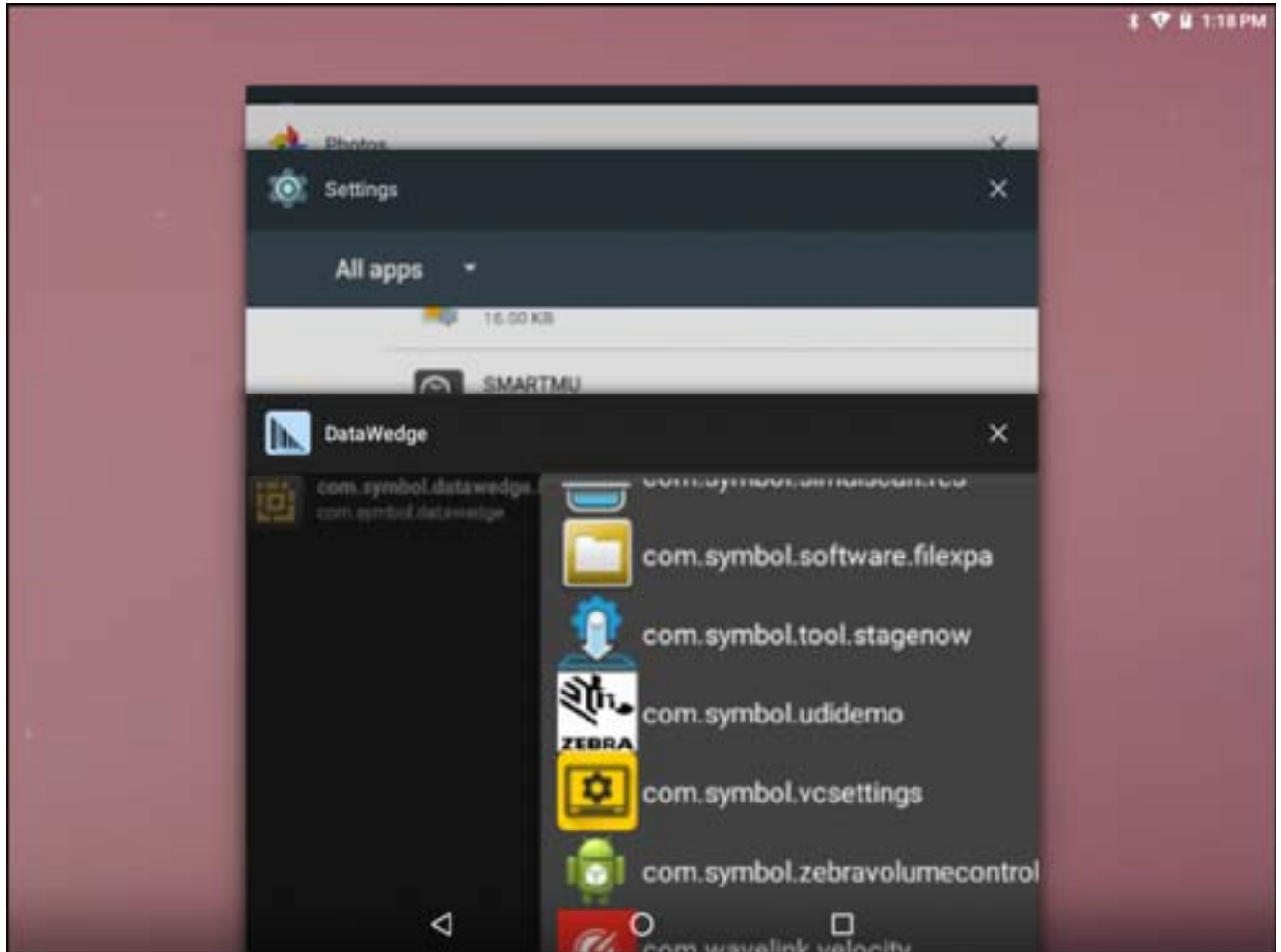
2. Slide the **APPS** window up or down to view more application icons. Touch an icon to open the application.


See [Application Shortcuts and Widgets on page 42](#) for information on creating a shortcut on the Home screen.

## Switching Between Recent Applications

1. Touch . A window appears on the screen with icons of recently used applications.

**Figure 26** Recently Used Applications



2. Slide the window up and down to view all recently used applications.
3. Swipe left or right to remove application from the list and force close the application.
4. Touch an icon to open it or touch  to return to the current screen.

---

## Un-Locking the Screen

Use the Lock screen to protect access to data on the VC80x. Some email account require locking the screen. See [Screen Unlock Settings on page 206](#) for information on setting up the locking feature.

When locked, a pattern, PIN or password is required to unlock the device. Press the Power button to lock the screen. The device also locks after a pre-defined time-out.

Press and release the Power button to wake the device.

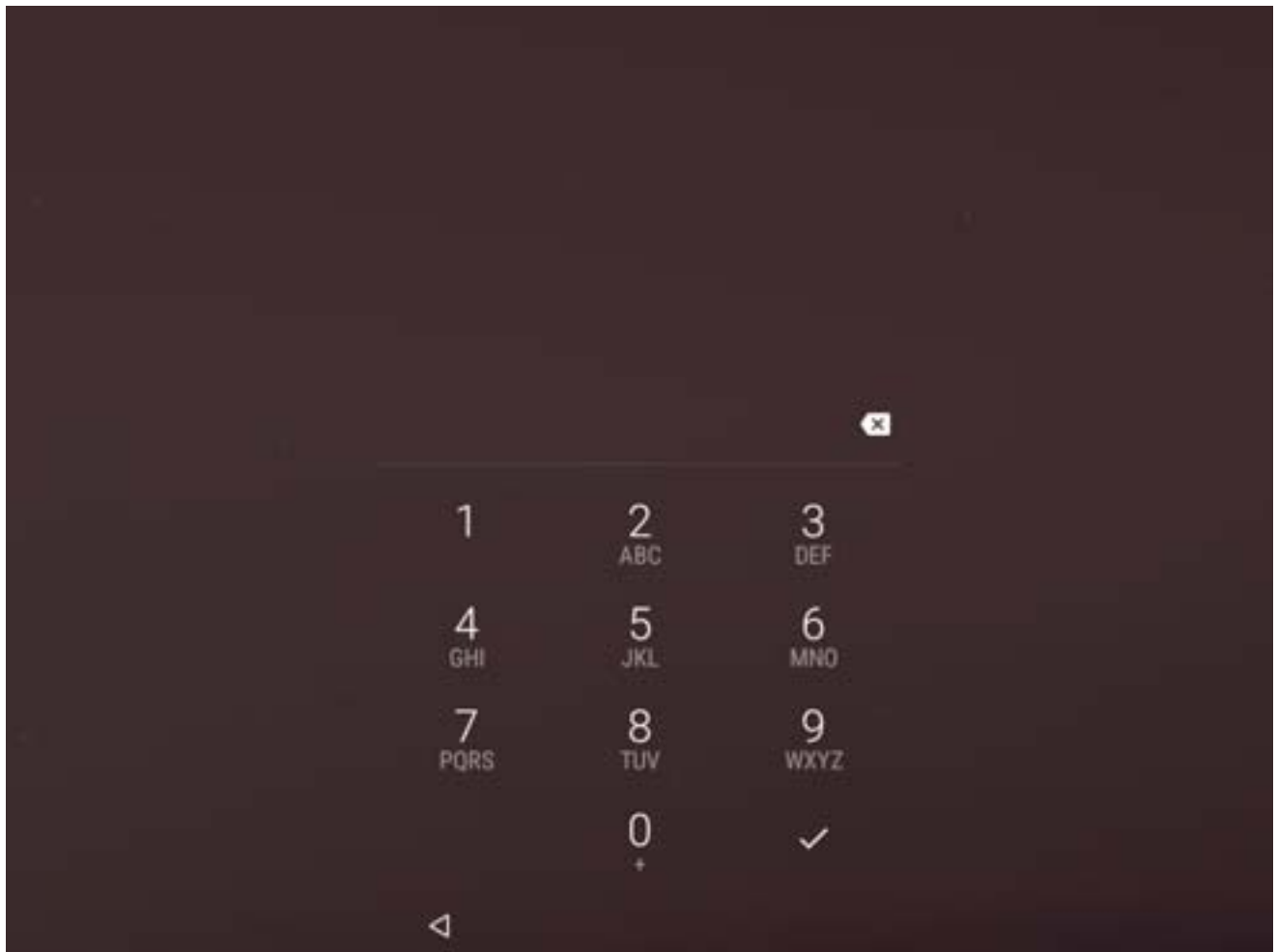
The Lock screen displays. Swipe the screen up to unlock.

If the Pattern screen unlock feature is enabled, the Pattern screen appears instead of the Lock screen.

If the PIN or Password screen unlock feature is enabled, enter the PIN or password after unlocking the screen.

**Figure 27** Lock Screen



**Figure 28** PIN Screen

---

## Resetting the Device

There are four reset functions:

- Soft reset
- Hard reset
- Enterprise reset. See [Performing an Enterprise Reset on page 226](#).
- Factory reset. See [Performing a Factory Reset on page 227](#).

### Performing a Soft Reset

Perform a soft reset if applications stop responding.

1. Press and hold the Power button until the menu appears.
2. Touch **Reboot**.
3. The device reboots.

## Performing a Hard Reset



**CAUTION** Performing a hard reset with a USB drive installed in the VC80x may cause damage or data corruption to the USB drive.

Perform a hard reset if the VC80x stops responding.

1. Press and hold the Power button for at least 12 seconds.
2. When the screen turns off, release the buttons.
3. The VC80x reboots.

---

## Suspend Mode

The VC80x goes into suspend mode when the user presses the Power button or after a period of inactivity (set in the Display settings window).

To wake the VC80x from Suspend mode, press the Power button. The Lock screen displays. Swipe the screen up to unlock. If the Pattern screen unlock feature is enabled, the Pattern screen appears instead of the Lock screen. If the PIN or Password screen unlock feature is enabled, enter the PIN or password after unlocking the screen.



**NOTE** If the user enters the PIN, password or pattern incorrectly five times, they must wait 30 seconds before trying again.

If the user forgets the PIN, password or pattern contact the system administrator.

**Figure 29** Lock Screen



---

## Transferring Files

To transfer files to the VC80x use a USB drive.

### Using a USB Drive



**NOTE** Use Media Transfer Protocol (MTP) to copy files between the VC80x (internal memory) and a USB drive.

1. Remove the dust cover on the back of the VC80x.
2. Plug the USB drive into the USB port on the bottom of the VC80x. A notification appears indicating that the VC80x detected the USB drive.
3. Open **File Browser**.
4. Locate the USB drive as a folder in `/mnt/media_rw/xxxx-xxxx`, where `xxxx-xxxx` is the name of the thumb drive.
5. Use **File Browser** to copy files between the drive and the VC80x.

## Disconnecting USB Drive

To remove the USB drive:

1. Swipe down from the status bar.
2. In the **General USB Drive** notification, touch **EJECT**.
3. Remove the USB drive from the device.
4. Replace the dust cover.



# Applications

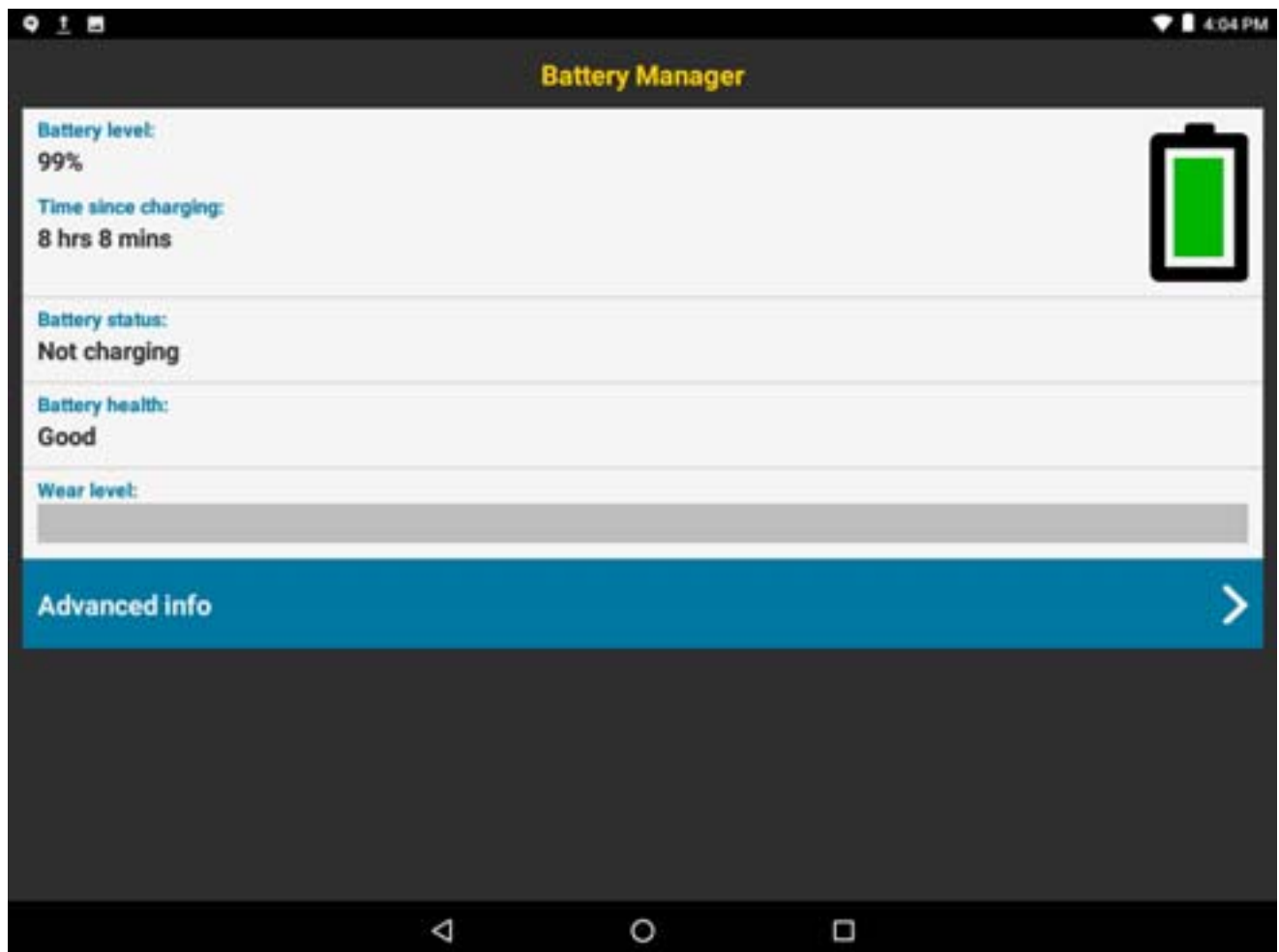
This section describes the applications installed on the device.

---




## Battery Manager


The **Battery Manager** provides detailed information about the UPS battery. The UPS battery provides power to the VC80x for 15 minutes if AC power is removed.

Figure 30 Battery Manager Screen



**Table 4-1** *UPS Battery Icon Description*

Battery Icon	Description
	Indicates the UPS battery charge level.
	Indicates the UPS battery charging.
	Indicates UPS battery charge level is below 20%.

- **Battery level** - Indicate the current UPS battery charge level as a percentage. Displays -% when level is unknown.
- **Battery status**
  - **Not charging** - Indicates that the device is not connected to AC power.
  - **Charging over AC** - Indicates that the device is connected to AC power and charging.
  - **Charging over USB** - Indicates that the device is connected to a host computer with a USB cable and charging.
  - **Discharging** - Indicates that the UPS battery is discharging.
  - **Full** - Indicates that the UPS battery is fully charged.
  - **Unknown** - Indicates that the UPS battery status is unknown.
- **Battery health** - Indicates the health of the UPS battery. If a critical error occurs,  appears. Touch to view error description.
  - **Decommission** - The UPS battery is past it's useful life and should be replaced. See system administrator.
  - **Good** - The UPS battery is good.
  - **Charge error** - An error occurred while charging. See system administrator.
  - **Over Current** - An over-current condition occurred. See system administrator.
  - **Dead** - The UPS battery has no charge. Replace the UPS battery.
  - **Over Voltage** - An over-voltage condition occurred. See system administrator.
  - **Below Temperature** - The UPS battery temperature is below normal. See system administrator.
  - **Failure Detected** - A failure has been detected in the UPS battery. See system administrator.
  - **Unknown** - See system administrator.
- **Wear level** - Indicates the health of the UPS battery in graphical form. When the wear level exceeds 80%, the bar color changes to red.

- **Advanced info** - Touch to view additional UPS battery information.
  - **Battery present status** - Indicates the maximum amount of charge (in mAh) that could be pulled from the UPS battery under the present discharge conditions if the UPS battery is fully charged.
  - **Battery level** - Indicates UPS battery charge level as a percentage of scale.
  - **Battery scale** - UPS Battery scale level used to determine UPS battery level (100).
  - **Battery voltage** - Indicates current UPS battery voltage in millivolts.
  - **Battery temperature** - Indicates current UPS battery temperature in degrees Centigrade.
  - **Battery technology** - Lists the type of UPS battery.
  - **Battery current** - Indicates the battery current level.
  - **Battery manufacture date** - Lists the date of manufacture.
  - **Battery serial number** - Lists the UPS battery serial number (A1234).
  - **Battery part number** - Lists the UPS battery part number.
  - **Battery rated capacity** - Lists the UPS battery capacity in mAh.
  - **Battery decommission status** - Indicates if the UPS battery is past it's life span.
    - **Battery Good** - UPS Battery is in good health.
    - **Decommissioned Battery** - UPS Battery is past it's useful life and should be replaced.
  - **Battery cumulative charge** - Indicates the total amount of charge applied to the UPS battery.
  - **Battery present capacity** - Indicates the capacity of the UPS battery (in mAh).
  - **Battery health percentage** - Battery health indicator in percentage (0 to 100).
  - **% decommission threshold** - Lists the threshold charge cycle count. When the Battery usage number reaches this value the battery should be decommissioned.
  - **Battery present charge** - Indicates the current battery charge level (in mAh).
  - **Battery total cumulative charge** - Indicates the total accumulated charge.
  - **Battery time since first use** - Indicates the number of seconds passed since the battery was charged for the first time.
- **App version** - Lists the application version number.

## Device Central

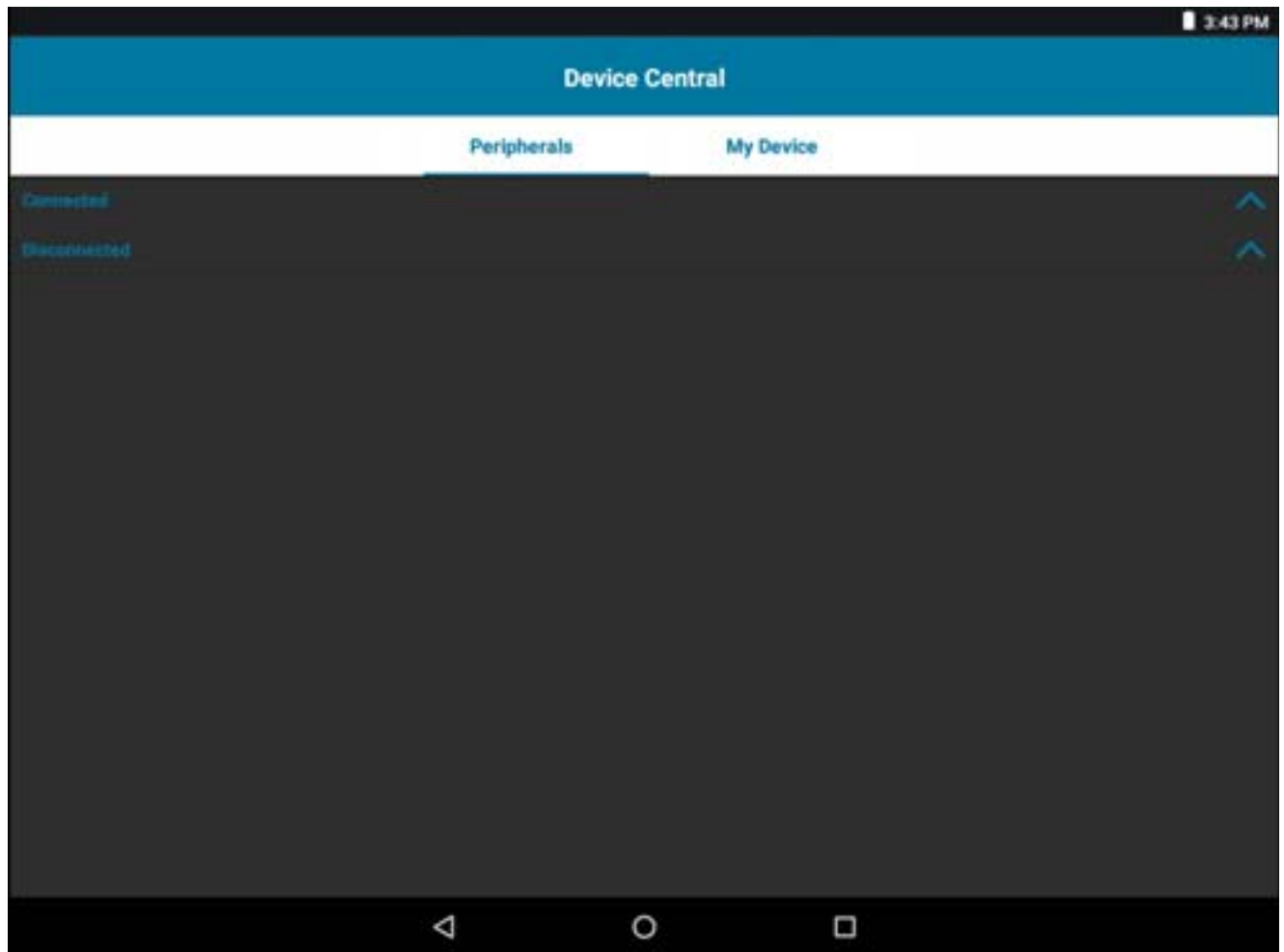
**Device Central** displays detailed information about the VC80x and connected peripherals and supports the following Zebra devices:

- RS6000 Bluetooth Ring Scanner
- HS3100 Bluetooth Headset.

Device Central features include:

- Discovering and pairing with supported peripherals via Bluetooth or corded connection.
- Paging a connected RS6000 Ring Scanner.
- Updating the firmware of supported ring scanners. For information on updating ring scanner firmware using Device Central, refer to the RS6000 User Guide.
- Displaying the connection status of peripherals.
- Displaying information for a connected peripheral in the notification bar.

**Figure 31** Device Central Screen



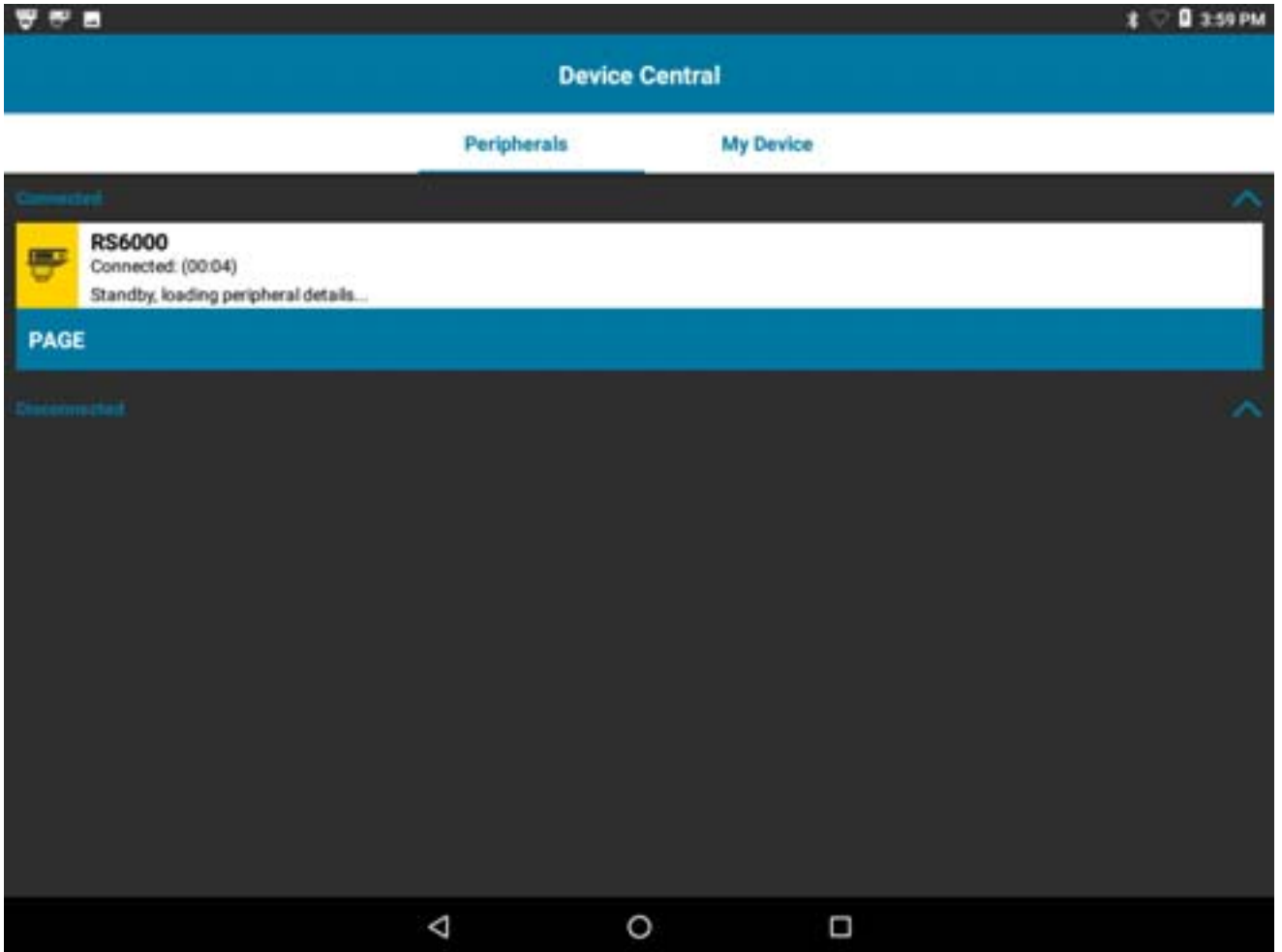
## Peripherals Tab

Displays all currently connected and previously connected peripherals. Connected peripherals display the length of time (in minutes) that they have been connected. When an RS6000 is connected the **Page** button displays. See Paging an RS6000 Ring Scanner on page 5-4.

Touch the peripheral information to display the **Device Details** screen.

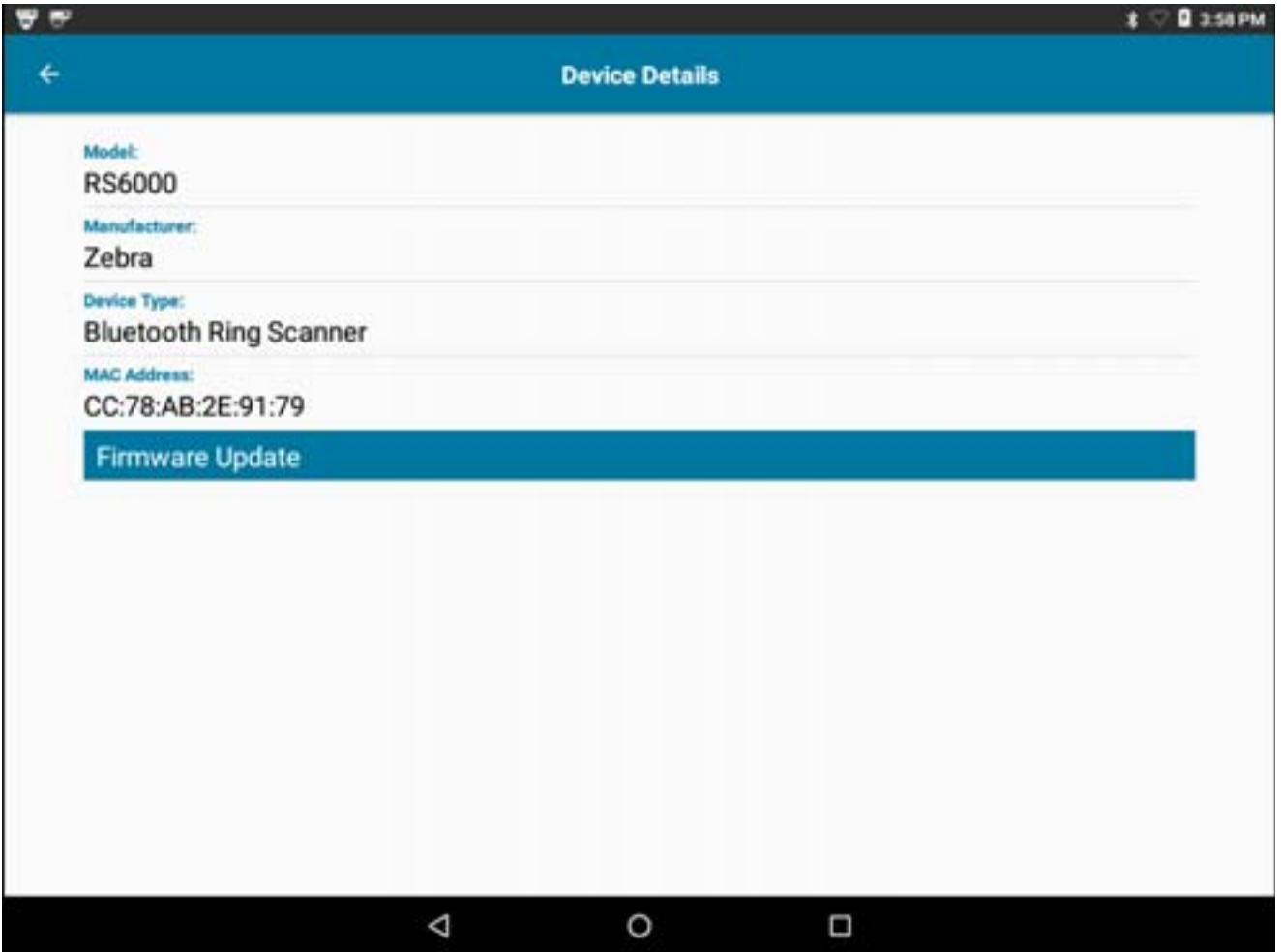
- **Device Details** - displays detailed device information for the selected peripheral.

**Figure 32** Connected Peripherals



- Touch the connected device icon to display details about the peripheral. The **Device Details** screen appears.

Figure 33 Device Details




## My Device

The **My Device** tab displays information about the VC80x and the current version of Device Central.

- **Device Name** - displays the name assigned to the VC80x.
- **Device Central Version** - displays the Device Central application version number.
- **Device Details** - Opens the **Phone status** settings window.
- **Device Battery Details** - Open the **Battery** settings window.

## Paging an RS6000 Ring Scanner

Use the **Page** button to easily locate the currently connected RS6000 Ring Scanner:

1. With the RS6000 Ring Scanner connected, swipe up from the bottom of the Home screen and touch .



**NOTE** The RS6000 Ring Scanner must be within 10 m (32 ft) of the VC80x.

2. Under the RS6000 peripheral information, touch **Page** to begin paging the RS6000. The paged RS6000 beeps and vibrates.

To stop paging, press the scan trigger of the RS6000. On a triggerless RS6000, stop paging by resetting the RS6000.

## Heater Control

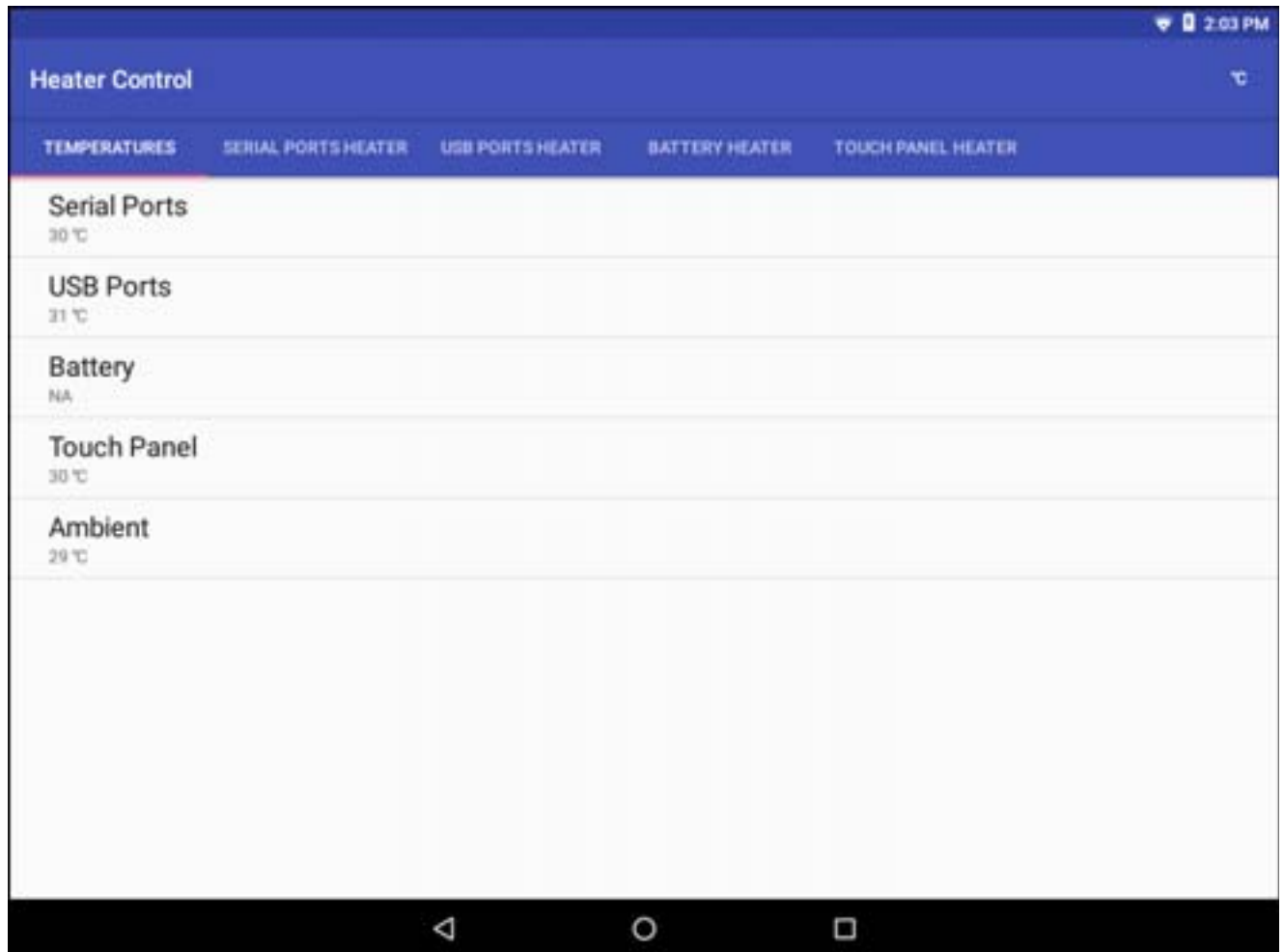


**IMPORTANT** Heater Control app is only applicable to freezer configurations.

The VC80x heater ensures optimum performance in freezers. The heater benefits include:

- Touch screen heater clears condensation on the display.
- Port heater prevents condensation on contacts.
- UPS Battery requires a heater to operate below freezing temperatures.
- The user interface displays current temperatures.

**Figure 34** Heater Control Screen



## Temperatures

The **Temperature** tab displays the current temperature for the following:

- Serial Ports
- USB Ports



- Battery
- Touch Panel
- Ambient.

## Serial Port Heater

Use the **Serial Ports Heater** tab to enable and set the heater for the serial ports.

- **Enable Heater** - Turns on or off the serial port heater. When on, the switch turn red.
- **Heater on threshold** - Set the temperature at which the heater turns on (default - 5°C/41°F).
- **Heater off threshold** - Set the temperature at which the heater turns off (default - 15°C/59°F).

## USB Port Heater

Use the **USB Ports Heater** tab to enable and set the heater for the USB ports.

- **Enable Heater** - Turns on or off the USB port heater. When on, the switch turn red.
- **Heater on threshold** - Set the temperature at which the heater turns on (default - 5°C/41°F).
- **Heater off threshold** - Set the temperature at which the heater turns off (default - 15°C/59°F).

## Battery Heater

Use the **Battery Heater** tab to enable and set the heater for the battery.

- **Enable Heater** - Turns on or off the battery heater. When on, the switch turn red.
- **Heater on threshold** - Set the temperature at which the heater turns on (default - 5°C/41°F).
- **Heater off threshold** - Set the temperature at which the heater turns off (default - 15°C/59°F).

## VC Settings



**NOTE** Ignition detect requires a CA1220 power extension cable.

**Figure 35** VC Settings Screen

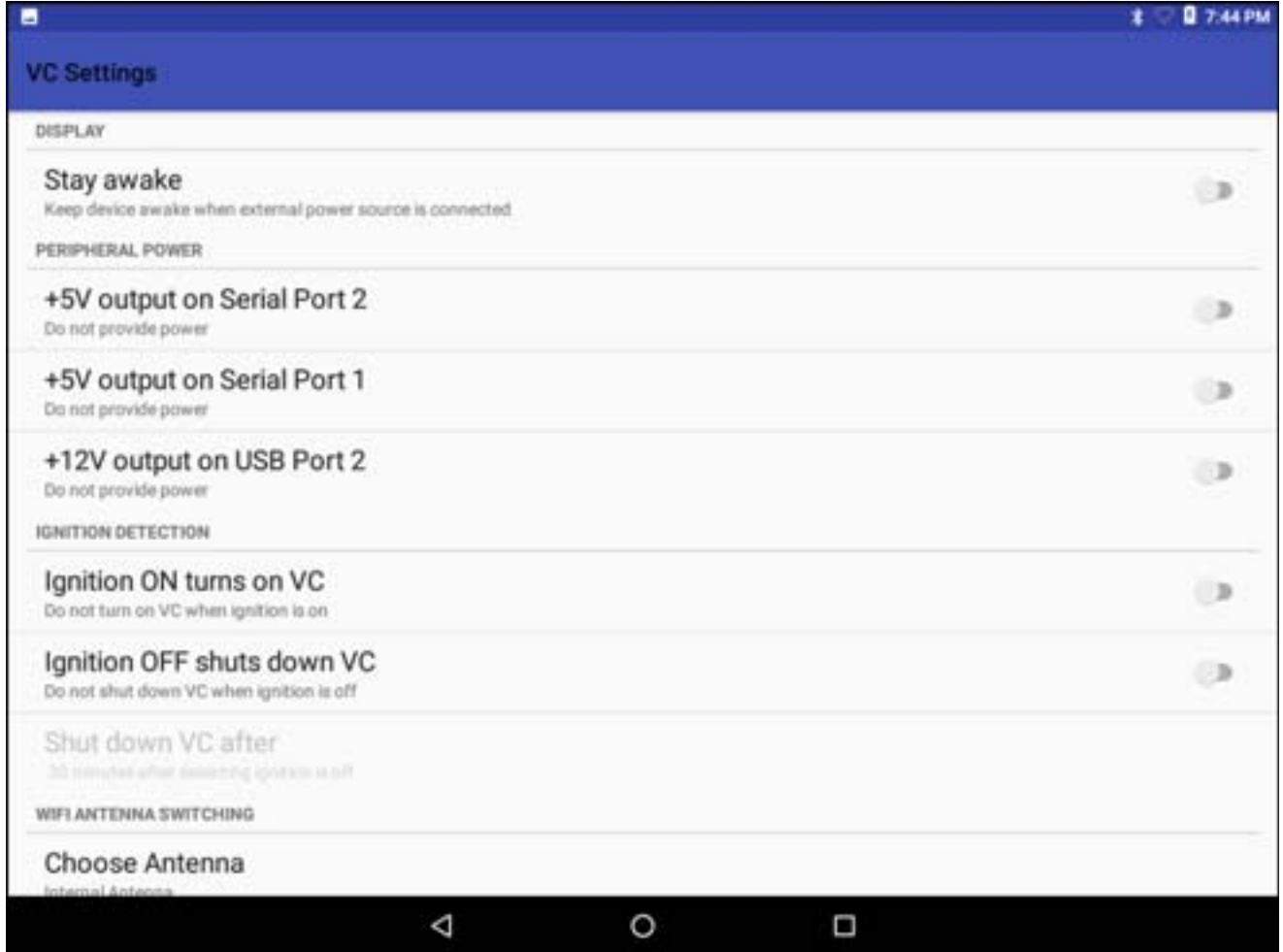
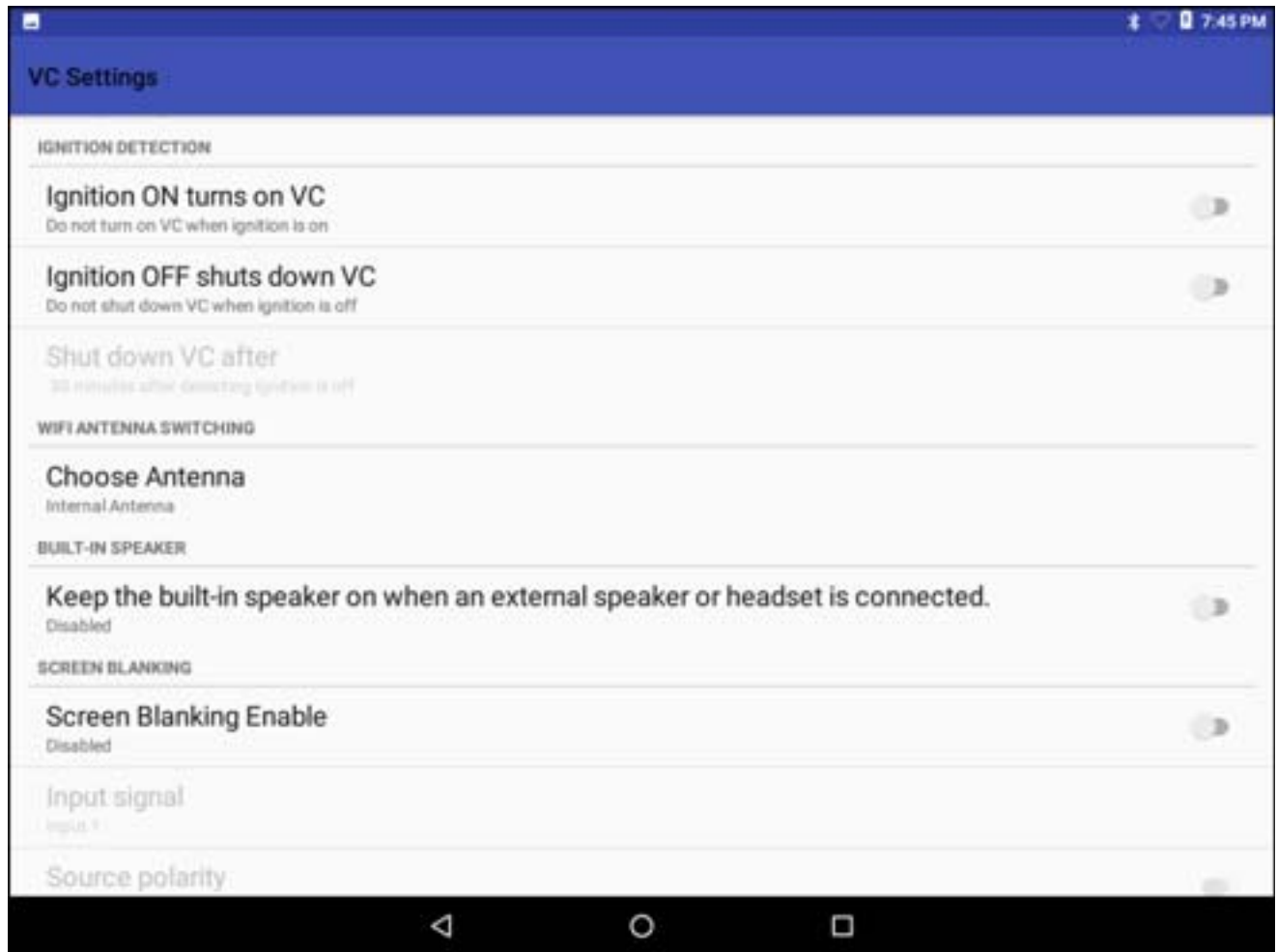


Figure 36 VC Settings Screen (Continued)



## Display

Enable/disable **Stay awake** to keep the VC80x awake when the external power source is connected.

## Peripheral Power

To provide power to an optional peripheral, turn on power to the appropriate port.

- **+5V output on Serial Port 1** - Enable/disable power for serial port 1.
- **+5V output on Serial Port 2** - Enable/disable power for serial port 2.
- **+12V output on USB** - Enable/disable additional power for the powered USB port.

## Ignition Detection

Use Ignition Detection settings to control if the VC80x turns on or off when the user turns on the ignition.



**NOTE** Ignition detect requires a CA1220 power extension cable.

- **Ignition ON Turns on VC** - Enable/disable the VC80x to turn on when the user turns the ignition on.

- **Ignition OFF shuts down VC** - Enable/disable the VC80x to turn off when the user turns the ignition off.
- **Shut down VC after** - Select the number of minutes that the VC80x turns off after the user turns off the ignition.

### WIFI Antenna Switching

Use to select which Wi-Fi antenna to use.

- **Choose Antenna** - Select antenna. Options: **Internal Antenna** (default) or **External Antenna**.

### Built-In Speaker

Enable/disable to keep the built-in speaker on when the optional M1000 Speaker/Microphone is connected.

### Screen Blanking

The optional Screen Blanking setting turns the screen off when the vehicle is moving and back on when the vehicle stops.




**NOTE** To use Screen Blanking, first connect one of the two DB9 serial ports on the VC80x to a user-supplied switch or relay. See [Connecting Switch for Screen Blanking on page 35](#).

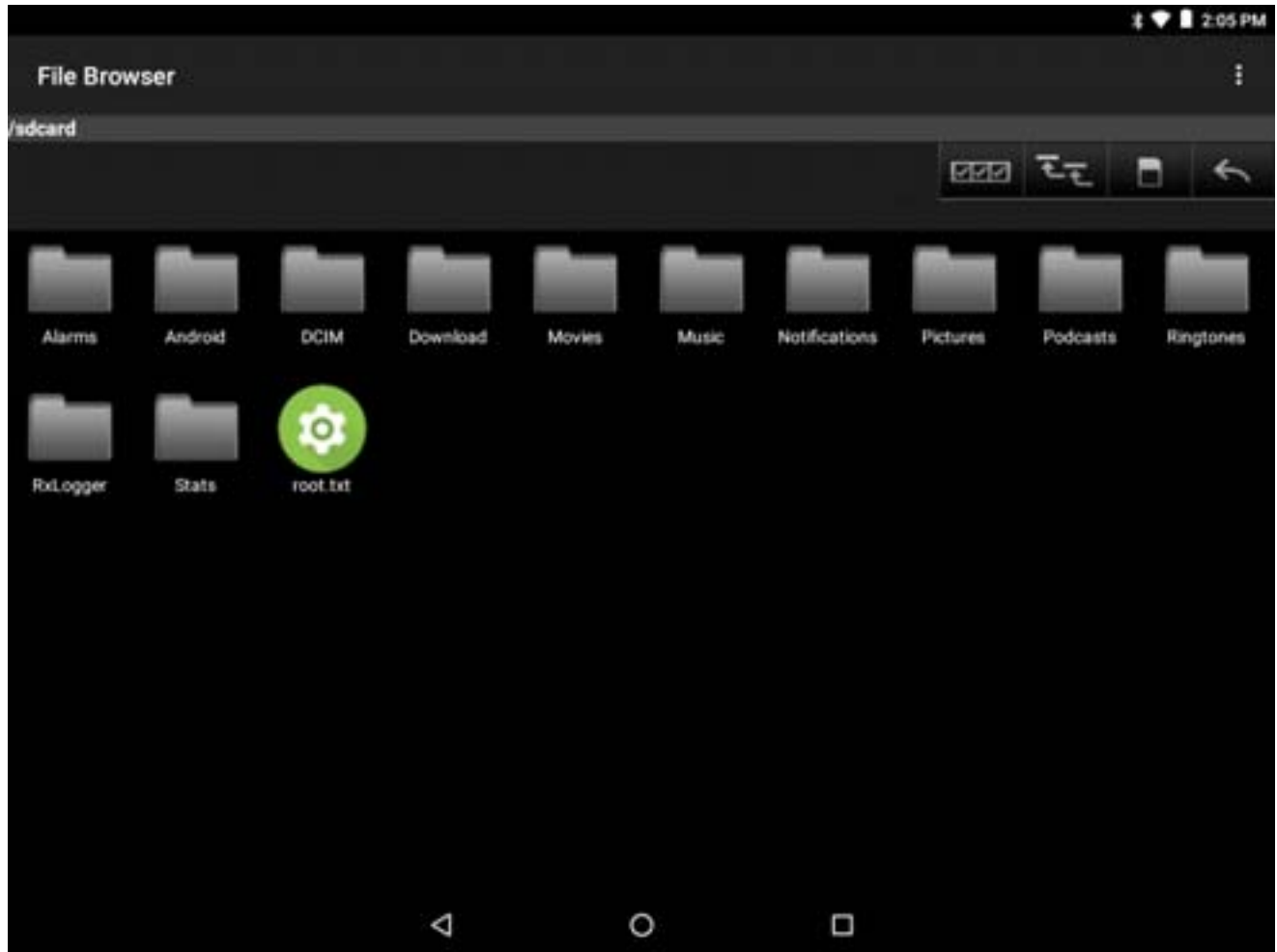
- **Screen Blanking Enable** - Enable/disable screen blanking feature.
- **Input signal** - Select the port that the screen blank cable is connected to. Options: **Input 1** or **Input 2**.
- **Source polarity** - Select blank screen option. De-select to disconnect the blank screen option.
- **Blank screen delay** - Set the amount of time after the VC80x receives the signal to blank the screen. Options 1 to 30 seconds (default - 1).

## File Browser


Use the **File Browser** application to view and manage files on the device.

To open **File Browser**, swipe up from the bottom of the Home screen and touch .


**Figure 37** File Browser Screen



The address bar indicates the current folder path. Touch the current folder path to manually enter a path and folder name.

Use  to select multiple files/folder.

Use  to view the device root folder.


Use  to view the internal storage folder.

Use  to view the previous folder the application.

Touch and hold an item to perform an operation on that item. Select one of the options from the **File Operations** menu:

- **Information** - View detailed information about the file or folder.
- **Move** - Move the file or folder to a new location.


- **Copy** - Copy the select file.
- **Delete** - Delete the selected file.
- **Rename** - Rename the select file.
- **Open as** - Open the selected file as a specific file type.
- **Share** - Share the file with other devices.

Touch  to open menu options:

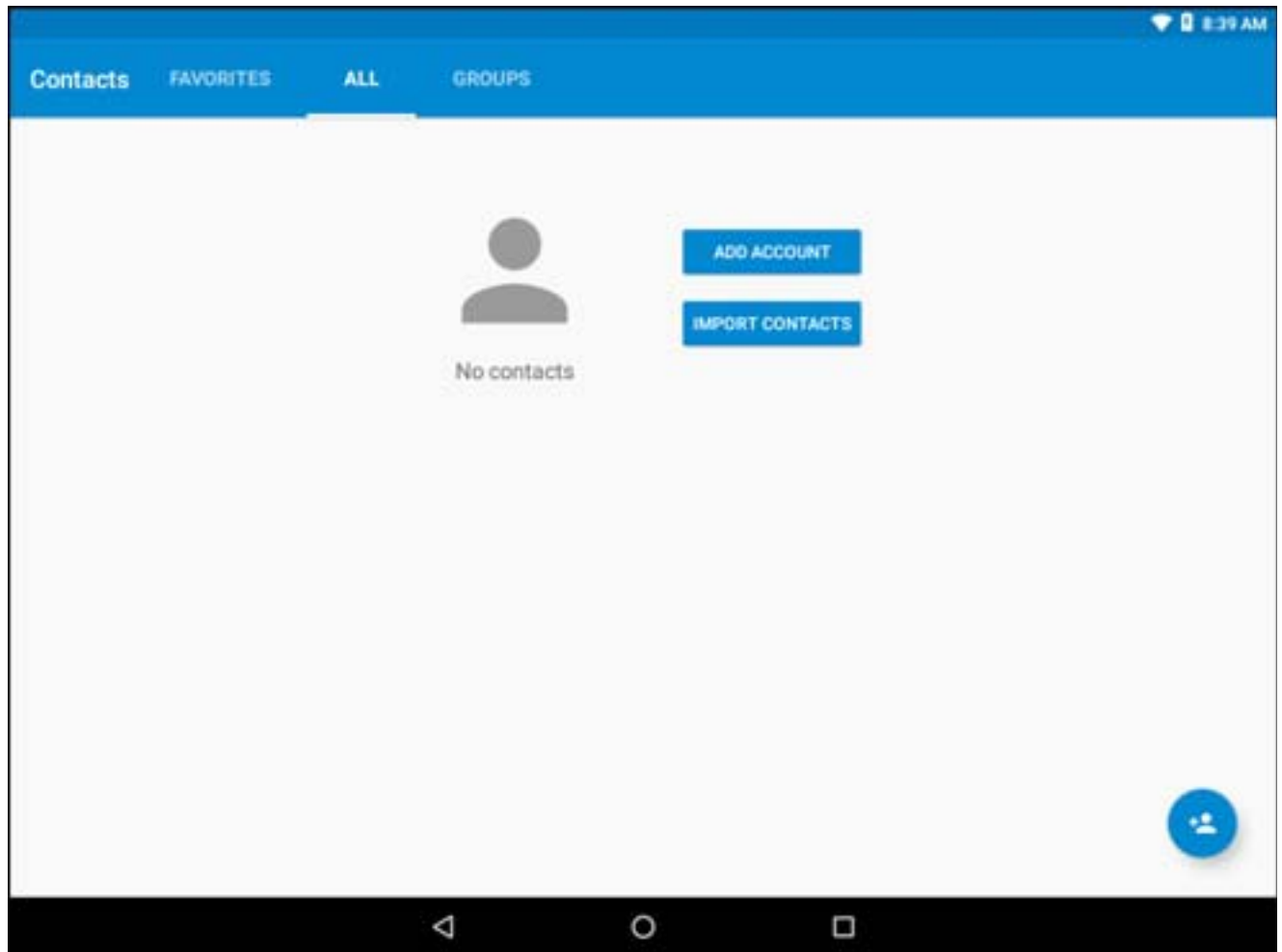
- **New Folder** - Create a new folder.
- **Search** - Search for a specific file on the device.
- **Sort** - Select the sort order of the files by name, type, size or date.
- **Refresh** - Refresh the current folder.
- **List View** - Change the folder to display item is a list. Appears only in Grid mode.
- **Grid View** - Change the folder to display item is a grid. Appears only in List mode.
- **Change Size** - Change the size of the icons.
- **About File Browser** - Displays the app version.

## Contacts



Use the **Contacts** application to manage contacts.

From a Home or **Apps** screen, touch . **People** opens to the main list of contacts. View contacts in three ways at the top of the screen: Groups, All contacts, and Favorites. Touch the tabs to change how to view the contacts. Swipe up or down to scroll through the lists.



**Figure 38** Contacts Screen




### Adding a Contact

1. In the **Contacts** application, touch .
2. If there are more than one account with contacts, touch the one to use.
3. Type the contact's name and other information. Touch a field to start typing, and swipe down to view all categories.
4. To open a menu with preset labels, such as Home or Work for an email address, touch the label to the right of the item of contact information. Or, to create your own label, touch **Custom** in the menu.
5. Touch .

## Editing Contacts

1. In the **Contacts** application, touch a contact name to edit.
2. Touch .
3. Edit the contact information.
4. Touch .

## Deleting Contacts

1. In the **Contacts** application, touch a contact name to delete.
2. Touch .
3. Touch **Delete**.
4. Touch **Delete** to confirm.



# Gallery




**NOTE** The device supports the following image formats: jpeg, gif, png and bmp.  
The device supports the following video formats: H.263, H.264 and MPEG4 Simple Profile.  
Available on device with AOSP software only.

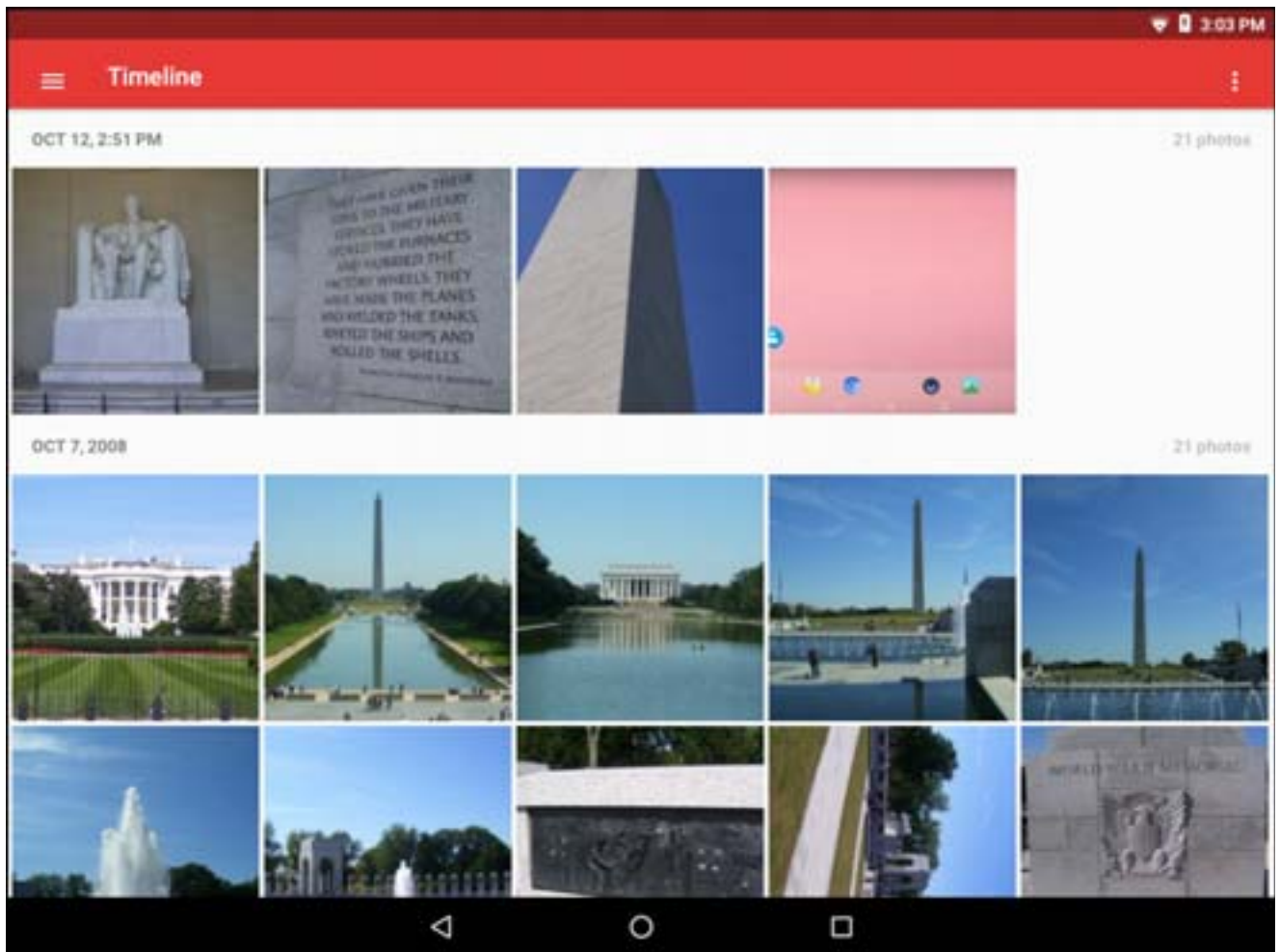
Use Gallery to:

- view photos
- play videos
- perform basic editing of photos
- set photos as wallpaper
- set photos as a contact photo
- share photos and videos.

**Gallery** presents all photos and videos stored on internal memory.

To open the gallery application, swipe up from the bottom of the Home screen and touch .

**Figure 39** Gallery - Thumbnail View



## Photos

---



**NOTE** The device supports the following image formats: jpeg, gif, png and bmp.


The device supports the following video formats: H.263, H.264 and MPEG4 Simple Profile.

Available on device with GMS software only.

Use Photos to:

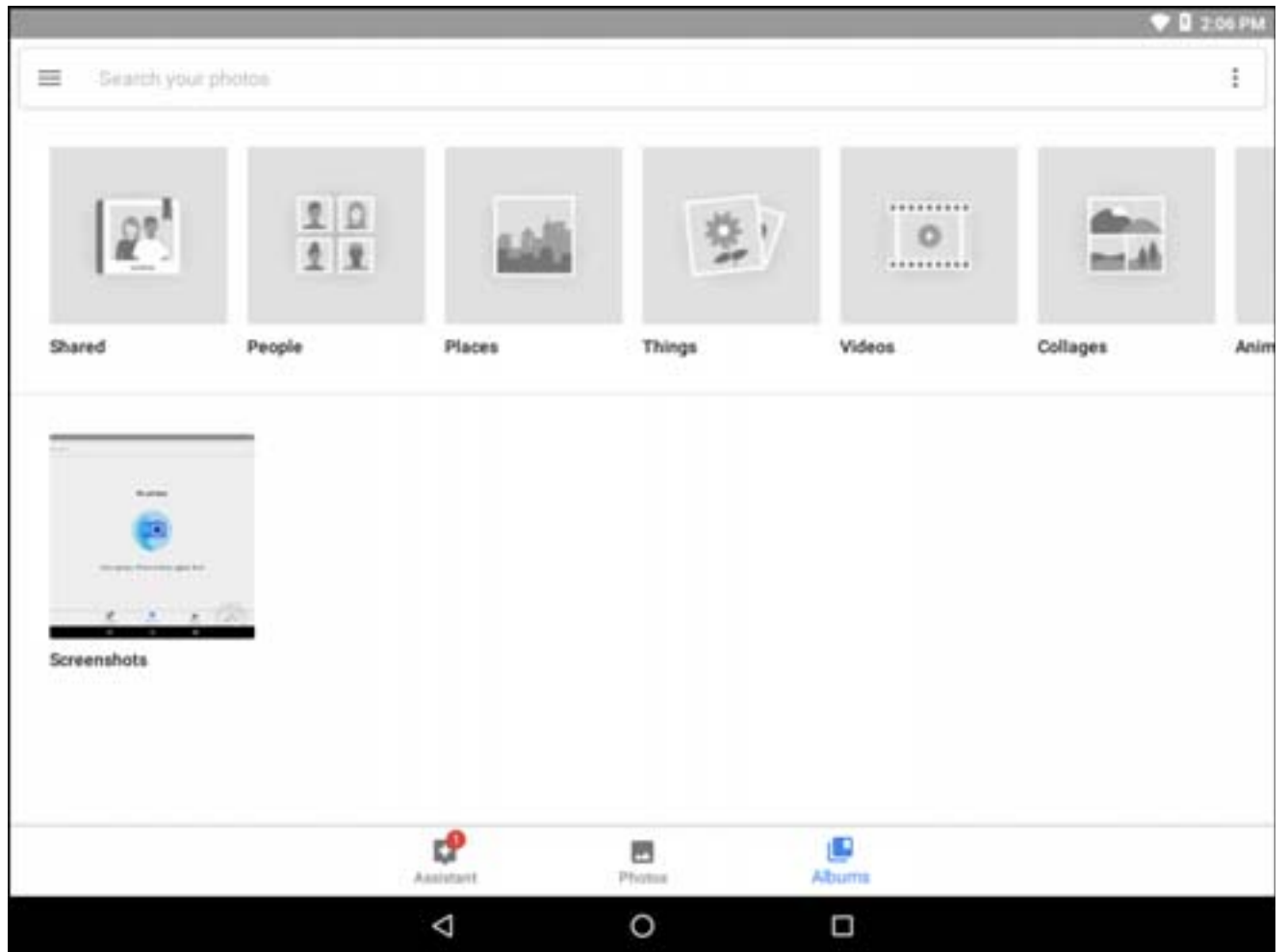
- view photos
- play videos
- perform basic editing of photos
- set photos as wallpaper
- set photos as a contact photo
- share photos and videos.

**Photos** presents all photos and videos stored on internal memory.

To open the **Photos** application, swipe up from the bottom of the Home screen and touch .

By default, Photos open to the Photos view.

**Figure 40** Photos View



Touch **Albums** to view photos sorted by albums.

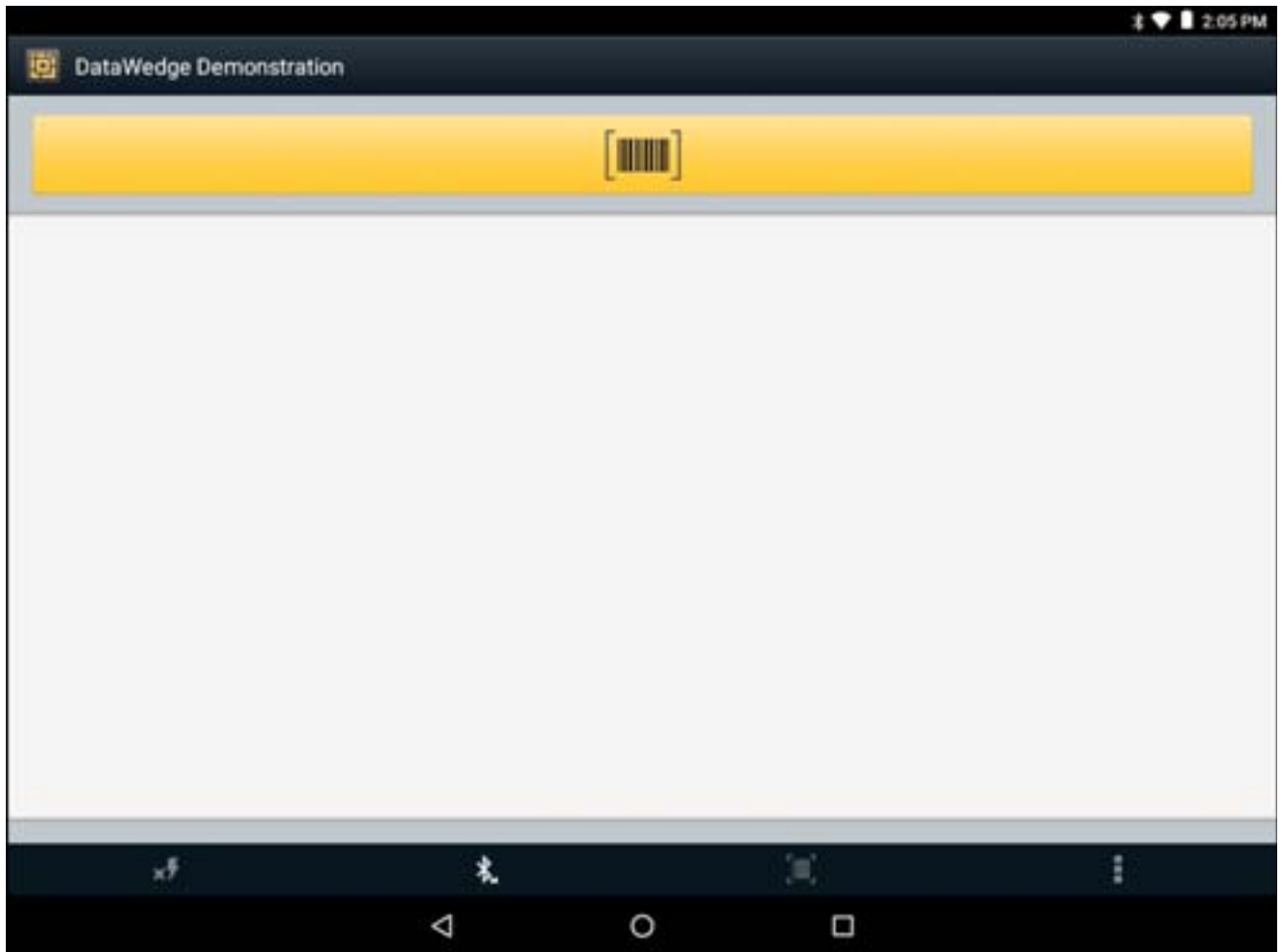
## DataWedge Demonstration



**NOTE** See [DataWedge Configuration](#) for information on DataWedge configuration.

Use **DataWedge Demonstration** to demonstrate data capture functionality.









**Figure 41** DataWedge Demonstration Window



**Table 5** DataWedge Demonstration Icons

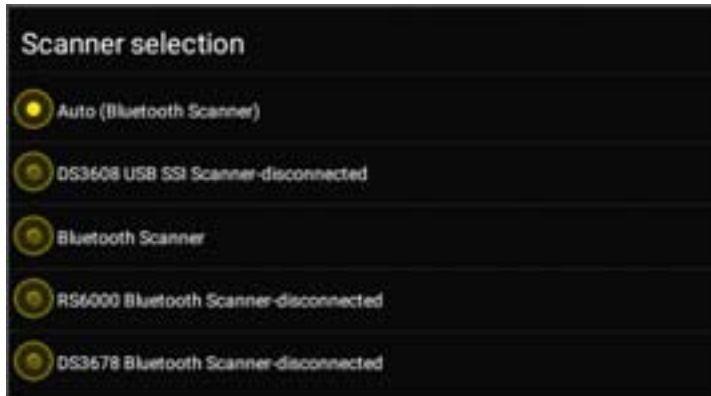
Feature	Icon	Description
Illumination		Indicates scanner illumination is off. Touch to turn illumination on.
		Indicates scanner illumination is on. Touch to turn illumination off.

**Table 5** DataWedge Demonstration Icons (Continued)

Feature	Icon	Description
Data Capture		Indicates that the data capture function is through the internal imager.
		Indicates a USB scanner is connected to the VC80x.
		Indicates a USB scanner is not connected to the VC80x.
		Indicates that a Bluetooth scanner is not connected to the VC80x.
		Indicates that a Bluetooth scanner is connected to the VC80x.
Scan Mode		Indicates imager is in picklist mode. Touch to change to normal scan mode.
		Indicates imager is in normal scan mode. Touch to change to picklist mode.
Menu		Opens a menu to view the application information or to set the application DataWedge profile.

Touch the Data Capture icon to select the data capture mode.

**Figure 42** Data Capture Options Menu




Select a scanner to use. See [Data Capture](#) for configuring scanner options.

Either press the programmable button or touch the yellow scan button to enable data capture. The captured data appears in the text field below the yellow button.

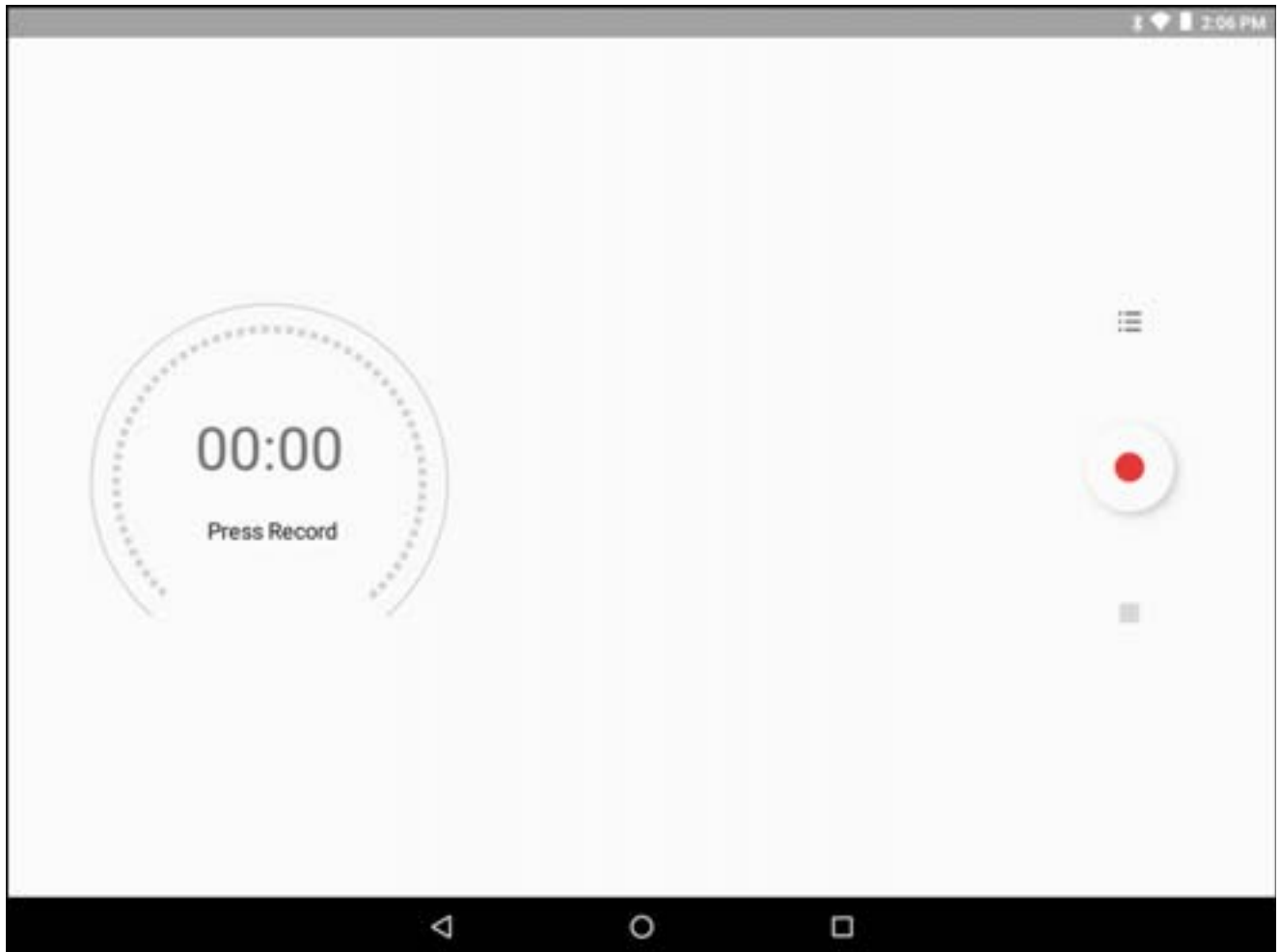
## Sound Recorder

Use **Sound Recorder** to record audio messages.

To open the **Sound Recorder** application, swipe up from the bottom of the Home screen and touch .

Recordings are saved on Internal Storage and available in the Music application playlist titled “Audio Recordings.”

**Figure 43** Sound Recorder Application



---

## PTT Express Voice Client



**IMPORTANT** The optional M1000 Speaker/Microphone is required to use PTT Express on the VC80x.

PTT Express Voice Client creates Push-To-Talk (PTT) communication capability between disparate enterprise devices. Leveraging existing Wireless Local Area Network (WLAN) infrastructure, PTT Express delivers simple PTT communication without the need of a voice communication server.

- **Group Call:** Press and hold the Talk button to start communicating with other voice client users.
- **Private Response:** Double-press and the Talk button to respond to the originator of the last broadcast or to make a Private Response.

Refer to the PTT Express User Guide at [www.zebra.com/support](http://www.zebra.com/support) for information on configuring the PTT Express Client application.

### Speaker/Microphone Setup

Use the optional M1000 Speaker/Microphone to use PTT Express:

1. Remove the dust cover on the back of the VC80x.
2. Plug the Speaker/microphone audio plug into the Speaker/Mic jack.
3. Replace the audio cable into the cable strain relief.
4. Replace the dust cover.

### PTT Audible Indicators

The following tones provide helpful cues when using the voice client.

- **Talk Tone:** Double chirp. Plays when the Talk button is depressed. This is a prompt for the user to start talking.
- **Access Tone:** Single beep. Plays when another user just finished a broadcast or response. The user is now able to initiate a Group Broadcast or Private Response.
- **Busy Tone:** Continuous tone. Plays when the Talk button is depressed and another user is already communicating on the same talkgroup. Plays after the maximum allowed talk time is reached (60 seconds).
- **Network Tone:**
  - Three increasing pitch beeps. Plays when PTT Express has acquired the WLAN connection and the service is enabled.
  - Three decreasing pitch beeps. Plays when PTT Express has lost the WLAN connection or the service is disabled.

**Figure 44** PTT Express Default User Interface



**Table 6** PTT Express Default User Interface Descriptions

Item	Description
Notification Icon	Indicates the current state of the PTT Express client.
Service Indication	Indicates the status of the PTT Express client. Options: <b>Service Enabled</b> , <b>Service Disabled</b> or <b>Service Unavailable</b> .
Talk Groups	Lists all 32 Talk Groups available for PTT communication.
Settings	Opens the PTT Express Settings screen.
Enable/Disable Switch	Turns the PTT service on and off.

## Notification Icons




Indicates the current state of the PTT Express Voice client.

**Table 7** PTT Express Default User Interface Descriptions


Status Icon	Description
	Indicates that PTT Express Voice client is disabled.
	Indicates that PTT Express Voice client is enabled but not connected to a WLAN.
	Indicates that PTT Express Voice client is enabled, connected to a WLAN and listening on the Talk Group indicated by the number next to the icon.
	Indicates that PTT Express Voice client is enabled, connected to a WLAN and communicating on the Talk Group indicated by the number next to the icon.



**Table 7** PTT Express Default User Interface Descriptions (Continued)

Status Icon	Description
	Indicates that PTT Express Voice client is enabled, connected to a WLAN and in a private response.
	Indicates that PTT Express Voice client is enabled and muted.
	Indicates that the PTT Express Voice client is enabled but it is not able to communicate due to a VoIP telephony call is in progress.

## Enabling PTT Communication

1. Swipe up from the bottom of the Home screen and touch .
2. Slide the **Enable/Disable Switch** to the **ON** position. The button changes to an **ON** button.

## Selecting a Talk Group

One of 32 Talk Groups can be selected by PTT Express users. However, only one talk group may be enabled at a time on the device. Touch one of the 32 Talk Groups. The selected Talk Group is highlighted.

## PTT Communication



**NOTE** This section describes the default PTT Express client configuration. See the PTT Express V1.2 User Guide for detailed information on using the client.

All calls are initiated using the Talk button.

### Creating a Group Call

1. Press and hold the Talk button and listen for the talk tone to play.  
If a busy tone is heard, release the button and wait a moment before making another attempt. Ensure that PTT Express and the WLAN are enabled.
2. Start talking after the talk tone is heard.



**NOTE** If the user holds the button for more than 60 seconds (default), the call is dropped allowing others to make Group calls. The user should release the button when finished talking to allow others to make calls.

3. Release the button when finished talking.



### Responding with a Private Response

The Private Response can only be initiated once a Group Call has been established. The initial Private Response is made to the originator of the Group Call.

1. Wait until an access tone is heard.
2. Within 10 seconds, double-press the Talk button, and listen for the talk tone to play.
3. If a busy tone is heard, release the button and wait a moment before making another attempt. Ensure that PTT Express and the WLAN are enabled.

4. Start talking after the talk tone plays.
5. Release the button when finished talking.

### Disabling PTT Express Voice Client Communication

1. Swipe up from the bottom of the Home screen and touch .
2. Slide the **Enable/Disable Switch** to the **OFF** position. The button changes to **OFF**.
3. Touch .

## RxLogger



RxLogger is a comprehensive diagnostic tool that provides application and system metrics. It allows for custom plug-ins to be created and work seamlessly with this tool. RxLogger is used to diagnose device and application issues. Its information tracking includes the following: CPU load, memory load, memory snapshots, battery consumption, power states, wireless logging, cellular logging, TCP dumps, Bluetooth logging, GPS logging, logcat, FTP push/pull, ANR dumps, etc. All logs and files generated are saved onto flash storage on the device (internal or external).

**Figure 45** RxLogger





### Enabling Logging

To enable RxLogger:

1. Swipe up from the bottom of the Home screen and touch .
2. Touch **START**. RxLogger begins collecting data.
3. Touch .

## Disabling Logging

To disable RxLogger:

1. Swipe up from the bottom of the Home screen and touch .
2. Touch **STOP**. RxLogger stops collecting data.
3. Touch .

## RxLogger Configuration

RxLogger is built with an extensible plug-in architecture and comes packaged with a number of plug-ins already built-in. The included plug-ins are described below. Touch **Settings** to open the configuration screen.

**Figure 46** RxLogger Settings Screen



### ANR Module

Application Not Responsive (ANR) indicates that a running application's UI thread is not responding for a specified time period. RxLogger is able to detect this condition and trigger a copy of the call stack trace of the unresponsive application into the log directory. The event will also be indicated in the high level CSV log.

- **Enable Module** - Enables logging for this module.

- **Log path** - Specifies the default log path to store the ANR log files.
- **Collect Historic ANRs** - Enable to save all previously stored logs.

### Kernel Module

The Kernel Module captures kmsg from the system.

- **Enable Module** - Enables logging for this kernel module.
- **Log path** - Specifies the high level log path for storage of all kernel logs. This setting applies globally to all kernel buffers.
- **Kernel Log filename** - Specifies the base log filename for this kernel buffer. The current file count is appended to this name.
- **Max Kernel log file size** - Specifies the maximum size, in megabytes, of an individual log file.
- **Kernel Log interval** - Sets the interval, in seconds, on which to flush the log buffer to the file.
- **Kernel Log file count** - Specifies the number of log files to keep and rotate through. Each log file is subject to the max log size option.

### Logcat Module

Logcat is an essential debugging tool on Android devices. RxLogger provides the ability to record data from all four of the available logcat buffers. The Logcat plug-in has the ability to collect data from multiple logcat buffers provided by the system. Currently these are the main, event, radio, and system buffers. Each of the settings are available for each buffer independently unless otherwise noted.

- **Enable Module** - Enables logging for this module.
- **Log path** - Specifies the high level log path for storage of all logcat logs. This setting applies globally to all logcat buffers.
- **Enable main logcat** - Enables logging for this logcat buffer.
  - **Main Log interval** - Sets the interval, in seconds, on which to flush the log buffer to the file.
  - **Main Log filename** - Specifies the base log filename for this logcat buffer. The current file count is appended to this name.
  - **Main Log file count** - Specifies the number of log files to keep and rotate through. Each log file is subject to the max log size option.
  - **Main Max log file size** - Specifies the maximum size, in megabytes, of an individual log file.
  - **Main Log Filter** - Custom logcat filter to run on the main buffer.
- **Enable event logcat** - Enables event logging for this logcat buffer.
  - **Event Log interval** - Sets the interval, in milliseconds, on which to flush the log buffer to the file.
  - **Event Log filename** - Specifies the base log filename for this logcat buffer. The current file count is appended to this name.
  - **Event Log file count** - Specifies the number of log files to keep and rotate through. Each log file is subject to the max log size option.
  - **Event Max log file size** - Specifies the maximum size, in kilobytes, of an individual log file.
  - **Event log filter** - Custom logcat filter to run on the event buffer.

- **Enable radio logcat** - Enables logging for this logcat buffer.
  - **Radio log interval** - Sets the interval, in milliseconds, on which to flush the log buffer to the file.
  - **Radio log filename** - Specifies the base log filename for this logcat buffer. The current file count is appended to this name.
  - **Radio log file count** - Specifies the number of log files to keep and rotate through. Each log file is subject to the max log size option.
  - **Radio log File size** - Specifies the maximum size, in kilobytes, of an individual log file.
  - **Radio log Filter** - Custom logcat filter to run on the radio buffer.
- **Enable system logcat** - Enables logging for this logcat buffer.
  - **System log interval** - Sets the interval, in milliseconds, on which to flush the log buffer to the file.
  - **System log filename** - Specifies the base log filename for this logcat buffer. The current file count is appended to this name.
  - **System log file count** - Specifies the number of log files to keep and rotate through. Each log file is subject to the max log size option.
  - **System log file size** - Specifies the maximum size, in kilobytes, of an individual log file.
  - **System log filter** - Custom logcat filter to run on the system buffer.
- **Enable crash logcat** - Enables logging for this crash logcat buffer.
  - **Crash log Interval** - Sets the interval, in milliseconds, on which to flush the log buffer to the file.
  - **Crash log Filename** - Specifies the base log filename for this logcat buffer. The current file count is appended to this name.
  - **Crash log file count** - Specifies the number of log files to keep and rotate through. Each log file is subject to the max log size option.
  - **Crash log file size** - Specifies the maximum size, in kilobytes, of an individual log file.
  - **Crash log filter** - Custom logcat filter to run on the crash buffer.
- **Enable combined logcat** - Enables logging for this logcat buffer.
  - **Enable main buffer** - Enable or disable the addition of the main buffer into the combined logcat file.
  - **Enable event buffer** - Enable or disable the addition of the event buffer into the combined logcat file.
  - **Enable radio buffer** - Enable or disable the addition of the radio buffer into the combined logcat file.
  - **Enable system buffer** - Enable or disable the addition of the system buffer into the combined logcat file.
  - **Enable crash buffer** - Enable or disable the addition of the crash buffer into the combined logcat file.
  - **Combined log filename** - Specifies the base log filename for this logcat buffer. The current file count is appended to this name.
  - **Combined log file count** - Specifies the number of log files to keep and rotate through. Each log file is subject to the max log size option.
  - **Combined log file size** - Specifies the maximum size, in kilobytes, of an individual log file.
  - **Combined log filter** - Custom logcat filter to run on the combined buffer.

### LTS Module

The LTS (Long Term Storage) Module captures data over a long duration of time without losing any data. Whenever a file is done being written to, LTS will then GZ the file and save it in an organize path for later use.

- **Enable Module** - Enables logging for this module.

- **Storage Directory** - Specifies the high level log path for storage of all logcat logs. This setting applies globally to all logcat buffers.

### Ramoops Module

Ramoops Module captures last kmsg from the device.

- **Enable Module** - Enables logging for this module.
- **Log path** - Specifies the high level log path for storage of all ramoops logs. This setting applies globally to all ramoops buffers.
- **Base filename** - Specifies the base log filename for this kernel buffer. The current file count is appended to this name.
- **Ramoops file count** - Specifies the number of log files to keep and rotate through. Each log file is subject to the max log size option.

### Resource Module

The Resource Module captures devices information on an interval. The data collected contains system statistics to see the health of device over a period of time.

- **Enable Module** - Enables logging for this module.
- **Log path** - Specifies the high level log path for storage of all resource logs. This setting applies globally to all resource buffers.
- **Resource Log interval** - Sets the interval, in seconds, on which to flush the log buffer to the file.
- **Resource Log file size** - Specifies the maximum size, in megabytes, of an individual log file.
- **Resource Log file count** - Specifies the number of log files to keep and rotate through. Each log file is subject to the max log size option.
- **Power** - Enables or disables the collection of Battery statistics.
- **System Resource** - Enables or disables the collection of System Resource information.
- **Network** - Enables or disables the collection of Network status.
- **Bluetooth** - Enables or disables the collection of Bluetooth information.
- **Light** - Enables or disables the collection of ambient light level.
- **Heater** - Enables or disables the collection of heater temperature data.

### Snapshot Module

The Snapshot Module collects detailed device statistics on an interval to see detailed device information.

- **Enable Module** - Enables logging for this module.
- **Log path** - Specifies the base path to use to store the snapshot files
- **Log filename** - Specifies the base filename for all the snapshot files. This file number will be appended to this base filename when saving the snapshot.
- **Log interval** - Specifies the interval, in milliseconds, on which to invoke a detailed snapshot.
- **Snapshot file count** - The maximum number of Snapshot files to keep at any one time.
- **Top** - Enables or disables the running of the “top” command for data collection.
- **CPU Info** - Enables detailed per process CPU logging in the snapshot.
- **Memory Info** - Enables logging of detailed per process memory usage in the snapshot.

- **Battery Info** - Enables logging of detailed power information including battery life, on time, charging, and wake locks.
- **Wake Locks** - Enables or disables the collection of the sys/fs wake\_lock information.
- **Time in State** - Enables or disables the collection of the sys/fs cpufreq for each core.
- **Processes** - Enables dumping the complete process list in the snapshot.
- **Threads** - Enables dumping all processes and their threads in the snapshot.
- **Properties** - Enables dumping of all system properties on the device. This includes build/version information as well as state information.
- **Interfaces** - Enables or disables the running of the “netcfg” command for data collection.
- **IP Routing Table** - Enables or disables the collection of the net route for data collection.
- **Connectivity** - Enables or disables the running of the “dumpsys connectivity” command for data collection.
- **Wifi** - Enables or disables the running of the “dumpsys wifi” command for data collection.
- **Filesystems** - Enables dumping of the available volumes on the file system and the free storage space for each.
- **Usage stats** - Enables dumping of detailed usage information for each package on the device. This includes the number of starts and duration of each run.

### TCPDump Module

The TCPDump Module captures tcp data that happens over the device’s networks.

- **Enable Module** - Enables logging for this module.
- **Log path** - Specifies the location to store the TCPDump output log files.
- **Base filename** - Specifies the base filename to use when storing the TCPDump files. The index number of the current log file will be appended to this filename.
- **Tcpdump file size** - Specifies the maximum file size, in megabytes, for each log file created.
- **Tcpdump file count** - Specifies the number of log files to cycle through when storing the network traces.



### Tombstone Module

The Tombstone Module collects tombstone (Linux Native Crashes) logs from the device.

- **Enable Module** - Enables logging for this module.
- **Log path** - Specifies the location to store the Tombstone output log files.
- **Collect Historic tombstones** - Enable to save all previously stored logs.

## Enabling Logging



To enable logging:

1. Swipe the screen up and select .
2. Touch **Start**.
3. Touch .

## Disabling Logging

To disable logging:



1. Swipe the screen up and select .
2. Touch **Stop**.
3. Touch .

### Extracting Log Files

1. Connect the device to a host computer using an USB connection.
2. Using a file explorer, navigate to the RxLogger folder.
3. Copy the file from the device to the host computer.
4. Disconnect the device from the host computer.

## RxLogger Utility

RxLogger Utility is a data monitoring application for viewing logs in the VC80x while RxLogger is running. The user can access the logs and RxLogger Utility features in the App View or the Overlay View.

In the App View the user views logs in the RxLogger Utility.

**Figure 47** RxLogger Utility App View



RxLogger Utility is a data monitoring application for viewing logs in the VC80x while RxLogger is running. The user can access the logs and RxLogger Utility features in the App View or the Overlay View.

### App View

In App View the user views logs in the RxLogger Utility.

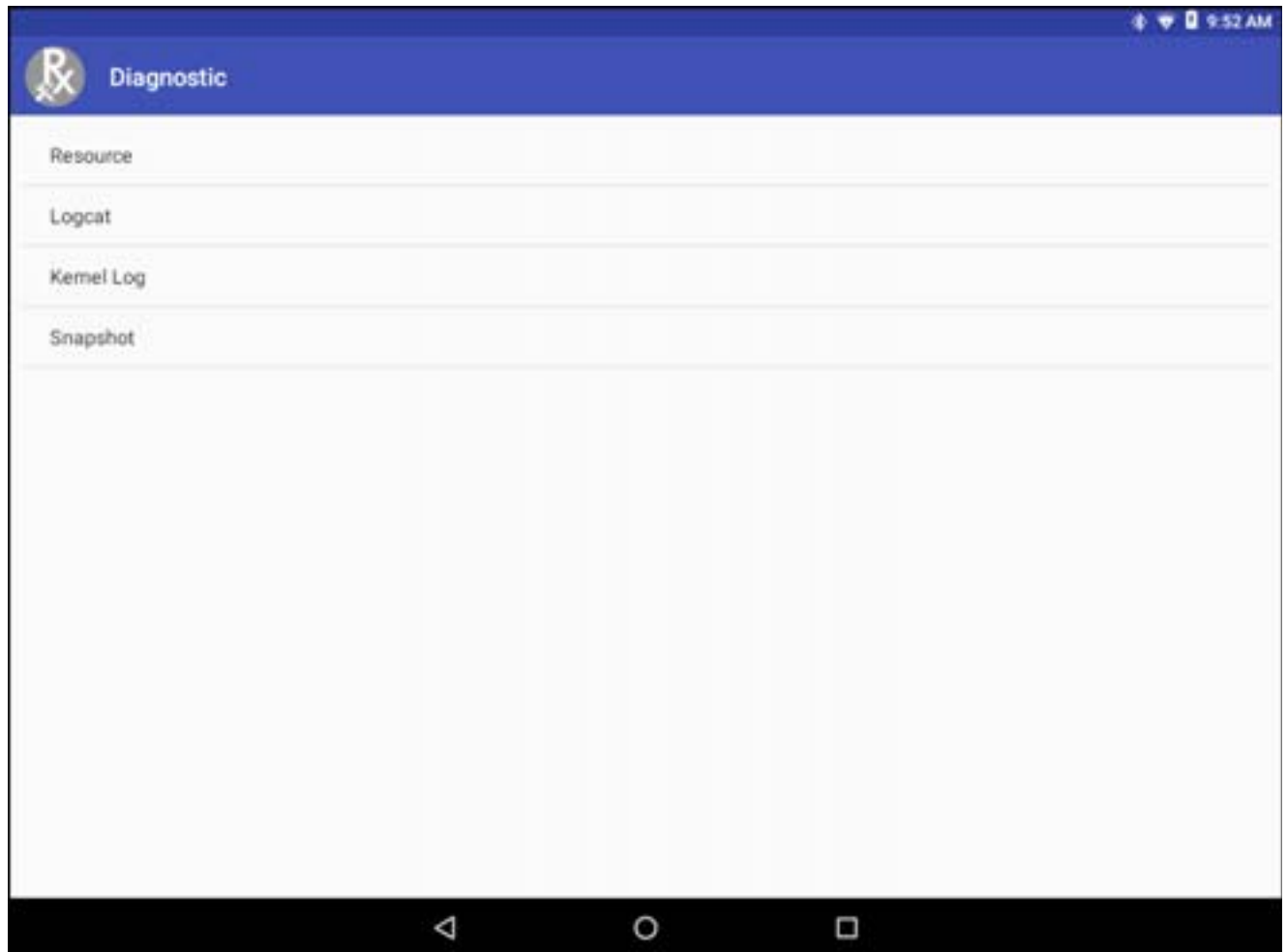
Figure 48 App View



### Viewing Logs

Touch **View**. The **Diagnostic** window appears.

Figure 49 Diagnostic Window



- **Resource** - View all resources.
- **Logcat** - View all the Logcat files. Messages are colored according to flags. Verbose messages is orange text, Assert messages are in brown text, Fail messages are in purple text, Warning messages are in yellow text, information messages are in blue text, debug messages are in green text, and error messages are in red.
- **Kernel Log** - View all the Kernel Logs.
- **Snapshot** - View all the Snapshot.

## Backup

RxLogger Utility allows the user to make a zip file of the RxLogger folder in the device, which by default contains all the RxLogger logs stored in the device.

Figure 50 Backup Message



Touch **Yes** to save the backup data.

## Archiving

The user can view all the RxLogger logs stored in the RxLogger directory by default. These is not for live-viewing logs.

**Figure 51** Archive



Touch any of the options to view the log files.

## Overlay View

To initiate Overlay view:

1. Open **RxLogger**.
2. Touch **☰** > **Toggle Chat Head**. The Chat Head icon appears on the screen.

## Removing the Main Chat Head

To remove the Main Chat Head icon:

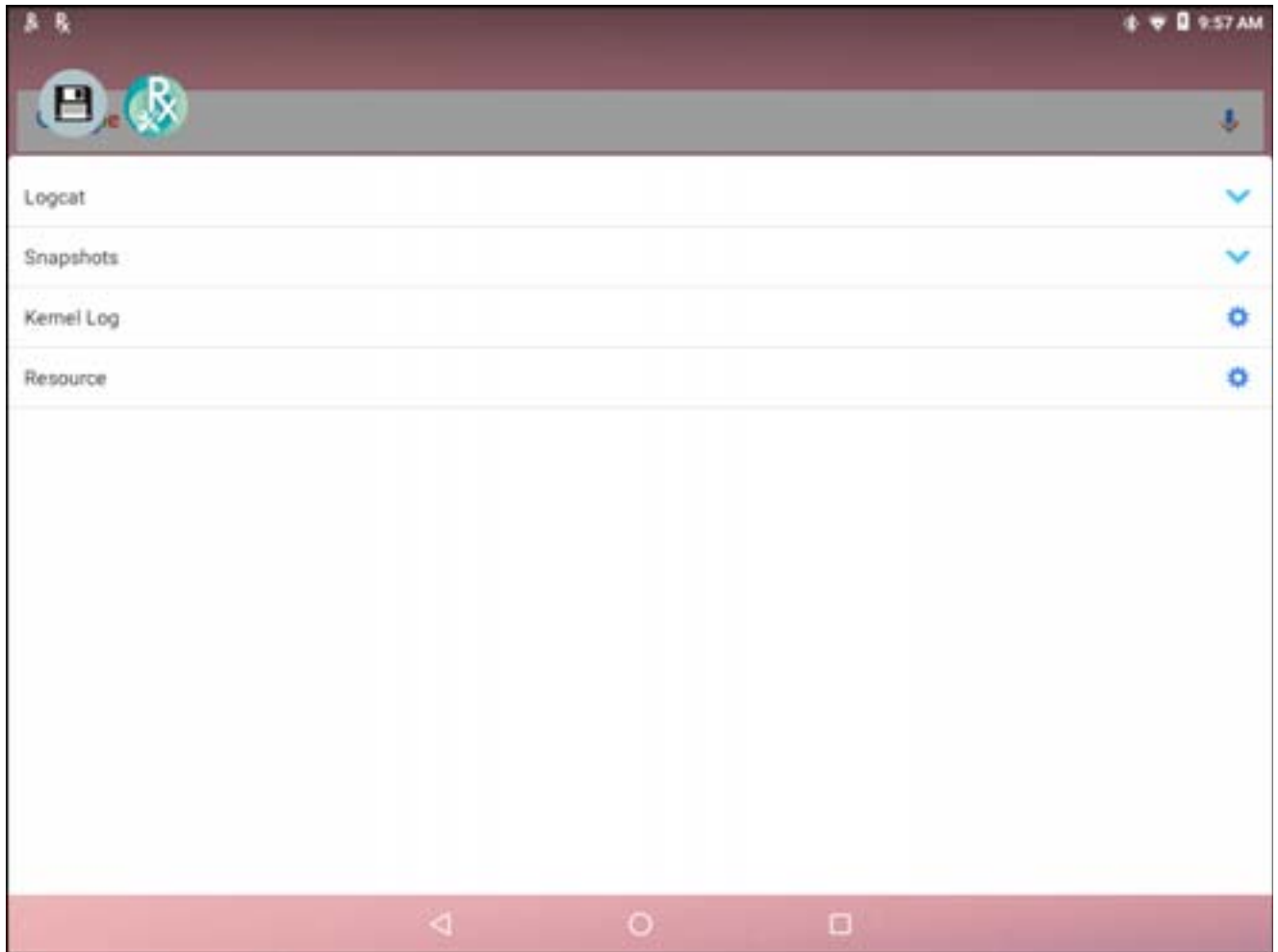
1. Touch and drag the icon. A circle with an X appears.
2. Move the icon over the circle and then release.

## Viewing Logs

To view logs:

1. Touch the Main Chat head icon. The In View screen appears.

**Figure 52** In View Screen



2. Touch a log to open it. The user can open many logs with each displaying a new sub Chat Head.
3. Touch a sub Chat Head to display the log contents. If there are more sub Chat Head icon, scroll left or right to view additional icons.

Figure 53 Log File



## Removing a Sub Chat Head Icon

To remove a sub chat Head icon, press and hold the icon until it disappears.

## Backup


RxLogger Utility allows the user to make a zip file of the RxLogger folder in the device, which by default contains all the RxLogger logs stored in the device.

Backup Now icon is always available in the Overlay View.

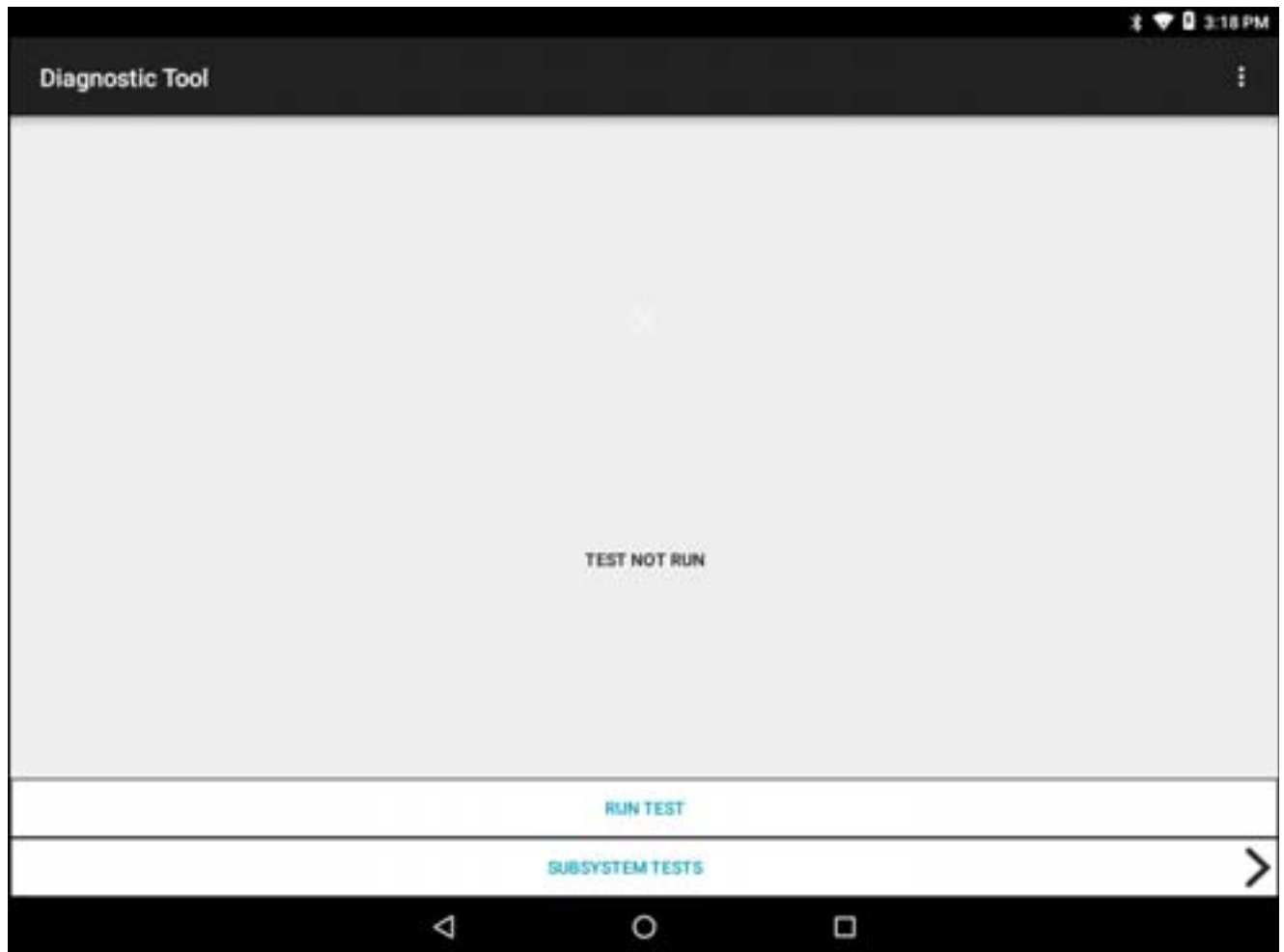
1. Touch the Backup Now icon. The Backup dialog box appears.
2. Touch **Yes** to create the back up.

## Diagnostic Tool

The **Diagnostic Tool** is a utility that determines the health of the VC80x. Use the Diagnostic Tool to troubleshooting the device and determine issues.

1. Swipe up from the bottom of the Home screen and touch .

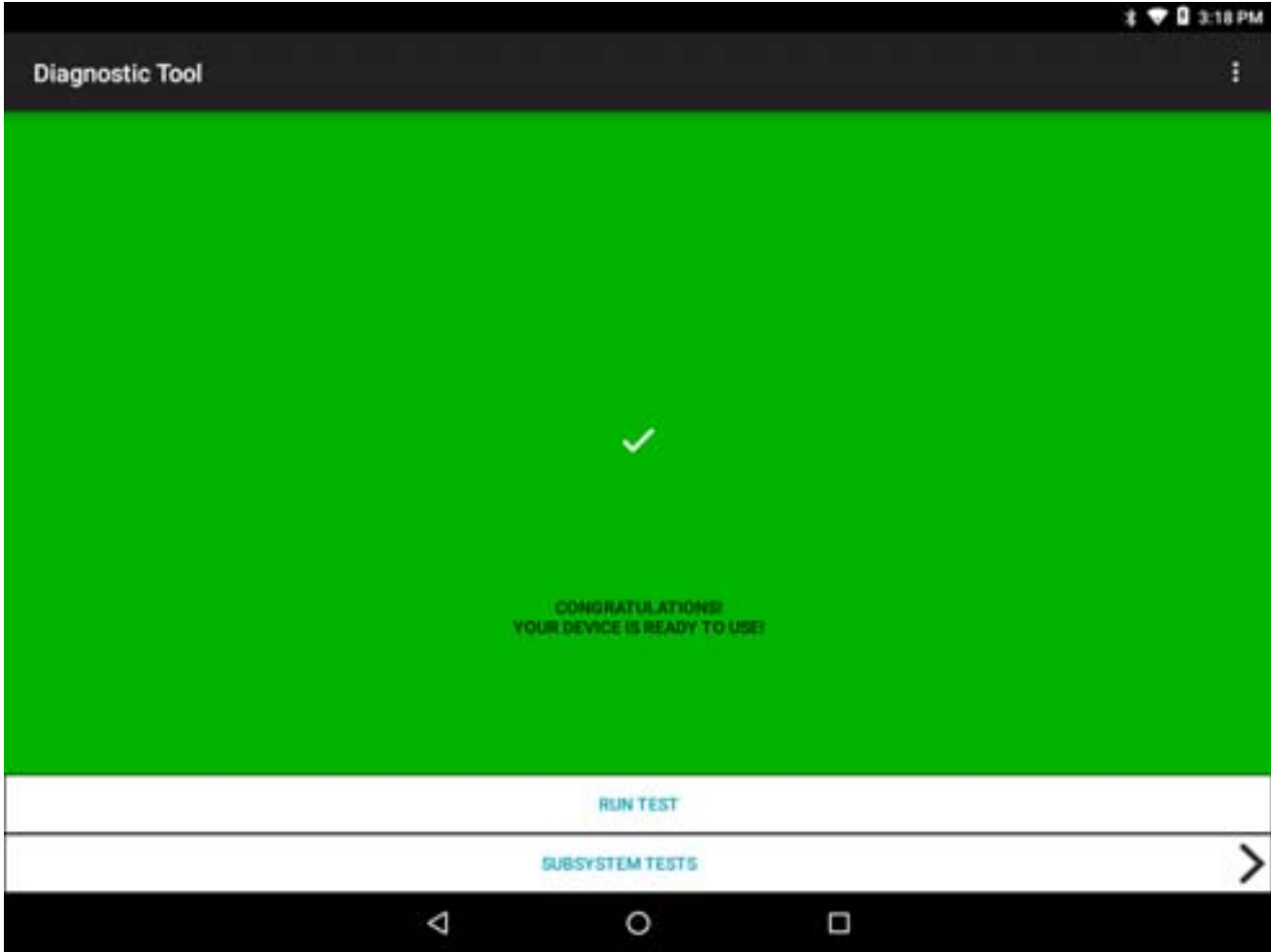
**Figure 54** Diagnostic Tool



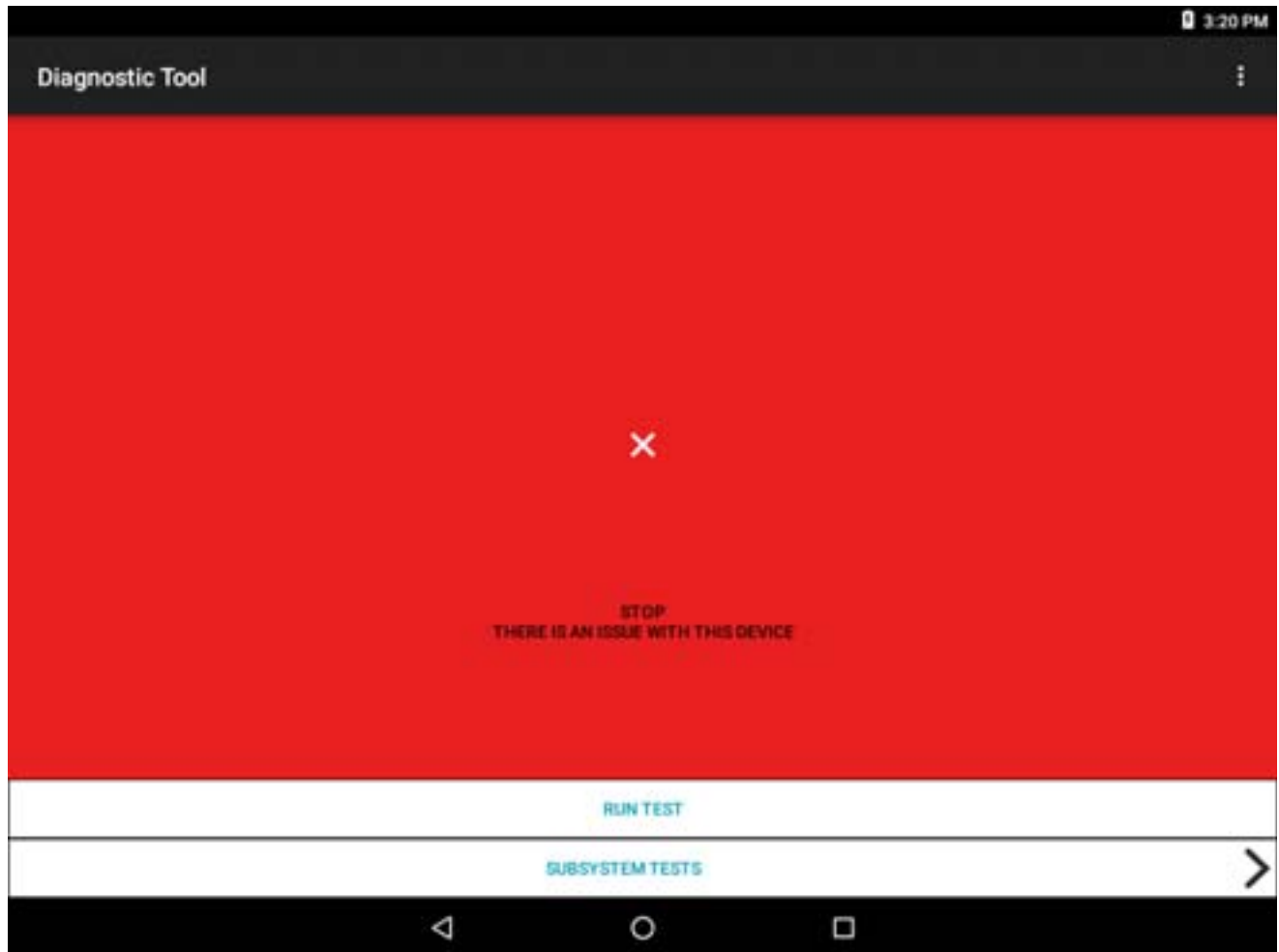
2. Touch **Run Test**. The app tests all enabled subsystems (by default only the Battery and System tests are enabled). See [Settings on page 100](#) to enable subsystem tests.



Figure 55 Test Passed Screen



**Figure 56** Test Failed Screen



3. To view each individual subsystem test, touch **Subsystem Tests**.

Figure 57 Subsystem Screen

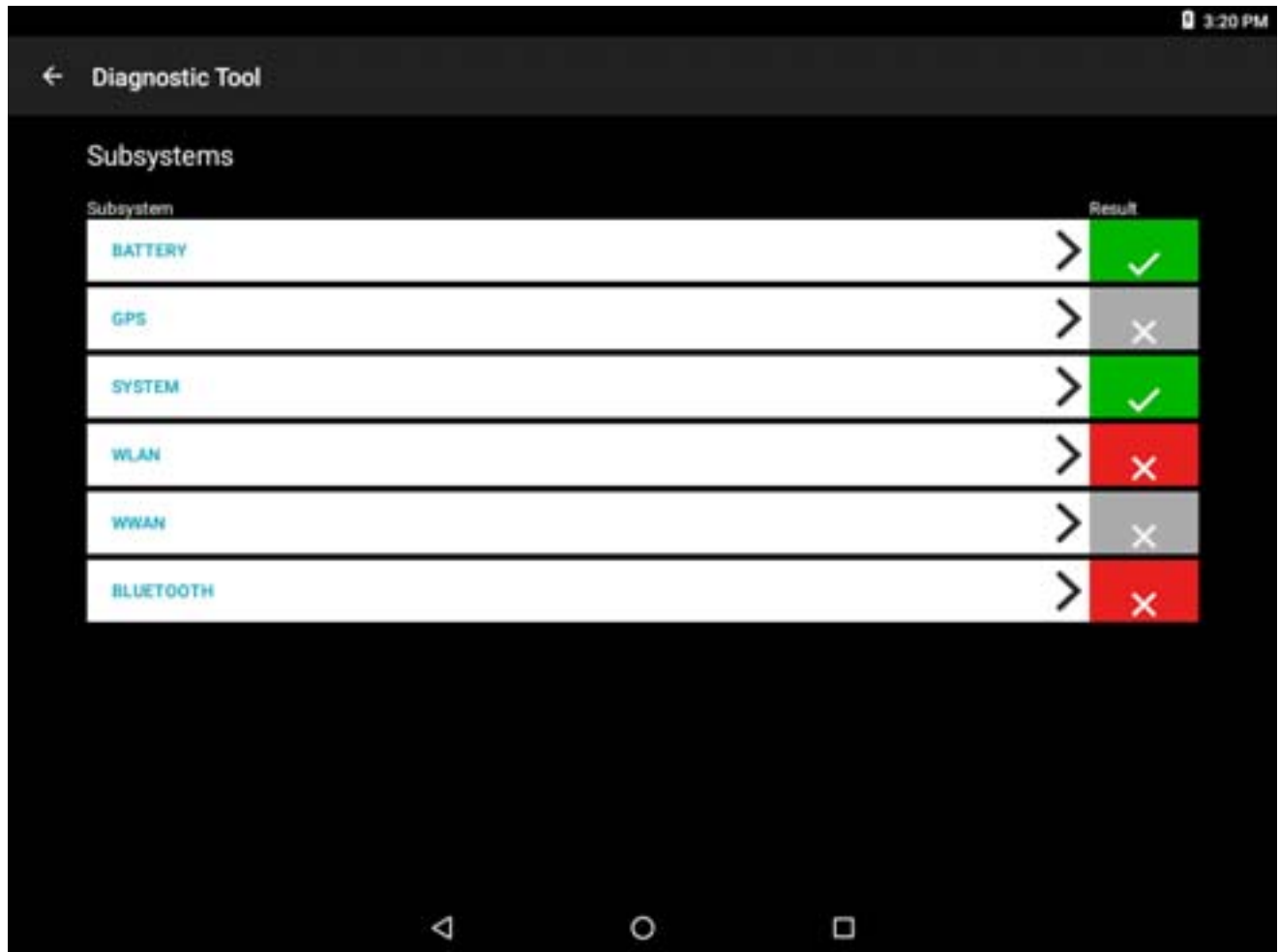



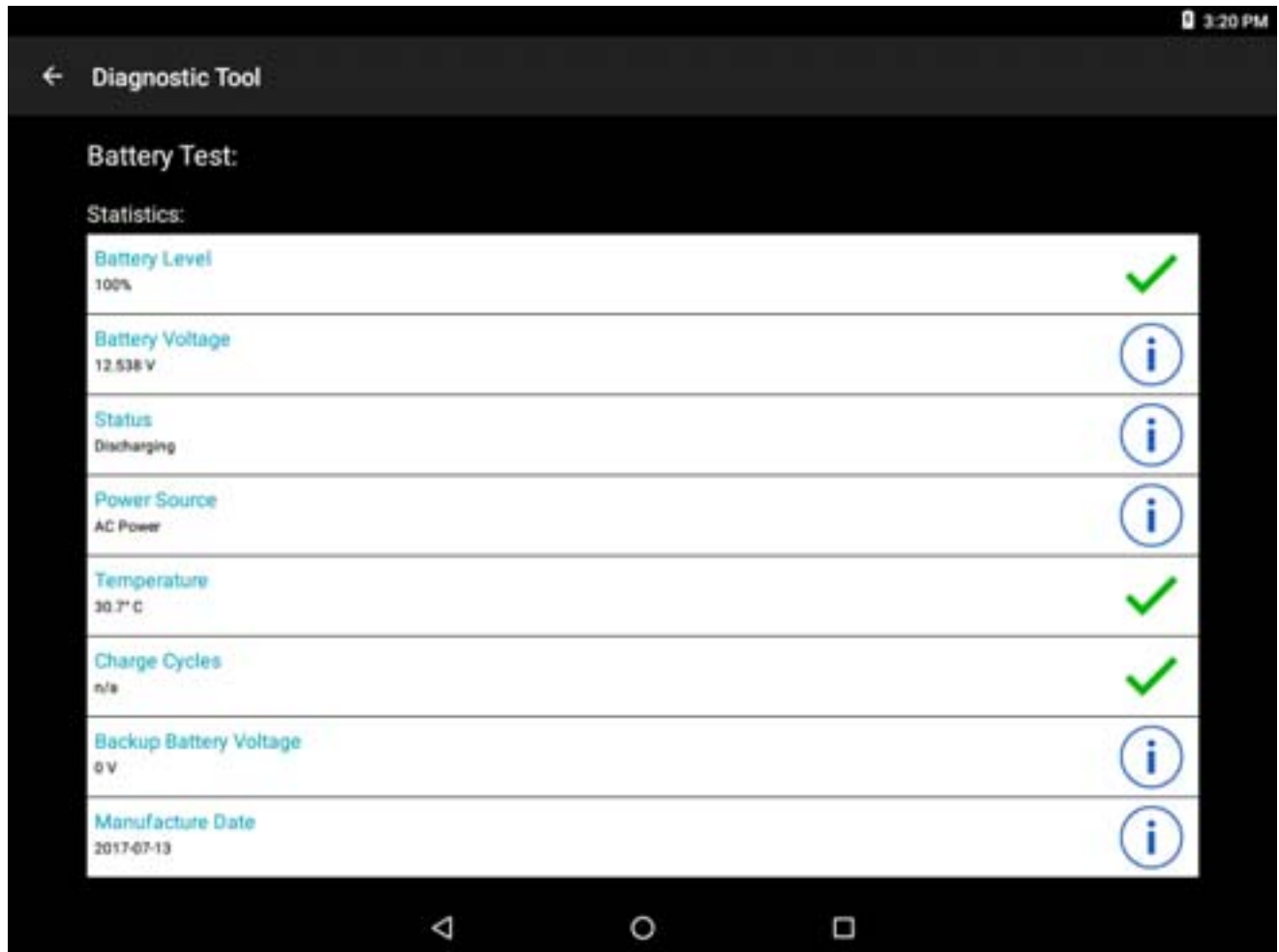


Table 8 Subsystem Test Result Indicators

Status Icon	Description
	Indicates test passed.
	Indicates test failed.
	Indicates test not supported or not enabled.

4. Touch one of the subsystems to view details.

Figure 58 Battery Subsystem Details



## Settings

By default only the Battery and System tests are enabled. To enable other tests:

1. Touch > **Settings**.
2. Touch to the left of the test name. A green box with a checkmark appears.
3. Touch **SAVE**.
4. Touch **Yes** to confirm.
5. Touch .

## Battery Test Information

The Battery Test obtains the following information:

- **Battery Level** - Indicates the current battery charge level.
- **Battery Voltage** - Indicates the current battery voltage.
- **Status** - Indicates if the battery is charging (on AC power) or discharging (on battery power).
- **Power Source** - Indicates whether the device is receiving power from the battery or from an external source.

- **Temperature** - Indicates the current battery temperature.
- **Charge Cycles** - Not applicable.
- **Backup Battery Voltage** - Indicates backup battery voltage.
- **Manufacture Date** - Not applicable (Displays the manufacture date of the battery).

### GPS Test Information

Not supported on the VC80x.

### System Test Information

Use the System Test to determine if the CPU or memory loads are too high, there are too many processes running on the device, or that storage on the device is almost full. The System Test obtains the following information:

- **CPU Load** - Indicates the amount of CPU being used.
- **Free Physical Memory** - Indicates the amount of RAM available.
- **Free Storage** - Indicates the amount of internal Flash memory available.
- **Process Count** - Indicates the number of processes currently running.

### WLAN Test Information

If the WiFi radio is not present or disabled the test may be skipped. Use this information to determine if the device's WLAN configuration is correct or whether there is any connection with an access point or network. The WLAN Test obtains the following information:

- **WLAN Enabled** - Indicates if the WLAN radio is enabled or disabled.
- **WLAN Status** - Indicates the current status of association with the access point.
- **ESSID** - Displays the name of the wireless network.
- **BSSID** - Displays the MAC address of the connected access point.
- **MAC Address** - Displays the device's MAC address.
- **Signal** - Indicates the strength of the Wi-Fi signal (in dBm).
- **IP Address** - Displays the IP address of the device.

### WWAN Test Information

Not supported on the VC80x.


### Bluetooth Test Information

The Bluetooth Test obtains the following information:

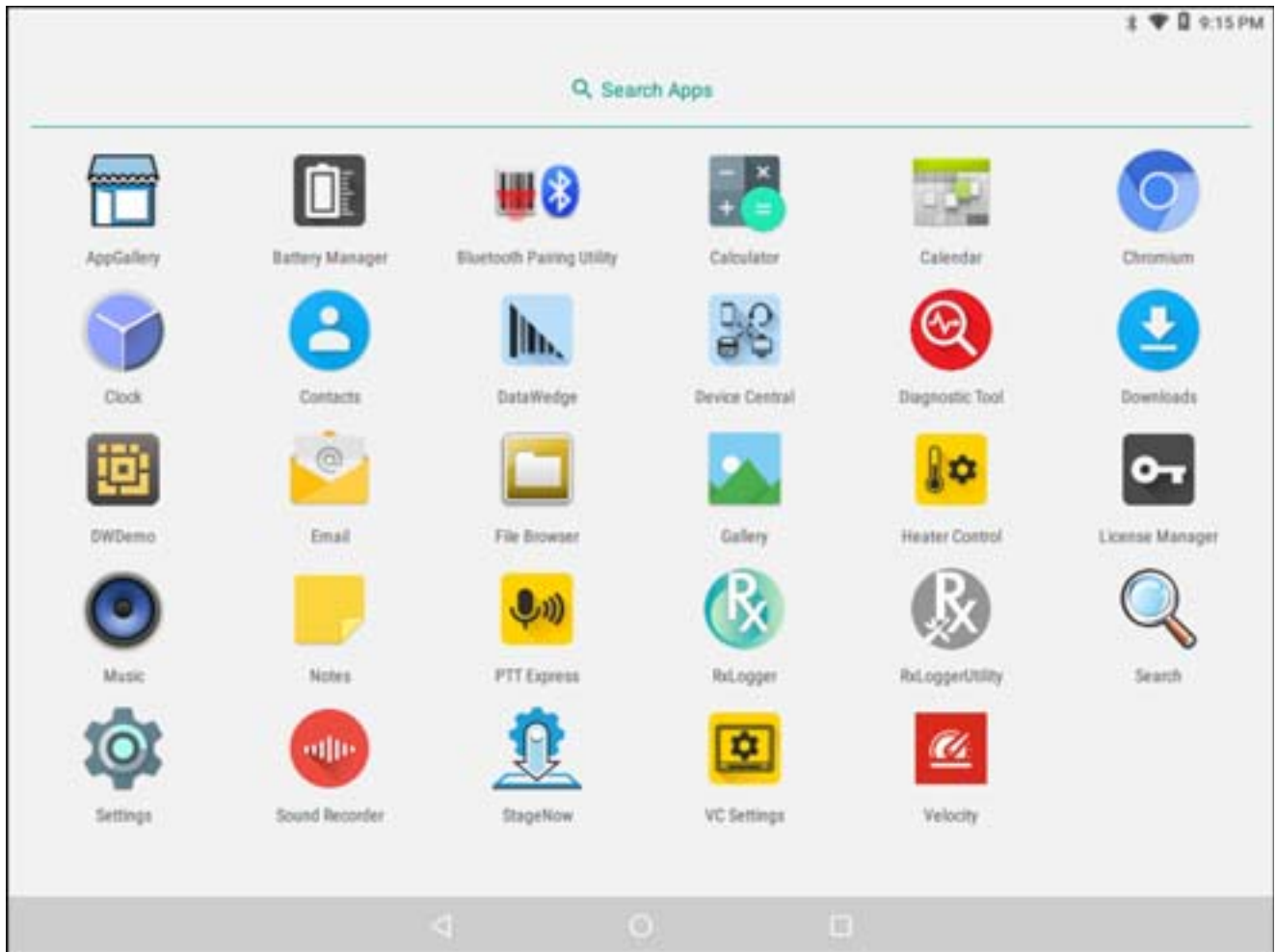
- **Enabled** - Indicates if the Bluetooth radio is enabled or disabled.
- **Status** - Indicates if the device is paired to another Bluetooth device.
- **Connectable/Discoverable** - Indicates if the device is discoverable or connectable.
- **Address** - Displays the Bluetooth radio MAC address.
- **Name** - Displays the Bluetooth name for the device.

## Velocity

Velocity transforms the traditional green screen telnet application into a modern smart device application. It accomplishes all of this without modifying the host application, offering workers a familiar experience optimized for today's touch screen mobile computers.

To open Velocity, swipe up from the Home screen and touch 

**Figure 59** Velocity Icon



- Access the context menu for quick access to function or control keys.
- Access the Velocity menu for starting new sessions or switching between green and reformatted screens.

Refer to the Velocity user guide for more information. Goto <http://download.wavelink.com/Files/Velocity-qsg-28042016.pdf>

## Scanner Setup in Velocity

Use the Velocity console to configure any of the supported SSI scanners. If you are using an RS-232 scanner, do not configure it in the Velocity console. Instead, configure the RS-232 scanner in Datawedge settings.

# Data Capture

The VC80x supports scanners that use the Human Interface Device (HID) and Simple Serial Interface (SSI) protocols. In HID mode, the scanner sends data to the VC80x like entering characters on a keyboard. In SSI mode, the scanner sends data to the VC80x in packets which can be ASCII data or as part of a larger message.

The VC80x supports data capture using:

- Tethered scanner connected to COM1 or COM2 port:
  - DS3508-ER, HD, SR
  - DS3608-SR, ER, HP, HD
  - LI3608-SR
  - LS3408-ER, FZ
  - Other tethered serial scanners.
- Tethered scanner connected to a USB host port:
  - DS3508-ER, HD, SR (HID mode only)
  - DS3608-SR, ER, HP, HD (HID and SSI modes)
  - LI3608-SR (HID mode only)
  - LS3408-ER, FZ (HID mode only)
  - Other USB scanners (HID mode only).
- Wireless scanner connected via Bluetooth:
  - DS3678-SR, ER, HP, HD (HID and SSI modes)
  - LI3678-SR (HID mode only)
  - LS3578-ER, SR, HD, FZ (HID mode only)
  - DS3578-SR, ER, HD (HID mode only)
  - RS507/RS507x (HID and SSI modes)
  - RS6000 (HID and SSI modes)
  - Other Bluetooth scanners (HID mode only).

---

## Imaging

The scanner with 2D imager has the following features:

- Omnidirectional reading of a variety of barcode symbologies, including the most popular linear, postal, PDF417, and 2D matrix code types.

- The ability to capture and download images to a host for a variety of imaging applications.
- Advanced intuitive laser aiming cross-hair and dot aiming for easy point-and-shoot operation.

The imager uses imaging technology to take a picture of a barcode, stores the resulting image in its memory, and executes state-of-the-art software decoding algorithms to extract the barcode data from the image.

## Operational Modes

The imager supports two modes of operation, listed below. Activate each mode by pressing the Scan button.

- **Decode Mode:** In this mode, the scanner attempts to locate and decode enabled barcodes within its field of view. The imager remains in this mode as long as the user holds the scan button, or until it decodes a barcode.



**NOTE** To enable Pick List Mode, configure in DataWedge or set in an application using a API command.

Picklist mode is dependent upon the scanner. Refer to the scanner user guide for more information.

- **Pick List Mode:** This mode allows the user to selectively decode a barcode when more than one barcode is in the scanner's field of view. To accomplish this, move the aiming crosshair or dot over the required barcode to decode only this barcode. This feature is ideal for pick lists containing multiple barcodes and manufacturing or transport labels containing more than one barcode type (either 1D or 2D).

---

## Laser Scanning

Scanner with lasers has the following features:

- Reading of a variety of bar code symbologies, including the most popular linear, postal, and 1-D code types.
- Intuitive aiming for easy point-and-shoot operation.

---

## Scanning Considerations

Typically, scanning is a simple matter of aim, scan, and decode and a few quick trial efforts master it. However, consider the following to optimize scanning performance:

- **Range:** Any scanning device decodes well over a particular working range — minimum and maximum distances from the barcode. This range varies according to barcode density and scanning device optics. Scanning within range brings quick and constant decodes; scanning too close or too far away prevents decodes. Move the scanner closer and further away to find the right working range for the barcodes being scanned.
- **Angle:** Scanning angle is important for promoting quick decodes. When laser beams reflect directly back into the scanner from the barcode, this specular reflection can “blind” the scanner. To avoid this, scan the barcode so that the beam does not bounce directly back. But don't scan at too sharp an angle; the scanner needs to collect scattered reflections from the scan to make a successful decode. Practice quickly shows what tolerances to work within.
- Hold the scanner farther away for larger symbols
- Move the scanner closer for symbols with bars that are close together.





**NOTE** Scanning procedures depend on the application and VC80x configuration. An application may use different scanning procedures from the one listed above.

---

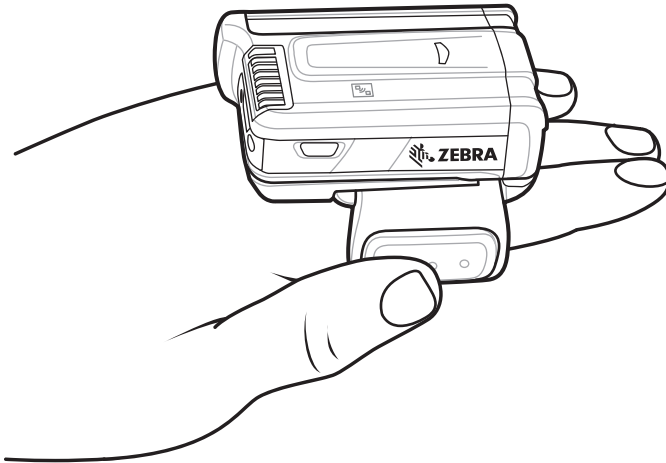
## Barcode Capture with RS6000 Bluetooth Ring Scanner

To read a barcode, a scan-enabled application is required. The VC80x contains the **DataWedge** application that allows the user to enable the scanner to decode barcode data and display the barcode content. See [DataWedge Demonstration on page 76](#) for more information on launching DataWedge.

Pair the RS6000 with the VC80x. See [Pairing Using Simple Serial Interface on page 111](#) or [Pairing Using Human Interface Device on page 112](#) for more information.

1. Ensure that an application is open on the device and a text field is in focus (text cursor in text field).
2. Point the RS6000 at a barcode.

**Figure 60** Barcode Scanning with RS6000

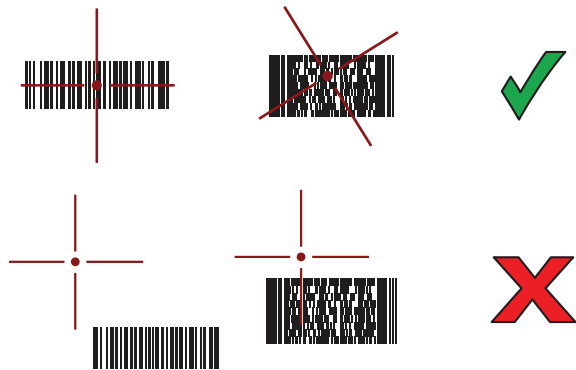


3. Press and hold the trigger.

The red laser aiming pattern turns on to assist in aiming. Ensure the barcode is within the area formed by the cross-hairs in the aiming pattern. The aiming dot is used for increased visibility in bright lighting conditions.

The RS6000 LEDs light green, a beep sounds to indicate the barcode was decoded successfully. Note that when the RS6000 is in Pick List Mode, the RS6000 does not decode the barcode until the center of the crosshair touches the barcode.

**Figure 61** Aiming Pattern



**Figure 62** Pick List Mode with Multiple barcodes in Aiming Pattern



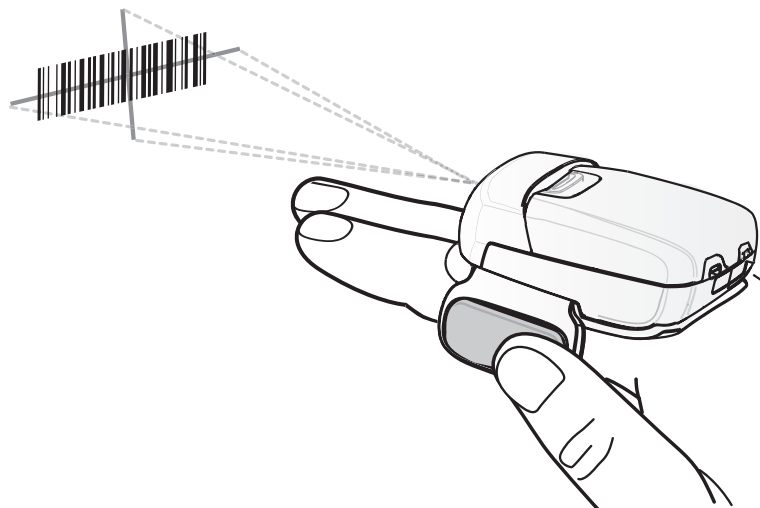
4. The captured data appears in the text field.

## Barcode Capture with RS507/RS507x Hands-Free Imager

Pair the RS507/RS507x with the VC80x. See [Pairing the RS507/RS507x/RS6000 Hands-Free Imager on page 111](#) for more information.

1. Ensure that an application is open on the device and a text field is in focus (text cursor in text field).
2. Point the RS507/RS507x at a barcode.

**Figure 63** barcode Scanning with RS507/RS507x

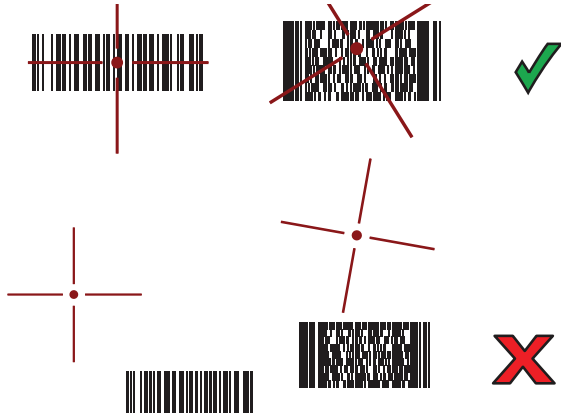


3. Press and hold the trigger.

The red laser aiming pattern turns on to assist in aiming. Ensure the barcode is within the area formed by the cross-hairs in the aiming pattern. The aiming dot is used for increased visibility in bright lighting conditions.

The RS507/RS507x LEDs light green, a beep sounds to indicate the barcode was decoded successfully. Note that when the RS507/RS507x is in Pick List Mode, the RS507/RS507x does not decode the barcode until the center of the crosshair touches the barcode.

**Figure 64** Aiming Pattern



**Figure 65** Pick List Mode with Multiple barcodes in Aiming Pattern



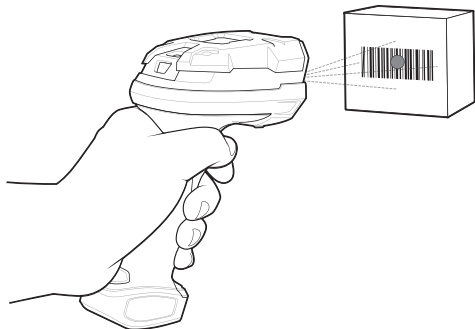
4. The captured data appears in the text field.

## Bar Code Capture with Zebra Scanner

To capture barcodes data:

1. Ensure that an application is open on the device and a text field is in focus (text cursor in text field).
2. Point the scanner at a bar code.

**Figure 66** Bar Code Scanning (DS3678-SR shown)



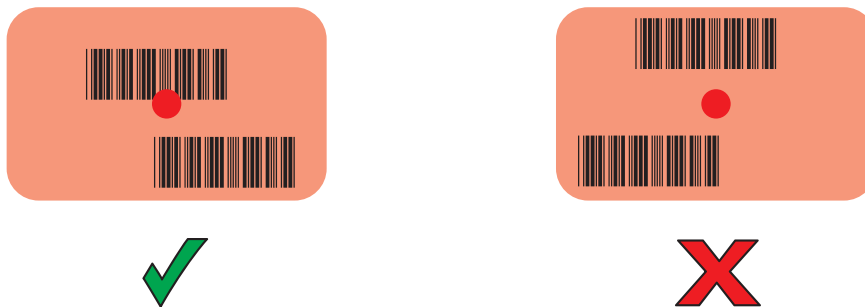
3. Press and hold the trigger.

Ensure the bar code is within the area formed by the aiming pattern. The aiming dot is used for increased visibility in bright lighting conditions. The aiming dot is used for increased visibility in bright lighting conditions.

**Figure 67** DS3678-SR Aiming Pattern



**Figure 68** DS3678-SR Pick List Mode with Multiple Bar Codes in Aiming Pattern



4. The captured data appears in the text field.

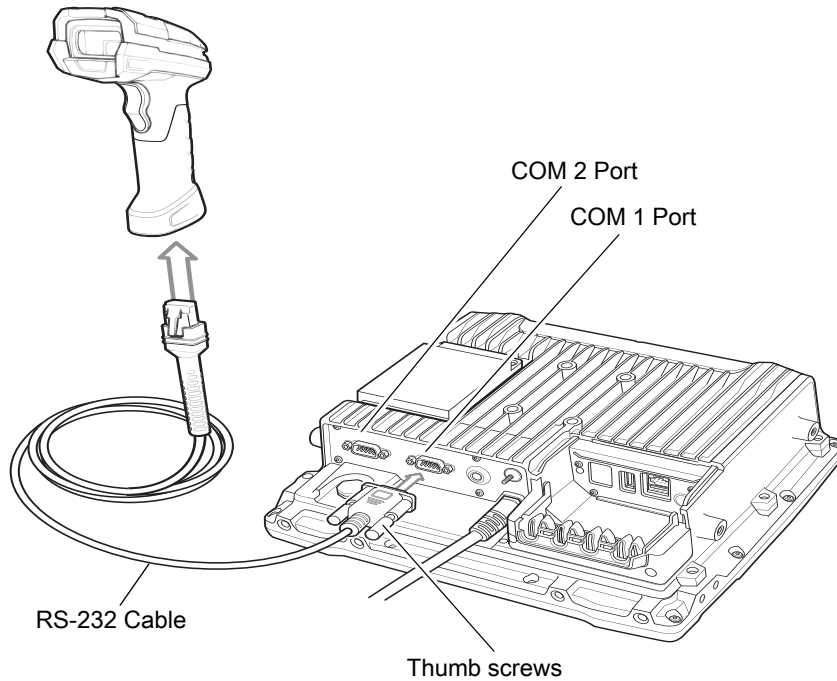
---




## Connecting an RS-232 Scanner

To connect an RS-232 scanner:

1. On the bottom of the VC80x, remove the connector cover from either the COM1 or COM2 port.
2. Connect the scanner cable RS-232 connector to either the COM1 or COM2 port and to the scanner.



Figure 69 Connect RS-232 Scanner



3. Tighten the RS-232 connect thumb screws.
4. On the VC80x home screen, swipe up from the bottom of the Home screen and touch .
5. Touch **+5V output on Serial Port 1** if the RS-232 scanner is connected to the COM1 port or **+5V output on Serial Port 2** if the scanner is connected to the COM 2 port. The scanner beeps.
6. Touch .
7. Swipe up from the bottom of the Home screen and touch .
8. Select a profile.
9. Scroll down to **Serial port input from Serial port 1** or **Serial port input from Serial port 2**.
10. Touch **Enabled**. A check appears in the checkbox to the right.



**IMPORTANT** By default, serial settings are set for all Zebra scanners. Other non-Zebra scanner may need configuration. Refer to the scanner user guide for more information.

11. Touch **Serial port configuration**.
12. Touch **Baud rate**.
13. Select one of the available baud rates.
14. Touch **Data bits**.
15. Select 7 or 8.
16. Touch **Parity**.
17. Select a parity value.
18. Touch **Stop bits**.
19. Select 1 or 2.
20. Touch .
21. Touch .

## Connecting a USB Scanner

To connect a USB scanner, use one of the following methods:

- Simple Serial Interface (SSI) mode
- Human Interface Device (HID) mode.

### Connecting Using Simple Serial Interface

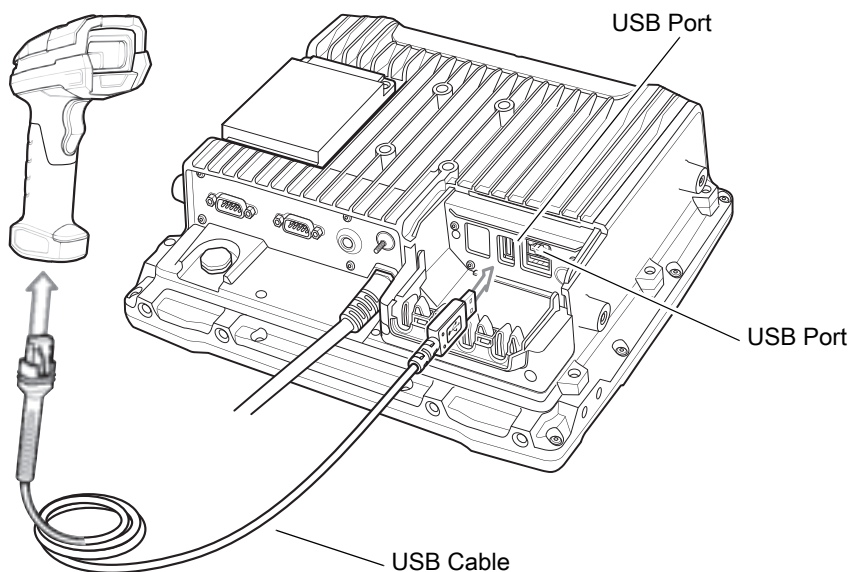



**IMPORTANT** Make sure that DS3608 scanner has firmware version CAACJS00-004-R00D0.DAT or higher.

To connect a USB scanner using SSI mode:

1. On the back of the VC80x, remove the dust cover.
2. Connect the scanner cable USB connector to either USB port. The scanner beeps.

**Figure 70** Connect USB Scanner

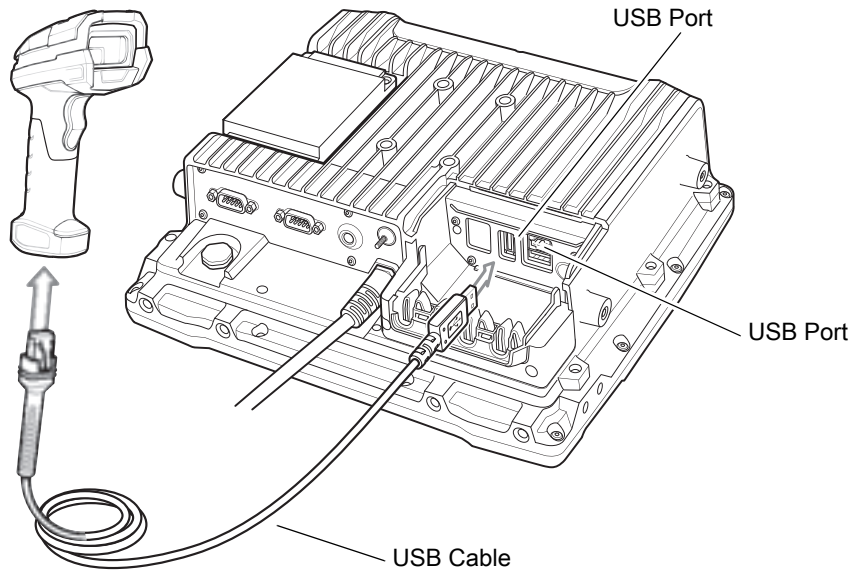


3. Place cable into strain relief.
4. Replace the dust cover.
5. Ensure that the scanner is in SSI mode. Refer to the scanner Product Reference Guide and scan the SSI Over USB CDC barcode.
6. On the VC80x home screen, swipe up from the bottom of the Home screen and touch .
7. Select a profile.
8. Configure additional settings.

### Connecting Using HID Mode

To connect a USB scanner using HID mode:

1. On the back of the VC80x, remove the dust cover.
2. Connect the scanner cable USB connector to either USB port. The scanner beeps.

**Figure 71** Connect USB Scanner

3. Place the cable into the strain relief.
4. Replace the dust cover.
5. Ensure that the scanner is in HID mode. Refer to the Product Reference Guide and scan the HID Keyboard barcode or perform a factory reset.



## Pairing the RS507/RS507x/RS6000 Hands-Free Imager

To connect an RS507/RS507x/RS6000 Hands-Free Imager to the VC80x, use one of the following methods:


- Simple Serial Interface (SSI) mode
- Bluetooth Human Interface Device (HID) mode.

### Pairing Using Simple Serial Interface

To pair the RS507/RS507x/RS6000 with the VC80x using SSI:

1. Ensure that the scanner is in SSI mode. If the RS507/RS507x/RS6000 is already in SSI mode, skip to step 2.
  - a. Remove the battery from the RS507/RS507x/RS6000.
  - b. Press and hold the Restore key.
  - c. Install the battery onto the RS507/RS507x/RS6000.
  - d. Keep holding the Restore key for about five seconds until a chirp is heard and the Scan LEDs flash green.
2. Ensure that the two devices are within 10 meters (32.8 feet) of one another.
3. On the VC80x, swipe up from the bottom of the Home screen and touch  .

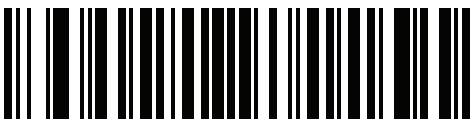
**Figure 72** Bluetooth Pairing Utility

4. Using the RS507/RS507x/RS6000, scan the barcode on the screen or scan the barcode on the right side of the VC80x.  
The RS507/RS507x/RS6000 emits a high/low/high/low beeps. The Scan LED flashes green indicating that the scanner is attempting to establish connection with the VC80x. When connection is established, the Scan LED turns off and the scanner emits one string of low/high beeps.
5. On the VC80x, touch .

## Pairing Using Human Interface Device



To pair the RS507/RS507x/RS6000 with the VC80x using HID:

1. Place the RS507/RS507x/RS6000 in Human Interface Device (HID) mode. If the scanner is already in HID mode, skip to step 2.
  - a. Remove the battery from the RS507/RS507x/RS6000.
  - b. Press and hold the Restore key.
  - c. Install the battery onto the RS507/RS507x/RS6000.
  - d. Keep holding the Restore key for about five seconds until a chirp is heard and the Scan LEDs flash green.
  - e. Scan the barcode below to place the RS507/RS507x/RS6000 in HID mode.

**Figure 73** RS507/RS507x Bluetooth HID Barcode**Figure 74** RS6000 Bluetooth HID Barcode

2. Remove the battery from the RS507/RS507x/RS6000.
3. Re-install the battery into the RS507/RS507x/RS6000.
4. Ensure that the two devices are within 10 meters (32.8 feet) of one another.



5. Swipe down from the status bar and then touch .
6. Touch  **Bluetooth**.
7. The device begins searching for discoverable Bluetooth devices in the area and displays them under **AVAILABLE DEVICES**.
8. Scroll through the list and select RS507/RS507x or RS6000.  
The RS507/RS507x/RS6000 connects to the scanner and **Connected** appears below the device name. The Bluetooth device is added to the **Paired devices** list and a trusted (“paired”) connection is established.

## Pairing a DS3678 Scanner

To connect an DS3678 scanner to the VC80x, use one of the following methods:


- Simple Serial Interface (SSI) mode
- Bluetooth Human Interface Device (HID) mode.

### Pairing Using Simple Serial Interface




**IMPORTANT** Make sure that DS3678 scanner has firmware version CAACKS00-003-R00D0.DAT or higher.

To pair the DS3678 scanner with the VC80x using SSI:

1. Ensure that the scanner is in SSI mode.
2. Ensure that the two devices are within 10 meters (32.8 feet) of one another.
3. On the VC80x, swipe up from the bottom of the Home screen and touch .

**Figure 75** Bluetooth Pairing Utility





4. Using the scanner, scan the barcode on the screen or scan the barcode on the right side of the VC80x.  
The scanner emits a high/low/high/low beeps. The Scan LED flashes green indicating that the scanner is attempting to establish connection with the VC80x. When connection is established, the Scan LED turns off and the scanner emits one string of low/high beeps.
5. On the VC80x, touch .

## Pairing a DS3678 Scanner Using Human Interface Device



**NOTE** The VC80x supports Zebra DS3678, LI3678, LS3578, and DS3578 scanners in HID mode.

To pair the scanner with the VC80x using HID:

1. Ensure that the scanner is in HID mode. Refer to the DS36X8 Product Reference Guide and scan the HID Keyboard barcode.
2. Ensure that the two devices are within 10 meters (32.8 feet) of one another.
3. Swipe down from the status bar and then touch .
4. Touch  **Bluetooth**.
5. The device begins searching for discoverable Bluetooth devices in the area and displays them under **AVAILABLE DEVICES**.
6. Scroll through the list and select the scanner.

The device connects to the scanner and **Connected** appears below the device name. The Bluetooth device is added to the **Paired devices** list and a trusted (“paired”) connection is established.




---

## DataWedge




DataWedge is a utility that adds advanced barcode scanning capability to any application without writing code. It runs in the background and handles the interface to built-in barcode scanners. The captured barcode data is converted to keystrokes and sent to the target application as if it was typed on the keypad.

To configure DataWedge see [DataWedge Configuration](#).

### Enabling DataWedge

1. Swipe up from the bottom of the Home screen and touch .
2. Touch  > **Settings**.
3. Touch the **DataWedge enabled** checkbox. A blue checkmark appears in the checkbox indicating that DataWedge is enabled.
4. Touch .

### Disabling DataWedge

1. Swipe up from the bottom of the Home screen and touch .
2. Touch  > **Settings**.
3. Touch the **DataWedge enabled** checkbox. The blue checkmark disappears from the checkbox indicating that DataWedge is disabled.
4. Touch .

# Wireless

This section provides information on the wireless features:

- Wireless Local Area Network (WLAN)
- Bluetooth.

---

## Wireless Local Area Networks



**NOTE** If using an external antenna, ensure correct settings.

Wireless local area networks (WLANs) allow the VC80x to communicate wirelessly inside a building. Before using the VC80x on a WLAN, the facility must be set up with the required hardware to run the WLAN (sometimes known as infrastructure). The infrastructure and the VC80x must both be properly configured to enable this communication.

Refer to the documentation provided with the infrastructure (access points (APs), access ports, switches, Radius servers, etc.) for instructions on how to set up the infrastructure.

Once the infrastructure is set up to enforce the chosen WLAN security scheme, use the **Wireless & networks** settings configure the VC80x to match the security scheme.

The VC80x supports the following WLAN security options:

- Open
- Wireless Equivalent Privacy (WEP).
- Wi-Fi Protected Access (WPA)/WPA2 Personal (PSK).
- Extensible Authentication Protocol (EAP).

The **Status** bar displays icons that indicate Wi-Fi network availability and Wi-Fi status. See Status Bar for more information.

## Scan and Connect to a Wi-Fi Network

1. Swipe down with two fingers from the status bar to open the quick access panel.

**Figure 76** Quick Access Panel

2. Touch **WLAN** to open the **WLAN** screen. The VC80x searches for WLANs in the area and lists them.

**Figure 77** WLAN Screen




3. Scroll through the list and select the desired WLAN network.
4. For open networks, touch profile once or press and hold and then select **Connect to network** or for secure networks enter the required password or other credentials then touch **Connect**. See the system administrator for more information.

The VC80x obtains a network address and other required information from the network using the dynamic host configuration protocol (DHCP) protocol. To configure the VC80x with a fixed internet protocol (IP) address, see [Configuring the Device to Use a Static IP Address on page 120](#).

5. In the Wi-Fi setting field, **Connected** appears indicating that the VC80x is connected to the WLAN.



## Remove a Wi-Fi Network

To remove a remembered or connected network:

1. Swipe down from the status bar and then touch .
2. Touch  **Wi-Fi**.
3. In the **Wi-Fi** list, touch and hold the name of the network.
4. In the menu, touch **Forget network**.
5. Touch .

## Configuring a Wi-Fi Network

To set up a Wi-Fi network:

1. Swipe down from the status bar and then touch .
2. Touch  **Wi-Fi**.
3. Slide the switch to the **ON** position.
4. The device searches for WLANs in the area and lists them on the screen.
5. Scroll through the list and select the desired WLAN network.
6. Touch the desired network. If the network security is **Open**, the device automatically connects to the network. For all other network security a dialog box appears.

**Figure 78** WLAN WEP Network Security Dialog Box



**Figure 79** WLAN 802.11 EAP Network Security Dialog Box

7. If the network security is **WEP** or **WPA/WPS2 PSK**, enter the required password and then touch **Connect**.
8. If the network security is 802.1x EAP:
  - Touch the **EAP method** drop-down list and select **PEAP**, **TLS**, **TTLS** or **LEAP**.
  - Touch the **Phase 2 authentication** drop-down list and select an authentication method.
  - If required, touch **CA certificate** and select a Certification Authority (CA) certificate. Note: Certificates are installed using the **Security** settings.
  - If required, touch **User certificate** and select a user certificate. Note: User certificates are installed using the Location & security settings.
  - If required, in the **Identity** text box, enter the username credentials.
  - If desired, in the **Anonymous identity** text box, enter an anonymous identity username.
  - If required, in the **Password** text box, enter the password for then given identity.






**NOTE** By default, the network Proxy is set to **None** and the IP settings is set to **DHCP**. See [Configuring for a Proxy Server on page 119](#) for setting connection to a proxy server and see [Configuring the Device to Use a Static IP Address on page 120](#) for setting the device to use a static IP address.

9. Touch **Connect**.
10. Touch

## Manually Adding a Wi-Fi Network

Manually add a Wi-Fi network if the network does not broadcast its name (SSID) or to add a Wi-Fi network when out of range.

1. Swipe down from the status bar and then touch

2. Touch  **Wi-Fi**.
  3. Slide the Wi-Fi switch to the **On** position.
  4. Scroll down to the bottom of the window and touch **Add network**.
  5. In the **Enter the SSID** text box, enter the name of the Wi-Fi network.
  6. In the **Security** drop-down list, select the type of security. Options:
    - **None**
    - **WEP**
    - **WPA/WPA2 PSK**
    - **802.1x EAP**.
  7. If the network security is **None**, touch **Save**.
  8. If the network security is **WEP** or **WPA/WPA2 PSK**, enter the required password and then touch **Save**.
  9. If the network security is **802.1x EAP**:
    - Touch the **EAP method** drop-down list and select **PEAP**, **TLS**, or **TTLS**.
    - Touch the **Phase 2 authentication** drop-down list and select an authentication method.
    - If required, touch **CA certificate** and select a Certification Authority (CA) certificate. Note: Certificates are installed using the **Security** settings.
    - If required, touch **User certificate** and select a user certificate. Note: User certificates are installed using the **Security** settings.
    - If required, in the **Identity** text box, enter the username credentials.
    - If desired, in the **Anonymous** identity text box, enter an anonymous identity username.
    - If required, in the **Password** text box, enter the password for then given identity.
-  **NOTE** By default, the network Proxy is set to **None** and the IP settings is set to **DHCP**. See [Configuring for a Proxy Server on page 119](#) for setting connection to a proxy server and see [Configuring the Device to Use a Static IP Address on page 120](#) for setting the device to use a static IP address.
10. Touch **Save**. To connect to the saved network, touch and hold on the saved network and select **Connect to network**.
  11. Touch .

## Configuring for a Proxy Server

A proxy server is a server that acts as an intermediary for requests from clients seeking resources from other servers. A client connects to the proxy server, requesting some service, such as a file, connection, web page, or other resource, available from a different server. The proxy server evaluates the request according to its filtering rules. For example, it may filter traffic by IP address or protocol. If the request is validated by the filter, the proxy provides the resource by connecting to the relevant server and requesting the service on behalf of the client.

It is important for enterprise customers to be able to set up secure computing environments within their companies, and proxy configuration is an essential part of doing that. Proxy configuration acts as a security barrier ensuring that the proxy server monitors all traffic between the Internet and the intranet. This is normally an integral part of security enforcement in corporate firewalls within intranets.

1. In the network dialog box, touch a network.
2. Touch **Advanced options**.
3. Touch **Proxy** and select **Manual**.

Figure 80 Proxy Settings

**WLAN**

Proxy  
Manual

The HTTP proxy is used by the browser but may not be used by the other apps.

Proxy hostname  
proxy.example.com

Proxy port  
8080

Bypass proxy for  
example.com,mycomp.test.com,

IP settings  
Static

IP address  
192.168.1.128

CANCEL CONNECT

4. In the **Proxy hostname** text box, enter the address of the proxy server.
5. In the **Proxy port** text box, enter the port number for the proxy server.  
When entering proxy addresses the Bypass proxy for field, do not use spaces or carriage returns between addresses.
6. In the **Bypass proxy for** text box, enter addresses for web sites that do not require to go through the proxy server. Use a comma “,” between addresses.
7. Touch **Connect**.
8. Touch .

## Configuring the Device to Use a Static IP Address


By default, the device is configured to use Dynamic Host Configuration Protocol (DHCP) to assign an Internet protocol (IP) address when connecting to a wireless network. To configure the device to connect to a network using a static IP address:

1. In the network dialog box, touch a network.
2. Touch **Advanced options**.
3. Touch **IP settings** and select **Static**.






**Figure 81** Static IP Settings

**WLAN**  
 IP settings  
 Static  
 IP address  
 192.168.1.128  
 Gateway  
 192.168.1.1  
 Network prefix length  
 24  
 DNS 1  
 8.8.8.8  
 DNS 2  
 8.8.4.4  
 CANCEL CONNECT

4. In the **IP address** text box, enter an IP address for the device.
5. If required, in the **Gateway** text box, enter a gateway address for the device.
6. If required, in the **Network prefix length** text box, enter a the prefix length.
7. If required, in the **DNS 1** text box, enter a Domain Name System (DNS) address.
8. If required, in the **DNS 2** text box, enter a DNS address.
9. Touch **Save**.
10. Touch .

## Wi-Fi Settings

Use Wi-Fi Settings to configure specific Wi-Fi settings.




1. Swipe down from the status bar and then touch .
2. Touch  **Wi-Fi** > .
  - **Saved networks** - Lists networks that are saved. When the VC80x is near and Wi-Fi is on, it automatically connects.
  - **Network notification** - When enabled, notifies the user when an open network is available.
  - **Keep Wi-Fi on during sleep** - Opens a menu to set whether and when the Wi-Fi radio turns off.
    - **Always** - The radio stays on when the device enters suspend mode.
    - **Only when plugged in** - The radio stays on while the device is connected to external power.
    - **Never** - The radio turns off when the device enters suspend mode (default).
  - **MAC address** - Displays the Media Access Control (MAC) address of the device when connecting to Wi-Fi networks.
  - **IP Address** - Displays the Internet Protocol (IP) address of the device when connecting to Wi-Fi networks.

## Advanced Wi-Fi Settings



**NOTE** Advanced Wi-Fi settings are for the device not for a specific wireless network.

Use the **Advanced** settings to configure additional Wi-Fi settings. To view advanced setting:

1. Swipe down from the status bar and then touch .
2. Touch  **Wi-Fi** >  > **Advanced**.
  - **Install Certificates** – Touch to install certificates.
  - **Wi-Fi Direct** - Displays a list of devices available for a direct Wi-Fi connection.
  - **WPS Push Button** - Touch to connect to a network using Wi-Fi Protected Setup (WPS) push button method.
  - **WPS Pin Entry** - Touch to connect to a network using Wi-Fi Protected Setup (WPS) pin entry method.

Touch **Additional settings**.

- **Regulatory**
  - **Country selection** - Allows user to select the country of operation. If **Auto** is selected, the VC80x will acquire the country information from the Access Points and displays the acquired country name.
  - **Region code** - Displays the current region code.
- **Band and Channel Selection**
  - **Wi-Fi frequency band** - Use to select the frequency band. Options: **Auto** (default), **5 GHz only** or **2.4 GHz only**.
  - **Available channels (2.4 GHz)** - Use to select specific channels. Touch to display the **Available channels** menu. Select specific channels. Touch **OK**.
  - **Available channels (5 GHz)** - Use to select specific channels. Touch to display the **Available channels** menu. Select specific channels. Touch **OK**.
- **Logging**
  - **Advanced Logging** – Provides support for continuous capture of system logs to a file to help in debugging and resolution of Wi-Fi related issues. Disabled by default. In the Advanced Logging dialog box, select Enable logging. If desired, change the log directory location. When enabled, the following logs are captured:



**NOTE** All log files are saved in /storage/sdcard/fusionlogs on the VC80x.

Fusion will ask the user whether to clear out previous logs before starting logging.

tcpdump capture file and fusion-sysinfo.log will only be generated when advanced logging is stopped.

- Android logcat output with time stamps and the kernel messages in the file: fusion-wlan.log.
- tcpdump intermediate capture of packets between network stack and driver in the file: fusi on-pktcap. pcap
- Fusion versions, Wi-Fi state machine logs and other framework information in the file: fusi on-sysinfo. log.
- **Wireless Logs** - Use to capture Wi-Fi log files.
  - **Fusion Logger** - Touch to open the Fusion Logger application. This application maintains a history of high level WLAN events which helps to understand the status of connectivity.

- **Fusion Status** - Touch to display live status of WLAN state. Also provides information of device and connected profile.

**Figure 82** Fusion Logger Screen



Figure 83 Fusion Status Screen



- **About**
  - **Version** - Displays the current Fusion information.

## Wi-Fi Direct

Wi-Fi Direct devices can connect to each other without having to go through an access point. Wi-Fi Direct devices establish their own ad-hoc network when required, letting you see which devices are available and choose which one you want to connect to.



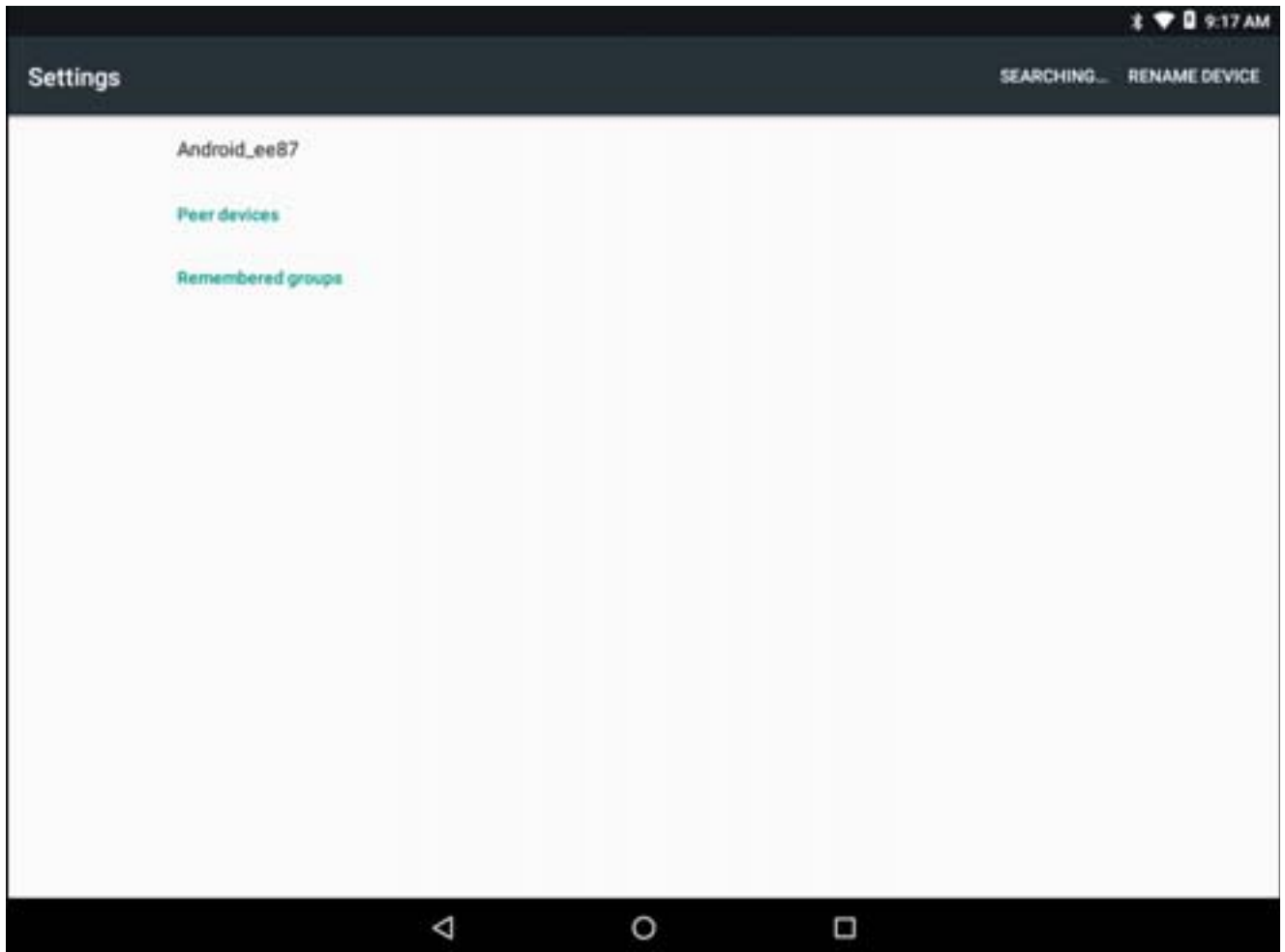
1. Swipe down from the status bar and then touch .
2. Touch **Wi-Fi** >  > **Advanced** > **Wi-Fi Direct**. The VC80x begins searching for another Wi-Fi Direct device.

Figure 84 Wi-Fi Direct Screen





3. Under Peer devices, touch the other device name.
4. On the other device, select **Accept**.
5. Connected appears on the VC80x. On both devices, in their respective Wi-Fi Direct screens, the other device name appears in the list.

## WPS Pin Entry

Wi-Fi Protected Setup (WPS) is a feature allowing devices to easily connect to Wi-Fi access points without typing a long password.

To use a PIN to connect to a wireless router:

1. Log in to the router.
2. Go to the Add WPS Client screen. Refer to the wireless router user documentation specific information.
3. On the VC80x, swipe down from the status bar and then touch .
4. Touch **Wi-Fi** >  > **Advanced** > **WPS Pin Entry**. A dialog box displays with an Pin number.

**Figure 85** Pin Entry Dialog Box

5. On the router, enter the Pin number. The VC80x connects to the wireless router.

## Additional Wi-Fi Advanced Features

Some additional Wi-Fi settings cannot be accessed from the User Interface. They can be configured by using Wi-Fi (CSP). Refer to EMDK documentation for the details on the Wi-Fi settings configuration using the Wi-Fi CSP.

- Auto Time Config - Using this feature, the device can sync up its time with Zebra WLAN infrastructure. This feature works only when the device is connected to Zebra WLAN infrastructure and the feature is enabled on the WLAN infrastructure side. Default: disabled.
- PMKID Caching - Allows the device to skip 802.1x authentication during roaming if it had previously connected to that AP with a full 802.1x authentication. Default: disabled. Note: disable OKC when enabling PMKID Caching.
- Opportunistic Key Caching - Use this feature to skip 802.1x authentication during roaming. The device will go for full 802.1x authentication for the first time it connects to the network. For subsequent roaming, the device skips 802.1x authentication. Default: enabled.
- Cisco Centralized Key Management - Allows the device to skip 802.1x and key-handshake phases during roaming. This feature is available only when the device is connected to a Cisco infrastructure that supports Cisco Centralized Key Management (CCKM). Default: enabled.
- Fast Transition - Fast Transition (FT) is the fast roaming standard, 802.11r. With this feature, the device can skip 802.1x and key-handshake phases during roam. Default: enabled.
- Fast Transition Resource Information Container - Allows the device to request TSPEC as part of reassociation frame exchange. This helps to avoid sending a separate resource request after roaming is completed. Default: disabled.
- Power Save - The device can be configured to work in different power save modes:
  - Active - Keeps the WLAN radio always in active mode (i.e. power save mode disabled).
  - Power save using WMM-PS - This is the default power save mode. Device uses WMM-PS power save method if the AP is configured to use this. If the AP is not supporting WMM-PS, the device will use PS-Poll power save method.
  - Power save using PS-Poll - In this method, the device will use PS-Poll frames to retrieve buffered frames from the AP.
  - Null Data Power Save - In Null Data Power Save (NDP), the device will stay awake for 100 ms after the last frame is sent or received. The device will send a Null Data packet with power management bit cleared to retrieve buffered frames from the AP.
- 802.11k - Using 802.11k, the device can discover neighbor APs and adds support for different types of radio resource measurements. Default: enabled.
- Band Preference - The device can be configured to prefer one band over another. By default, device prefers 5 GHz frequency band over 2.4 GHz.
- Subnet Roaming - When the device roams between different sub networks, if it detects that it is roaming to a different subnet, the device will request a fresh IP address. Default: disabled.

## Zebra Mobility Extensions

Zebra Mobility Extensions make use 802.11 specifications and Zebra proprietary extensions to achieve the highest level of performance, efficiency and reliability. The VC80x adds support for the following Zebra Mobility Extensions.

- Coverage Hole Detection - The VC80x includes enhancements to the IEEE 802.11k standard. These improvements will report gaps in signal coverage to the Zebra wireless LAN infrastructure. Network administrators can detect and mitigate coverage gaps present in the network for greater reliability. Default: enabled.
- Aggregated Fast Transition - Aggregated FT improves on IEEE 802.11r, Over-the-DS fast roaming. In conjunction with Zebra wireless LAN infrastructure, the VC80x will achieve more reliable and consistent fast roaming. Default: enabled.
- Scan Assist - The VC80x monitors neighbor access points and retrieves roaming related information from the Zebra wireless LAN infrastructure without doing scans. Using this Scan Assist feature, the VC80x improves roaming. Default: enabled.

## Bluetooth

Bluetooth-equipped devices can communicate without wires, using frequency-hopping spread spectrum (FHSS) radio frequency (RF) to transmit and receive data in the 2.4 GHz Industry Scientific and Medical (ISM) band (802.15.1). Bluetooth wireless technology is specifically designed for short-range (10 meters (32.8 feet)) communication and low power consumption.

Devices with Bluetooth capabilities can exchange information (e.g., files, appointments, and tasks) with other Bluetooth enabled devices such as printers, access points, and other mobile devices.

The VC80x support Bluetooth Low Energy. Bluetooth Low Energy is targeted at applications in the healthcare, fitness, security, and home entertainment industries. It provides reduced power consumption and cost while maintaining standard Bluetooth range.

## Adaptive Frequency Hopping

Adaptive Frequency Hopping (AFH) is a method of avoiding fixed frequency interferers, and can be used with Bluetooth voice. All devices in the piconet (Bluetooth network) must be AFH-capable in order for AFH to work. There is no AFH when connecting and discovering devices. Avoid making Bluetooth connections and discoveries during critical 802.11b communications. AFH for Bluetooth consists of four main sections:

- Channel Classification - A method of detecting an interference on a channel-by-channel basis, or pre-defined channel mask.
- Link Management - Coordinates and distributes the AFH information to the rest of the Bluetooth network.
- Hop Sequence Modification - Avoids interference by selectively reducing the number of hopping channels.
- Channel Maintenance - A method for periodically re-evaluating the channels.

When AFH is enabled, the Bluetooth radio “hops around” (instead of through) the 802.11b high-rate channels. AFH coexistence allows Enterprise devices to operate in any infrastructure.

The Bluetooth radio in this device operates as a Class 2 device power class. The maximum output power is 2.5 mW and the expected range is 10 meters (32.8 ft.). A definition of ranges based on power class is difficult to obtain due to power and device differences, and whether one measures open space or closed office space.



**NOTE** It is not recommended to perform Bluetooth wireless technology inquiry when high rate 802.11b operation is required.

## Security

The current Bluetooth specification defines security at the link level. Application-level security is not specified. This allows application developers to define security mechanisms tailored to their specific need. Link-level security occurs between devices, not users, while application-level security can be implemented on a per-user basis. The Bluetooth specification defines security algorithms and procedures required to authenticate devices, and if needed, encrypt the data flowing on the link between the devices. Device authentication is a mandatory feature of Bluetooth while link encryption is optional.

Pairing of Bluetooth devices is accomplished by creating an initialization key used to authenticate the devices and create a link key for them. Entering a common personal identification number (PIN) in the devices being paired generates the initialization key. The PIN is never sent over the air. By default, the Bluetooth stack responds with no key when a key is requested (it is up to user to respond to the key request event). Authentication of Bluetooth devices is based-upon a challenge-response transaction. Bluetooth allows for a PIN or passkey used to create other 128-bit keys used for security and encryption. The encryption key is derived from the link key used to



authenticate the pairing devices. Also worthy of note is the limited range and fast frequency hopping of the Bluetooth radios that makes long-distance eavesdropping difficult.

Recommendations are:

- Perform pairing in a secure environment
- Keep PIN codes private and do not store the PIN codes in the device
- Implement application-level security.

## Bluetooth Profiles

The device supports the following Bluetooth services:

- Service Discovery Protocol (SDP) - Handles the search for known and specific services as well as general services.
- Serial Port Profile (SPP) - Allows use of RFCOMM protocol to emulate serial cable connection between two Bluetooth peer devices. For example, connecting the device to a printer.
- Object Push Profile (OPP) - Allows the device to push and pull objects to and from a push server.
- Advanced Audio Distribution Profile (A2DP) - Allows the device to stream stereo-quality audio to a wireless headset or wireless stereo speakers.
- Audio/Video Remote Control Profile (AVRCP) - Allows the device to control A/V equipment to which a user has access. It may be used in concert with A2DP.
- Personal Area Network (PAN) - Allows the use of Bluetooth Network Encapsulation Protocol to provide L3 networking capabilities over a Bluetooth link. Only PANU role is supported.
- Human Interface Device Profile (HID) - Allows Bluetooth keyboards, pointing devices, gaming devices and remote monitoring devices to connect to the device.
- Headset Profile (HSP) - Allows a hands-free device, such as a Bluetooth headset, to place and receive calls on the device.
- Hands-Free Profile (HFP) - Allows car hands-free kits to communicate with the device in the car.
- Out of Band (OOB) - Allows exchange of information used in the pairing process. Pairing is completed using the Bluetooth radio, but requires information from the OOB mechanism.
- File Transfer Profile (FTP) - Provides the capability to browse, manipulate and transfer files in file system of another system. Uses GOEP as a basis.
- Generic Attribute Profile (GATT) - Provides profile discovery and description services for Bluetooth Low Energy protocol. It defines how attributes are grouped together into sets to form services.
- HID Over GATT Profile (HOGP) - Defines the procedures and features used by Bluetooth low energy HID Devices using GATT and Bluetooth HID Hosts using GATT.
- Scan Parameters Profile (ScPP) - Provides devices with information to assist them in managing their connection idle timeout and advertising parameters to optimize for power consumption and/or reconnection latency.

## Bluetooth Power States

The Bluetooth radio is off by default.

- Suspend - When the VC80x goes into suspend mode, the Bluetooth radio stays on.
- Airplane Mode - When the VC80x is placed in Airplane Mode, the Bluetooth radio turns off. When Airplane mode is disabled, the Bluetooth radio returns to the prior state. When in Airplane Mode, the Bluetooth radio can be turned back on if desired.



## Bluetooth Radio Power

Turn off the Bluetooth radio to save power or if entering an area with radio restrictions (e.g., an airplane). When the radio is off, other Bluetooth devices cannot see or connect to the device. Turn on the Bluetooth radio to exchange information with other Bluetooth devices (within range). Communicate only with Bluetooth radios in close proximity.





**NOTE** To achieve the best battery life turn off radios when not in use.

### Enabling Bluetooth

1. Swipe down with two fingers from the status bar to open the quick access panel.
2. Touch  to turn Bluetooth on.
3. Touch .

### Disabling Bluetooth

1. Swipe down with two fingers from the status bar to open the quick access panel.
2. Touch  to turn Bluetooth off.
3. Touch .



## Discovering Bluetooth Device(s)



The VC80x can receive information from discovered devices without pairing. However, once paired, the VC80x and a paired device exchange information automatically when the Bluetooth radio is on. To find Bluetooth devices in the area:

1. Ensure that Bluetooth is enabled on both devices.
2. Ensure that the Bluetooth device to discover is in discoverable mode.
3. Ensure that the two devices are within 10 meters (32.8 feet) of one another.
4. Swipe down with two fingers from the status bar to open the quick access panel.
5. Touch **Bluetooth**.
6. Touch **More Settings**. The **Bluetooth** screen appears.
7. The VC80x begins searching for discoverable Bluetooth devices in the area and displays them under **Available devices**.
8. Scroll through the list and select a device. The **Bluetooth pairing request** dialog box appears.
9. Enter a PIN in the text box and touch **OK**. Enter the same PIN on the other device.
10. For Simple Pairing, touch **Pair** on both devices.
11. The Bluetooth device is added to the **Bluetooth devices** list and a trusted (“paired”) connection is established.

## Changing the Bluetooth Name


By default, the VC80x has a generic Bluetooth name that is visible to other devices when connected.

1. Swipe down from the status bar and then touch .
2. Touch  **Bluetooth**.
3. If Bluetooth is not on, touch the switch to turn Bluetooth on.

4. Touch .
5. Touch **Rename device**.
6. Enter a name and touch **Rename**.
7. Touch .





## Connecting to a Bluetooth Device

Once paired, connect to a Bluetooth device.

1. Swipe down from the status bar and then touch .
2. Touch **Bluetooth**.
3. In the list, touch the unconnected Bluetooth device.
4. When connected, Connected appears below the device name.





## Selecting Profiles on the Bluetooth Device

Some Bluetooth devices have multiple profiles. To select a profile:

1. Swipe down from the status bar and then touch .
2. Touch  **Bluetooth**.
3. In the **PAIRED DEVICES** list, touch  next to the device name.
4. Under **PROFILES**, check or uncheck a profile to allow the device to use that profile.
5. Touch .

## Unpairing a Bluetooth Device

To unpair a Bluetooth device and erase all pairing information:

1. Swipe up from the bottom of the Home screen and touch  >  **Bluetooth**.
2. In the **PAIRED DEVICES** list, touch  next to the device name.
3. Touch **Forget**.
4. Touch .

# Accessories and Mounting

---

## Introduction

This chapter provides accessory information, mounting options and instructions.

---

## Accessories

**Table 9** Accessories

Model Number	Description
<b>Antennas</b>	
AN2010	Antenna, dual band, 802.11 a/b/g/n, 2 dBi, reverse polarity SMA connector, magnetic mount, 2.9 m (9.5 ft) cable.
AN2020	Antenna, 2.4 GHz, 802.11 b/g, 5 dBi, reverse polarity SMA connector, magnetic mount, 2.9 m (9.5 ft) cable.
AN2030	Whip antenna (stubby), dual band, 802.11 a/b/g/n, 2.4 GHz 2 dBi, 5 GHz 3.7 dBi, reverse polarity SMA connector.
AR1000	Right Angle SMA reverse polarity plug-jack adapter.
<b>Mounts</b>	
MT4200	Quick release mount.
MT4205	Mounting plate for the MT4200 quick release mount.
MT4210	Adapter bracket kit for 82XX quick release mount.
MT4510	RAM rectangular base with 2.25" rubber ball.
MT4301	RAM mount, 4" arm.
MT4302	RAM mount, 12" arm.
MT3501	VESA base (for 4" or 12" RAM arm).
MT3502	Circular base (for 4" or 12" RAM arm).
MT3505	Clamp base (for 4" or 12" RAM arm), 2" max. width.
MT3507	Clamp base (for 4" or 12" RAM arm), 3" max. width.

**Table 9** Accessories (Continued)

Model Number	Description
MT3509	Rail base (for 4" or 12" RAM arm), 1-1/4" to 1-7/8".
MT3510	Rail base (for 4" or 12" RAM arm), 2" to 2-1/2"
KT-SCANMNT-VC80-R	Side mounted holder for scanner.
KT-KYBDTRAY-VC80-R	Keyboard mounting tray (includes tilting arms, knobs and screws) for VC80x keyboards.
KT-KYBDMNT-VC80-R	Function/Numeric keypad side mount bracket.
MNT-VC80-ADPA1-1	Adapter for VC50 U-Mount.
MNT-VC80-ADPB1-1	Adapter for Honeywell U-Mount.
KT-U-MOUNT-VC80-R	U-Mount, with VC70 and 8585 / 8595 U-Mount hole pattern. Includes MNT-VC80-ADPA1-1 adapter.
<b>Keyboard</b>	
KYBD-QW-VC80-S-1	USB QWERTY keyboard with 22 cm (8.66 in.) cable for VC80.
KYBD-QW-VC80-L-1	USB QWERTY keyboard with 300 cm (9.8 ft) cable for VC80.
<b>Speaker/Mic</b>	
M1000	Speaker/Mic with push-to-talk function.
<b>Miscellaneous</b>	
KT-SPRTCT-VC70-05R	Screen protector pack of 5
SL0001	Stylus and stylus holder
KT-VC80-BTRY1-01	Spare battery
WA4070	Ethernet to USB Dongle.
<b>Power Supplies and Cables</b>	
PS000145A01	100/240 VAC power supply, 24 VDC, 6.5 A, 150W (AC power cord sold separately)
PS1370	Pre-Regulator, 19 - 90 VDC in, 15 VDC out, 90 W
CB000417A01	DC power adaptor to VC50 extension cable
CB000416A01	DC Power adaptor to VC70 extension cable
CA1210	Power extension cable, DC, 6', waterproof
CA1230	Power extension cable for pre-regulator
CA1220	Power extension cable, DC, 180 cm, with ignition sense
CA1300	Screen blanking cable (DB9 to open wires)

**Table 9** Accessories (Continued)

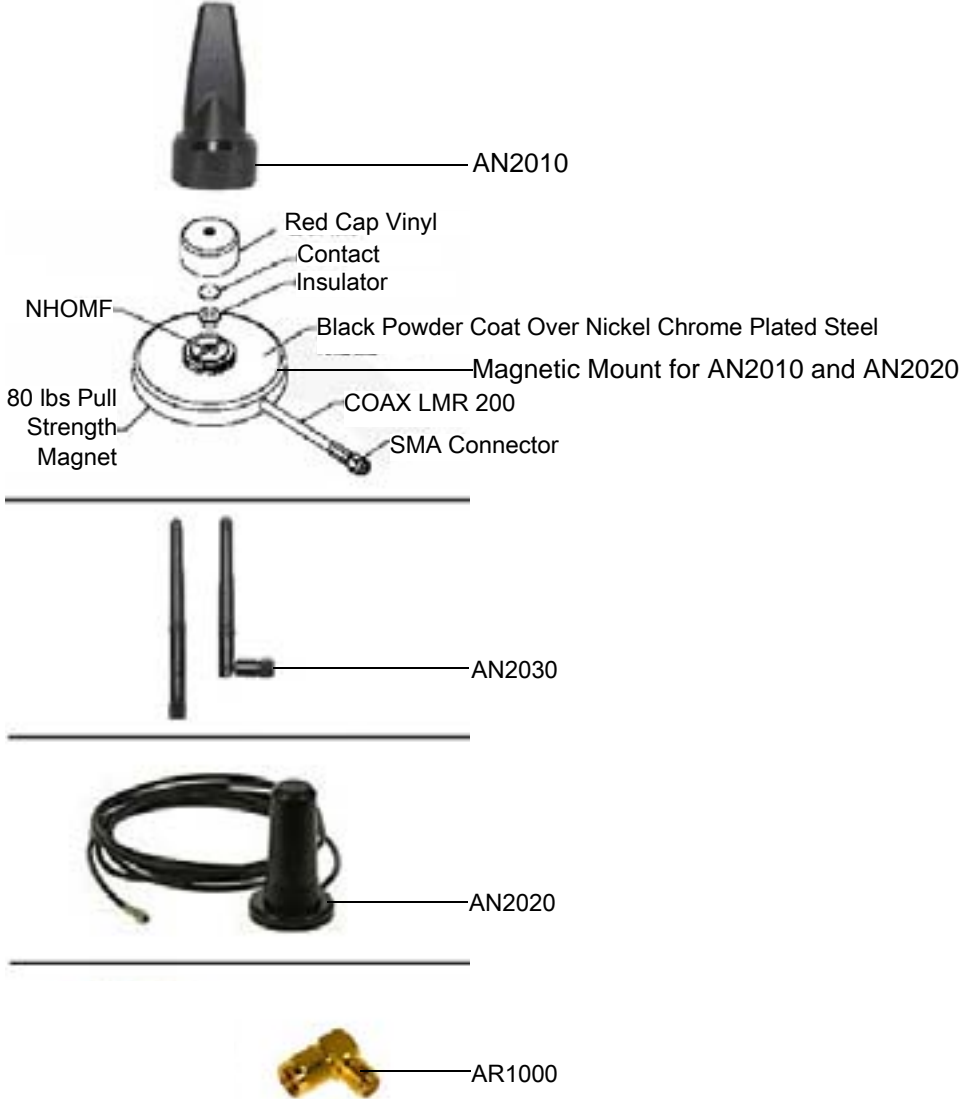
Model Number	Description
A9169798	Adapter CPC to LXE/Honeywell VCX8, VX9, VM1, VM2 and VM3 DC Power Extension Cable.
A9169801	Adapter CPC and Serial to LXE VCX8 and VX9 DC Power Extension and Screen Blanking Cable.

# VC80x Antenna Options

Antenna hardware configurations are located in [Table 9 on page 132](#). To determine the best antenna option for your location, contact your Zebra representative.

**!** **IMPORTANT** If using a magnetic mount antenna, place it in a location that balances the need for the VC80x to communicate with the access points and local Bluetooth peripherals.

**Figure 86** VC80x Antenna Options



---

## VC80x Mounting Accessories

**WARNING**

Failure to install the mount correctly, or modifications to the mount, may result in serious injury or damage to property. Contact Zebra Technical Support or your Zebra representative if you have problems installing this mount. To ensure operator safety, you must use a calibrated torque wrench and the supplied mounting hardware when fastening the computer and mount. Use of this mount in vehicles driven on public roads or highways is prohibited. Contact Zebra for further details.

Before mounting a VC80x in a vehicle, there are a number of operator safety issues that require careful attention. When mounting a VC80x use only approved Zebra mounting hardware and mounting parts which are specific to the VC80x model purchased. An improperly mounted VC80x or use of non-approved parts may result in one or more of the following: operator injury, property damage, operator visibility obstruction, operator distraction, and/or poor ease of egress for the operator. Zebra strongly recommends that you seek professional mounting advice from the vehicle manufacturer.

If it is necessary to mount the VC80x overhead, or in any position that could cause injury to the operator should the unit fall, it is critical that a secondary tether or other fail safe device be installed.

The following restrictions must be strictly enforced:

- Do not use the mount and/or the VC80x as a hand-held. Using the mount in this manner may cause the person to fall or dislodge the mounting hardware and/or mounts.
- Do not add weight or attach any other items to the mount or VC80x. Additional elements may fall causing injury, or may increase the chance of failure and/or damage in mounting hardware and/or mounts.
- Mounts used in industrial or vibration generating environments may be subjected to fatigue, stress, and/or part wear. A periodic inspection of the mounting hardware and mounts should be performed to ensure parts are retightened to the correct torque, free of fractures, excessive wear, and/or other environmental damage. Any parts found to be unsafe should be removed and replaced immediately. After inspection or replacement of parts, readjust the mount as outlined in the pertinent sections below.
- Cable routing within a vehicle cab also requires careful consideration, especially for separately connected scanners and other devices with loose cables. If you are unable to obtain suitable advice, contact Zebra for assistance. For better protection, the equipment should be mounted inside the vehicle roll cage.
- When charging the vehicle battery, the VC80x must be either disconnected from the battery or it must be determined that the maximum allowed input voltage of the VC80x is not exceeded.



## MT43XX RAM Mount



**IMPORTANT** To avoid injury, this device must be properly secured when in a moving vehicle.

Keep this device away from magnetic fields.

Do not place the computer near a television or radio receiver.

Do not disassemble the VC80x computer as there are no user-serviceable parts inside.



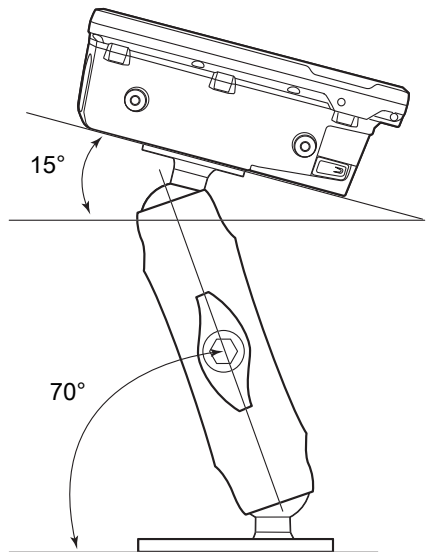
**IMPORTANT** The operator can easily adjust the tilt and rotation of the VC80x. Use care to avoid operator injury or equipment damage if the computer slips due to a loosened hand screw.

The VC80x may be installed using an articulating RAM Mount (Model MT43XX – 4 in. or 12 in. arm) secured to either a VESA or circular base.

The RAM articulating mount can be installed in a variety of orientations (see [Figure 88 on page 138](#)). Select the best orientation for the specific application. Preferred orientations maintain the center of mass of the computer assembly, directly over the center of the base.

For detailed mount installation information, refer to the instructions included with the mount kit.

**Figure 87** Orientation of Vehicle-Mount Assembly



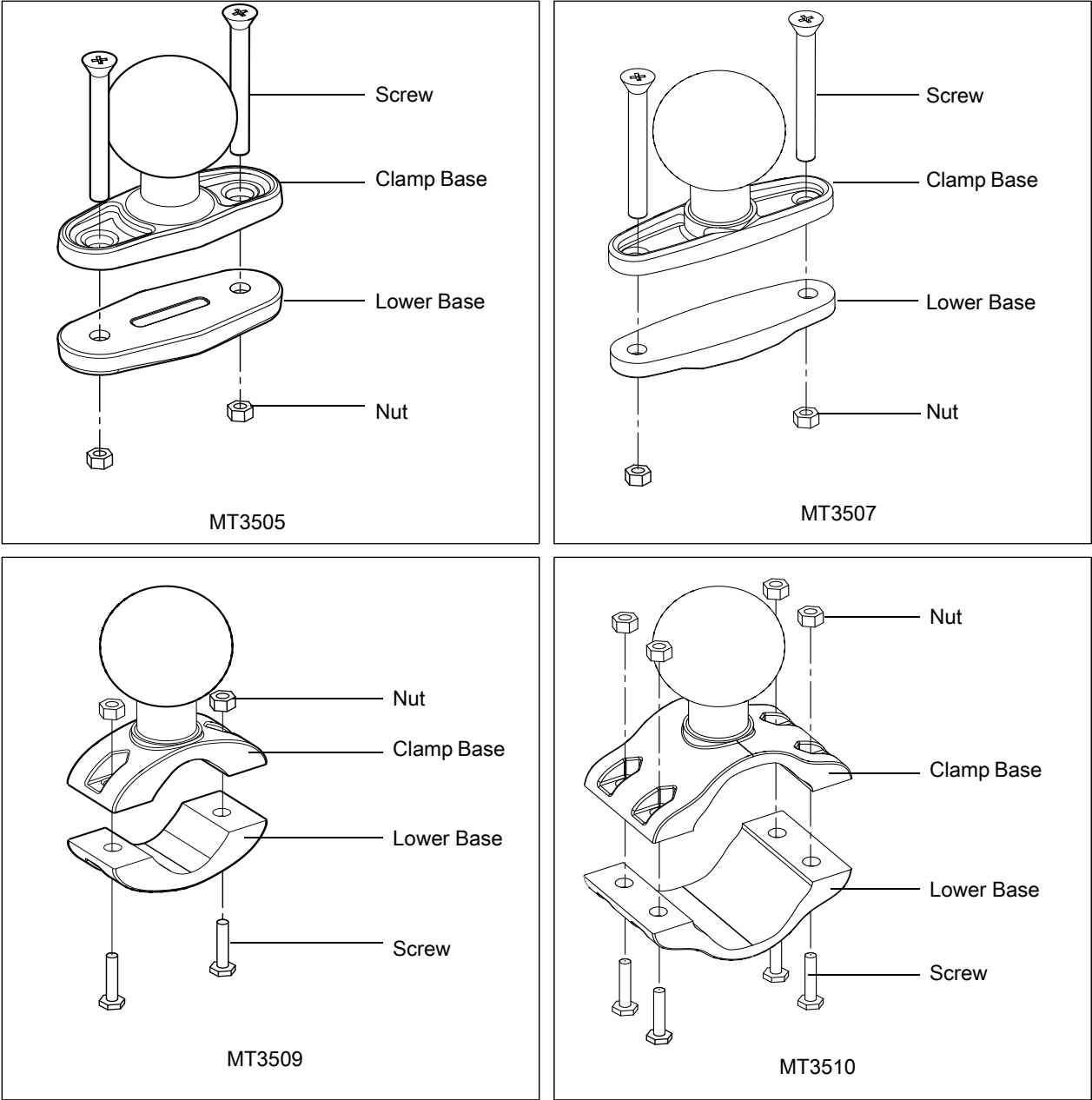
## Optional Mounts

One of the following optional mounting kits shown in [Figure 88](#) may be substituted for the Vesa base or the circular base when mounting to a post or forklift roll cage.

To assemble the optional mount kit:

1. Mount the clamp base and lower base around the shaft.
2. Place the screws through the clamp and the lower base, and affix with the nuts.
3. Torque to 26 in-lbs.
4. Secure the RAM standard arm by inserting the RAM balls into both ends of the arm sockets.

Figure 88 Optional Mount Kits



**Plate Bases for MT35XX Mounts**

Plate bases are not recommended for forklift mounting solutions. If this requires a plate rather than a clamp base, you must penetrate into the structure of the vehicle. This requires additional hardware. The following plate bases are available:

- MT3501 - VESA Plate
- MT3502 - Circular Plate

### MT4200 Quick Release Mount

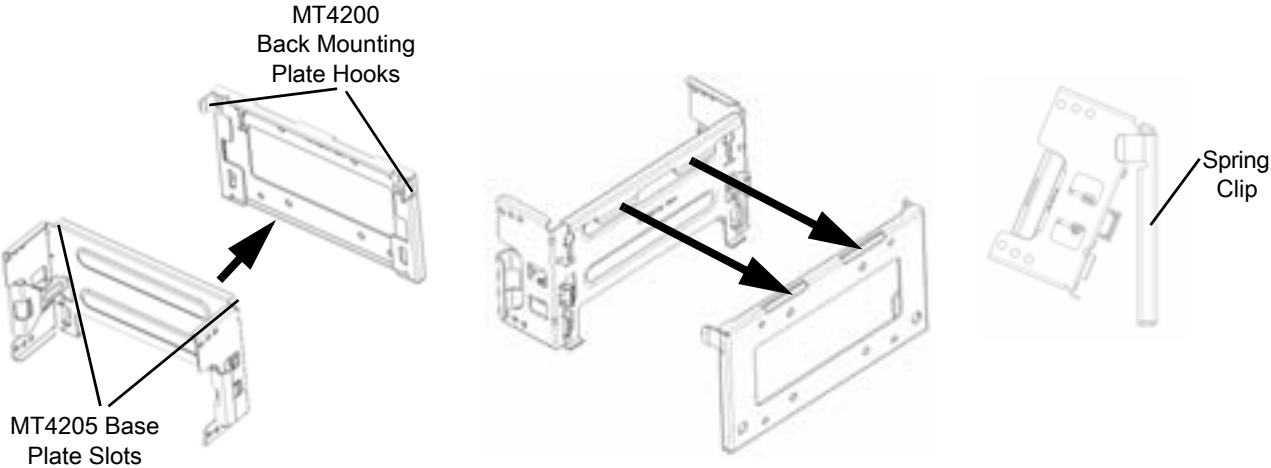
The MT4200 Quick Release Mount allows for removal without the need for tools.

#### Assembling MT4200

To assemble the MT4200 Quick Release Mount:

- 1. Place the back mounting plate hooks into the base plate slots.
- 2. Snap spring clips into place.

Figure 89 MT4200 Quick Release Mount Assembly

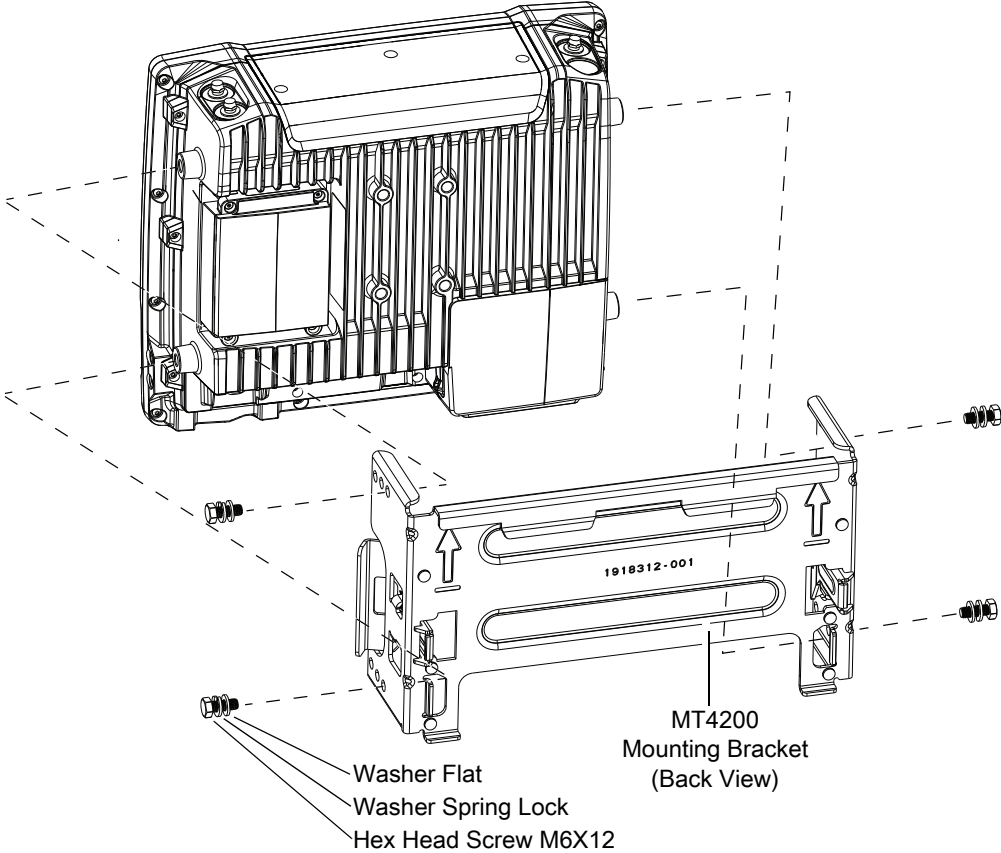


### Attaching MT4200 to VC80x

To attach the MT4200 Quick Release Mount to the VC80x:

- 1. Line up the MT4200 mounting bracket holes with the holes on the sides of the VC80x (two on each side).
- 2. Place the spring lock washer onto the hex head screw.
- 3. Place the flat washer onto the hex head screw (on top of the washer spring lock).
- 4. Screw the bracket onto the VC80x (total of four). Torque to 34.7 in-lbs.

Figure 90 VC80x and MT4200 Assembly



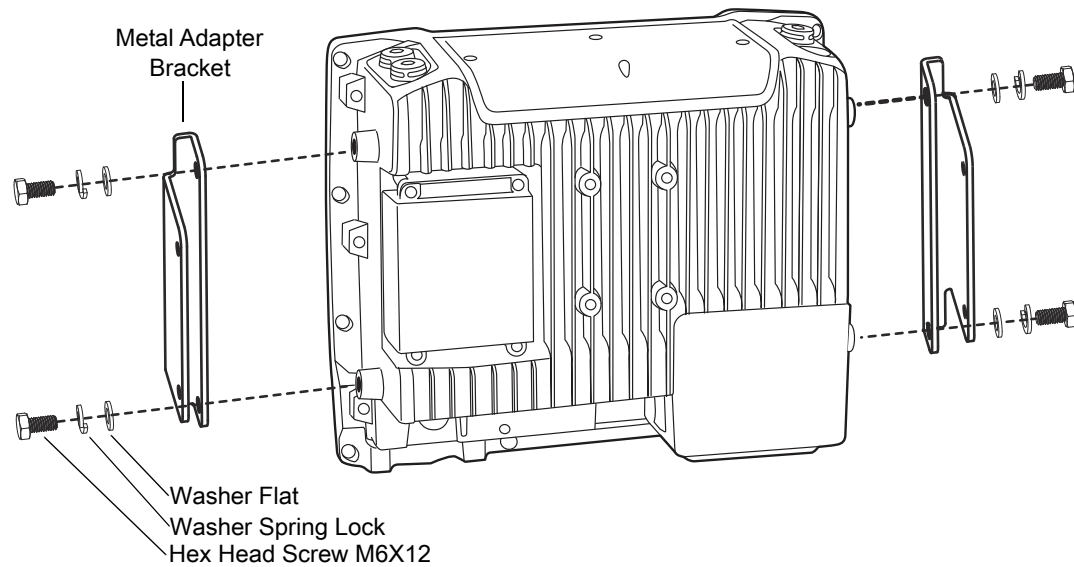
## MT4210 Adapter Bracket

The MT4210 Adapter Bracket is for use with older mounts, such as the 82XX Quick Release Mount.

To assemble the MT4210 Adapter Bracket:

1. Line up the MT4210 mounting bracket holes with the holes on the sides of the VC80x (two on each side).
2. Place the spring lock washer onto the hex head screw.
3. Place the flat washer onto the hex head screw (on top of the washer spring lock).
4. Screw the metal adapter bracket onto the VC80x (total of four). Torque to 34.7 in-lbs.

**Figure 91** MT4210 Adapter Bracket Assembly



# DataWedge Configuration

---

## Introduction

This chapter applies to DataWedge on Android devices. DataWedge is an application that reads data, processes the data and sends the data to an application.

---

## Profiles

DataWedge is based on profiles and plug-ins. A profile contains information on how DataWedge should behave with different applications.

Profile information consists of:

- Associated application
- Input plug-in configurations
- Output plug-in configurations
- Process plug-in configurations.

Using profiles, each application can have a specific DataWedge configuration. For example, each user application can have a profile which outputs scanned data in the required format when that application comes to the foreground. DataWedge can be configured to process the same set of captured data differently based on the requirements of each application.

DataWedge includes the following pre-configured profiles which support specific built-in applications:

- Visible profiles:
  - **Profile0** - created automatically the first time DataWedge runs. Generic profile used when there are no user created profiles associated with an application.
  - **Launcher** - enables scanning when the Launcher is in foreground. Note: to save battery power, disable this profile when not required.
  - **DWDemo** - provides support for the DWDemo application.

Some Zebra applications are capable of capturing data by scanning. DataWedge is pre-loaded with private and hidden profiles for this purpose. There is no option to modify these private profiles.

## Profile0

**Profile0** can be edited but cannot be associated with an application. That is, **DataWedge** allows manipulation of plug-in settings for **Profile0** but it does not allow assignment of a foreground application. This configuration allows

**DataWedge** to send output data to any foreground application other than applications associated with user-defined profiles when **Profile0** is enabled.

**Profile0** can be disabled to allow **DataWedge** to only send output data to those applications which are associated in user-defined profiles. For example, create a profile associating a specific application, disable **Profile0** and then scan. **DataWedge** only sends data to the application specified in the user-created profile. This adds additional security to **DataWedge** enabling the sending of data only to specified applications.

---

## Plug-ins

A plug-in is a software module utilized in **DataWedge** to extend its functionality to encompass technologies such as barcode scanning. The plug-ins can be categorized into three types based on their operations:

- Input Plug-ins
- Output Plug-ins
- Process Plug-ins.

### Input Plug-ins

An Input Plug-in supports an input device, such as a barcode scanner contained in, or attached to the device. **DataWedge** contains base plug-ins for these input devices.

- **Bar Code Scanner Input Plug-in** – The Bar Code Scanner Input Plug-in is responsible for reading data from the integrated barcode scanner and supports different types of barcode readers including laser, imager and internal camera. Raw data read from the barcode scanner can be processed or formatted using Process Plug-ins as required. **DataWedge** has built-in feedback functionality for the barcode scanner to issue user alerts. The feedback settings can be configured according to user requirement.

### Process Plug-ins

Process Plug-ins are used in **DataWedge** to manipulate the received data according to the requirement, before sending to the foreground application via the Output Plug-in.


- **Basic Data Formatting Process Plug-in** – The Basic Data Formatting Plug-in allows **DataWedge** to add a prefix and/or a suffix to the captured data before passing it to an Output Plug-in.
- **Advanced Data Formatting Process Plug-in** – The Advanced Data Formatting Plug-in allows **DataWedge** to apply rules (actions to be performed based on defined criteria) to the data received via an input plug-in before passing it to an Output Plug-in.

### Output Plug-ins

Output Plug-ins are responsible for sending the data from Input Plug-ins to a foreground application on the device.

- **Keystroke Output Plug-in** – The Keystroke Output Plug-in collects and sends data received from the Input Plug-in to the foreground applications by emulating keystrokes.
- **Intent Output Plug-in** – The Intent Output Plug-in collects and sends data received from the Input Plug-ins to foreground applications using the Android Intent mechanism.
- **IP Output Plug-in** – The IP Output Plug-in collects and sends data received from the Input Plug-ins to a host computer via a network connection. Captured data can be sent over an IP network to a specified IP address and port using either TCP or UDP transport protocols.

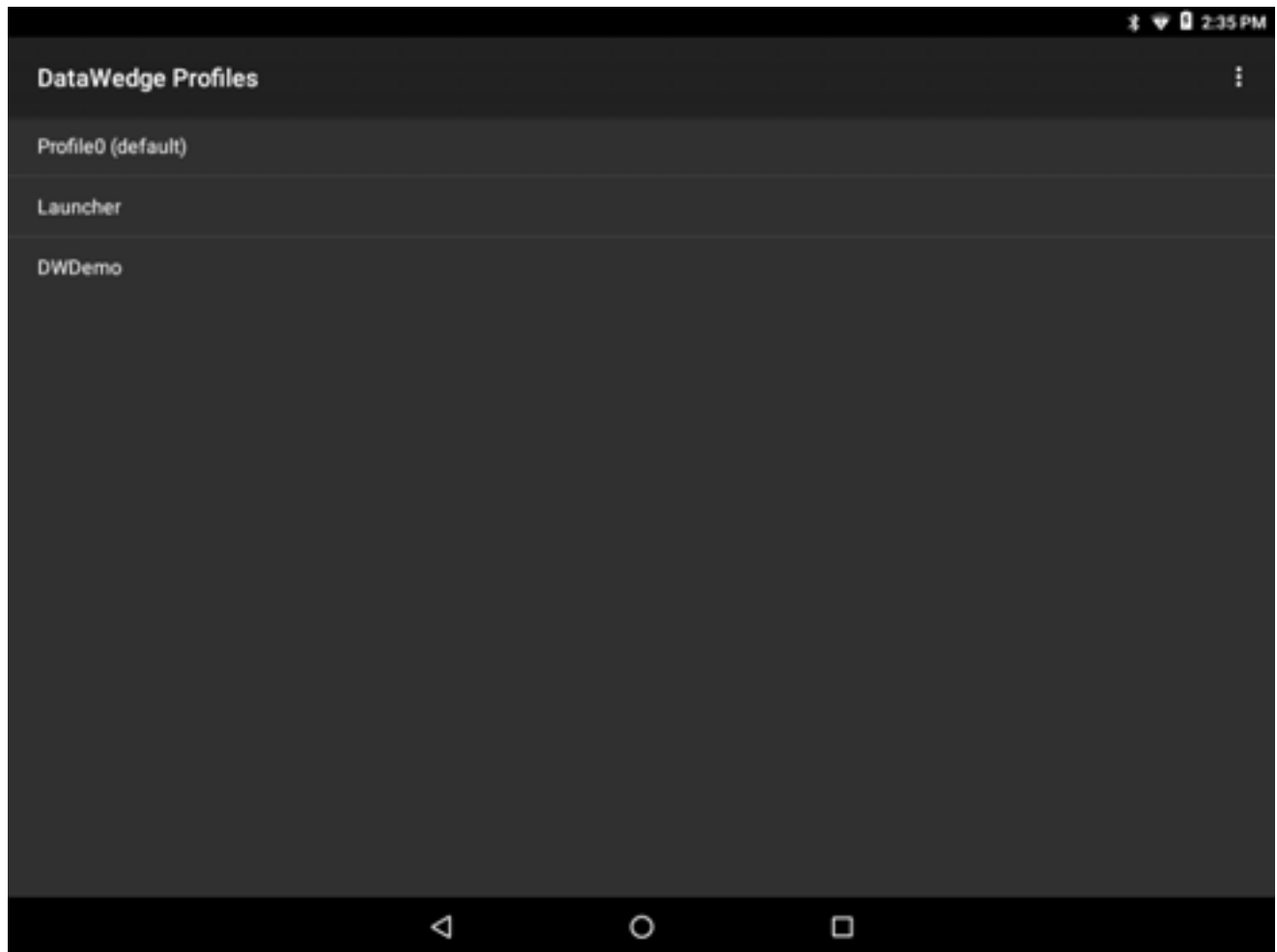
## Profiles Screen

To launch DataWedge, swipe up from the bottom of the Home screen and touch . By default, three profiles appear:

- **Profile0**
- **Launcher**
- **DWDemo.**

Profile0 is the default profile and is used when no other profile can be applied.

**Figure 92** DataWedge Profiles Screen



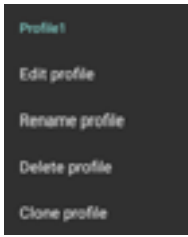
Profile names are color coded. Enabled profiles are white and disabled profiles are gray.

To configure a profile touch the profile name.

## Profile Context Menu

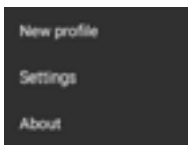
Touch and hold a profile to open a context menu that allows additional actions to be performed on the selected profile.



**Figure 93** Profile Context Menu



The profile context menu allows the profile to be edited (same as just tapping on a profile), renamed or deleted.

## Options Menu

**Figure 94** DataWedge Options Menu

The menu provides options to create a new profiles, access to general DataWedge settings and DataWedge version information.



## Disabling DataWedge

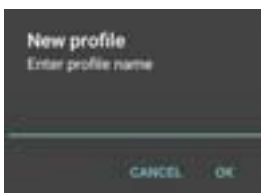
1. Swipe up from the bottom of the Home screen and touch .
2. Touch .
3. Touch **Settings**.
4. Touch **DataWedge enabled**.

The blue check disappears from the checkbox indicating that DataWedge is disabled.

---

## Creating a New Profile

5. Swipe up from the bottom of the Home screen and touch .
6. Touch .
7. Touch **New profile**.
8. In the **New profile** dialog box, enter a name for the new profile. It is recommended that profile names be unique and made up of only alpha-numeric characters (A-Z, a-z, 0-9).

**Figure 95** New Profile Name Dialog Box

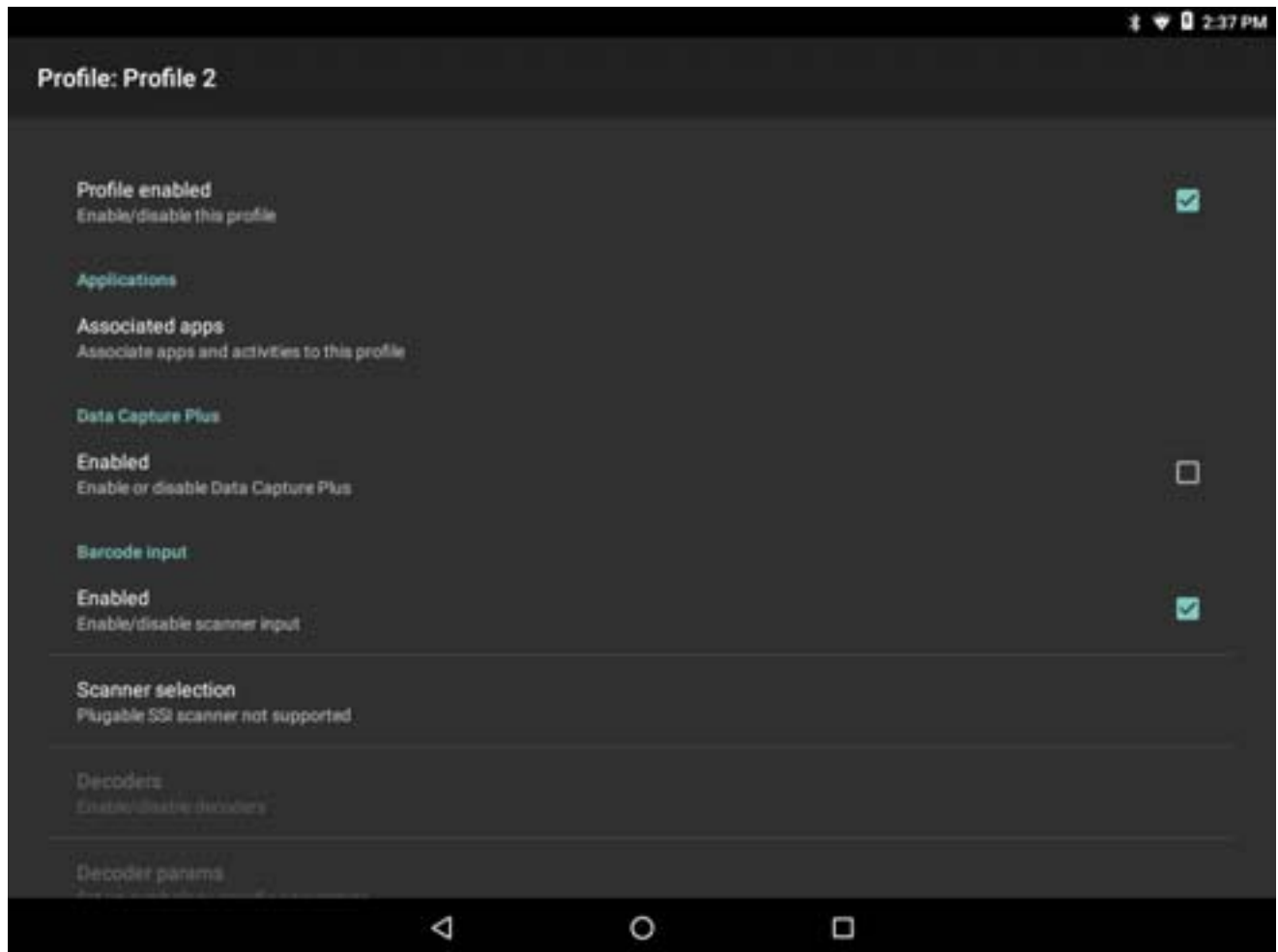
9. Touch **OK**.

The new profile name appears in the **DataWedge profile** screen.

## Profile Configuration

To configure the Profile0 or a user-created profile, touch the profile name.

**Figure 96** Profile Configuration Screen



The configuration screen lists the following sections:

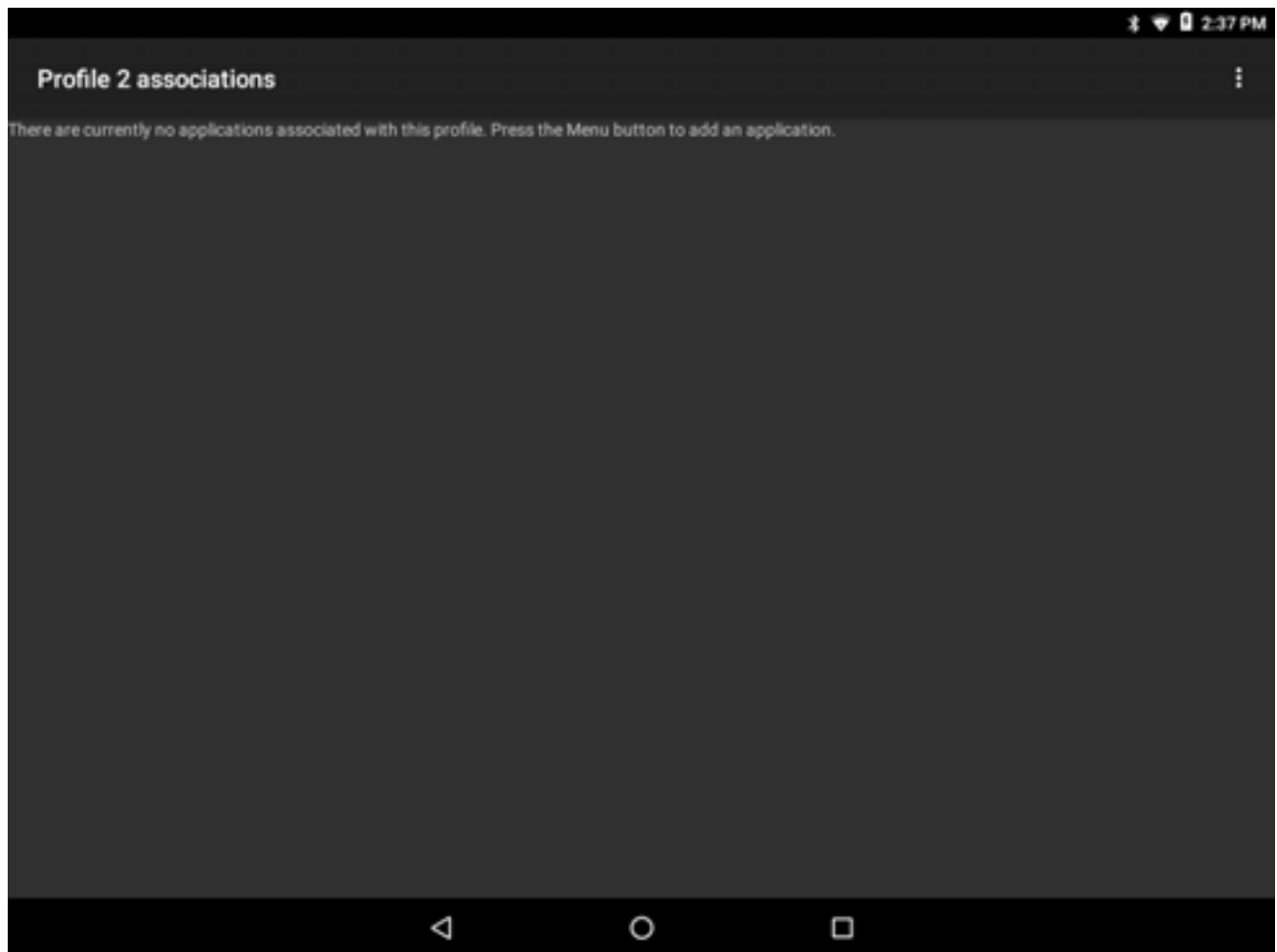
- Profile enabled
- Applications
- Data Capture Plus (DCP)
- Serial port input from Serial Port 1
- Serial port input from Serial Port 2
- Barcode Input
- Keystroke output
- Intent Output
- IP Output.

## Associating Applications

Use Applications option to associate applications with this profile. User created profiles should be associated with one or more applications and its activities.

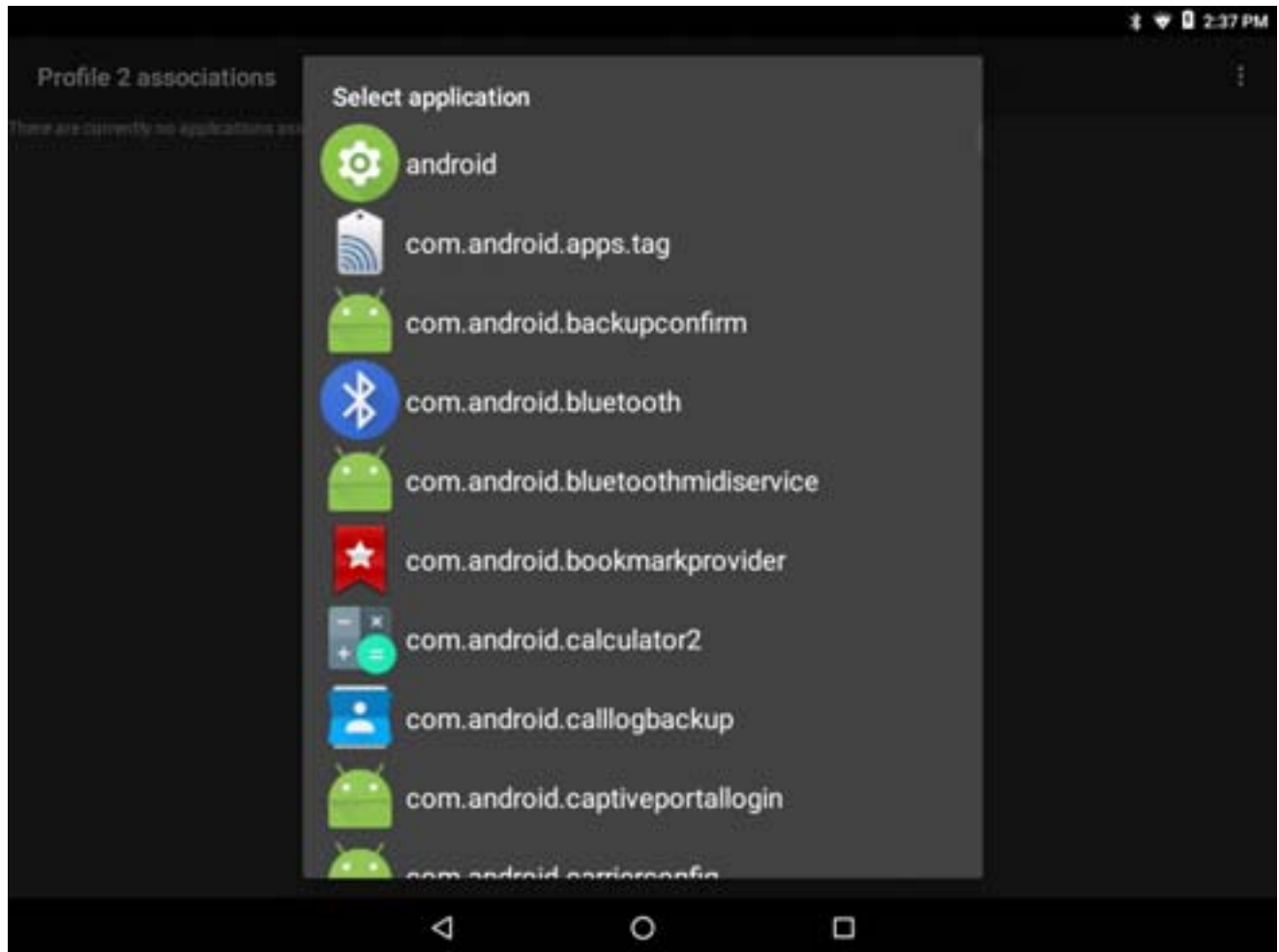
1. Touch **Associated apps**. A list of applications/activities associated with the profile displays. Initially the list does not contain any applications/activities.


**Figure 97** Associated Apps Screen



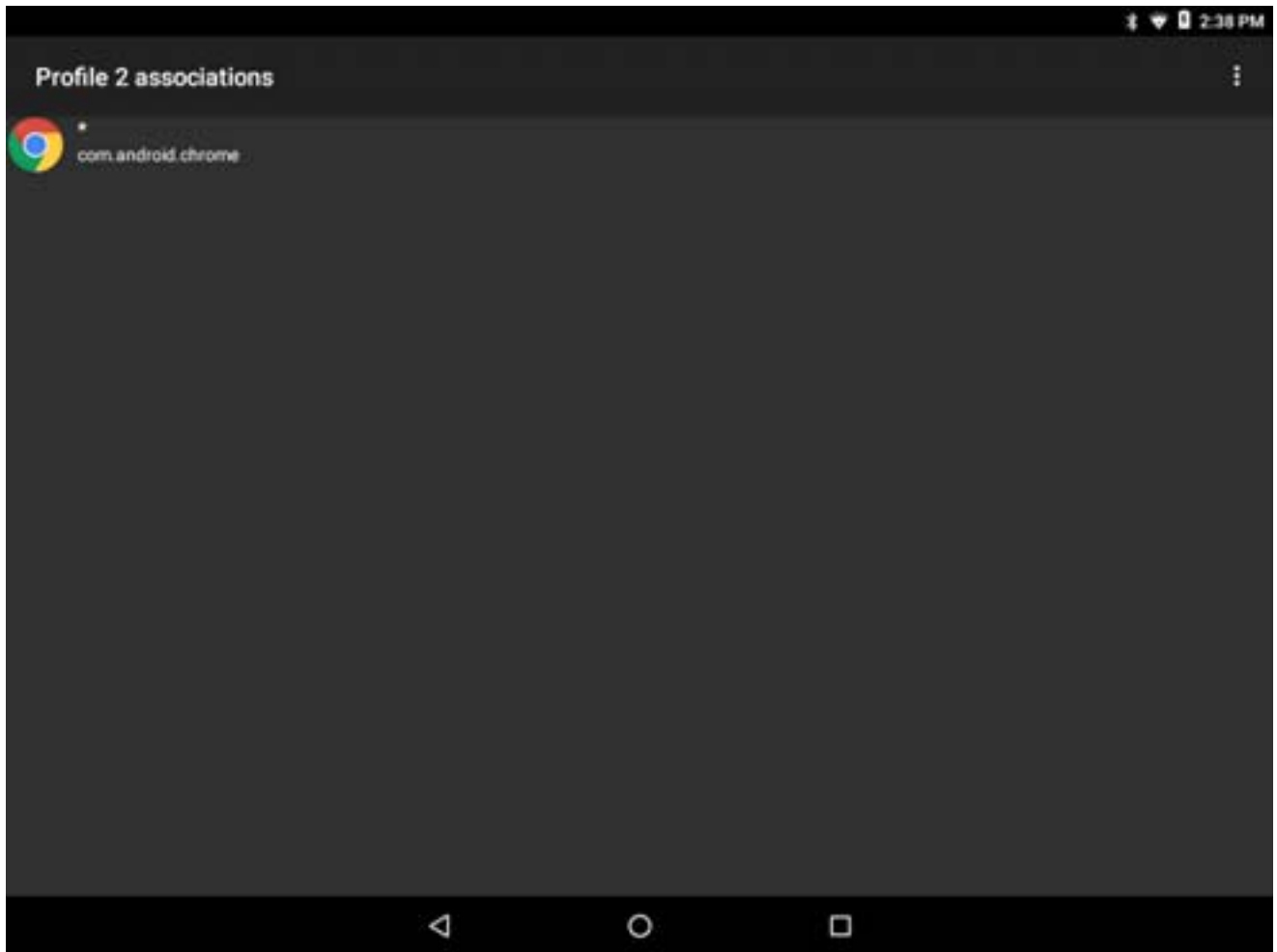
2. Touch .
3. Touch **New app/activity**.

Figure 98 Select Application Menu



4. In the **Select application** screen, select the desired application from the list.
5. In the **Select activity** menu, selecting the activity adds that application/activity combination to the associated application list for that profile. Selecting \* as the activity results in all activities within that application being associated to the profile. During operation, DataWedge tries to match the specific application/activity combinations with the foreground application/activity before trying to match the general application/\* combinations.
6. Touch .

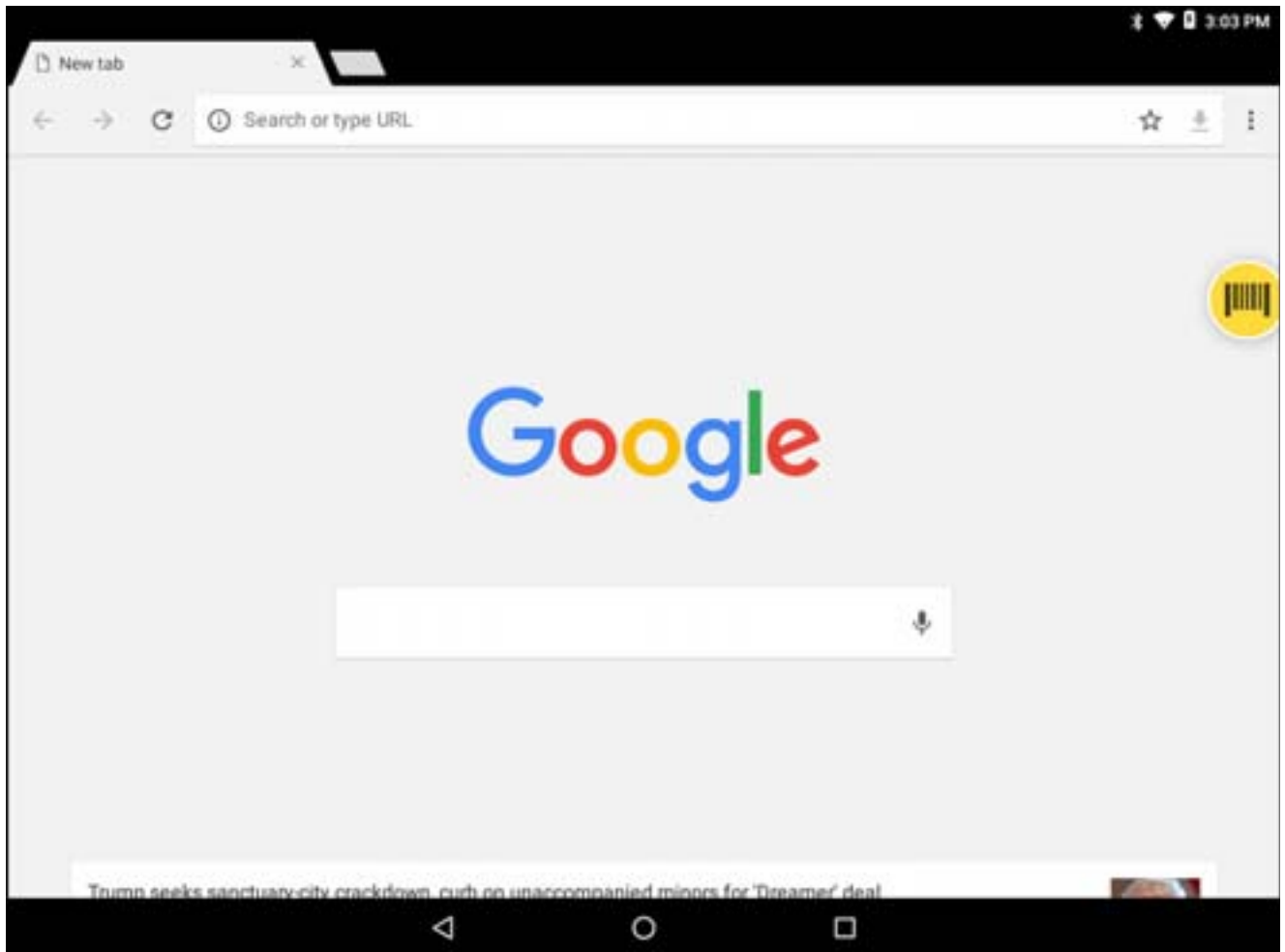
**Figure 99** Selected Application/Activity



## Data Capture Plus

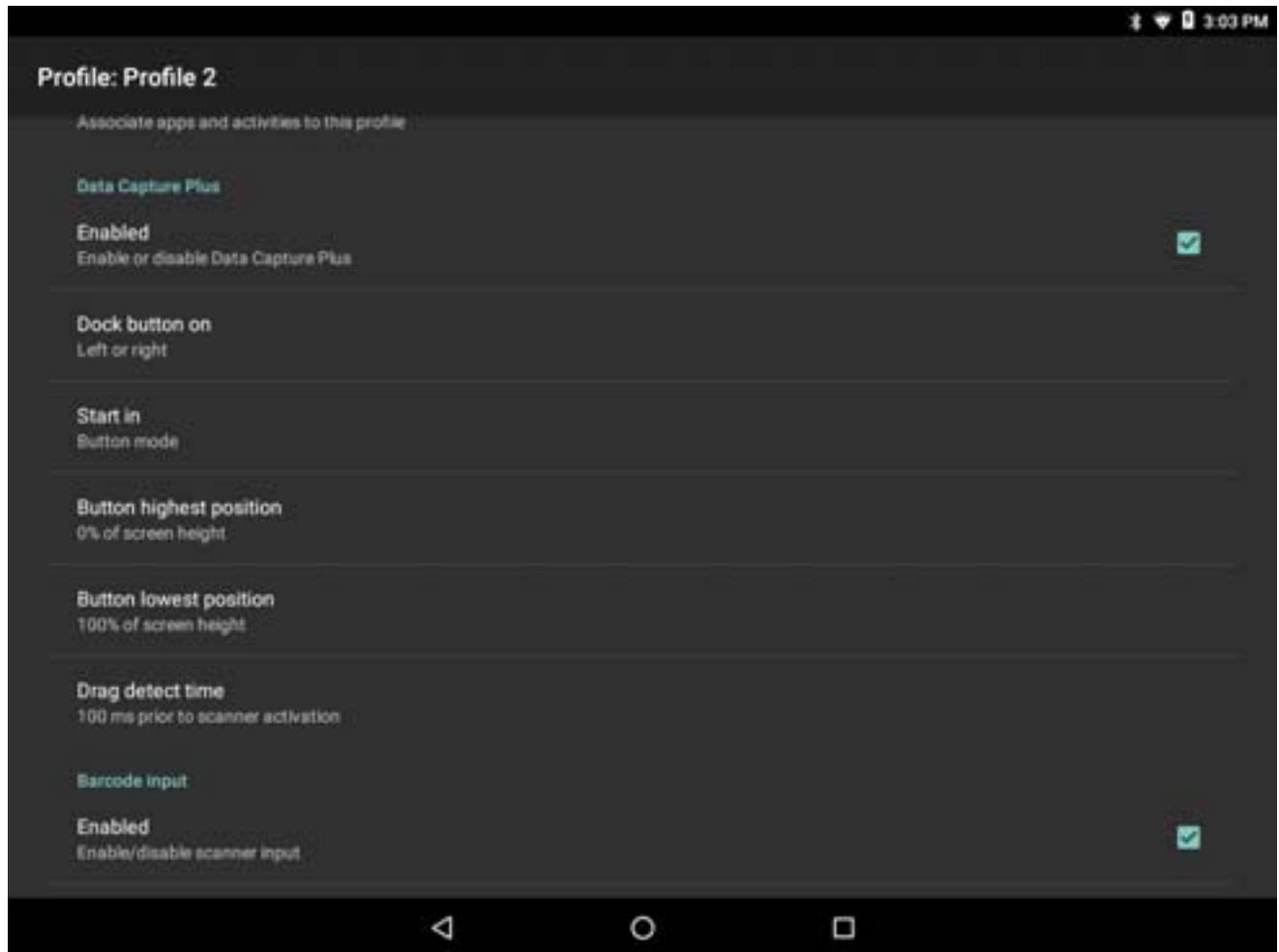
Data Capture Plus (DCP) is a DataWedge feature that enables the user to initiate data capture by touching a designated part of the screen. A variable screen overlay acts like a scan button.

**Figure 100** Minimized Data Capture Panel



The DataWedge profile configuration screen allows the user to configure how the DCP appears on the screen once the particular profile is enabled. The DCP is hidden by default. Enabling DCP option displays seven additional configuration parameters.

Figure 101 Data Capture Panel Settings



- Enable - Select to enable Data Capture Plus (default - disabled).
- Dock button on - Select position of the button.
  - **Left or right** - Allows user to place the button on either the right or left edge of the screen.
  - **Left only** - Places the button on left edge of the screen.
  - **Right only** - Places the button on the right edge of the screen.
- Start in - Select the initial DCP state.
  - **Fullscreen mode** - DCP covers the whole screen.
  - **Button mode** - DCP displays as a circular button on the screen and can be switched to fullscreen mode.
  - **Button only mode** - DCP displays as a circular button on the screen and cannot be switched to fullscreen mode.
- **Button highest position** - Select the top of the range the user is allowed to move the DCP, given as a percent of the screen height (default - 0).
- **Button lowest position** - Select the bottom of the range the user is allowed to move the DCP, given as a percent of the screen height (default - 100).
- **Drag detect time** - Select the time in milliseconds that the scanner waits before activating scanner. This allows the user to drag the button without initiating scanner (default - 100 ms, maximum 1000 ms).



**NOTE** The DCP does not appear if the scanner is disabled in the profile even though the **Enabled** option is set.

In Button mode, the user can place DCP in full screen mode by dragging the button over **Fullscreen mode**. The overlay covers the screen.

**Figure 102** Maximized DCP



Swipe down to return to button mode.

## Bar Code Input

Use the **Bar Code Input** options to configure the Bar Code Scanner Input Plug-in for the profile.

### Enabled

Enables or disables this plug-in. A check in the checkbox indicates that the plug-in is enabled.

### Scanner Selection

Configures which scanning device to use for barcode data capture when the profile is active.

- Auto - The software automatically determines the best scanning device.



- DS3608 USB SSI scanner
- Bluetooth scanner
- DS3678 Bluetooth Scanner
- RS6000 Bluetooth Scanner - Scanning is performed using the option RS6000 Bluetooth scanner.

### Decoders

Configures which barcode decoders are enabled or disabled. For best performance disable all unnecessary decoders.

Touch **Decoders**. The **Barcode input** screen appears. A check in the checkbox indicates that the decoder is enabled. By default the most commonly used decoders are enabled (shown below with an asterisk). The supported decoders are:




**NOTE** DataWedge supports the decoders listed below but not all are validated on this device.

**Table 10** Supported Decoders

Decoders	RS507/RS507x	RS6000	DS36X8
Australian Postal	Disabled	Disabled	Disabled
Aztec	Enabled	Enabled	Enabled
Canadian Postal	Not supported	Disabled	Not supported
Chinese 2 of 5	Disabled	Disabled	Disabled
Codabar	Enabled	Enabled	Enabled
Code 11	Disabled	Disabled	Disabled
Code 128	Enabled	Enabled	Enabled
Code 39	Enabled	Enabled	Enabled
Code 93	Disabled	Disabled	Disabled
Composite AB	Disabled	Disabled	Disabled
Composite C	Disabled	Disabled	Disabled
Discrete 2 of 5	Disabled	Disabled	Disabled
Datamatrix	Enabled	Enabled	Enabled
Dutch Postal	Disabled	Disabled	Disabled
EAN-13	Enabled	Enabled	Enabled
EAN-8	Enabled	Enabled	Enabled
GS1 DataBar	Enabled	Enabled	Enabled
GS1 DataBar Expanded	Enabled	Enabled	Enabled
GS1 DataBar Limited	Disabled	Disabled	Disabled
HAN XIN	Not supported	Disabled	Disabled
Interleaved 2 of 5	Disabled	Disabled	Disabled
Japanese Postal	Disabled	Disabled	Disabled
Korean 3 of 5	Disabled	Disabled	Disabled
MAIL MARK	Not supported	Enabled	Enabled
Matrix 2 of 5	Disabled	Disabled	Disabled
Maxicode	Enabled	Enabled	Enabled
MicroPDF	Disabled	Disabled	Disabled
MicroQR	Disabled	Disabled	Disabled
MSI	Disabled	Disabled	Disabled
PDF417	Enabled	Enabled	Enabled
QR Code	Enabled	Enabled	Enabled

**Table 10** Supported Decoders (Continued)

Decoders	RS507/RS507x	RS6000	DS36X8
Decoder Signature	Disabled	Disabled	Not supported
TLC 39	Disabled	Disabled	Disabled
Trioptic 39	Disabled	Disabled	Disabled
UK Postal	Disabled	Disabled	Disabled
UPC-A	Enabled	Enabled	Enabled
UPC-E0	Enabled	Enabled	Enabled
UPC-E1	Disabled	Disabled	Disabled
US4state	Disabled	Disabled	Disabled
US4state FICS	Disabled	Disabled	Disabled
US Planet	Disabled	Disabled	Disabled
US Postnet	Disabled	Disabled	Disabled

Touch  to return to the previous screen.

## Decoder Params

Use **Decode Params** to configure individual decoder parameters.

### Codabar

- **CLSI Editing** - Enable this parameter to strip the start and stop characters and insert a space after the first, fifth, and tenth characters of a 14-character Codabar symbol. Enable this feature if the host system requires this data format (default - disabled).
- **Length1** - Use to set decode lengths (default - 6). See [Decode Lengths on page 161](#) for more information.
- **Length2** - Use to set decode lengths (default - 55). See [Decode Lengths on page 161](#) for more information.
- **NOTIS Editing** - Enable this parameter to strip the start and stop characters from a decoded Codabar symbol. Enable this feature if the host system requires this data format (default - disabled).
- **Redundancy** - Sets the reader to read the barcode twice before accepting data. A check in the checkbox indicates that redundancy is enabled (default - enabled).

### Code 11

- **Length1** - Use to set decode lengths (default - 4). See [Decode Lengths on page 161](#) for more information.
- **Length2** - Use to set decode lengths (default - 55). See [Decode Lengths on page 161](#) for more information.
- **Redundancy** - Sets the reader to read the barcode twice before accepting data. A check in the checkbox indicates that redundancy is enabled (default - enabled).
- **Report Check Digit** - Transmit Code 11 data with or without the check digit. A check in the checkbox indicates to send Code 11 data with check digit (default - disabled).

- **Verify Check Digit** - Check the integrity of all Code 11 symbols to verify that the data complies with the specified check digit algorithm. This selects the check digit mechanism for the decoded Code 11 barcode.
  - **No Check Digit** - Do not verify check digit.
  - **1 Check Digit** - Bar code contains one check digit (default).
  - **2 Check Digits** - Bar code contains two check digits.

### Code128

- **Code128 Reduced Quiet Zone** - Enables decoding of margin-less Code 128 barcodes (default - disabled) (DS36X8 and RS6000 only).
- **Ignore Code128 FNC4** - When enabled, and a Code 128 barcode has an embedded FNC4 character, it will be removed from the data and the following characters will not be changed. When the feature is disabled, the FNC4 character will not be transmitted but the following character will have 128 added to it (default - disabled) (DS36X8 and RS6000 only).
- **Check ISBT Table** - The ISBT specification includes a table that lists several types of ISBT barcodes that are commonly used in pairs. If ISBT128 Concat Mode is set, enable Check ISBT Table to concatenate only those pairs found in this table. Other types of ISBT codes are not concatenated. A check in the checkbox indicates that redundancy is enabled (default - disabled).
- **Enable GS1-128** - Set the GS1 128 subtype. A check in the checkbox indicates that the option is enabled (default - enabled).
- **Enable ISBT128** - Set the ISBT128 subtype. A check in the checkbox indicates that the option is enabled (default - enabled).
- **Enabled Plain Code128** - (default - enabled).
- **ISBT128 Concatenation Mode** - Select an option for concatenating pairs of ISBT code types:
  - **Concat Mode Never** - Do not concatenate pairs of ISBT codes encountered (default).
  - **Concat Mode Always** - There must be two ISBT codes in order to decode and perform concatenation. Does not decode single ISBT symbols.
  - **Concat Mode Auto** - Decodes and concatenates pairs of ISBT codes immediately. If only a single ISBT symbol is present, the device must decode the symbol the number of times set via DataWedge Configuration 4 - 11 Redundancy - Code128 before transmitting its data to confirm that there is no additional ISBT symbol.
- **Length1** - Use to set decode lengths (default - 0). See [Decode Lengths on page 161](#) for more information.
- **Length2** - Use to set decode lengths (default - 55). See [Decode Lengths on page 161](#) for more information.
- **Redundancy** - Sets the reader to read the barcode twice before accepting data. A check in the checkbox indicates that redundancy is enabled (default - disabled).
- **Security Level** - The scanner offers four levels of decode security for Code 128 barcodes. Select increasing levels of security for decreasing levels of barcode quality. There is an inverse relationship between security and scanner aggressiveness, so choose only that level of security necessary for any given application.
  - **Security Level 0** - This setting allows the scanner to operate in its most aggressive state, while providing sufficient security in decoding most "in-spec" barcodes.
  - **Security Level 1** - This setting eliminates most misdecodes (default).
  - **Security Level 2** - Select this option if Security level 1 fails to eliminate misdecodes.
  - **Security Level 3** - If Security Level 2 is selected and misdecodes still occur, select this security level. Be advised, selecting this option is an extreme measure against mis-decoding severely out of spec barcodes. Selecting this level of security significantly impairs the decoding ability of the scanner. If this level of security is needed, try to improve the quality of the barcodes.

## Code39

- **Code39 Reduced Quiet Zone** - Enables decoding of margin-less Code 39 barcodes (default - disabled) (DS36X8 and RS6000 only).
- **Convert Code39 To Code32** - Code 32 is a variant of Code 39 used by the Italian pharmaceutical industry. Scan the appropriate barcode below to enable or disable converting Code 39 to Code 32 (default - disabled).
- **Full ASCII** - Code 39 Full ASCII is a variant of Code 39 that pairs characters to encode the full ASCII character set. To enable or disable Code 39 Full ASCII (default - disabled),
- **Length1** - Use to set decode lengths (default - 0). See [Decode Lengths on page 161](#) for more information.
- **Length2** - Use to set decode lengths 4 (default - 55). See [Decode Lengths on page 161](#) for more information.
- **Redundancy** - Sets the reader to read the barcode twice before accepting data. A check in the checkbox indicates that redundancy is enabled (default - disabled).
- **Report Check Digit** - Transmit Code 39 data with or without the check digit. A check in the checkbox indicates to send Code 39 data with check digit (default - disabled).
- **Report Code32 Prefix** - Scan the appropriate barcode to enable or disable adding the prefix character “A” to all Code 32 barcodes (default - disabled).
- **Security Level** - Options: **Security level 0**, **Security Level 1**, **Security Level 2** and **Security Level 3** (default - Security level 1).
  - **Security Level 0** - This setting allows the scanner to operate in its most aggressive state, while providing sufficient security in decoding most “in-spec” barcodes.
  - **Security Level 1** - This setting eliminates most misdecodes (default).
  - **Security Level 2** - Select this option if Security level 1 fails to eliminate misdecodes.
  - **Security Level 3** - If Security Level 2 is selected and misdecodes still occur, select this security level. Be advised, selecting this option is an extreme measure against mis-decoding severely out of spec barcodes. Selecting this level of security significantly impairs the decoding ability of the scanner. If this level of security is needed, try to improve the quality of the barcodes.
- **Verify Check Digit** - Enable this feature to check the integrity of all Code 39 symbols to verify that the data complies with a specified check digit algorithm. The digital scanner decodes only those Code 39 symbols that include a modulo 43 check digit. Enable this feature only if the Code 39 symbols contain a modulo 43 check digit (default - disabled).

## Code93

- **Length1** - Use to set decode lengths (default - 0). See [Decode Lengths on page 161](#) for more information.
- **Length2** - Use to set decode lengths (default - 55). See [Decode Lengths on page 161](#) for more information.
- **Redundancy** - Sets the reader to read the barcode twice before accepting data. A check in the checkbox indicates that redundancy is enabled (default - disabled).

## Composite AB

- **UCC Link Mode**
  - **Link Flag ignored** - 1D component is transmitted regardless of whether a 2D component is detected.
  - **Always Linked** - 1D and the 2D components are transmitted. If 2D is not present, the 1D component is not transmitted.
  - **Auto Discriminate** - the digital scanner determines if there is a 2D portion, then transmits the 1D component, as well as the 2D portion if present. (default).

## Discrete 2 of 5

- **Length1** - Use to set decode lengths (default - 0). See [Decode Lengths on page 161](#) for more information.
- **Length2** - Use to set decode lengths (default - 14). See [Decode Lengths on page 161](#) for more information.
- **Redundancy** - Sets the reader to read the barcode twice before accepting data. A check in the checkbox indicates that redundancy is enabled (default - enabled).

## GS1 DataBar Limited

- **GS1 Limited Security Level**
  - **GS1 Security Level 1** - This setting allows the scanner to operate in its most aggressive state, while providing sufficient security in decoding most “in-spec” barcodes.
  - **GS1 Security Level 2** - This setting eliminates most misdecodes (default).
  - **GS1 Security Level 3** - Select this option if Security level 2 fails to eliminate misdecodes.
  - **GS1 Security Level 4** - If Security Level 3 is selected and misdecodes still occur, select this security level. Be advised, selecting this option is an extreme measure against mis-decoding severely out of spec barcodes. Selecting this level of security significantly impairs the decoding ability of the scanner. If this level of security is needed, try to improve the quality of the barcodes.

## HAN XIN

- **HAN XIN Inverse (DS36X8 and RS6000 only)**
  - **Disable** - Disables decoding of HAN XIN inverse barcodes (default).
  - **Enable** - Enables decoding of HAN XIN inverse barcodes.
  - **Auto** - Decodes both HAN XIN regular and inverse barcodes.

## Interleaved 2 of 5

- **Check Digit**
  - **No Check Digit** - A check digit is not used (default).
  - **USS Check Digit** - Select to check the integrity of all Interleaved 2 of 5 symbols to verify the data complies with either the Uniform Symbology Specification (USS) check digit algorithm.
  - **OPCC Check Digit** - Select to check the integrity of all Interleaved 2 of 5 symbols to verify the data complies with either the Optical Product Code Council (OPCC) check digit algorithm.
- **Length1** - Use to set decode lengths (default - 6). See [Decode Lengths on page 161](#) for more information.
- **Length2** - Use to set decode lengths (default - 55). See [Decode Lengths on page 161](#) for more information.
- **Redundancy** - Sets the reader to read the barcode twice before accepting data. A check in the checkbox indicates that redundancy is enabled (default - enabled).

- **Report Check Digit** - Transmit Interleaved 2 of 5 data with or without the check digit. A check in the checkbox indicates to send Interleaved 2 of 5 data with check digit (default - disabled).
- **I2of5 Security Level** - Options: **I2of5 Security level 0**, **I2of5 Security Level 1**, **I2of5 Security Level 2** and **I2of5 Security Level 3** (default - I2of5 Security level 1).
- **Convert ITF-14 To EAN13** - Convert 14-character Interleaved 2 of 5 barcodes to EAN-13, and transmit as EAN-13. The Interleaved 2 of 5 barcode must be enabled and must have a leading zero and a valid EAN-13 check digit. A check in the checkbox indicates that the option is enabled (default - disabled).
- **I2of5 Reduced Quiet Zone** - Enables decoding of margin-less I2of5 barcodes (default - disabled).

### Matrix 2 of 5

- **Length1** - Use to set decode lengths (default - 10). See [Decode Lengths on page 161](#) for more information.
- **Length2** - Use to set decode lengths (default - 0). See [Decode Lengths on page 161](#) for more information.
- **Redundancy** - Sets the reader to read the barcode twice before accepting data. A check in the checkbox indicates that redundancy is enabled (default - disabled).
- **Report Check Digit** - Transmit Matrix 2 of 5 data with or without the check digit. A check in the checkbox indicates to send Matrix 2 of 5 data with check digit (default - enabled).
- **Verify Check Digit** - Enable this feature to check the integrity of all Matrix 2 of 5 symbols to verify that the data complies with a specified check digit algorithm (default - enabled).

### MSI

- **Check Digit** - With MSI symbols, one check digit is mandatory and always verified by the reader. The second check digit is optional.
  - **One Check Digit** - Verify one check digit (default).
  - **Two Check Digits** - Verify two check digits.
- **Check Digit Scheme** - Two algorithms are possible for the verification of the second MSI check digit. Select the algorithm used to encode the check digit.
  - **Mod-11-10** - First check digit is MOD 11 and second check digit is MOD 10 (default).
  - **Mod-10-10** - Both check digits are MOD 10.
- **Length 1** - Use to set decode lengths (default - 4). See [Decode Lengths on page 161](#) for more information.
- **Length 2** - Use to set decode lengths (default - 55). See [Decode Lengths on page 161](#) for more information.
- **Redundancy** - Sets the reader to read the barcode twice before accepting data. A check in the checkbox indicates that redundancy is enabled (default - enabled).
- **Report Check Digit** - Transmit MSI data with or without the check digit. A check in the checkbox indicates to send MSI data with check digit (default - disabled).

### Trioptic 39

- **Redundancy** - Sets the reader to read the barcode twice before accepting data. A check in the checkbox indicates that redundancy is enabled (default - enabled) (DS36X8 and RS6000 only).

### UK Postal

- **Report Check Digit** - Transmit UK Postal data with or without the check digit. A check in the checkbox indicates to send UK Postal data with check digit (default - disabled).

## UPCA

- **Preamble** - Preamble characters are part of the UPC symbol consisting of Country Code and System Character. Select the appropriate option to match the host system.  
There are three options for transmitting a UPCA preamble:
  - **Preamble None** - Transmit no preamble.
  - **Preamble Sys Char** - Transmit System Character only (default).
  - **Preamble Country and Sys Char** - Transmit System Character and Country Code ("0" for USA). Select the appropriate option to match the host system.
- **Report Check Digit** - The check digit is the last character of the symbol used to verify the integrity of the data. Enables or disables this option. A check in the checkbox indicates that the option is enabled (default - enabled).

## UPCE0

- **Convert UPCE0 To UPCA** - Enable to convert UPCE0 (zero suppressed) decoded data to UPC-A format before transmission. After conversion, the data follows UPC-A format and is affected by UPC-A programming selections. Disable to transmit UPCE0 decoded data as UPCE0 data, without conversion (default - disabled).
- **Preamble** - Preamble characters are part of the UPC symbol consisting of Country Code and System Character. Select the appropriate option to match the host system.  
There are three options for transmitting a UPCE0 preamble:
  - **Preamble Sys Char** - Transmit System Character only.
  - **Preamble Country and Sys Char** - Transmit System Character and Country Code ("0" for USA).
  - **Preamble None** - Transmit no preamble (default).
- **Report Check Digit** - The check digit is the last character of the symbol used to verify the integrity of the data. Enables or disables this option. A check in the checkbox indicates that the option is enabled (default - disabled).

## UPCE1

- **Convert UPCE1 To UPCA** - Enable this to convert UPCE1 decoded data to UPC-A format before transmission. After conversion, the data follows UPC-A format and is affected by UPC-A programming selections. Disable this to transmit UPCE1 decoded data as UPCE1 data, without conversion (default - disabled).
- **Preamble** - Preamble characters are part of the UPC symbol consisting of Country Code and System Character. Select the appropriate option to match the host system.  
There are three options for transmitting a UPCE1 preamble:
  - **Preamble Sys Char** - Transmit System Character only.
  - **Preamble Country and Sys Char** - Transmit System Character and Country Code ("0" for USA).
  - **Preamble None** - Transmit no preamble (default).
- **Report Check Digit** - The check digit is the last character of the symbol used to verify the integrity of the data. Enables or disables this option. A check in the checkbox indicates that the option is enabled (default - disabled).



## US Planet

- **Report Check Digit** - The check digit is the last character of the symbol used to verify the integrity of the data. Enables or disables this option. A check in the checkbox indicates that the option is enabled (default - disabled).

## Decode Lengths

- The allowable decode lengths are specified by options **Length1** and **Length2** as follows:
- Variable length: Decode symbols containing any number of characters.
  - Set both **Length1** and **Length2** to 0.
- Range: Decode a symbol with a specific length range (from *a* to *b*, including *a* and *b*).
  - Set **Length1** to *a* and set **Length2** to *b*.
- Two Discrete Lengths: Decode only symbols containing either of two selected lengths.
  - Set both **Length1** or **Length2** to the specific lengths. **Length1** must be greater than **Length2**.
- One Discrete Length: Decode only symbols containing a specific length.
  - Set both **Length1** and **Length2** to the specific length.

## UPC EAN Params

Allows the configuration of the parameters that apply to more than one UPC or EAN decoder.

- **Convert DataBar To UPC EAN** - If this is set it converts DataBar barcodes to UPC/EAN format. For this setting to work UPC/EAN symbologies must be enabled. A check in the checkbox indicates that the option is enabled (default - disabled).
- **UPC Reduced Quiet Zone** - Enables decoding of margin-less UPC barcodes (default - disabled) (DS36X8 and RS6000 only).
- **Bookland** - Enable Bookland decoding. A check in the checkbox indicates that the option is enabled (default - disabled).
- **Bookland Format** - If Bookland EAN is enabled, select one of the following formats for Bookland data:
  - **Format ISBN-10** - The decoder reports Bookland data starting with 978 in traditional 10-digit format with the special Bookland check digit for backward-compatibility. Data starting with 979 is not considered Bookland in this mode. (default)
  - **Format ISBN-13** - The decoder reports Bookland data (starting with either 978 or 979) as EAN-13 in 13-digit format to meet the 2007 ISBN-13 protocol.
- **Coupon** - Enables Coupon code decoding. Note that in order to successfully decode Coupon codes, all of the correct decoders must be enabled. A check in the checkbox indicates that the option is enabled (default - disabled).
- **Coupon Report Mode** - Traditional coupon symbols are composed of two barcode: UPC/EAN and Code 128. A new coupon symbol is composed of a single Data Expanded barcode. The new format offers more options for purchase values (up to \$999.999) and supports complex discount offers as a second purchase requirement. An interim coupon symbol also exists that contain both types of barcodes: UPC/EAN and

Databar Expanded. This format accommodates both retailers that do not recognize or use the additional information included in the new coupon symbol, as well as those who can process new coupon symbols.

- **Old Coupon Report Mode** - Scanning an old coupon symbol reports both UPC and Code 128, scanning an interim coupon symbol reports UPC, and scanning a new coupon symbol reports nothing (no decode).
- **New Coupon Report Mode** - Scanning an old coupon symbol reports either UPC or Code 128, and scanning an interim coupon symbol or a new coupon symbol reports Databar Expanded.
- **Both Coupon Report Modes** - Scanning an old coupon symbol reports both UPC and Code 128, and scanning an interim coupon symbol or a new coupon symbol reports Databar Expanded (default).
- **Ean Zero Extended** – Enable this parameter to add five leading zeros to decoded EAN-8 symbols to make them compatible in format to EAN-13 symbols. Disable this to transmit EAN-8 symbols as is. Default – disabled.
- **Linear Decode** - This option applies to code types containing two adjacent blocks (e.g., UPC-A, EAN-8, EAN-13). Enable this parameter to transmit a barcode only when both the left and right blocks are successfully decoded within one laser scan. Enable this option when barcodes are in proximity to each other (default - enabled).
- **Retry Count** - Retry count for auto-discriminating for supplementals. Possible values are 2 to 20 inclusive. Note that this flag is only considered if Supplemental Mode - UPC EAN is set to one of the following values: **Supplementals Auto**, **Supplementals Smart**, **Supplementals 378-379**, **Supplementals 978-979**, **Supplementals 977** or **Supplementals 414-419-434-439** (2 to 20, default 10).
- **Security Level** - The scanner offers four levels of decode security for UPC/EAN barcodes. Select higher security levels for lower quality barcodes. There is an inverse relationship between security and decode speed, so be sure to choose only that level of security necessary for the application.
  - **Level 0** - This default setting allows the scanner to operate fastest, while providing sufficient security in decoding “in-spec” UPC/EAN barcodes.
  - **Level 1** - As barcode quality levels diminish, certain characters become prone to misdecodes before others (i.e., 1, 2, 7, 8). If the scanner is misdecoding poorly printed barcodes, and the misdecodes are limited to these characters, select this security level (default).
  - **Level 2** - If the scanner is misdecoding poorly printed barcodes, and the misdecodes are not limited to characters 1, 2, 7, and 8, select this security level.
  - **Level 3** - If the scanner is still misdecoding, select this security level. Be advised, selecting this option is an extreme measure against misdecoding severely out of spec barcodes. Selecting this level of security can significantly impair the decoding ability of the scanner. If this level of security is necessary, try to improve the quality of the barcodes.
- **Supplemental2** - Enables or disables this option. A check in the checkbox indicates that the option is enabled.
- **Supplemental5** - Enables or disables this option. A check in the checkbox indicates that the option is enabled.
- **Supplemental Mode**
  - **No Supplementals** - the scanner is presented with a UPC/EAN plus supplemental symbol, the scanner decodes UPC/EAN and ignores the supplemental characters (default).
  - **Supplemental Always** - the scanner only decodes UPC/EAN symbols with supplemental characters, and ignores symbols without supplementals.
  - **Supplementals Auto** - the scanner decodes UPC/EAN symbols with supplemental characters immediately. If the symbol does not have a supplemental, the scanner must decode the barcode the

number of times set via UPC/EAN Supplemental Redundancy before transmitting its data to confirm that there is no supplemental.

- **Supplemental Smart** - Enables smart supplementals. In this mode the decoder returns the decoded value of the main block right away if it does not belong to one of the following supplemental types: 378, 379, 977, 978, 979, 414, 419, 434 or 439. If the barcode starts with one of the prefixes it searches the image more aggressively for a supplemental. Tries to scan the supplemental if it is present. If the supplemental scanning failed, then the main barcode is returned.
- **Supplemental 378-379** - Enables (auto-discriminate) supplemental for UPC/EAN codes starting with 378 or 379. Disables reading of supplementals for any other UPC/EAN barcode not starting with 378 or 379. Tries to scan the supplemental if it is present. If the supplemental scanning failed, then the main barcode is returned.
- **Supplemental 978-979** - Enables (auto-discriminate) supplemental for UPC/EAN codes starting with 978 or 979. Disables reading of supplementals for another UPC/EAN barcode not starting with 978 or 979. Tries to scan the supplemental if it is present. If the supplemental scanning failed, then the main barcode is returned.
- **Supplemental 414-419-434-439** - Enables (auto-discriminate) supplemental for UPC/EAN codes starting with 414, 419, 434 or 439. Disables reading of supplementals for another UPC/EAN barcode 4 - 16 not starting with 414, 419, 434 or 439. Tries to scan the supplemental if it is present. If the supplemental scanning failed, then the main barcode is returned.
- **Supplemental 977** - Enables (auto-discriminate) supplemental for UPC/EAN codes starting with 977. Disables reading of supplementals for another UPC/EAN barcode not starting with 977. Tries to scan the supplemental if it is present. If the supplemental scanning failed, then the main barcode is returned.

## Reader Params

Allows the configuration of parameters specific to the selected barcode reader.

- **1D Quiet Zone Level** - Sets the level of aggressiveness in decoding barcodes with a reduced quiet zone (the area in front of and at the end of a barcode), and applies to symbologies enabled by a Reduced Quiet Zone parameter. Because higher levels increase the decoding time and risk of misdecodes, Zebra strongly recommends enabling only the symbologies which require higher quiet zone levels, and leaving Reduced Quiet Zone disabled for all other symbologies (DS36X8 only).

Options are:

- **0** - The scanner performs normally in terms of quiet zone.
- **1** - The scanner performs more aggressively in terms of quiet zone (default).
- **2** - The scanner only requires one side EB (end of barcode) for decoding.
- **3** - The scanner decodes anything in terms of quiet zone or end of barcode.
- **Aim mode** - Turns the scanner cross-hairs on or off.
  - **On** - Cross-hair is on (default).
  - **Off** - Cross-hair is off.

- **Character Set Selection**
  - **ISO-88959-1** - part of the ISO/IEC 8859 series of ASCII-based standard character encodings. It is generally intended for Western European languages.
  - **Shift\_JIS** - Shift Japanese Industrial Standards (JIS) is a character encoding for the Japanese language.
  - **GB18030** - a Chinese government standard, that defines the required language and character support necessary for software in China.
  - **UTF-8** - A character encoding capable of encoding all possible characters, or code points, defined by Unicode (default).
- **Time Delay to Low Power** - Sets the time the decoder remains active after decoding. After a scan session, the decoder waits this amount of time before entering Low Power Mode. Options: **1 Second** (default), **30 Seconds**, **1 Minute** or **5 Minutes**.
- **Illumination Brightness** - Sets the brightness of the illumination by altering LED power. The default is 10, which is maximum LED brightness. For values from 1 to 10, LED brightness varies from lowest to highest level of brightness.
- **Illumination mode** - Turns imager illumination on and off. This option is only available when **Bluetooth Scanner** is selected in the **Barcode input, Scanner selection** option.
  - **On** - Illumination is on (default).
  - **Off** - Illumination is off.
- **Inverse 1D Mode** - This parameter allows the user to select decoding on inverse 1D barcodes.
  - **Disable** - Disables decoding of inverse 1D barcodes (default).
  - **Enable** - Enables decoding of only inverse 1D barcodes.
  - **Auto** - Allows decoding of both twice positive and inverse 1D barcodes.
- **Keep Pairing Info After Reboot (DS3678 only)**
  - **Disable** - Disables the ability to keep pairing info after reboot.
  - **Enable** - Enables the ability to keep pairing info after reboot. (default).
- **LCD Mode** - Enables or disables LCD mode. LCD mode enhances the ability of the imager to read barcodes from LCD displays such as cellphones (DS36X8 only).
  - **Disable** - Disables the LCD mode (default).
  - **Enable** - Enables LCD mode.
- **Picklist** - Allows the imager to decode only the barcode that is directly under the cross-hair/reticle (+) part of the pattern. This feature is useful in applications where multiple barcodes may appear in the field of view during a decode session and only one of them is targeted for decode.
  - **Disabled** – Disables Picklist mode. Any barcode within the field of view can be decoded (default).
  - **Enabled** – Enables Picklist mode so that only the barcode under the projected reticle can be decoded.

- **Aim Type** - Set the aiming usage.
  - **Trigger** - A trigger event activates decode processing, which continues until the trigger event ends or a valid decode occurs (default).
  - **Timed Hold** - A trigger pull and hold activates the laser for aiming, which continues until the trigger is released, a valid decode, or the decode session time-out is expired.
  - **Timed Release** - A trigger pull activates the laser for aiming, which continues until a valid decode or the remaining decode session time has expired.
  - **Press and Release** - A trigger pull and release activates the laser for aiming, which continues until a trigger is pressed again, a valid decode, or the decode session time-out is expired.
  - **Continuous Read** - When the imager detects an object in its field of view, it triggers and attempt to decode.
- **Beam Timer** - Sets the maximum amount of time that the reader remains on (0 - 60,000 ms in increments of 100 ms). A value of 0 sets the reader to stay on indefinitely (default - 5000).
- **Different Symbol Timeout** - Controls the time the scanner is inactive between decoding different symbols. Programmable in 500 msec increments from 0 to 5 seconds. The default is 500 msec.
- **Same Symbol Timeout** - Controls the time the scanner is inactive between decoding same symbols. Programmable in 500 msec increments from 0 to 5 seconds. The default is 500 msec.

## Scan Params

Allows the configuration of Code ID and decode feedback options.

- **Code ID Type** - A Code ID character identifies the code type of a scanned barcode. This is useful when the reader is decoding more than one code type. Select a code ID character to insert between the prefix and the decoded symbol.
  - **Code ID Type None** - No prefix (default)
  - **Code ID Type AIM** - Insert AIM Character prefix.
  - **Code ID Type Symbol** - Insert Symbol character prefix.
- **Engine Decode LED** - Use to turn on scanner red LED when the scan beam is emitting either by scanner trigger or using soft scan button (RS507/RS507x only).
- **BT Disconnect On Exit** - Bluetooth connection is disconnected when data capture application is closed (Default - disabled) (RS507/RS507x, RS6000 and DS3678 only).
- **Connection Idle Time** - Set connection idle time. The Bluetooth connection disconnects after being idle for set time (Default - 600) (RS507/RS507x, RS6000 and DS3678 only).
- **Decode Haptic Feedback** - Enable the device to vibrate upon a good decode (default - disabled).
- **Display BT Address Barcode** - Enable or disable displaying Bluetooth Address barcode if there is no Bluetooth scanner being paired when application tries to enable the Bluetooth scanner (Default - enabled) (RS507/RS507x and RS6000 only).
- **Establish Connection Time** - The timeout which the device will try to enable or reconnect to the Bluetooth scanner when the Bluetooth scanner is not in the vicinity or not paired (Default - 45) (RS507/RS507x and RS6000 only).
- **Audio Feedback Mode** - Select good decode audio indication.
  - **Local Audio Feedback** - Good decode audio indication on the device only.
  - **Remote Audio Feedback** - Good decode audio indication on scanner only.
  - **Both** - Good decode audio indication on the device and scanner (default).
  - **Disable** - No good decode audio indication on either device or scanner.

- **LED Feedback Mode** - Select good decode LED indication.
  - **Local LED Feedback** - Good decode LED indication on device only. (CHECK)
  - **Remote LED Feedback** - Good decode LED indication on scanner only (default on DS36X8).
  - **Both** - Good decode LED indication on the Bluetooth scanner (default) NOT ON DS36X8).
  - **Disable** - No good decode LED indication on either the device or scanner.
- **Decode Audio Feedback** - Select an audio tone to sound upon a good decode (Default - optimized beep).
- **Decoding LED Notification** - Enable the device to light the red Data Capture LED when data capture is in progress. (default - disabled).
- **Decode Feedback LED Timer** - Set the amount of time (in milliseconds) that the green Data Capture LED stays lit after a good decode. (default - 75 msec.)
- **Beep Volume Channel** - Set the good decode beep to a system or other sound. This allows for independent control of the good beep volume.



**NOTE** Not all ringtones are fully supported as decode tones and those of longer length may be truncated when used as a decode tone. The recommendation is to test the selected tone for operation before deployment to a customer site.

- **Ringer** - Set the good decode beep to the ringer sound.
- **Music and Media** - Set the good decode beep to the media sound.
- **Alarms** - Set the good decode beep to the alarm sound.
- **Notifications** - Set the good decode beep to the notification sound (default).

## UDI Parameters

Disabled

## Keep Enabled on Suspend

Keep the Bluetooth scanner enabled after suspend (default - disabled).

## Serial Port Input from Serial Port 1

Use to configure an RS-232 scanner connected to COM Port 1.

- **Enabled** - Touch checkbox to enable scanner input from COM port 1.
- **Serial Port Configuration** - Use to configure COM port settings. For Zebra scanners, correct settings are set as default.
  - **Baud rate** - Select baud rate for scanner (default - 9600).
  - **Data bits** - Select data bits for scanner. Options: **7**, or **8** (default)
  - **Parity** - Select data bits for scanner. Options: **None** (default), **Odd**, **Even**, **Mark**, or **Space**.
  - **Stop bits** - Select data bits for scanner. Options: **1** (default), or **2**.

## Serial Port Input from Serial Port 2

Use to configure an RS-232 scanner connected to COM Port 2.

- **Enabled** - Touch checkbox to enable scanner input from COM port 2.

- **Serial Port Configuration** - Use to configure COM port settings. For Zebra scanners, correct settings are set as default.
  - **Baud rate** - Select baud rate for scanner (default - 9600).
  - **Data bits** - Select data bits for scanner. Options: **7**, or **8** (default)
  - **Parity** - Select data bits for scanner. Options: **None** (default), **Odd**, **Even**, **Mark**, or **Space**.
  - **Stop bits** - Select data bits for scanner. Options: **1** (default), or **2**.

## Keystroke Output

Use to configure the Keystroke Output Plug-in for the profile.

- **Enabled** — Enables or disables this plug-in. A check in the checkbox indicates that the plug-in is enabled (default - enabled).
- **Action key character** - Enables decoding of a special character embedded within a barcode data for use in native Android applications. This feature is helpful when populating or executing a form.
  - **None** - Action key character feature is disabled (default).
  - **Tab** - Tab character code in a barcode is processed. When DataWedge detects this character code in a barcode, move the focus to the next field.
  - **Line feed** - Line feed character code in a barcode is processed. When DataWedge detects this character code in a barcode, move the focus to the next field.
  - **Carriage return** - Carriage return character code in a barcode is processed. When DataWedge detects this character code in a barcode, move the focus to the next field.
- **Multi byte character display** - Set the amount of time (in milliseconds) of the inter character delay for multi byte characters. (default - 0.)
- **Key event delay** - Set the amount of time (in milliseconds) a delay for dispatching control characters as keystrokes to the foreground application (default - 0).
- **Token selection** - UDI Token selection and ordering keystroke output.
  - **Send tokens**
    - **Disabled** - By default, token selection plugin is disabled. In this configuration, it will not change the data dispatching compared to existing operation (default).
    - **Tokens only** - In the Tokens only mode the DataWedge parses the UDI output and break it to individual tokens and it will dispatch the tokens.
    - **Barcodes and tokens** - In Barcodes and tokens mode DataWedge will send the barcode string first and the tokenized data amended to it. So, if there is no separator (see below) selected it will dispatch two instances of same data.
  - **Token separator** - Option is enabled only if the send tokens option is not in disabled state. The user can select the separator character that is sent with the data. Available options are shown below. The same character will be sent for separating the barcode section and token section if both are sent. Options: **None** (default), **Tab**, **Line Feed** or **Carriage Return**.
  - **Token order** - With this configuration user, can change the order of token dispatching and select which tokens should be dispatched.

Note: Token selection depends on the mode of decoding. Therefore, user must enable UDI from Single/UDI parameter in scanning modes option in reader parameters of scanner, in single mode, Token selection plugin will not have any effect.

- **Advanced data formatting** - is a way to customizing data before transmission. Use advanced data formatting (ADF) to edit scan data to suit requirements.
  - **Enable** - Enables or disables ADF. A check in the checkbox indicates that ADF is enabled (default - disabled).
  - **Rules** - ADF uses rules to customize data. These rules perform detailed actions when the data meets certain criteria. One rule may consist of single or multiple criteria applied to single or multiple actions. See [Generating Advanced Data Formatting Rules on page 174](#) for more information.
- **Basic data formatting** - Allows the configuration of any data formatting for the related Output Plug-in. When the plug-in is disabled, any data is passed on without modification.
  - **Enabled** - Enables or disables Basic Data Formatting. A check in the checkbox indicates that it is enabled (default - enabled).
  - **Prefix to data** - Add characters to the beginning of the data when sent.
  - **Suffix to data** - Add characters to the end of the data when sent.
  - **Send data** - Set to transfer the captured data to the foreground application. Disabling this option prevents the actual data from being transmitted. However, the prefix and suffix strings, if present, are still transmitted even when this option is disabled (default - enabled).
  - **Send as hex** - Set to send the data in hexadecimal format. A check in the checkbox indicates that the plug-in is enabled (default - disabled).
  - **Send TAB key** - Set to append a tab character to the end of the processed data. A check in the checkbox indicates that the plug-in is enabled (default - disabled).
  - **Send ENTER key** - Set to append an Enter character to the end of the processed data. A check in the checkbox indicates that the plug-in is enabled (default - disabled).

## Intent Output

Allows configuration of the Intent Output Plug-in for the profile. The Intent Output Plug-in allows the captured data to be sent to an application in the form of an implicit Intent. Refer to the Android Developer web site for more information, [developer.android.com](http://developer.android.com).

- **Enabled** - Enables or disables this plug-in. A check in the checkbox indicates that the plug-in is enabled (default - disabled).
- **Intent action** - Enter the Intent Action name (required).
- **Intent category** - Enter the Intent Category name (required).
- **Intent delivery** - Select the method by which the intent is delivered:
  - Send via StartActivity (default)
  - Send via startService
  - Broadcast intent
- **Receiver foreground flag** - (disabled)
- **Advanced data formatting** - is a way to customizing data before transmission. Use advanced data formatting (ADF) to edit scan data to suit requirements.
  - **Enable** - Enables or disables ADF. A check in the checkbox indicates that ADF is enabled (default - disabled).
  - **Rules** - ADF uses rules to customize data. These rules perform detailed actions when the data meets certain criteria. One rule may consist of single or multiple criteria applied to single or multiple actions. See [Generating Advanced Data Formatting Rules on page 174](#) for more information.



- **Basic data formatting** - Allows configuration of any data formatting for the related Output Plug-in. When the plug-in is disabled any data is passed on without modification.
  - **Enabled** - Enables or disables Basic Data Formatting. A check in the checkbox indicates that it is enabled (default - enabled).
  - **Prefix to data** - Add characters to the beginning of the data when sent.
  - **Suffix to data** - Add characters to the end of the data when sent.
  - **Send data** - Set to transfer the captured data to the foreground application. Disabling this option prevents the actual data from being transmitted. However, the prefix and suffix strings, if present, are still transmitted even when this option is disabled (default - enabled).
  - **Send as hex** - Set to send the data in hexadecimal format. A check in the checkbox indicates that the plug-in is enabled (default - disabled).
  - **Send TAB key** - Set to append a tab character to the end of the processed data. A check in the checkbox indicates that the plug-in is enabled (default - disabled).
  - **Send ENTER key** - Set to append an Enter character to the end of the processed data. A check in the checkbox indicates that the plug-in is enabled (default - disabled).

## Intent Overview

The core components of an Android application (its activities, services, and broadcast receivers) are activated by intents. An intent is a bundle of information (an Intent object) describing a desired action - including the data to be acted upon, the category of component that should perform the action, and other pertinent instructions. Android locates an appropriate component to respond to the intent, launches a new instance of the component if one is needed, and passes it the Intent object.

Components advertise their capabilities, the kinds of intents they can respond to, through intent filters. Since the system must learn which intents a component can handle before it launches the component, intent filters are specified in the manifest as `<intent-filter>` elements. A component may have any number of filters, each one describing a different capability. For example, if the manifest contains the following:

```
<intent-filter . . . >
<action android:name="android.intent.action.DEFAULT" />
<category android:name="android.intent.category.MAIN" />
</intent-filter>
```

In the Intent output plug-in configuration, the **Intent action** would be:

```
android.intent.category.DEFAULT
```

and the Intent category would be:

```
android.intent.category.MAIN.
```

The **Intent delivery** option allows the method by which the intent is delivered to be specified. The delivery mechanisms are **Send via startActivity**, **Send via startService** or **Broadcast intent**.

The decode related data added to the Intent's bundle can be retrieved using the `Intent.getStringExtra()` and `Intent.getSerializableExtra()` calls, using the following String tags:

- String LABEL\_TYPE\_TAG = "com.symbol.emdk.datawedge.label\_type";
  - String contains the label type of the barcode.

- String `DATA_STRING_TAG` = “com.symbol.emdk.datawedge.data\_string”;
  - String contains the output data as a String. In the case of concatenated barcodes, the decode data is concatenated and sent out as a single string.
- String `DECODE_DATA_TAG` = “com.symbol.emdk.datawedge.decode\_data”;
  - Decode data is returned as a list of byte arrays. In most cases there will be one byte array per decode. For barcode symbologies that support concatenation e.g. Codabar, Code128, MicroPDF, etc., the decoded data is stored in multiple byte arrays (one byte array per barcode). Clients can get data in each byte array by passing an index.

Most scanning applications might want the user to be able to decode data and for that decode data to be sent to the **\*current\*** activity but not necessarily displayed. If this is the case, then the activity needs to be marked as 'singleTop' in its AndroidManifest.xml file. If your activity is not defined as singleTop, then on every decode, the system will create another copy of your Activity and send the decode data to this second copy.

Finally there will be a configuration option for each process plug-in so that the process plug-in can be configured specifically for the intent output, which in this case is the basic data formatting process plug-in.

## IP Output



**NOTE** IPWedge application is required on a host computer. Download the IPWedge application from the Support Central web site: [www.zebra.com/support](http://www.zebra.com/support).

IP Output allows DataWedge to send captured data to a host computer via a network connection. Captured data can be sent over an IP network to a specified IP address and port using either TCP or UDP transport protocols.

- **Enabled** - Enables or disables this plug-in. A check in the checkbox indicates that the plug-in is enabled (default - disabled).
- **Remote Wedge** - Enable or disable the Remote Wedge option (default - enabled). Remote Wedge is used with the IPWedge application.
- **Protocol** - Select the protocol used by the remote application. Options: **TCP** (default) or **UDP**.
- **IP address** - Enter the IP address used by the remote application (default - 0.0.0.0).
- **Port** - Enter the port number used by the remote application (default - 58627).
- **Token selection** - UDI Token selection and ordering keystroke output.
  - **Send tokens**
    - **Disabled** - By default, token selection plugin is disabled. In this configuration, it will not change the data dispatching compared to existing operation (default).
    - **Tokens only** - In the Tokens only mode the DataWedge parses the UDI output and break it to individual tokens and it will dispatch the tokens.
    - **Barcodes and tokens** - In Barcodes and tokens mode DataWedge will send the barcode string first and the tokenized data amended to it. So, if there is no separator (see below) selected it will dispatch two instances of same data.
  - **Token separator** - Option is enabled only if the send tokens option is not in disabled state. The user can select the separator character that is sent with the data. Available options are shown below. The

same character will be sent for separating the barcode section and token section if both are sent. Options: **None** (default), **Tab**, **Line Feed** or **Carriage Return**.

- **Token order** - With this configuration user, can change the order of token dispatching and select which tokens should be dispatched.

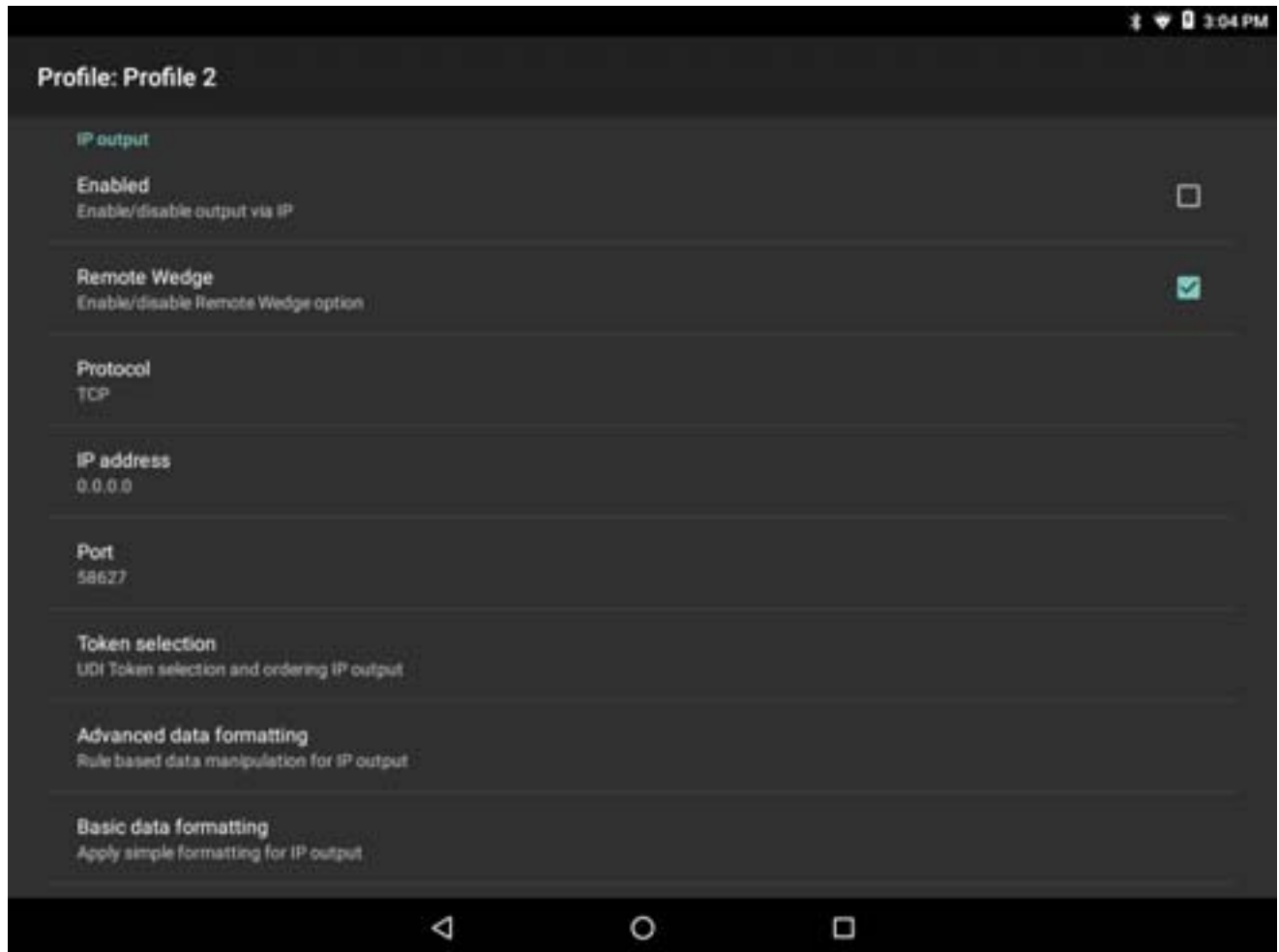
Note: Token selection depends on the mode of decoding. Therefore, user must enable UDI from Single/UDI parameter in scanning modes option in reader parameters of scanner, in single mode, Token selection plugin will not have any effect.

- **Advanced data formatting** - is a way of customizing data before transmission. Use advanced data formatting (ADF) to edit scan data to suit requirements.
  - **Enable** - Enables or disables ADF. A check in the checkbox indicates that ADF is enabled (default - disabled).
  - **Rules** - ADF uses rules to customize data. These rules perform detailed actions when the data meets certain criteria. One rule may consist of single or multiple criteria applied to single or multiple actions. See [Generating Advanced Data Formatting Rules on page 174](#) for more information.
- **Basic data formatting** - Allows configuration of any data formatting for the related Output Plug-in. When the plug-in is disabled any data is passed on without modification.
  - **Enabled** - Enables or disables Basic Data Formatting. A check in the checkbox indicates that it is enabled (default - enabled).
  - **Prefix to data** - Add characters to the beginning of the data when sent.
  - **Suffix to data** - Add characters to the end of the data when sent.
  - **Send data** - Set to transfer the captured data to the foreground application. Disabling this option prevents the actual data from being transmitted. However, the prefix and suffix strings, if present, are still transmitted even when this option is disabled (default - enabled).
  - **Send as hex** - Set to send the data in hexadecimal format. A check in the checkbox indicates that the plug-in is enabled (default - disabled).
  - **Send TAB key** - Set to append a tab character to the end of the processed data. A check in the checkbox indicates that the plug-in is enabled (default - disabled).
  - **Send ENTER key** - Set to append an Enter character to the end of the processed data. A check in the checkbox indicates that the plug-in is enabled (default - disabled).

## Usage

This section provides information on how to configure IP Output using the DataWedge configuration user interface. To use IP Output in a particular DataWedge profile (for example: **Profile0**), scroll downward on **IP Output**.

Figure 103 IP Output Screen



## Using IP Output with IPWedge

IPWedge is a computer application that can be easily configured to retrieve data sent over network by DataWedge IP Output. Refer to the *IPWedge User Manual* on how to install and configure in a host computer. To enable IP Output to send captured data to a remote computer that is installed with IPWedge:

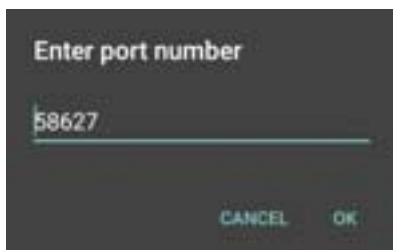
1. In **IP Output**, touch **Enabled**.  
A check appears in the checkbox.
2. Ensure **Remote Wedge** option is enabled.
3. Touch **Protocol**.
4. In the **Choose protocol** dialog box, touch the same protocol selected for the IPWedge computer application. (TCP is the default).

**Figure 104** Protocol Selection

5. Touch **IP Address**.
6. In the **Enter IP Address** dialog box, enter the IP address of host computer to send data to.

**Figure 105** IP Address Entry

7. Touch **Port**.
8. In the **Enter port number** dialog box, enter same port number selected for IPWedge computer application.

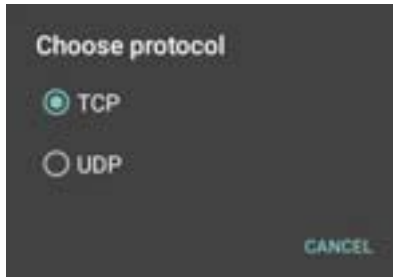
**Figure 106** Port Number Entry

9. Configure **Advanced data formatting** and **Basic data formatting** Plug-in if any required modification to be done to captured data before sending to remote computer.

## Using IP Output without IPWedge

IP Output Plug-in can be used to send captured data from DataWedge to a remote device or host computer without using IPWedge. At the data receiving end, the host computer or mobile device should have an application, that listens to TCP or UDP data coming from a configured port and IP address in the IP Output plug-in. To enable IP Output to send captured data to a remote computer:

1. In **IP Output**, touch **Enabled**.  
A check appears in the checkbox.
2. Ensure **Remote Wedge** option is disabled.
3. Touch **Protocol**.
4. In the **Choose protocol** dialog box, touch the same protocol selected in the client application. (TCP is the default).

**Figure 107** Protocol Selection

5. Touch **IP Address**.

6. In the **Enter IP address** dialog box, enter the IP address of host computer to send data to.

**Figure 108** IP Address Entry

7. Touch **Port**.

8. In the **Enter port number** dialog box, enter the port number that the host computer application is listening on.

**Figure 109** Port Number Entry

9. Configure **Advanced Data Formatting** and **Basic Data Formatting** Plug-in if any required modification to be done to captured data before sending to remote computer.

---


## Generating Advanced Data Formatting Rules

The ADF plug-in applies rules (actions to be performed based on defined criteria) to the data received via an input plug-in before sending it to the output plug-in.

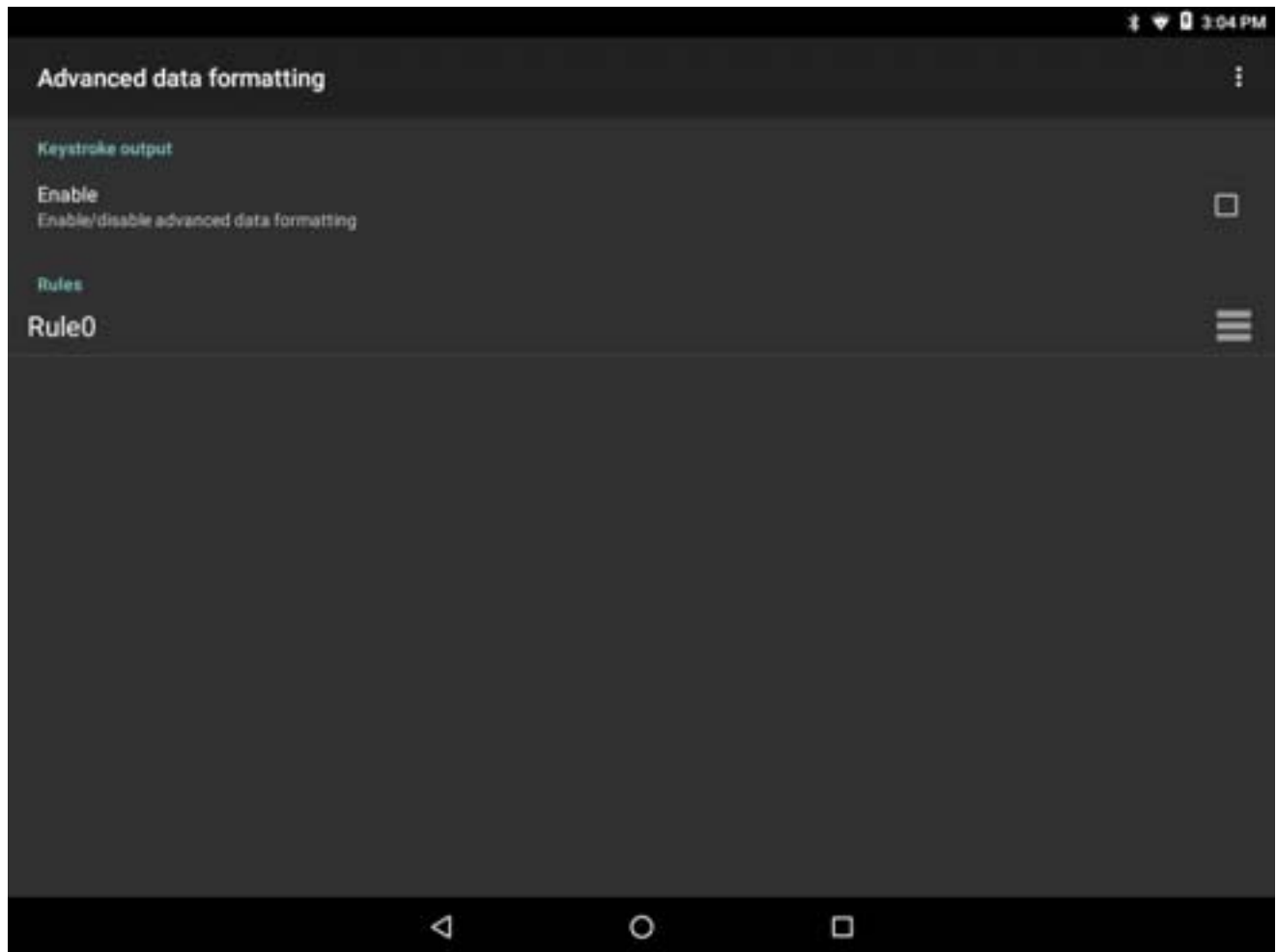
- **Rules** - The ADF process plug-in consists of one or more rules. DataWedge formats the output data according to the first matching rule. A rule is a combination of criteria and a set of actions to be performed, upon fulfillment of the criteria set in the rule.
- **Criteria** - Criteria can be set according to Input plug-in, symbology, matching string within the data (at the specified position) and/or data length. Received data must match the defined criteria in order for the data to be processed.
- **Actions** - A set of procedures defined to format data. There are four types of actions which are for formatting cursor movement, data modification, data sending and delay specifications. An action can be defined to send the first number of characters to the Output plug-in, pad the output data with spaces or zeros, remove spaces in data, etc.

## Configuring ADF Plug-in

Configuring the ADF plug-in consists of creating a rule, defining the criteria and defining the actions.

1. Swipe up from the bottom of the Home screen and touch .
2. Touch a DataWedge profile.
3. In **Keystroke Output**, touch **Advanced data formatting**.


**Figure 110** Advanced Data Formatting Screen



4. Touch the **Enable** checkbox to enable ADF.

## Creating a Rule

✓ **NOTE** By default, Rule0, is the only rule in the Rules list.

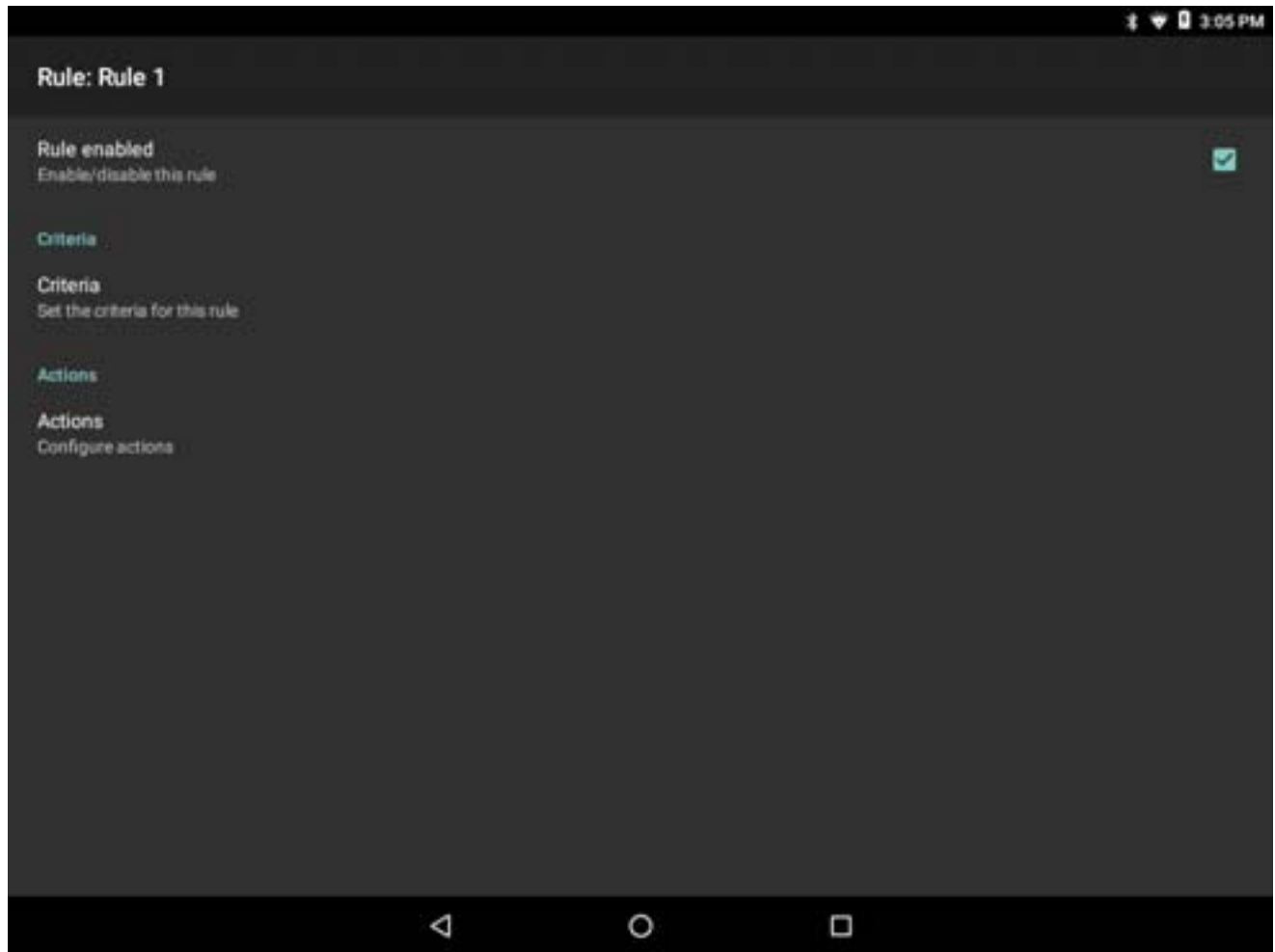
1. Touch .
2. Touch **New rule**.
3. Touch the **Enter rule name** text box.
4. In the text box, enter a name for the new rule.

5. Touch **OK**.

## Defining a Rule

1. Touch the newly created rule in the **Rules** list.

**Figure 111** Rule List Screen



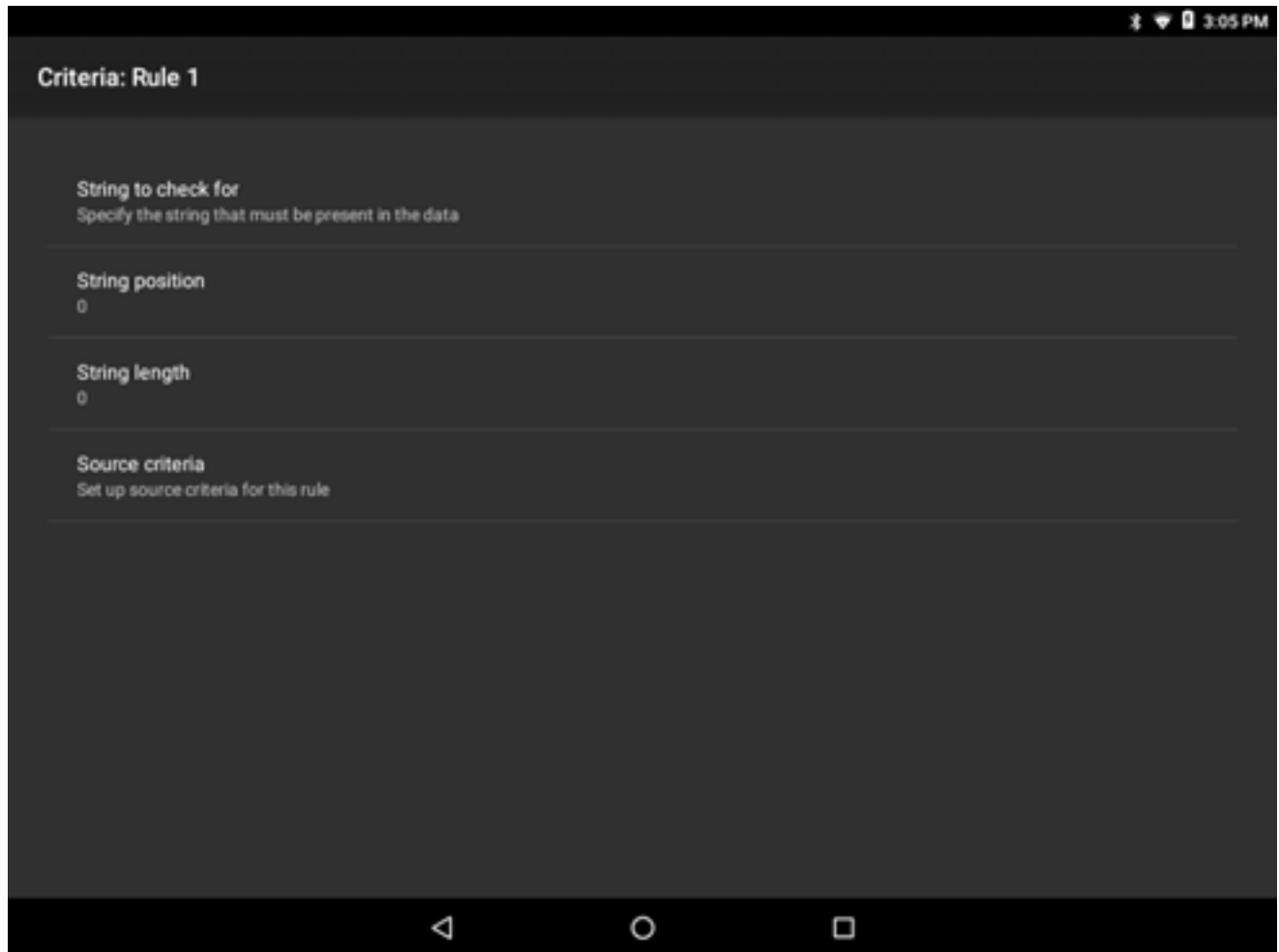
2. Touch the **Rule enabled** checkbox to enable the current rule.

## Defining Criteria

1. Touch **Criteria**.

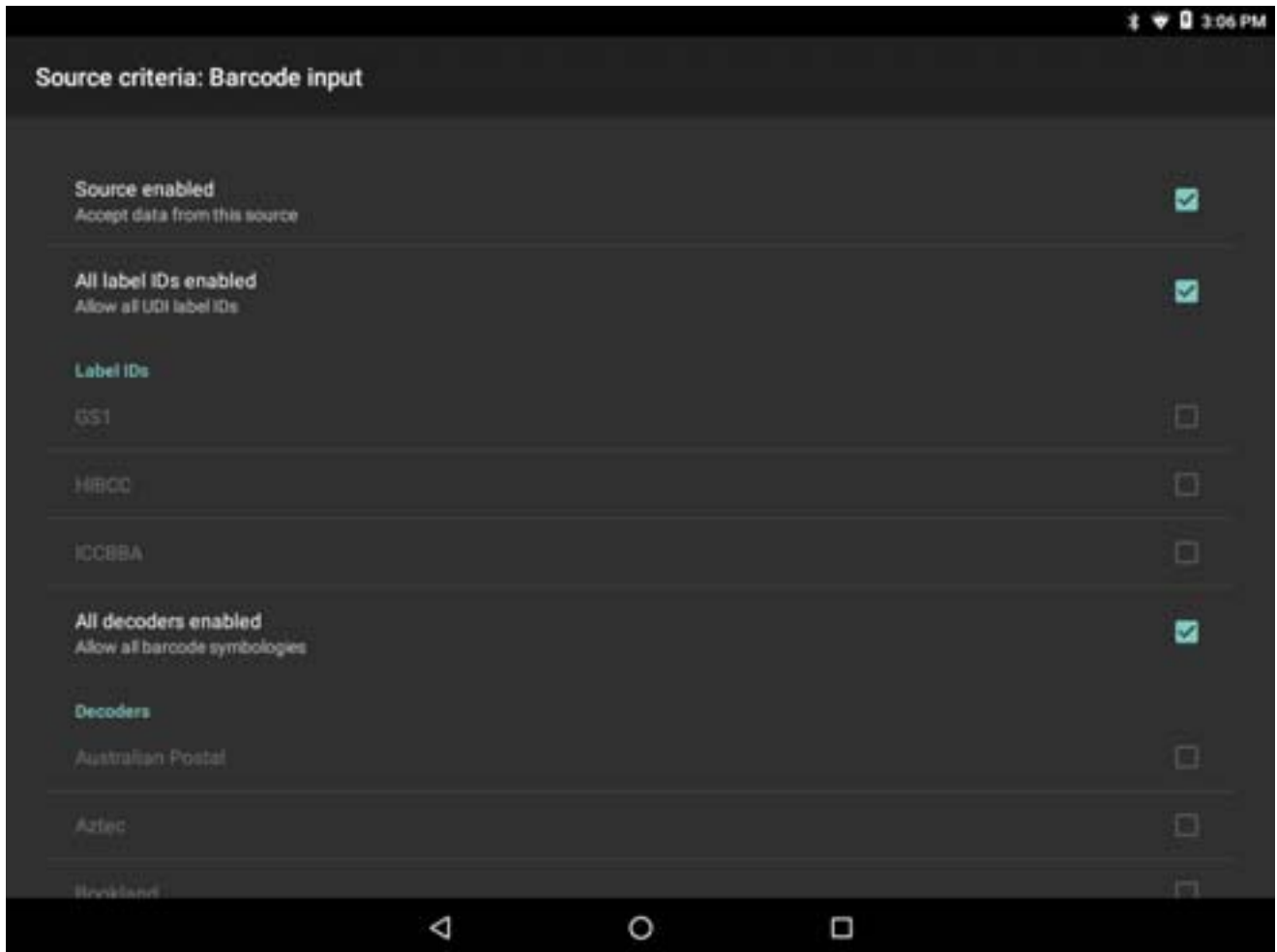




Figure 112 Criteria Screen



2. Touch **String to check for** option to specify the string that must be present in the data.
3. In the **Enter the string to check for** dialog box, enter the string.
4. Touch **OK**.
5. Touch **String position** option to specify the position of the string specified in the **String to check for** option. The ADF rule is only applied if the specific string in **String to check for** is found at the specified **String position** location (zero for the start of the string).
6. Touch the **+** or **-** to change the value.
7. Touch **OK**.
8. Touch **String length option** to specify a length for the received data. The ADF rule only applies to the barcode data with that specified length.
9. Touch the **+** or **-** to change the value.
10. Touch **OK**.
11. Touch **Source criteria** option to associate an input device to an ADF rule. The ADF rule only applies to data received from associated input devices.
12. Touch Barcode input. Options vary depending upon the device configuration.
13. Touch the **Source enabled** checkbox to accept data from this source.

Figure 113 Barcode Input Screen






14. For **Barcode inputs**, touch the **All decoders enabled** checkbox to select all barcode symbologies. Deselect the **All decoders enabled** checkbox to individually select the symbologies.
15. Touch  until the **Rule** screen appears.
16. If required, repeat steps to create another rule.
17. Touch  until the Rule screen appears.

## Defining an Action



**NOTE** By default the **Send remaining** action is in the **Actions** list.

1. Touch .
2. Touch **New action**.
3. In the **New action** menu, select an action to add to the **Actions** list. See [Table 11 on page 180](#) for a list of supported ADF actions.
4. Some Actions require additional information. Touch the Action to display additional information fields.
5. Repeat steps to create more actions.

6. Touch .
7. Touch .

### Deleting a Rule

1. Touch and hold on a rule until the context menu appears.
2. Touch **Delete** to delete the rule from the **Rules** list.



**NOTE** When there is no rule available for ADF plug-in or all rules are disabled, DataWedge passes decoded data to the output plug-in without processing the data.

### Order Rules List



**NOTE** When there are no rules defined, ADF passes the captured data through as is. In contrast, when rules are defined but all are disabled, ADF does not pass any captured data through.

Rules are processed in top-down order. The rules that are on top of the list are processed first. Use the icon next to the rule to move it to another position in the list.

**Table 11** ADF Supported Actions

Type	Actions	Description
Cursor Movement	Skip ahead	Moves the cursor forward by a specified number of characters. Enter the number of characters to move the cursor ahead.
	Skip back	Moves the cursor back by a specified number of characters. Enter the number of characters to move the cursor back.
	Skip to start	Moves the cursor to the beginning of the data.
	Move to	Moves the cursor forward until the specified string is found. Enter the string in the data field.
	Move past a	Moves the cursor forward past the specified string. Enter the string in the data field.
Data Modification	Crunch spaces	Remove spaces between words to one and remove all spaces at the beginning and end of the data.
	Stop space crunch	Stops space crunching. This disables the last <b>Crunch spaces</b> action.
	Remove all spaces	Remove all spaces in the data.
	Stop space removal	Stop removing spaces. This disables the last <b>Remove all spaces</b> action.
	Remove leading zeros	Remove all zeros at the beginning of data.
	Stop zero removal	Stop removing zeros at the beginning of data. This disables the previous <b>Remove leading zeros</b> action.
	Pad with zeros	Left pad data with zeros to meet the specified length. Enter the number zeros to pad.
	Stop pad zeros	Stop padding with zeros. This disables the previous <b>Pad with zeros</b> action.
	Pad with spaces	Left pad data with spaces to meet the specified length. Enter the number spaces to pad.
	Stop pad spaces	Stop padding with spaces. This disables the previous <b>Pad with spaces</b> action.
	Replace string	Replaces a specified string with a new string. Enter the string to replace and the string to replace it with.
	Stop all replace string	Stop all <b>Replace string</b> actions.

**Table 11** ADF Supported Actions (Continued)

Type	Actions	Description
Data Sending	Send next	Sends the specified number of characters from the current cursor position. Enter the number of characters to send.
	Send remaining	Sends all data that remains from the current cursor position.
	Send up to	Sends all data up to a specified string. Enter the string.
	Send pause	Pauses the specified number of milliseconds before continuing the next action. Enter the amount of time in milliseconds.
	Send string	Sends a specified string. Enter the string to send.
	Send char	Sends a specified ASCII/ Unicode character. Enter a character value. The maximum Unicode character value can be entered is U-10FFFF (= 1114111 in decimal).

## Deleting an Action

1. Touch and hold the action name.
2. Select **Delete action** from the context menu.

## ADF Example

The following illustrates an example of creating Advanced Data Formatting:


When a user scans a barcode with the following criteria:

- Code 39 barcode.
- length of 12 characters.
- contains 129 at the start position.

Modify the data as follows:

- Pad all sends with zeros to length 8.
- send all data up to character X.
- send a space character.

To create an ADF rule for the above example:

1. Swipe up from the bottom of the Home screen and touch .
2. Touch **Profile0**.
3. Under **Keystroke Output**, touch **Advanced data formatting**.
4. Touch **Enable**.
5. Touch **Rule0**.
6. Touch **Criteria**.
7. Touch **String to check for**.
8. In the **Enter the string to check for** text box, enter 129 and then touch **OK**.
9. Touch **String position**.
10. Change the value to 0.








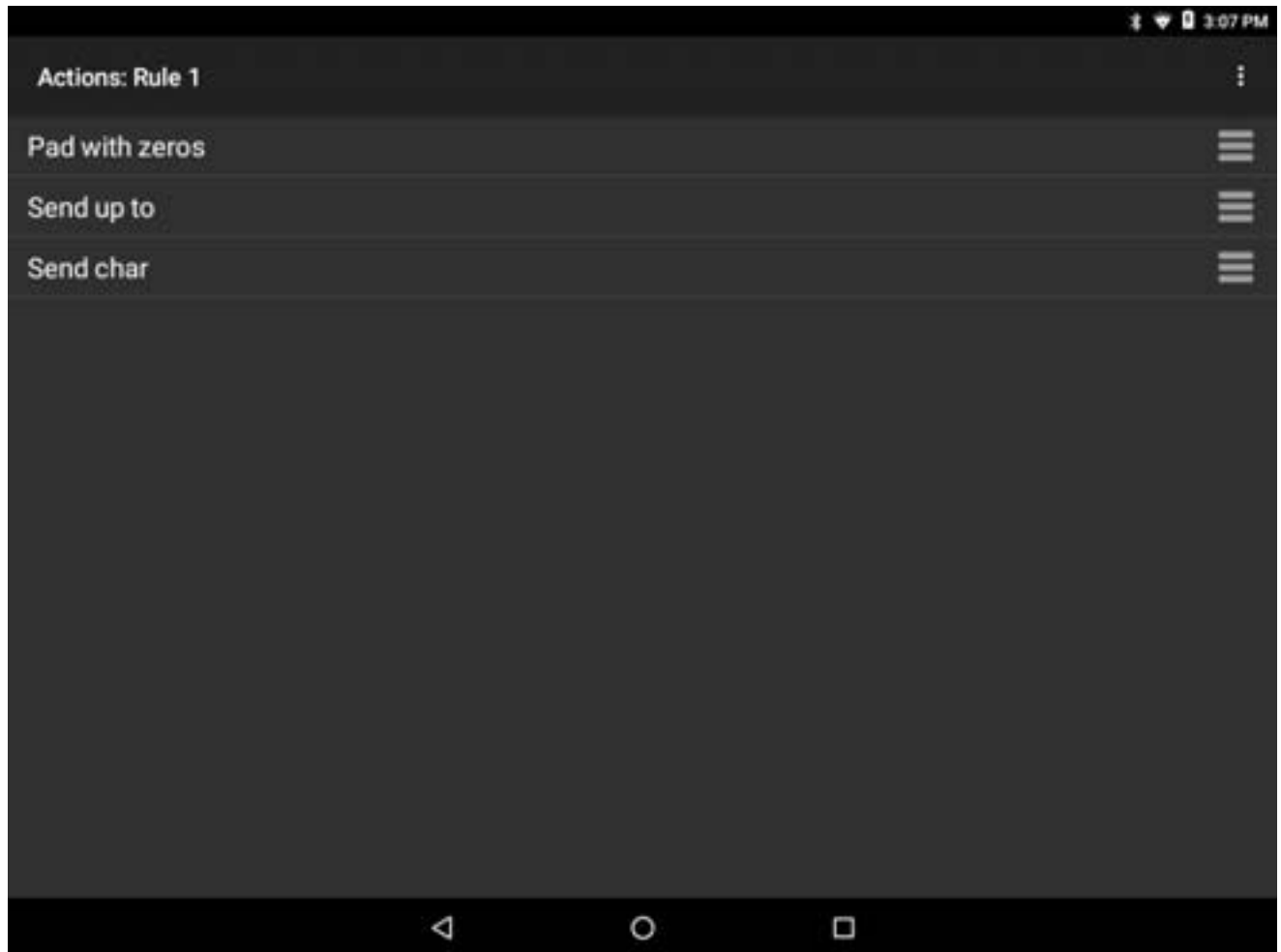
11. Touch **OK**.
12. Touch **String length**.
13. Change value to 12.
14. Touch **OK**.
15. Touch **Source criteria**.
16. Touch **Barcode input**.
17. Touch **All decoders enabled** to disable all decoders.
18. Touch **Code 39**.
19. Touch  three times.
20. Touch **Actions**.
21. Touch and hold on the **Send remaining rule** until a menu appears.
22. Touch **Delete action**.
23. Touch .
24. Touch **New action**.
25. Select **Pad with zeros**.
26. Touch the **Pad with zeros** rule.
27. Touch **How many**.
28. Change value to 8 and then touch **OK**.
29. Touch .
30. Touch .
31. Touch **New action**.
32. Select **Send up to**.
33. Touch **Send up to** rule.
34. Touch **String**.
35. In the **Enter a string** text box, enter x.
36. Touch **OK**.
37. Touch .
38. Touch .
39. Touch **New action**.
40. Select **Send char**.
41. Touch **Send char** rule.
42. Touch **Character code**.
43. In the **Enter character code** text box, enter 32.
44. Touch **OK**.
45. Touch .

Figure 114 ADF Sample Screen



46. Ensure that an application is open on the device and a text field is in focus (text cursor in text field).
47. Aim the exit window at the barcode.

Figure 115 Sample Bar Code

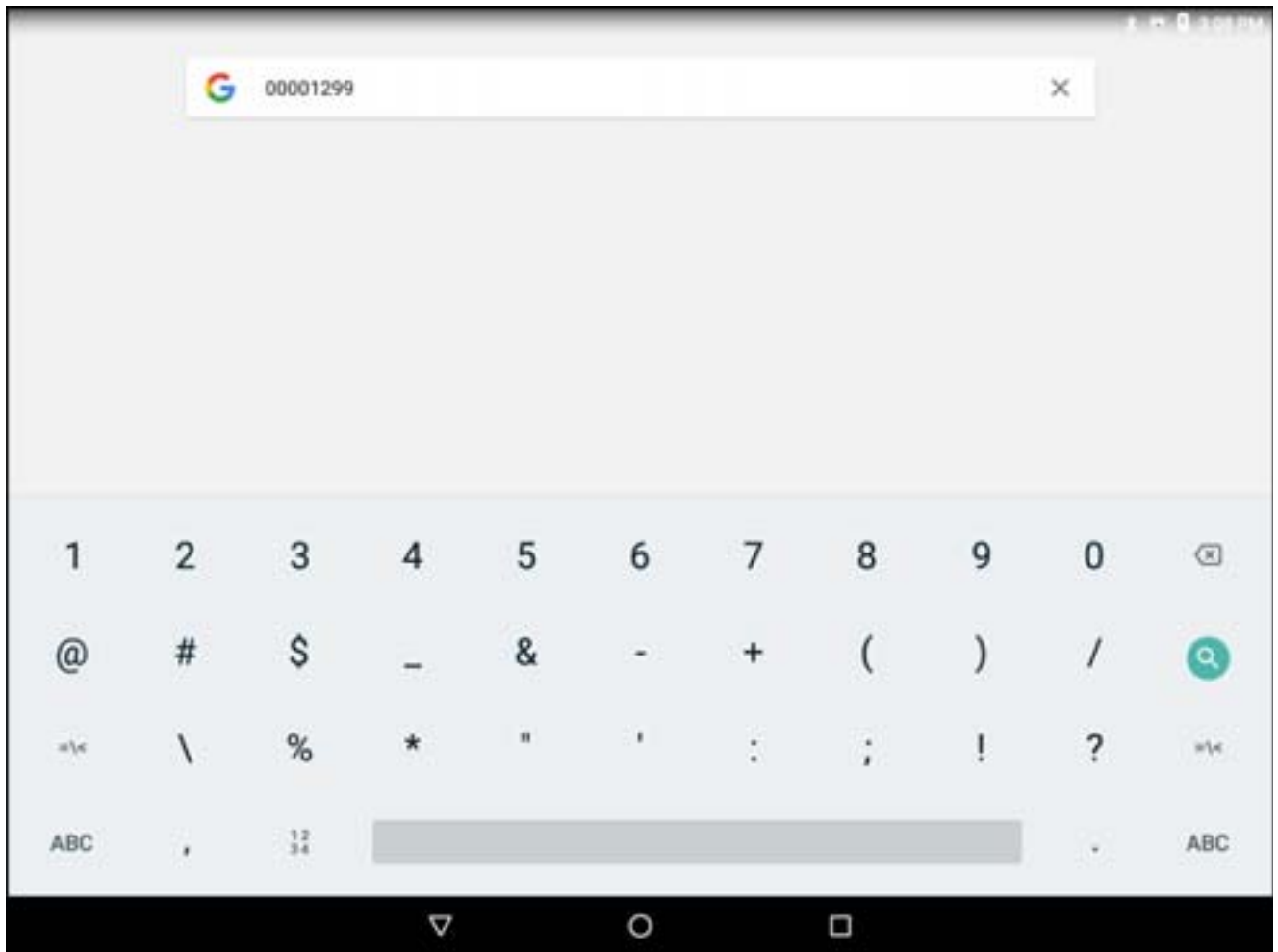


48. Press and hold the scan key.
 

The red laser aiming pattern turns on to assist in aiming. Ensure that the barcode is within the area formed by the aiming pattern.
49. The LED lights green, a beep sounds and the device vibrates, by default, to indicate the barcode was decoded successfully. The formatted data 0000129 appears in the text field.
 

Scanning a Code 39 barcode of 1299X15598 does not transmit data (rule is ignored) because the barcode data did not meet the length criteria.

**Figure 116** Formatted Data



## DataWedge Settings


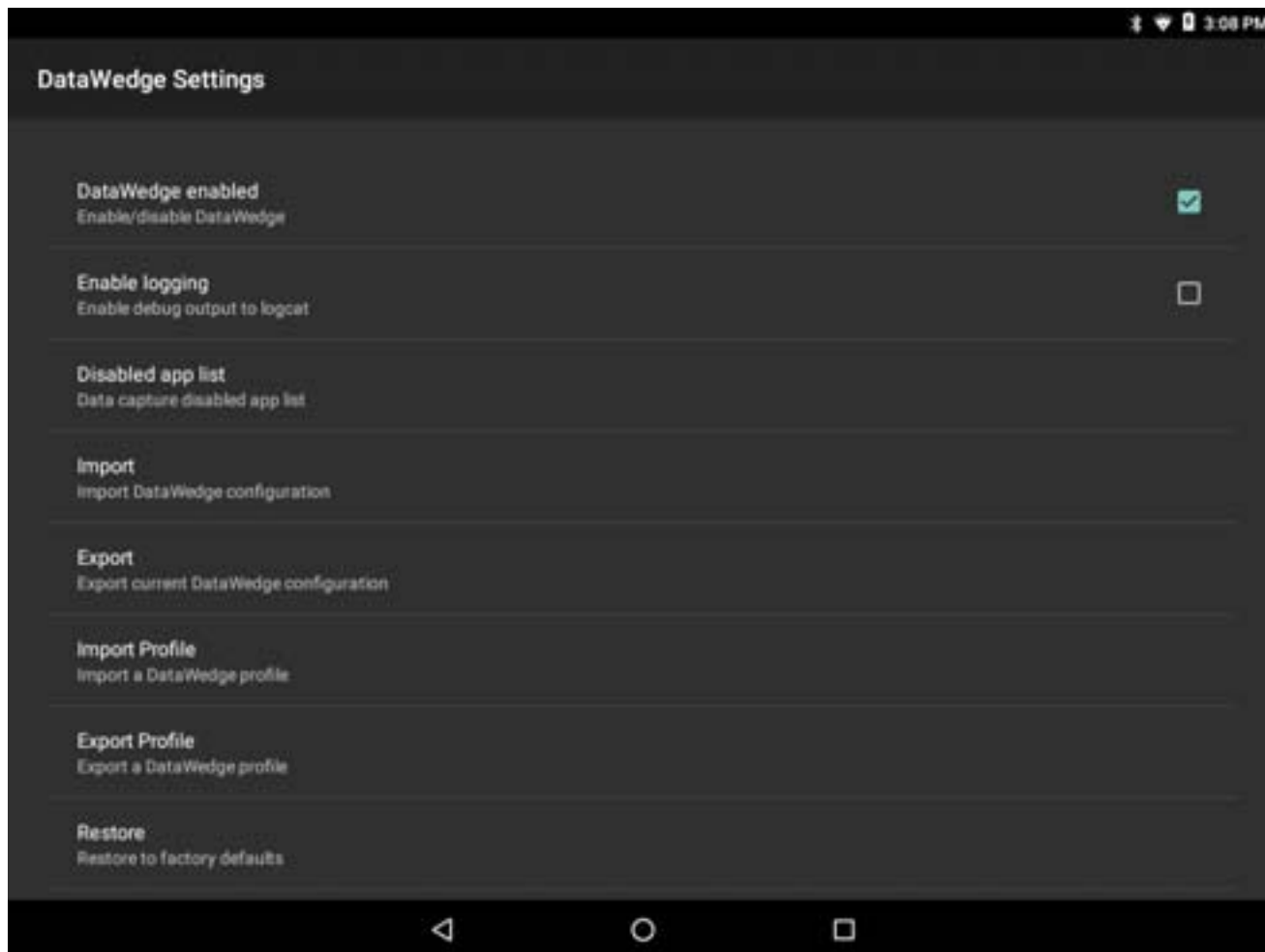
The DataWedge Settings screen provides access to general, non-profile related options. Touch  > **Settings**.





Figure 117 DataWedge Settings Window





- **DataWedge enabled** - Enables or disables DataWedge. To disable DataWedge uncheck this option.
- **Enable logging** - Enables or disables debug output file to logcat. To enable logging check this option.
- **Import** - allows import of a DataWedge configuration file. The imported configuration replaces the current configuration.
- **Export** - allows export of the current DataWedge configuration.
- **Import Profile** - allows import of a DataWedge profile file.
- **Export Profile** - allows export of a DataWedge profile.
- **Restore** - return the current configuration back to factory defaults.

## Importing a Configuration File

1. Copy the configuration file to the USB drive `/Android/data/com.symbol.datawedge/files` folder.
2. Swipe up from the bottom of the Home screen and touch .
3. Touch .
4. Touch **Settings**.
5. Touch **Import**.
6. Touch **filename to import**.



The configuration file (datawedge.db) is imported and replaces the current configuration.

## Exporting a Configuration File



1. Swipe up from the bottom of the Home screen and touch .
2. Touch .
3. Touch **Settings**.
4. Touch **Export**.
5. In the Export to dialog box, select the location to save the file.
6. Touch **Export**. The configuration file (datawedge.db) is saved to the selected location.

## Importing a Profile File

✓ **NOTE** Do not change the filename of the of the profile file. If the filename is changed, the file will not be imported.

1. Copy the profile file to the On Device Storage /Android/data/com.symbol.datawedge folder.
2. Swipe up from the bottom of the Home screen and touch .
3. Touch .
4. Touch **Settings**.
5. Touch **Import Profile**.
6. Touch the profile file to import.
7. Touch **Import**. The profile file (dwprofile\_x.db, where x = the name of the profile) is imported and appears in the profile list.



## Exporting a Profile

1. Swipe up from the bottom of the Home screen and touch .
2. Touch .
3. Touch **Settings**.
4. Touch **Export Profile**.
5. Touch the profile to export.
6. Touch **Export**.

The profile file (*dwprofile\_x.db*, where x = name of the profile) is saved to the root of the On-device Storage.

## Restoring DataWedge

To restore DataWedge to the factory default configuration:

1. Swipe up from the bottom of the Home screen and touch .
2. Touch .
3. Touch **Settings**.
4. Touch **Restore**.
5. Touch **Yes**.

## Configuration and Profile File Management

The configuration or profile settings for DataWedge can be saved to a file for distribution to other devices.

After making configuration or profile changes, export the new configuration or profile to the root of the On-device Storage. The configuration file created is automatically named *datawedge.db*. The profile file created is automatically named *dwprofile\_x.db*, where *x* is the profile name. The files can then be copied to the On-device Storage of other devices and imported into DataWedge on those devices. Importing a configuration or profile replaces the existing settings.

### Enterprise Folder

Internal storage contains the Enterprise folder (*/enterprise*). The Enterprise folder is persistent and maintains data after an Enterprise reset. After an Enterprise Reset, DataWedge checks folder */enterprise/device/settings/datawedge/enterpriseset/* for a configuration file, *datawedge.db* or a profile file, *dwprofile\_x.db*. If the file is found, it imports the file to replace any existing configuration or profile.



**NOTE** A Factory Reset deletes all files in the Enterprise folder.

### Auto Import

DataWedge supports remote deployment of a configuration to a device, using tools such as MSP. DataWedge monitors the */enterprise/device/settings/datawedge/autoimport* folder for the DataWedge configuration file (*datawedge.db*) or a profile file (*dwprofile\_x.db*). When DataWedge launches it checks the folder. If a configuration or profile file is found, it imports the file to replace any existing configuration or profile. Once the file has been imported it is deleted from the folder.

While DataWedge is running it receives a notification from the system that a file has been placed into the */enterprise/device/settings/datawedge/autoimport* folder. When this occurs, DataWedge imports this new configuration or profile, replacing the existing one and delete the file. DataWedge begins using the imported configuration immediately.



**NOTE** A Factory Reset deletes all files in the Enterprise folder.

It is strongly recommended that the user exits DataWedge before remotely deploying any configuration or profile. It is required that the file permissions are set to 666.

## Programming Notes



The following paragraphs provide specific programming information when using DataWedge.

### Overriding Trigger Key in an Application

To override the trigger key in an application, create a profile for the application that disables the Barcode input. In the application, use standard APIs, such as `onKeyDown()` to listen for the `KEYCODE_BUTTON_L1` and `KEYCODE_BUTTON_R1` presses.

## Disable DataWedge on Device and Mass Deploy

To disable DataWedge and deploy onto multiple devices:

1. Swipe up from the bottom of the Home screen and touch .
2. Touch .
3. Touch Settings.
4. Unselect the DataWedge enabled check box.
5. Export the DataWedge configuration. See [Exporting a Configuration File on page 186](#) for instructions. See [Configuration and Profile File Management on page 187](#) for instructions for using the auto import feature.

## Soft Scan Feature

DataWedge allows a native Android application to programmatically start, stop, or toggle the scan trigger state. The application can issue an Android Broadcast Intent, to control the scanner, without requiring the scan key to be pressed. The active DataWedge profile is required to control all the parameters during a scan operation.

The structure of the broadcast intent that resolves to the soft scan is:

**action:** "com.symbol.emdk.datawedge.api.ACTION\_SOFTSCANTRIGGER"

**extras:** This is a String name/value pair that contains trigger state details.

**name:** "com.symbol.emdk.datawedge.api.EXTRA\_PARAMETER"

**value:** "START\_SCANNING" or "STOP\_SCANNING" or "TOGGLE\_SCANNING"

## Sample

```
Intent sendIntent = new Intent();
sendIntent.setAction("com.symbol.emdk.datawedge.api.ACTION_SOFTSCANTRIGGER");
sendIntent.putExtra("com.symbol.emdk.datawedge.api.EXTRA_PARAMETER",
"TOGGLE_SCANNING");
sendBroadcast(sendIntent);
```

## Scanner Input Plugin

The ScannerInputPlugin API command can be used to enable/disable the scanner plug-in being used by the currently active Profile. Disabling the scanner plug-in effectively disables scanning in that Profile, regardless of whether the Profile is associated or unassociated. Valid only when Barcode Input is enabled in the active Profile.



**NOTE** Use of this API changes only the runtime status of the scanner; it does not make persistent changes to the Profile.

## Function Prototype

```
Intent i = new Intent();
i.setAction(ACTION);
i.putExtra(EXTRA_DATA, "<parameter>");
```

## Parameters

action: String "com.symbol.datawedge.api.ACTION\_SCANNERINPUTPLUGIN"

extra\_data: String "com.symbol.datawedge.api.EXTRA\_PARAMETER"

<parameter>: The parameter as a string, using either of the following:

- "ENABLE\_PLUGIN" - enables the plug-in
- "DISABLE\_PLUGIN" - disables the plug-in

## Return Values

None.

Error and debug messages will be logged to the Android logging system which then can be viewed and filtered by the logcat command. You can use logcat from an ADB shell to view the log messages, e.g.

```
$ adb logcat -s DWAPI
```

Error messages will be logged for invalid actions and parameters.

## Example

```
// define action and data strings
String scannerInputPlugin = "com.symbol.datawedge.api.ACTION_SCANNERINPUTPLUGIN";
String extraData = "com.symbol.datawedge.api.EXTRA_PARAMETER";

public void onResume() {
    // create the intent
    Intent i = new Intent();
    // set the action to perform
    i.setAction(scannerInputPlugin);
    // add additional info
    i.putExtra(extraData, "DISABLE_PLUGIN");
    // send the intent to DataWedge
    context.this.sendBroadcast(i);
}
```

## Comments

This Data Capture API intent allows the scanner plug-in for the current Profile to be enabled or disabled. For example, activity A launches and uses the Data Capture API intent to switch to ProfileA in which the scanner

plug-in is enabled, then at some point it uses the Data Capture API to disable the scanner plug-in. Activity B is launched. In DataWedge, ProfileB is associated with activity B. DataWedge switches to ProfileB. When activity A comes back to the foreground, in the onResume method, activity A needs to use the Data Capture API intent to switch back to ProfileA, then use the Data Capture API intent again to disable the scanner plug-in, to return back to the state it was in.



**NOTE** Use of this API changes only the runtime status of the scanner; it does not make persistent changes to the Profile.

The above assumes that ProfileA is not associated with any applications/activities, therefore when focus switches back to activity A, DataWedge will not automatically switch to ProfileA therefore activity A must switch back to ProfileA in its onResume method. Because DataWedge will automatically switch Profile when an activity is paused, it is recommended that this API function be called from the onResume method of the activity.

## Enumerate Scanners

Use the enumerateScanners API command to get a list of scanners available on the device.

### Function Prototype

```
Intent i = new Intent();  
i.setAction(ACTION);
```

### Parameters

action: String "com.symbol.datawedge.api.ACTION\_ENUMERATESCANNERS"

### Return Values

The enumerated list of scanners will be returned via a broadcast Intent. The broadcast Intent action is "com.symbol.datawedge.api.ACTION\_ENUMERATEDSCANNERLIST" and the list of scanners is returned as a string array (see the example below).

Error and debug messages will be logged to the Android logging system which then can be viewed and filtered by the logcat command. You can use logcat from an ADB shell to view the log messages, e.g.

```
$ adb logcat -s DWAPI
```

Error messages will be logged for invalid actions and parameters

## Example

```
// first send the intent to enumerate the available scanners on the device
// define action string
String enumerateScanners = "com.symbol.datawedge.api.ACTION_ENUMERATESCANNERS";
// create the intent
Intent i = new Intent();
// set the action to perform
i.setAction(enumerateScanners);
// send the intent to DataWedge
context.this.sendBroadcast(i);

// now we need to be able to receive the enumerate list of available scanners
String enumeratedList = "com.symbol.datawedge.api.ACTION_ENUMERATEDSCANNERLIST";
String KEY_ENUMERATEDSCANNERLIST = "DataWedgeAPI_KEY_ENUMERATEDSCANNERLIST";
// Create a filter for the broadcast intent
IntentFilter filter = new IntentFilter();
filter.addAction(enumeratedList);
registerReceiver(myBroadcastReceiver, filter);

// now we need a broadcast receiver
private BroadcastReceiver myBroadcastReceiver = new BroadcastReceiver() {
    @Override
    public void onReceive(Context context, Intent intent) {
        String action = intent.getAction();
        if (action.equals(enumeratedList)) {
            Bundle b = intent.getExtras();
            String[] scanner_list = b.getStringArray(KEY_ENUMERATEDSCANNERLIST);
        }
    }
};
```

### Comments

The scanner and its parameters are set based on the currently active Profile.

## Set Default Profile

Use the setDefaultProfile API function to set the specified Profile as the default Profile.

### Default Profile Recap

Profile0 is the generic Profile used when there are no user created Profiles associated with an application.

Profile0 can be edited but cannot be associated with an application. That is, DataWedge allows manipulation of plug-in settings for Profile0 but it does not allow assignment of a foreground application. This configuration allows DataWedge to send output data to any foreground application other than applications associated with user-defined Profiles when Profile0 is enabled.

Profile0 can be disabled to allow DataWedge to only send output data to those applications which are associated in user-defined Profiles. For example, create a Profile associating a specific application, disable Profile0 and then scan. DataWedge only sends data to the application specified in the user-created Profile. This adds additional security to DataWedge enabling the sending of data only to specified applications.

### Usage Scenario

A launcher application has a list of apps that a user can launch and that none of the listed apps has an associated DataWedge Profile. Once the user has selected an app, the launcher needs to set the appropriate DataWedge Profile for the selected app. This could be done by using `setDefaultProfile` to set the default Profile to the required Profile. Then when the user launches the selected app, DataWedge auto Profile switching switches to the default Profile (which is now the required Profile for that app).

If, for some reason, the launched app has an associated DataWedge Profile then that will override the set default Profile.

When control is returned to the launcher application, `resetDefaultProfile` can be used to reset the default Profile.

### Function Prototype

```
Intent i = new Intent();
i.setAction(ACTION);
i.putExtra(EXTRA_DATA, "<profile name>");
```

### Parameters

action: String "com.symbol.datawedge.api.ACTION\_SETDEFAULTPROFILE"

extra\_data: String "com.symbol.datawedge.api.EXTRA\_PROFILENAME"

<profile name>: The Profile name to set as the default Profile as a string (case-sensitive).

### Return Values

None.

Error and debug messages will be logged to the Android logging system which then can be viewed and filtered by the logcat command. You can use logcat from an ADB shell to view the log messages, e.g.

```
$ adb logcat -s DWAPI
```

Error messages will be logged for invalid actions, parameters and failures (e.g. Profile not found or associated with an application).



## Example

```
// define action and data strings
String setDefaultProfile = "com.symbol.datawedge.api.ACTION_SETDEFAULTPROFILE";
String extraData = "com.symbol.datawedge.api.EXTRA_PROFILENAME";

public void onResume() {
    // create the intent
    Intent i = new Intent();
    // set the action to perform
    i.setAction(setDefaultProfile);
    // add additional info
    i.putExtra(extraData, "myProfile");
    // send the intent to DataWedge
    context.this.sendBroadcast(i);
}
```

## Comments

The API command will have no effect if the specified Profile does not exist or if the specified Profile is already associated with an application. DataWedge will automatically switch Profiles when the activity is paused, so it is recommended that this API function be called from the onResume method of the activity.

Zebra recommends that this Profile be created to cater to all applications/activities that would otherwise default to using Profile0. This will ensure that these applications/activities continue to work with a consistent configuration. For example, let's say that initially Profile0 is the default Profile using the camera as the barcode scanner. Using the Browser application and scanning a barcode with the camera, DataWedge enters the data into the Browser. Now launch an application that changes the default Profile to a Profile using the blockbuster as the barcode scanner. When returning to the Browser application, since it is using the default Profile, scanning will now be via the blockbuster not the camera as previously. To ensure that the Browser continues to use the camera as the barcode scanner a Profile should be created and associated with the Browser that specifies the camera as the barcode scanner.

## Reset Default Profile

Use the resetDefaultProfile API function to reset the default Profile back to Profile0.

### Function Prototype

```
Intent i = new Intent();

i.setAction(ACTION);
i.putExtra(EXTRA_DATA, "<Profile name>");
```

### Parameters

action: String "com.symbol.datawedge.api.ACTION\_RESETDEFAULTPROFILE"

extra\_data: String "com.symbol.datawedge.api.EXTRA\_PROFILENAME"

<Profile name>: The Profile name to set as the default Profile as a string (case-sensitive).

### Return Values

None.

Error and debug messages will be logged to the Android logging system which then can be viewed and filtered by the logcat command. You can use logcat from an ADB shell to view the log messages, e.g.

```
$ adb logcat -s DWAPI
```

Error messages will be logged for invalid actions, parameters and failures (e.g. Profile not found or associated with an application).

### Example

```
// define action string
String resetDefaultProfile = "com.symbol.datawedge.api.ACTION_RESETDEFAULTPROFILE";

public void onResume() {
    // create the intent
    Intent i = new Intent();
    // set the action to perform
    i.setAction(resetDefaultProfile);
    context.this.sendBroadcast(i);
}
```

### Comments

None.

## Switch To Profile

Use the SwitchToProfile API action to switch to the specified Profile.

### Profiles Recap

DataWedge is based on Profiles and plug-ins. A Profile contains information on how DataWedge should behave with different applications.

Profile information consists of:

- Associated application
- Input plug-in configurations
- Output plug-in configurations
- Process plug-in configurations

DataWedge includes a default Profile, Profile0, that is created automatically the first time DataWedge runs.

Using Profiles, each application can have a specific DataWedge configuration. For example, each user application can have a Profile which outputs scanned data in the required format when that application comes to the foreground. DataWedge can be configured to process the same set of captured data differently based on the requirements of each application.



**NOTE** Use of this API changes only the runtime status of the scanner; it does not make persistent changes to the Profile.

### NOTE

A single Profile may be associated with one or many activities/apps, however, given an activity, only one Profile may be associated with it.

### Usage Scenario

An application has two activities. Activity A only requires EAN13 barcodes to be scanned. Activity B only requires MSR card data. Profile B is configured to only scan EAN13 barcodes and is left unassociated. Profile M is configured to only accept MSR input and is left unassociated. When Activity A launches it uses SwitchToProfile to activate Profile B. Similarly, when Activity B launches it uses switchToProfile to activate Profile M.

If another activity/app comes to the foreground, DataWedge auto Profile switching will set the DataWedge Profile accordingly either to the default Profile or to an associated Profile.

When Activity A (or Activity B) comes back to the foreground it will use switchToProfile to reset the Profile back to Profile B (or Profile M).

### Function Prototype

```
Intent i = new Intent();
i.setAction(ACTION);
i.putExtra(EXTRA_DATA, "<profile name>");
```

### Parameters

action: String "com.symbol.datawedge.api.ACTION\_SWITCHTOPROFILE"

extra\_data: String "com.symbol.datawedge.api.EXTRA\_PROFILENAME"

<profile name>: The Profile name to switch to as a string (case-sensitive).

## Return Values

None.

Error and debug messages will be logged to the Android logging system which then can be viewed and filtered by the logcat command. You can use logcat from an ADB shell to view the log messages, e.g.

```
$ adb logcat -s DWAPI
```

Error messages will be logged for invalid actions, parameters and failures (e.g. Profile not found or associated with an application).

## Example

```
// define action and data strings
String switchToProfile = "com.symbol.datawedge.api.ACTION_SWITCHTOPROFILE";
String extraData = "com.symbol.datawedge.api.EXTRA_PROFILENAME";

public void onResume() {
    super.onResume();
    // create the intent
    Intent i = new Intent();
    // set the action to perform
    i.setAction(switchToProfile);
    // add additional info
    i.putExtra(extraData, "myProfile");
    // send the intent to DataWedge
    context.this.sendBroadcast(i);
}
```

## Comments

This API function will have no effect if the specified Profile does not exist or is already associated with an application.

DataWedge has a one-to-one relationship between Profiles and activities; a Profile can be associated only with a single activity. When a Profile is first created, it's not associated with any application, and will not be activated until associated. This makes it possible to create multiple unassociated Profiles.

This API function activates such Profiles.

For example, Profile A is unassociated and Profile B is associated with activity B. If activity A is launched and uses `SwitchToProfile` function to switch to Profile A, then Profile A will be active whenever activity A is in the foreground. When activity B comes to the foreground, DataWedge will automatically switch to Profile B.

When activity A returns to the foreground, the app must use `SwitchToProfile` again to switch back to Profile A. This would be done in the `onResume` method of activity A.



**NOTE** Use of this API changes only the runtime status of the scanner; it does not make persistent changes to the Profile.

## Notes

Because DataWedge will automatically switch Profile when the activity is paused, Zebra recommends that this API function be called from the onResume method of the activity.

After switching to a Profile, this unassociated Profile does not get assigned to the application/activity and is available to be used in the future with a different app/activity.

For backward compatibility, DataWedge's automatic Profile switching is not affected by the above API commands. This why the commands work only with unassociated Profiles and apps.

DataWedge auto Profile switching works as follows:

Every second...

- Sets newProfileId to the associated Profile ID of the current foreground activity.
- If no associated Profile is found, sets newProfileId to the associated Profile ID of the current foreground app.
- If no associated Profile is found, sets newProfileId to the current default Profile (which MAY NOT be Profile0).
- Checks the newProfileId against the currentProfileId. If they are different:
  - deactivates current Profile
  - activates new Profile (newProfileId)
  - sets currentProfileId = newProfileId

# Settings

---




## Introduction

This chapter describes settings available for configuring the device.

---

## Setting the Date and Time

The user is only required to set the time zone or set the date and time when the wireless LAN does not support Network Time Protocol (NTP).

1. Swipe down from the status bar and then touch .
2. Touch  **Date & time**.
3. Touch **Automatic date & time** to disable automatic date and time synchronization.
4. Touch **Set date**.
5. In the calendar, set today's date.
6. Touch **OK**.
7. Touch **Set time**.
8. Touch the green circle, drag to the current hour and then release.
9. Touch the green circle, drag to the current minute and then release.
10. Touch **AM** or **PM**.
11. Touch **OK**.
12. Touch **Automatic time zone** to disable automatic date and time synchronization.
13. Touch **Select time zone**.
14. Select the current time zone from the list.
15. Touch .

---

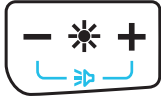
## Display Setting

Use Display settings to change the screen brightness, change the background image, enable screen rotation, set sleep time and change font size.

## Setting the Screen Brightness

To manually set the screen brightness use the Display Brightness control buttons on the front of the VC80x.

**Figure 118** Brightness Control



Alternately:




1. Swipe down with two fingers from the status bar to open the quick access panel.
2. Slide the brightness icon to adjust the screen brightness level.

**Figure 119** Brightness Slider



## Setting Screen Timeout Setting

To set the screen sleep time:

1. Swipe down from the status bar and then touch .
2. Touch  **Display**.
3. Touch **Sleep**.
4. Select one of the sleep values.
  - **15 seconds**
  - **30 seconds**
  - **1 minute** (default)
  - **2 minutes**
  - **5 minutes**
  - **10 minutes**
  - **30 minutes**
5. Touch .

## Setting Font Size

To set the size of the font in system applications:



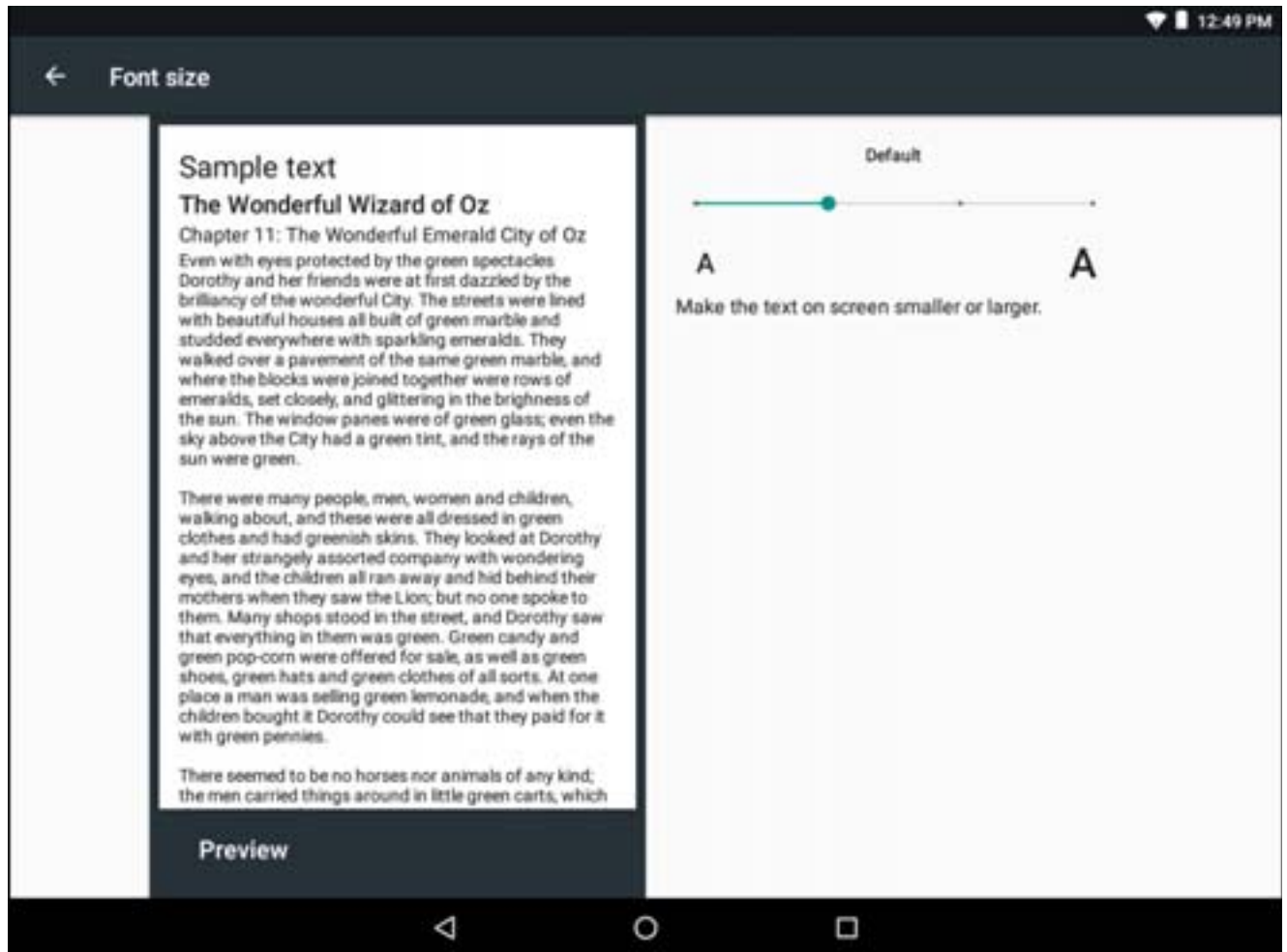
1. Swipe down from the status bar and then touch .
2. Touch  **Display**.
3. Touch **Font size**.



Figure 120 Font Settings



4. Select one of the font size values.
  - **Small**
  - **Default** (default)
  - **Large**
  - **Largest.**
5. Touch .

## Setting Screen Rotation



By default, screen rotation is disabled. To enable screen rotation:

1. Swipe down from the status bar and then touch .
2. Touch  **Display**.
3. Touch **When device is rotated** and select **Rotate to contents of the screen** to set the VC80x to automatically switch orientation when the VC80x is rotated.
4. Touch .

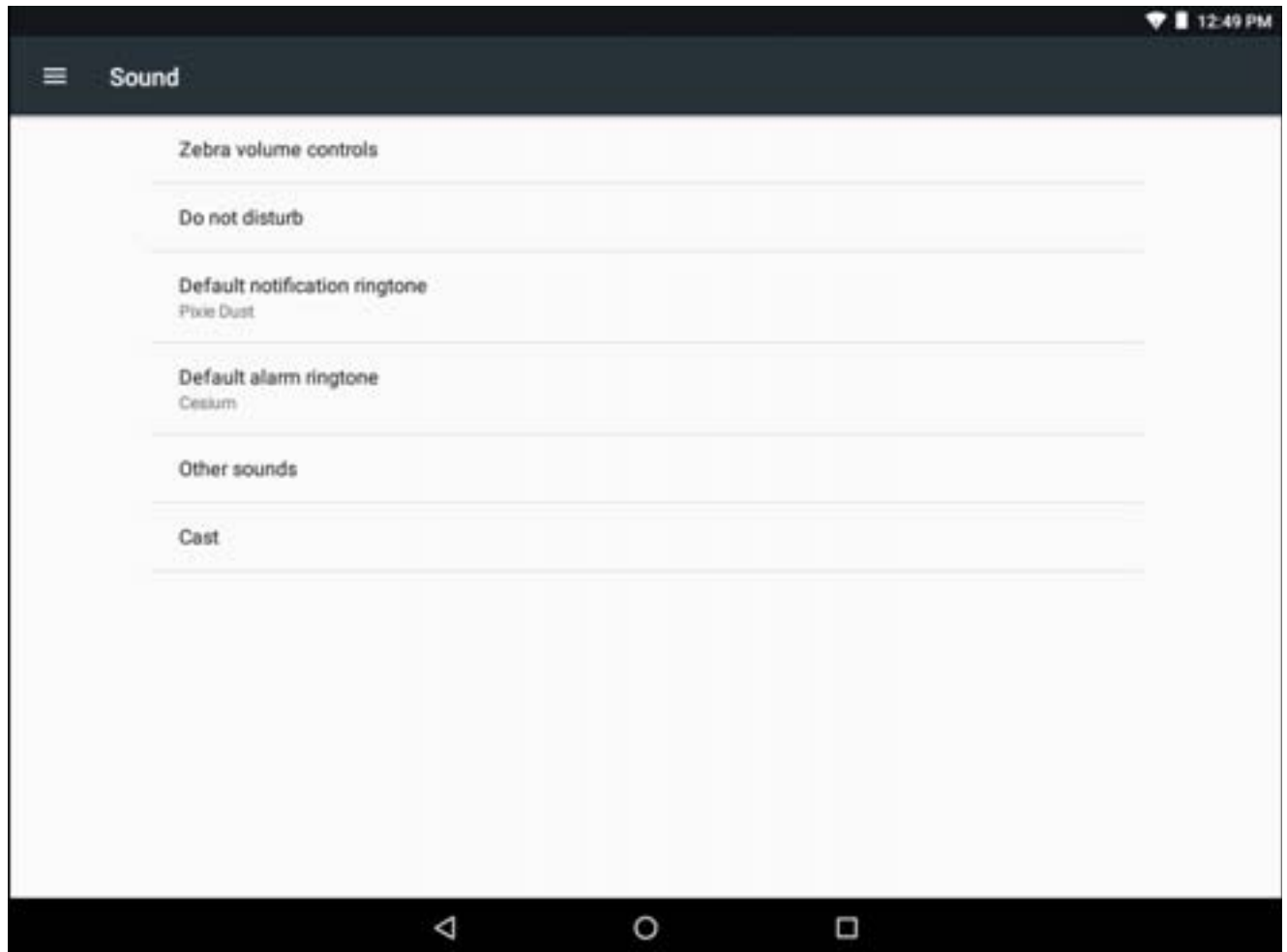


## General Sound Setting

Use the **Sounds** settings to configure media and alarm volumes.

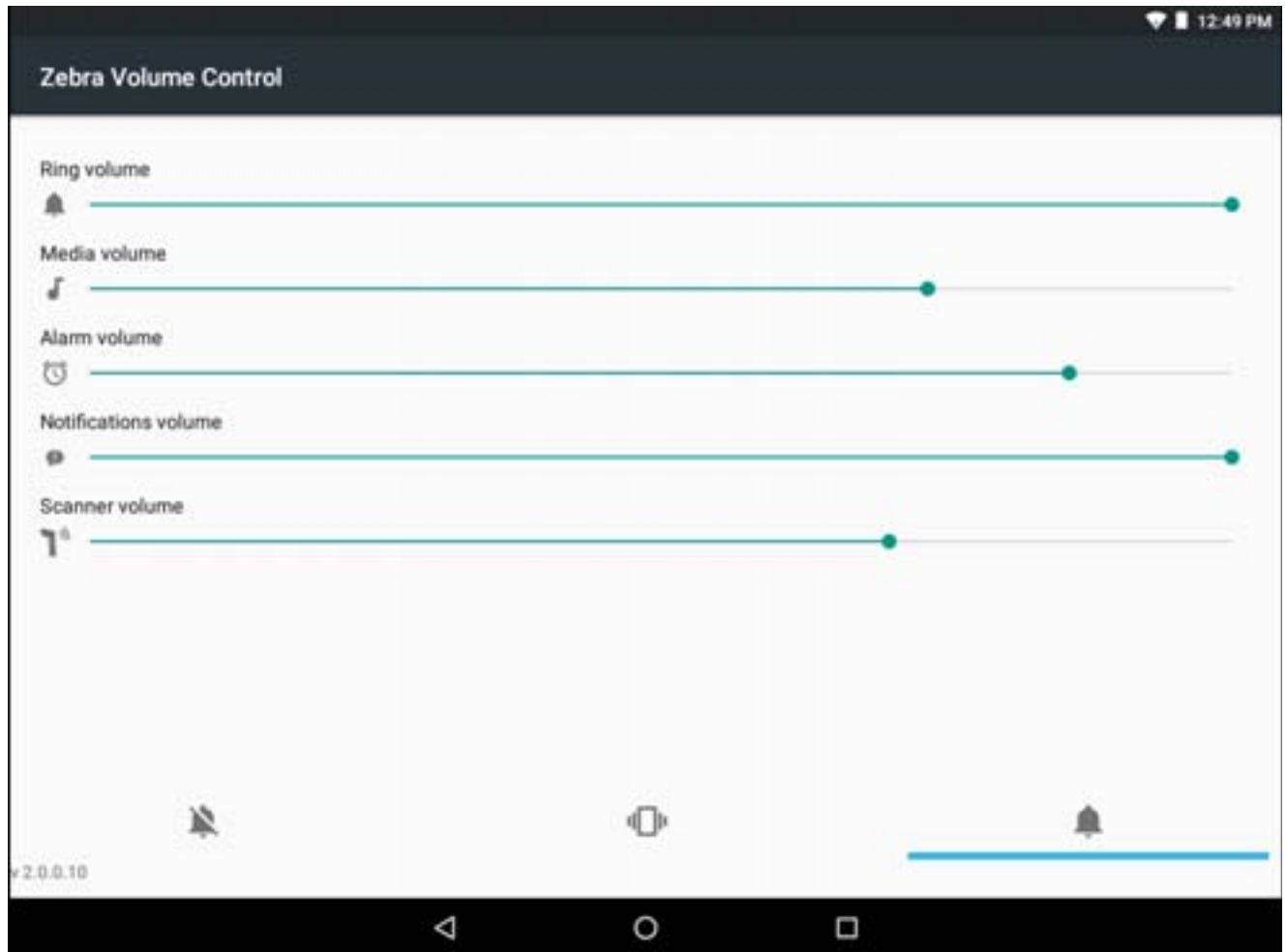
1. Swipe down from the status bar and then touch .
2. Touch  **Sounds**.

**Figure 121** Sound Screen



- **Zebra Volume Controls**

Figure 122 Zebra Volume Controls



- **Ring Volume** - Controls the ringtone volume.
- **Media volume** - Controls the music, games and media volume.
- **Alarm volume** - Controls the alarm clock volume.
- **Notification volume** - Controls the system notification volume.
- **Scanner volume** - Controls the scanner beep volume.
- **Do not disturb** - Mutes the VC80x so that it does not make sounds or vibrate when you do not want it to.
  - **Priority only allows** - Use to set priorities.
    - **Alarms** - Disabled.
    - **Reminders and Events** - Switch on or off.
    - **Messages and Calls** - Choose from anyone, starred contacts, any contact, or none. To star contacts, use the Contacts app.
    - **Repeat callers** - Choose whether to let the VC80x ring if the same person calls again within 15 minutes.
  - **Automatic rules** - To automatically silence the VC80x during certain times, like at night or on weekends. Touch a default rule Weekend or Weeknight. Or, to make your own rule, tap Add rule and then Time rule.
  - **Block visual disturbances**

- **Block when screen is on** - option pertains to notifications you receive when you are actively using the device. If you would like to disable the banner like notifications when Do not Disturb is enabled, turn this option On. This will also prevent you from peeking at notifications.
- **Block when screen is off** - option pertains to notifications you receive when you are not using your device i.e. the display is asleep. If you want to prevent the display from waking up when a new notification is received, turn this option On. This will additionally disable the LED light alerts your phone sends you when you have new notifications.
- **Default notification ringtone** - Touch to select a sound to play for all system notifications.
- **Default alarm ringtone** - Touch to select a sound to play for alarms.
- **Other sounds**
  - **Screen locking sounds** - play a sound when locking and unlocking the screen (default – enabled)
  - **Charging sounds** - Not applicable.
  - **Touch sounds** - Play a sound when making screen selections (default – enabled).
  - **Vibrate on tap** - Device vibrates when making screen selections (default – disabled).

---

## Do Not Disturb Feature

This mode mutes the VC80x so that it does not make sounds or vibrate.

For example, use Do Not Disturb to:

- Automatically limit sounds at night or during events
- Mute interruptions other than alarms
- Get alerted to messages only from favorite contacts.

## Limit Sounds and Vibrations

Mute the VC80x completely, or let through the important alarms or important calls.

### Total Silence

To completely mute the VC80x so that it does not make a sound or vibrate, choose **Total silence**.


In Total silence mode:

- Alarms do not make noise.
- VC80x does not vibrate or make sounds when receiving a message, or notification.
- Sounds from music, videos, games, and other media are muted.



**NOTE:** The user will not hear alarms in Total silence mode.

1. Swipe down with two fingers from the status bar to open the quick access panel.
2. Touch **Do not disturb > Total silence**.
3. Choose **Until you turn it off** or select a time period.
4. Touch **Done**.


When Total Silence is on,  appears in the quick access panel and the Status Bar.

To turn off Total Silence, open quick access panel and touch **Total silence**.

## Alarms Only

To mute the VC80x so that the user hears alarms, choose **Alarms only**. This option does not mute sounds from music, videos, games, or other media.

1. Swipe down with two fingers from the status bar to open the quick access panel.
2. Touch **Do not disturb > Alarms only**.
3. Choose **Until you turn it off** or select a time period.
4. Tap **Done**.

When Alarms Only is on,  appears in the quick access panel and the Status Bar.

To turn off Alarms Only, open quick access panel and touch **Alarms only**.





**NOTE:** To quickly turn on Alarms Only, with the screen on, press and hold the Volume Down button until the volume is all the way down. Then, press Volume Down again to turn on Alarms Only.

To turn off Alarms Only, press either the Volume Up or Volume Down button and the touch **END NOW** in the alert message. Then, press Volume Up again to turn on Alarms Only.

## Priority Notifications Only


To only be interrupted by important notifications, choose Priority Only. This option does not mute sounds from music, videos, games, or other media.

Before turning on Priority Only mode, set the notification priorities:

1. Swipe down from the status bar and then touch .
2. Touch  **Sound > Do not disturb > Priority only allows**.
3. Set priorities.
  - **Alarms:** Disabled by default.
  - **Reminders and Events:** Switch on or off.
  - **Messages:** Choose **From anyone**, **From contacts only**, **From starred contacts only**, or **none**. To star contacts, use the **Contacts** app.
  - **Repeat callers:** Not applicable.

After setting notification priorities, turn on Priority only mode to limit interruptions. The priority notifications make a sound or vibrate based on the current ringer volume, but other notifications will be silenced.

1. Swipe down with two fingers from the status bar to open the quick access panel.
2. Touch **Do not disturb > Priority only**.
3. Choose **Until you turn it off** or select a time period.
4. Tap **Done**.



When Priority Only is on,  appears in the quick access panel and the Status Bar.

To turn off Priority Only, open quick access panel and touch **Priority only**.

## Automatically Block Sounds and Vibrations



### Silence Sounds During Certain Times

To automatically silence the VC80x during certain times, like at night or on weekends, set the time rules.



1. Swipe down from the status bar and then touch .
2. Touch  **Sound > Do not disturb > Automatic rules**.
3. Touch a default **Weekend** or **Weeknight**. Or, to make a new rule, touch **Add rule** and then **Time rule**.
4. Edit the new rule:
  - **Rule name:** Name the rule.
  - **Days, Start time, and End time:** Set the rule's schedule.
  - **Do not disturb:** Choose whether the rule uses **Alarms only**, **Priority only**, or **Total silence**.
5. Touch the On/Off text or switch at the top to turn on the rule.

### Silence Sounds During Events and Meetings

To automatically silence the VC80x during events or meetings, set an event rules.

1. Swipe down from the status bar and then touch .
2. Touch  **Sound & notification > Do not disturb > Automatic rules**.
3. To edit the default rule, touch **Event**. Or, to create a new rule, touch **Add rule > Event rule**.
4. Edit the rule settings.
  - **During events for:** Select which Google Calendar events the rule uses.
  - **Where reply is:** Options: **Yes, Maybe, or Not replied, Yes or Maybe, or Yes**.
  - **Do not disturb:** Choose whether the rule uses **Priority only**, **Alarms only**, or **Total silence**.
5. Touch the On/Off switch at the top to turn on the rule.

### Turn Sounds Back On

When the VC80x is in Do Not Disturb mode, Alarms or Priority only  or Total silence  display.

To turn off Do Not Disturb, either:

- In the quick access panel, touch **Alarms only**, **Priority only**, or **Total silence**.
- Press the Volume Down button and touch **End Now**.

### Override Do Not Disturb for Specific Apps



To let through notifications from specific apps:

1. Open **Settings > Notifications**.
2. Touch an app.
3. Touch **Override Do Not Disturb**. This lets notifications through Priority only mode but not Total silence or Alarms only.

---

## Screen Unlock Settings

Use the **Security settings** to set preferences for locking the screen.

1. Swipe down from the status bar and then touch .
2. Touch  **Security**.



**NOTE** Options vary depending upon the application's policy, for example, email.

- **Screen lock** - Touch to configure the device to require a slide, pattern, PIN, or password to unlock the screen.
  - **None** - Disable screen unlock security.
  - **Swipe** - Slide the lock icon to unlock the screen.
  - **Pattern** - Draw a pattern to unlock screen. See Set Screen Unlock Using Pattern for more information.
  - **PIN** - Enter a numeric PIN to unlock screen. See Set Screen Unlock Using PIN for more information.
  - **Password** - Enter a password to unlock screen. See Set Screen Unlock Using Password for more information.

Lock the screen to protect access to data on the device. Some email accounts require locking the screen. The Locking feature functions differently in Single-user versus Multiple-user mode.

When locked, a slide, pattern, PIN or password is required to unlock the device. Press the Power button to lock the screen. The device also locks after a pre-defined time-out.

Press and release the Power button to wake the device. The Lock screen displays.

Slide the screen up to unlock. If the Pattern screen unlock feature is enabled, the Pattern screen appears instead of the Lock screen. If the PIN or Password screen unlock feature is enabled, enter the PIN or password after unlocking the screen.

### Set Screen Unlock Using PIN



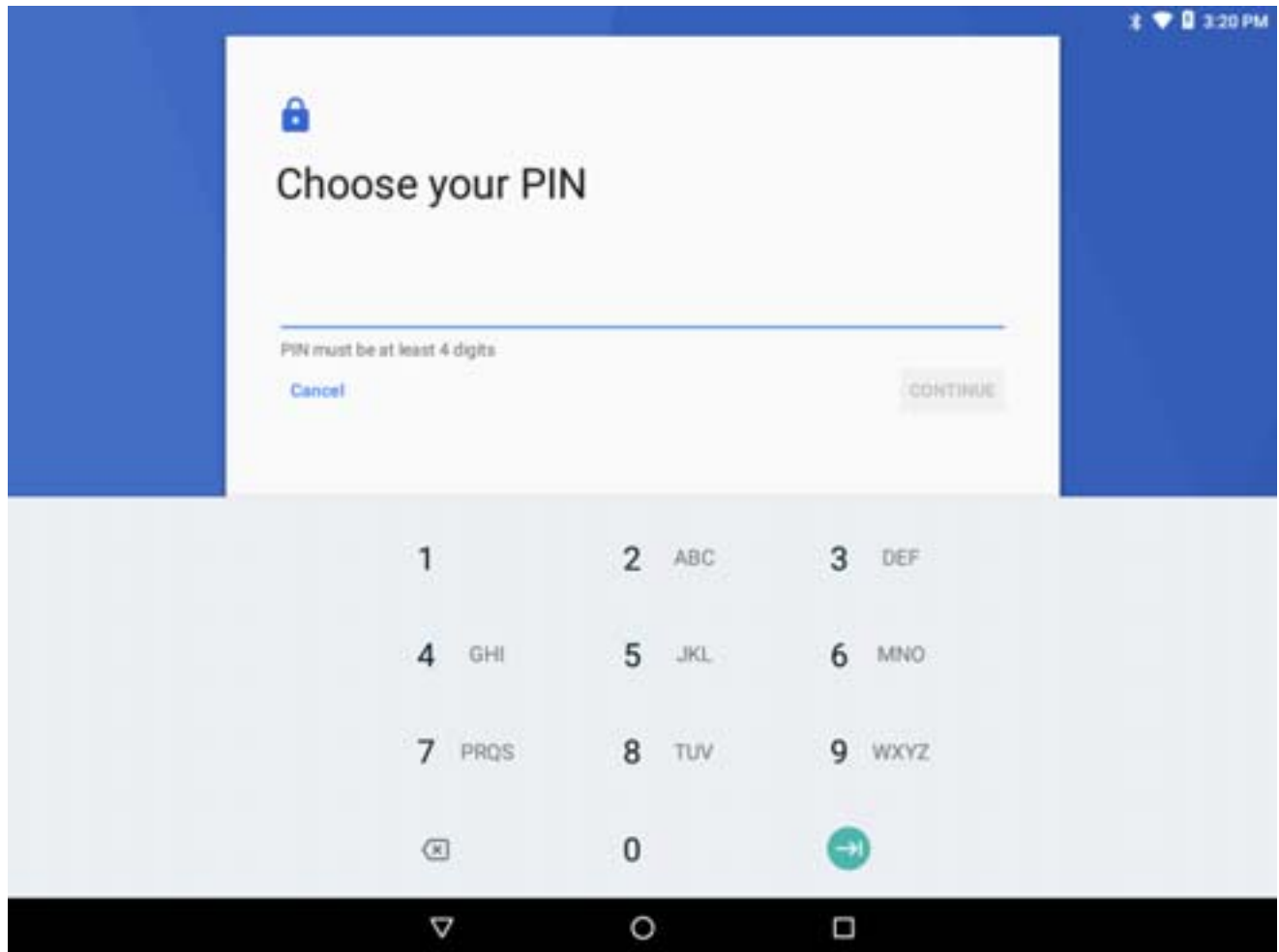
1. Swipe down from the status bar and then touch .
2. Touch  **Security**.
3. Touch **Screen lock**.
4. Touch **PIN**.
5. To require a PIN upon device start up select **Require PIN to start device** or **No thanks** not to require a PIN.

Figure 123 Enter PIN Screen



6. Touch in the text field.
7. Enter a PIN (4 numbers) then touch **Continue**.
8. Re-enter PIN and then touch **OK**.
9. Select the type of notifications that appear when the screen is locked and then touch **DONE**.
10. Touch . The next time the device goes into suspend mode a PIN is required upon waking.

### Set Screen Unlock Using Password



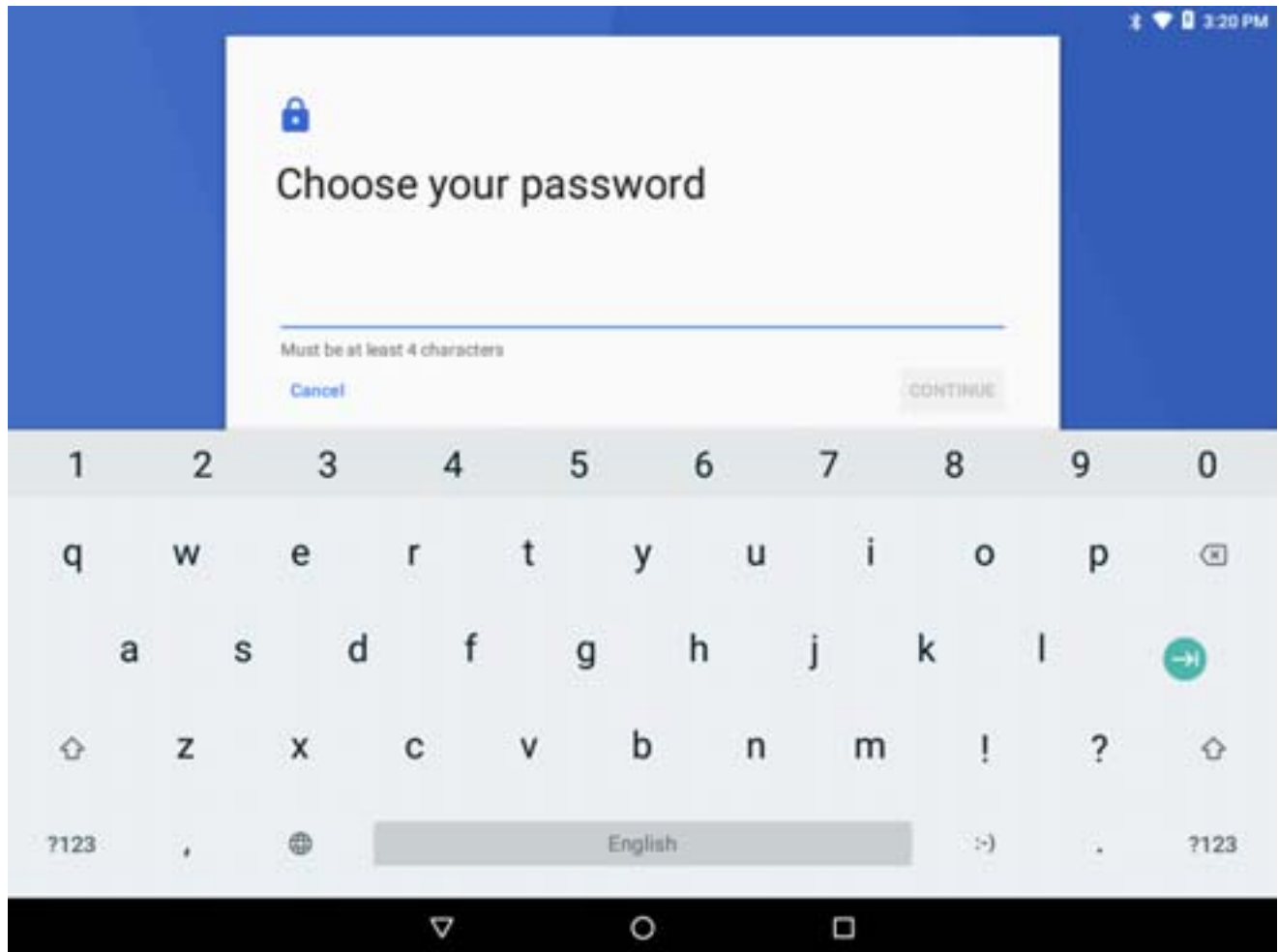


1. Swipe down from the status bar and then touch .
2. Touch  **Security**.
3. Touch **Screen lock**.
4. Touch **Password**.
5. To require a PIN upon device start up select **Require PIN to start device** or **No thanks** not to require a PIN.
6. Touch in the text field.

Figure 124 Enter Password Screen

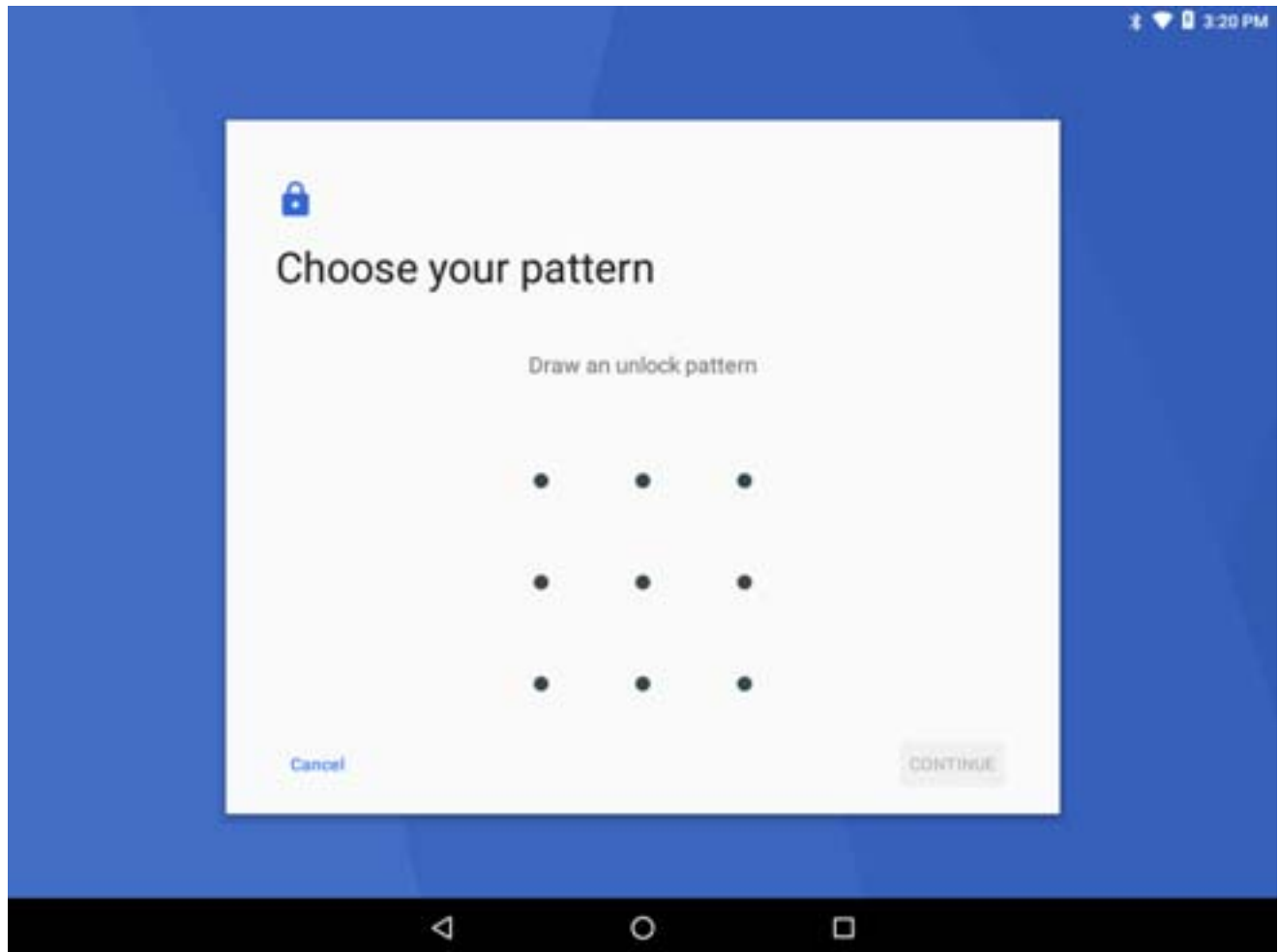



7. Enter a password (between 4 and 16 characters) then touch **Continue**.
8. Re-enter the password and then touch **OK**.
9. Select the type of notifications that appear when the screen is locked and then touch **DONE**.
10. Touch . The next time the device goes into suspend mode a PIN is required upon waking.

### Set Screen Unlock Using Pattern

1. Swipe down from the status bar and then touch .
2. Touch  **Security**.
3. Touch **Screen lock**.
4. Touch **Pattern**.





**Figure 125** Enter Pattern Screen

5. Draw a pattern connecting at least four dots.
6. Touch **Continue**.
7. Re-draw the pattern.
8. Touch **Confirm**.
9. Touch . The next time the device goes into suspend mode a Pattern is required upon waking.

---

## Passwords




To set the device to hide password characters as the user types:

1. Swipe down from the status bar and then touch .
2. Touch  **Security**.
3. Slide the **Make passwords visible** switch to the off position.





## System Language Usage

Use the **Language & input** settings to change the language that display for the text and including words added to its dictionary.





### Adding Languages

1. Swipe down from the status bar and then touch .
2. Touch  **Language & input**.
3. Touch **Languages**.
4. Touch **Add a language**.
5. Scroll through the list and touch a language. The language appears in the language list.
6. Touch .



### Selecting a Language


1. Swipe down from the status bar and then touch .
2. Touch  **Language & input**.
3. Touch **Languages**.
4. Touch and drag a language to the top of the list.
5. Touch . The operating system text changes to the selected language.
6. Touch .

### Removing a Language

1. Swipe down from the status bar and then touch .
2. Touch  **Language & input**.
3. Touch **Languages**.
4. Touch .
5. Touch **Remove**.
6. Select the languages to remove.
7. Touch .
8. Touch **OK**.

### Adding Words to the Dictionary

1. Swipe down from the status bar and then touch .
2. Touch  **Language & input**.
3. Touch **Personal dictionary**.
4. If prompted, select the language that this word or phrase is stored.
5. Touch **+** to add a new word or phrase to the dictionary.
6. Enter the word or phrase.

7. In the **Shortcut** text box, enter a shortcut for the word or phrase.
8. Touch .




---

## Keyboard Settings

Use the **Language & input** settings for configuring the on-screen keyboards.

### Enabling Keyboards





To enable various keyboard input methods:

1. Swipe down from the status bar and then touch .
2. Touch  **Language & input**.
3. Touch **Virtual keyboard**.
4. Touch **Manage keyboards**.
5. Touch one or more of the keyboard input method switches.
6. Touch **OK**.
7. Touch .


When using a keyboard, touch  to switch between the enabled input methods.


### Configuring a Keyboard

To configure a keyboard:

1. On AOSP devices, touch and hold  (comma) > .
2. On GMS devices, touch and hold  (comma) > .
3. Select **Android Keyboard Settings (AOSP)** or **Google keyboard settings** to configure the current keyboard.
4. Select **Languages** to change the language layout of the keyboard.
 

By default, the keyboard uses the default system languages. To override the system languages:

  - a. Touch **Use system languages** to disable the default setting.
  - b. Scroll through the list and select languages for the keyboard.
  - c. Touch .



When using a keyboard, touch  to switch between the enabled keyboard languages.

## Key Programmer

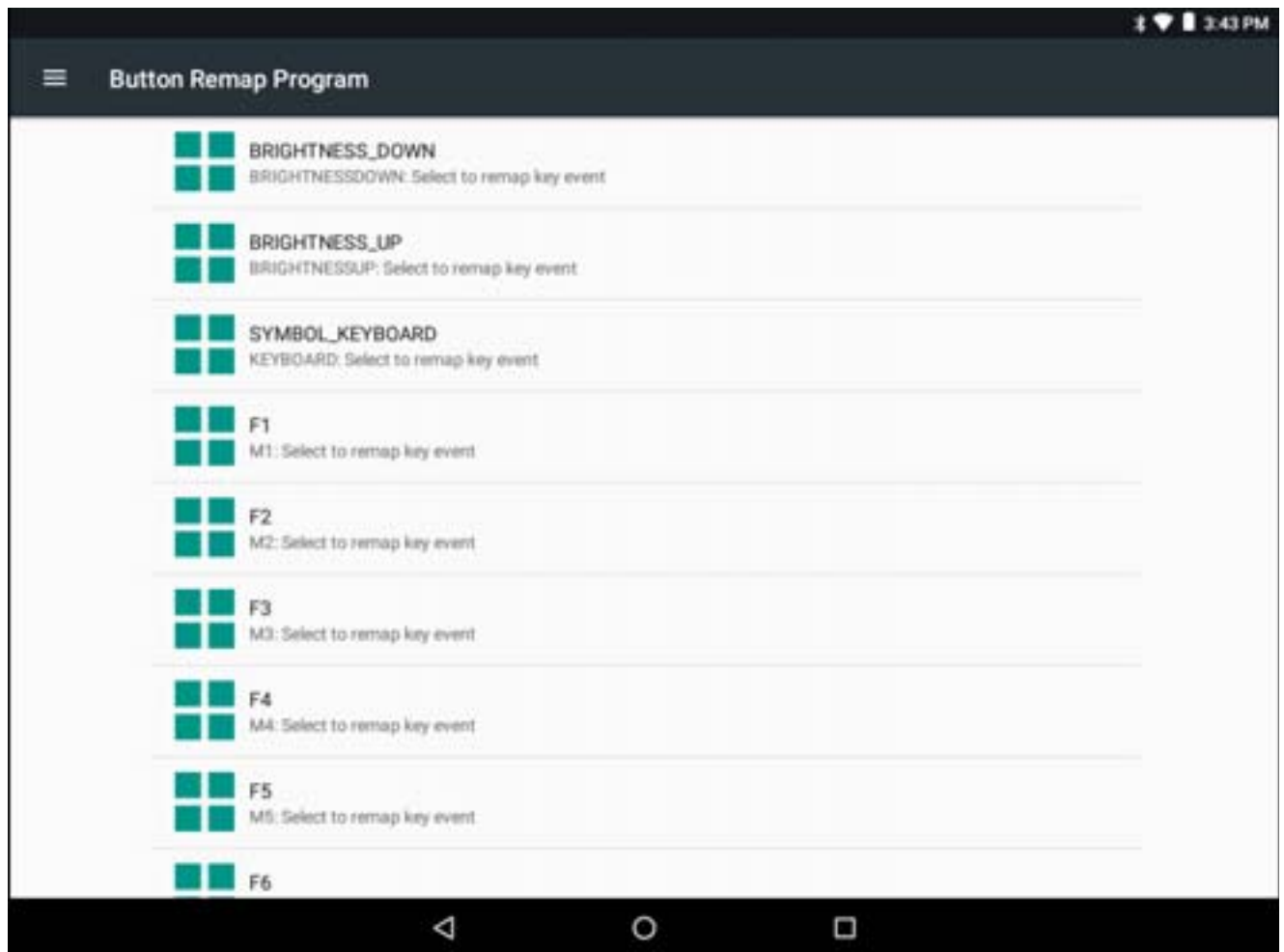
The VC80x's buttons can be programmed to perform different functions or shortcuts to installed applications.

- M1 through M6 keys
- Brightness Up button
- Brightness Down button
- Keyboard button.

### Remapping a Button

1. Swipe down from the status bar and then touch .
2. Touch  **Key Programmer**.

**Figure 126** Key Programmer Screen

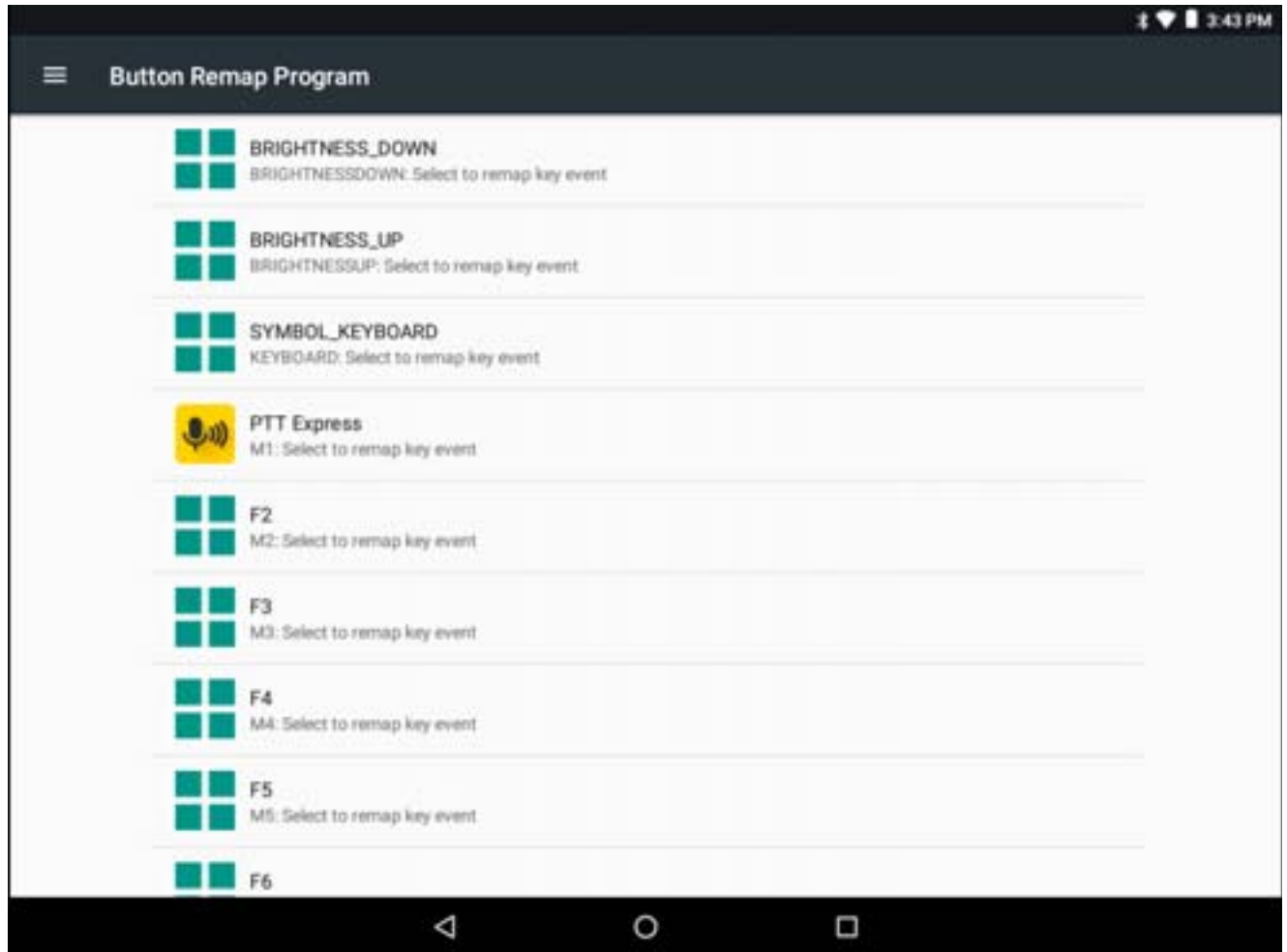



3. Select the button to remap.
4. Touch the **BUTTON REMAPPING, SHORTCUT** or **TRIGGER** tab that lists the available functions and applications.

5. Touch a function or application shortcut to map to the button.

✓ **NOTE** If you select an application shortcut, the application icon appears next to the button on the Key Programmer screen.

**Figure 127** Remapped Button





6. Touch .

---

## About Phone

Use **About phone** settings to view information about the VC80x. Swipe down from the status bar and then touch

 >  **About phone**.

- **Status** - Touch to display the following:
  - **Battery status** - Indicates if the battery is charging (on AC power) or discharging (on battery power).
  - **Battery level** - Indicates the battery charge level.
  - **IP address** - Displays the IP address of the device.
  - **Wi-Fi MAC address** - Displays the Wi-Fi radio MAC address.
  - **Ethernet MAC address** - Displays the Ethernet driver MAC address.
  - **Bluetooth address** - Displays the Bluetooth radio Bluetooth address.
  - **Serial number** - Displays the serial number of the device.
  - **Up time** - Displays the time that the VC80x has been running since being turned on.
- **Battery Information** - Displays information about the battery.
- **SW components** - Lists filenames and versions for various software on the VC80x.
- **Legal information** - Opens a screen to view legal information about the software included on the VC80x.
- **Model** - Displays the device's model number.
- **Part Number** - Displays the device's part number.
- **Android version** - Displays the operating system version.
- **Fingerprint** - Defines Device Manufacturer, Model, Android version and Build version together in one location.
- **Android security patch level** - Displays the security patch level date.
- **Kernel version** - Displays the kernel version.
- **Build number** - Displays the software build number.

# Application Deployment

---

## Introduction

This chapter describes features in Android including new security features, how to package applications, and procedures for deploying applications onto the device.

---

## Security

The device implements a set of security policies that determine whether an application is allowed to run and, if allowed, with what level of trust. To develop an application, you must know the security configuration of the device, and how to sign an application with the appropriate certificate to allow the application to run (and to run with the needed level of trust).



**NOTE** Ensure the date is set correctly before installing certificates or when accessing secure web sites.

---

## Secure Certificates

If the VPN or Wi-Fi networks rely on secure certificates, obtain the certificates and store them in the device's secure credential storage, before configuring access to the VPN or Wi-Fi networks.

If downloading the certificates from a web site, set a password for the credential storage. The device supports X.509 certificates saved in PKCS#12 key store files with a .p12 extension (if key store has a .pfx or other extension, change to .p12).

The device also installs any accompanying private key or certificate authority certificates contained in the key store.



---

## Installing a Secure Certificate

To install a secure certificate:



**IMPORTANT** USB Drive must have FAT32 format.



1. Copy the certificate from the host computer to the root of a USB drive. See [Transferring Files](#) for information about connecting a USB drive to the device and copying files.
2. On the back of the VC80x, remove the dust cover.
3. Plug the USB drive into the USB port on the bottom of the device.
4. Swipe down from the status bar and then touch .
5. Touch  **Security**.
6. Touch **Install from storage**.
7. Navigate to the location of the certificate file (path: /mnt/media\_rw/xxxx-xxxx, where xxx-xxx is the name assigned to the drive).
8. Touch the filename of the certificate to install.
9. If prompted, enter the password for credential storage. If a password has not been set for the credential storage, enter a password for it twice and then touch **OK**.
10. If prompted, enter the certificate's password and touch **OK**.
11. Enter a name for the certificate and in the Credential use drop-down, select **VPN and apps** or **Wi-Fi**.

**Figure 128** Name the Certificate Dialog Box



12. Touch **OK**.  
The certificate can now be used when connecting to a secure network. For security, the certificate is deleted from the USB drive.
13. Swipe down from the status bar.
14. In the **General USB drive** notification, touch **Eject**.
15. Remove the thumb drive from the bottom of the VC80x.
16. Replace the dust cover.

## Configuring Credential Storage Settings

1. Swipe down from the status bar and then touch .
2. Touch  **Security**.
  - **Trusted credentials** - Touch to display the trusted system and user credentials.
  - **Install from storage** - Touch to install a secure certificate from a USB drive.
  - **Clear credentials** - Deletes all secure certificates and related credentials.



---

## Development Tools

### Android

Android development tools are available at [developer.android.com](http://developer.android.com).


To start developing applications for the device, download the development SDK and the Eclipse IDE. Development can take place on a Microsoft® Windows®, Mac® OS X®, or Linux® operating system.


Applications are written in the Java language, but compiled and executed in the Dalvik VM (a non-Java virtual machine). Once the Java code is compiled cleanly, the developer tools make sure the application is packaged properly, including the AndroidManifest.xml file.

The development SDK is distributed as a ZIP file that unpacks to a directory on the host computer hard drive. The SDK includes:

- android.jar
  - Java archive file containing all of the development SDK classes necessary to build an application.
- documentation.html and docs directory
  - The SDK documentation is provided locally and on the Web. It's largely in the form of JavaDocs, making it easy to navigate the many packages in the SDK. The documentation also includes a high-level Development Guide and links to the broader community.
- Samples directory
  - The samples subdirectory contains full source code for a variety of applications, including ApiDemo, which exercises many APIs. The sample application is a great place to explore when starting application development.
- Tools directory
  - Contains all of the command-line tools to build applications. The most commonly employed and useful tool is the adb utility.
- usb\_driver
  - Directory containing the necessary drivers to connect the development environment to an enabled device. These files are only required for developers using the Windows platform.

Open the **Developer options** screen to set development related settings.

By default, the Developer Options are hidden. To un-hide the developer options, swipe down from the status bar and then touch .

Touch  **About device**. Scroll down to **Build number**. Tap **Build number** seven times until **You are now a developer** appears.

Touch    **Developer options**. Slide the switch to the **ON** position to enable developer options.

## EMDK for Android

EMDK for Android provides developers with a comprehensive set of tools to easily create powerful line-of-business applications for enterprise mobile computing devices. It's designed for Google's Android SDK and Android Studio, and includes class libraries, sample applications with source code, and all associated documentation to help your applications take full advantage of what Zebra devices have to offer.

The kit also delivers Profile Manager, a GUI-based device configuration tool providing exclusive access to the Zebra MX device management framework. This allows developers to configure Zebra devices from within their applications in less time, with fewer lines of code and with fewer errors.

For more information go to: [techdocs.zebra.com](http://techdocs.zebra.com).

## StageNow

StageNow is Zebra's next-generation Android Staging Solution, supporting Android Lollipop, KitKat, and Jelly Bean operating systems, and built on the MX 4.3/4.4/5.x/6.0 platform. It allows quick and easy creation of device profiles, and can deploy to devices simply by scanning a barcode, reading a tag, or playing an audio file.

The StageNow Staging Solution includes the following components:

- The StageNow Workstation tool installs on the staging workstation (host computer) and lets the administrator easily create staging profiles for configuring device components, and perform other staging actions such as checking the condition of a target device to determine suitability for software upgrades or other activities. The StageNow Workstation stores profiles and other created content for later use.
- The StageNow Client resides on the device and provides a user interface for the staging operator to initiate staging. The operator uses one or more of the desired staging methods (print and scan a barcode, read an NFC tag or play an audio file) to deliver staging material to the device.

For more information go to: [techdocs.zebra.com](http://techdocs.zebra.com).

The VC80x and StageNow supports staging with the following scanners:

- DS3678, RS6000, and RS507/RS507x Bluetooth scanners
- DS3608 USB SSI scanner
- RS-232 scanners.

To begin using one of the supported scanners for staging:

- Update the firmware on the scanner, if required.
- Connect and configure the scanner See [Data Capture](#) for more information.
- Open StageNow application and scan staging barcodes.

---





## ADB USB Setup

To use the ADB, install the USB driver. This assumes that the development SDK has been installed on the host computer. Go to [developer.android.com/sdk/index.html](http://developer.android.com/sdk/index.html) for details on setting up the development SDK.

ADB driver for Windows and Linux are available on the Zebra Support Central web site at [www.zebra.com/us/en/support-downloads/software/drivers/android-usb-driver.html](http://www.zebra.com/us/en/support-downloads/software/drivers/android-usb-driver.html). Download the ADB and USB Driver Setup package. Following the instructions with the package to install the ADB and USB drivers for Windows and Linux.

## Enabling USB Debugging

By default, USB debugging is disabled. To enable USB debugging:

1. Swipe down from the status bar and then touch .
2. Touch  **About phone**.
3. Scroll down to **Build number**.
4. Tap **Build number** seven times. The message **You are now a developer!** appears.
5. Touch .
6. Touch  **Developer options**.
7. Slide the **USB debugging** switch to the **ON** position.
8. Touch **OK**.
9. Connect the device to the host computer using the Rugged Charge/USB Cable.  
The **Allow USB debugging?** dialog box appears on the device.
10. On the device, touch **OK**.
11. On the host computer, navigate to the `platform-tools` folder.
12. Type `adb devices`.

The following displays:

List of devices attached

XXXXXXXXXXXXXXXXX device (where XXXXXXXXXXXXXXXXXXXX is the device number).



**NOTE** If device number does not appear, ensure that ADB drivers are installed properly.

13. Touch .

---

## Application Installation

After an application is developed, install the application onto the device using one of the following methods:

- USB drive, see [Installing Applications Using a USB Drive on page 219](#).
- Android Debug Bridge, see [Installing Applications Using the Android Debug Bridge on page 220](#).
- Mobile device management (MDM) platforms that have application provisioning. Refer to the MDM software documentation for details.

### Installing Applications Using a USB Drive







**IMPORTANT** USB Drive must have FAT32 format.

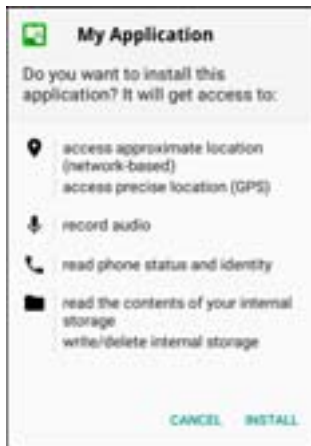
1. Plug the USB drive into the USB port on the host computer.
2. On the host computer, open a file explorer application.
3. Copy the application `.apk` file from the host computer to the USB drive.
4. Eject the USB drive from the host computer.



**CAUTION** Follow the host computer's instructions to eject the USB drive correctly to avoid losing information.

5. Remove the dust cover on the back of the VC80x. See [Figure 3 on page 19](#).
6. Plug the USB drive into the USB port on the VC80x, see [Figure 4 on page 19](#). A notification appears indicating that the VC80x detected the USB drive.
7. Swipe down from the status bar and then touch .
8. Touch  **Security**.
9. Slide the **Unknown sources** switch to the **ON** position.
10. Touch **OK**.
11. Touch .
12. Swipe up from the bottom of the Home screen and touch  **File Browser**.
13. Locate the USB drive as a folder in /storage to view files on the USB drive.
14. Locate the application .apk file.
15. Touch the application file to begin the installation process. The Accept Installation screen appears.

**Figure 129** Accept Installation Screen



16. To confirm installation and accept what the application affects, touch **Install** otherwise touch **Cancel**.
17. Touch **Open** to open the application or **DONE** to exit the installation process. The application appears in the App list.
18. Disconnect the USB drive from the host computer.

## Installing Applications Using the Android Debug Bridge

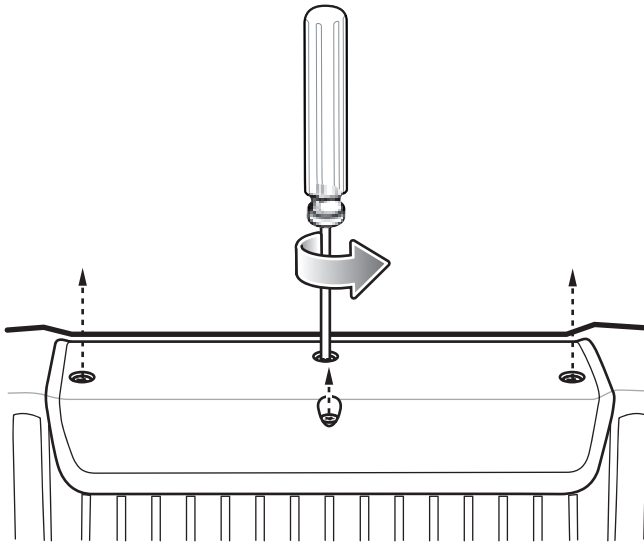
Use ADB commands to install application onto the device.





**CAUTION** When connecting the device to a host computer, follow the host computer's instructions for connecting and disconnecting USB devices, to avoid damaging or corrupting files.

Ensure that the ADB drivers are installed on the host computer. See [ADB USB Setup on page 218](#).

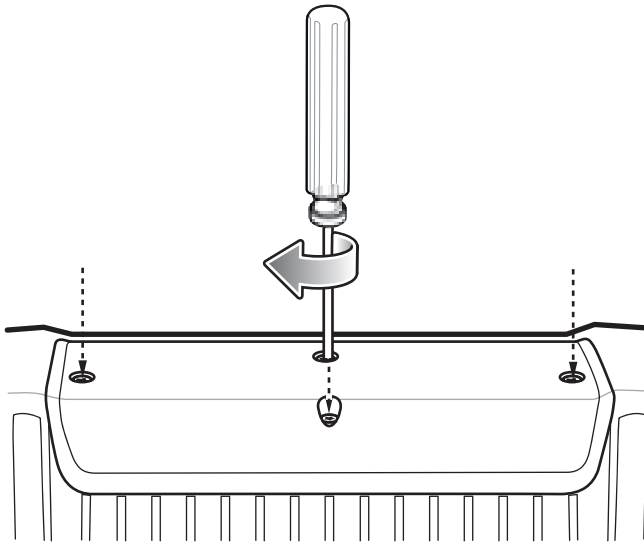
1. Using a T10 Torx screwdriver, remove four screws securing the top cover to the VC80x.

**Figure 130** Remove Top Cover

**IMPORTANT** When the user connects a USB cable to the USB port on top of the VC80x, the USB and RS-232 ports on the bottom are disabled.

2. Connect the device to a host computer using a USB cable.
3. Swipe down from the status bar and then touch .
4. Touch  **Developer options**.
5. Slide the switch to the **ON** position.
6. Touch **USB Debugging**. A check appears in the check box. The **Allow USB debugging?** dialog box appears.
7. Touch **OK**.
8. On the host computer, open a command prompt window and use the adb command:  
`adb install <application>`  
 where: <application> = the path and filename of the apk file.
9. Disconnect the USB cable from the VC80x.
10. Replace the top cover.
11. Secure the top cover to the VC80x using the four screws.

**Figure 131** Replace Top Cover



12. Torque the screws to 6kg-cm (5.2lbs-in).

## Uninstalling an Application

To uninstall an application:



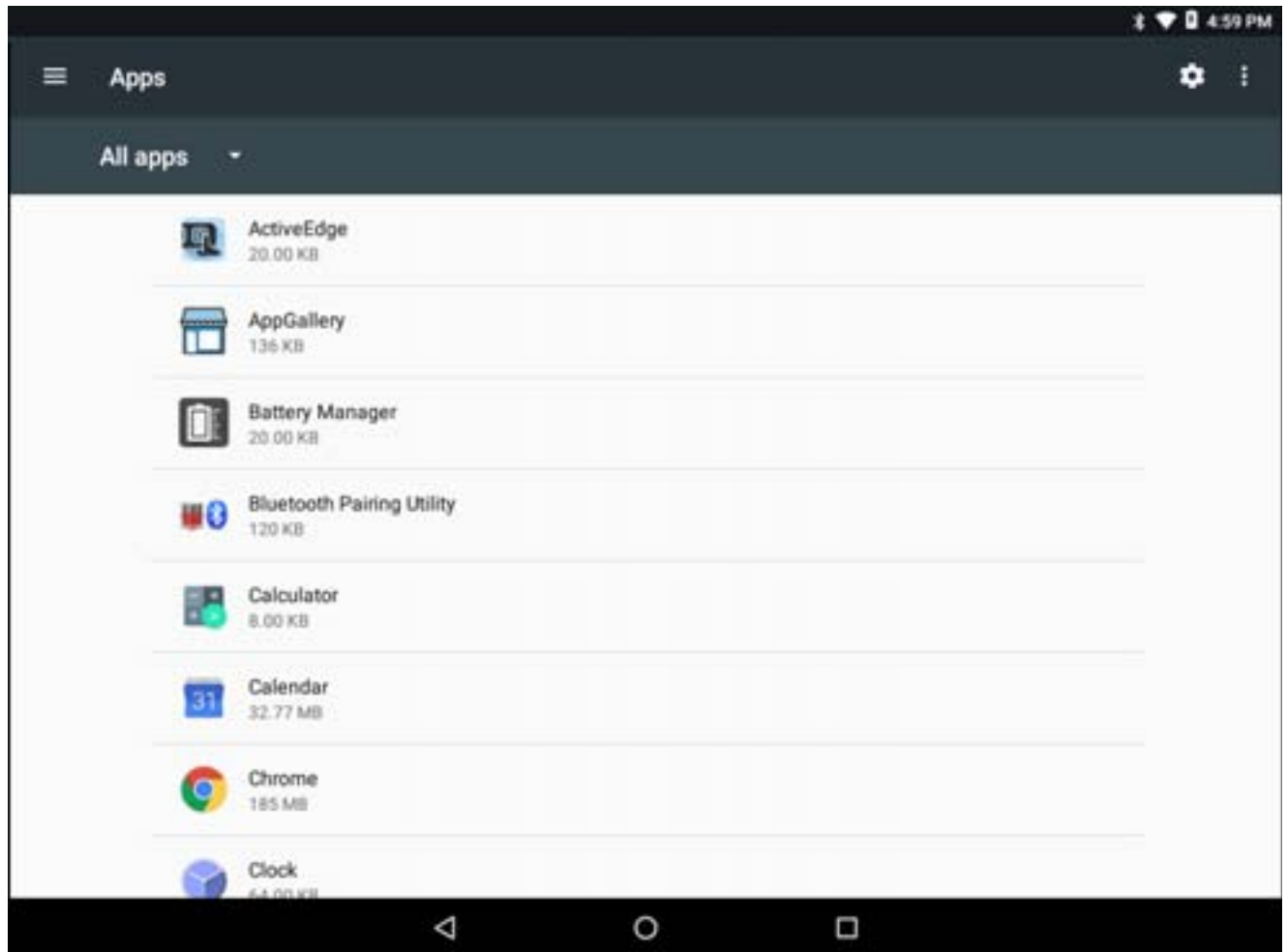
1. Swipe down from the status bar and then touch .
2. Touch  **Apps**.

Figure 132 All Apps Screen



3. Scroll through the list to the application.
4. Touch the application to uninstall.
5. Touch **Uninstall**.
6. Touch **OK** to confirm.

---

## Performing a System Update

System Update packages can contain either partial or complete updates for the operating system. Zebra distributes the System Update packages on the Zebra Support & Downloads web site. Perform system update using either a USB drive or using ADB.

### Download the System Update Package

Download the system update package:

1. Go to the Zebra Support & Downloads web site, [www.zebra.com/support](http://www.zebra.com/support).
2. Download the appropriate System Update package to a host computer.

## Using USB Drive

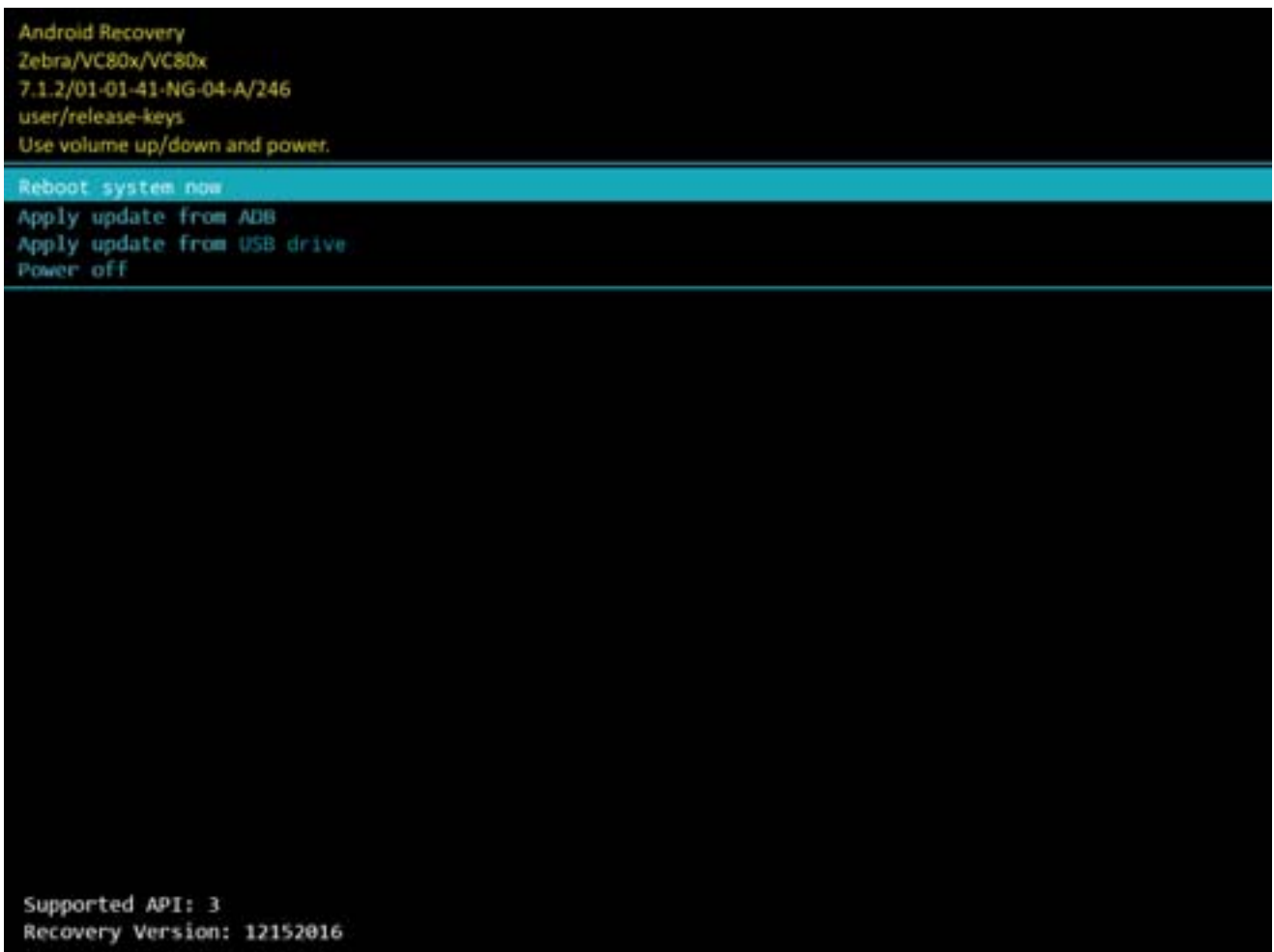
To update the system using a USB drive:



**IMPORTANT** USB drive must have FAT32 format.

1. Install the USB drive into the host computer USB port.
2. Copy the System Update zip file to the root of a USB drive.
3. Properly eject the USB drive from host computer and remove the USB drive.
4. Remove the dust cover from the back of the VC80x.
5. Insert the USB drive into the USB port.
6. Press and hold the Power button until the menu appears.
7. Touch **Reboot**.
8. Touch **OK**. The device resets.
9. Press and hold the **+** button until the Zebra logo screen appears. The System Recovery screen appears.

**Figure 133** System Recovery Screen



10. Press the Volume Up and Volume Down buttons to navigate to **apply from USB drive**.
11. Press the Power button.



12. Use the Volume Up and Volume Down buttons to navigate to the System Update zip file.
13. Press the Power button. The System Update installs and then the device returns to the Recovery screen.
14. Press the Power button to reboot the device.



**NOTE** If installing GMS software on a device that had AOSP software or AOSP software on a device that had GMS software, perform a Factory or Enterprise reset (retains enterprise data).



## Using ADB

To update the system using ADB:

1. Using a T10 Torx screwdriver, remove four screws securing the top cover to the VC80x.



**IMPORTANT** When the user connects a USB cable to the USB port on top of the VC80x, the USB and RS-232 ports on the bottom are disabled.

2. Connect the device to a host computer using a USB cable.
3. On the device, swipe down the status bar and then touch .
4. Touch  **Developer options**.
5. Slide the switch to the **ON** position.
6. Touch **USB Debugging**. A check appears in the check box. The **Allow USB debugging?** dialog box appears.
7. Touch **OK**.
8. On the host computer, open a command prompt window and use the adb command:  

```
adb devices
```

The following displays:  
List of devices attached  
XXXXXXXXXXXXXXXXX device (where XXXXXXXXXXXXXXXXXXXX is the device number).



**NOTE** If device number does not appear, ensure that ADB drivers are installed properly.

9. Type:  

```
adb reboot recovery
```
10. Press Enter. The System Recovery screen appears. See [Figure 133 on page 224](#).
11. Press the Volume Up and Volume Down buttons to navigate to **apply from adb**.
12. Press the Power button.
13. On the host computer command prompt window type:  

```
adb sideload <file>
```



where: <file> = the path and filename of the zip file.
14. Press Enter. The System Update installs (progress appears as percentage in the Command Prompt window) and then the Recovery screen appears.
15. Press the Power button to reboot the device.
16. Replace the top cover.
17. Secure the top cover to the VC80x using the four screws. See [Figure 131 on page 222](#).
18. Torque the screws to 6kg-cm (5.2lbs-in).



**NOTE** If installing GMS software on a device that had AOSP software or AOSP software on a device that had GMS software, perform a Factory or Enterprise reset (retains enterprise data).

## Verify System Update Installation

To check that the system update installed properly:

1. On the device, swipe down from the status bar and then touch .
2. Touch  **About**.
3. Scroll down to **Build number**.
4. Ensure that the build number matches the new system update package file number.

---

## Performing an Enterprise Reset

An Enterprise Reset erases all data in the /cache and /data partitions and clears all device settings, except those in the /enterprise partition.

Before performing an Enterprise Reset, copy all applications and the key remap configuration file that you want to persist after the reset into the /enterprise/usr/persist folder.

Perform Enterprise Reset using either a USB drive or using ADB.

## Download the Enterprise Reset Package

Download the system update package:



1. Go to the Zebra Support web site, [www.zebra.com/support](http://www.zebra.com/support).
2. Download the Enterprise Reset file to a host computer.

## Using a USB Drive

1. Copy the Enterprise Reset zip file to the root of the USB drive.
  - Copy the zip file to a USB drive using a host computer and then installing the USB drive into the device.
  - Connect the device with a USB drive already installed to the host computer and copy zip file to the USB drive. Disconnect the device from the host computer.
2. Press and hold the Power button until the menu appears.
3. Touch **Reboot**.
4. Touch **OK**. The device resets.
5. Press and hold the **+** button until the device vibrates. The Android Recovery screen appears.
6. Press the Up and Down Volume buttons to navigate to the **apply update from USB drive**.
7. Press the Power button.
8. Press the Up and Down Volume buttons to navigate to the Enterprise Reset file.
9. Press the Power button. The Enterprise Reset occurs and then the device returns to the Recovery screen.
10. Press the Power button.

## Using ADB

To perform an Enterprise Reset using ADB:

1. Using a T10 Torx screwdriver, remove four screws securing the top cover to the VC80x. See [Figure 130 on page 221](#).
2. Connect the device to a host computer using a micro USB cable.
3. On the device, swipe down from the status bar and then touch .
4. Touch  **Developer options**.
5. Slide the switch to the **ON** position.
6. Touch **USB Debugging**. A check appears in the check box. The **Allow USB debugging?** dialog box appears.
7. Touch **OK**.
8. On the host computer, open a command prompt window and type:

```
adb devices.
```

The following displays:

```
List of devices attached
```

```
XXXXXXXXXXXXXXXXX device (where XXXXXXXXXXXXXXXXXXXX is the device number).
```

✓ **NOTE** If device number does not appear, ensure that ADB drivers are installed properly.

9. Type:
 

```
adb reboot recovery
```
10. Press Enter. The Android Recovery screen appears.
11. Press the Volume Up and Volume Down buttons to navigate to **apply update from adb**.
12. Press the Power button.
13. On the host computer command prompt window type:
 

```
adb sideload <file>
```

where: <file> = the path and filename of the zip file.
14. Press Enter. The Enterprise Reset package installs and the device reboots.
15. Replace the top cover.
16. Secure the top cover to the VC80x using the four screws. See [Figure 131 on page 222](#).
17. Torque the screws to 6kg-cm (5.2lbs-in).

---

## Performing a Factory Reset

A Factory Reset erases all data in the /cache, /data and /enterprise partitions in internal storage and clears all device settings. A Factory Reset returns the device to the last installed operating system image. To revert to a previous operating system version, re-install that operating system image. See [Performing a System Update on page 223](#) for more information.

## Download the Factory Reset Package

Download the Factory Reset package:

1. Go to the Zebra Support & Downloads web site, [www.zebra.com/support](http://www.zebra.com/support).



2. Download the appropriate Factory Reset file to a host computer.

## Using a USB Drive

1. Copy the Factory Reset zip file to the root of the USB drive.
  - Copy the zip file to a USB drive using a host computer and then installing the USB drive into the device.
  - Connect the device with a USB drive already installed to the host computer and copy the zip file to the USB drive. Disconnect the device from the host computer.
2. Press and hold the Power button until the menu appears.
3. Touch **Reboot**.
4. Touch **OK**. The device resets.
5. Press and hold the **+** button until the device vibrates. The System Recovery screen appears.
6. Press the Up and Down Volume buttons to navigate to the **apply update from USB drive**.
7. Press the Power button.
8. Press the Up and Down Volume buttons to navigate to the Android Reset file.
9. Press the Power button. The Factory Reset occurs and then the device returns to the Recovery screen.
10. Press the Power button.

## Using ADB

To perform an Factory Reset using ADB:

1. Using a T10 Torx screwdriver, remove four screws securing the top cover to the VC80x. See [Figure 130 on page 221](#).
2. Connect USB cable to the device.
3. Connect the USB cable to the host computer.
4. On the device, swipe down from the status bar and then touch .
5. Touch  **Developer options**.
6. Slide the switch to the **ON** position.
7. Touch **USB Debugging**. A check appears in the check box. The **Allow USB debugging?** dialog box appears.
8. Touch **OK**.
9. On the host computer, open a command prompt window and use the adb command:  
adb reboot recovery
10. Press Enter. The Android Recovery screen appears.
11. Press the Volume Up and Volume Down buttons to navigate to **apply from adb**.
12. Press the Power button.
13. On the host computer, open a command prompt window and use the adb command:  
adb devices.

The following displays:

List of devices attached

XXXXXXXXXXXXXXXXX device (where XXXXXXXXXXXXXXXXXXXX is the device number).



**NOTE** If device number does not appear, ensure that ADB drivers are installed properly.

14. Type:  
`adb sideload <file>`  
where: <file> = the path and filename of the zip file.
15. Press Enter. The Factory Reset package installs and then the device reboots.
16. Replace the top cover.
17. Secure the top cover to the VC80x using the four screws. See [Figure 131 on page 222](#).
18. Torque the screws to 6kg-cm (5.2lbs-in).

---

## Storage

The device contains four types of file storage:

- Random Access Memory (RAM)
- Internal storage
- External storage (USB drive)
- Enterprise folder.

## Random Access Memory

Executing programs use RAM to store data. Data stored in RAM is lost upon a reset. The operating system manages how applications use RAM. It only allows applications and component processes and services to use RAM when required. It may cache recently used processes in RAM, so they restart more quickly when opened again, but it will erase the cache if it needs the RAM for new activities.

To view the amount of free and used memory:



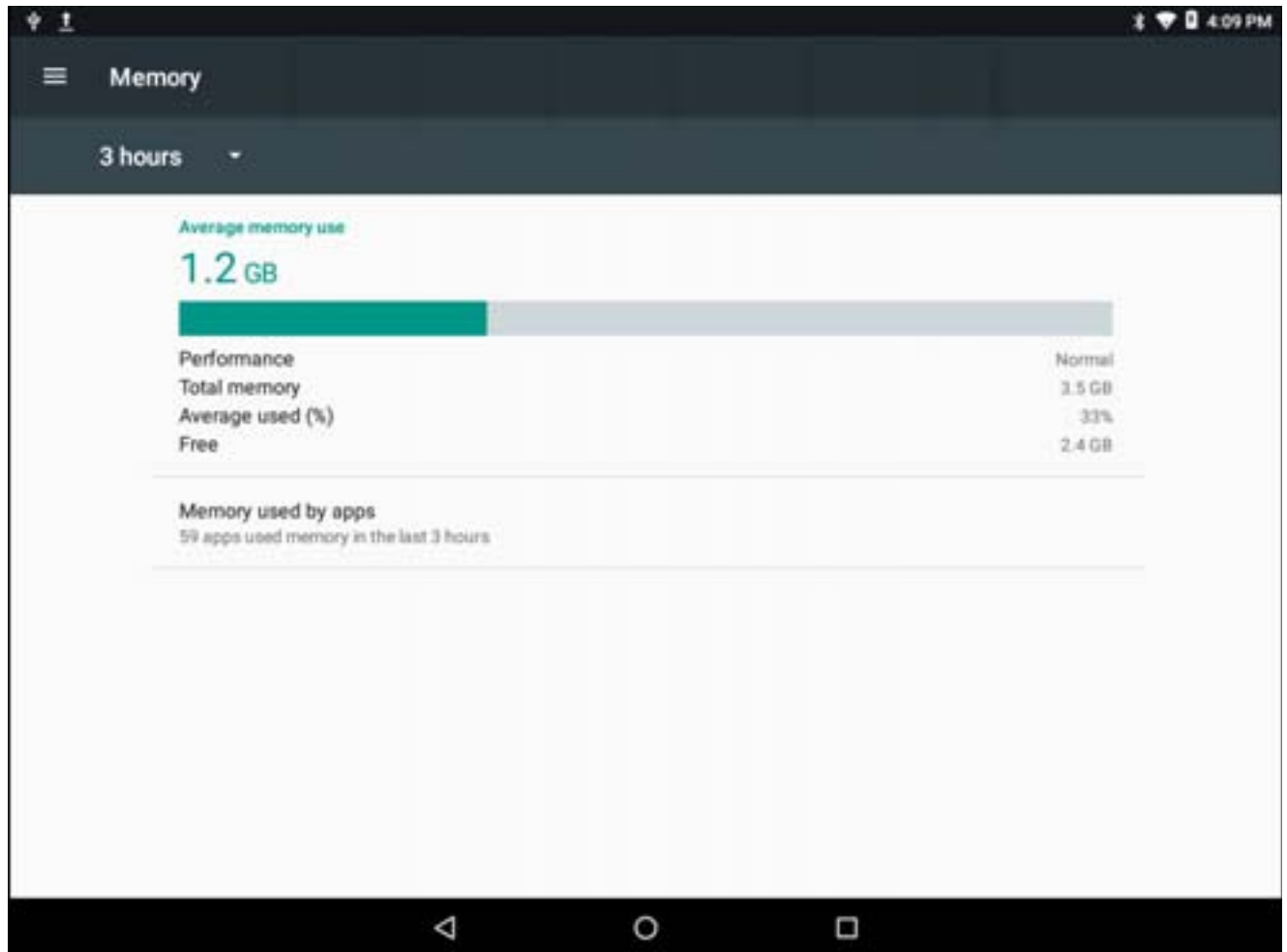
1. Swipe down from the status bar and then touch .
2. Touch  **Memory**.

Figure 134 Memory Screen



The screen displays the amount of used and free RAM.

## Internal Storage

The device has internal storage. The internal storage content can be viewed and files copied to and from when the device is connected to a host computer. Some applications are designed to be stored on the internal storage rather than in internal memory.

To view the used and available space on the internal storage:



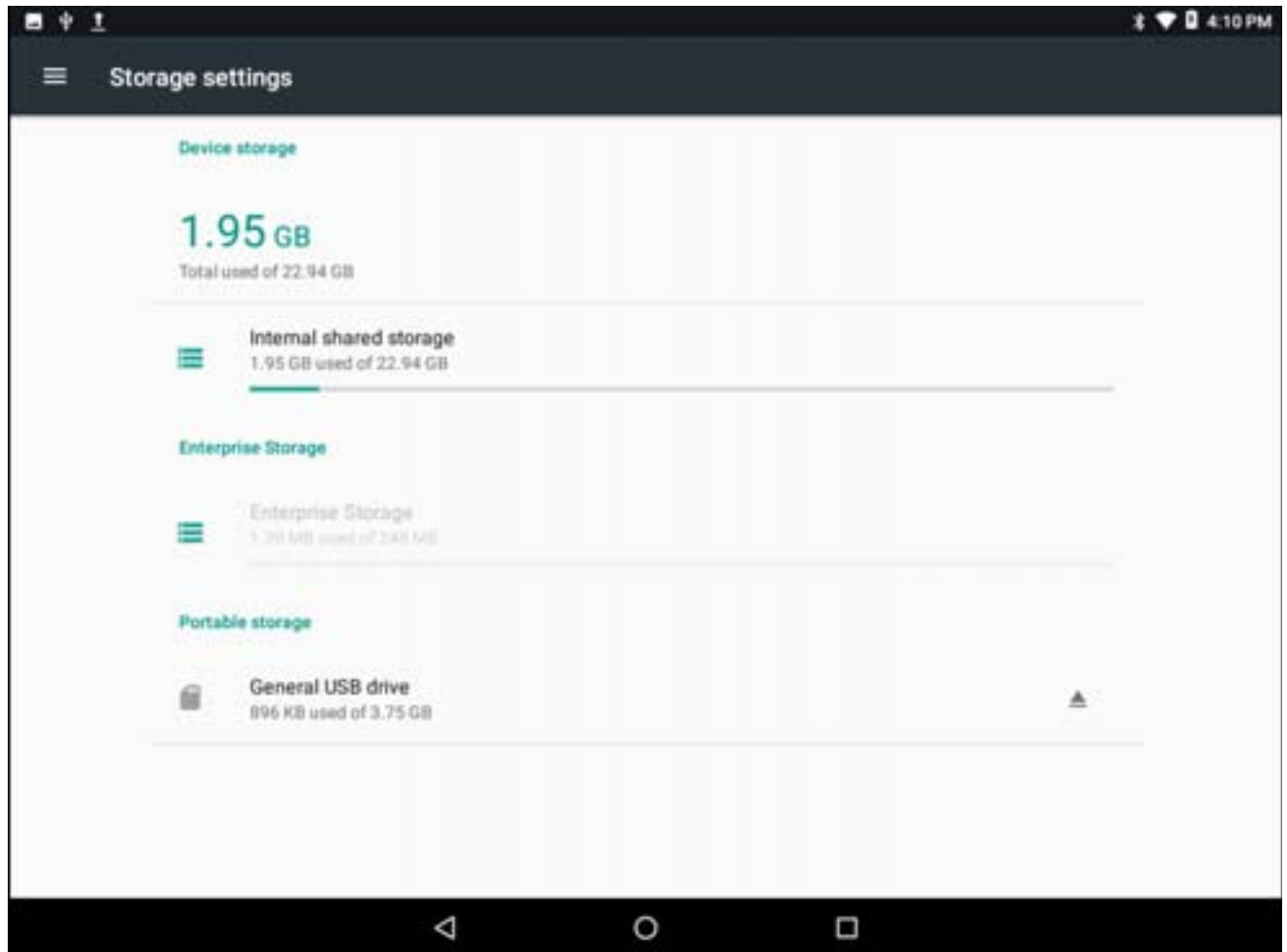
1. Swipe down from the status bar and then touch .
2. Touch  **Storage**.

Figure 135 Storage Screen



- **Internal shared Storage** - Displays the total amount of space on internal storage and amount used.

Touch **Internal shared storage** to display a the amount of storage used by apps, photos, videos, audio and other files.

Figure 136 Internal Storage Screen



## External Storage

The VC80x can have a removable USB drive. The user can view and copy content to and from the USB drive to the VC80x.

To view the used and available space on the USB drive:



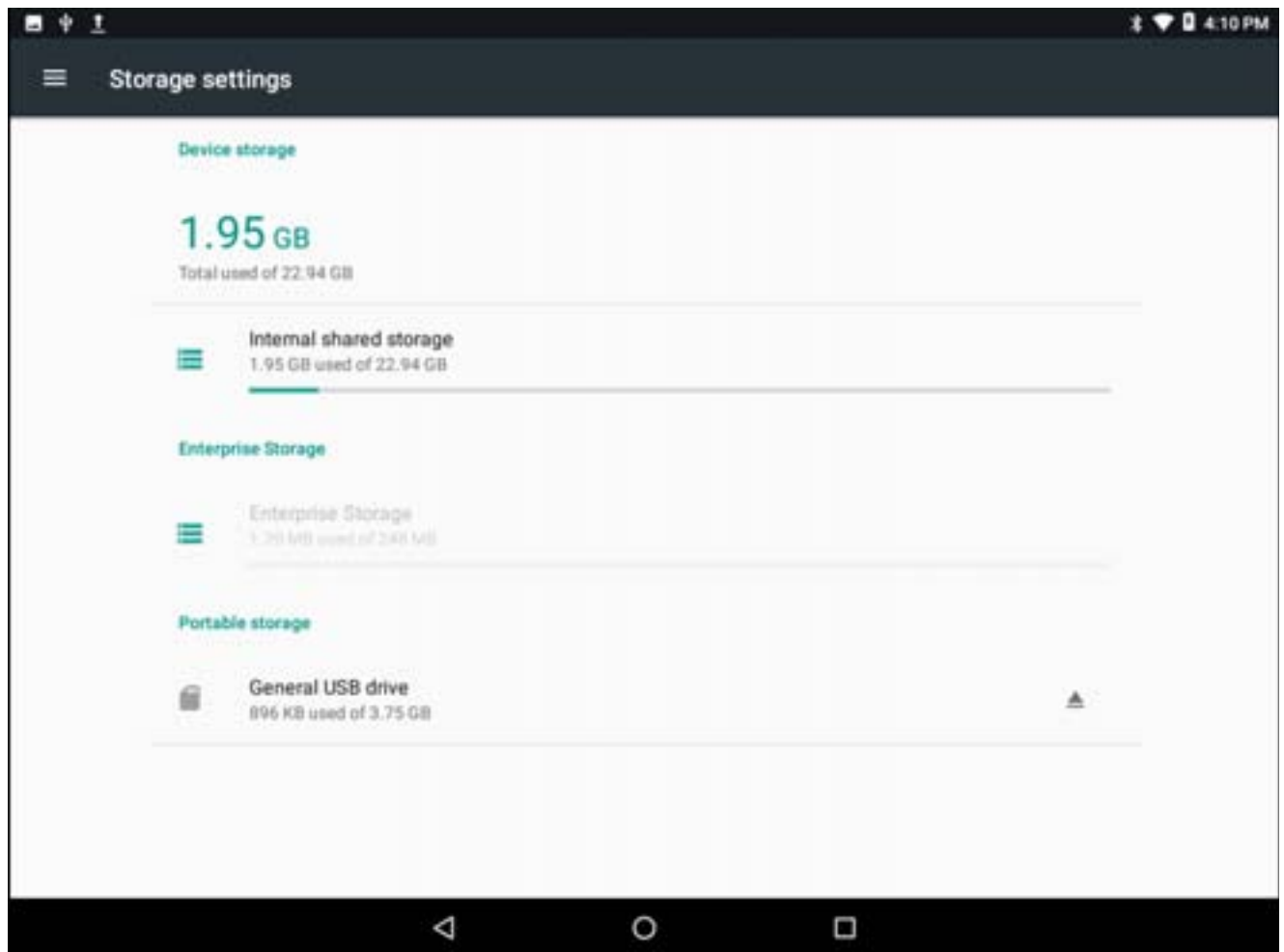

1. Swipe down from the status bar and then touch .
2. Touch  **Storage**.



Figure 137 Storage Screen

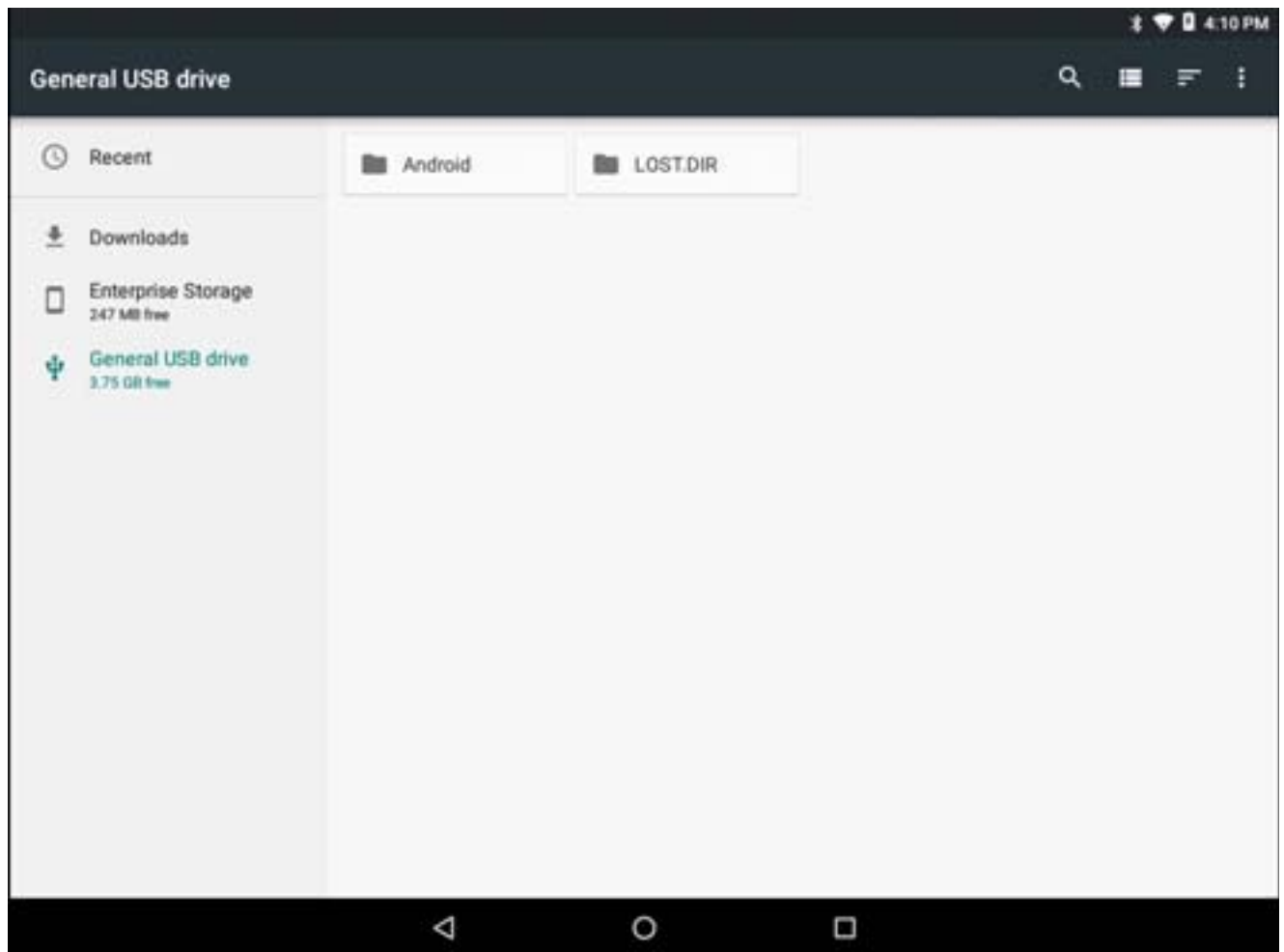


Portable storage displays the total amount of space on the installed USB drive and the amount used.

To unmount the USB drive, touch .

Touch **General USB Drive** to view the contents of the card.

**Figure 138** USB Drive Contents List

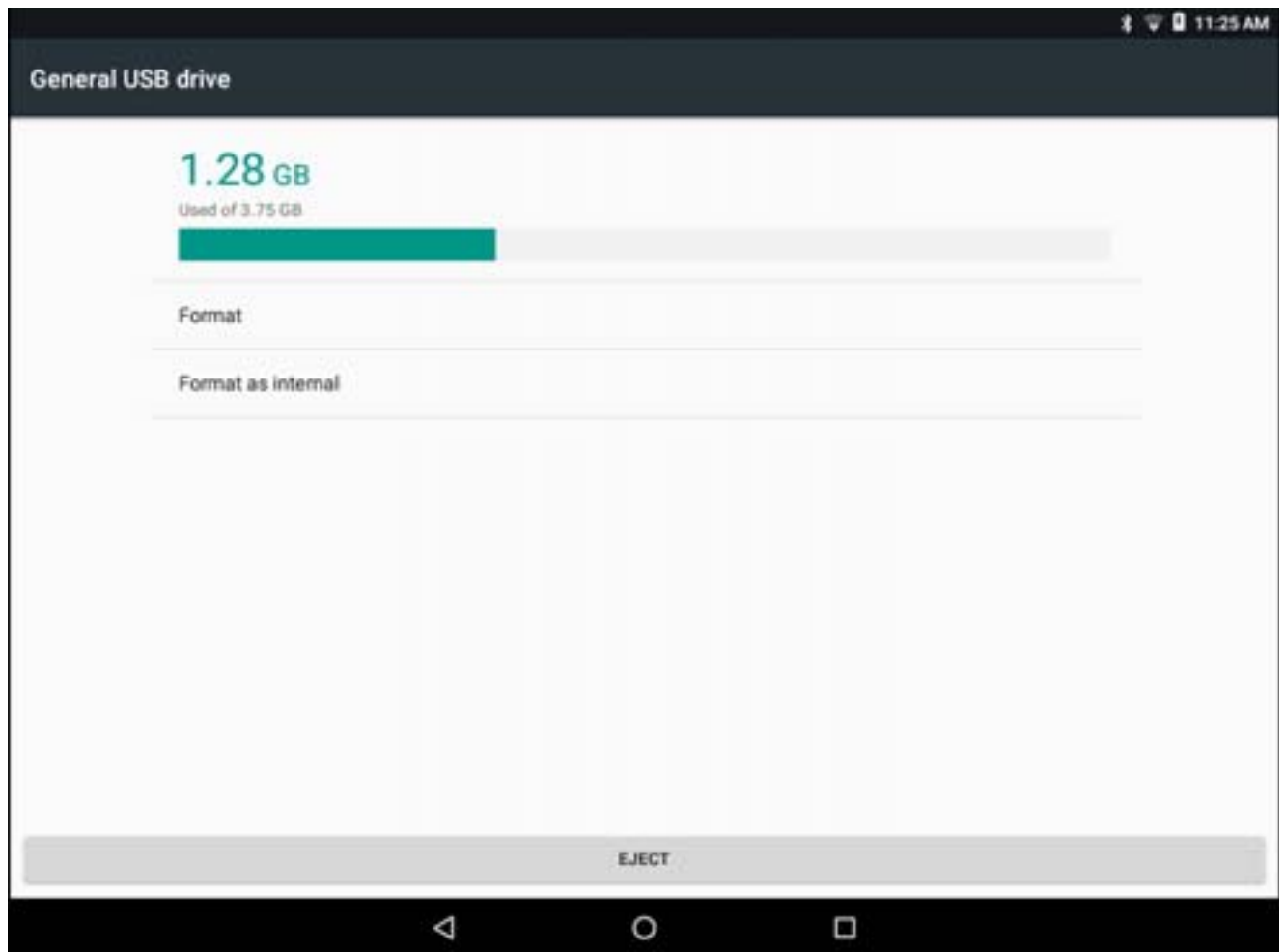


## Formatting a USB Drive

To format an installed USB drive as portable storage:

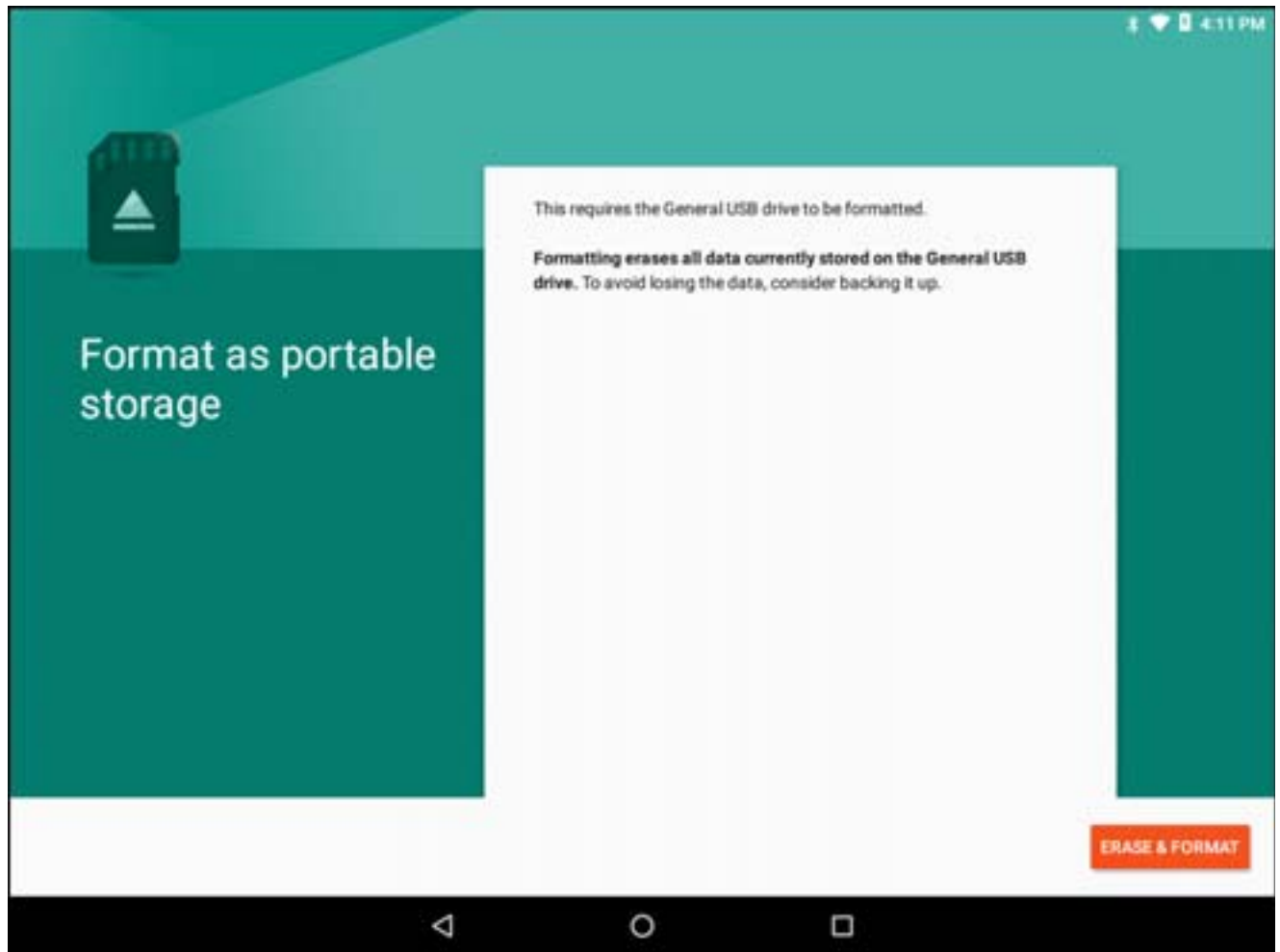
1. Touch **General USB Drive**.
2. Touch **☰** > **Storage Settings**.

Figure 139 USB Drive Settings Screen



3. Touch **Format**.

Figure 140 Format Screen



4. Touch **ERASE & FORMAT**.
5. Touch **DONE**.

## Enterprise Folder

The Enterprise folder (within internal flash) is a super-persistent storage that is persistent after a reset and an Enterprise Reset. The Enterprise folder is erased during a Factory Reset. The Enterprise folder is used for deployment and device-unique data. The Enterprise folder is approximately 248 MB (formatted). Applications can persist data after an Enterprise Reset by saving data to the enterprise/user folder. The folder is ext4 formatted and is only accessible from a host computer using ADB or from an MDM.

---

## Application Management

Applications use two kinds of memory: storage memory and RAM. Applications use storage memory for themselves and any files, settings, and other data they use. They also use RAM when they are running.



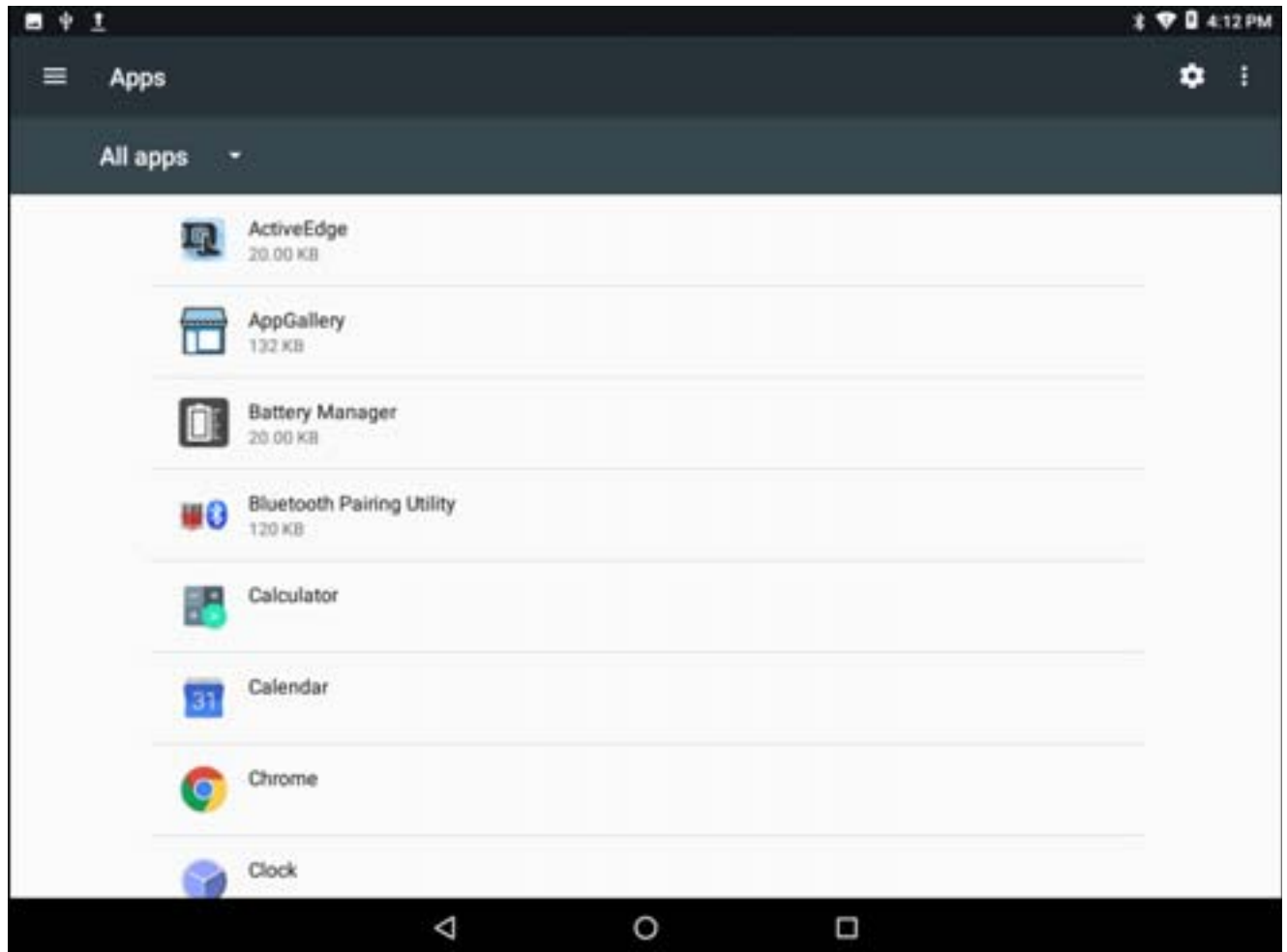
1. Swipe down from the status bar and then touch .
2. Touch  **Apps**.

Figure 141 Apps Screen



Touch  > **Show system** to include system processes in the list.

Touch an application, process, or service in the list to open a screen with details about it and, depending on the item, to change its settings, permissions, notifications and to force stop or uninstall it.

## Viewing Application Details

Applications have different kinds of information and controls, but commonly include:




- **Force stop** - stop an application.
- **Uninstall** - remove the application and all of its data and settings from the device. See [Uninstalling an Application on page 222](#) for information about uninstalling applications.
- **Storage** - lists how much information is stored, and includes a button for clearing it.
- **Data usage** - indicates the amount of data that the application uses for a specific timeframe.
- **Permissions** - lists the areas on the device that the application has access to.
- **Notification** - set the application notification settings.
- **Open by default** - clears If you have configured an application to launch certain file types by default, you can clear that setting here.
- **Battery** - lists the amount of computing power used by the application.

- **Memory** - lists the average application memory usage.

---

## Managing Downloads

Files and applications downloaded using the Browser or Email are stored in the Download directory. Use the **Downloads** application to view, open, or delete downloaded items.

1. Swipe the screen up and touch .
2. Touch an item to open it.
3. Touch headings for earlier downloads to view them.
4. Touch and hold an item, select items to delete and touch . The item is deleted from storage.
5. Touch  > **By name** or **By date modified** or **By size** to switch between them.

When an application is opened, the other applications being used do not stop. The operating system and applications work together to ensure that applications not being used do not consume resources unnecessarily, stopping and starting them as needed. For this reason, there's no need to stop applications unless it is not functioning properly.

# Maintenance and Troubleshooting

---

## Introduction

This chapter includes instructions on cleaning the device and provides troubleshooting solutions for potential problems during device operations.



### **WARNING**

**Danger due to electric shock when cleaning and maintaining the device. To avoid electric shock, turn the VC80x off and disconnect it from the power supply before cleaning or maintaining it.**

---

## Cleaning



**CAUTION** Do not use compressed air, a high-pressure cleaner or vacuum cleaner, as this can damage the surface. Using a high-pressure cleaner poses the additional risk of water entering the device and damaging the electronics or display.

### **Housing Cleaning**

Clean the fully assembled VC80x vehicle mount computer housing using only a mild detergent on a lightly dampened soft cloth.

### **Touchscreen Cleaning**

Use neutral detergent or isopropyl alcohol on a clean soft cloth to clean the panel surface. Do not use any kind of chemical solvent, acidic or alkali solution.

---

## Touchscreen

The VC80x is equipped with a resistive touchscreen.



**CAUTION** Keep the touchscreen clean (see [Touchscreen Cleaning on page 239](#)).

Do not apply adhesives to the surface.

Avoid high voltage and/or static charge.

Do not use ball point pens, writing utensils, tools, or sharp objects.

Touch the panel with your finger or stylus only to ensure normal operation.

Operate in a stable environment. Abrupt variation of temperature and humidity may cause malfunction.

Avoid applying excessive activation force or sudden impact on the touchscreen surface.



Operation of the resistive touch screen is recommended with:

- Clean, dry fingers.
- Clean, dry, soft gloves.
- Suitable touch stylus (plastic or wood, rounded tip).

---

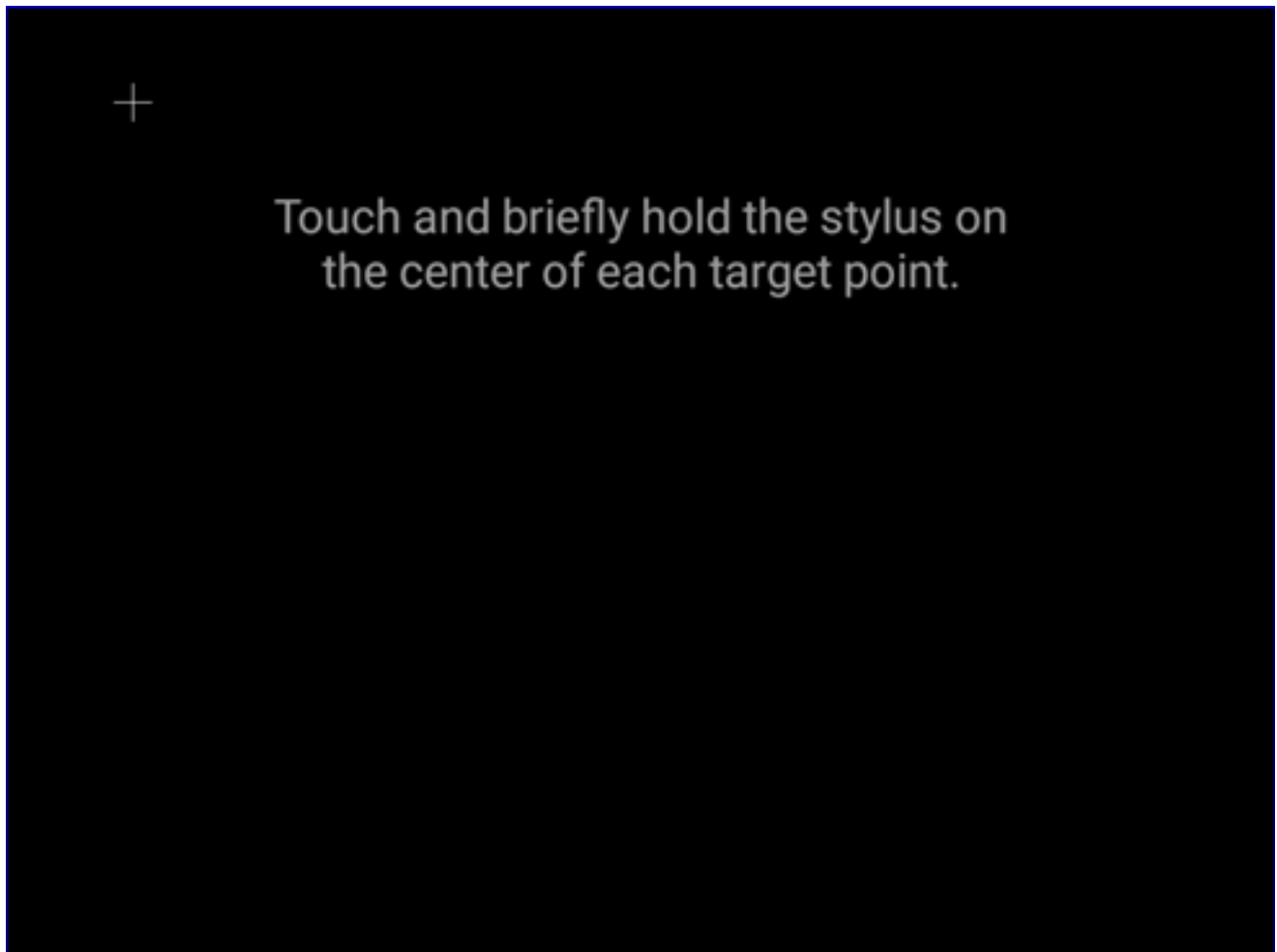
## Screen Calibration

To calibrate the screen so the cursor on the touch screen aligns with the tip of finger or stylus:

1. Swipe down from the status bar and then touch .
2. Touch  **Display**.
3. Touch **Touch Calibration**.



**Figure 142** Touch Screen Calibration



4. Carefully press and briefly hold the tip of finger or stylus on the center of each target that appears on the screen.
5. Repeat as the target moves around the screen.
6. After touching the final target, the calibration screen disappears.

## Troubleshooting

**Table 12** Troubleshooting

Symptom	Possible Cause	Solution
The vehicle computer does not power on or shuts off suddenly.	The power cable ignition sense wire (yellow) is not connected properly.	Verify that the power cable is connected properly. See <a href="#">Wiring Vehicle Power to the VC80x on page 28</a> .
	Power cable not connected properly or unplugged.	Connect power cable to power cable portion underside of vehicle computer. Turn the main power switch on.
	If the vehicle computer is powered by a vehicle battery, the vehicle battery is depleted.	Replace or charge the vehicle battery.
Cannot see characters on display.	Vehicle computer not powered on (Power LED is Off).	Press the Power button on.
	Screen is too dark.	Adjust the brightness; see <a href="#">Figure 1 on page 18</a> .
	The vehicle computer is in suspend mode (Power LED is on).	Press the Power button to turn on the vehicle computer.
The touchscreen is not working.	Replacement screen protector was damaged.	Replace screen protector.
	Touch screen is damaged.	See system administrator.
Touches on screen not aligned with items on display.	Screen calibration is off.	Re-calibration the touch screen. See <a href="#">Screen Calibration on page 240</a> .

**Table 12** Troubleshooting (Continued)

Symptom	Possible Cause	Solution
The optional serial scanner does not operate.	Scanner is not properly connected to the vehicle computer.	Connect the scanner to the COM1 or COM2 port. Ensure the proper COM port is selected in the <b>VC Settings</b> application, see <a href="#">Connecting an RS-232 Scanner on page 108</a> . If the problem continues, refer to the scanner Product Reference Guide.
	External power is not connected.	Verify external power connection.
	Power is not applied to COM port.	Enable power to COM ports. See <a href="#">VC Settings on page 66</a> .
	Serial COM port in not enabled in DataWedge.	Enable the serial COM port in the DataWedge profile. See <a href="#">Serial Port Input from Serial Port 1 on page 166</a> or <a href="#">Serial Port Input from Serial Port 2 on page 166</a> .
	USB cable is connected to USB port on top of VC80x.	Disconnect USB cable from top of VC80x.
The optional USB scanner does not operate.	USB cable is connected to USB port on top of VC80x.	Disconnect USB cable from top of VC80x.
	Scanner not configured for correct protocol (SSI or HID)	Configure scanner to correct protocol. See <a href="#">Data Capture</a> .
	USB connector not connected properly.	Remove USB cable and re-connect.
No sound is heard when you tap the touchscreen or press a key.	Volume is turned down.	Adjust the volume; see <a href="#">Figure 1 on page 18</a> .
	Application currently running disabled the sound.	Configure the application to enable the sound.
	Faulty speaker.	Contact Zebra support at <a href="http://www.zebra.com/support">www.zebra.com/support</a> .
	The optional M1000 speakerphone/mic is connected to the VC80x.	Normal operation, sound is through speaker / mic.
Missing pixels on the display.	Faulty LCD.	Contact Zebra support. See <a href="http://www.zebra.com/support">www.zebra.com/support</a> .
COM1 or COM2 port is not working.	Another application, or DataWedge is using the port.	Stop the application using the port or change the DataWedge COM Port Settings.
	USB cable connected to the USB port on top of the VC80x.	Disconnect USB cable from USB port on top of the VC80x.

**Table 12** Troubleshooting (Continued)

Symptom	Possible Cause	Solution
No keys are working on the optional or built-in keyboard.	The optional keyboard is not properly connected to the vehicle computer.	Check the cable connections between the keyboard and the vehicle computer.
	The application does not require keyboard input.	Configure the application to use the keyboard.
	Vehicle computer is not responding.	Warm boot the vehicle computer.
The vehicle computer cannot find any Bluetooth devices nearby.	Too far from other Bluetooth devices.	Move closer to the other Bluetooth device(s).
	The Bluetooth device(s) nearby are not turned on.	Turn on the Bluetooth device(s).
	The Bluetooth device(s) are not in discoverable mode.	Set the Bluetooth device(s) to discoverable mode. If needed, refer to the device's user documentation for help.
When installed on some electric forklifts, the scanner range is shorter than it is when installed on other forklifts.	Electro-magnetic interference caused by the forklift.	Consult forklift vendor about reducing the interference by adding a capacitor between the forklift chassis and its battery's negative terminal, or another recommended solution.
Wi-Fi Signal strength degraded.	Incorrect antenna selection.	Check antenna selection. See <a href="#">VC Settings on page 66</a> .
	Damaged external antenna.	Either right or left external antenna broken or not connected properly.
	Using wrong antenna.	See accessory list for correct antenna for VC80x.
Cannot find Bluetooth devices.	Incorrect antenna selection.	Check antenna selection. See <a href="#">VC Settings on page 66</a> .
	Damaged external antenna.	Right external antenna broken or not connected properly.
	Using wrong antenna.	See accessory list for correct antenna for VC80x.

# Specifications

---

## Introduction

The following tables summarize the device's intended operating environment and technical specifications.

---

## Technical Specifications

**Table 13** Technical Specifications

Item	Description
<b>Physical and Environmental Characteristics</b>	
Dimensions	10.9 in. L x 9.4 in. W x 3.5 in. D 276 mm L x 238 mm W x 90 mm D
Weight	3.7 kg (8.1 lbs)
Display: Size Resolution Brightness	10.4 in. color XGA 1024 x 768 LCD with LED backlight; 24 bit color depth 400 NITs or 1000 NITs
UPS and Backup Battery	Rechargeable UPS battery for operation during power loss; Internal rechargeable battery for multiple months of real-time clock backup
IP Sealing	IP 66
Interface Ports	Standard sealed and secured connectors: <ul style="list-style-type: none"><li>• Two RS-232 serial port</li><li>• One standard USB port</li><li>• One powered USB port</li><li>• One 3.5 mm audio jack</li></ul>
Thermal Shock	-30°C to 50°C (-22°F to 122°F)

**Table 13** Technical Specifications (Continued)

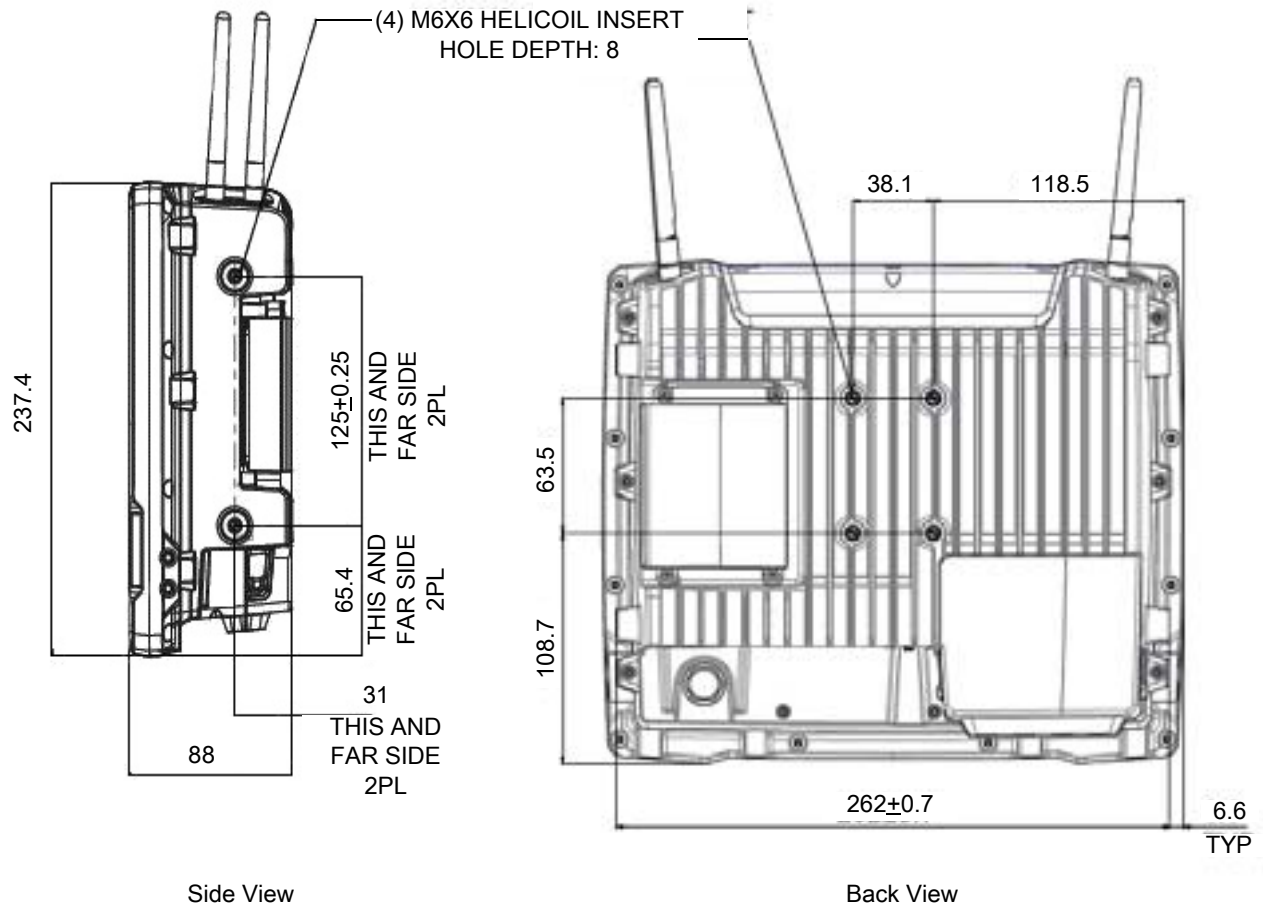
Item	Description
<b>User Environment</b>	
Operating Temperature	-30°C to 50°C (-22°F to 122°F)
Storage Temperature	-40°C to 60°C (-40°F to 140°F)
Relative Humidity	5% to 95% non-condensing (standard version) 5% to 95% condensing (freezer version with internal heating)
Salt Fog	48 hours of 5% solution at 35°C (95°F)
Solar Radiation	MIL STD 810-G, Method 505.5, Procedure I
ESD	+/-20kV air discharge +/-10kV direct discharge
Integrated Sensors	Motion (accelerometer); temperature; ignition
Shock/Vibration	IEC 60721-3-5M3; MIL-STD 810G; Method 514.6; MIL-STD 810G; Method 516.6
Power Consumption	16W: Display brightness at 1/2, keyboard backlight off, radio in received mode, UPS battery fully charged. 42W: Full display brightness, full external keyboard backlight on, radio running ping test, UPS battery is charging, scanner connected. 100W: Full display brightness, full external keyboard backlight on, radio running ping test, UPS battery is charging, scanner connected, touch screen heater on.
<b>Performance Characteristics</b>	
CPU/RAM	Qualcomm 8056 1.8 GHz hexa-core 64 bit with power optimization and 4 GB RAM
Operating System	Android 7.1.2 Nougat, AOSP or GMS on select configurations
Mass Storage	eMMC pSLC mode 32 GB
Additional Software	Zebra Mobility DNA, and Ivanti Velocity
Application Development	Zebra Enterprise Mobility Developer Kit (EMDK) for Android
Touchscreen	<ul style="list-style-type: none"> <li>• Resistive touchscreen with passive stylus or finger operation</li> <li>• Freezer version includes integrated touchscreen heater for evaporates external condensation.</li> <li>• Construction: Film-Glass (FG)</li> <li>• Hardness of surface: 3H (ASTM D3363)</li> <li>• Resistance: 35 million actuations</li> </ul>
Audio	High volume 87 dBA speaker (at 1 foot distance)

**Table 13** Technical Specifications (Continued)

Item	Description
Push-to-Talk	External optional M1000 speaker/microphone
<b>WLAN Wireless Data Communications</b>	
WLAN radio	IEEE 802.11 a/b/g/n/ac/k/r 2x2 MIMO
Output Power	2.4 GHz=+18.5 dBm max, 5 GHz=+18.5 dBm max
Max. Data Rate	867 Mbps @ 5 GHz, 144 Mbps @ 2.4 GHz
Frequency Range	Country dependent 2.4 GHz band (802.11b/g/n) = 2400-2483.5 MHz 5 GHz band (802.11a/n/ac) = 5170-5330 MHz, 5490-5835 MHz.
Antenna	Internal or external (software switchable)
WLAN Security	WPA, WPA2, AES, TKIP, WEP, 802.11x, CCX v4
<b>WPAN Wireless Data Communications</b>	
Bluetooth	Class 2, Bluetooth v4.1 (Bluetooth® Smart technology); Bluetooth Wideband audio and HFPv1.6 support.
<b>Power Supply</b>	
Power Supply	Internal power supply 12-48V nominal

## VC80x Drill Hole Dimensions

Figure 143 VC80x Drill Hole Dimensions





# Index

## A

adaptive frequency hopping	128
airplane mode	24
applications	47

## B

battery	
low power notification	23
management	22
manager	57
usage monitoring	23
battery manager	57
battery usage	23
Bluetooth	115, 128
PIN	128
power states	129
profiles	129
security	128
bluetooth	128
browser	47

## C

cable dust cover	29
cables, installing in vehicle	26
calculator	47
calendar	47
cleaning	
housing	239
clock	47
connect to WLAN	115
contacts	47, 71
CPU	246

## D

data capture	103
DataWedge	47
datawedge	114
datawedge demo	76

dimensions	245
display	67, 245
display settings	198
downloads	48
DWDEmo	48

## E

EAP	115
electrical installation	26
email	48
emergency shutdown	17
external antenna	28

## F

file browser	48, 69
font size	199
Forklift	32
forklift battery replacement	32
forklift installation	26
front keys	20

## G

gallery	48
ground bolt	26

## H

hard reset	54
Heater Status	22
home screen	36

## I

imager scanning	103
installation	
non-vehicle	33
vehicle	33

- K**
- keyboard ..... 45, 132
- L**
- LAN ..... 22
  - LED indicators ..... 20
  - low battery notification ..... 23
- M**
- message URL http  
    //www.zebra.com/support ..... 79, 223
  - mounting
    - assembly steps ..... 29
    - instructions ..... 25
  - MT43XX RAM Mount kit ..... 137
- N**
- notification icons ..... 39
- O**
- operating
    - emergency ..... 17
  - operating system ..... 246
  - optional mount kits ..... 137
- P**
- picklist ..... 104
  - power
    - power down VC80x ..... 22
    - power up VC80x ..... 22
    - supply ..... 17
      - protection ..... 17
      - safety ..... 17
  - PTT Express ..... 79
- R**
- RAM Mount kit ..... 137
  - resetting the device ..... 53
  - RS507/RS507x scanning ..... 106, 107
  - RS6000 scanning ..... 105
  - RxLogger ..... 83
- S**
- scanning ..... 103
  - scanning application ..... 76
  - screen
    - unlocking ..... 51
- screen blanking ..... 68
  - screen font size ..... 199
  - screen rotation ..... 200
  - screen timeout ..... 199, 240
  - security ..... 115
  - set font size ..... 199
  - setting
    - font ..... 199
    - sounds ..... 201
  - setting date ..... 198
  - setting time ..... 198
  - settings ..... 49
    - display ..... 198
  - soft reset ..... 53
  - sound recorder ..... 49, 78
  - sound settings ..... 201
  - speaker
    - built-in ..... 68
  - specifications ..... 14, 245
  - status icons ..... 38
  - strain relief rail ..... 30
  - suspend mode ..... 54
- T**
- technical specifications ..... 245
  - touchscreen ..... 44, 239
    - cleaning ..... 239
    - operation ..... 239
    - specifications ..... 239
  - transferring files using USB ..... 55
  - troubleshooting ..... 242
- U**
- unlocking the screen ..... 51
  - unpacking ..... 16
  - USB ..... 55
- V**
- VC80x
    - features ..... 18
  - vehicle
    - battery, charging ..... 17
  - vehicle-mount installation
    - cables ..... 26
- W**
- weight ..... 245
  - WEP ..... 115
  - wi-fi network ..... 115
  - wireless local area network ..... 115
  - WLAN ..... 22, 115

WPA ..... 115

